



HEARING AID COMPATIBILITY T-COIL PARTIAL TEST REPORT

FCC ID : IHDT56ZD3
Equipment : Mobile Cellular Phone
Brand Name : Motorola
Model Name : XT2093-1, XT2093-7
T-Rating : T3
Applicant : Motorola Mobility LLC
222 W, Merchandise Mart Plaza, Chicago IL 60654 USA
Manufacturer : Motorola Mobility LLC
222 W, Merchandise Mart Plaza, Chicago IL 60654 USA
Standard : FCC 47 CFR §20.19
ANSI C63.19-2011

The product was received on Aug. 07, 2020 and testing was started from Aug. 22, 2020 and completed on Sep. 07, 2020. We, Sporton International (Kunshan) Inc., would like to declare that the tested sample has been evaluated in accordance with the test procedures and has been in compliance with the applicable technical standards.

The test results in this report apply exclusively to the tested model / sample. Without written approval of Sporton International (Kunshan) Inc., the test report shall not be reproduced except in full.



Rose Wang

Reviewed by: Rose Wang / Supervisor

Kat Yin

Approved by: Kat Yin / Manager



Sporton International (Kunshan) Inc.
No. 1098, Pengxi North Road, Kunshan Economic Development Zone Jiangsu Province 215300
People's Republic of China



Table of Contents

1. Attestation of Test Results 5
2. General Information 6
3. Testing Location..... 7
4. Applied Standards 7
5. Air Interface and Operating Mode..... 8
6. Measurement standards for T-Coil 9
 6.1 Frequency Response 9
 6.2 T-Coil Signal Quality Categories..... 9
7. T-Coil Test Procedure10
 7.1 Test Flow Chart.....11
 7.2 Test Setup Diagram12
 7.3 Description of EUT Test Position14
8. Test Equipment List.....15
9. T-Coil testing for CMRS Voice.....16
 9.1 GSM Tests Results16
 9.2 UMTS Tests Results17
10. T-Coil testing for CMRS IP Voice18
 10.1 VoLTE Tests Results.....18
 10.2 VoWiFi Tests Results.....20
11. Uncertainty Assessment22
12. References.....23

Appendix A. Plots of T-Coil Measurement
Appendix B. DASy Calibration Certificate
Appendix C. Test Setup Photos



History of this test report

Report No.	Version	Description	Issued Date
HA080709-01B	Rev. 01	Initial issue of report	Sep. 21, 2020



1. Attestation of Test Results

Air Interface	Band MHz	T-Rating	Frequency Response	Magnetic Intensity
GSM CMRS Voice	GSM850	T3	Pass	Pass
	GSM1900	T3	Pass	Pass
UMTS CMRS Voice	Band 2	T4	Pass	Pass
	Band 4	T4	Pass	Pass
	Band 5	T4	Pass	Pass
VoLTE	Band 2	T4	Pass	Pass
	Band 4	T4	Pass	Pass
	Band 5	T4	Pass	Pass
	Band 12	T4	Pass	Pass
	Band 14	T4	Pass	Pass
	Band 30	T4	Pass	Pass
VoWiFi	Band 66	T4	Pass	Pass
	2450	T4	Pass	Pass
	5200	T4	Pass	Pass
	5300	T4	Pass	Pass
	5500	T4	Pass	Pass
5800	T4	Pass	Pass	Pass
Date Tested	2020/8/22 ~ 2020/9/7			

1. The device is compliance with HAC limits specified in guidelines FCC 47CFR §20.19 and ANSI Standard ANSI C63.19.
2. This is **partial** report for CMRS voice T-Coil testing . VOIP testing is performed by Sporton International Inc with Report No. HA080625-01(FCC ID: IHDT56ZD3)



2. General Information

Product Feature & Specification	
Applicant Name	Motorola Mobility LLC
Equipment Name	Mobile Cellular Phone
Brand Name	Motorola
Model Name	XT2093-1, XT2093-7
IMEI Code	355565110012328
FCC ID	IHDT56ZD3
HW	DVT2
SW	QZA30.32
EUT Stage	Identical Prototype
Frequency Band	GSM850: 824.2 MHz ~ 848.8 MHz GSM1900: 1850.2 MHz ~ 1909.8 MHz WCDMA Band II: 1852.4 MHz ~ 1907.6 MHz WCDMA Band IV: 1712.4 MHz ~ 1752.6 MHz WCDMA Band V: 826.4 MHz ~ 846.6 MHz LTE Band 2: 1850.7 MHz ~ 1909.3 MHz LTE Band 4: 1710.7 MHz ~ 1754.3 MHz LTE Band 5: 824.7 MHz ~ 848.3 MHz LTE Band 12: 699.7 MHz ~ 715.3 MHz LTE Band 14: 790.5 MHz ~ 795.5 MHz LTE Band 30: 2307.5 MHz ~ 2312.5 MHz LTE Band 66: 1710.7 MHz ~ 1779.3 MHz WLAN 2.4GHz Band: 2412 MHz ~ 2462 MHz WLAN 5.2GHz Band: 5180 MHz ~ 5240 MHz WLAN 5.3GHz Band: 5260 MHz ~ 5320 MHz WLAN 5.5GHz Band: 5500 MHz ~ 5720 MHz WLAN 5.8GHz Band: 5745 MHz ~ 5825 MHz Bluetooth: 2402 MHz ~ 2480 MHz
Mode	GSM/GPRS/EGPRS AMR / RMC 12.2Kbps HSDPA HSUPA DC-HSDPA HSPA+ (16QAM uplink is not supported) LTE: QPSK, 16QAM, 64QAM WLAN 2.4GHz : 802.11b/g/n HT20 WLAN 5GHz : 802.11a/n/ac HT20/HT40/VHT20/VHT40/VHT80 Bluetooth BR/EDR/LE



3. Testing Location

Sporton International (Kunshan) Inc. is accredited to ISO/IEC 17025:2017 by American Association for Laboratory Accreditation with Certificate Number 5145.02.

Testing Laboratory		
Test Firm	Sporton International (Kunshan) Inc.	
Test Site Location	No. 1098, Pengxi North Road, Kunshan Economic Development Zone Jiangsu Province 215300 People's Republic of China TEL : +86-512-57900158 FAX : +86-512-57900958	
Test Site No.	FCC Designation No.	FCC Test Firm Registration No.
	CN1257	314309

4. Applied Standards

- FCC CFR47 Part 20.19
- ANSI C63.19 2011-version
- FCC KDB 285076 D01 HAC Guidance v05
- FCC KDB 285076 D02 T Coil testing v03
- FCC KDB 285076 D03 HAC FAQ v01



5. Air Interface and Operating Mode

Air Interface	Band MHz	Type	C63.19 Tested	Simultaneous Transmitter	Name of Voice Service	Power Reduction
GSM	GSM850	VO	Yes	WLAN, BT	CMRS Voice	No
	GSM1900			WLAN, BT		No
	EDGE850	VD	Yes	WLAN, BT	Google Duo ⁽¹⁾	No
	EDGE1900					
UMTS	850	VO	Yes	WLAN, BT	CMRS Voice	No
	1750			WLAN, BT		No
	1900			WLAN, BT		No
	HSPA	VD	Yes	WLAN, BT	Google Duo ⁽¹⁾	No
LTE (FDD)	Band 2	VD	Yes	WLAN, BT	VoLTE / Google Duo ⁽¹⁾	No
	Band 4			WLAN, BT		No
	Band 5			WLAN, BT		No
	Band 12			WLAN, BT		No
	Band 14			WLAN, BT		No
	Band 30			WLAN, BT		No
	Band 66			WLAN, BT		No
Wi-Fi	2450	VD	Yes	GSM,WCDMA,LTE	VoWiFi ⁽¹⁾ / Google Duo ⁽¹⁾	No
	5200					No
	5300					No
	5500					No
	5800					No
BT	2450	DT	No	GSM,WCDMA,LTE	NA	No
Type Transport: VO= Voice only DT= Digital Transport only (no voice) VD= CMRS and IP Voice Service over Digital Transport						
Remark: 1. For protocols not listed in Table 7.1 of ANSI C63.19-2011 or the ANSI C63.19-2011 VoLTE interpretation, the average speech level of -20 dBm0 should be used. 2. This is partial report for CMRS voice T-Coil testing . VOIP testing is performed by Sporton International Inc. with Report No. HA080625-01(FCC ID: IHDT56ZD3).						

6. Measurement standards for T-Coil

6.1 Frequency Response

The frequency response of the perpendicular component of the magnetic field, measured in 1/3 octave bands, shall follow the response curve specified in this sub-clause, over the frequency range 300 Hz to 3000 Hz.

Figure 1.1 and Figure 1.2 provide the boundaries as a function of frequency. These response curves are for true field-strength measurements of the T-Coil signal. Thus, the 6 dB/octave probe response has been corrected from the raw readings.

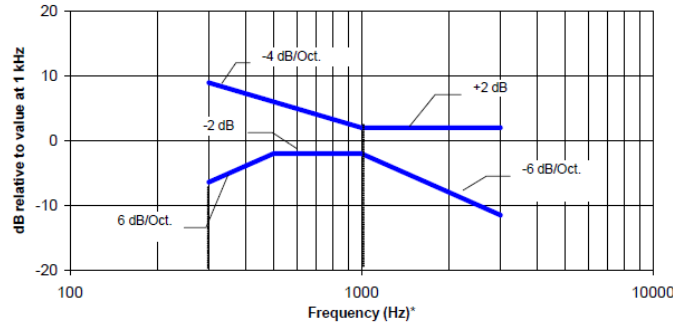

NOTE—The frequency response is between 300 Hz and 3000 Hz.

Fig. 1.1 Magnetic field frequency response for WDs with field strength ≤ -15 dB at 1 kHz

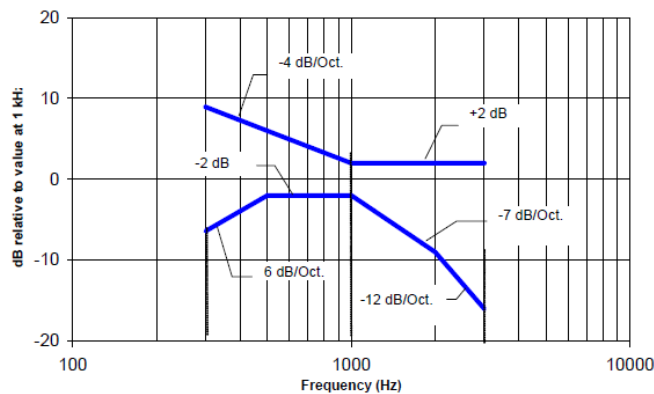

NOTE—The frequency response is between 300 Hz and 3000 Hz.

Fig. 1.2 Magnetic field frequency response for WDs with a field that exceeds -15 dB(A/m) at 1 kHz

6.2 T-Coil Signal Quality Categories

This section provides the signal quality requirement for the intended T-Coil signal from a WD. Only the RF immunity of the hearing aid is measured in T-Coil mode. It is assumed that a hearing aid can have no immunity to an interference signal in the audio band, which is the intended reception band for this mode. A device is assessed beginning by determining the category of the RF environment in the area of the T-Coil source.

The RF measurements made for the T-Coil evaluation are used to assign the category T1 through T4. The limitation is given in Table 1. This establishes the RF environment presented by the WD to a hearing aid.

Category	Telephone parameters WD signal quality ((signal + noise) to noise ratio in dB)
Category T1	0 to 10 dB
Category T2	10 to 20 dB
Category T3	20 to 30 dB
Category T4	> 30 dB

Table 1 T-Coil Signal Quality Categories



7. T-Coil Test Procedure

Referenced to ANSI C63.19-2011, Section 7.4,

This section describes the procedures used to measure the ABM (T-Coil) performance of the WD. In addition to measuring the absolute signal levels, the A-weighted magnitude of the unintended signal shall also be determined. To assure that the required signal quality is measured, the measurement of the intended signal and the measurement of the unintended signal must be made at the same location for each measurement position. In addition, the RF field strength at each measurement location must be at or below that required for the assigned category.

Measurements shall not include undesired properties from the WD's RF field; therefore, use of a coaxial connection to a base station simulator or non-radiating load, there might still be RF leakage from the WD, which can interfere with the desired measurement. Pre-measurement checks should be made to avoid this possibility. All measurements shall be performed with the WD operating on battery power with an appropriate normal speech audio signal input level given in ANSI C63.19-2011 Table 7.1. If the device display can be turned off during a phone call, then that may be done during the measurement as well,

Measurement shall be performed at two locations specified in ANSI C63.19-2011 A.3, with the correct probe orientation for a particular location, in a multistage sequence by first measuring the field intensity of the desired T-Coil signal the same location as the desired ABM or T-Coil signal (ABM1), and the ratio of desired to undesired magnetic components (ABM2) must be measured at the same location as the desired ABM or T-Coil signal (ABM1), and the ratio of desired to undesired ABM signals must be calculated. For the perpendicular field location, only the ABM1 frequency response shall be determined in a third measurement stage.

The following steps summarize the basic test flow for determining ABM1 and ABM2. These steps assume that a sine wave or narrowband 1/3 octave signal can be used for the measurement of ABM1.

- a. A validation of the test setup and instrumentation may be performed using a TMFS or Helmholtz coil Measure the emissions and confirm that they are within the specified tolerance.
- b. Position the WD in the test setup and connect the WD RF connector to a base station simulator or a non-radiating load. Confirm that equipment that requires calibration has been calibrated, and that the noise level meets the requirements given in ANSI C63.19-2011 clause 7.3.1.
- c. The drive level to the WD is set such that the reference input level specified in ANSI C63.19-2011 Table 7.1 is input to the base station simulator (or manufacturer's test mode equivalent) in 1 kHz, 1/3 octave band. This drive level shall be used for the T-Coil signal test (ABM1) at $f = 1$ kHz. Either a sine wave at 1025 Hz or a voice-like signal, band-limited to the 1 kHz 1/3 octave, as defined in ANSI C63.19-2011 clause 7.4.2, shall be used for the reference audio signal. If interference is found at 1025 Hz an alternative nearby reference audio signal frequency may be used. The same drive level shall be used for the ABM1 frequency response measurements at each 1/3 octave band center frequency. The WD volume control may be set at any level up to maximum, provided that a signal at any frequency at maximum modulation would not result in clipping or signal overload.
- d. Determine the magnetic measurement locations for the WD device (A.3), if not already specified by the manufacturer, as described in ANSI C63.19-2011 clause 7.4.4.1.1 and 7.4.4.2.
- e. At each measurement location, measure and record the desired T-Coil magnetic signals (ABM1 at f_i) as described in ANSI C63.19-2011 clause 7.4.4.2 in each individual ISO 266-1975 R10 standard 1/3 octave band. The desired audio band input frequency (f_i) shall be centered in each 1/3 octave band maintaining the same drive level as determined in item c) and the reading taken for that band.
- f. Equivalent methods of determining the frequency response may also be employed, such as fast Fourier transform (FFT) analysis using noise excitation or input-output comparison using simulated speech. The full-band integrated probe output, as specified in D.9, may be used, as long as the appropriate calibration curve is applied to the measured result, so as to yield an accurate measurement of the field magnitude. (The resulting measurement shall be an accurate measurement in dB A/m.)
- g. All Measurements of the desired signal shall be shown to be of the desired signal and not of an undesired signal. This may be shown by turning the desired signal ON and OFF with the probe measuring the same location. If the scanning method is used the scans shall show that all measurement points selected for the ABM1 measurement meet the ambient and test system noise criteria in ANSI C63.19-2011 clause 7.3.1.
- h. At the measurement location for each orientation, measure and record the undesired broadband audio magnetic signal (ABM2) as specified in ANSI C63.19-2011 clause 7.4.4.4 with no audio signal applied (or digital zero applied, if appropriate) using A-weighting and the half-band integrator. Calculate the ratio of the desired to undesired signal strength (i.e., signal quality).
- i. Obtain the data from the postprocessor, SEMCAD, and determine the category that properly classifies the signal quality based on ANSI C63.19-2011 Table 8.5.

7.1 Test Flow Chart

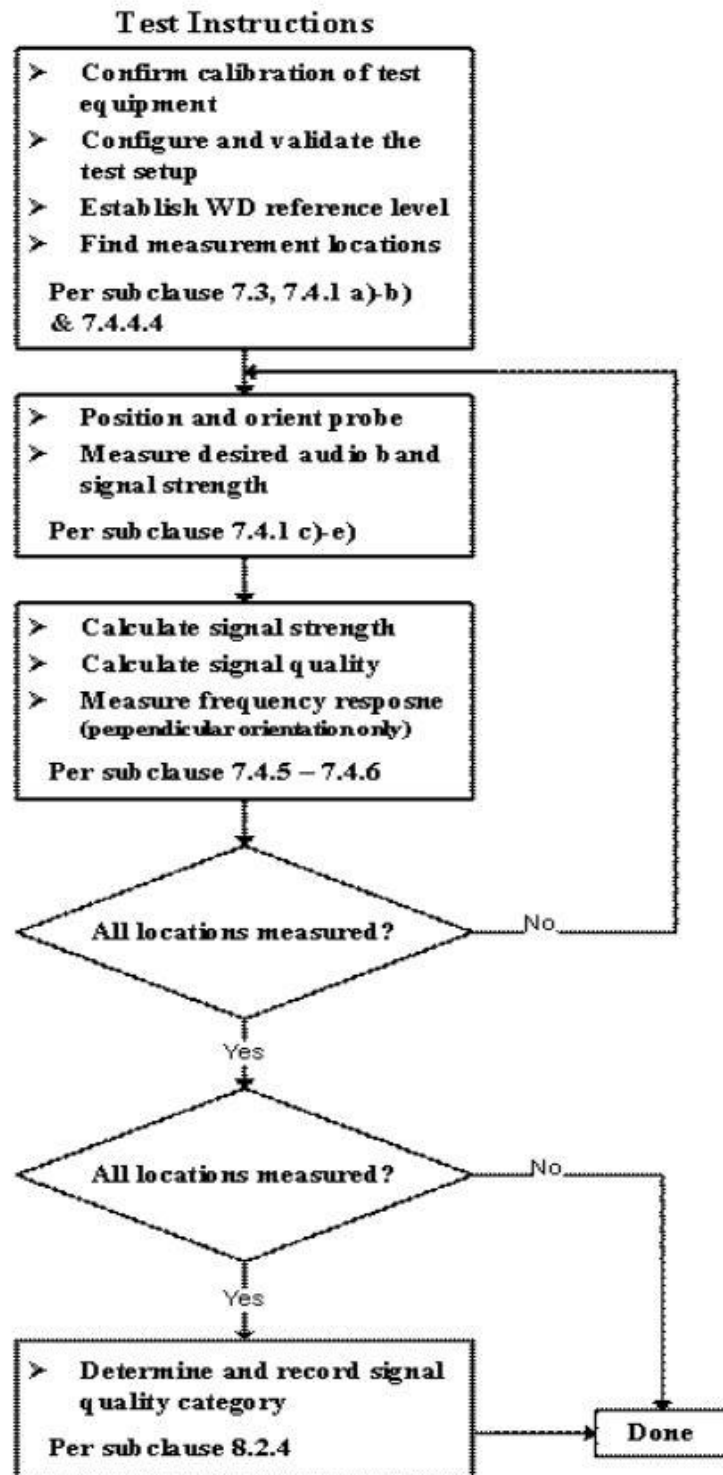
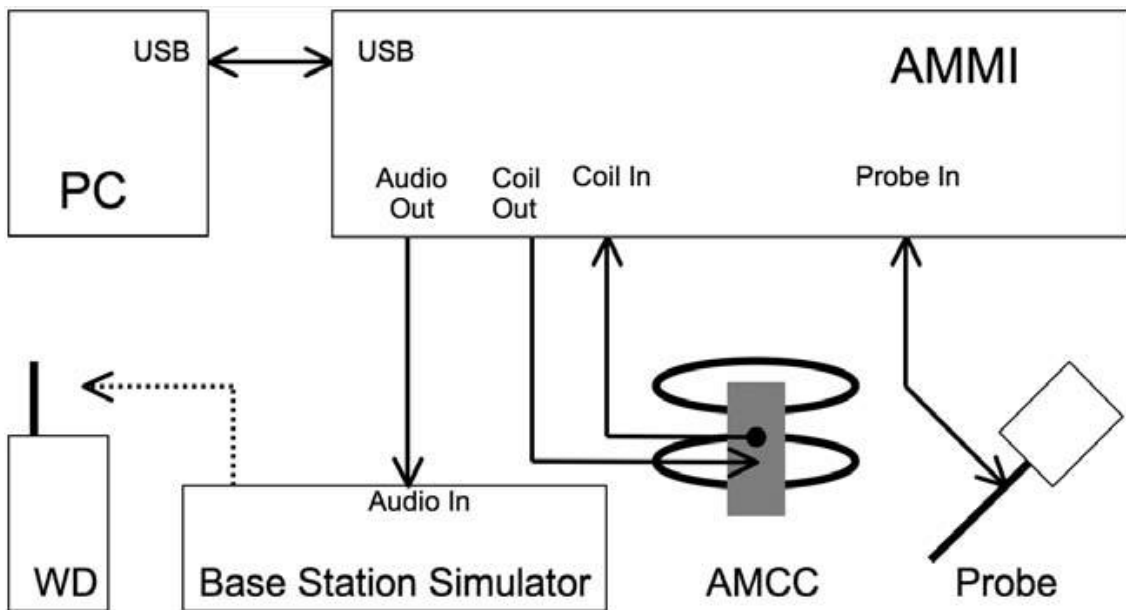

Fig. 2 T-Coil Signal Test flowchart

7.2 Test Setup Diagram



General Note:

1. Define the all applicable input audio level as below according to C63 and KDB 285076 D02v03:
 - GSM input level: -16dBm0
 - UMTS input level: -16dBm0
 - VoLTE input level: -16dBm0
 - VoWiFi input level: -20dBm0
2. For GSM / UMTS test setup and input level, the correct input level definition is via a communication tester CMU200's "Decoder Cal" and "Codec Cal" with audio option B52 and B85 to set the correct audio input levels.
3. CMU200 is able to output 1kHz audio signal equivalent to 3.14dBm0 at "Decoder Cal." configuration, the signal reference is used to adjust the AMMI gain setting to reach -16dBm0 for GSM/UMTS. CMW500 input is calibrated and the relation between the analog input voltage and the internal level in dBm0 can be determined
4. The test setup used for VoLTE over IMS and VoWiFi over IMS is via the callbox of CMW500 for T-coil measurement, The data application unit of the CMW500 was used to simulate the IP multimedia subsystem server. The CMW500 can be manually configured to ensure and control the speech input level result is -16dBm0 for VoLTE, -20dBm0 for VoWiFi when the device during the IMS connection.



1. The Required gain factor for the specific signal shall typically be multiplied by this factor to achieve approx. the same level as for the 1kHz sine signal
2. The below calculation formula is an example and showing how to determine the input level for the device.

The predefined signal types have the following differences / factors compared to the 1kHz sine signal:

Signal [file name]	Duration [s]	Peak-to-RMS [dB]	RMS [dB]	Required gain factor *)	Gain setting
1kHz sine	---	3.0	0.0	1.00	
48k_1.025kHz_10s.wav	10	3.0	0.0	1.00	
48k_1kHz_3.15kHz_10s.wav	10	6.0	-3.0	1.42	
48k_315Hz_1kHz_10s.wav	10	6.0	-2.9	1.40	
48k_csek_8k_441_white_10s.wav	10	13.8	-10.5	3.34	
48k_multisine_50-5000_10s.wav	10	11.1	-7.9	2.49	
48k_voice_1kHz_1s.wav	1	16.2	-12.7	4.33	
48k_voice_300-3000_2s.wav	2	21.6	-18.6	8.48	

(*) The gain for the specific signal shall typically be multiplied by this factor to achieve approx. the same level as for the 1kHz sine signal.

Insert the gain applicable for your setup in the last column of the table.

Calculation formula:

- Audio Level at -16dBm0 = ((-16dBm0) – (3.14dBm0)) + X dBv
- Calculated Gain at -16dBm0 = 10((audio level at -16dBm0 – Y dBm0) / 20) * 10
- Gating setting at -16dBm0 = required gain factor * calculated gain

Gain Value	dBm0	Full scal Voltage	dB	AMMI audio out dBv (RMS)	AMCC Coil Out (dBv (RMS)
-	3.14	1.5	-	0.51	-
100	5.73	-	40	3.1	3.25
8.20	-16	-	18.27	-	-18.48
Signal Type	Duration (s)	Peak to RMS (dB)	RMS (dB)	Gain Factor	Gain Setting
1kHz sine	-	3	0	1	8.20
48k_voice_1kHz	1	16.2	-12.7	4.33	35.49
48k_voice_300-3000	2	21.6	-18.6	8.48	69.50

7.3 Description of EUT Test Position

Fig.3 illustrate the references and reference plane that shall be used in a typical EUT emissions measurement. The principle of this section is applied to EUT with similar geometry. Please refer to Appendix C for the setup photographs.

- ◆ The area is 5 cm by 5 cm.
- ◆ The area is centered on the audio frequency output transducer of the EUT.
- ◆ The area is in a reference plane, which is defined as the planar area that contains the highest point in the area of the phone that normally rests against the user’s ear. It is parallel to the centerline of the receiver area of the phone and is defined by the points of the receiver-end of the EUT handset, which, in normal handset use, rest against the ear.
- ◆ The measurement plane is parallel to, and 10 mm in front of, the reference plane.

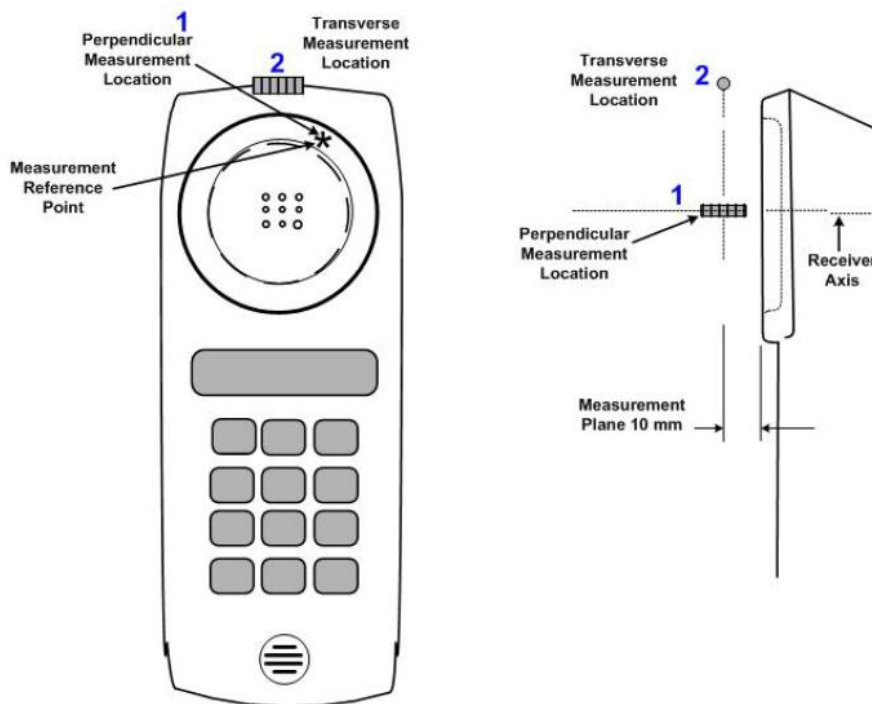

Fig.3 A typical EUT reference and plane for T-Coil measurements



8. Test Equipment List

Manufacturer	Name of Equipment	Type/Model	Serial Number	Calibration	
				Last Cal.	Due Date
SPEAG	Audio Magnetic 1D Field Probe	AM1DV3	3128	2020/6/18	2021/6/17
SPEAG	Data Acquisition Electronics	DAE4	690	2020/3/26	2021/3/25
SPEAG	Audio Magnetic Calibration Coil	AMCC	1049	NCR	NCR
SPEAG	Audio Measuring Instrument	AMMI	1041	NCR	NCR
Testo	Hygrometer	608-H1	1241332088	2020/1/8	2021/1/7
R&S	Base Station	CMW500	117336	2020/7/31	2021/7/30
R&S	Base Station	CMU200	143030	2019/10/18	2020/10/17
SPEAG	Test Arch Phantom	N/A	N/A	NCR	NCR
SPEAG	Phone Positioner	N/A	N/A	NCR	NCR

Note:

- 1. NCR: "No-Calibration Required"



9. T-Coil testing for CMRS Voice

General Note:

1. **Codec Investigation:** For a voice service/air interface, investigate the variations of codec configurations (WB, NB bit rate) and document the parameters (ABM1, ABM2, S+N/N, frequency response) for that voice service. It is only necessary to document this for one channel/band, the following worst investigation codec would be remarked to be used for the testing for the handset.
2. **Air Interface Investigation:**
 - a. Use the worst-case codec test and document a limited set of bands/channel/bandwidths. Observe the effect of changing the band and bandwidth to ensure that there are no unexpected variations. Using the knowledge of the observed variations, it is necessary to report only a set band/channel/bandwidth for each orientation for a voice service/air interface.
 - b. According to the ANSI C63.19 2011 section 7.3.2, test middle channel of each frequency band for HAC testing for each orientation to determine worst HAC T-Coil rating.

9.1 GSM Tests Results

<Codec Investigation>

GSM Codec				
Codec	FR_V1	HR_V1	Orientation	Band / Channel
ABM 1 (dBA/m)	2.42	2.36	Axial	GSM850 / 189
ABM 2 (dBA/m)	-22.71	-25.37		
Signal Quality (dB)	25.13	27.73		
Freq. Response	PASS	PASS		

Remark: According to codec investigation, the worst codec is FR_V1

<Air Interface Investigation>

Plot No.	Air Interface	Mode	Channel	Probe Position	ABM1 dB (A/m)	ABM2 dB (A/m)	Signal Quality dB	T Rating	Ambient Noise dB (A/m)	Freq. Response Variation dB	Frequency Response
1	GSM850	Voice_FR_V1	189	Axial (Z)	2.42	-22.71	25.13	T3	-55.86	0.50	PASS
				Transversal (Y)	-8.42	-49.93	41.51	T4	-55.41		
2	GSM1900	Voice_FR_V1	661	Axial (Z)	2.12	-26.63	28.75	T3	-55.69	0.76	PASS
				Transversal (Y)	-11.16	-53.78	42.62	T4	-55.48		

9.2 UMTS Tests Results
<Codec Investigation>

Codec	AMR 4.75Kbps	AMR 7.95Kbps	AMR 12.2Kbps	Orientation	Band / Channel
ABM 1 (dBA/m)	1.01	1.16	1.09	Axial	Band 5 / 4182
ABM 2 (dBA/m)	-45.06	-46	-44.87		
Signal Quality (dB)	46.07	47.16	45.96		
Freq. Response	PASS	PASS	PASS		

Remark: According to codec investigation, the worst codec is AMR 12.2Kbps

<Air Interface Investigation>

Plot No.	Air Interface	Mode	Channel	Probe Position	ABM1 dB (A/m)	ABM2 dB (A/m)	Signal Quality dB	T Rating	Ambient Noise dB (A/m)	Freq. Response Variation dB	Frequency Response
3	WCDMA II	Voice_ AMR 12.2Kbps	9400	Axial (Z)	1.29	-45.74	47.03	T4	-55.72	0.61	PASS
				Transversal (Y)	-8.17	-52.86	44.69	T4	-55.61		
4	WCDMA IV	Voice_ AMR 12.2Kbps	1413	Axial (Z)	1.39	-47.19	48.58	T4	-55.68	0.62	PASS
				Transversal (Y)	-7.71	-52.88	45.17	T4	-55.72		
5	WCDMA V	Voice_ AMR 12.2Kbps	4182	Axial (Z)	0.98	-44.94	45.92	T4	-55.68	0.50	PASS
				Transversal (Y)	-8.06	-52.75	44.69	T4	-55.71		



10. T-Coil testing for CMRS IP Voice

10.1 VoLTE Tests Results

General Note:

- 1. Codec Investigation: For a voice service/air interface, investigate the variations of codec configurations (WB, NB bit rate) and document the parameters (ABM1, ABM2, S+N/N, frequency response) for that voice service. It is only necessary to document this for one channel / band, the following worst investigation codec would be remarked to be used for the testing for the handset.
2. Air Interface Investigation:
a. Use the worst-case codec test and document a limited set of bands / channel / bandwidths. Observe the effect of changing the band and bandwidth to ensure that there are no unexpected variations. Using the knowledge of the observed variations, it is necessary to report only a set band/channel/bandwidth for each orientation for a voice service/air interface and the following worst configure would be remarked to be used for the testing for the handset.
b. Select LTE FDD one frequency band to do measurement at the worst SNR position was additionally performed with varying the BWs/Modulations/RB size to verify the variation to find out worst configuration , the observed variation is very little to be within 1.5 dB which is much less than the margin from the rating threshold.
c. According to the ANSI C63.19 2011 section 7.3.2, test middle channel of each frequency band for HAC testing for each orientation to determine worst HAC T-Coil rating.

<Codec Investigation>

LTE FDD

Table with 13 columns: Codec, NB AMR 4.75Kbps, WB AMR 6.60Kbps, NB AMR 12.2Kbps, WB AMR 23.85Kbps, EVS SWB 9.6Kbps, EVS SWB 128Kbps, EVS WB 5.9Kbps, EVS WB 128Kbps, EVS NB 5.9Kbps, EVS NB 24.4Kbps, Orientation, Band / BW / Channel. Rows include ABM 1 (dBA/m), ABM 2 (dBA/m), Signal Quality (dB), and Freq. Response.

Remark: According to codec investigation, the worst codec is WB AMR 23.85Kbps.



<Air Interface Investigation>

Air Interface		BW (MHz)	Modulation	RB Size	RB offset	Channel	ABM1 dB (A/m)	ABM2 dB (A/m)	Signal Quality dB
FDD	LTE B2	20	QPSK	1	0	18900	-6.86	-47.09	40.23
	LTE B2	20	QPSK	50	0	18900	-6.86	-47.82	40.96
	LTE B2	20	QPSK	100	0	18900	-6.89	-47.81	40.92
	LTE B2	20	16QAM	1	0	18900	-6.90	-46.17	39.27
	LTE B2	20	64QAM	1	0	18900	-6.83	-46.25	39.42
	LTE B2	15	16QAM	1	0	18900	-6.99	-44.11	37.12
	LTE B2	10	16QAM	1	0	18900	-7.09	-44.51	37.42
	LTE B2	5	16QAM	1	0	18900	-6.95	-43.89	36.94
	LTE B2	3	16QAM	1	0	18900	-7.00	-43.86	36.86
LTE B2	1.4	16QAM	1	0	18900	-6.90	-41.97	35.07	

Plot No.	Air Interface	BW (MHz)	Modulation / Mode	RB Size	RB offset	Channel	Probe Position	ABM1 dB (A/m)	ABM2 dB (A/m)	Signal Quality dB	T Rating	Ambient Noise dB (A/m)	Freq. Response Variation dB	Frequency Response
6	LTE Band2	1.4M	16QAM WB AMR 23.85Kbps	1RB	0	18900	Axial (Z)	-1.08	-44.32	43.24	T4	-55.69	1.72	PASS
							Transversal (Y)	-13.42	-50.32	36.90	T4	-55.82		
7	LTE Band4	1.4M	16QAM WB AMR 23.85Kbps	1RB	0	20175	Axial (Z)	-1.19	-43.42	42.23	T4	-55.78	0.25	PASS
							Transversal (Y)	-13.62	-50.30	36.68	T4	-55.91		
8	LTE Band5	1.4M	16QAM WB AMR 23.85Kbps	1RB	0	20525	Axial (Z)	-1.98	-43.81	41.83	T4	-55.38	0.27	PASS
							Transversal (Y)	-13.84	-50.17	36.33	T4	-55.76		
9	LTE Band12	1.4M	16QAM WB AMR 23.85Kbps	1RB	0	23095	Axial (Z)	-1.43	-43.83	42.40	T4	-55.42	0.09	PASS
							Transversal (Y)	-13.01	-50.20	37.19	T4	-55.61		
10	LTE Band14	5M	16QAM WB AMR 23.85Kbps	1RB	0	23330	Axial (Z)	-1.13	-43.23	42.10	T4	-55.68	1.72	PASS
							Transversal (Y)	-15.76	-52.46	36.70	T4	-55.74		
11	LTE Band30	5M	16QAM WB AMR 23.85Kbps	1RB	0	27710	Axial (Z)	-1.35	-43.60	42.25	T4	-55.68	0.77	PASS
							Transversal (Y)	-12.07	-48.56	36.49	T4	-55.71		
12	LTE Band66	1.4M	16QAM WB AMR 23.85Kbps	1RB	0	132322	Axial (Z)	-1.14	-42.64	41.50	T4	-55.92	0.15	PASS
							Transversal (Y)	-13.22	-49.78	36.56	T4	-55.68		



10.2 VoWiFi Tests Results

General Note:

- 1. Codec Investigation: For a voice service/air interface, investigate the variations of codec configurations (WB, NB bit rate) and document the parameters (ABM1, ABM2, S+N/N, frequency response) for that voice service. It is only necessary to document this for one channel/band, the following worst investigation codec would be remarked to be used for the testing for the handset.
2. Air Interface Investigation:
a. Use the worst-case codec test and document a limited set of bands/channel/bandwidths. Observe the effect of changing the band and bandwidth to ensure that there are no unexpected variations. Using the knowledge of the observed variations, it is necessary to report only a set band/channel/bandwidth for each orientation for a voice service/air interface and the following worst configure would be remarked to be used for the testing for the handset.
b. Select WLAN 2.4GHz and WLAN 5GHz one frequency band to do measurement at the worst SNR position was additionally performed with varying the BWs/Modulations/data rate to verify the variation to find out worst configuration , the observed variation is very little to be within 1 dB which is much less than the margin from the rating threshold.
c. According to the ANSI C63.19 2011 section 7.3.2, test middle channel of each frequency band for HAC testing for each orientation to determine worst HAC T-Coil rating.

<Codec Investigation>

Table with 12 columns: Codec, NB AMR 4.75Kbps, WB AMR 6.60Kbps, NB AMR 12.2Kbps, WB AMR 23.85Kbps, EVS SWB 9.6Kbps, EVS SWB 128Kbps, EVS WB 5.9Kbps, EVS WB 128Kbps, EVS NB 5.9Kbps, EVS NB 24.4Kbps, Orientation, Band / Channel. The table contains data for ABM 1, ABM 2, Signal Quality, and Freq. Response across various codec configurations.

Remark: According to codec investigation, the worst codec is EVS WB 128Kbps



<Air Interface Investigation>

Frequency Bands	Modulation	Bandwidth	Data Rate	Channel	ABM1 dB (A/m)	ABM2 dB (A/m)	Signal Quality dB
WLAN 2.4GHz	802.11b	20	1M	6	-5.43	-34.51	29.08
	802.11b	20	11M	6	-5.28	-35.18	29.90
	802.11g	20	6M	6	-11.59	-37.13	25.54
	802.11g	20	54M	6	-9.27	-36.79	27.52
	802.11n-HT20	20	MCS0	6	-9.54	-36.62	27.08
	802.11n-HT20	20	MCS7	6	-9.41	-38.06	28.65
WLAN 5GHz	802.11a	20	6M	36	-10.54	-43.09	32.55
	802.11a	20	54M	36	-9.48	-43.10	33.62
	802.11an-HT20	20	MCS0	36	-9.75	-40.45	30.70
	802.11an-HT20	20	MCS7	36	-9.07	-41.74	32.67
	802.11an-HT40	40	MCS0	38	-10.67	-41.91	31.24
	802.11an-HT40	40	MCS7	38	-9.48	-41.33	31.85
	802.11ac-VHT20	20	MCS0	36	-9.33	-43.10	33.77
	802.11ac-VHT20	20	MCS8	36	-10.02	-43.26	33.24
	802.11ac-VHT40	40	MCS0	38	-9.54	-43.02	33.48
	802.11ac-VHT40	40	MCS8	38	-10.59	-42.36	31.77
	802.11ac-VHT80	80	MCS0	42	-10.29	-41.79	31.50
	802.11ac-VHT80	80	MCS8	42	-10.21	-42.97	32.76

Plot No.	Air Interface	BW (MHz)	Modulation / Mode	Channel	Probe Position	ABM1 dB (A/m)	ABM2 dB (A/m)	Signal Quality dB	T Rating	Ambient Noise dB (A/m)	Freq. Response Variation dB	Frequency Response
13	WLAN2.4GHz	802.11g 6M	EVS WB 128Kbps	6	Axial (Z)	-4.78	-42.77	37.99	T4	-55.15	1.11	PASS
					Transversal (Y)	-16.58	-52.53	35.95	T4	-55.68		
14	WLAN5GHz	802.11an-HT20 MCS0	EVS WB 128Kbps	44	Axial (Z)	-0.77	-42.48	41.71	T4	-55.91	2	PASS
					Transversal (Y)	-9.72	-48.00	38.28	T4	-55.85		
15	WLAN5GHz	802.11an-HT20 MCS0	EVS WB 128Kbps	60	Axial (Z)	-0.75	-41.99	41.24	T4	-55.81	2	PASS
					Transversal (Y)	-10.66	-49.72	39.06	T4	-55.64		
16	WLAN5GHz	802.11an-HT20 MCS0	EVS WB 128Kbps	116	Axial (Z)	0.05	-41.19	41.24	T4	-55.36	2	PASS
					Transversal (Y)	-10.20	-49.77	39.57	T4	-55.48		
17	WLAN5GHz	802.11an-HT20 MCS0	EVS WB 128Kbps	157	Axial (Z)	0.08	-41.78	41.86	T4	-55.61	2	PASS
					Transversal (Y)	-13.76	-51.40	37.64	T4	-55.75		

Remark:

1. Phone Condition: Mute on; Backlight off; Max Volume
2. The detail frequency response results please refer to appendix A.
3. Test Engineer : Nick Hu



11. Uncertainty Assessment

The evaluation of uncertainty by the statistical analysis of a series of observations is termed a Type A evaluation of uncertainty. The evaluation of uncertainty by means other than the statistical analysis of a series of observation is termed a Type B evaluation of uncertainty. Each component of uncertainty, however evaluated, is represented by an estimated standard deviation, termed standard uncertainty, which is determined by the positive square root of the estimated variance. The combined standard uncertainty of the measurement result represents the estimated standard deviation of the result. It is obtained by combining the individual standard uncertainties of both Type A and Type B evaluation using the usual “root-sum-squares” (RSS) methods of combining standard deviations by taking the positive square root of the estimated variances. Expanded uncertainty is a measure of uncertainty that defines an interval about the measurement result within which the measured value is confidently believed to lie. It is obtained by multiplying the combined standard uncertainty by a coverage factor. For purpose of this document, a coverage factor two is used, which corresponds to confidence interval of about 95 %. The DASY uncertainty Budget is showed in Table 8.2. The judgment of conformity in the report is based on the measurement results excluding the measurement uncertainty.

Error Description	Uncertainty Value (±%)	Probability	Divisor	(Ci) ABM1	(Ci) ABM2	Standard Uncertainty (ABM1) (±%)	Standard Uncertainty (ABM2) (±%)
Probe Sensitivity							
Reference Level	3.0	N	1	1	1	3.0	3.0
AMCC Geometry	0.4	R	1.732	1	1	0.2	0.2
AMCC Current	1.0	R	1.732	1	1	0.6	0.6
Probe Positioning during Calibr.	0.1	R	1.732	1	1	0.1	0.1
Noise Contribution	0.7	R	1.732	0.014	1	0.0	0.4
Frequency Slope	5.9	R	1.732	0.1	1	0.3	3.4
Probe System							
Repeatability / Drift	1.0	R	1.732	1	1	0.6	0.6
Linearity / Dynamic Range	0.6	R	1.732	1	1	0.3	0.3
Acoustic Noise	1.0	R	1.732	0.1	1	0.1	0.6
Probe Angle	2.3	R	1.732	1	1	1.3	1.3
Spectral Processing	0.9	R	1.732	1	1	0.5	0.5
Integration Time	0.6	N	1	1	5	0.6	3.0
Field Distribution	0.2	R	1.732	1	1	0.1	0.1
Test Signal							
Ref. Signal Spectral Response	0.6	R	1.732	0	1	0.0	0.3
Positioning							
Probe Positioning	1.9	R	1.732	1	1	1.1	1.1
Phantom Thickness	0.9	R	1.732	1	1	0.5	0.5
DUT Positioning	1.9	R	1.732	1	1	1.1	1.1
External Contributions							
RF Interference	0.0	R	1.732	1	0.3	0.0	0.0
Test Signal Variation	2.0	R	1.732	1	1	1.2	1.2
Combined Std. Uncertainty						4.0%	6.1%
Coverage Factor for 95 %						K=2	K=2
Expanded STD Uncertainty						8.1%	12.2%

Table 8.2 Uncertainty Budget of audio band magnetic measurement



12. References

- [1] ANSI C63.19-2011, "American National Standard for Methods of Measurement of Compatibility between Wireless Communications Devices and Hearing Aids", 27 May 2011.
- [2] FCC KDB 285076 D01v05, "Equipment Authorization Guidance for Hearing Aid Compatibility", Sep 2017
- [3] FCC KDB 285076 D02v03, "Guidance for performing T-Coil tests for air interfaces supporting voice over IP (e.g., LTE and WiFi) to support CMRS based telephone services", Sep 2017
- [4] FCC KDB 285076 D03v01, "Hearing aid compatibility frequently asked questions", Sep 2017
- [5] SPEAG DASY System Handbook



Appendix A. Plots of T-Coil Measurement

The plots are shown as follows.

1_HAC T-Coil GSM850_Voice_Ch189 FR-V1 (Z)

Communication System: UID 0, GSM850-1UP (0); Frequency: 836.4 MHz; Duty Cycle: 1:8.3

Medium: Air Medium parameters used: $\sigma = 0$ S/m, $\epsilon_r = 1$; $\rho = 0$ kg/m³

Ambient Temperature : 23.2 °C

DASY5 Configuration:

- Probe: AM1DV3 - 3128; ; Calibrated: 2020.6.18
- Sensor-Surface: 0mm (Fix Surface)
- Electronics: DAE4 Sn690; Calibrated: 2020.3.26
- Phantom: HAC Test Arch with AMCC; Type: SD HAC P01 BA;
- Measurement SW: DASY52, Version 52.10 (4); SEMCAD X Version 14.6.14 (7483)

Ch189/z (axial) 4.2mm 50 x 50/ABM Interpolated SNR(x,y,z) (121x121x1):

Interpolated grid: dx=1.000 mm, dy=1.000 mm

ABM1/ABM2 = 25.13 dB

ABM1 comp = 2.42 dBA/m

BWC Factor = 0.16 dB

Location: 3.8, -8.8, 3.7 mm

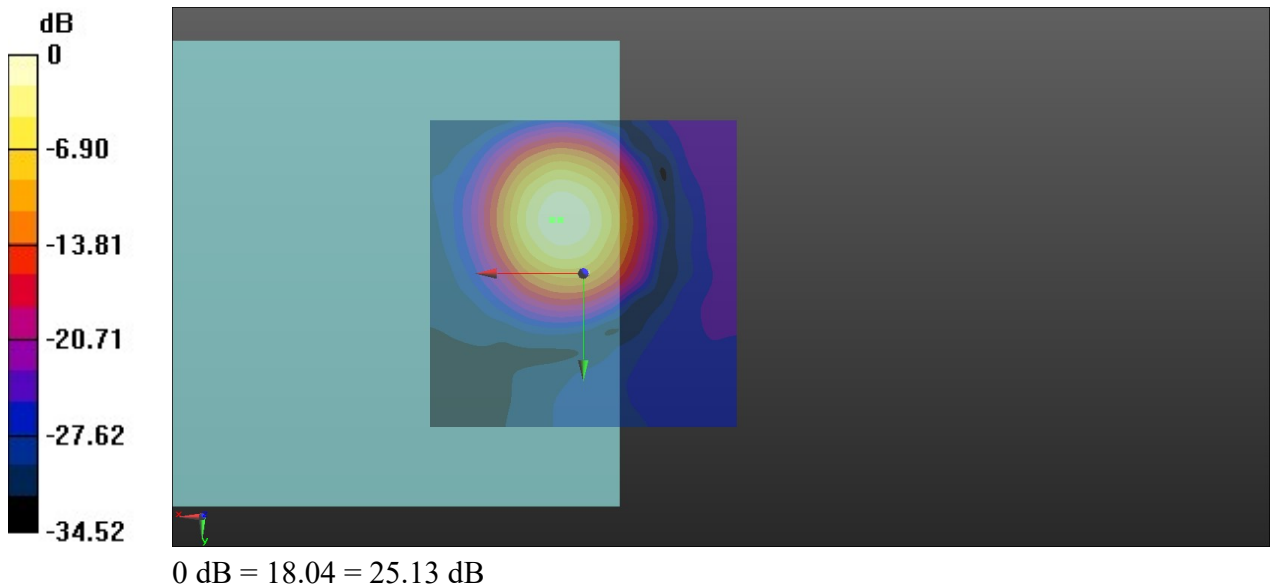

Ch189/z (axial) wideband at best S/N/ABM Freq Resp(x,y,z,f)

Loc: 5.1, -8.8, 3.7 mm Diff: 0.5dB

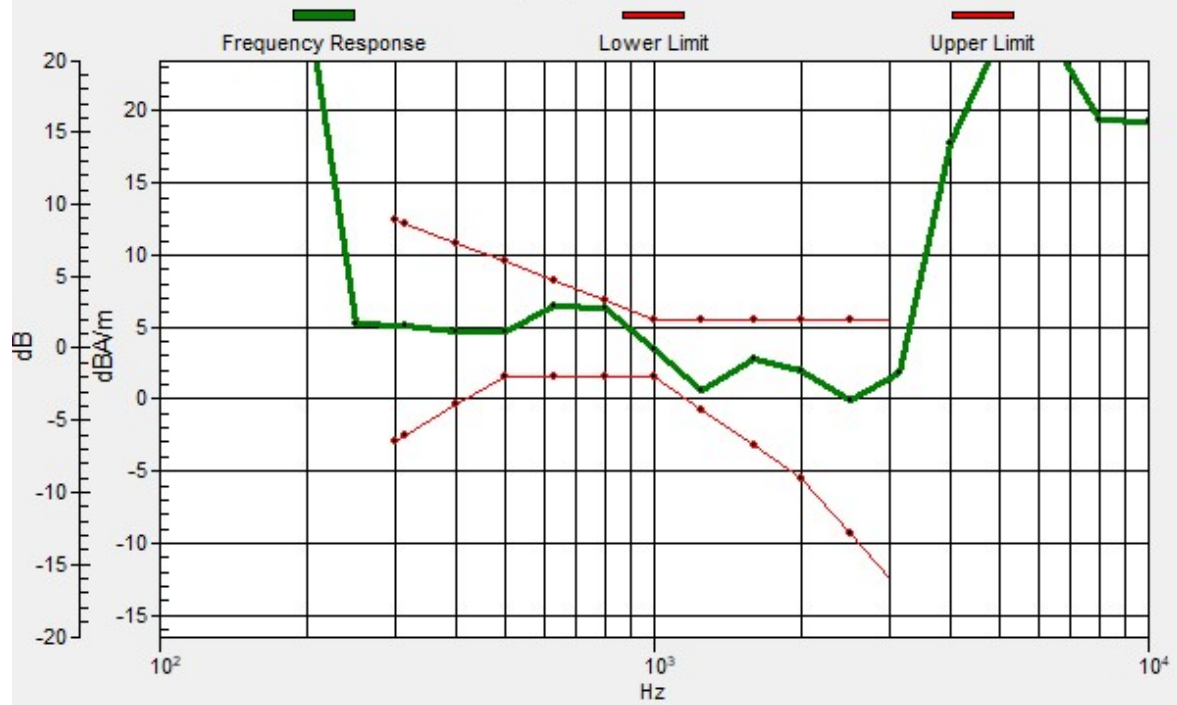

1_HAC T-Coil GSM850_Voice_Ch189 FR-V1 (Y)

Communication System: UID 0, GSM850-1UP (0); Frequency: 836.4 MHz; Duty Cycle: 1:8.3

Medium: Air Medium parameters used: $\sigma = 0$ S/m, $\epsilon_r = 1$; $\rho = 0$ kg/m³

Ambient Temperature : 23.2 °C

DASY5 Configuration:

- Probe: AM1DV3 - 3128; ; Calibrated: 2020.6.18
- Sensor-Surface: 0mm (Fix Surface)
- Electronics: DAE4 Sn690; Calibrated: 2020.3.26
- Phantom: HAC Test Arch with AMCC; Type: SD HAC P01 BA;
- Measurement SW: DASY52, Version 52.10 (4); SEMCAD X Version 14.6.14 (7483)

Ch189/y (transversal) 4.2mm 50 x 50/ABM Interpolated SNR(x,y,z) (121x121x1):

Interpolated grid: dx=1.000 mm, dy=1.000 mm

ABM1/ABM2 = 41.51 dB

ABM1 comp = -8.42 dBA/m

BWC Factor = 0.16 dB

Location: -0.8, -18.8, 3.7 mm

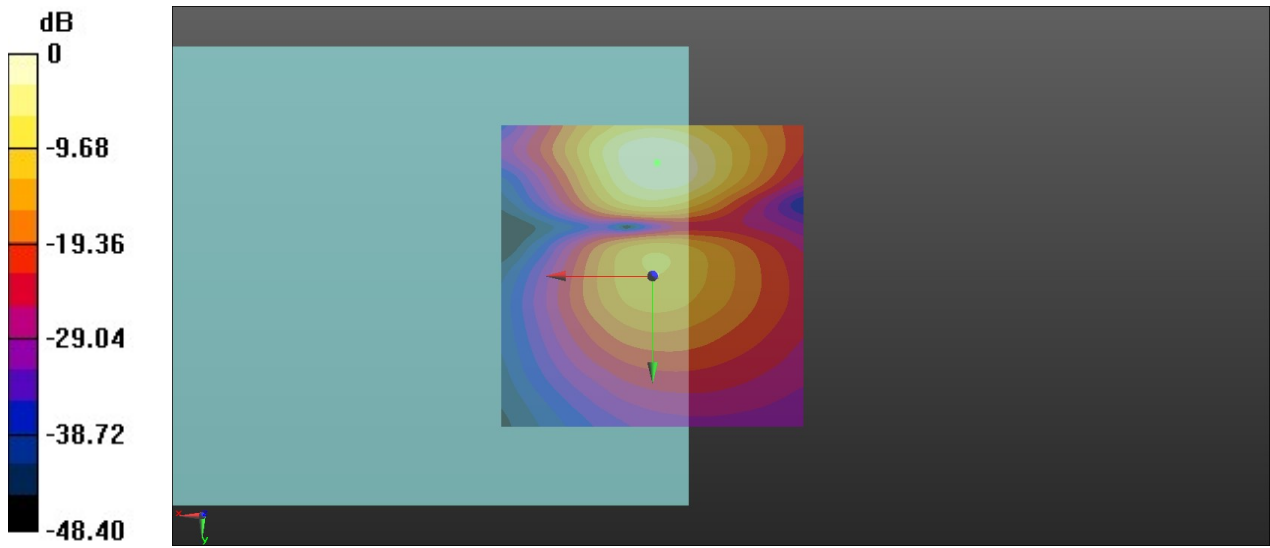

0 dB = 119.0 = 41.51 dB

2_HAC T-Coil GSM850_Voice_Ch661 FR-V1 (Z)

Communication System: UID 0, PCS-1UP (0); Frequency: 1880 MHz; Duty Cycle: 1:8.3

Medium: Air Medium parameters used: $\sigma = 0$ S/m, $\epsilon_r = 1$; $\rho = 0$ kg/m³

Ambient Temperature : 23.2 °C

DASY5 Configuration:

- Probe: AM1DV3 - 3128; ; Calibrated: 2020.6.18
- Sensor-Surface: 0mm (Fix Surface)
- Electronics: DAE4 Sn690; Calibrated: 2020.3.26
- Phantom: HAC Test Arch with AMCC; Type: SD HAC P01 BA;
- Measurement SW: DASY52, Version 52.10 (4); SEMCAD X Version 14.6.14 (7483)

Ch661/z (axial) 4.2mm 50 x 50/ABM Interpolated SNR(x,y,z) (121x121x1):

Interpolated grid: dx=1.000 mm, dy=1.000 mm

ABM1/ABM2 = 28.75 dB

ABM1 comp = 2.12 dBA/m

BWC Factor = 0.16 dB

Location: 3.8, -8.8, 3.7 mm

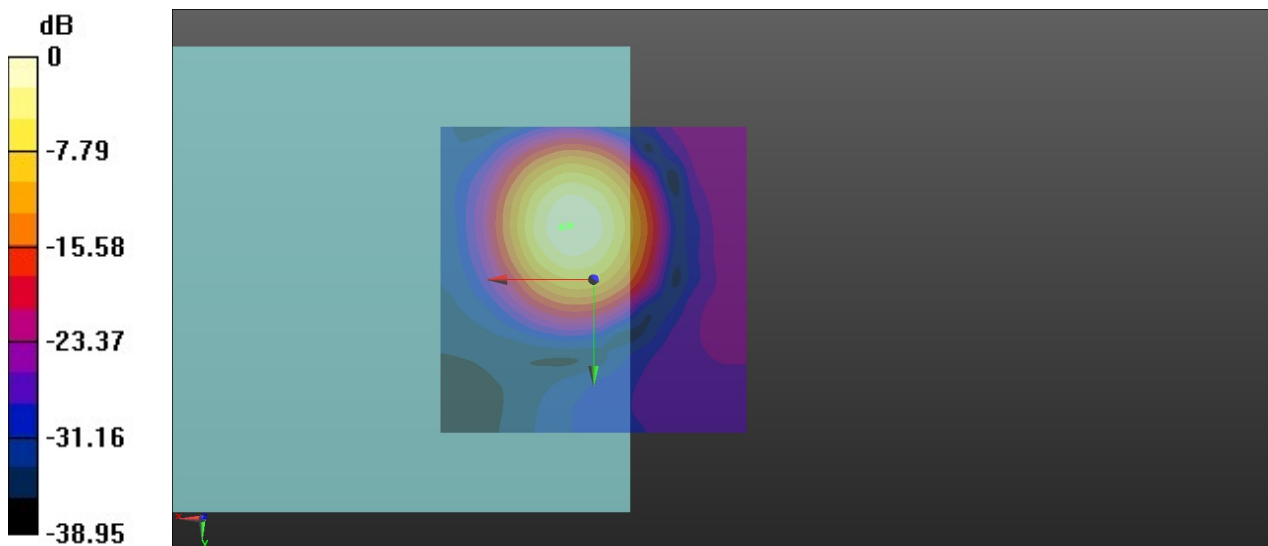

0 dB = 27.38 = 28.75 dB

Ch661/z (axial) wideband at best S/N/ABM Freq Resp(x,y,z,f)

Loc: 5.2, -8.6, 3.7 mm Diff: 0.76dB

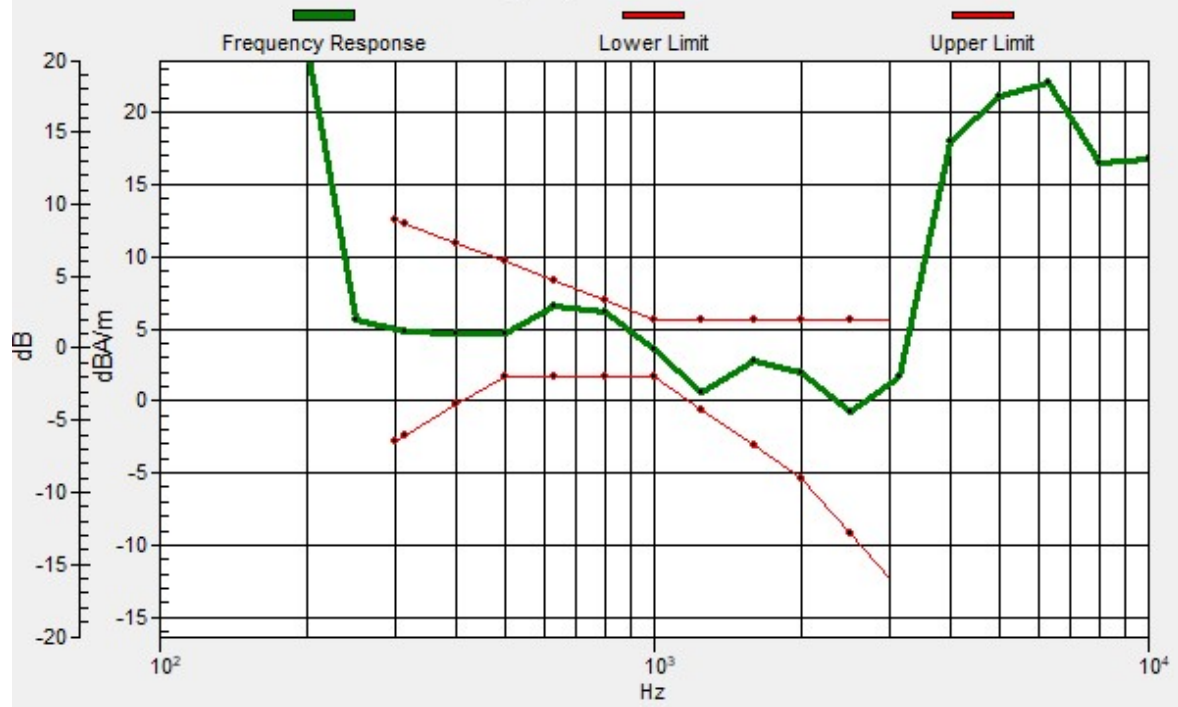

2_HAC T-Coil GSM850_Voice_Ch661 FR-V1 (Y)

Communication System: UID 0, PCS-1UP (0); Frequency: 1880 MHz; Duty Cycle: 1:8.3

Medium: Air Medium parameters used: $\sigma = 0$ S/m, $\epsilon_r = 1$; $\rho = 0$ kg/m³

Ambient Temperature : 23.2 °C

DASY5 Configuration:

- Probe: AM1DV3 - 3128; ; Calibrated: 2020.6.18
- Sensor-Surface: 0mm (Fix Surface)
- Electronics: DAE4 Sn690; Calibrated: 2020.3.26
- Phantom: HAC Test Arch with AMCC; Type: SD HAC P01 BA;
- Measurement SW: DASY52, Version 52.10 (4); SEMCAD X Version 14.6.14 (7483)

Ch661/y (transversal) 4.2mm 50 x 50/ABM Interpolated SNR(x,y,z) (121x121x1):

Interpolated grid: dx=1.000 mm, dy=1.000 mm

ABM1/ABM2 = 42.62 dB

ABM1 comp = -11.16 dBA/m

BWC Factor = 0.16 dB

Location: -3.7, -17.9, 3.7 mm

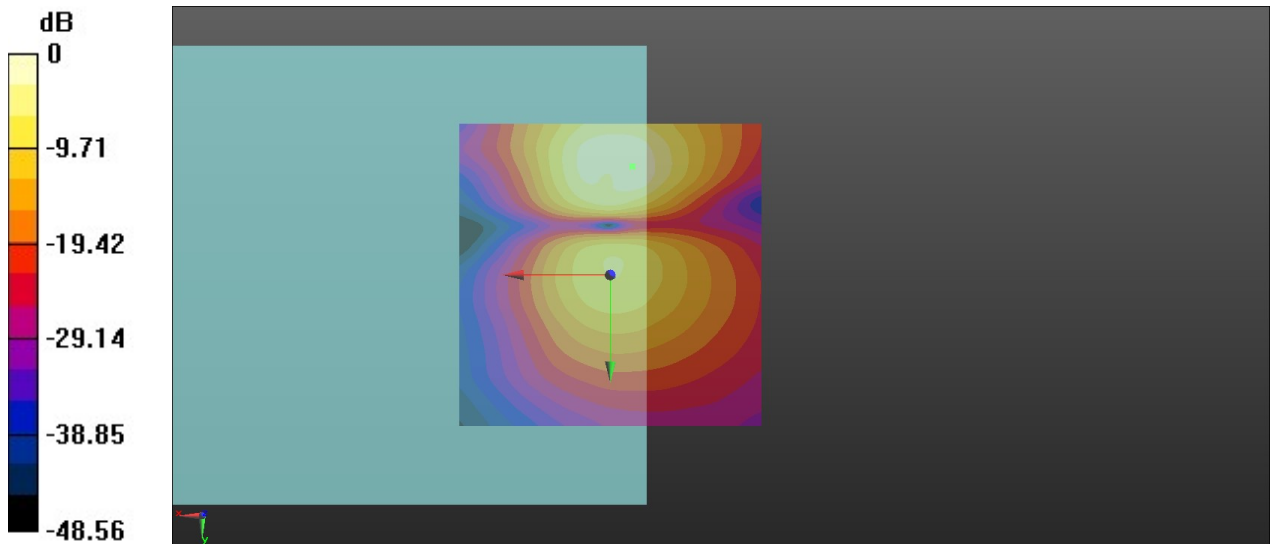

0 dB = 135.2 = 42.62 dB

3_HAC T-Coil WCDMA II_Voice_AMR 12.2Kbps_Ch9400 (Z)

Communication System: UID 0, WCDMA (0); Frequency: 1880 MHz; Duty Cycle: 1:1

Medium: Air Medium parameters used: $\sigma = 0$ S/m, $\epsilon_r = 1$; $\rho = 0$ kg/m³

Ambient Temperature : 23.2 °C

DASY5 Configuration:

- Probe: AM1DV3 - 3128; ; Calibrated: 2020.6.18
- Sensor-Surface: 0mm (Fix Surface)
- Electronics: DAE4 Sn690; Calibrated: 2020.3.26
- Phantom: HAC Test Arch with AMCC; Type: SD HAC P01 BA;
- Measurement SW: DASY52, Version 52.10 (4); SEMCAD X Version 14.6.14 (7483)

Ch9400/z (axial) 4.2mm 50 x 50/ABM Interpolated SNR(x,y,z) (121x121x1):

Interpolated grid: dx=1.000 mm, dy=1.000 mm

ABM1/ABM2 = 47.03 dB

ABM1 comp = 1.29 dBA/m

BWC Factor = 0.16 dB

Location: 0.8, -7.9, 3.7 mm

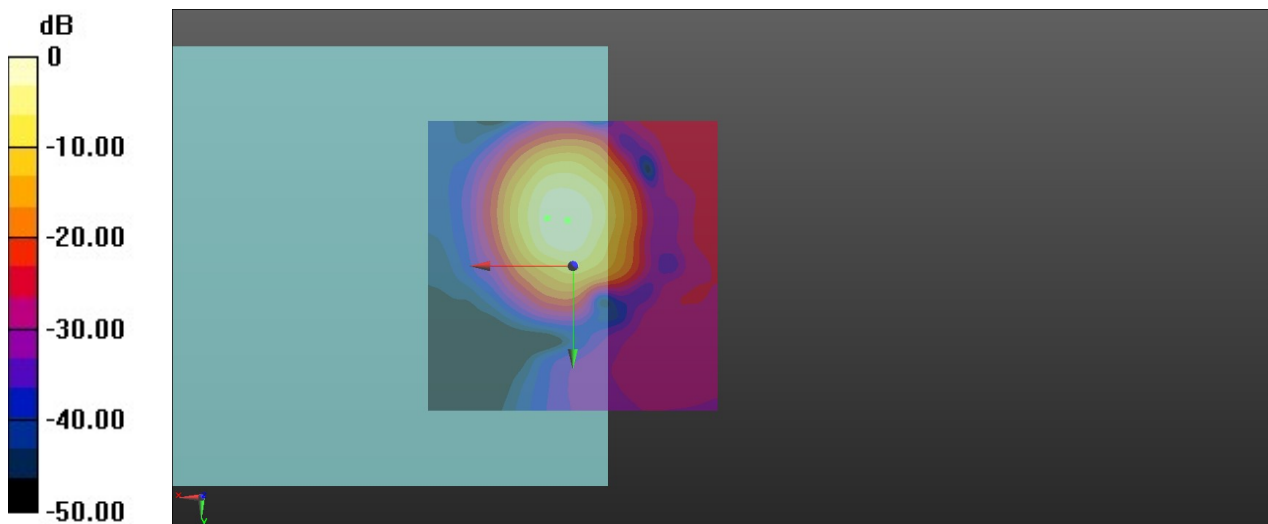

0 dB = 224.7 = 47.03 dB

Ch9400/z (axial) wideband at best S/N/ABM Freq Resp(x,y,z,f)

Loc: 4.5, -8.2, 3.7 mm Diff: 0.61dB

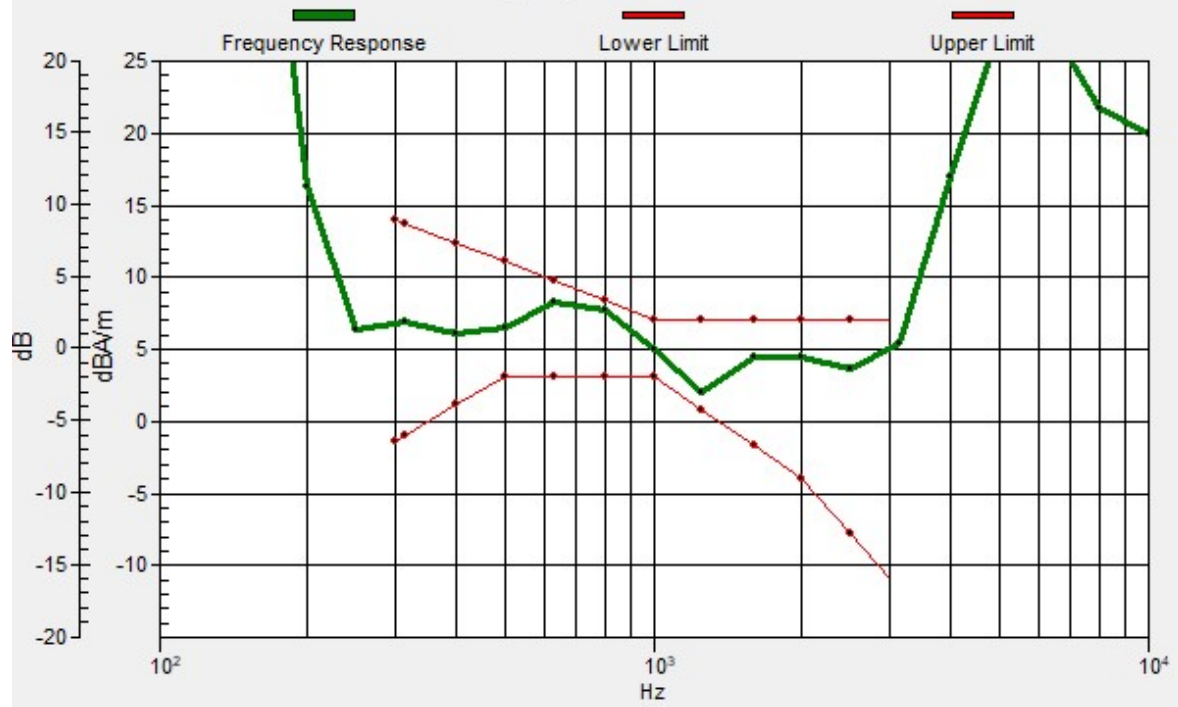

3_HAC T-Coil WCDMA II_Voice_AMR 12.2Kbps_Ch9400 (Y)

Communication System: UID 0, WCDMA (0); Frequency: 1880 MHz; Duty Cycle: 1:1

Medium: Air Medium parameters used: $\sigma = 0$ S/m, $\epsilon_r = 1$; $\rho = 0$ kg/m³

Ambient Temperature : 23.2 °C

DASY5 Configuration:

- Probe: AM1DV3 - 3128; ; Calibrated: 2020.6.18
- Sensor-Surface: 0mm (Fix Surface)
- Electronics: DAE4 Sn690; Calibrated: 2020.3.26
- Phantom: HAC Test Arch with AMCC; Type: SD HAC P01 BA;
- Measurement SW: DASY52, Version 52.10 (4); SEMCAD X Version 14.6.14 (7483)

Ch9400/y (transversal) 4.2mm 50 x 50/ABM Interpolated SNR(x,y,z) (121x121x1):

Interpolated grid: dx=1.000 mm, dy=1.000 mm

ABM1/ABM2 = 44.69 dB

ABM1 comp = -8.17 dBA/m

BWC Factor = 0.16 dB

Location: -1.7, -17.1, 3.7 mm

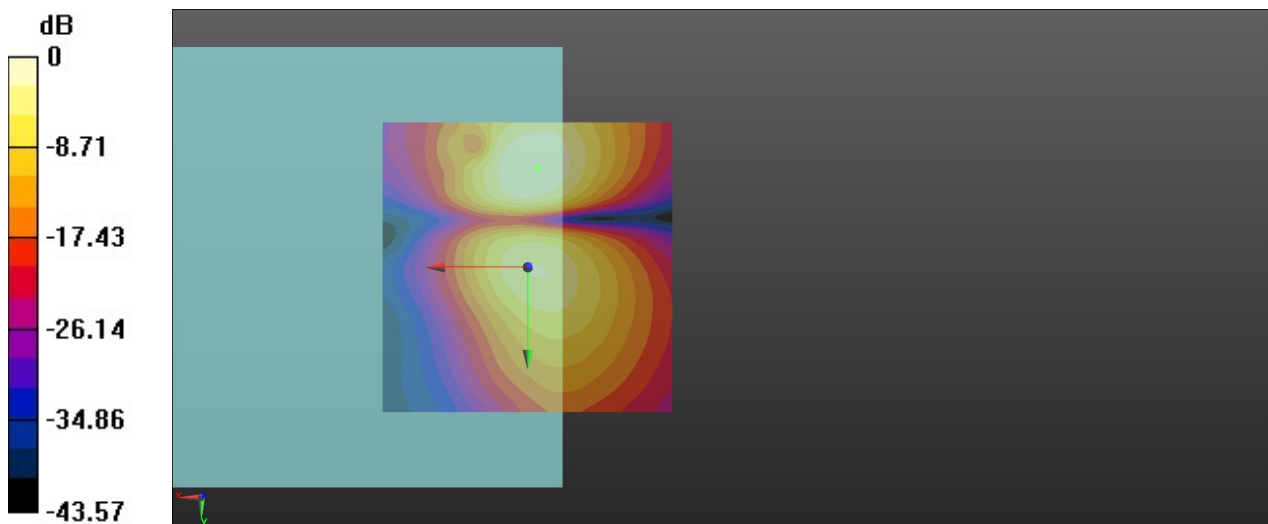

0 dB = 171.7 = 44.69 dB

4_HAC T-Coil WCDMA IV_Voice_AMR 12.2Kbps_Ch1413(Z)

Communication System: UID 0, WCDMA (0); Frequency: 1732.6 MHz; Duty Cycle: 1:1

Medium: Air Medium parameters used: $\sigma = 0$ S/m, $\epsilon_r = 1$; $\rho = 0$ kg/m³

Ambient Temperature : 23.2 °C;

DASY5 Configuration:

- Probe: AM1DV3 - 3128; ; Calibrated: 2020.6.18
- Sensor-Surface: 0mm (Fix Surface)
- Electronics: DAE4 Sn690; Calibrated: 2020.3.26
- Phantom: HAC Test Arch with AMCC; Type: SD HAC P01 BA;
- Measurement SW: DASY52, Version 52.10 (4); SEMCAD X Version 14.6.14 (7483)

Ch1413/z (axial) 4.2mm 50 x 50/ABM Interpolated SNR(x,y,z) (121x121x1):

Interpolated grid: dx=1.000 mm, dy=1.000 mm

ABM1/ABM2 = 48.58 dB

ABM1 comp = 1.39 dBA/m

BWC Factor = 0.16 dB

Location: 0.8, -7.9, 3.7 mm

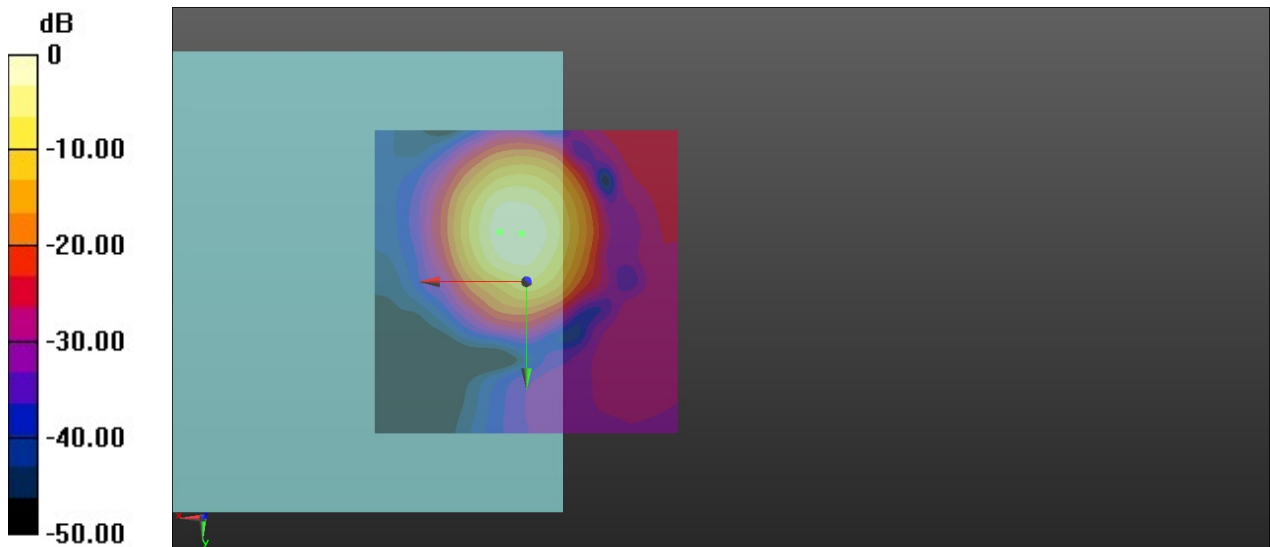

0 dB = 268.5 = 48.58 dB

Ch1413/z (axial) wideband at best S/N/ABM Freq Resp(x,y,z,f)

Loc: 4.4, -8.2, 3.7 mm Diff: 0.62dB

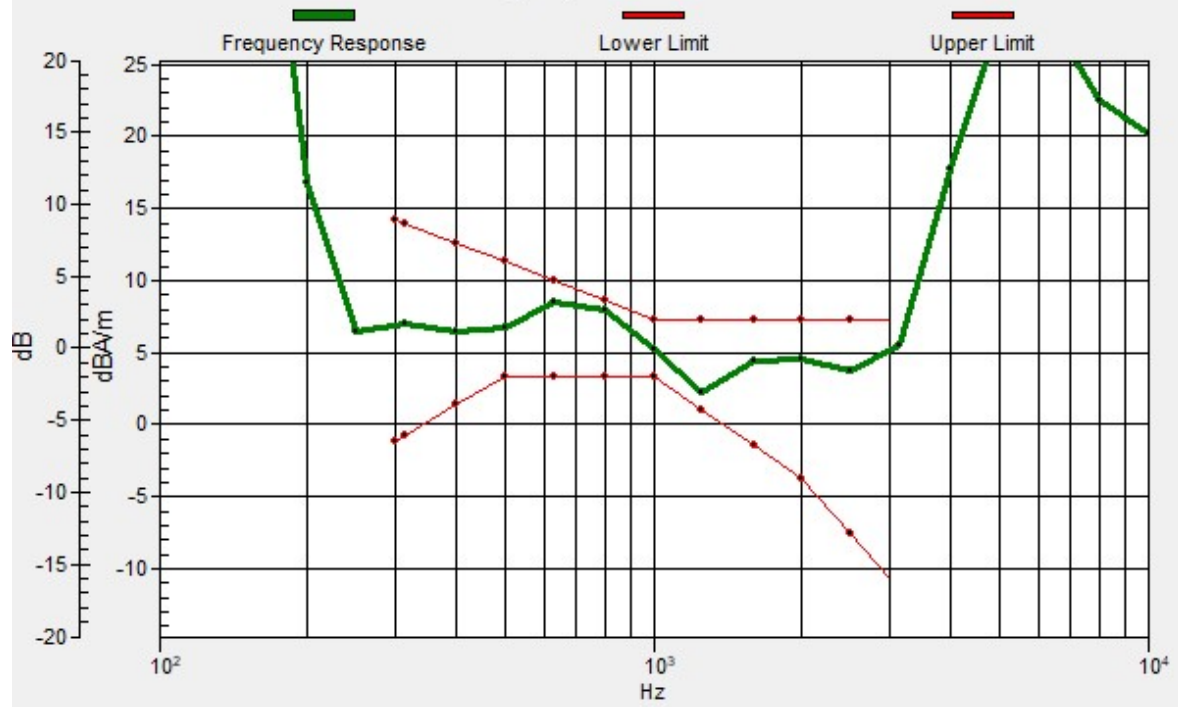

4_HAC T-Coil WCDMA IV_Voice_AMR 12.2Kbps_Ch1413(Y)

Communication System: UID 0, WCDMA (0); Frequency: 1732.6 MHz; Duty Cycle: 1:1

Medium: Air Medium parameters used: $\sigma = 0$ S/m, $\epsilon_r = 1$; $\rho = 0$ kg/m³

Ambient Temperature : 23.2 °C;

DASY5 Configuration:

- Probe: AM1DV3 - 3128; ; Calibrated: 2020.6.18
- Sensor-Surface: 0mm (Fix Surface)
- Electronics: DAE4 Sn690; Calibrated: 2020.3.26
- Phantom: HAC Test Arch with AMCC; Type: SD HAC P01 BA;
- Measurement SW: DASY52, Version 52.10 (4); SEMCAD X Version 14.6.14 (7483)

Ch1413/y (transversal) 4.2mm 50 x 50/ABM Interpolated SNR(x,y,z) (121x121x1):

Interpolated grid: dx=1.000 mm, dy=1.000 mm

ABM1/ABM2 = 45.17 dB

ABM1 comp = -7.71 dBA/m

BWC Factor = 0.16 dB

Location: -1.2, -17.5, 3.7 mm

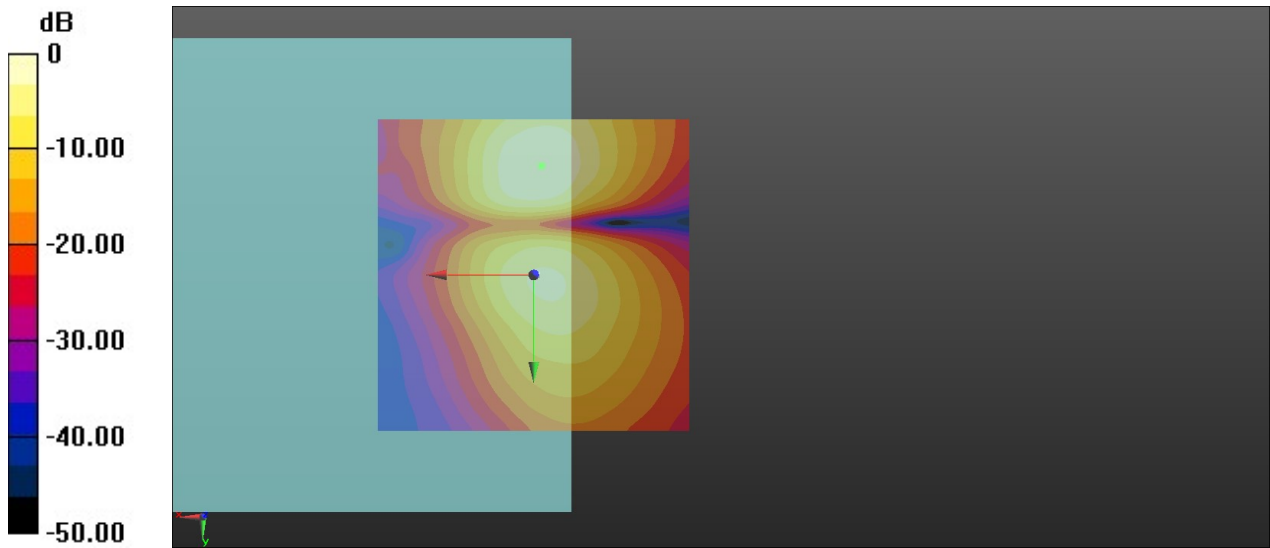

0 dB = 181.3 = 45.17 dB

5_HAC T-Coil WCDMA V_Voice_AMR 12.2Kbps_Ch4182(Z)

Communication System: UID 0, WCDMA (0); Frequency: 836.4 MHz; Duty Cycle: 1:1

Medium: Air Medium parameters used: $\sigma = 0$ S/m, $\epsilon_r = 1$; $\rho = 0$ kg/m³

Ambient Temperature : 23.2 °C;

DASY5 Configuration:

- Probe: AM1DV3 - 3128; ; Calibrated: 2020.6.18
- Sensor-Surface: 0mm (Fix Surface)
- Electronics: DAE4 Sn690; Calibrated: 2020.3.26
- Phantom: HAC Test Arch with AMCC; Type: SD HAC P01 BA;
- Measurement SW: DASY52, Version 52.10 (4); SEMCAD X Version 14.6.14 (7483)

Ch4182/z (axial) 4.2mm 50 x 50/ABM Interpolated SNR(x,y,z) (121x121x1):

Interpolated grid: dx=1.000 mm, dy=1.000 mm

ABM1/ABM2 = 45.92 dB

ABM1 comp = 0.98 dBA/m

BWC Factor = 0.16 dB

Location: 0.4, -8.3, 3.7 mm

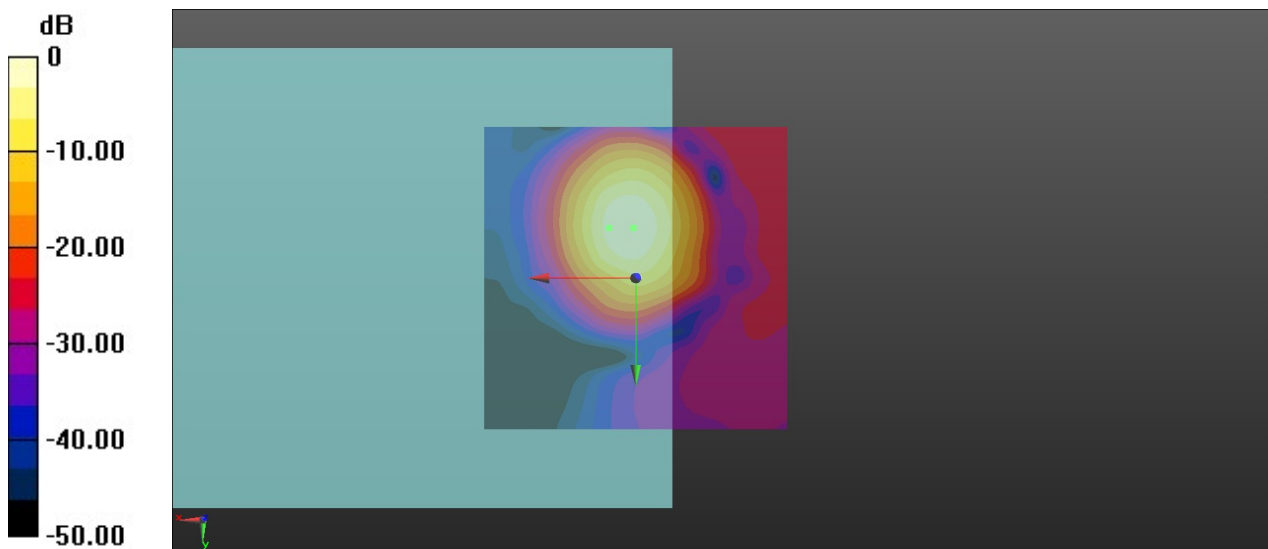

0 dB = 197.6 = 45.92 dB

Ch4182/z (axial) wideband at best S/N/ABM Freq Resp(x,y,z,f)

Loc: 4.4, -8.2, 3.7 mm Diff: 0.5dB

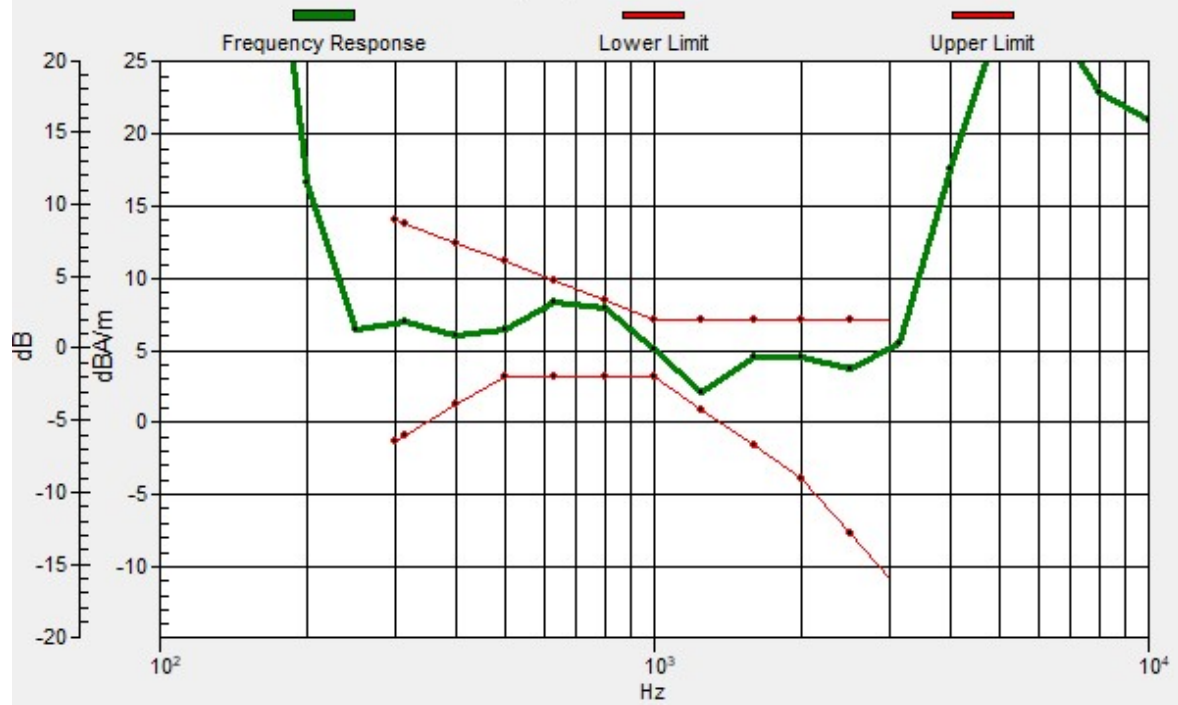

5_HAC T-Coil WCDMA V_Voice_AMR 12.2Kbps_Ch4182(Y)

Communication System: UID 0, WCDMA (0); Frequency: 836.4 MHz; Duty Cycle: 1:1

Medium: Air Medium parameters used: $\sigma = 0$ S/m, $\epsilon_r = 1$; $\rho = 0$ kg/m³

Ambient Temperature : 23.2 °C;

DASY5 Configuration:

- Probe: AM1DV3 - 3128; ; Calibrated: 2020.6.18
- Sensor-Surface: 0mm (Fix Surface)
- Electronics: DAE4 Sn690; Calibrated: 2020.3.26
- Phantom: HAC Test Arch with AMCC; Type: SD HAC P01 BA;
- Measurement SW: DASY52, Version 52.10 (4); SEMCAD X Version 14.6.14 (7483)

Ch4182/y (transversal) 4.2mm 50 x 50/ABM Interpolated SNR(x,y,z) (121x121x1):

Interpolated grid: dx=1.000 mm, dy=1.000 mm

ABM1/ABM2 = 44.69 dB

ABM1 comp = -8.06 dBA/m

BWC Factor = 0.16 dB

Location: -1.7, -17.1, 3.7 mm

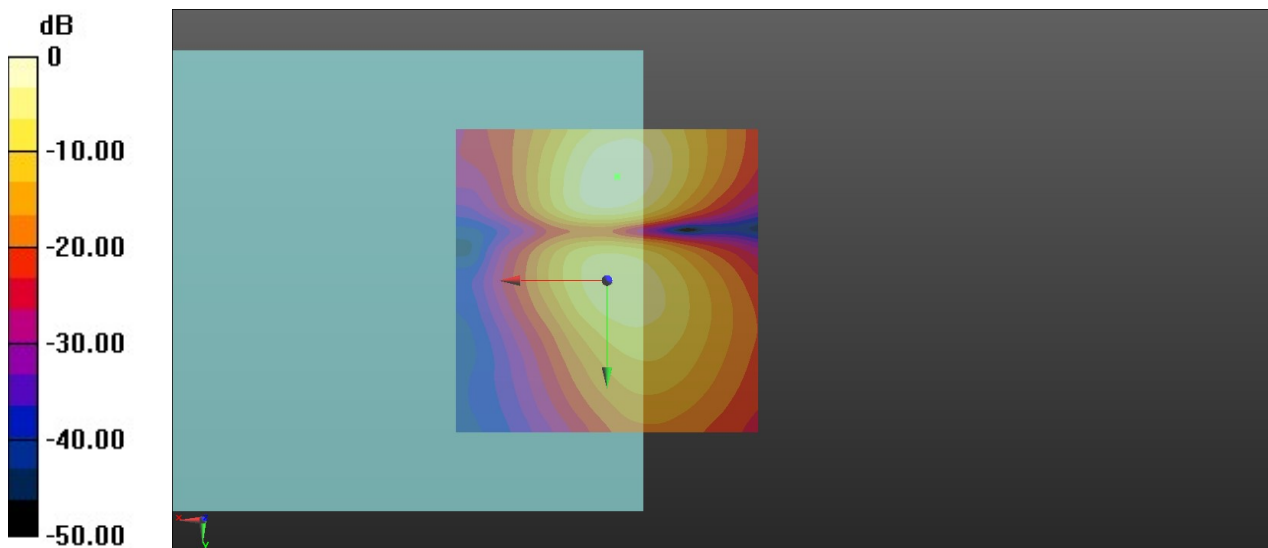

0 dB = 171.6 = 44.69 dB

6_HAC_T-Coil_LTE Band 2_1.4M_16QAM_1RB_0Offset_WB AMR 23.85Kbps_Ch18900 (Z)

Communication System: UID 0, LTE-FDD (0); Frequency: 1880 MHz;Duty Cycle: 1:1

Medium: Air Medium parameters used: $\sigma = 0$ S/m, $\epsilon_r = 1$; $\rho = 0$ kg/m³

Ambient Temperature : 23.2 °C

DASY5 Configuration:

- Probe: AM1DV3 - 3128; ; Calibrated: 2020.6.18
- Sensor-Surface: 0mm (Fix Surface)
- Electronics: DAE4 Sn690; Calibrated: 2020.3.26
- Phantom: HAC Test Arch with AMCC; Type: SD HAC P01 BA;
- Measurement SW: DASY52, Version 52.10 (4); SEMCAD X Version 14.6.14 (7483)

Ch18900/z (axial) 4.2mm 50 x 50/ABM Interpolated SNR(x,y,z) (121x121x1):

Interpolated grid: dx=1.000 mm, dy=1.000 mm

ABM1/ABM2 = 43.24 dB

ABM1 comp = -1.08 dBA/m

BWC Factor = 0.15 dB

Location: 3.8, -8.3, 3.7 mm

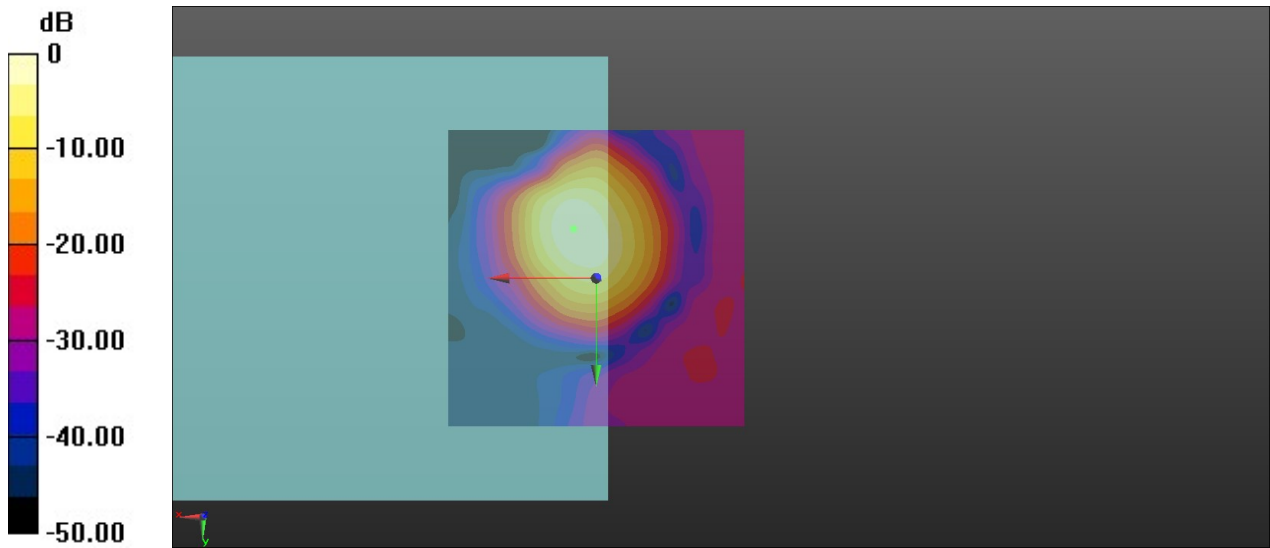

0 dB = 145.2 = 43.24 dB

Ch18900/z (axial) wideband at best S/N/ABM Freq Resp(x,y,z,f)

Loc: 0, 360, 13 mm Diff: 1.72dB

