

FCC SAR Test Report

APPLICANT : Motorola Mobility LLC
EQUIPMENT : Mobile Cellular Phone
BRAND NAME : Motorola
MODEL NAME : XT2093-1, XT2093-7
FCC ID : IHDT56ZD3
STANDARD : FCC 47 CFR Part 2 (2.1093)
ANSI/IEEE C95.1-1992
IEEE 1528-2013

The product was received on Aug. 07, 2020 and testing was started from Aug. 15, 2020 and completed on Sep. 11, 2020. We, Sporton International (Kunshan) Inc, would like to declare that the tested sample has been evaluated in accordance with the procedures and had been in compliance with the applicable technical standards.

The test results in this report apply exclusively to the tested model / sample. Without written approval of Sporton International (Kunshan) Inc., the test report shall not be reproduced except in full.

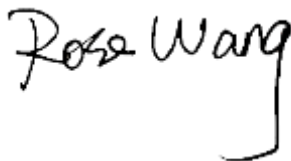

Reviewed by: Rose Wang / Supervisor



Approved by: Kat Yin / Manager



Sporton International (Kunshan) Inc.
No. 1098, Pengxi North Road, Kunshan Economic Development Zone Jiangsu Province 215300
People's Republic of China



Table of Contents

1. Statement of Compliance 4
2. Administration Data 5
3. Guidance Applied 5
4. Equipment Under Test (EUT) Information 6
4.1 General Information 6
4.2 General LTE SAR Test and Reporting Considerations 8
5. Proximity Sensor Triggering Test 10
5.1 Proximity sensor triggering distances(Per KDB616217§6.2) 10
6. RF Exposure Limits 20
6.1 Uncontrolled Environment 20
6.2 Controlled Environment 20
7. Specific Absorption Rate (SAR) 21
7.1 Introduction 21
7.2 SAR Definition 21
8. System Description and Setup 22
8.1 E-Field Probe 23
8.2 Data Acquisition Electronics (DAE) 23
8.3 Phantom 24
8.4 Device Holder 25
9. Measurement Procedures 26
9.1 Spatial Peak SAR Evaluation 26
9.2 Power Reference Measurement 27
9.3 Area Scan 27
9.4 Zoom Scan 28
9.5 Volume Scan Procedures 28
9.6 Power Drift Monitoring 28
10. Test Equipment List 29
11. System Verification 30
11.1 Tissue Simulating Liquids 30
11.2 Tissue Verification 31
11.3 System Performance Check Results 32
12. RF Exposure Positions 33
12.1 Ear and handset reference point 33
12.2 Definition of the cheek position 34
12.3 Definition of the tilt position 35
12.4 Body Worn Accessory 36
12.5 Product Specific 10g SAR Exposure 37
12.6 Wireless Router 37
13. Conducted RF Output Power (Unit: dBm) 38
14. Antenna Location 46
15. SAR Test Results 47
15.1 Head SAR 50
15.2 Hotspot SAR 53
15.3 Body Worn Accessory SAR 59
15.4 Product specific 10g SAR 63
15.5 Repeated SAR Measurement 66
16. Simultaneous Transmission Analysis 67
16.1 Head Exposure Conditions 68
16.2 Hotspot Exposure Conditions 70
16.3 Body-Worn Accessory Exposure Conditions 72
16.4 Product specific 10g SAR Exposure Conditions 75
16.5 SPLSR Evaluation and Analysis 77
17. Supplemental Tuner Tests Results 87
17.1 Supplemental Tuner Head & Body SAR Results 87
18. Uncertainty Assessment 88
19. References 89
Appendix A. Plots of System Performance Check
Appendix B. Plots of High SAR Measurement
Appendix C. DASy Calibration Certificate
Appendix D. Test Setup Photos
Appendix E. Conducted RF Output Power Table
Appendix F. Supplemental Tuner SAR Results



Revision History

REPORT NO.	VERSION	DESCRIPTION	ISSUED DATE
FA080709-01	Rev. 01	Initial issue of report	Sep. 27, 2020



1. Statement of Compliance

The maximum results of Specific Absorption Rate (SAR) found during testing for **Motorola Mobility LLC, Mobile Cellular Phone, XT2093-1, XT2093-7**, are as follows.

Highest 1g SAR Summary						
Equipment Class	Frequency Band		Head (Separation 0mm)	Hotspot (Separation 5mm)	Body-worn (Separation 5mm)	Highest Simultaneous Transmission 1g SAR (W/kg)
			1g SAR (W/kg)			
Licensed	GSM	GSM850	0.49	1.28	1.28	1.59
		GSM1900	<0.10	1.27	1.27	
	WCDMA	Band II	0.22	1.38	1.22	
		Band IV	0.21	1.37	1.33	
		Band V	0.64	1.21	1.21	
	LTE	Band 2	0.13	1.37	1.18	
		Band 5	0.45	1.27	1.27	
		Band 12	0.44	1.08	1.08	
		Band 14	0.48	1.44	1.44	
		Band 30	0.59	1.44	1.44	
		Band 66/Band 4	0.17	1.41	1.43	
DTS	WLAN	2.4GHz WLAN	0.68	1.18	0.81	1.43
NII		5GHz WLAN	0.16	1.13	1.45	1.43
DSS	Bluetooth	2.4GHz Bluetooth	0.32	0.18	0.16	1.59

Highest 10g SAR Summary				
Equipment Class	Frequency Band		Product Specific 10g SAR (W/kg) (Separation 0mm)	Highest Simultaneous Transmission 10g SAR (W/kg)
Licensed	GSM	GSM850	0.67	3.93
		GSM1900	3.19	
	WCDMA	Band II	3.07	
		Band IV	3.45	
		Band V	1.52	
	LTE	Band 2	2.83	
		Band 5	2.42	
		Band 14	1.99	
		Band 30	3.27	
		Band 66/Band 4	3.51	
NII	WLAN	5GHz WLAN	3.12	3.93

Date of Testing: 2020/08/15 ~ 2020/09/11

Remark: This device supports LTE B4 and B66. Since the supported frequency span for LTE B4 falls completely within the supports frequency span for LTE B66, both LTE bands have the same target power, and both LTE bands share the same transmission path; therefore, SAR was only assessed for LTE B66.

Declaration of Conformity:

The test results with all measurement uncertainty excluded are presented in accordance with the regulation limits or requirements declared by manufacturers.

Comments and Explanations:

The declared of product specification for EUT presented in the report are provided by the manufacturer, and the manufacturer takes all the responsibilities for the accuracy of product specification.

This device is in compliance with Specific Absorption Rate (SAR) for general population/uncontrolled exposure limits (1.6 W/kg for Partial-Body 1g SAR, 4.0 W/kg for Product Specific 10g SAR) specified in FCC 47 CFR part 2 (2.1093) and ANSI/IEEE C95.1-1992, and had been tested in accordance with the measurement methods and procedures specified in IEEE 1528-2013 and FCC KDB publications.



2. Administration Data

Sporton International (Kunshan) Inc. is accredited to ISO/IEC 17025:2017 by American Association for Laboratory Accreditation with Certificate Number 5145.02.

Table with 3 columns: Test Firm, Test Site Location, and Test Site No. (with sub-columns for FCC Designation No. and FCC Test Firm Registration No.).

Table with 2 columns: Applicant Company Name and Address.

Table with 2 columns: Manufacturer Company Name and Address.

3. Guidance Applied

The Specific Absorption Rate (SAR) testing specification, method, and procedure for this device is in accordance with the following standards:

- List of standards including FCC 47 CFR Part 2 (2.1093), ANSI/IEEE C95.1-1992, IEEE 1528-2013, and various FCC KDB SAR measurement and reporting guidelines.



4. Equipment Under Test (EUT) Information

4.1 General Information

Product Feature & Specification	
Equipment Name	Mobile Cellular Phone
Brand Name	Motorola
Model Name	XT2093-1, XT2093-7
FCC ID	IHDT56ZD3
IMEI Code	355565110012419
Wireless Technology and Frequency Range	GSM850: 824.2 MHz ~ 848.8 MHz GSM1900: 1850.2 MHz ~ 1909.8 MHz WCDMA Band II: 1852.4 MHz ~ 1907.6 MHz WCDMA Band IV: 1712.4 MHz ~ 1752.6 MHz WCDMA Band V: 826.4 MHz ~ 846.6 MHz LTE Band 2: 1850.7 MHz ~ 1909.3 MHz LTE Band 4: 1710.7 MHz ~ 1754.3 MHz LTE Band 5: 824.7 MHz ~ 848.3 MHz LTE Band 12: 699.7 MHz ~ 715.3 MHz LTE Band 14: 790.5 MHz ~ 795.5 MHz LTE Band 30: 2307.5 MHz ~ 2312.5 MHz LTE Band 66: 1710.7 MHz ~ 1779.3 MHz WLAN 2.4GHz Band: 2412 MHz ~ 2462 MHz WLAN 5.2GHz Band: 5180 MHz ~ 5240 MHz WLAN 5.3GHz Band: 5260 MHz ~ 5320 MHz WLAN 5.5GHz Band: 5500 MHz ~ 5720 MHz WLAN 5.8GHz Band: 5745 MHz ~ 5825 MHz Bluetooth: 2402 MHz ~ 2480 MHz
Mode	GSM/GPRS/EGPRS RMC/AMR 12.2Kbps HSDPA HSUPA DC-HSDPA HSPA+(16QAM uplink is not supported) LTE: QPSK, 16QAM, 64QAM WLAN 2.4GHz 802.11b/g/n HT20 WLAN 5GHz 802.11a/n/ac HT20/HT40/VHT20/VHT40/VHT80 Bluetooth BR/EDR/LE
HW Version	DVT2
SW Version	QZA30.32
GSM / (E)GPRS Transfer mode	Class B – EUT cannot support Packet Switched and Circuit Switched Network simultaneously but can automatically switch between Packet and Circuit Switched Network.
EUT Stage	Identical Prototype
Remark: 1. 802.11n-HT40 is not supported in 2.4GHz WLAN. 2. This device supports VoIP in GPRS, EGPRS, WCDMA and LTE (e.g. for 3rd-party VoIP), LTE supports VoLTE operation. 3. This device 2.4GHz WLAN support hotspot operation and Bluetooth support tethering applications. 4. This device 2.4GHz WLAN/5.2GHz WLAN/5.8GHz WLAN support hotspot operation, and 5.2GHz WLAN/5.8GHz WLAN supports WiFi Direct (GC/GO), and 5.3GHz / 5.5GHz supports WiFi Direct (GC only). 5. This device does not support DTM operation and supports GRPS/EGRPS mode up to multi-slot class 12. 6. The device implements Proximity sensors/receiver detect mechanism/hotspot trigger reduced power for the power management for SAR compliance at different exposure conditions (head, body-worn, hotspot, extremity). 7. The device will invoke corresponding work scenarios power level, which are provided in the operational description. 8. For Some WWAN bands, sensor on reduced power level higher than hotspot reduced power level, so front/back sensor on SAR can represent hotspot conservatively. 9. When handheld state, when WWAN transmit simultaneous with WLAN/Bluetooth, for WLAN5.2GHz/5.3GHz/5.5GHz /5.8GHz, product specific 10g SAR condition reduced powers will be active for back side. Other faces full power can be tested pass, so reduced power no need to be evaluated. 10. This device has two WWAN transmitter antennas. WWAN antenna 1 is located at the right of bottom edge of the	



device and WWAN antenna 2 is located at the left side of bottom edge of the device which can refer to antenna location chapter. WWAN antenna 1 frequency bands include GSM850/1900, WCDMA Band II/IV/V and LTE Band 2/4/5/12/14//66, WWAN antenna 2 frequency band include LTE Band 30.

11. This device implements antenna tuning techniques for several WWAN (cellular) operating modes and frequencies for the purpose of improving antenna efficiency over a broad range of frequencies. Specifically, these techniques are employed in the WCDMA and LTE modes of WWAN antenna 1. In this report SAR was measured according to the normally required SAR configurations with the tuner active and worst tune state (auto tune) was used for SAR testing. The detail descriptions of the antenna tuner and supplemental data for additional information on section17.



4.2 General LTE SAR Test and Reporting Considerations

Summarized necessary items addressed in KDB 941225 D05 v02r05																																																															
FCC ID	IHDT56ZD3																																																														
Equipment Name	Mobile Cellular Phone																																																														
Operating Frequency Range of each LTE transmission band	LTE Band 2: 1850.7 MHz ~ 1909.3 MHz LTE Band 4: 1710.7 MHz ~ 1754.3 MHz LTE Band 5: 824.7 MHz ~ 848.3 MHz LTE Band 12: 699.7 MHz ~ 715.3 MHz LTE Band 14: 790.5 MHz ~ 795.5 MHz LTE Band 30: 2307.5 MHz ~ 2312.5 MHz LTE Band 66: 1710.7 MHz ~ 1779.3 MHz																																																														
Channel Bandwidth	LTE Band 2: 1.4MHz, 3MHz, 5MHz, 10MHz, 15MHz, 20MHz LTE Band 4: 1.4MHz, 3MHz, 5MHz, 10MHz, 15MHz, 20MHz LTE Band 5: 1.4MHz, 3MHz, 5MHz, 10MHz LTE Band 12: 1.4MHz, 3MHz, 5MHz, 10MHz LTE Band 14: 5MHz, 10MHz LTE Band 30: 5MHz, 10MHz LTE Band 66: 1.4MHz, 3MHz, 5MHz, 10MHz, 15MHz, 20MHz																																																														
uplink modulations used	QPSK / 16QAM / 64QAM																																																														
LTE Voice / Data requirements	Voice and Data																																																														
LTE Release Version	R12, Cat4																																																														
CA Support	Not Supported																																																														
LTE MPR permanently built-in by design	<p>Table 6.2.3-1: Maximum Power Reduction (MPR) for Power Class 1, 2 and 3</p> <table border="1"> <thead> <tr> <th rowspan="2">Modulation</th> <th colspan="6">Channel bandwidth / Transmission bandwidth (N_{RB})</th> <th rowspan="2">MPR (dB)</th> </tr> <tr> <th>1.4 MHz</th> <th>3.0 MHz</th> <th>5 MHz</th> <th>10 MHz</th> <th>15 MHz</th> <th>20 MHz</th> </tr> </thead> <tbody> <tr> <td>QPSK</td> <td>> 5</td> <td>> 4</td> <td>> 8</td> <td>> 12</td> <td>> 16</td> <td>> 18</td> <td>≤ 1</td> </tr> <tr> <td>16 QAM</td> <td>≤ 5</td> <td>≤ 4</td> <td>≤ 8</td> <td>≤ 12</td> <td>≤ 16</td> <td>≤ 18</td> <td>≤ 1</td> </tr> <tr> <td>64 QAM</td> <td>> 5</td> <td>> 4</td> <td>> 8</td> <td>> 12</td> <td>> 16</td> <td>> 18</td> <td>≤ 2</td> </tr> <tr> <td>256 QAM</td> <td>≤ 5</td> <td>≤ 4</td> <td>≤ 8</td> <td>≤ 12</td> <td>≤ 16</td> <td>≤ 18</td> <td>≤ 2</td> </tr> <tr> <td>64 QAM</td> <td>> 5</td> <td>> 4</td> <td>> 8</td> <td>> 12</td> <td>> 16</td> <td>> 18</td> <td>≤ 3</td> </tr> <tr> <td>256 QAM</td> <td colspan="6" style="text-align: center;">≥ 1</td> <td>≤ 5</td> </tr> </tbody> </table>	Modulation	Channel bandwidth / Transmission bandwidth (N _{RB})						MPR (dB)	1.4 MHz	3.0 MHz	5 MHz	10 MHz	15 MHz	20 MHz	QPSK	> 5	> 4	> 8	> 12	> 16	> 18	≤ 1	16 QAM	≤ 5	≤ 4	≤ 8	≤ 12	≤ 16	≤ 18	≤ 1	64 QAM	> 5	> 4	> 8	> 12	> 16	> 18	≤ 2	256 QAM	≤ 5	≤ 4	≤ 8	≤ 12	≤ 16	≤ 18	≤ 2	64 QAM	> 5	> 4	> 8	> 12	> 16	> 18	≤ 3	256 QAM	≥ 1						≤ 5
Modulation	Channel bandwidth / Transmission bandwidth (N _{RB})						MPR (dB)																																																								
	1.4 MHz	3.0 MHz	5 MHz	10 MHz	15 MHz	20 MHz																																																									
QPSK	> 5	> 4	> 8	> 12	> 16	> 18	≤ 1																																																								
16 QAM	≤ 5	≤ 4	≤ 8	≤ 12	≤ 16	≤ 18	≤ 1																																																								
64 QAM	> 5	> 4	> 8	> 12	> 16	> 18	≤ 2																																																								
256 QAM	≤ 5	≤ 4	≤ 8	≤ 12	≤ 16	≤ 18	≤ 2																																																								
64 QAM	> 5	> 4	> 8	> 12	> 16	> 18	≤ 3																																																								
256 QAM	≥ 1						≤ 5																																																								
LTE A-MPR	In the base station simulator configuration, Network Setting value is set to NS_01 to disable A-MPR during SAR testing and the LTE SAR tests was transmitting on all TTI frames (Maximum TTI)																																																														
Spectrum plots for RB configuration	A properly configured base station simulator was used for the SAR and power measurement; therefore, spectrum plots for each RB allocation and offset configuration are not included in the SAR report.																																																														
Power reduction applied to satisfy SAR compliance	Yes, head/body-worn/ hotspot/extremity will trigger reduced power for some LTE bands, the detail please referred to section 13.																																																														



Transmission (H, M, L) channel numbers and frequencies in each LTE band												
LTE Band 2												
	Bandwidth 1.4 MHz		Bandwidth 3 MHz		Bandwidth 5 MHz		Bandwidth 10 MHz		Bandwidth 15 MHz		Bandwidth 20 MHz	
	Ch. #	Freq. (MHz)	Ch. #	Freq. (MHz)	Ch. #	Freq. (MHz)	Ch. #	Freq. (MHz)	Ch. #	Freq. (MHz)	Ch. #	Freq. (MHz)
L	18607	1850.7	18615	1851.5	18625	1852.5	18650	1855	18675	1857.5	18700	1860
M	18900	1880	18900	1880	18900	1880	18900	1880	18900	1880	18900	1880
H	19193	1909.3	19185	1908.5	19175	1907.5	19150	1905	19125	1902.5	19100	1900
LTE Band 4												
	Bandwidth 1.4 MHz		Bandwidth 3 MHz		Bandwidth 5 MHz		Bandwidth 10 MHz		Bandwidth 15 MHz		Bandwidth 20 MHz	
	Ch. #	Freq. (MHz)	Ch. #	Freq. (MHz)	Ch. #	Freq. (MHz)	Ch. #	Freq. (MHz)	Ch. #	Freq. (MHz)	Ch. #	Freq. (MHz)
L	19957	1710.7	19965	1711.5	19975	1712.5	20000	1715	20025	1717.5	20050	1720
M	20175	1732.5	20175	1732.5	20175	1732.5	20175	1732.5	20175	1732.5	20175	1732.5
H	20393	1754.3	20385	1753.5	20375	1752.5	20350	1750	20325	1747.5	20300	1745
LTE Band 5												
	Bandwidth 1.4 MHz		Bandwidth 3 MHz		Bandwidth 5 MHz		Bandwidth 10 MHz					
	Ch. #	Freq. (MHz)	Ch. #	Freq. (MHz)	Ch. #	Freq. (MHz)	Ch. #	Freq. (MHz)	Ch. #	Freq. (MHz)	Ch. #	Freq. (MHz)
L	20407	824.7	20415	825.5	20425	826.5	20450	829				
M	20525	836.5	20525	836.5	20525	836.5	20525	836.5				
H	20643	848.3	20635	847.5	20625	846.5	20600	844				
LTE Band 12												
	Bandwidth 1.4 MHz		Bandwidth 3 MHz		Bandwidth 5 MHz		Bandwidth 10 MHz					
	Ch. #	Freq. (MHz)	Ch. #	Freq. (MHz)	Ch. #	Freq. (MHz)	Ch. #	Freq. (MHz)	Ch. #	Freq. (MHz)	Ch. #	Freq. (MHz)
L	23017	699.7	23025	700.5	23035	701.5	23060	704				
M	23095	707.5	23095	707.5	23095	707.5	23095	707.5				
H	23173	715.3	23165	714.5	23155	713.5	23130	711				
LTE Band 14												
	Bandwidth 5 MHz				Bandwidth 10 MHz							
	Channel #		Channel #		Channel #		Freq.(MHz)					
L	23305		790.5									
M	23330		793		23330		793					
H	23355		795.5									
LTE Band 30												
	Bandwidth 5 MHz				Bandwidth 10 MHz							
	Channel #		Freq.(MHz)		Channel #		Freq.(MHz)					
L	27685		2307.5									
M	27710		2310		27710		2310					
H	27735		2312.5									
LTE Band 66												
	Bandwidth 1.4 MHz		Bandwidth 3 MHz		Bandwidth 5 MHz		Bandwidth 10 MHz		Bandwidth 15 MHz		Bandwidth 20 MHz	
	Ch. #	Freq. (MHz)	Ch. #	Freq. (MHz)	Ch. #	Freq. (MHz)	Ch. #	Freq. (MHz)	Ch. #	Freq. (MHz)	Ch. #	Freq. (MHz)
L	131979	1710.7	131987	1711.5	131997	1712.5	132022	1715	132047	1717.5	132072	1720
M	132322	1745	132322	1745	132322	1745	132322	1745	132322	1745	132322	1745
H	132665	1779.3	132657	1778.5	132647	1777.5	132622	1775	132597	1772.5	132572	1770

5. Proximity Sensor Triggering Test

5.1 Proximity sensor triggering distances(Per KDB616217§6.2)

- Proximity sensor triggering distance testing was performed according to the procedures outlined in KDB 616217 D04 section 6.2, and EUT moving further away from the flat phantom and EUT moving toward the flat phantom were both assessed and the tissue-equivalent medium for highest frequency (5825MHz) and lowest (850MHz) frequency was used for proximity sensor triggering testing.
- Capacitive proximity sensor placed coincident with antenna elements at the bottom end of the phone are utilized to determine when the device comes in proximity of the user's body at the front or back or bottom or left side surface of the device. There is no need to do sensor coverage testing for the proximity sensor is designed to support sufficient detection range and sensitivity to cover regions of the sensors in all applicable directions since the proximity sensor entirely covers the antenna.
- When the proximity sensor is active, GSM1900, WCDMA band II/IV/V, LTE band 2/4/5/30/66 and WLAN5.2GHz/5.3GHz/5.5GHz/5.8GHz reduced power will be active for front/ back body worn SAR.
- P-sensor can detect handheld state, WCDMA band II/IV and LTE B2/4/30/66 for front/back/left sides/bottom sides of product specific 10g SAR condition reduced powers will be active for handheld SAR.
- The proximity sensors used to detect the proximity of the user's body at the front or back or left side or bottom side surface of the device use a detection threshold distance. The data shown in the sections below shows the distance(s).
- For verification of compliance of power reduction scheme, additional SAR testing with EUT transmitting at full RF power at a conservative trigger distance was performed for body worn:
Front: [20 mm](#)
Back: [23 mm](#)
- For verification of compliance of power reduction scheme, additional SAR testing with EUT transmitting at full RF power at a conservative trigger distance was performed for handheld:
For antenna 2
Front: [7 mm](#)
Back: [6 mm](#)
Bottom side: [9 mm](#)
Left side: [10 mm](#)

For antenna 1
Front: [8 mm](#)
Back: [8 mm](#)
Bottom side: [13 mm](#)

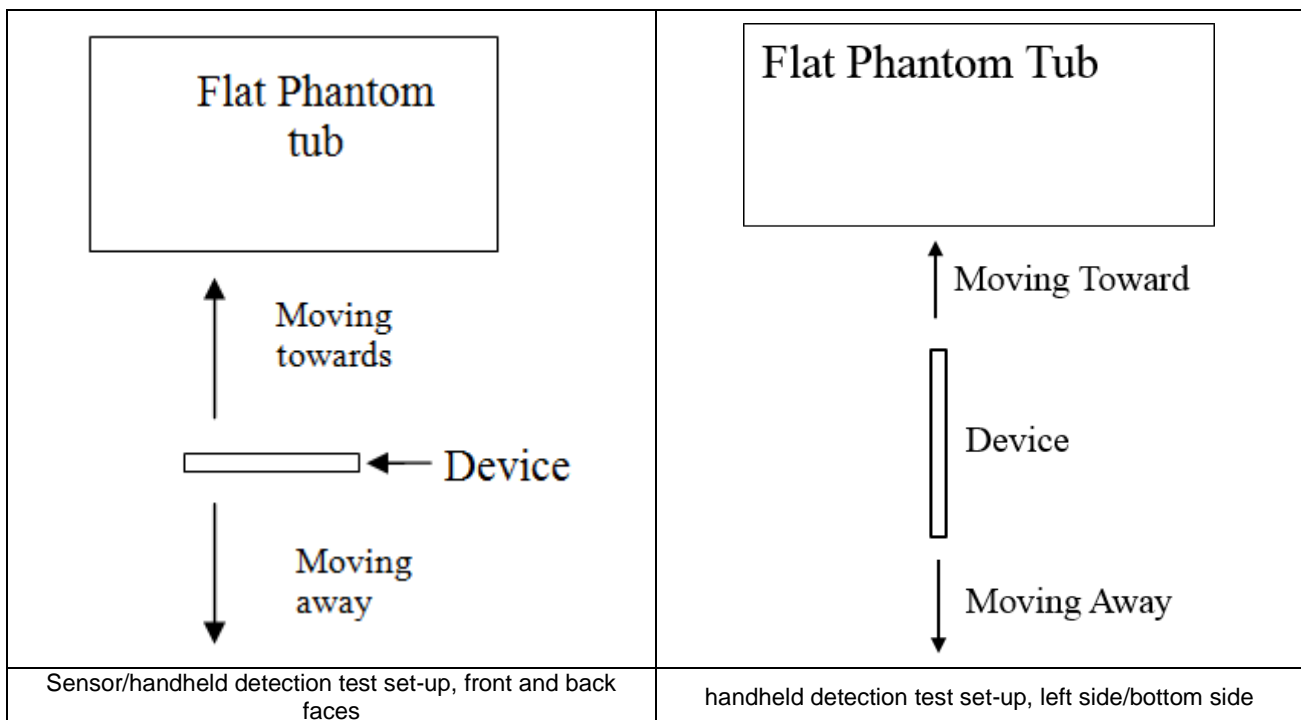



<P-Sensor>

Proximity Sensor Triggering Distance (mm)				
Position	Front		Back	
	Moving towards	Moving away	Moving towards	Moving away
Minimum	22	25	24	27

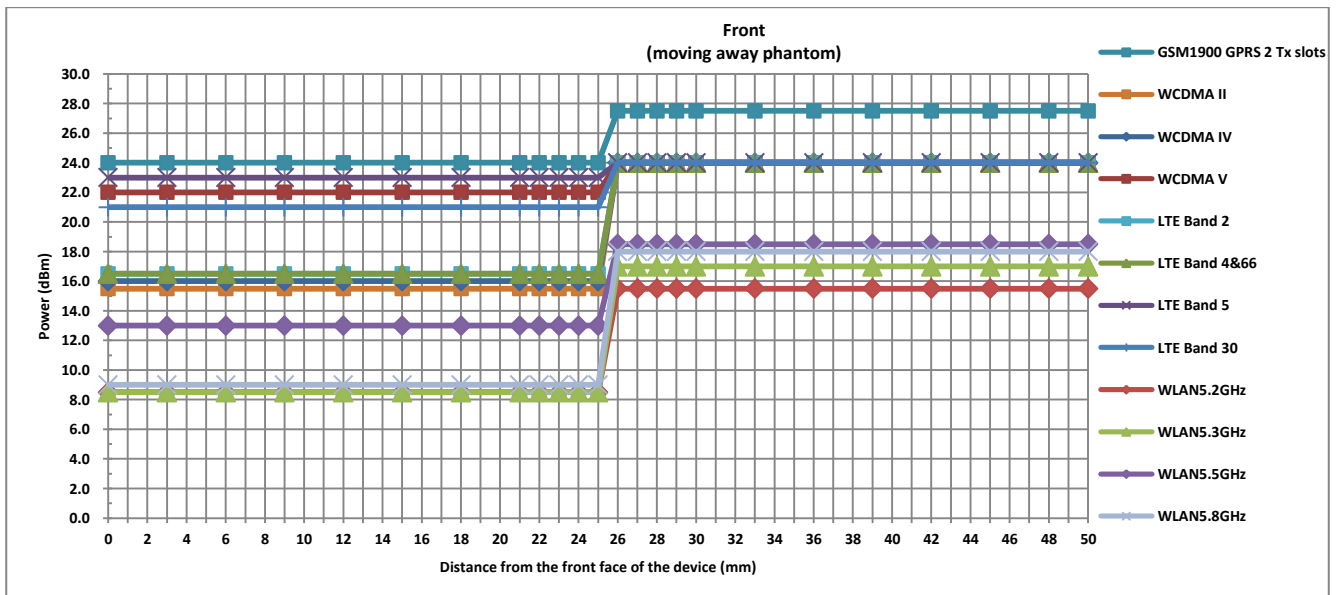
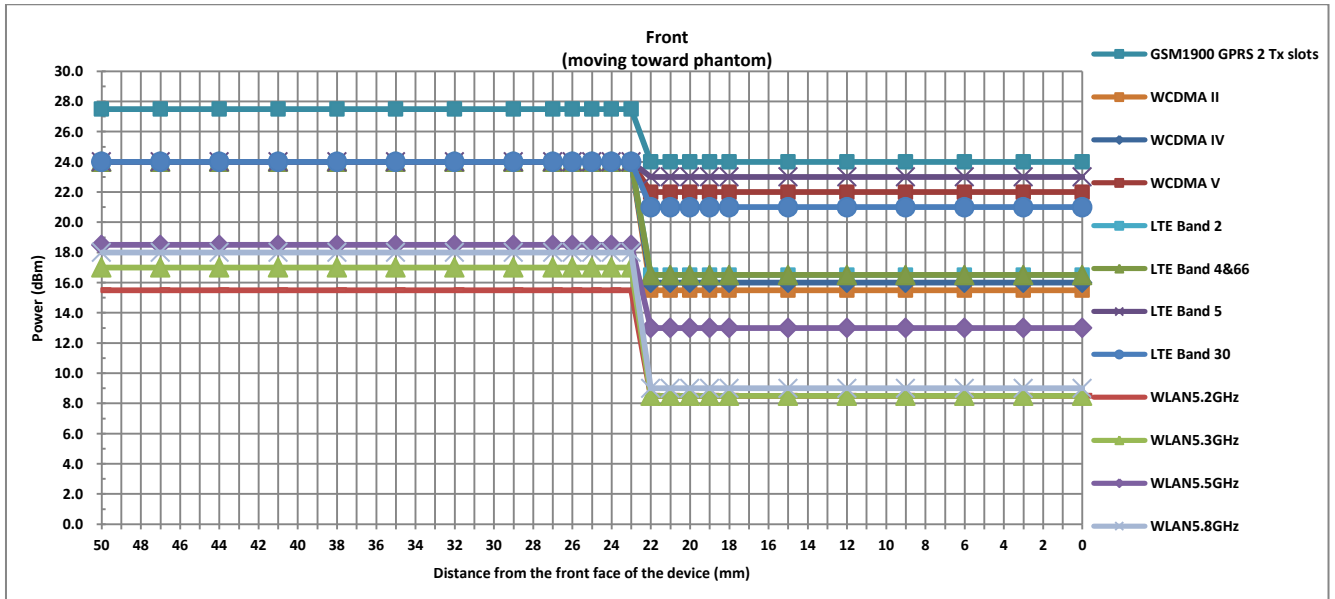

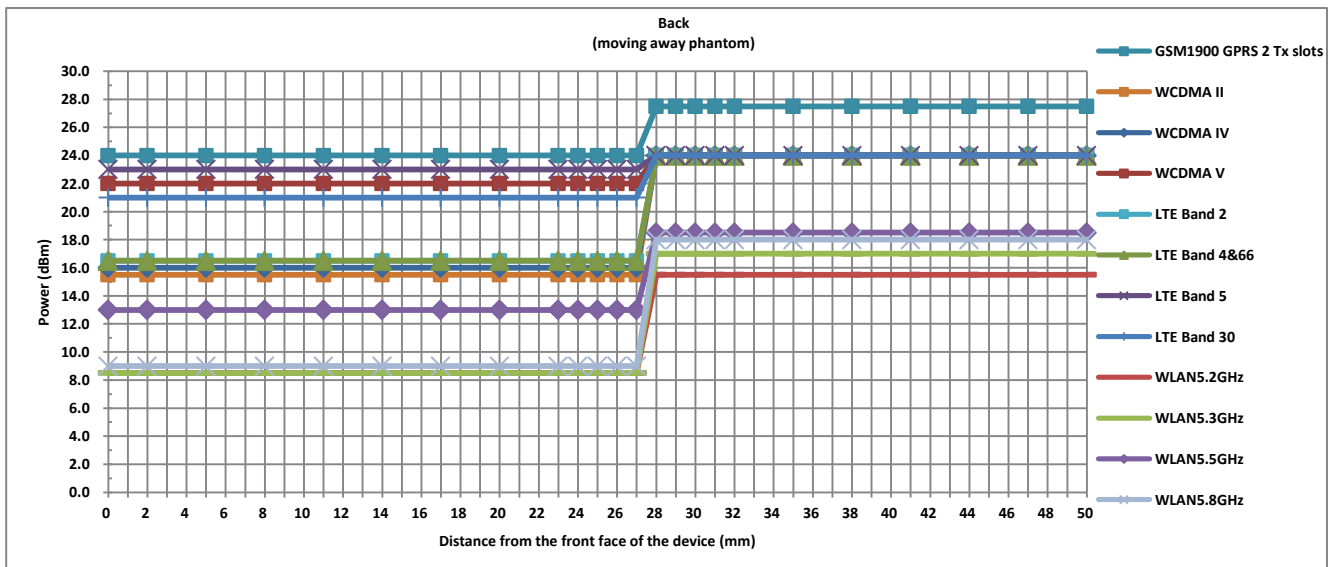
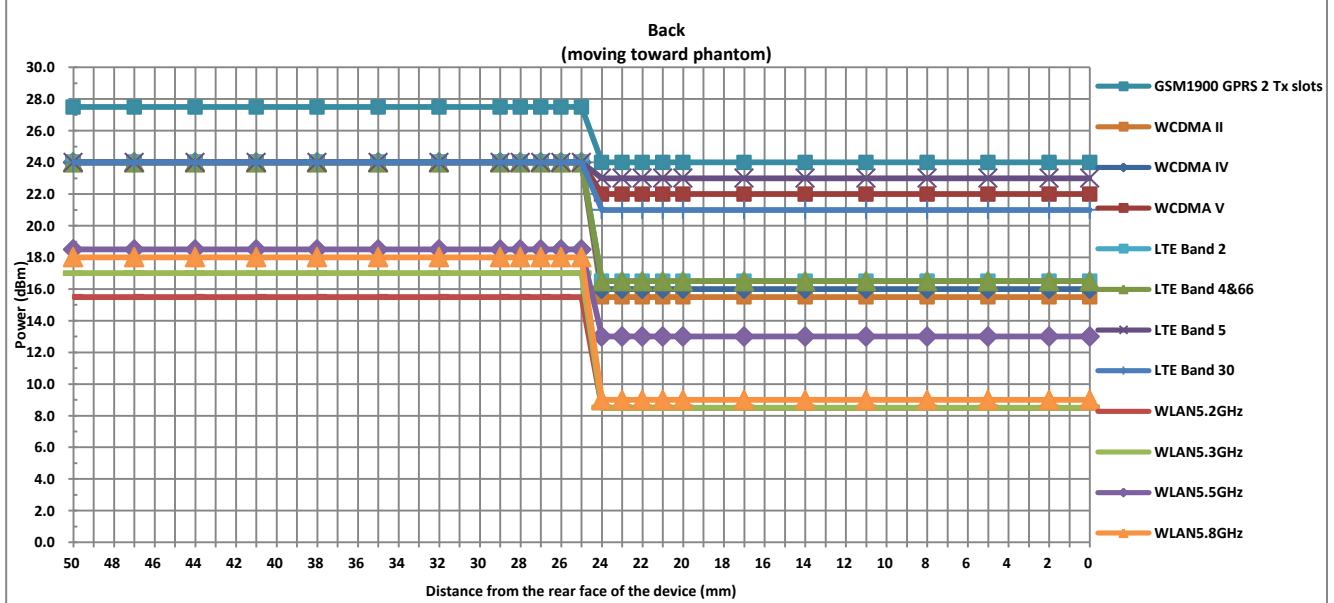



<Handheld for antenna 1>

Position	Front		Back		Bottom Side	
	Moving towards	Moving away	Moving towards	Moving away	Moving towards	Moving away
Minimum	14	17	11	14	21	25

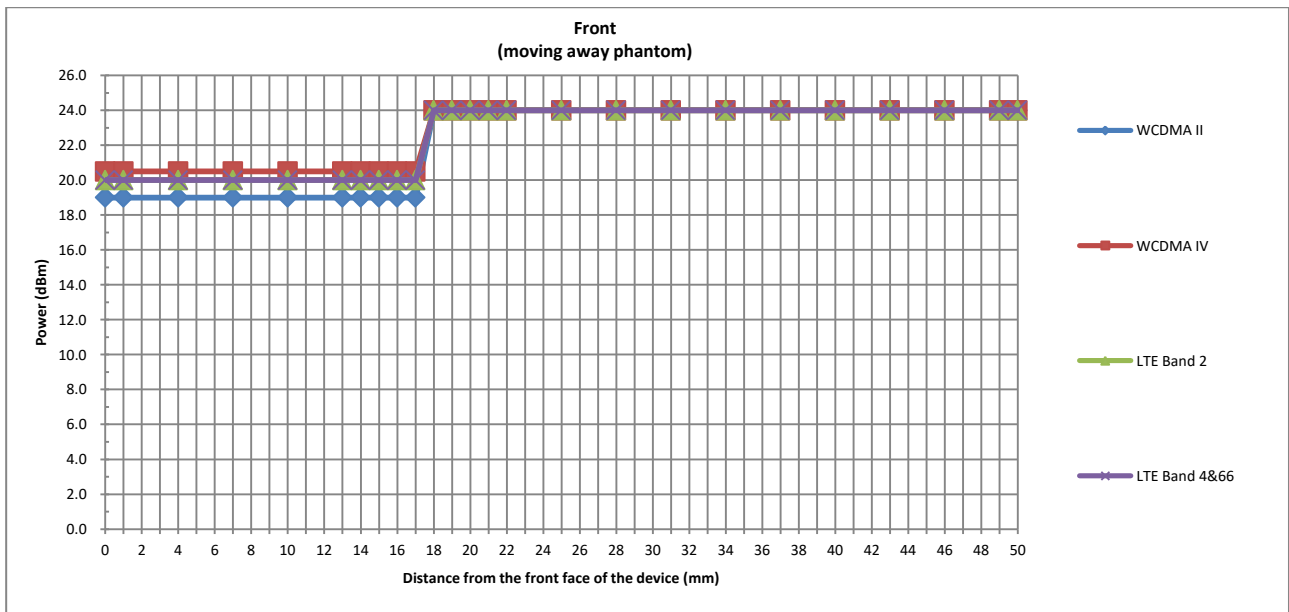
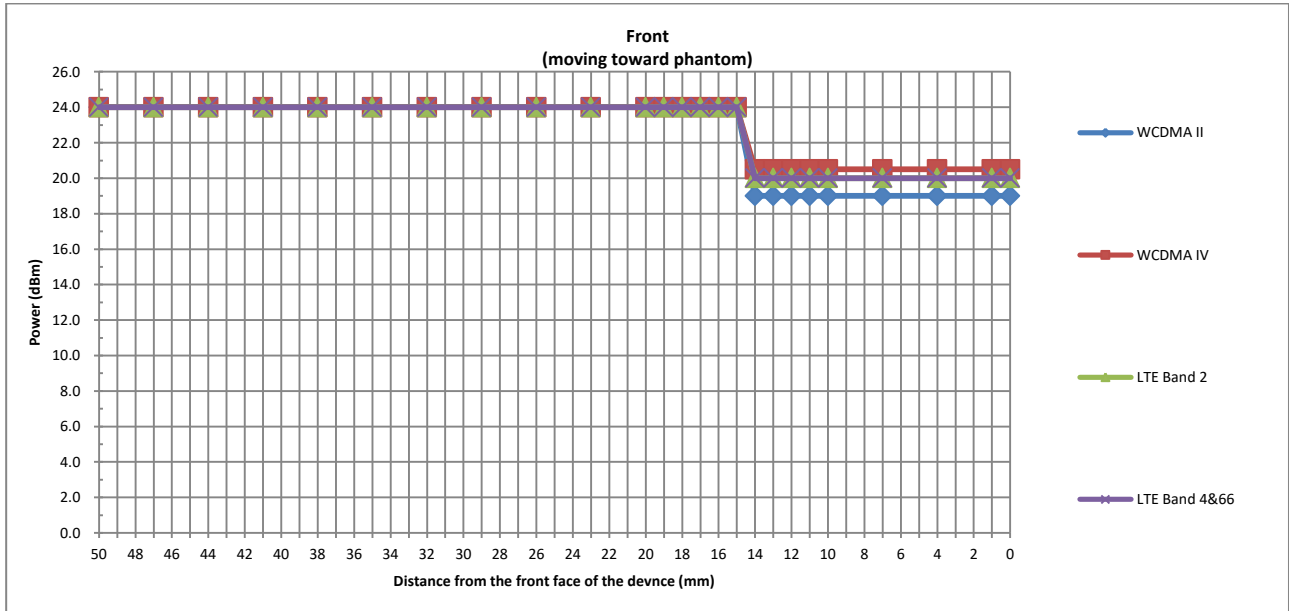

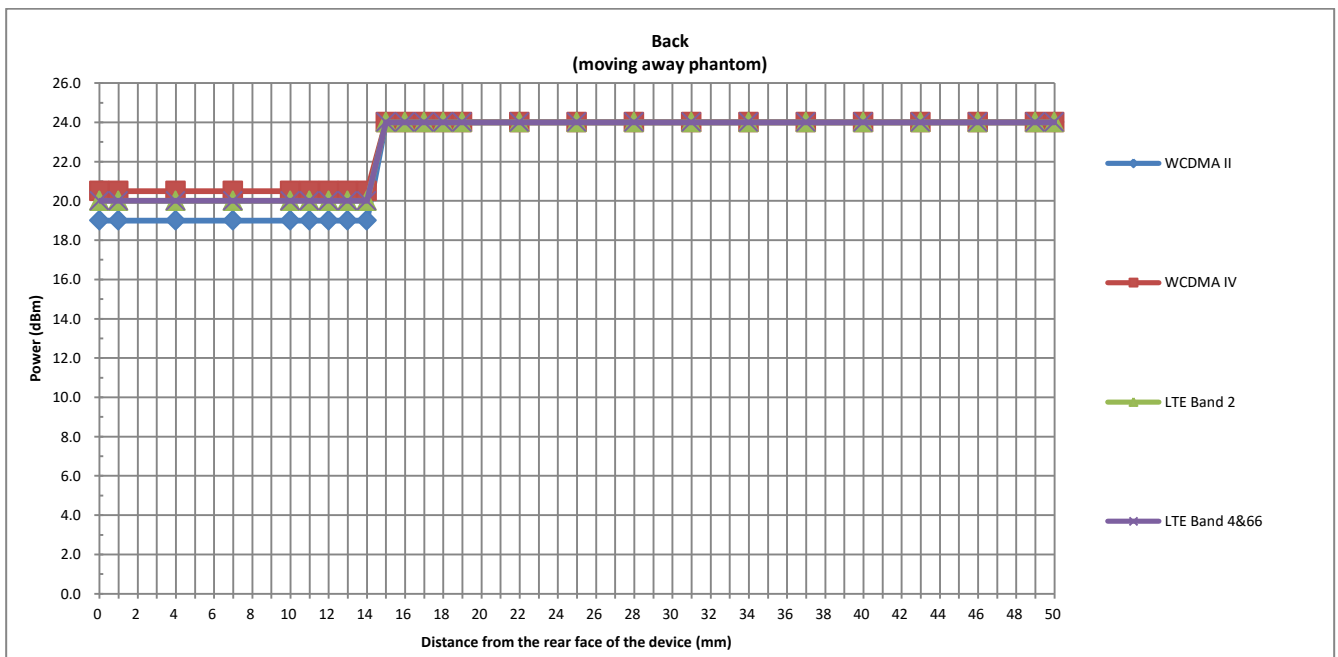
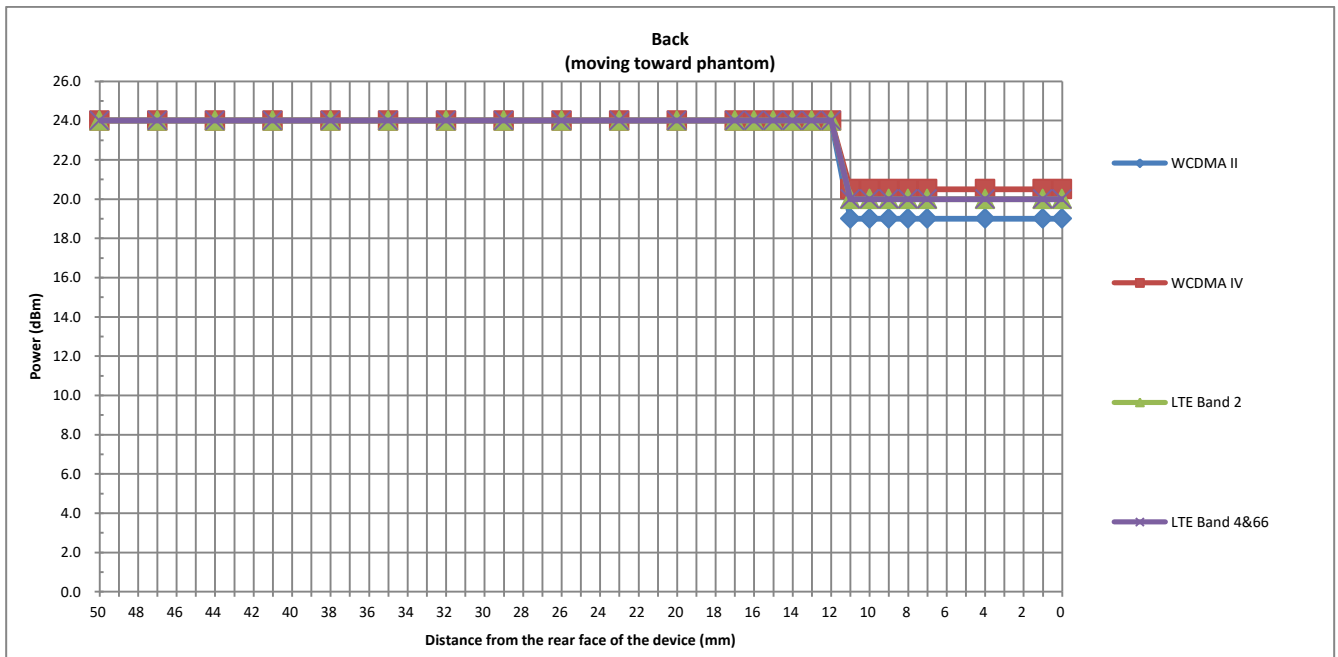

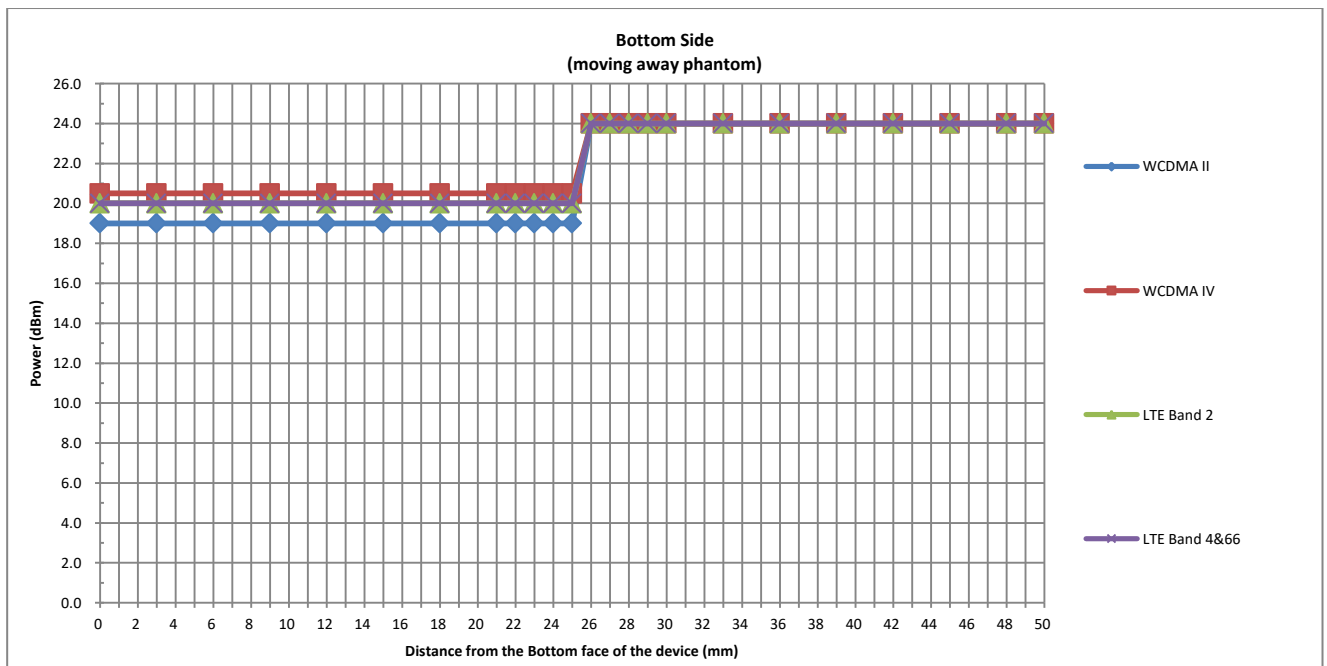
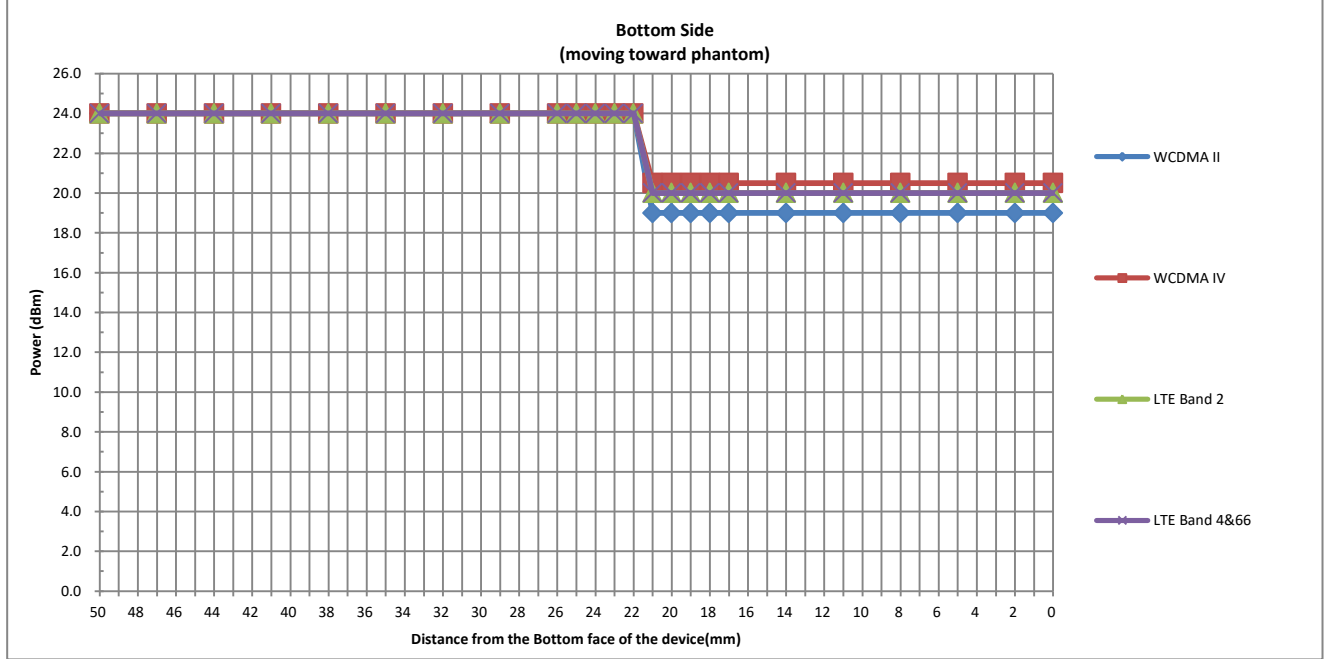



<Handheld for antenna 2>

Position	Front		Back		Left Side		Bottom Side	
	Moving towards	Moving away	Moving towards	Moving away	Moving towards	Moving away	Moving towards	Moving away
Minimum	8	10	7	10	11	12	10	13

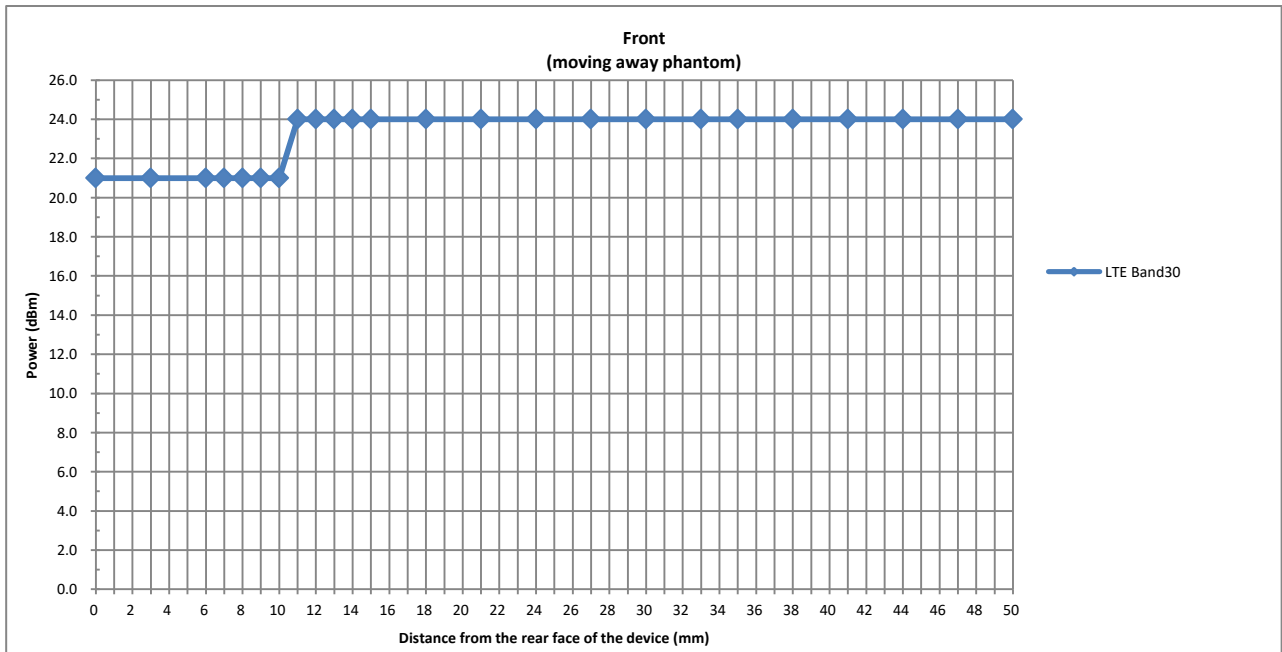
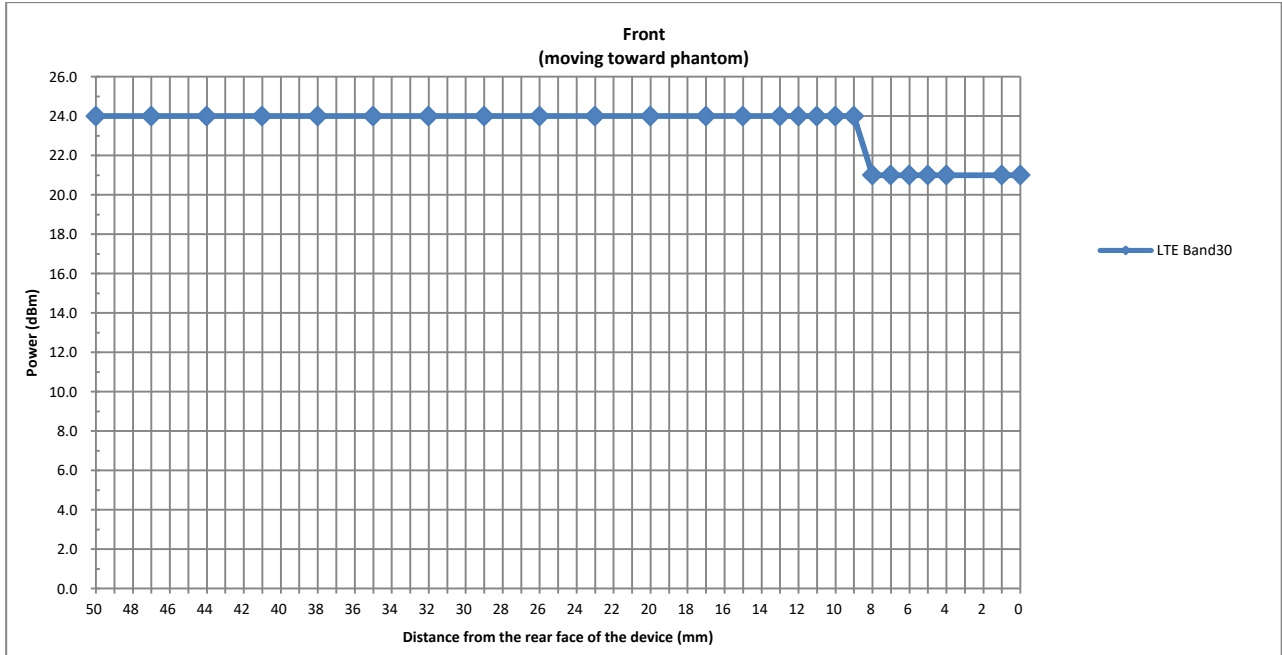

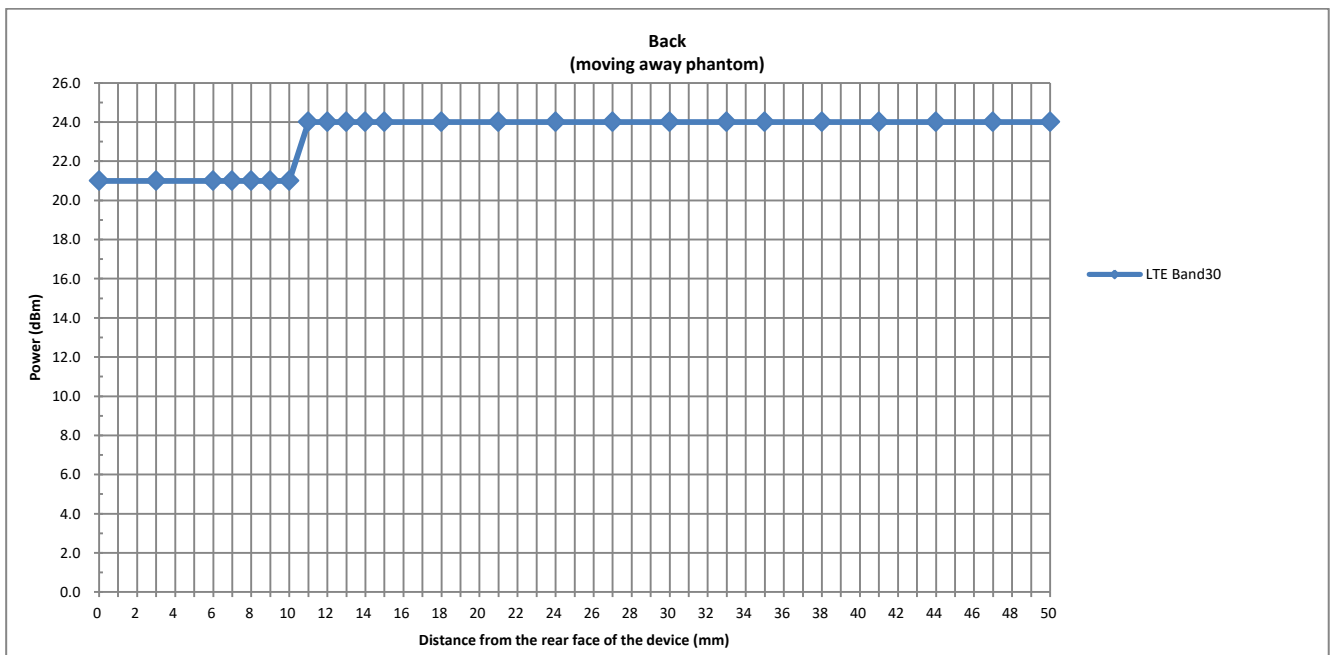
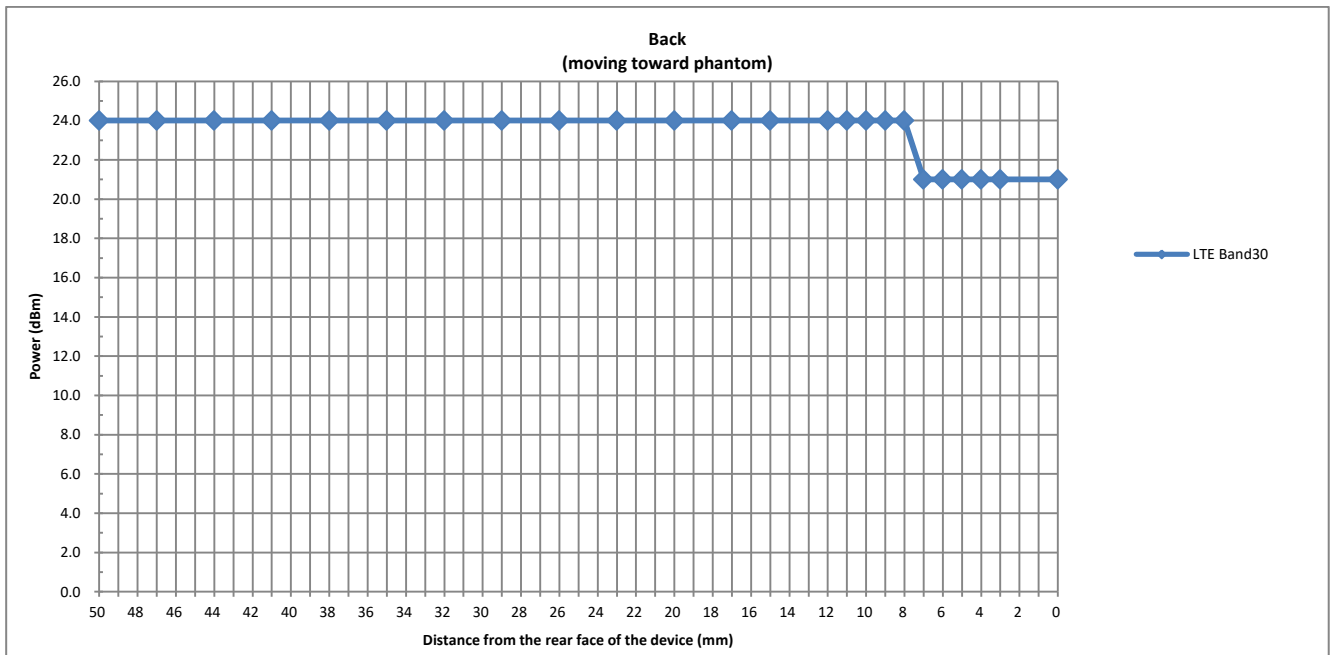

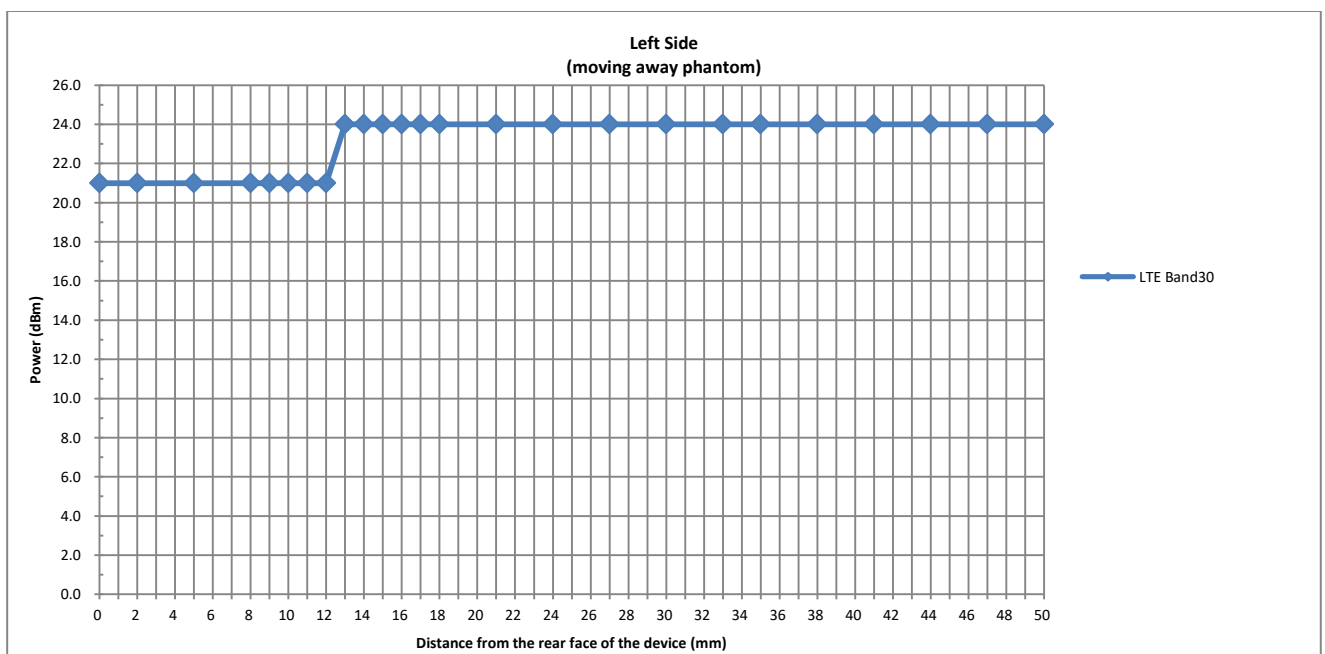
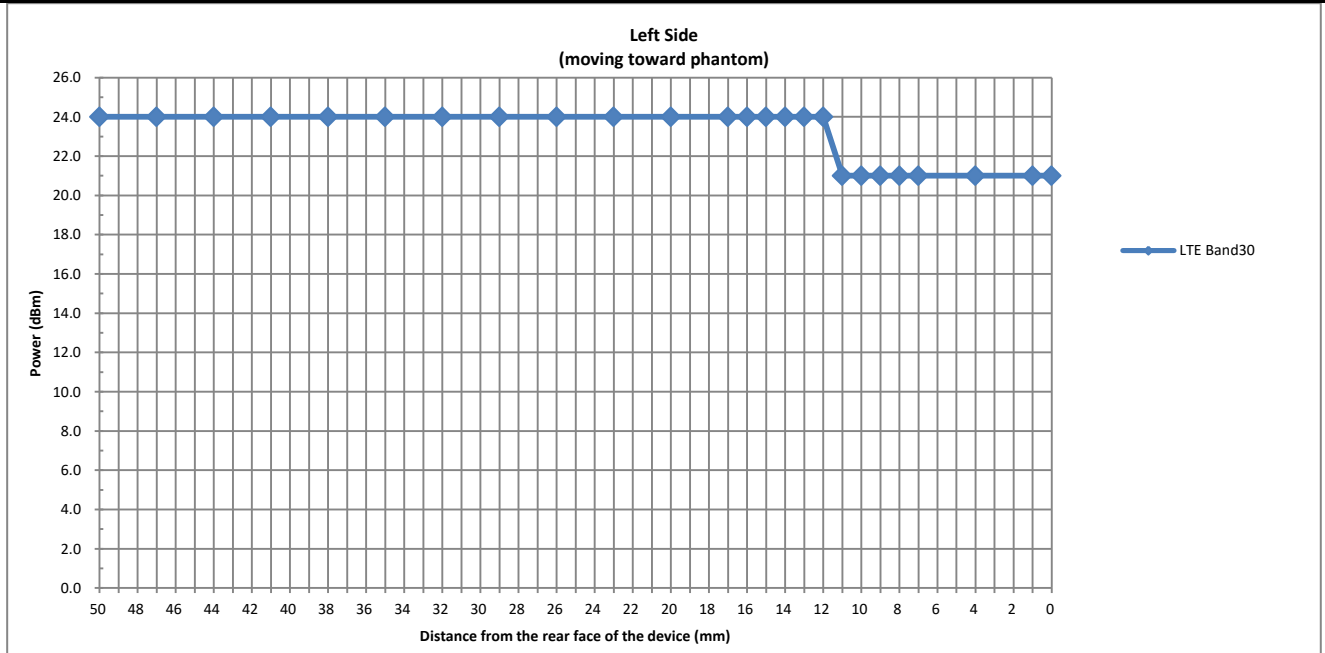

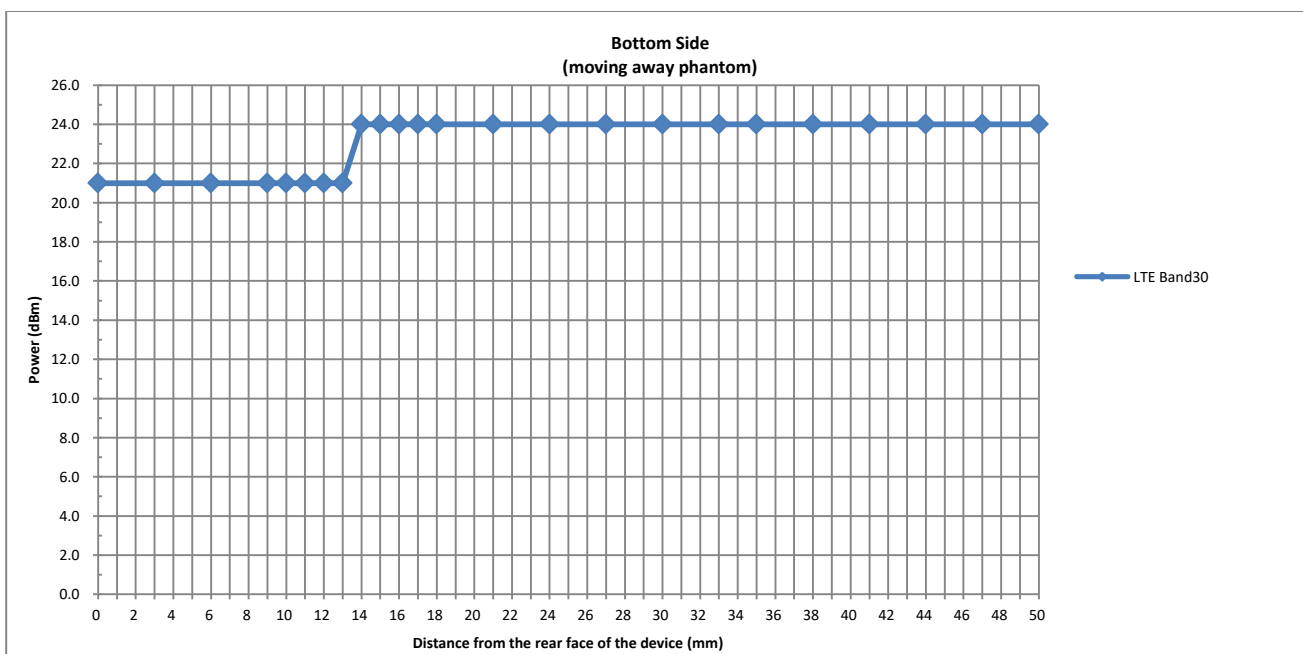
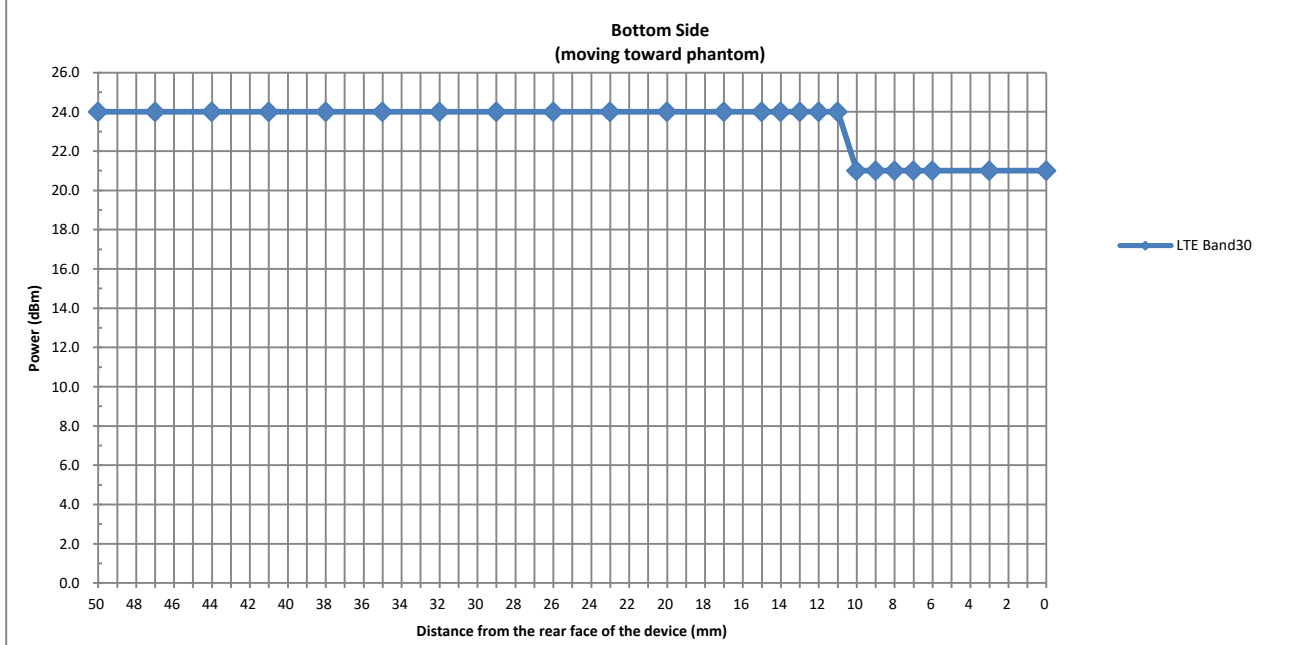



6. RF Exposure Limits

6.1 Uncontrolled Environment

Uncontrolled Environments are defined as locations where there is the exposure of individuals who have no knowledge or control of their exposure. The general population/uncontrolled exposure limits are applicable to situations in which the general public may be exposed or in which persons who are exposed as a consequence of their employment may not be made fully aware of the potential for exposure or cannot exercise control over their exposure. Members of the general public would come under this category when exposure is not employment-related; for example, in the case of a wireless transmitter that exposes persons in its vicinity.

6.2 Controlled Environment

Controlled Environments are defined as locations where there is exposure that may be incurred by persons who are aware of the potential for exposure, (i.e. as a result of employment or occupation). In general, occupational/controlled exposure limits are applicable to situations in which persons are exposed as a consequence of their employment, who have been made fully aware of the potential for exposure and can exercise control over their exposure. The exposure category is also applicable when the exposure is of a transient nature due to incidental passage through a location where the exposure levels may be higher than the general population/uncontrolled limits, but the exposed person is fully aware of the potential for exposure and can exercise control over his or her exposure by leaving the area or by some other appropriate means.

Limits for Occupational/Controlled Exposure (W/kg)

Whole-Body	Partial-Body	Hands, Wrists, Feet and Ankles
0.4	8.0	20.0

Limits for General Population/Uncontrolled Exposure (W/kg)

Whole-Body	Partial-Body	Hands, Wrists, Feet and Ankles
0.08	1.6	4.0

Whole-Body SAR is averaged over the entire body, partial-body SAR is averaged over any 1gram of tissue defined as a tissue volume in the shape of a cube. SAR for hands, wrists, feet and ankles is averaged over any 10 grams of tissue defined as a tissue volume in the shape of a cube.

7. Specific Absorption Rate (SAR)

7.1 Introduction

SAR is related to the rate at which energy is absorbed per unit mass in an object exposed to a radio field. The SAR distribution in a biological body is complicated and is usually carried out by experimental techniques or numerical modeling. The standard recommends limits for two tiers of groups, occupational/controlled and general population/uncontrolled, based on a person's awareness and ability to exercise control over his or her exposure. In general, occupational/controlled exposure limits are higher than the limits for general population/uncontrolled.

7.2 SAR Definition

The SAR definition is the time derivative (rate) of the incremental energy (dW) absorbed by (dissipated in) an incremental mass (dm) contained in a volume element (dv) of a given density (ρ). The equation description is as below:

$$\text{SAR} = \frac{d}{dt} \left(\frac{dW}{dm} \right) = \frac{d}{dt} \left(\frac{dW}{\rho dv} \right)$$

SAR is expressed in units of Watts per kilogram (W/kg)

$$\text{SAR} = \frac{\sigma |E|^2}{\rho}$$

Where: σ is the conductivity of the tissue, ρ is the mass density of the tissue and E is the RMS electrical field strength.

8. System Description and Setup

The DASY system used for performing compliance tests consists of the following items:

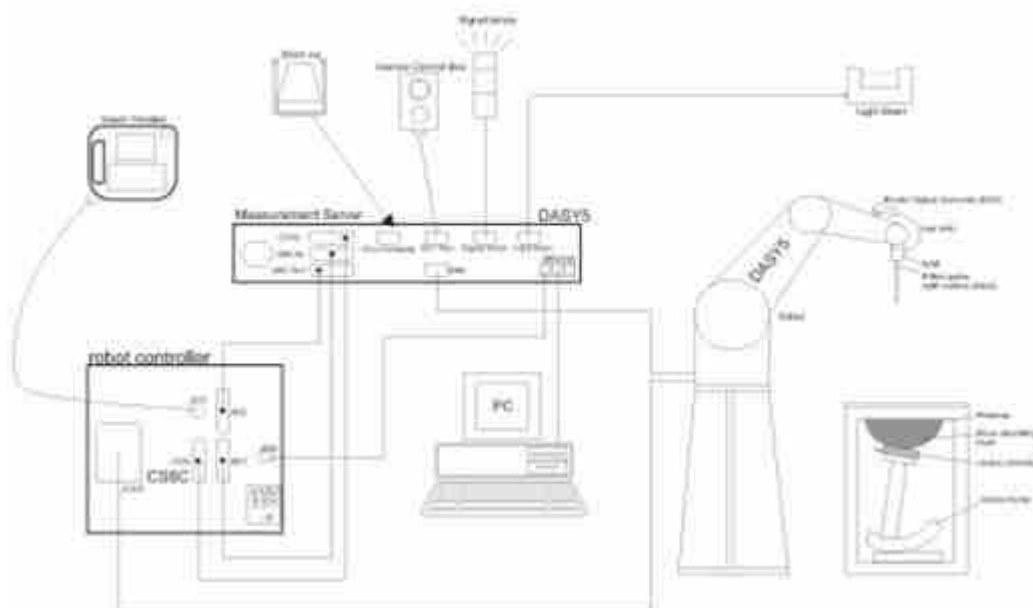

- A standard high precision 6-axis robot with controller, teach pendant and software. An arm extension for accommodating the data acquisition electronics (DAE).
- An isotropic Field probe optimized and calibrated for the targeted measurement.
- A data acquisition electronics (DAE) which performs the signal amplification, signal multiplexing, AD-conversion, offset measurements, mechanical surface detection, collision detection, etc. The unit is battery powered with standard or rechargeable batteries. The signal is optically transmitted to the EOC.
- The Electro-optical converter (EOC) performs the conversion from optical to electrical signals for the digital communication to the DAE. To use optical surface detection, a special version of the EOC is required. The EOC signal is transmitted to the measurement server.
- The function of the measurement server is to perform the time critical tasks such as signal filtering, control of the robot operation and fast movement interrupts.
- The Light Beam used is for probe alignment. This improves the (absolute) accuracy of the probe positioning.
- A computer running WinXP or Win7 and the DASY5 software.
- Remote control and teach pendant as well as additional circuitry for robot safety such as warning lamps, etc.
- The phantom, the device holder and other accessories according to the targeted measurement.

8.1 E-Field Probe

The SAR measurement is conducted with the dosimetric probe (manufactured by SPEAG).The probe is specially designed and calibrated for use in liquid with high permittivity. The dosimetric probe has special calibration in liquid at different frequency. This probe has a built in optical surface detection system to prevent from collision with phantom.

<EX3DV4 Probe>

Construction	Symmetric design with triangular core Built-in shielding against static charges PEEK enclosure material (resistant to organic solvents, e.g., DGBE)	
Frequency	10 MHz – >6 GHz Linearity: ±0.2 dB (30 MHz – 6 GHz)	
Directivity	±0.3 dB in TSL (rotation around probe axis) ±0.5 dB in TSL (rotation normal to probe axis)	
Dynamic Range	10 µW/g – >100 mW/g Linearity: ±0.2 dB (noise: typically <1 µW/g)	
Dimensions	Overall length: 337 mm (tip: 20 mm) Tip diameter: 2.5 mm (body: 12 mm) Typical distance from probe tip to dipole centers: 1 mm	

8.2 Data Acquisition Electronics (DAE)

The data acquisition electronics (DAE) consists of a highly sensitive electrometer-grade preamplifier with auto-zeroing, a channel and gain-switching multiplexer, a fast 16 bit AD-converter and a command decoder and control logic unit. Transmission to the measurement server is accomplished through an optical downlink for data and status information as well as an optical uplink for commands and the clock.

The input impedance of the DAE is 200 MOhm; the inputs are symmetrical and floating. Common mode rejection is above 80 dB.



Photo of DAE

8.3 Phantom

<SAM Twin Phantom>

Shell Thickness	2 ± 0.2 mm; Center ear point: 6 ± 0.2 mm	
Filling Volume	Approx. 25 liters	
Dimensions	Length: 1000 mm; Width: 500 mm; Height: adjustable feet	
Measurement Areas	Left Hand, Right Hand, Flat Phantom	

The bottom plate contains three pair of bolts for locking the device holder. The device holder positions are adjusted to the standard measurement positions in the three sections. A white cover is provided to tap the phantom during off-periods to prevent water evaporation and changes in the liquid parameters. On the phantom top, three reference markers are provided to identify the phantom position with respect to the robot.

<ELI Phantom>

Shell Thickness	2 ± 0.2 mm (sagging: <1%)	
Filling Volume	Approx. 30 liters	
Dimensions	Major ellipse axis: 600 mm Minor axis: 400 mm	

The ELI phantom is intended for compliance testing of handheld and body-mounted wireless devices in the frequency range of 30 MHz to 6 GHz. ELI4 is fully compatible with standard and all known tissue simulating liquids.

8.4 Device Holder

<Mounting Device for Hand-Held Transmitter>

In combination with the Twin SAM V5.0/V5.0c or ELI phantoms, the Mounting Device for Hand-Held Transmitters enables rotation of the mounted transmitter device to specified spherical coordinates. At the heads, the rotation axis is at the ear opening. Transmitter devices can be easily and accurately positioned according to IEC 62209-1, IEEE 1528, FCC, or other specifications. The device holder can be locked for positioning at different phantom sections (left head, right head, flat). And upgrade kit to Mounting Device to enable easy mounting of wider devices like big smart-phones, e-books, small tablets, etc. It holds devices with width up to 140 mm.



Mounting Device for Hand-Held Transmitters



Mounting Device Adaptor for Wide-Phones

<Mounting Device for Laptops and other Body-Worn Transmitters>

The extension is lightweight and made of POM, acrylic glass and foam. It fits easily on the upper part of the mounting device in place of the phone positioned. The extension is fully compatible with the SAM Twin and ELI phantoms.



Mounting Device for Laptops



9. Measurement Procedures

The measurement procedures are as follows:

<Conducted power measurement>

- (a) For WWAN power measurement, use base station simulator to configure EUT WWAN transmission in conducted connection with RF cable, at maximum power in each supported wireless interface and frequency band.
- (b) Read the WWAN RF power level from the base station simulator.
- (c) For WLAN/BT power measurement, use engineering software to configure EUT WLAN/BT continuously transmission, at maximum RF power in each supported wireless interface and frequency band
- (d) Connect EUT RF port through RF cable to the power meter, and measure WLAN/BT output power

<SAR measurement>

- (a) Use base station simulator to configure EUT WWAN transmission in radiated connection, and engineering software to configure EUT WLAN/BT continuously transmission, at maximum RF power, in the highest power channel.
- (b) Place the EUT in the positions as Appendix D demonstrates.
- (c) Set scan area, grid size and other setting on the DASY software.
- (d) Measure SAR results for the highest power channel on each testing position.
- (e) Find out the largest SAR result on these testing positions of each band
- (f) Measure SAR results for other channels in worst SAR testing position if the reported SAR of highest power channel is larger than 0.8 W/kg

According to the test standard, the recommended procedure for assessing the peak spatial-average SAR value consists of the following steps:

- (a) Power reference measurement
- (b) Area scan
- (c) Zoom scan
- (d) Power drift measurement

9.1 Spatial Peak SAR Evaluation

The procedure for spatial peak SAR evaluation has been implemented according to the test standard. It can be conducted for 1g and 10g, as well as for user-specific masses. The DASY software includes all numerical procedures necessary to evaluate the spatial peak SAR value.

The base for the evaluation is a "cube" measurement. The measured volume must include the 1g and 10g cubes with the highest averaged SAR values. For that purpose, the center of the measured volume is aligned to the interpolated peak SAR value of a previously performed area scan.

The entire evaluation of the spatial peak values is performed within the post-processing engine (SEMCAD). The system always gives the maximum values for the 1g and 10g cubes. The algorithm to find the cube with highest averaged SAR is divided into the following stages:

- (a) Extraction of the measured data (grid and values) from the Zoom Scan
- (b) Calculation of the SAR value at every measurement point based on all stored data (A/D values and measurement parameters)
- (c) Generation of a high-resolution mesh within the measured volume
- (d) Interpolation of all measured values from the measurement grid to the high-resolution grid
- (e) Extrapolation of the entire 3-D field distribution to the phantom surface over the distance from sensor to surface
- (f) Calculation of the averaged SAR within masses of 1g and 10g

9.2 Power Reference Measurement

The Power Reference Measurement and Power Drift Measurements are for monitoring the power drift of the device under test in the batch process. The minimum distance of probe sensors to surface determines the closest measurement point to phantom surface. This distance cannot be smaller than the distance of sensor calibration points to probe tip as defined in the probe properties.

9.3 Area Scan

The area scan is used as a fast scan in two dimensions to find the area of high field values, before doing a fine measurement around the hot spot. The sophisticated interpolation routines implemented in DASY software can find the maximum found in the scanned area, within a range of the global maximum. The range (in dB0 is specified in the standards for compliance testing. For example, a 2 dB range is required in IEEE standard 1528 and IEC 62209 standards, whereby 3 dB is a requirement when compliance is assessed in accordance with the ARIB standard (Japan), if only one zoom scan follows the area scan, then only the absolute maximum will be taken as reference. For cases where multiple maximums are detected, the number of zoom scans has to be increased accordingly.

Area scan parameters extracted from FCC KDB 865664 D01v01r04 SAR measurement 100 MHz to 6 GHz.

	$\leq 3 \text{ GHz}$	$> 3 \text{ GHz}$
Maximum distance from closest measurement point (geometric center of probe sensors) to phantom surface	$5 \pm 1 \text{ mm}$	$3.5 \cdot 5 \cdot \ln(2) \pm 0.5 \text{ mm}$
Maximum probe angle from probe axis to phantom surface normal at the measurement location	$30^\circ \pm 1^\circ$	$20^\circ \pm 1^\circ$
Maximum area scan spatial resolution: Δx_{Area} , Δy_{Area}	$\leq 2 \text{ GHz: } \leq 15 \text{ mm}$ $2 - 3 \text{ GHz: } \leq 12 \text{ mm}$	$3 - 4 \text{ GHz: } \leq 12 \text{ mm}$ $4 - 6 \text{ GHz: } \leq 10 \text{ mm}$
	When the x or y dimension of the test device, in the measurement plane orientation, is smaller than the above, the measurement resolution must be \leq the corresponding x or y dimension of the test device with at least one measurement point on the test device.	



9.4 Zoom Scan

Zoom scans are used to assess the peak spatial SAR values within a cubic averaging volume containing 1 gram and 10 gram of simulated tissue. The zoom scan measures points (refer to table below) within a cube whose base faces are centered on the maxima found in a preceding area scan job within the same procedure. When the measurement is done, the zoom scan evaluates the averaged SAR for 1 gram and 10 gram and displays these values next to the job's label.

Zoom scan parameters extracted from FCC KDB 865664 D01v01r04 SAR measurement 100 MHz to 6 GHz.

			≤ 3 GHz	> 3 GHz
Maximum zoom scan spatial resolution: Δx_{Zoom} , Δy_{Zoom}			≤ 2 GHz: ≤ 8 mm $2 - 3$ GHz: ≤ 5 mm*	$3 - 4$ GHz: ≤ 5 mm* $4 - 6$ GHz: ≤ 4 mm*
Maximum zoom scan spatial resolution, normal to phantom surface	uniform grid: $\Delta z_{Zoom}(n)$		≤ 5 mm	$3 - 4$ GHz: ≤ 4 mm $4 - 5$ GHz: ≤ 3 mm $5 - 6$ GHz: ≤ 2 mm
	graded grid	$\Delta z_{Zoom}(1)$: between 1 st two points closest to phantom surface	≤ 4 mm	$3 - 4$ GHz: ≤ 3 mm $4 - 5$ GHz: ≤ 2.5 mm $5 - 6$ GHz: ≤ 2 mm
		$\Delta z_{Zoom}(n>1)$: between subsequent points		$\leq 1.5 \cdot \Delta z_{Zoom}(n-1)$
Minimum zoom scan volume	x, y, z		≥ 30 mm	$3 - 4$ GHz: ≥ 28 mm $4 - 5$ GHz: ≥ 25 mm $5 - 6$ GHz: ≥ 22 mm
Note: δ is the penetration depth of a plane-wave at normal incidence to the tissue medium; see draft standard IEEE P1528-2011 for details. * When zoom scan is required and the <i>reported</i> SAR from the <i>area scan based 1-g SAR estimation</i> procedures of KDB 447498 is ≤ 1.4 W/kg, ≤ 8 mm, ≤ 7 mm and ≤ 5 mm zoom scan resolution may be applied, respectively, for 2 GHz to 3 GHz, 3 GHz to 4 GHz and 4 GHz to 6 GHz.				

9.5 Volume Scan Procedures

The volume scan is used to assess overlapping SAR distributions for antennas transmitting in different frequency bands. It is equivalent to an oversized zoom scan used in standalone measurements. The measurement volume will be used to enclose all the simultaneous transmitting antennas. For antennas transmitting simultaneously in different frequency bands, the volume scan is measured separately in each frequency band. In order to sum correctly to compute the 1g aggregate SAR, the EUT remain in the same test position for all measurements and all volume scan use the same spatial resolution and grid spacing. When all volume scan were completed, the software, SEMCAD postprocessor can combine and subsequently superpose these measurement data to calculating the multiband SAR.

9.6 Power Drift Monitoring

All SAR testing is under the EUT install full charged battery and transmit maximum output power. In DASy measurement software, the power reference measurement and power drift measurement procedures are used for monitoring the power drift of EUT during SAR test. Both these procedures measure the field at a specified reference position before and after the SAR testing. The software will calculate the field difference in dB. If the power drifts more than 5%, the SAR will be retested.



10. Test Equipment List

Manufacturer	Name of Equipment	Type/Model	Serial Number	Calibration	
				Last Cal.	Due Date
SPEAG	750MHz System Validation Kit	D750V3	1087	2019/3/27	2022/3/26
SPEAG	835MHz System Validation Kit	D835V2	4d151	2019/3/27	2022/3/26
SPEAG	1750MHz System Validation Kit	D1750V2	1090	2019/3/27	2022/3/26
SPEAG	1900MHz System Validation Kit	D1900V2	5d170	2019/3/26	2022/3/25
SPEAG	2300MHz System Validation Kit	D2300V2	1055	2018/9/20	2021/9/19
SPEAG	2450MHz System Validation Kit	D2450V2	908	2019/3/25	2022/3/24
SPEAG	5000MHz System Validation Kit	D5GHzV2	1113	2019/9/24	2020/9/23
SPEAG	Data Acquisition Electronics	DAE4	1358	2020/4/28	2021/4/27
SPEAG	Dosimetric E-Field Probe	EX3DV4	3935	2020/5/27	2021/5/26
SPEAG	SAM Twin Phantom	QD 000 P40 CB	TP-1753	NCR	NCR
SPEAG	Phone Positioner	N/A	N/A	NCR	NCR
Anritsu	Radio Communication Analyzer	MT8821C	6201432831	2020/4/14	2021/4/13
Agilent	Wireless Communication Test Set	E5515C	MY52102706	2020/5/19	2021/5/18
Agilent	ENA Series Network Analyzer	E5071C	MY46106933	2020/8/1	2021/7/31
SPEAG	Dielectric Probe Kit	DAK-3.5	1138	2020/5/19	2021/5/18
Anritsu	Vector Signal Generator	MG3710A	6201682672	2020/1/8	2021/1/7
Rohde & Schwarz	Power Meter	NRVD	102081	2020/8/13	2021/8/12
Rohde & Schwarz	Power Sensor	NRV-Z5	100538	2020/8/13	2021/8/12
Rohde & Schwarz	Power Sensor	NRV-Z5	100539	2020/8/13	2021/8/12
R&S	CBT BLUETOOTH TESTER	CBT	101246	2020/4/14	2021/4/13
EXA	Spectrum Analyzer	FSV7	101631	2020/1/8	2021/1/7
Testo	Hygrometer	608-H1	1241332088	2020/1/8	2021/1/7
FLUKE	DIGITAC THERMOMETER	51II	97240029	2020/8/14	2021/8/13
BONN	POWER AMPLIFIER	BLMA 0830-3	087193A	Note	
BONN	POWER AMPLIFIER	BLMA 2060-2	087193B	Note	
ARRA	Power Divider	A3200-2	N/A	Note	
MCL	Attenuation1	BW-S10W5+	N/A	Note	
MCL	Attenuation2	BW-S10W5+	N/A	Note	
MCL	Attenuation3	BW-S10W5+	N/A	Note	
Agilent	Dual Directional Coupler	778D	20500	Note	
Agilent	Dual Directional Coupler	11691D	MY48151020	Note	

Note:

1. Prior to system verification and validation, the path loss from the signal generator to the system check source and the power meter, which includes the amplifier, cable, attenuator and directional coupler, was measured by the network analyzer. The reading of the power meter was offset by the path loss difference between the path to the power meter and the path to the system check source to monitor the actual power level fed to the system check
2. Referring to KDB 865664 D01v01r04, the dipole calibration interval can be extended to 3 years with justification. The dipoles are also not physically damaged, or repaired during the interval.
3. The justification data of dipole can be found in appendix C. The return loss is < -20dB, within 20% of prior calibration, the impedance is within 5 ohm of prior calibration.

11. System Verification

11.1 Tissue Simulating Liquids

For the measurement of the field distribution inside the SAM phantom with DASY, the phantom must be filled with around 25 liters of homogeneous body tissue simulating liquid. For head SAR testing, the liquid height from the ear reference point (ERP) of the phantom to the liquid top surface is larger than 15 cm, which is shown in Fig. 11.1. For body SAR testing, the liquid height from the center of the flat phantom to the liquid top surface is larger than 15 cm, which is shown in Fig. 11.2.



Fig 11.1 Photo of Liquid Height for Head SAR



Fig 11.2 Photo of Liquid Height for Body SAR



11.2 Tissue Verification

The following tissue formulations are provided for reference only as some of the parameters have not been thoroughly verified. The composition of ingredients may be modified accordingly to achieve the desired target tissue parameters required for routine SAR evaluation.

Frequency (MHz)	Water (%)	Sugar (%)	Cellulose (%)	Salt (%)	Preventol (%)	DGBE (%)	Conductivity (σ)	Permittivity (ϵ_r)
For Head								
750	41.1	57.0	0.2	1.4	0.2	0	0.89	41.9
835	40.3	57.9	0.2	1.4	0.2	0	0.90	41.5
1800, 1900, 2000	55.2	0	0	0.3	0	44.5	1.40	40.0
2450	55.0	0	0	0	0	45.0	1.80	39.2

Simulating Liquid for 5GHz, Manufactured by SPEAG

Ingredients	(% by weight)
Water	64~78%
Mineral oil	11~18%
Emulsifiers	9~15%
Additives and Salt	2~3%

<Tissue Dielectric Parameter Check Results>

Frequency (MHz)	Tissue Type	Liquid Temp. (°C)	Conductivity (σ)	Permittivity (ϵ_r)	Conductivity Target (σ)	Permittivity Target (ϵ_r)	Delta (σ) (%)	Delta (ϵ_r) (%)	Limit (%)	Date
750	Head	22.7	0.911	42.231	0.89	41.90	2.36	0.79	±5	2020/8/15
835	Head	22.9	0.915	41.263	0.90	41.50	1.67	-0.57	±5	2020/8/16
1750	Head	22.8	1.383	41.080	1.37	40.10	0.95	2.44	±5	2020/8/18
1900	Head	22.9	1.401	40.146	1.40	40.00	0.07	0.37	±5	2020/8/20
2300	Head	22.8	1.691	39.197	1.67	39.50	1.26	-0.77	±5	2020/8/23
2450	Head	22.8	1.863	38.595	1.80	39.20	3.50	-1.54	±5	2020/8/29
5250	Head	22.7	4.683	35.318	4.71	35.90	-0.57	-1.62	±5	2020/9/11
5600	Head	22.6	5.029	34.778	5.07	35.50	-0.81	-2.03	±5	2020/9/11
5750	Head	22.7	5.190	34.530	5.22	35.40	-0.57	-2.46	±5	2020/9/11

11.3 System Performance Check Results

Comparing to the original SAR value provided by SPEAG, the verification data should be within its specification of 10 %. Below table shows the target SAR and measured SAR after normalized to 1W input power. The table below indicates the system performance check can meet the variation criterion and the plots can be referred to Appendix A of this report.

<1g SAR>

Date	Frequency (MHz)	Tissue Type	Input Power (mW)	Dipole S/N	Probe S/N	DAE S/N	Measured 1g SAR (W/kg)	Targeted 1g SAR (W/kg)	Normalized 1g SAR (W/kg)	Deviation (%)
2020/8/15	750	Head	250	1087	3935	1358	2.18	8.36	8.72	4.31
2020/8/16	835	Head	250	4d151	3935	1358	2.51	9.30	10.04	7.96
2020/8/18	1750	Head	250	1090	3935	1358	9.11	36.40	36.44	0.11
2020/8/20	1900	Head	250	5d170	3935	1358	10.10	39.00	40.4	3.59
2020/8/23	2300	Head	250	1055	3935	1358	12.90	48.70	51.6	5.95
2020/8/29	2450	Head	250	908	3935	1358	13.70	52.80	54.8	3.79
2020/9/11	5250	Head	100	1113	3935	1358	7.34	80.50	73.4	-8.82
2020/9/11	5600	Head	100	1113	3935	1358	8.72	83.40	87.2	4.56
2020/9/11	5750	Head	100	1113	3935	1358	8.20	80.00	82	2.50

<10g SAR>

Date	Frequency (MHz)	Tissue Type	Input Power (mW)	Dipole S/N	Probe S/N	DAE S/N	Measured 10g SAR (W/kg)	Targeted 10g SAR (W/kg)	Normalized 10g SAR (W/kg)	Deviation (%)
2020/8/15	750	Head	250	1087	3935	1358	1.44	5.65	5.76	1.95
2020/8/16	835	Head	250	4d151	3935	1358	1.62	6.16	6.48	5.19
2020/8/18	1750	Head	250	1090	3935	1358	4.87	19.20	19.48	1.46
2020/8/20	1900	Head	250	5d170	3935	1358	5.18	20.30	20.72	2.07
2020/8/23	2300	Head	250	1055	3935	1358	6.35	23.20	25.4	9.48
2020/9/11	5250	Head	100	1113	3935	1358	2.08	23.10	20.8	-9.96
2020/9/11	5600	Head	100	1113	3935	1358	2.52	23.80	25.2	5.88
2020/9/11	5750	Head	100	1113	3935	1358	2.34	22.80	23.4	2.63

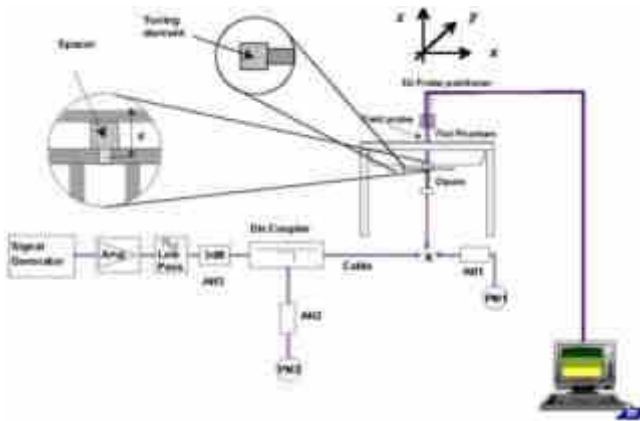

Fig 11.3.1 System Performance Check Setup



Fig 11.3.2 Setup Photo

12. RF Exposure Positions

12.1 Ear and handset reference point

Figure 12.1.1 shows the front, back, and side views of the SAM phantom. The center-of-mouth reference point is labeled “M,” the left ear reference point (ERP) is marked “LE,” and the right ERP is marked “RE.” Each ERP is 15 mm along the B-M (back-mouth) line behind the entrance-to-ear-canal (EEC) point, as shown in Figure 12.1.2 The Reference Plane is defined as passing through the two ear reference points and point M. The line N-F (neck-front), also called the reference pivoting line, is normal to the Reference Plane and perpendicular to both a line passing through RE and LE and the B-M line (see Figure 12.1.3). Both N-F and B-M lines should be marked on the exterior of the phantom shell to facilitate handset positioning. Posterior to the N-F line the ear shape is a flat surface with 6 mm thickness at each ERP, and forward of the N-F line the ear is truncated, as illustrated in Figure 12.1.2. The ear truncation is introduced to preclude the ear lobe from interfering with handset tilt, which could lead to unstable positioning at the cheek.

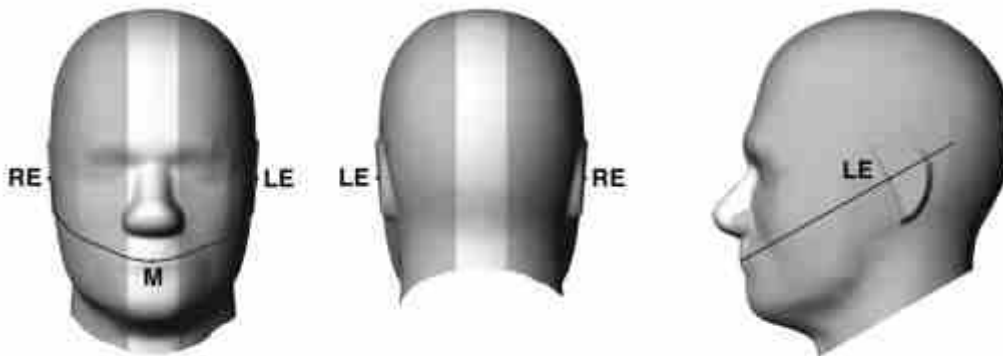

Fig 12.1.1 Front, back, and side views of SAM twin phantom

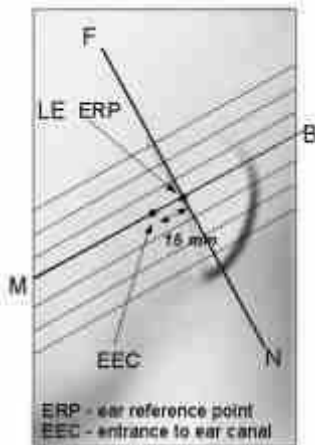

Fig 12.1.2 Close-up side view of phantom showing the ear region.

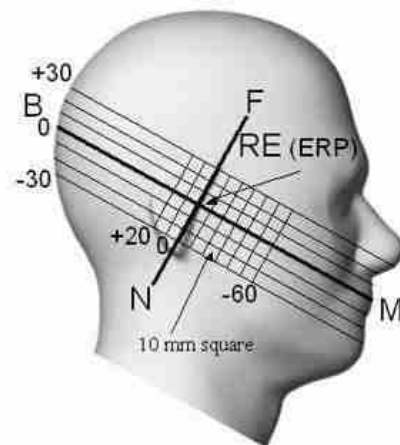

Fig 12.1.3 Side view of the phantom showing relevant markings and seven cross-sectional plane locations

12.2 Definition of the cheek position

1. Ready the handset for talk operation, if necessary. For example, for handsets with a cover piece (flip cover), open the cover. If the handset can transmit with the cover closed, both configurations must be tested.
2. Define two imaginary lines on the handset—the vertical centerline and the horizontal line. The vertical centerline passes through two points on the front side of the handset—the midpoint of the width w_t of the handset at the level of the acoustic output (point A in Figure 12.2.1 and Figure 12.2.2), and the midpoint of the width w_b of the bottom of the handset (point B). The horizontal line is perpendicular to the vertical centerline and passes through the center of the acoustic output (see Figure 12.2.1). The two lines intersect at point A. Note that for many handsets, point A coincides with the center of the acoustic output; however, the acoustic output may be located elsewhere on the horizontal line. Also note that the vertical centerline is not necessarily parallel to the front face of the handset (see Figure 12.2.2), especially for clamshell handsets, handsets with flip covers, and other irregularly-shaped handsets.
3. Position the handset close to the surface of the phantom such that point A is on the (virtual) extension of the line passing through points RE and LE on the phantom (see Figure 12.2.3), such that the plane defined by the vertical centerline and the horizontal line of the handset is approximately parallel to the sagittal plane of the phantom.
4. Translate the handset towards the phantom along the line passing through RE and LE until handset point A touches the pinna at the ERP.
5. While maintaining the handset in this plane, rotate it around the LE-RE line until the vertical centerline is in the plane normal to the plane containing B-M and N-F lines, i.e., the Reference Plane.
6. Rotate the handset around the vertical centerline until the handset (horizontal line) is parallel to the N-F line.
7. While maintaining the vertical centerline in the Reference Plane, keeping point A on the line passing through RE and LE, and maintaining the handset contact with the pinna, rotate the handset about the N-F line until any point on the handset is in contact with a phantom point below the pinna on the cheek. See Figure 12.2.3. The actual rotation angles should be documented in the test report.

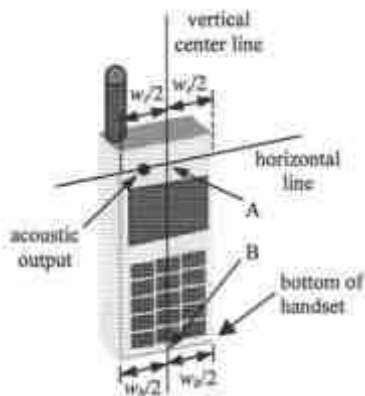

Fig 12.2.1 Handset vertical and horizontal reference lines—“fixed case”

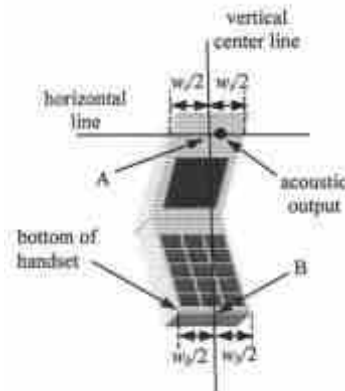

Fig 12.2.2 Handset vertical and horizontal reference lines—“clam-shell case”

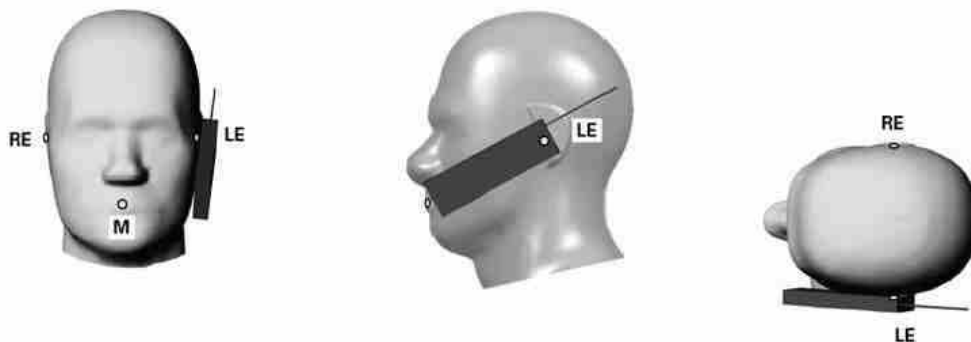

Fig 12.2.3 cheek or touch position. The reference points for the right ear (RE), left ear (LE), and mouth (M), which establish the Reference Plane for handset positioning, are indicated.

12.3 Definition of the tilt position

1. Ready the handset for talk operation, if necessary. For example, for handsets with a cover piece (flip cover), open the cover. If the handset can transmit with the cover closed, both configurations must be tested.
2. While maintaining the orientation of the handset, move the handset away from the pinna along the line passing through RE and LE far enough to allow a rotation of the handset away from the cheek by 15°.
3. Rotate the handset around the horizontal line by 15°.
4. While maintaining the orientation of the handset, move the handset towards the phantom on the line passing through RE and LE until any part of the handset touches the ear. The tilt position is obtained when the contact point is on the pinna. See Figure 12.3.1. If contact occurs at any location other than the pinna, e.g., the antenna at the back of the phantom head, the angle of the handset should be reduced. In this case, the tilt position is obtained if any point on the handset is in contact with the pinna and a second point

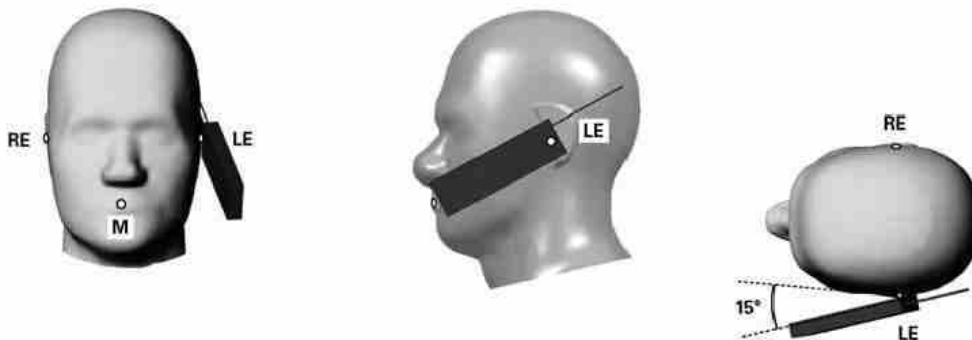

Fig 12.3.1 Tilt position. The reference points for the right ear (RE), left ear (LE), and mouth (M), which define the Reference Plane for handset positioning, are indicated.

12.4 Body Worn Accessory

Body-worn operating configurations are tested with the belt-clips and holsters attached to the device and positioned against a flat phantom in a normal use configuration (see Figure 12.4). Per KDB648474 D04v01r03, body-worn accessory exposure is typically related to voice mode operations when handsets are carried in body-worn accessories. The body-worn accessory procedures in FCC KDB 447498 D01v06 should be used to test for body-worn accessory SAR compliance, without a headset connected to it. This enables the test results for such configuration to be compatible with that required for hotspot mode when the body-worn accessory test separation distance is greater than or equal to that required for hotspot mode, when applicable. When the reported SAR for body-worn accessory, measured without a headset connected to the handset is > 1.2 W/kg, the highest reported SAR configuration for that wireless mode and frequency band should be repeated for that body-worn accessory with a headset attached to the handset.

Accessories for body-worn operation configurations are divided into two categories: those that do not contain metallic components and those that do contain metallic components. When multiple accessories that do not contain metallic components are supplied with the device, the device is tested with only the accessory that dictates the closest spacing to the body. Then multiple accessories that contain metallic components are tested with the device with each accessory. If multiple accessories share an identical metallic component (i.e. the same metallic belt-clip used with different holsters with no other metallic components) only the accessory that dictates the closest spacing to the body is tested.

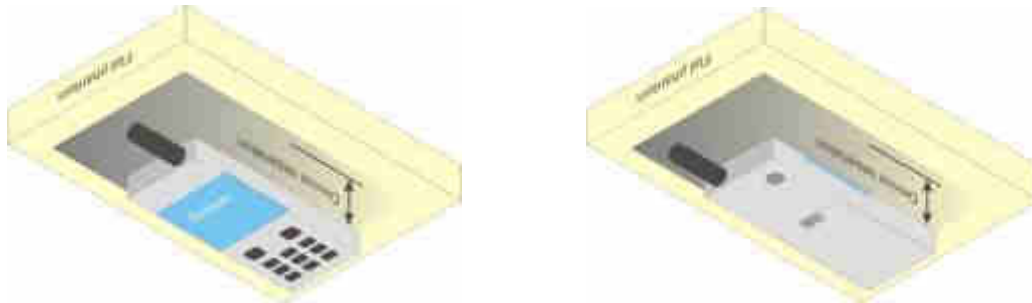

Fig 12.4 Body Worn Position



12.5 Product Specific 10g SAR Exposure

For smart phones with a display diagonal dimension > 15.0 cm or an overall diagonal dimension > 16.0 cm that provide similar mobile web access and multimedia support found in mini-tablets or UMPC mini-tablets that support voice calls next to the ear, According to KDB648474 D04v01r03, the following phablet procedures should be applied to evaluate SAR compliance for each applicable wireless modes and frequency band. Devices marketed as phablets, regardless of form factors and operating characteristics must be tested as a phablet to determine SAR compliance

1. The normally required head and body-worn accessory SAR test procedures for handsets, including hotspot mode, must be applied.
2. The UMPC mini-tablet procedures must also be applied to test the SAR of all surfaces and edges with an antenna located at ≤ 25 mm from that surface or edge, in direct contact with a flat phantom, for 10-g extremity SAR according to the body-equivalent tissue dielectric parameters in KDB 865664 to address interactive hand use exposure conditions.6 The UMPC mini-tablet 1-g SAR at 5 mm is not required. When hotspot mode applies, 10-g extremity SAR is required only for the surfaces and edges with hotspot mode 1-g reported SAR > 1.2 W/kg.

12.6 Wireless Router

Some battery-operated handsets have the capability to transmit and receive user through simultaneous transmission of WIFI simultaneously with a separate licensed transmitter. The FCC has provided guidance in FCC KDB Publication 941225 D06 v02r01 where SAR test considerations for handsets ($L \times W \geq 9$ cm x 5 cm) are based on a composite test separation distance of 10mm from the front, back and edges of the device containing transmitting antennas within 2.5cm of their edges, determined from general mixed use conditions for this type of devices. Since the hotspot SAR results may overlap with the body-worn accessory SAR requirements, the more conservative configurations can be considered, thus excluding some body-worn accessory SAR tests.

When the user enables the personal wireless router functions for the handset, actual operations include simultaneous transmission of both the WIFI transmitter and another licensed transmitter. Both transmitters often do not transmit at the same transmitting frequency and thus cannot be evaluated for SAR under actual use conditions due to the limitations of the SAR assessment probes. Therefore, SAR must be evaluated for each frequency transmission and mode separately and spatially summed with the WIFI transmitter according to FCC KDB Publication 447498 D01v06 publication procedures. The "Portable Hotspot" feature on the handset was NOT activated during SAR assessments, to ensure the SAR measurements were evaluated for a single transmission frequency RF signal at a time.



13. Conducted RF Output Power (Unit: dBm)

The detailed conducted power table can refer to Appendix E.

<GSM Conducted Power>

1. Per KDB 447498 D01v06, the maximum output power channel is used for SAR testing and for further SAR test reduction.
2. Per KDB 941225 D01v03r01, for SAR test reduction for GSM / GPRS / EDGE modes is determined by the source-based time-averaged output power including tune-up tolerance. The mode with highest specified time-averaged output power should be tested for SAR compliance in the applicable exposure conditions. For modes with the same specified maximum output power and tolerance, the higher number time-slot configuration should be tested. Therefore, the GPRS 2Tx slots for GSM850/GSM1900 are considered as the primary mode.
3. Other configurations of GSM / GPRS / EDGE are considered as secondary modes. The 3G SAR test reduction procedure is applied, when the maximum output power and tune-up tolerance specified for production units in a secondary mode is $\leq 1/4$ dB higher than the primary mode, SAR measurement is not required for the secondary mode.

<WCDMA Conducted Power>

1. The following tests were conducted according to the test requirements outlines in 3GPP TS 34.121 specification.
2. The procedures in KDB 941225 D01v03r01 are applied for 3GPP Rel. 6 HSPA to configure the device in the required sub-test mode(s) to determine SAR test exclusion.
3. For DC-HSDPA, the device was configured according to the H-Set 12, Fixed Reference Channel (FRC) configuration in Table C.8.1.12 of 3GPP TS 34.121-1, with the primary and the secondary serving HS-DSCH Cell enabled during the power measurement.

A summary of these settings are illustrated below:

HSDPA Setup Configuration:

- a. The EUT was connected to Base Station Agilent E5515C referred to the Setup Configuration.
- b. The RF path losses were compensated into the measurements.
- c. A call was established between EUT and Base Station with following setting:
 - i. Set Gain Factors (β_c and β_d) and parameters were set according to each
 - ii. Specific sub-test in the following table, C10.1.4, quoted from the TS 34.121
 - iii. Set RMC 12.2Kbps + HSDPA mode.
 - iv. Set Cell Power = -86 dBm
 - v. Set HS-DSCH Configuration Type to FRC (H-set 1, QPSK)
 - vi. Select HSDPA Uplink Parameters
 - vii. Set Delta ACK, Delta NACK and Delta CQI = 8
 - viii. Set Ack-Nack Repetition Factor to 3
 - ix. Set CQI Feedback Cycle (k) to 4 ms
 - x. Set CQI Repetition Factor to 2
 - xi. Power Ctrl Mode = All Up bits
- d. The transmitted maximum output power was recorded.



Table C.10.1.4: β values for transmitter characteristics tests with HS-DPCCH

Sub-test	β_c	β_d	β_d (SF)	β_c/β_d	β_{HS} (Note 1, Note 2)	CM (dB) (Note 3)	MPR (dB) (Note 3)
1	2/15	15/15	64	2/15	4/15	0.0	0.0
2	12/15 (Note 4)	15/15 (Note 4)	64	12/15 (Note 4)	24/15	1.0	0.0
3	15/15	8/15	64	15/8	30/15	1.5	0.5
4	15/15	4/15	64	15/4	30/15	1.5	0.5

Note 1: Δ_{ACK} , Δ_{NACK} and $\Delta_{CQI} = 30/15$ with $\beta_{HS} = 30/15 * \beta_c$.

Note 2: For the HS-DPCCH power mask requirement test in clause 5.2C, 5.7A, and the Error Vector Magnitude (EVM) with HS-DPCCH test in clause 5.13.1A, and HSDPA EVM with phase discontinuity in clause 5.13.1AA, Δ_{ACK} and $\Delta_{NACK} = 30/15$ with $\beta_{HS} = 30/15 * \beta_c$, and $\Delta_{CQI} = 24/15$ with $\beta_{HS} = 24/15 * \beta_c$.

Note 3: CM = 1 for $\beta_c/\beta_d = 12/15$, $\beta_{HS}/\beta_c = 24/15$. For all other combinations of DPDCCH, DPCCH and HS-DPCCH the MPR is based on the relative CM difference. This is applicable for only UEs that support HSDPA in release 6 and later releases.

Note 4: For subtest 2 the β_c/β_d ratio of 12/15 for the TFC during the measurement period (TF1, TF0) is achieved by setting the signalled gain factors for the reference TFC (TF1, TF1) to $\beta_c = 11/15$ and $\beta_d = 15/15$.

Setup Configuration

HSUPA Setup Configuration:

- a. The EUT was connected to Base Station Agilent E5515C referred to the Setup Configuration.
- b. The RF path losses were compensated into the measurements.
- c. A call was established between EUT and Base Station with following setting * :
 - i. Call Configs = 5.2B, 5.9B, 5.10B, and 5.13.2B with QPSK
 - ii. Set the Gain Factors (β_c and β_d) and parameters (AG Index) were set according to each specific sub-test in the following table, C11.1.3, quoted from the TS 34.121
 - iii. Set Cell Power = -86 dBm
 - iv. Set Channel Type = 12.2k + HSPA
 - v. Set UE Target Power
 - vi. Power Ctrl Mode= Alternating bits
 - vii. Set and observe the E-TFCI
 - viii. Confirm that E-TFCCI is equal to the target E-TFCCI of 75 for sub-test 1, and other subtest's E-TFCCI
- d. The transmitted maximum output power was recorded.

Table C.11.1.3: β values for transmitter characteristics tests with HS-DPCCH and E-DCH

Sub-test	β_c	β_d	β_{sf} (SF)	β_c/β_d	β_{HS} (Note1)	β_{ec}	β_{ed} (Note 4) (Note 5)	β_{ed} (SF)	β_{ed} (Codes)	CM (dB) (Note 2)	MPR (dB) (Note 2) (Note 6)	AG Index (Note 5)	E-TFCI
1	11/15 (Note 3)	15/15 (Note 3)	64	11/15 (Note 3)	22/15	209/25	1309/225	4	1	1.0	0.0	20	75
2	6/15	15/15	64	6/15	12/15	12/15	94/75	4	1	3.0	2.0	12	67
3	15/15	9/15	64	15/9	30/15	30/15	β_{ed1} : 47/15 β_{ed2} : 47/15	4	2	2.0	1.0	15	92
4	2/15	15/15	64	2/15	4/15	2/15	56/75	4	1	3.0	2.0	17	71
5	15/15	0	-	-	5/15	5/15	47/15	4	1	1.0	0.0	12	67

Note 1: For sub-test 1 to 4, Δ_{ACK} , Δ_{NACK} and $\Delta_{CDI} = 30/15$ with $\beta_{br} = 30/15 * \beta_c$. For sub-test 5, Δ_{ACK} , Δ_{NACK} and $\Delta_{CDI} = 5/15$ with $\beta_{br} = 5/15 * \beta_c$.

Note 2: CM = 1 for $\beta_c/\beta_d = 12/15$, $\beta_{ed}/\beta_c = 24/15$. For all other combinations of DPDCH, DPCCH, HS-DPCCH, E-DPDCH and E-DPCCH the MPR is based on the relative CM difference.

Note 3: For subtest 1 the β_c/β_d ratio of 11/15 for the TFC during the measurement period (TF1, TF0) is achieved by setting the signalled gain factors for the reference TFC (TF1, TF0) to $\beta_c = 10/15$ and $\beta_d = 15/15$.

Note 4: In case of testing by UE using E-DPDCH Physical Layer category 1, Sub-test 3 is omitted according to TS25.306 Table 5.1g.

Note 5: β_{ed} can not be set directly; it is set by Absolute Grant Value.

Note 6: For subtests 2, 3 and 4, UE may perform E-DPDCH power scaling at max power which could results in slightly smaller MPR values.

Setup Configuration



DC-HSDPA 3GPP release 8 Setup Configuration:

- a. The EUT was connected to Base Station referred to the Setup Configuration below
- b. The RF path losses were compensated into the measurements.
- c. A call was established between EUT and Base Station with following setting:
 - i. Set RMC 12.2Kbps + HSDPA mode.
 - ii. Set Cell Power = -25 dBm
 - iii. Set HS-DSCH Configuration Type to FRC (H-set 12, QPSK)
 - iv. Select HSDPA Uplink Parameters
 - v. Set Gain Factors (β_c and β_d) and parameters were set according to each Specific sub-test in the following table, C10.1.4, quoted from the TS 34.121
 - a). Subtest 1: $\beta_c/\beta_d=2/15$
 - b). Subtest 2: $\beta_c/\beta_d=12/15$
 - c). Subtest 3: $\beta_c/\beta_d=15/8$
 - d). Subtest 4: $\beta_c/\beta_d=15/4$
 - vi. Set Delta ACK, Delta NACK and Delta CQI = 8
 - vii. Set Ack-Nack Repetition Factor to 3
 - viii. Set CQI Feedback Cycle (k) to 4 ms
 - ix. Set CQI Repetition Factor to 2
 - x. Power Ctrl Mode = All Up bits
- d. The transmitted maximum output power was recorded.

The following tests were conducted according to the test requirements outlines in 3GPP TS 34.121 specification. A summary of these settings are illustrated below:

C.8.1.12 Fixed Reference Channel Definition H-Set 12

Table C.8.1.12: Fixed Reference Channel H-Set 12

Parameter	Unit	Value
Nominal Avg. Inf. Bit Rate	kbps	68
Inter-TTI Duration	TTIs	1
Number of HARQ Processes	Proces	8
Information Bit Payload (N_{info})	Bits	120
Number Code Blocks	Blocks	1
Binary Channel Bits Per TTI	Bits	860
Total Available SML's at UE	SML's	19200
Number of SML's per HARQ Proc.	SML's	3200
Coding Rate		0.15
Number of Physical Channel Codes	Codes	1
Modulation		QPSK

Note 1: The RMC is intended to be used for DC-HSDPA mode and both cells shall transmit with identical parameters as listed in the table.
 Note 2: Maximum number of transmission is limited to 1, i.e. retransmission is not allowed. The redundancy and constellation within 0 shall be used.

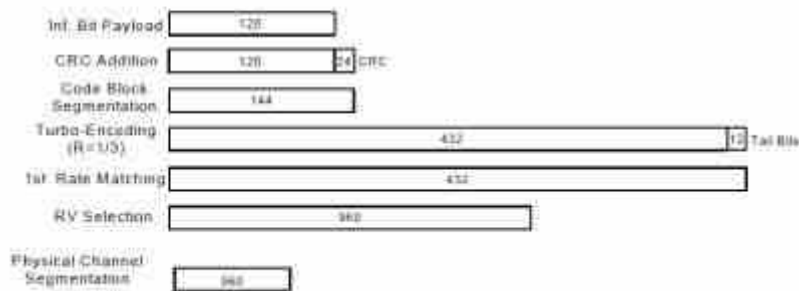

Figure C.8.19: Coding rate for Fixed reference Channel H-Set 12 (QPSK)

Setup Configuration



<WCDMA Conducted Power>

General Note:

1. Per KDB 941225 D01v03r01, for SAR testing is measured using a 12.2 kbps RMC with TPC bits configured to all "1's".
2. Per KDB 941225 D01v03r01, RMC 12.2kbps setting is used to evaluate SAR. The maximum output power and tune-up tolerance specified for production units in HSDPA / HSUPA / DC-HSDPA is $\leq \frac{1}{4}$ dB higher than RMC 12.2Kbps or when the highest reported SAR of the RMC12.2Kbps is scaled by the ratio of specified maximum output power and tune-up tolerance of HSDPA / HSUPA / DC-HSDPA to RMC12.2Kbps and the adjusted SAR is ≤ 1.2 W/kg, SAR measurement is not required for HSDPA / HSUPA / DC-HSDPA, and according to the following RF output power, the output power results of the secondary modes (HSDPA / HSUPA / DC-HSDPA) are less than $\frac{1}{4}$ dB higher than the primary modes; therefore, SAR measurement is not required for HSDPA / HSUPA / DC-HSDPA

<LTE Conducted Power>

General Note:

1. Anritsu MT8820C base station simulator was used to setup the connection with EUT; the frequency band, channel bandwidth, RB allocation configuration, modulation type are set in the base station simulator to configure EUT transmitting at maximum power and at different configurations which are requested to be reported to FCC, for conducted power measurement and SAR testing.
2. Per KDB 941225 D05v02r05, when a properly configured base station simulator is used for the SAR and power measurements, spectrum plots for each RB allocation and offset configuration is not required.
3. Per KDB 941225 D05v02r05, start with the largest channel bandwidth and measure SAR for QPSK with 1 RB allocation, using the RB offset and required test channel combination with the highest maximum output power for RB offsets at the upper edge, middle and lower edge of each required test channel.
4. Per KDB 941225 D05v02r05, 50% RB allocation for QPSK SAR testing follows 1RB QPSK allocation procedure.
5. Per KDB 941225 D05v02r05, for QPSK with 100% RB allocation, SAR is not required when the highest maximum output power for 100 % RB allocation is less than the highest maximum output power in 50% and 1 RB allocations and the highest reported SAR for 1 RB and 50% RB allocation are ≤ 0.8 W/kg. Otherwise, SAR is measured for the highest output power channel; and if the reported SAR is > 1.45 W/kg, the remaining required test channels must also be tested.
6. Per KDB 941225 D05v02r05, 16QAM/64QAM output power for each RB allocation configuration is $>$ not $\frac{1}{2}$ dB higher than the same configuration in QPSK and the reported SAR for the QPSK configuration is ≤ 1.45 W/kg; Per KDB 941225 D05v02r05, 16QAM/64QAM SAR testing is not required.
7. Per KDB 941225 D05v02r05, smaller bandwidth output power for each RB allocation configuration is $>$ not $\frac{1}{2}$ dB higher than the same configuration in the largest supported bandwidth, and the reported SAR for the largest supported bandwidth is ≤ 1.45 W/kg; Per KDB 941225 D05v02r05, smaller bandwidth SAR testing is not required.
8. For LTE B4 / B5 / B12 the maximum bandwidth does not support three non-overlapping channels, per KDB 941225 D05v02r05, when a device supports overlapping channel assignment in a channel bandwidth configuration, the middle channel of the group of overlapping channels should be selected for testing.
9. LTE B4 SAR test was covered by B66; according to April 2015 TCB workshop, SAR test for overlapping LTE bands can be reduced if
 - a. the maximum output power, including tolerance, for the smaller band is \leq the larger band to qualify for the SAR test exclusion
 - b. the channel bandwidth and other operating parameters for the smaller band are fully supported by the larger band
10. According to 2017 TCB workshop, for 64 QAM and 16 QAM should be verified by checking the signal constellation with a call box to avoid incorrect maximum power levels due to MPR and other requirements associated with signal modulation, and the following figure is taken from the "Fundamental Measurement >> Modulation Analysis >> constellation" mode of the device connect to the MT8821C base station, therefore, the device 64QAM and 16QAM signal modulation are correct.

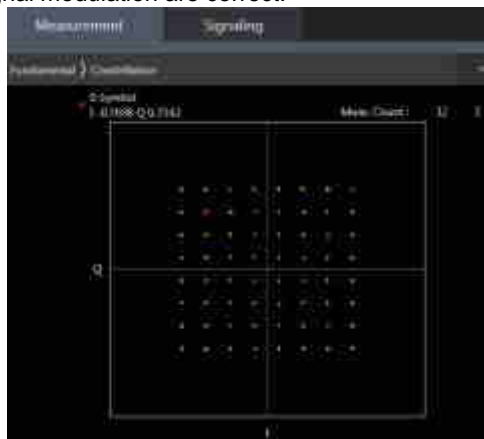

64QAM



16QAM

**<WLAN Conducted Power>****General Note:**

1. Per KDB 248227 D01v02r02, SAR test reduction is determined according to 802.11 transmission mode configurations and certain exposure conditions with multiple test positions. In the 2.4 GHz band, separate SAR procedures are applied to DSSS and OFDM configurations to simplify DSSS test requirements. For OFDM, in both 2.4 and 5 GHz bands, an initial test configuration must be determined for each standalone and aggregated frequency band, according to the transmission mode configuration with the highest maximum output power specified for production units to perform SAR measurements. If the same highest maximum output power applies to different combinations of channel bandwidths, modulations and data rates, additional procedures are applied to determine which test configurations require SAR measurement. When applicable, an initial test position may be applied to reduce the number of SAR measurements required for next to the ear, UMPC mini-tablet or hotspot mode configurations with multiple test positions.
2. For 2.4 GHz 802.11b DSSS, either the initial test position procedure for multiple exposure test positions or the DSSS procedure for fixed exposure position is applied; these are mutually exclusive. For 2.4 GHz and 5 GHz OFDM configurations, the initial test configuration is applied to measure SAR using either the initial test position procedure for multiple exposure test position configurations or the initial test configuration procedures for fixed exposure test conditions. Based on the reported SAR of the measured configurations and maximum output power of the transmission mode configurations that are not included in the initial test configuration, the subsequent test configuration and initial test position procedures are applied to determine if SAR measurements are required for the remaining OFDM transmission configurations. In general, the number of test channels that require SAR measurement is minimized based on maximum output power measured for the test sample(s).
3. For OFDM transmission configurations in the 2.4 GHz and 5 GHz bands, When the same maximum power is specified for multiple transmission modes in a frequency band, the largest channel bandwidth, lowest order modulation, lowest data rate and lowest order 802.11a/g/n/ac mode is used for SAR measurement, on the highest measured output power channel for each frequency band.
4. DSSS and OFDM configurations are considered separately according to the required SAR procedures. SAR is measured in the initial test position using the 802.11 transmission mode configuration required by the DSSS procedure or initial test configuration and subsequent test configuration(s) according to the OFDM procedures.18 The initial test position procedure is described in the following:
 - a. When the reported SAR of the initial test position is ≤ 0.4 W/kg, further SAR measurement is not required for the other test positions in that exposure configuration and 802.11 transmission mode combinations within the frequency band or aggregated band.
 - b. When the reported SAR of the test position is > 0.4 W/kg, SAR is repeated for the 802.11 transmission mode configuration tested in the initial test position to measure the subsequent next closet/smallest test separation distance and maximum coupling test position on the highest maximum output power channel, until the report SAR is ≤ 0.8 W/kg or all required test position are tested.
 - c. For all positions/configurations, when the reported SAR is > 0.8 W/kg, SAR is measured for these test positions/configurations on the subsequent next highest measured output power channel(s) until the reported SAR is ≤ 1.2 W/kg or all required channels are tested.



<2.4GHz Bluetooth>

General Note:

1. For 2.4GHz Bluetooth SAR testing was selected 1Mbps, due to its highest average power.
2. The Bluetooth duty cycle is 76.84 % as following figure, according to 2016 Oct. TCB workshop for Bluetooth SAR scaling need further consideration and the theoretical duty cycle is 83.3%, therefore the actual duty cycle will be scaled up to the theoretical value of Bluetooth reported SAR calculation

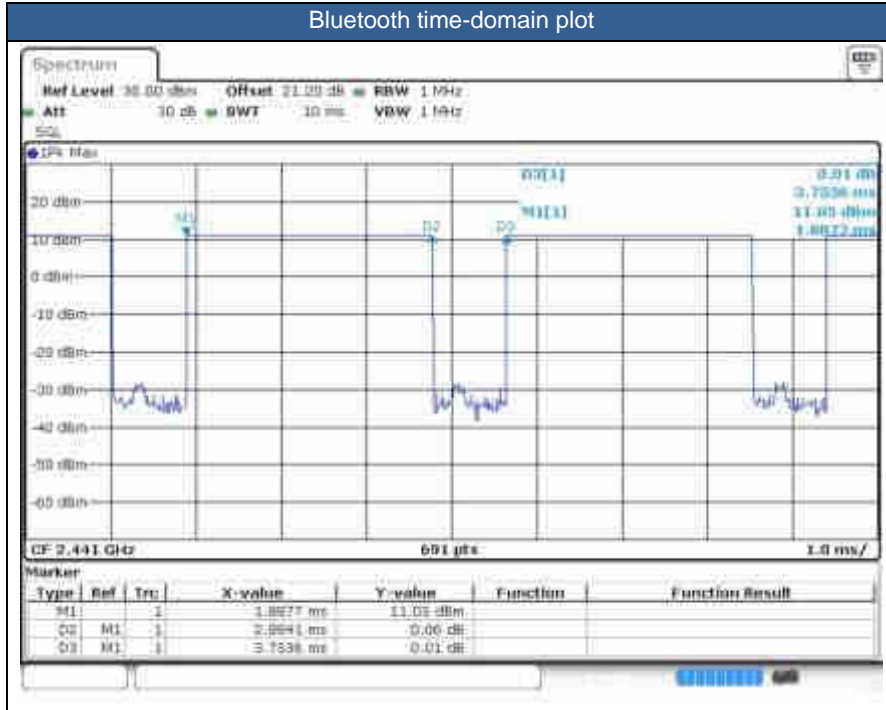



14. Antenna Location

The detailed antenna location information can refer to SAR Test Setup Photos.



15. SAR Test Results

General Note:

1. Per KDB 447498 D01v06, the reported SAR is the measured SAR value adjusted for maximum tune-up tolerance.
 - a. Tune-up scaling Factor = tune-up limit power (mW) / EUT RF power (mW), where tune-up limit is the maximum rated power among all production units.
 - b. For SAR testing of WLAN signal with non-100% duty cycle, the measured SAR is scaled-up by the duty cycle scaling factor which is equal to "1/(duty cycle)"
 - c. For WWAN: Reported SAR(W/kg)= Measured SAR(W/kg)*Tune-up Scaling Factor
 - d. For BT/WLAN: Reported SAR(W/kg)= Measured SAR(W/kg)* Duty Cycle scaling factor * Tune-up scaling factor
2. Per KDB 447498 D01v06, for each exposure position, testing of other required channels within the operating mode of a frequency band is not required when the *reported* 1-g or 10-g SAR for the mid-band or highest output power channel is:
 - ≤ 0.8 W/kg or 2.0 W/kg, for 1-g or 10-g respectively, when the transmission band is ≤ 100 MHz
 - ≤ 0.6 W/kg or 1.5 W/kg, for 1-g or 10-g respectively, when the transmission band is between 100 MHz and 200 MHz
 - ≤ 0.4 W/kg or 1.0 W/kg, for 1-g or 10-g respectively, when the transmission band is ≥ 200 MHz
3. Per KDB 865664 D01v01r04, for each frequency band, repeated SAR measurement is required when the measured SAR is ≥ 0.8 W/kg. Per KDB 865664 D01v01r04, if the extremity repeated SAR is necessary, the same procedures should be adapted for measurements according to extremity and occupational exposure limits by applying a factor of 2.5 for extremity exposure and a factor of 5 for occupational exposure to the corresponding SAR thresholds.
4. Per KDB648474 D04v01r03, when the reported SAR for a body-worn accessory, measured without a headset connected to the handset, is > 1.2 W/kg, the highest reported SAR configuration for that wireless mode and frequency band should be repeated for that body-worn accessory with a headset attached to the handset. When headset SAR is less than or equal than without headset SAR, no need to verify the remaining channels for headset SAR.
5. The device implements Proximity sensors/receiver detect mechanism/hotspot trigger reduced power for the power management for SAR compliance at different exposure conditions (head, body-worn, hotspot, extremity).
6. The device will invoke corresponding work scenarios power level, which are provided in the operational description.
7. For Some WWAN bands, sensor on reduced power level higher than hotspot reduced power level, so front/back sensor on SAR can represent hotspot conservatively.
8. When handheld state, when WWAN transmit simultaneous with WLAN/Bluetooth, for WLAN5.2GHz/5.3GHz/5.5GHz /5.8GHz, product specific 10g SAR condition reduced powers will be active for back side. Other faces full power can be tested pass, so reduced power no need to be evaluated.
9. This device has two WWAN transmitter antennas. WWAN antenna 1 is located at the right of bottom edge of the device and WWAN antenna 2 is located at the left side of bottom edge of the device which can refer to antenna location chapter. WWAN antenna 1 frequency bands include GSM850/1900, WCDMA Band II/IV/V and LTE Band 2/4/5/12/14/66, WWAN antenna 2 frequency band include LTE Band 30.
10. Per KDB648474 D04v01r03, for smart phones with a display diagonal dimension > 15.0 cm or an overall diagonal dimension > 16.0 cm, when hotspot mode applies, 10-g extremity SAR is required only for the surfaces and edges with hotspot mode 1-g reported SAR > 1.2 W/kg, however, when power reduction applies to hotspot mode the measured SAR must be scaled to the maximum output power (for handheld on state, the maximum full power means reduced power), including tolerance, allowed for phablet modes to compare with the 1.2 W/kg SAR test reduction threshold.
 - a. For this device SAR for WWAN/WLAN transmitter scaled to maximum output power mode for product specific 10g SAR is higher than 1.2W/kg of GSM850/GSM1900, WCDMA Band II/IV/V, LTE Band 2/4/5/14/30/66, and WLAN 5.2/5.8GHz therefore product specific 10g SAR is necessary.
 - b. WLAN 5.3/5.5GHz tested the product specific 10g SAR since it has no hotspot mode.
 - c. When 10-g product specific 10g SAR is considered, SAR thresholds is specified in the procedures for SAR test reduction and exclusion should be multiplied by 2.5.
11. For verification of compliance of power reduction scheme, additional SAR testing with EUT transmitting at full RF power at a conservative trigger distance was performed for body worn:
Front: [20 mm](#)
Back: [23 mm](#)
12. For verification of compliance of power reduction scheme, additional SAR testing with EUT transmitting at full RF power at a conservative trigger distance was performed for handheld:
For antenna 2
Front: [7 mm](#)
Back: [6 mm](#)
Bottom side: [9 mm](#)
Left side: [10 mm](#)

For antenna 1
Front: [8 mm](#)



Back: [8 mm](#)
Bottom side: [13 mm](#)

GSM Note:

1. Per KDB 941225 D01v03r01, for SAR test reduction for GSM / GPRS / EDGE modes is determined by the source-based time-averaged output power including tune-up tolerance. The mode with highest specified time-averaged output power should be tested for SAR compliance in the applicable exposure conditions. For modes with the same specified maximum output power and tolerance, the higher number time-slot configuration should be tested. Therefore, the GPRS 2Tx slots for GSM850/GSM1900 are considered as the primary mode.
2. Other configurations of GSM / GPRS / EDGE are considered as secondary modes. The 3G SAR test reduction procedure is applied, when the maximum output power and tune-up tolerance specified for production units in a secondary mode is \leq $\frac{1}{4}$ dB higher than the primary mode, SAR measurement is not required for the secondary mode.

WCDMA Note:

1. Per KDB 941225 D01v03r01, for SAR testing is measured using a 12.2 kbps RMC with TPC bits configured to all "1's".
2. Per KDB 941225 D01v03r01, RMC 12.2kbps setting is used to evaluate SAR. The maximum output power and tune-up tolerance specified for production units in HSDPA / HSUPA / DC-HSDPA is \leq $\frac{1}{4}$ dB higher than RMC 12.2Kbps or when the highest reported SAR of the RMC12.2Kbps is scaled by the ratio of specified maximum output power and tune-up tolerance of HSDPA / HSUPA / DC-HSDPA to RMC12.2Kbps and the adjusted SAR is \leq 1.2 W/kg, SAR measurement is not required for HSDPA / HSUPA / DC-HSDPA, and according to the following RF output power, the output power results of the secondary modes (HSDPA / HSUPA / DC-HSDPA) are less than $\frac{1}{4}$ dB higher than the primary modes; therefore, SAR measurement is not required for HSDPA / HSUPA / DC-HSDPA.

LTE Note:

1. Per KDB 941225 D05v02r05, start with the largest channel bandwidth and measure SAR for QPSK with 1 RB allocation, using the RB offset and required test channel combination with the highest maximum output power for RB offsets at the upper edge, middle and lower edge of each required test channel.
2. Per KDB 941225 D05v02r05, 50% RB allocation for QPSK SAR testing follows 1RB QPSK allocation procedure.
3. Per KDB 941225 D05v02r05, for QPSK with 100% RB allocation, SAR is not required when the highest maximum output power for 100 % RB allocation is less than the highest maximum output power in 50% and 1 RB allocations and the highest reported SAR for 1 RB and 50% RB allocation are \leq 0.8 W/kg. Otherwise, SAR is measured for the highest output power channel; and if the reported SAR is $>$ 1.45 W/kg, the remaining required test channels must also be tested.
4. Per KDB 941225 D05v02r05, 16QAM/64QAM output power for each RB allocation configuration is $>$ not $\frac{1}{2}$ dB higher than the same configuration in QPSK and the reported SAR for the QPSK configuration is \leq 1.45 W/kg; Per KDB 941225 D05v02r05, 16QAM/64QAM SAR testing is not required.
5. Per KDB 941225 D05v02r05, smaller bandwidth output power for each RB allocation configuration is $>$ not $\frac{1}{2}$ dB higher than the same configuration in the largest supported bandwidth, and the reported SAR for the largest supported bandwidth is \leq 1.45 W/kg; Per KDB 941225 D05v02r05, smaller bandwidth SAR testing is not required.
6. This device supports HPUE for LTE band 41 with class 2 level, so HPUE SAR has been performed.
7. For LTE B4 / B5 / B12 the maximum bandwidth does not support three non-overlapping channels, per KDB 941225 D05v02r05, when a device supports overlapping channel assignment in a channel bandwidth configuration, the middle channel of the group of overlapping channels should be selected for testing.
8. LTE B4 SAR test was covered by LTE B66; according to April 2015 TCB workshop, SAR test for overlapping LTE bands can be reduced if
 - a. the maximum output power, including tolerance, for the smaller band is \leq the larger band to qualify for the SAR test exclusion
 - b. the channel bandwidth and other operating parameters for the smaller band are fully supported by the larger band



WLAN/Bluetooth Note:

1. Per KDB 248227 D01v02r02, for 2.4GHz 802.11g/n SAR testing is not required when the highest reported SAR for DSSS is adjusted by the ratio of OFDM to DSSS specified maximum output power and the adjusted SAR is ≤ 1.2 W/kg.
2. Per KDB 248227 D01v02r02, U-NII-1 SAR testing is not required when the U-NII-2A band highest reported SAR for a test configuration is ≤ 1.2 W/kg, SAR is not required for U-NII-1 band.
3. When the reported SAR of the test position is > 0.4 W/kg, SAR is repeated for the 802.11 transmission mode configuration tested in the initial test position to measure the subsequent next closet/smallest test separation distance and maximum coupling test position on the highest maximum output power channel, until the report SAR is ≤ 0.8 W/kg or all required test position are tested.
4. For all positions / configurations, when the reported SAR is > 0.8 W/kg, SAR is measured for these test positions / configurations on the subsequent next highest measured output power channel(s) until the reported SAR is ≤ 1.2 W/kg or all required channels are tested.
5. During SAR testing the WLAN transmission was verified using a spectrum analyzer.
6. Based on WLAN 2.4GHz and Bluetooth share the same antenna, so Bluetooth RF exposure evaluation chose the worst position of WLAN 2.4GHz Ant to perform Bluetooth SAR test, and used this Bluetooth SAR value conservatively represent other position do co-located analysis with WWAN.



15.1 Head SAR

<GSM SAR>

Plot No.	Band	Mode	Test Position	Power Reduction	Ch.	Freq. (MHz)	Average Power (dBm)	Tune-Up Limit (dBm)	Tune-up Scaling Factor	Power Drift (dB)	Measured 1g SAR (W/kg)	Reported 1g SAR (W/kg)
01	GSM850	GPRS 2 Tx slots	Right Cheek	Full Power	189	836.4	29.11	30.50	1.377	0.01	0.354	0.488
	GSM850	GPRS 2 Tx slots	Right Tilted	Full Power	189	836.4	29.11	30.50	1.377	0.05	0.150	0.207
	GSM850	GPRS 2 Tx slots	Left Cheek	Full Power	189	836.4	29.11	30.50	1.377	0.01	0.191	0.263
	GSM850	GPRS 2 Tx slots	Left Tilted	Full Power	189	836.4	29.11	30.50	1.377	0.09	0.139	0.191
02	GSM1900	GPRS 2 Tx slots	Right Cheek	Full Power	661	1880	26.35	27.50	1.303	-0.01	0.039	0.051
	GSM1900	GPRS 2 Tx slots	Right Tilted	Full Power	661	1880	26.35	27.50	1.303	0.02	0.011	0.014
	GSM1900	GPRS 2 Tx slots	Left Cheek	Full Power	661	1880	26.35	27.50	1.303	-0.01	0.025	0.032
	GSM1900	GPRS 2 Tx slots	Left Tilted	Full Power	661	1880	26.35	27.50	1.303	0.03	0.017	0.022

<WCDMA SAR>

Plot No.	Band	Mode	Test Position	Power Reduction	Ch.	Freq. (MHz)	Average Power (dBm)	Tune-Up Limit (dBm)	Tune-up Scaling Factor	Power Drift (dB)	Measured 1g SAR (W/kg)	Reported 1g SAR (W/kg)
03	WCDMA II	RMC 12.2Kbps	Right Cheek	Full Power	9400	1880	23.05	24.00	1.245	-0.01	0.179	0.223
	WCDMA II	RMC 12.2Kbps	Right Tilted	Full Power	9400	1880	23.05	24.00	1.245	0.04	0.068	0.085
	WCDMA II	RMC 12.2Kbps	Left Cheek	Full Power	9400	1880	23.05	24.00	1.245	-0.02	0.075	0.093
	WCDMA II	RMC 12.2Kbps	Left Tilted	Full Power	9400	1880	23.05	24.00	1.245	0.05	0.058	0.072
	WCDMA IV	RMC 12.2Kbps	Right Cheek	Full Power	1413	1732.6	23.23	24.00	1.194	0.06	0.109	0.130
	WCDMA IV	RMC 12.2Kbps	Right Tilted	Full Power	1413	1732.6	23.23	24.00	1.194	0.03	0.080	0.096
04	WCDMA IV	RMC 12.2Kbps	Left Cheek	Full Power	1413	1732.6	23.23	24.00	1.194	0.16	0.177	0.211
	WCDMA IV	RMC 12.2Kbps	Left Tilted	Full Power	1413	1732.6	23.23	24.00	1.194	-0.02	0.073	0.087
05	WCDMA V	RMC 12.2Kbps	Right Cheek	Full Power	4182	836.4	23.29	24.00	1.178	-0.1	0.546	0.643
	WCDMA V	RMC 12.2Kbps	Right Tilted	Full Power	4182	836.4	23.29	24.00	1.178	0.02	0.259	0.305
	WCDMA V	RMC 12.2Kbps	Left Cheek	Full Power	4182	836.4	23.29	24.00	1.178	0.04	0.344	0.405
	WCDMA V	RMC 12.2Kbps	Left Tilted	Full Power	4182	836.4	23.29	24.00	1.178	0.07	0.237	0.279



<FDD LTE SAR>

Plot No.	Band	BW (MHz)	Modulation	RB Size	RB offset	Test Position	Power Reduction	Ch.	Freq. (MHz)	Average Power (dBm)	Tune-Up Limit (dBm)	Tune-up Scaling Factor	Power Drift (dB)	Measured 1g SAR (W/kg)	Reported 1g SAR (W/kg)
06	LTE Band 2	20M	QPSK	1	0	Right Cheek	Full Power	18900	1880	23.27	24.00	1.183	0.03	0.110	0.130
	LTE Band 2	20M	QPSK	50	0	Right Cheek	Full Power	18900	1880	22.43	23.00	1.140	0.05	0.068	0.078
	LTE Band 2	20M	QPSK	1	0	Right Tilted	Full Power	18900	1880	23.27	24.00	1.183	0.03	0.060	0.071
	LTE Band 2	20M	QPSK	50	0	Right Tilted	Full Power	18900	1880	22.43	23.00	1.140	0.04	0.032	0.036
	LTE Band 2	20M	QPSK	1	0	Left Cheek	Full Power	18900	1880	23.27	24.00	1.183	-0.02	0.059	0.070
	LTE Band 2	20M	QPSK	50	0	Left Cheek	Full Power	18900	1880	22.43	23.00	1.140	0.03	0.028	0.032
	LTE Band 2	20M	QPSK	1	0	Left Tilted	Full Power	18900	1880	23.27	24.00	1.183	-0.01	0.080	0.095
	LTE Band 2	20M	QPSK	50	0	Left Tilted	Full Power	18900	1880	22.43	23.00	1.140	-0.12	0.042	0.048
07	LTE Band 5	10M	QPSK	1	0	Right Cheek	Full Power	20525	836.5	23.24	24.00	1.191	-0.06	0.381	0.454
	LTE Band 5	10M	QPSK	25	0	Right Cheek	Full Power	20525	836.5	22.51	23.00	1.119	0.13	0.209	0.234
	LTE Band 5	10M	QPSK	1	0	Right Tilted	Full Power	20525	836.5	23.24	24.00	1.191	0.01	0.222	0.264
	LTE Band 5	10M	QPSK	25	0	Right Tilted	Full Power	20525	836.5	22.51	23.00	1.119	0.02	0.125	0.140
	LTE Band 5	10M	QPSK	1	0	Left Cheek	Full Power	20525	836.5	23.24	24.00	1.191	0.08	0.303	0.361
	LTE Band 5	10M	QPSK	25	0	Left Cheek	Full Power	20525	836.5	22.51	23.00	1.119	-0.05	0.150	0.168
	LTE Band 5	10M	QPSK	1	0	Left Tilted	Full Power	20525	836.5	23.24	24.00	1.191	0.04	0.198	0.236
	LTE Band 5	10M	QPSK	25	0	Left Tilted	Full Power	20525	836.5	22.51	23.00	1.119	0.03	0.091	0.102
08	LTE Band 12	10M	QPSK	1	0	Right Cheek	Full Power	23095	707.5	23.18	24.00	1.208	0.01	0.363	0.438
	LTE Band 12	10M	QPSK	25	0	Right Cheek	Full Power	23095	707.5	22.16	23.00	1.213	0.07	0.167	0.203
	LTE Band 12	10M	QPSK	1	0	Right Tilted	Full Power	23095	707.5	23.18	24.00	1.208	-0.07	0.191	0.231
	LTE Band 12	10M	QPSK	25	0	Right Tilted	Full Power	23095	707.5	22.16	23.00	1.213	0.05	0.099	0.120
	LTE Band 12	10M	QPSK	1	0	Left Cheek	Full Power	23095	707.5	23.18	24.00	1.208	0.14	0.266	0.321
	LTE Band 12	10M	QPSK	25	0	Left Cheek	Full Power	23095	707.5	22.16	23.00	1.213	-0.07	0.140	0.170
	LTE Band 12	10M	QPSK	1	0	Left Tilted	Full Power	23095	707.5	23.18	24.00	1.208	0.05	0.153	0.185
	LTE Band 12	10M	QPSK	25	0	Left Tilted	Full Power	23095	707.5	22.16	23.00	1.213	0.03	0.081	0.098
09	LTE Band 14	10M	QPSK	1	0	Right Cheek	Full Power	23330	793	23.25	24.00	1.189	-0.18	0.400	0.475
	LTE Band 14	10M	QPSK	25	0	Right Cheek	Full Power	23330	793	22.53	23.00	1.114	0.03	0.203	0.226
	LTE Band 14	10M	QPSK	1	0	Right Tilted	Full Power	23330	793	23.25	24.00	1.189	0.01	0.210	0.250
	LTE Band 14	10M	QPSK	25	0	Right Tilted	Full Power	23330	793	22.53	23.00	1.114	-0.08	0.128	0.143
	LTE Band 14	10M	QPSK	1	0	Left Cheek	Full Power	23330	793	23.25	24.00	1.189	0.02	0.263	0.313
	LTE Band 14	10M	QPSK	25	0	Left Cheek	Full Power	23330	793	22.53	23.00	1.114	0.06	0.148	0.165
	LTE Band 14	10M	QPSK	1	0	Left Tilted	Full Power	23330	793	23.25	24.00	1.189	0.01	0.167	0.198
	LTE Band 14	10M	QPSK	25	0	Left Tilted	Full Power	23330	793	22.53	23.00	1.114	0.05	0.100	0.111
	LTE Band 30	10M	QPSK	1	0	Right Cheek	Full Power	27710	2310	23.24	24.00	1.191	-0.05	0.285	0.340
	LTE Band 30	10M	QPSK	25	0	Right Cheek	Full Power	27710	2310	22.53	23.00	1.114	0.04	0.174	0.194
	LTE Band 30	10M	QPSK	1	0	Right Tilted	Full Power	27710	2310	23.24	24.00	1.191	0.01	0.222	0.264
	LTE Band 30	10M	QPSK	25	0	Right Tilted	Full Power	27710	2310	22.53	23.00	1.114	0.12	0.139	0.155
10	LTE Band 30	10M	QPSK	1	0	Left Cheek	Full Power	27710	2310	23.24	24.00	1.191	-0.18	0.497	0.592
	LTE Band 30	10M	QPSK	25	0	Left Cheek	Full Power	27710	2310	22.53	23.00	1.114	-0.04	0.245	0.273
	LTE Band 30	10M	QPSK	1	0	Left Tilted	Full Power	27710	2310	23.24	24.00	1.191	0.02	0.136	0.162
	LTE Band 30	10M	QPSK	25	0	Left Tilted	Full Power	27710	2310	22.53	23.00	1.114	0.06	0.076	0.085
	LTE Band 66	20M	QPSK	1	0	Right Cheek	Full Power	132322	1745	23.36	24.00	1.159	0.02	0.120	0.139
	LTE Band 66	20M	QPSK	50	0	Right Cheek	Full Power	132322	1745	22.30	23.00	1.175	-0.06	0.066	0.078
	LTE Band 66	20M	QPSK	1	0	Right Tilted	Full Power	132322	1745	23.36	24.00	1.159	0.02	0.090	0.104
	LTE Band 66	20M	QPSK	50	0	Right Tilted	Full Power	132322	1745	22.30	23.00	1.175	0.06	0.052	0.061
11	LTE Band 66	20M	QPSK	1	0	Left Cheek	Full Power	132322	1745	23.36	24.00	1.159	0.08	0.149	0.173
	LTE Band 66	20M	QPSK	50	0	Left Cheek	Full Power	132322	1745	22.30	23.00	1.175	-0.07	0.077	0.090
	LTE Band 66	20M	QPSK	1	0	Left Tilted	Full Power	132322	1745	23.36	24.00	1.159	0.03	0.123	0.143
	LTE Band 66	20M	QPSK	50	0	Left Tilted	Full Power	132322	1745	22.30	23.00	1.175	-0.02	0.078	0.092



<WLAN2.4G SAR>

Plot No.	Band	Mode	Test Position	Power Reduction	Ch.	Freq. (MHz)	Average Power (dBm)	Tune-Up Limit (dBm)	Tune-up Scaling Factor	Duty Cycle %	Duty Cycle Scaling Factor	Power Drift (dB)	Measured 1g SAR (W/kg)	Reported 1g SAR (W/kg)
	WLAN2.4GHz	802.11b 1Mbps	Right Cheek	Reduced	1	2412	15.30	16.00	1.175	98.28	1.018	0.01	0.261	0.312
	WLAN2.4GHz	802.11b 1Mbps	Right Tilted	Reduced	1	2412	15.30	16.00	1.175	98.28	1.018	0.03	0.309	0.370
12	WLAN2.4GHz	802.11b 1Mbps	Left Cheek	Reduced	1	2412	15.30	16.00	1.175	98.28	1.018	-0.05	0.570	0.682
	WLAN2.4GHz	802.11b 1Mbps	Left Tilted	Reduced	1	2412	15.30	16.00	1.175	98.28	1.018	0.08	0.368	0.440

<Bluetooth SAR>

Plot No.	Band	Mode	Test Position	Power Reduction	Ch.	Freq. (MHz)	Average Power (dBm)	Tune-Up Limit (dBm)	Tune-up Scaling Factor	Duty Cycle %	Duty Cycle Scaling Factor	Power Drift (dB)	Measured 1g SAR (W/kg)	Reported 1g SAR (W/kg)
13	Bluetooth	1Mbps	Left Cheek	Full Power	39	2441	11.00	11.50	1.122	76.84	1.084	0.05	0.266	0.324

<WLAN5G SAR>

Plot No.	Band	Mode	Test Position	Power Reduction	Ch.	Freq. (MHz)	Average Power (dBm)	Tune-Up Limit (dBm)	Tune-up Scaling Factor	Duty Cycle %	Duty Cycle Scaling Factor	Power Drift (dB)	Measured 1g SAR (W/kg)	Reported 1g SAR (W/kg)
14	WLAN5.3GHz	802.11n-HT40 MCS0	Right Cheek	Full Power	54	5270	16.47	17.00	1.131	96.03	1.041	0.07	0.068	0.080
	WLAN5.3GHz	802.11n-HT40 MCS0	Right Tilted	Full Power	54	5270	16.47	17.00	1.131	96.03	1.041	0.03	0.040	0.047
	WLAN5.3GHz	802.11n-HT40 MCS0	Left Cheek	Full Power	54	5270	16.47	17.00	1.131	96.03	1.041	0.01	0.060	0.071
	WLAN5.3GHz	802.11n-HT40 MCS0	Left Tilted	Full Power	54	5270	16.47	17.00	1.131	96.03	1.041	-0.09	0.043	0.051
15	WLAN5.5GHz	802.11n-HT40 MCS0	Right Cheek	Full Power	110	5550	17.82	18.50	1.169	96.03	1.041	-0.15	0.056	0.069
	WLAN5.5GHz	802.11n-HT40 MCS0	Right Tilted	Full Power	110	5550	17.82	18.50	1.169	96.03	1.041	0.02	0.032	0.039
	WLAN5.5GHz	802.11n-HT40 MCS0	Left Cheek	Full Power	110	5550	17.82	18.50	1.169	96.03	1.041	0.03	0.035	0.043
	WLAN5.5GHz	802.11n-HT40 MCS0	Left Tilted	Full Power	110	5550	17.82	18.50	1.169	96.03	1.041	0.02	0.030	0.037
	WLAN5.8GHz	802.11n-HT40 MCS0	Right Cheek	Full Power	151	5755	17.56	18.00	1.107	96.03	1.041	0.05	0.085	0.098
	WLAN5.8GHz	802.11n-HT40 MCS0	Right Tilted	Full Power	151	5755	17.56	18.00	1.107	96.03	1.041	0.03	0.077	0.089
16	WLAN5.8GHz	802.11n-HT40 MCS0	Left Cheek	Full Power	151	5755	17.56	18.00	1.107	96.03	1.041	-0.01	0.138	0.159
	WLAN5.8GHz	802.11n-HT40 MCS0	Left Tilted	Full Power	151	5755	17.56	18.00	1.107	96.03	1.041	-0.04	0.076	0.088



15.2 Hotspot SAR

<GSM SAR>

Plot No.	Band	Mode	Test Position	Gap (mm)	Power Reduction	Ch.	Freq. (MHz)	Average Power (dBm)	Tune-Up Limit (dBm)	Tune-up Scaling Factor	Power Drift (dB)	Measured 1g SAR (W/kg)	Reported 1g SAR (W/kg)
	GSM850	GPRS 2 Tx slots	Front	5mm	Full Power	189	836.4	29.11	30.50	1.377	-0.05	0.843	1.161
17	GSM850	GPRS 2 Tx slots	Front	5mm	Full Power	128	824.2	28.86	30.50	1.459	0.06	0.879	1.282
	GSM850	GPRS 2 Tx slots	Front	5mm	Full Power	251	848.8	29.10	30.50	1.380	-0.03	0.682	0.941
	GSM850	GPRS 2 Tx slots	Back	5mm	Full Power	189	836.4	29.11	30.50	1.377	0.03	0.771	1.062
	GSM850	GPRS 2 Tx slots	Back	5mm	Full Power	128	824.2	28.86	30.50	1.459	0.01	0.775	1.131
	GSM850	GPRS 2 Tx slots	Back	5mm	Full Power	251	848.8	29.10	30.50	1.380	-0.09	0.642	0.886
	GSM850	GPRS 2 Tx slots	Left Side	5mm	Full Power	189	836.4	29.11	30.50	1.377	0.02	0.289	0.398
	GSM850	GPRS 2 Tx slots	Right Side	5mm	Full Power	189	836.4	29.11	30.50	1.377	0.05	0.526	0.724
	GSM850	GPRS 2 Tx slots	Bottom Side	5mm	Full Power	189	836.4	29.11	30.50	1.377	-0.05	0.655	0.902
	GSM850	GPRS 2 Tx slots	Bottom Side	5mm	Full Power	128	824.2	28.86	30.50	1.459	-0.05	0.692	1.009
	GSM850	GPRS 2 Tx slots	Bottom Side	5mm	Full Power	251	848.8	29.10	30.50	1.380	-0.01	0.532	0.734
	GSM1900	GPRS 2 Tx slots	Front	5mm	Reduced	661	1880	22.43	24.00	1.435	0.02	0.822	1.180
18	GSM1900	GPRS 2 Tx slots	Front	5mm	Reduced	512	1850.2	22.41	24.00	1.442	-0.06	0.883	1.273
	GSM1900	GPRS 2 Tx slots	Front	5mm	Reduced	810	1909.8	22.36	24.00	1.459	0.02	0.842	1.228
	GSM1900	GPRS 2 Tx slots	Back	5mm	Reduced	661	1880	22.43	24.00	1.435	0.03	0.812	1.166
	GSM1900	GPRS 2 Tx slots	Back	5mm	Reduced	512	1850.2	22.41	24.00	1.442	0.14	0.743	1.071
	GSM1900	GPRS 2 Tx slots	Back	5mm	Reduced	810	1909.8	22.36	24.00	1.459	-0.01	0.771	1.125
	GSM1900	GPRS 2 Tx slots	Left Side	5mm	Reduced	661	1880	20.21	21.50	1.346	0.02	0.001	0.001
	GSM1900	GPRS 2 Tx slots	Right Side	5mm	Reduced	661	1880	20.21	21.50	1.346	-0.03	0.043	0.058
	GSM1900	GPRS 2 Tx slots	Bottom Side	5mm	Reduced	661	1880	20.21	21.50	1.346	0.05	0.815	1.097
	GSM1900	GPRS 2 Tx slots	Bottom Side	5mm	Reduced	512	1850.2	20.05	21.50	1.396	-0.02	0.884	1.234
	GSM1900	GPRS 2 Tx slots	Bottom Side	5mm	Reduced	810	1909.8	20.11	21.50	1.377	-0.07	0.847	1.166



<WCDMA SAR>

Plot No.	Band	Mode	Test Position	Gap (mm)	Power Reduction	Ch.	Freq. (MHz)	Average Power (dBm)	Tune-Up Limit (dBm)	Tune-up Scaling Factor	Power Drift (dB)	Measured 1g SAR (W/kg)	Reported 1g SAR (W/kg)
	WCDMA II	RMC 12.2Kbps	Front	5mm	Reduced	9400	1880	14.28	15.50	1.324	0.03	0.883	1.169
	WCDMA II	RMC 12.2Kbps	Front	5mm	Reduced	9262	1852.4	14.21	15.50	1.346	-0.19	0.909	1.223
	WCDMA II	RMC 12.2Kbps	Front	5mm	Reduced	9538	1907.6	14.22	15.50	1.343	-0.02	0.820	1.101
	WCDMA II	RMC 12.2Kbps	Back	5mm	Reduced	9400	1880	14.28	15.50	1.324	0.05	0.819	1.085
	WCDMA II	RMC 12.2Kbps	Back	5mm	Reduced	9262	1852.4	14.21	15.50	1.346	-0.15	0.826	1.112
	WCDMA II	RMC 12.2Kbps	Back	5mm	Reduced	9538	1907.6	14.22	15.50	1.343	-0.01	0.802	1.077
	WCDMA II	RMC 12.2Kbps	Left Side	5mm	Reduced	9400	1880	11.79	13.00	1.321	0.02	0.022	0.029
	WCDMA II	RMC 12.2Kbps	Right Side	5mm	Reduced	9400	1880	11.79	13.00	1.321	0.06	0.001	0.001
	WCDMA II	RMC 12.2Kbps	Bottom Side	5mm	Reduced	9400	1880	11.79	13.00	1.321	-0.07	0.952	1.258
	WCDMA II	RMC 12.2Kbps	Bottom Side	5mm	Reduced	9262	1852.4	11.70	13.00	1.349	-0.03	0.989	1.334
19	WCDMA II	RMC 12.2Kbps	Bottom Side	5mm	Reduced	9538	1907.6	11.52	13.00	1.406	-0.07	0.984	1.384
	WCDMA IV	RMC 12.2Kbps	Front	5mm	Reduced	1413	1732.6	15.27	16.00	1.183	0.12	1.036	1.226
	WCDMA IV	RMC 12.2Kbps	Front	5mm	Reduced	1513	1752.6	15.18	16.00	1.208	-0.09	1.100	1.329
	WCDMA IV	RMC 12.2Kbps	Front	5mm	Reduced	1312	1712.4	15.22	16.00	1.197	0.02	0.860	1.029
	WCDMA IV	RMC 12.2Kbps	Back	5mm	Reduced	1413	1732.6	15.27	16.00	1.183	0.09	0.899	1.064
	WCDMA IV	RMC 12.2Kbps	Back	5mm	Reduced	1312	1712.4	15.22	16.00	1.197	-0.13	0.785	0.939
	WCDMA IV	RMC 12.2Kbps	Back	5mm	Reduced	1513	1752.6	15.18	16.00	1.208	0.07	0.975	1.178
	WCDMA IV	RMC 12.2Kbps	Left Side	5mm	Reduced	1413	1732.6	13.23	14.00	1.194	-0.02	0.042	0.050
	WCDMA IV	RMC 12.2Kbps	Right Side	5mm	Reduced	1413	1732.6	13.23	14.00	1.194	0.04	0.004	0.005
	WCDMA IV	RMC 12.2Kbps	Bottom Side	5mm	Reduced	1413	1732.6	13.23	14.00	1.194	-0.09	1.049	1.252
	WCDMA IV	RMC 12.2Kbps	Bottom Side	5mm	Reduced	1312	1712.4	13.20	14.00	1.202	0.03	0.930	1.118
20	WCDMA IV	RMC 12.2Kbps	Bottom Side	5mm	Reduced	1513	1752.6	13.21	14.00	1.199	-0.07	1.140	1.367
	WCDMA V	RMC 12.2Kbps	Front	5mm	Reduced	4182	836.4	21.16	22.00	1.213	0.06	0.926	1.124
	WCDMA V	RMC 12.2Kbps	Front	5mm	Reduced	4132	826.4	20.86	22.00	1.300	-0.06	0.886	1.152
21	WCDMA V	RMC 12.2Kbps	Front	5mm	Reduced	4233	846.6	21.11	22.00	1.227	0.03	0.988	1.213
	WCDMA V	RMC 12.2Kbps	Back	5mm	Reduced	4182	836.4	21.16	22.00	1.213	0.05	0.789	0.957
	WCDMA V	RMC 12.2Kbps	Back	5mm	Reduced	4132	826.4	20.86	22.00	1.300	-0.03	0.757	0.984
	WCDMA V	RMC 12.2Kbps	Back	5mm	Reduced	4233	846.6	21.11	22.00	1.227	0.17	0.808	0.992
	WCDMA V	RMC 12.2Kbps	Left Side	5mm	Reduced	4182	836.4	21.16	22.00	1.213	0.06	0.198	0.240
	WCDMA V	RMC 12.2Kbps	Right Side	5mm	Reduced	4182	836.4	21.16	22.00	1.213	0.01	0.399	0.484
	WCDMA V	RMC 12.2Kbps	Bottom Side	5mm	Reduced	4182	836.4	21.16	22.00	1.213	-0.02	0.521	0.632



<FDD LTE SAR>

Plot No.	Band	BW (MHz)	Modulation	RB Size	RB offset	Test Position	Gap (mm)	Power Reduction	Ch.	Freq. (MHz)	Average Power (dBm)	Tune-Up Limit (dBm)	Tune-up Scaling Factor	Power Drift (dB)	Measured 1g SAR (W/kg)	Reported 1g SAR (W/kg)
	LTE Band 2	20M	QPSK	1	0	Front	5mm	Reduced	18900	1880	16.07	16.50	1.104	-0.02	1.070	1.181
	LTE Band 2	20M	QPSK	1	0	Front	5mm	Reduced	18700	1860	15.94	16.50	1.138	0.01	1.031	1.173
	LTE Band 2	20M	QPSK	1	0	Front	5mm	Reduced	19100	1900	15.83	16.50	1.167	0.05	0.989	1.154
	LTE Band 2	20M	QPSK	50	0	Front	5mm	Reduced	18900	1880	15.96	16.50	1.132	0.09	1.007	1.140
	LTE Band 2	20M	QPSK	50	0	Front	5mm	Reduced	18700	1860	15.89	16.50	1.151	-0.06	1.016	1.169
	LTE Band 2	20M	QPSK	50	0	Front	5mm	Reduced	19100	1900	15.81	16.50	1.172	0.03	0.954	1.118
	LTE Band 2	20M	QPSK	100	0	Front	5mm	Reduced	18900	1880	15.91	16.50	1.146	0.014	0.998	1.143
	LTE Band 2	20M	QPSK	1	0	Back	5mm	Reduced	18900	1880	16.07	16.50	1.104	0.05	0.906	1.000
	LTE Band 2	20M	QPSK	1	0	Back	5mm	Reduced	18700	1860	15.94	16.50	1.138	0.01	0.906	1.031
	LTE Band 2	20M	QPSK	1	0	Back	5mm	Reduced	19100	1900	15.83	16.50	1.167	0.09	0.888	1.036
	LTE Band 2	20M	QPSK	50	0	Back	5mm	Reduced	18900	1880	15.96	16.50	1.132	0.07	0.941	1.066
	LTE Band 2	20M	QPSK	50	0	Back	5mm	Reduced	18700	1860	15.89	16.50	1.151	0.12	0.897	1.032
	LTE Band 2	20M	QPSK	50	0	Back	5mm	Reduced	19100	1900	15.81	16.50	1.172	-0.02	0.869	1.019
	LTE Band 2	20M	QPSK	100	0	Back	5mm	Reduced	18900	1880	15.91	16.50	1.146	0.03	0.888	1.017
	LTE Band 2	20M	QPSK	1	0	Left Side	5mm	Reduced	18900	1880	13.18	14.00	1.208	0.03	0.035	0.042
	LTE Band 2	20M	QPSK	50	0	Left Side	5mm	Reduced	18900	1880	12.98	14.00	1.265	0.05	0.033	0.042
	LTE Band 2	20M	QPSK	1	0	Right Side	5mm	Reduced	18900	1880	13.18	14.00	1.208	0.01	0.025	0.030
	LTE Band 2	20M	QPSK	50	0	Right Side	5mm	Reduced	18900	1880	12.98	14.00	1.265	-0.06	0.025	0.031
	LTE Band 2	20M	QPSK	1	0	Bottom Side	5mm	Reduced	18900	1880	13.18	14.00	1.208	0.02	1.073	1.296
	LTE Band 2	20M	QPSK	1	0	Bottom Side	5mm	Reduced	18700	1860	12.97	14.00	1.268	0.09	0.999	1.266
22	LTE Band 2	20M	QPSK	1	0	Bottom Side	5mm	Reduced	19100	1900	13.00	14.00	1.259	-0.09	1.090	1.372
	LTE Band 2	20M	QPSK	50	0	Bottom Side	5mm	Reduced	18900	1880	12.98	14.00	1.265	0.03	1.032	1.305
	LTE Band 2	20M	QPSK	50	0	Bottom Side	5mm	Reduced	18700	1860	12.91	14.00	1.285	0.05	1.045	1.343
	LTE Band 2	20M	QPSK	50	0	Bottom Side	5mm	Reduced	19100	1900	12.88	14.00	1.294	0.01	1.008	1.305
	LTE Band 2	20M	QPSK	100	0	Bottom Side	5mm	Reduced	18900	1880	12.88	14.00	1.294	0.06	1.045	1.352
23	LTE Band 5	10M	QPSK	1	0	Front	5mm	Reduced	20525	836.5	22.44	23.00	1.138	-0.13	1.120	1.274
	LTE Band 5	10M	QPSK	25	0	Front	5mm	Reduced	20525	836.5	22.39	23.00	1.151	0.03	0.784	0.902
	LTE Band 5	10M	QPSK	50	0	Front	5mm	Reduced	20525	836.5	22.29	23.00	1.178	0.02	0.772	0.909
	LTE Band 5	10M	QPSK	1	0	Back	5mm	Reduced	20525	836.5	22.44	23.00	1.138	-0.04	0.991	1.127
	LTE Band 5	10M	QPSK	25	0	Back	5mm	Reduced	20525	836.5	22.39	23.00	1.151	0.1	0.632	0.727
	LTE Band 5	10M	QPSK	50	0	Back	5mm	Reduced	20525	836.5	22.29	23.00	1.178	0.15	0.661	0.778
	LTE Band 5	10M	QPSK	1	0	Left Side	5mm	Reduced	20525	836.5	22.44	23.00	1.138	0.06	0.264	0.300
	LTE Band 5	10M	QPSK	25	0	Left Side	5mm	Reduced	20525	836.5	22.39	23.00	1.151	0.07	0.174	0.200
	LTE Band 5	10M	QPSK	1	0	Right Side	5mm	Reduced	20525	836.5	22.44	23.00	1.138	0.01	0.454	0.516
	LTE Band 5	10M	QPSK	25	0	Right Side	5mm	Reduced	20525	836.5	22.39	23.00	1.151	0.06	0.290	0.334
	LTE Band 5	10M	QPSK	1	0	Bottom Side	5mm	Reduced	20525	836.5	22.44	23.00	1.138	-0.01	0.950	1.081
	LTE Band 5	10M	QPSK	25	0	Bottom Side	5mm	Reduced	20525	836.5	22.39	23.00	1.151	0.09	0.540	0.621
	LTE Band 5	10M	QPSK	50	0	Bottom Side	5mm	Reduced	20525	836.5	22.29	23.00	1.178	0.11	0.576	0.678



Plot No.	Band	BW (MHz)	Modulation	RB Size	RB offset	Test Position	Gap (mm)	Power Reduction	Ch.	Freq. (MHz)	Average Power (dBm)	Tune-Up Limit (dBm)	Tune-up Scaling Factor	Power Drift (dB)	Measured 1g SAR (W/kg)	Reported 1g SAR (W/kg)
24	LTE Band 12	10M	QPSK	1	0	Front	5mm	Full Power	23095	707.5	23.18	24.00	1.208	-0.15	0.891	1.076
	LTE Band 12	10M	QPSK	25	0	Front	5mm	Full Power	23095	707.5	22.16	23.00	1.213	0.06	0.506	0.614
	LTE Band 12	10M	QPSK	50	0	Front	5mm	Full Power	23095	707.5	22.08	23.00	1.236	-0.03	0.433	0.535
	LTE Band 12	10M	QPSK	1	0	Back	5mm	Full Power	23095	707.5	23.18	24.00	1.208	-0.01	0.828	1.000
	LTE Band 12	10M	QPSK	25	0	Back	5mm	Full Power	23095	707.5	22.16	23.00	1.213	0.05	0.508	0.616
	LTE Band 12	10M	QPSK	50	0	Back	5mm	Full Power	23095	707.5	22.08	23.00	1.236	-0.09	0.519	0.641
	LTE Band 12	10M	QPSK	1	0	Left Side	5mm	Full Power	23095	707.5	23.18	24.00	1.208	0.16	0.465	0.562
	LTE Band 12	10M	QPSK	25	0	Left Side	5mm	Full Power	23095	707.5	22.16	23.00	1.213	-0.02	0.262	0.318
	LTE Band 12	10M	QPSK	1	0	Right Side	5mm	Full Power	23095	707.5	23.18	24.00	1.208	-0.17	0.692	0.836
	LTE Band 12	10M	QPSK	25	0	Right Side	5mm	Full Power	23095	707.5	22.16	23.00	1.213	0.02	0.354	0.430
	LTE Band 12	10M	QPSK	50	0	Right Side	5mm	Full Power	23095	707.5	22.08	23.00	1.236	0.03	0.350	0.433
	LTE Band 12	10M	QPSK	1	0	Bottom Side	5mm	Full Power	23095	707.5	23.18	24.00	1.208	0.02	0.622	0.751
	LTE Band 12	10M	QPSK	25	0	Bottom Side	5mm	Full Power	23095	707.5	22.16	23.00	1.213	0.01	0.340	0.413
	LTE Band 14	10M	QPSK	1	0	Front	5mm	Full Power	23330	793	23.25	24.00	1.189	-0.03	1.130	1.343
	LTE Band 14	10M	QPSK	25	0	Front	5mm	Full Power	23330	793	22.53	23.00	1.114	0.05	0.676	0.753
	LTE Band 14	10M	QPSK	50	0	Front	5mm	Full Power	23330	793	22.54	23.00	1.112	0.03	0.703	0.782
25	LTE Band 14	10M	QPSK	1	0	Back	5mm	Full Power	23330	793	23.25	24.00	1.189	-0.15	1.210	1.438
	LTE Band 14	10M	QPSK	25	0	Back	5mm	Full Power	23330	793	22.53	23.00	1.114	0.04	0.616	0.686
	LTE Band 14	10M	QPSK	50	0	Back	5mm	Full Power	23330	793	22.54	23.00	1.112	-0.12	0.589	0.655
	LTE Band 14	10M	QPSK	1	0	Left Side	5mm	Full Power	23330	793	23.25	24.00	1.189	0.06	0.384	0.456
	LTE Band 14	10M	QPSK	25	0	Left Side	5mm	Full Power	23330	793	22.53	23.00	1.114	0.01	0.193	0.215
	LTE Band 14	10M	QPSK	1	0	Right Side	5mm	Full Power	23330	793	23.25	24.00	1.189	-0.02	0.636	0.756
	LTE Band 14	10M	QPSK	25	0	Right Side	5mm	Full Power	23330	793	22.53	23.00	1.114	0.05	0.331	0.369
	LTE Band 14	10M	QPSK	1	0	Bottom Side	5mm	Full Power	23330	793	23.25	24.00	1.189	-0.06	0.962	1.143
	LTE Band 14	10M	QPSK	25	0	Bottom Side	5mm	Full Power	23330	793	22.53	23.00	1.114	0.07	0.508	0.566
	LTE Band 30	10M	QPSK	1	0	Front	5mm	Reduced	27710	2310	20.15	21.00	1.216	-0.04	0.931	1.132
	LTE Band 30	10M	QPSK	25	0	Front	5mm	Reduced	27710	2310	20.11	21.00	1.227	0.03	0.915	1.123
	LTE Band 30	10M	QPSK	50	0	Front	5mm	Reduced	27710	2310	20.03	21.00	1.250	0.02	0.902	1.128
26	LTE Band 30	10M	QPSK	1	0	Back	5mm	Reduced	27710	2310	20.15	21.00	1.216	-0.11	1.180	1.435
	LTE Band 30	10M	QPSK	25	0	Back	5mm	Reduced	27710	2310	20.11	21.00	1.227	-0.01	1.050	1.289
	LTE Band 30	10M	QPSK	50	0	Back	5mm	Reduced	27710	2310	20.03	21.00	1.250	0.05	1.070	1.338
	LTE Band 30	10M	QPSK	1	0	Left Side	5mm	Reduced	27710	2310	20.15	21.00	1.216	0.08	0.870	1.058
	LTE Band 30	10M	QPSK	25	0	Left Side	5mm	Reduced	27710	2310	20.11	21.00	1.227	0.03	0.717	0.880
	LTE Band 30	10M	QPSK	50	0	Left Side	5mm	Reduced	27710	2310	20.03	21.00	1.250	0.05	0.736	0.920
	LTE Band 30	10M	QPSK	1	0	Right Side	5mm	Reduced	27710	2310	20.15	21.00	1.216	-0.01	0.061	0.074
	LTE Band 30	10M	QPSK	25	0	Right Side	5mm	Reduced	27710	2310	20.11	21.00	1.227	-0.15	0.063	0.077
	LTE Band 30	10M	QPSK	1	0	Bottom Side	5mm	Reduced	27710	2310	20.15	21.00	1.216	0.12	0.671	0.816
	LTE Band 30	10M	QPSK	25	0	Bottom Side	5mm	Reduced	27710	2310	20.11	21.00	1.227	-0.01	0.654	0.803
	LTE Band 30	10M	QPSK	50	0	Bottom Side	5mm	Reduced	27710	2310	20.03	21.00	1.250	0.02	0.648	0.810



Plot No.	Band	BW (MHz)	Modulation	RB Size	RB offset	Test Position	Gap (mm)	Power Reduction	Ch.	Freq. (MHz)	Average Power (dBm)	Tune-Up Limit (dBm)	Tune-up Scaling Factor	Power Drift (dB)	Measured 1g SAR (W/kg)	Reported 1g SAR (W/kg)
	LTE Band 66	20M	QPSK	1	0	Front	5mm	Reduced	132322	1745	16.06	16.50	1.107	0.01	1.007	1.114
	LTE Band 66	20M	QPSK	1	0	Front	5mm	Reduced	132072	1720	16.01	16.50	1.119	0.02	0.792	0.887
	LTE Band 66	20M	QPSK	1	0	Front	5mm	Reduced	132572	1770	15.98	16.50	1.127	0.06	1.025	1.155
	LTE Band 66	20M	QPSK	50	0	Front	5mm	Reduced	132322	1745	15.86	16.50	1.159	-0.01	1.070	1.240
	LTE Band 66	20M	QPSK	50	0	Front	5mm	Reduced	132072	1720	15.82	16.50	1.169	0.02	0.877	1.026
	LTE Band 66	20M	QPSK	50	0	Front	5mm	Reduced	132572	1770	15.75	16.50	1.189	0.17	1.110	1.319
	LTE Band 66	20M	QPSK	100	0	Front	5mm	Reduced	132322	1745	15.71	16.50	1.199	0.03	1.043	1.251
	LTE Band 66	20M	QPSK	1	0	Back	5mm	Reduced	132322	1745	16.06	16.50	1.107	-0.02	1.020	1.129
	LTE Band 66	20M	QPSK	1	0	Back	5mm	Reduced	132072	1720	16.01	16.50	1.119	0.02	0.865	0.968
	LTE Band 66	20M	QPSK	1	0	Back	5mm	Reduced	132572	1770	15.98	16.50	1.127	0.07	1.007	1.135
	LTE Band 66	20M	QPSK	50	0	Back	5mm	Reduced	132322	1745	15.86	16.50	1.159	0.05	0.954	1.105
	LTE Band 66	20M	QPSK	50	0	Back	5mm	Reduced	132072	1720	15.82	16.50	1.169	-0.15	0.824	0.964
	LTE Band 66	20M	QPSK	50	0	Back	5mm	Reduced	132572	1770	15.75	16.50	1.189	0.05	1.060	1.260
	LTE Band 66	20M	QPSK	100	0	Back	5mm	Reduced	132322	1745	15.71	16.50	1.199	0.02	0.989	1.186
	LTE Band 66	20M	QPSK	1	0	Left Side	5mm	Reduced	132322	1745	13.87	14.50	1.156	0.15	0.040	0.046
	LTE Band 66	20M	QPSK	50	0	Left Side	5mm	Reduced	132322	1745	13.87	14.50	1.156	0.03	0.045	0.052
	LTE Band 66	20M	QPSK	1	0	Right Side	5mm	Reduced	132322	1745	13.87	14.50	1.156	0.08	0.041	0.047
	LTE Band 66	20M	QPSK	50	0	Right Side	5mm	Reduced	132322	1745	13.87	14.50	1.156	-0.01	0.040	0.046
	LTE Band 66	20M	QPSK	1	0	Bottom Side	5mm	Reduced	132322	1745	13.87	14.50	1.156	0.02	1.130	1.306
	LTE Band 66	20M	QPSK	1	0	Bottom Side	5mm	Reduced	132072	1720	13.77	14.50	1.183	0.08	0.950	1.124
	LTE Band 66	20M	QPSK	1	0	Bottom Side	5mm	Reduced	132572	1770	13.82	14.50	1.169	0.02	1.200	1.403
	LTE Band 66	20M	QPSK	50	0	Bottom Side	5mm	Reduced	132322	1745	13.87	14.50	1.156	0.03	1.160	1.341
	LTE Band 66	20M	QPSK	50	0	Bottom Side	5mm	Reduced	132072	1720	13.79	14.50	1.178	0.09	1.030	1.213
27	LTE Band 66	20M	QPSK	50	0	Bottom Side	5mm	Reduced	132572	1770	13.86	14.50	1.159	-0.17	1.220	1.414
	LTE Band 66	20M	QPSK	100	0	Bottom Side	5mm	Reduced	132322	1745	13.81	14.50	1.172	-0.02	1.190	1.395

<WLAN2.4G SAR>

Plot No.	Band	Mode	Test Position	Gap (mm)	Power Reduction	Ch.	Freq. (MHz)	Average Power (dBm)	Tune-Up Limit (dBm)	Tune-up Scaling Factor	Duty Cycle %	Duty Cycle Scaling Factor	Power Drift (dB)	Measured 1g SAR (W/kg)	Reported 1g SAR (W/kg)
	WLAN2.4GHz	802.11b 1Mbps	Front	5mm	Full Power	11	2462	18.70	20.00	1.349	98.28	1.018	-0.06	0.429	0.589
	WLAN2.4GHz	802.11b 1Mbps	Back	5mm	Full Power	11	2462	18.70	20.00	1.349	98.28	1.018	0.03	0.586	0.805
	WLAN2.4GHz	802.11b 1Mbps	Back	5mm	Full Power	6	2437	18.60	20.00	1.380	98.28	1.018	0.08	0.488	0.686
	WLAN2.4GHz	802.11b 1Mbps	Left Side	5mm	Full Power	11	2462	18.70	20.00	1.349	98.28	1.018	0.03	0.115	0.158
	WLAN2.4GHz	802.11b 1Mbps	Right Side	5mm	Full Power	11	2462	18.70	20.00	1.349	98.28	1.018	0.05	0.267	0.367
28	WLAN2.4GHz	802.11b 1Mbps	Top Side	5mm	Full Power	11	2462	18.70	20.00	1.349	98.28	1.018	-0.16	0.856	1.175
	WLAN2.4GHz	802.11b 1Mbps	Top Side	5mm	Full Power	6	2437	18.60	20.00	1.380	98.28	1.018	-0.02	0.646	0.908

<Bluetooth SAR>

Plot No.	Band	Mode	Test Position	Gap (mm)	Power Reduction	Ch.	Freq. (MHz)	Average Power (dBm)	Tune-Up Limit (dBm)	Tune-up Scaling Factor	Duty Cycle %	Duty Cycle Scaling Factor	Power Drift (dB)	Measured 1g SAR (W/kg)	Reported 1g SAR (W/kg)
	Bluetooth	1Mbps	Back	5mm	Full Power	39	2441	11.00	11.50	1.122	76.84	1.084	-0.02	0.130	0.158
29	Bluetooth	1Mbps	Top Side	5mm	Full Power	39	2441	11.00	11.50	1.122	76.84	1.084	-0.07	0.148	0.180



<WLAN5G SAR>

Plot No.	Band	Mode	Test Position	Gap (mm)	Power Reduction	Ch.	Freq. (MHz)	Average Power (dBm)	Tune-Up Limit (dBm)	Tune-up Scaling Factor	Duty Cycle %	Duty Cycle Scaling Factor	Power Drift (dB)	Measured 1g SAR (W/kg)	Reported 1g SAR (W/kg)
	WLAN5.2GHz	802.11n-HT40 MCS0	Front	5mm	Reduced	38	5190	8.05	8.50	1.109	96.03	1.041	0.08	0.055	0.064
	WLAN5.2GHz	802.11n-HT40 MCS0	Back	5mm	Reduced	38	5190	8.05	8.50	1.109	96.03	1.041	-0.01	0.848	0.979
30	WLAN5.2GHz	802.11n-HT40 MCS0	Back	5mm	Reduced	46	5230	7.92	8.50	1.143	96.03	1.041	0.08	0.948	1.128
	WLAN5.2GHz	802.11n-HT40 MCS0	Left Side	5mm	Reduced	38	5190	8.05	8.50	1.109	96.03	1.041	0.02	0.076	0.088
	WLAN5.2GHz	802.11n-HT40 MCS0	Right Side	5mm	Reduced	38	5190	8.05	8.50	1.109	96.03	1.041	0.09	0.066	0.076
	WLAN5.2GHz	802.11n-HT40 MCS0	Top Side	5mm	Reduced	38	5190	8.05	8.50	1.109	96.03	1.041	0.02	0.063	0.073
	WLAN5.8GHz	802.11n-HT40 MCS0	Front	5mm	Reduced	151	5755	8.38	9.00	1.153	96.03	1.041	0.03	0.071	0.085
	WLAN5.8GHz	802.11n-HT40 MCS0	Back	5mm	Reduced	151	5755	8.38	9.00	1.153	96.03	1.041	0.07	0.673	0.808
31	WLAN5.8GHz	802.11n-HT40 MCS0	Back	5mm	Reduced	159	5795	8.37	9.00	1.156	96.03	1.041	0.04	0.911	1.096
	WLAN5.8GHz	802.11n-HT40 MCS0	Left Side	5mm	Reduced	151	5755	8.38	9.00	1.153	96.03	1.041	-0.02	0.065	0.078
	WLAN5.8GHz	802.11n-HT40 MCS0	Right Side	5mm	Reduced	151	5755	8.38	9.00	1.153	96.03	1.041	0.03	0.117	0.140
	WLAN5.8GHz	802.11n-HT40 MCS0	Top Side	5mm	Reduced	151	5755	8.38	9.00	1.153	96.03	1.041	-0.02	0.122	0.146



15.3 Body Worn Accessory SAR

<GSM SAR>

Plot No.	Band	Mode	Test Position	Gap (mm)	Headset	Power Reduction	Ch.	Freq. (MHz)	Average Power (dBm)	Tune-Up Limit (dBm)	Tune-up Scaling Factor	Power Drift (dB)	Measured 1g SAR (W/kg)	Reported 1g SAR (W/kg)
	GSM850	GPRS 2 Tx slots	Front	5mm	-	Full Power	189	836.4	29.11	30.50	1.377	-0.05	0.843	1.161
32	GSM850	GPRS 2 Tx slots	Front	5mm	-	Full Power	128	824.2	28.86	30.50	1.459	0.06	0.879	1.282
	GSM850	GPRS 2 Tx slots	Front	5mm	-	Full Power	251	848.8	29.10	30.50	1.380	-0.03	0.682	0.941
	GSM850	GPRS 2 Tx slots	Front	5mm	Headset	Full Power	128	824.2	28.86	30.50	1.459	-0.08	0.843	1.230
	GSM850	GPRS 2 Tx slots	Back	5mm	-	Full Power	189	836.4	29.11	30.50	1.377	0.03	0.771	1.062
	GSM850	GPRS 2 Tx slots	Back	5mm	-	Full Power	128	824.2	28.86	30.50	1.459	0.01	0.775	1.131
	GSM850	GPRS 2 Tx slots	Back	5mm	-	Full Power	251	848.8	29.10	30.50	1.380	-0.09	0.642	0.886
	GSM1900	GPRS 2 Tx slots	Front	5mm	-	Reduced	661	1880	22.43	24.00	1.435	0.02	0.822	1.180
33	GSM1900	GPRS 2 Tx slots	Front	5mm	-	Reduced	512	1850.2	22.41	24.00	1.442	-0.06	0.883	1.273
	GSM1900	GPRS 2 Tx slots	Front	5mm	-	Reduced	810	1909.8	22.36	24.00	1.459	0.02	0.842	1.228
	GSM1900	GPRS 2 Tx slots	Front	5mm	Headset	Reduced	512	1850.2	22.41	24.00	1.442	0.14	0.876	1.263
	GSM1900	GPRS 2 Tx slots	Back	5mm	-	Reduced	661	1880	22.43	24.00	1.435	0.03	0.812	1.166
	GSM1900	GPRS 2 Tx slots	Back	5mm	-	Reduced	512	1850.2	22.41	24.00	1.442	0.14	0.743	1.071
	GSM1900	GPRS 2 Tx slots	Back	5mm	-	Reduced	810	1909.8	22.36	24.00	1.459	-0.01	0.771	1.125
	GSM1900	GPRS 2 Tx slots	Front	20mm	-	Full Power	661	1880	26.35	27.50	1.303	0.02	0.257	0.335
	GSM1900	GPRS 2 Tx slots	Back	23mm	-	Full Power	661	1880	26.35	27.50	1.303	0.01	0.281	0.366

<WCDMA SAR>

Plot No.	Band	Mode	Test Position	Gap (mm)	Headset	Power Reduction	Ch.	Freq. (MHz)	Average Power (dBm)	Tune-Up Limit (dBm)	Tune-up Scaling Factor	Power Drift (dB)	Measured 1g SAR (W/kg)	Reported 1g SAR (W/kg)
	WCDMA II	RMC 12.2Kbps	Front	5mm	-	Reduced	9400	1880	14.28	15.50	1.324	0.03	0.883	1.169
34	WCDMA II	RMC 12.2Kbps	Front	5mm	-	Reduced	9262	1852.4	14.21	15.50	1.346	-0.19	0.909	1.223
	WCDMA II	RMC 12.2Kbps	Front	5mm	-	Reduced	9538	1907.6	14.22	15.50	1.343	-0.02	0.820	1.101
	WCDMA II	RMC 12.2Kbps	Front	5mm	Headset	Reduced	9262	1852.4	14.21	15.50	1.346	0.01	0.876	1.179
	WCDMA II	RMC 12.2Kbps	Back	5mm	-	Reduced	9400	1880	14.28	15.50	1.324	0.05	0.819	1.085
	WCDMA II	RMC 12.2Kbps	Back	5mm	-	Reduced	9262	1852.4	14.21	15.50	1.346	-0.15	0.826	1.112
	WCDMA II	RMC 12.2Kbps	Back	5mm	-	Reduced	9538	1907.6	14.22	15.50	1.343	-0.01	0.802	1.077
	WCDMA II	RMC 12.2Kbps	Front	20mm	-	Full Power	9262	1852.4	22.96	24.00	1.271	0.03	0.788	1.001
	WCDMA II	RMC 12.2Kbps	Back	23mm	-	Full Power	9262	1852.4	22.96	24.00	1.271	-0.02	0.628	0.798
	WCDMA IV	RMC 12.2Kbps	Front	5mm	-	Reduced	1413	1732.6	15.27	16.00	1.183	0.12	1.036	1.226
35	WCDMA IV	RMC 12.2Kbps	Front	5mm	-	Reduced	1513	1752.6	15.18	16.00	1.208	-0.09	1.100	1.329
	WCDMA IV	RMC 12.2Kbps	Front	5mm	-	Reduced	1312	1712.4	15.22	16.00	1.197	0.02	0.860	1.029
	WCDMA IV	RMC 12.2Kbps	Front	5mm	Headset	Reduced	1513	1752.6	15.18	16.00	1.208	0.08	1.080	1.304
	WCDMA IV	RMC 12.2Kbps	Back	5mm	-	Reduced	1413	1732.6	15.27	16.00	1.183	0.09	0.899	1.064
	WCDMA IV	RMC 12.2Kbps	Back	5mm	-	Reduced	1312	1712.4	15.22	16.00	1.197	-0.13	0.785	0.939
	WCDMA IV	RMC 12.2Kbps	Back	5mm	-	Reduced	1513	1752.6	15.18	16.00	1.208	0.07	0.975	1.178
	WCDMA IV	RMC 12.2Kbps	Front	20mm	-	Full Power	1513	1752.6	23.10	24.00	1.230	0.05	0.740	0.910
	WCDMA IV	RMC 12.2Kbps	Back	23mm	-	Full Power	1513	1752.6	23.10	24.00	1.230	0.04	0.581	0.715
	WCDMA V	RMC 12.2Kbps	Front	5mm	-	Reduced	4182	836.4	21.16	22.00	1.213	0.06	0.926	1.124
	WCDMA V	RMC 12.2Kbps	Front	5mm	-	Reduced	4132	826.4	20.86	22.00	1.300	-0.06	0.886	1.152
36	WCDMA V	RMC 12.2Kbps	Front	5mm	-	Reduced	4233	846.6	21.11	22.00	1.227	0.03	0.988	1.213
	WCDMA V	RMC 12.2Kbps	Front	5mm	Headset	Reduced	4233	846.6	21.11	22.00	1.227	-0.14	0.968	1.188
	WCDMA V	RMC 12.2Kbps	Back	5mm	-	Reduced	4182	836.4	21.16	22.00	1.213	0.05	0.789	0.957
	WCDMA V	RMC 12.2Kbps	Back	5mm	-	Reduced	4132	826.4	20.86	22.00	1.300	-0.03	0.757	0.984
	WCDMA V	RMC 12.2Kbps	Back	5mm	-	Reduced	4233	846.6	21.11	22.00	1.227	0.17	0.808	0.992
	WCDMA V	RMC 12.2Kbps	Front	20mm	-	Full Power	4233	846.6	23.14	24.00	1.219	0.05	0.213	0.260
	WCDMA V	RMC 12.2Kbps	Back	23mm	-	Full Power	4233	846.6	23.14	24.00	1.219	0.03	0.290	0.354



<FDD LTE SAR>

Plot No.	Band	BW (MHz)	Modulation	RB Size	RB offset	Test Position	Gap (mm)	Headset	Power Reduction	Ch.	Freq. (MHz)	Average Power (dBm)	Tune-Up Limit (dBm)	Tune-up Scaling Factor	Duty Cycle Scaling Factor	Power Drift (dB)	Measured 1g SAR (W/kg)	Reported 1g SAR (W/kg)
37	LTE Band 2	20M	QPSK	1	0	Front	5mm	-	Reduced	18900	1880	16.07	16.50	1.104	1.000	-0.02	1.070	1.181
	LTE Band 2	20M	QPSK	1	0	Front	5mm	-	Reduced	18700	1860	15.94	16.50	1.138	1.000	0.01	1.031	1.173
	LTE Band 2	20M	QPSK	1	0	Front	5mm	-	Reduced	19100	1900	15.83	16.50	1.167	1.000	0.05	0.989	1.154
	LTE Band 2	20M	QPSK	50	0	Front	5mm	-	Reduced	18900	1880	15.96	16.50	1.132	1.000	0.09	1.007	1.140
	LTE Band 2	20M	QPSK	50	0	Front	5mm	-	Reduced	18700	1860	15.89	16.50	1.151	1.000	-0.06	1.016	1.169
	LTE Band 2	20M	QPSK	50	0	Front	5mm	-	Reduced	19100	1900	15.81	16.50	1.172	1.000	0.03	0.954	1.118
	LTE Band 2	20M	QPSK	100	0	Front	5mm	-	Reduced	18900	1880	15.91	16.50	1.146	1.000	0.014	0.998	1.143
	LTE Band 2	20M	QPSK	1	0	Back	5mm	-	Reduced	18900	1880	16.07	16.50	1.104	1.000	0.05	0.906	1.000
	LTE Band 2	20M	QPSK	1	0	Back	5mm	-	Reduced	18700	1860	15.94	16.50	1.138	1.000	0.01	0.906	1.031
	LTE Band 2	20M	QPSK	1	0	Back	5mm	-	Reduced	19100	1900	15.83	16.50	1.167	1.000	0.09	0.888	1.036
	LTE Band 2	20M	QPSK	50	0	Back	5mm	-	Reduced	18900	1880	15.96	16.50	1.132	1.000	0.07	0.941	1.066
	LTE Band 2	20M	QPSK	50	0	Back	5mm	-	Reduced	18700	1860	15.89	16.50	1.151	1.000	0.12	0.897	1.032
	LTE Band 2	20M	QPSK	50	0	Back	5mm	-	Reduced	19100	1900	15.81	16.50	1.172	1.000	-0.02	0.869	1.019
	LTE Band 2	20M	QPSK	100	0	Back	5mm	-	Reduced	18900	1880	15.91	16.50	1.146	1.000	0.03	0.888	1.017
	LTE Band 2	20M	QPSK	1	0	Front	20mm	-	Full Power	18900	1880	23.27	24.00	1.183	1.000	-0.08	0.692	0.819
	LTE Band 2	20M	QPSK	1	0	Back	23mm	-	Full Power	18900	1880	23.27	24.00	1.183	1.000	0.01	0.381	0.451
38	LTE Band 5	10M	QPSK	1	0	Front	5mm	-	Reduced	20525	836.5	22.44	23.00	1.138	1.000	-0.13	1.120	1.274
	LTE Band 5	10M	QPSK	25	0	Front	5mm	-	Reduced	20525	836.5	22.39	23.00	1.151	1.000	0.03	0.784	0.902
	LTE Band 5	10M	QPSK	50	0	Front	5mm	-	Reduced	20525	836.5	22.29	23.00	1.178	1.000	0.02	0.772	0.909
	LTE Band 5	10M	QPSK	1	0	Front	5mm	Headset	Reduced	20525	836.5	22.44	23.00	1.138	1.000	-0.03	1.110	1.263
	LTE Band 5	10M	QPSK	1	0	Back	5mm	-	Reduced	20525	836.5	22.44	23.00	1.138	1.000	-0.04	0.991	1.127
	LTE Band 5	10M	QPSK	25	0	Back	5mm	-	Reduced	20525	836.5	22.39	23.00	1.151	1.000	0.1	0.632	0.727
	LTE Band 5	10M	QPSK	50	0	Back	5mm	-	Reduced	20525	836.5	22.29	23.00	1.178	1.000	0.15	0.661	0.778
	LTE Band 5	10M	QPSK	1	0	Front	20mm	-	Full Power	20525	836.5	23.24	24.00	1.191	1.000	0.01	0.293	0.349
	LTE Band 5	10M	QPSK	1	0	Back	23mm	-	Full Power	20525	836.5	23.24	24.00	1.191	1.000	0.03	0.231	0.275
39	LTE Band 12	10M	QPSK	1	0	Front	5mm	-	Full Power	23095	707.5	23.18	24.00	1.208	1.000	-0.15	0.891	1.076
	LTE Band 12	10M	QPSK	25	0	Front	5mm	-	Full Power	23095	707.5	22.16	23.00	1.213	1.000	0.06	0.506	0.614
	LTE Band 12	10M	QPSK	50	0	Front	5mm	-	Full Power	23095	707.5	22.08	23.00	1.236	1.000	-0.03	0.433	0.535
	LTE Band 12	10M	QPSK	1	0	Back	5mm	-	Full Power	23095	707.5	23.18	24.00	1.208	1.000	-0.01	0.828	1.000
	LTE Band 12	10M	QPSK	25	0	Back	5mm	-	Full Power	23095	707.5	22.16	23.00	1.213	1.000	0.05	0.508	0.616
	LTE Band 12	10M	QPSK	50	0	Back	5mm	-	Full Power	23095	707.5	22.08	23.00	1.236	1.000	-0.09	0.519	0.641
	LTE Band 14	10M	QPSK	1	0	Front	5mm	-	Full Power	23330	793	23.25	24.00	1.189	1.000	-0.03	1.130	1.343
	LTE Band 14	10M	QPSK	25	0	Front	5mm	-	Full Power	23330	793	22.53	23.00	1.114	1.000	0.05	0.676	0.753
	LTE Band 14	10M	QPSK	50	0	Front	5mm	-	Full Power	23330	793	22.54	23.00	1.112	1.000	0.03	0.703	0.782
40	LTE Band 14	10M	QPSK	1	0	Back	5mm	-	Full Power	23330	793	23.25	24.00	1.189	1.000	-0.15	1.210	1.438
	LTE Band 14	10M	QPSK	25	0	Back	5mm	-	Full Power	23330	793	22.53	23.00	1.114	1.000	0.04	0.616	0.686
	LTE Band 14	10M	QPSK	50	0	Back	5mm	-	Full Power	23330	793	22.54	23.00	1.112	1.000	-0.12	0.589	0.655
	LTE Band 14	10M	QPSK	1	0	Back	5mm	Headset	Full Power	23330	793	23.25	24.00	1.189	1.000	0.05	1.100	1.307
	LTE Band 30	10M	QPSK	1	0	Front	5mm	-	Reduced	27710	2310	20.15	21.00	1.216	1.000	-0.04	0.931	1.132
	LTE Band 30	10M	QPSK	25	0	Front	5mm	-	Reduced	27710	2310	20.11	21.00	1.227	1.000	0.03	0.915	1.123
	LTE Band 30	10M	QPSK	50	0	Front	5mm	-	Reduced	27710	2310	20.03	21.00	1.250	1.000	0.02	0.902	1.128
41	LTE Band 30	10M	QPSK	1	0	Back	5mm	-	Reduced	27710	2310	20.15	21.00	1.216	1.000	-0.11	1.180	1.435
	LTE Band 30	10M	QPSK	25	0	Back	5mm	-	Reduced	27710	2310	20.11	21.00	1.227	1.000	-0.01	1.050	1.289
	LTE Band 30	10M	QPSK	50	0	Back	5mm	-	Reduced	27710	2310	20.03	21.00	1.250	1.000	0.05	1.070	1.338
	LTE Band 30	10M	QPSK	1	0	Back	5mm	Headset	Reduced	27710	2310	20.15	21.00	1.216	1.000	-0.06	1.020	1.241
	LTE Band 30	10M	QPSK	1	0	Front	20mm	-	Full Power	27710	2310	23.24	24.00	1.191	1.000	-0.08	0.241	0.287
	LTE Band 30	10M	QPSK	1	0	Back	23mm	-	Full Power	27710	2310	23.24	24.00	1.191	1.000	0.01	0.159	0.189



Plot No.	Band	BW (MHz)	Modulation	RB Size	RB offset	Test Position	Gap (mm)	Headset	Power Reduction	Ch.	Freq. (MHz)	Average Power (dBm)	Tune-Up Limit (dBm)	Tune-up Scaling Factor	Duty Cycle Scaling Factor	Power Drift (dB)	Measured 1g SAR (W/kg)	Reported 1g SAR (W/kg)
	LTE Band 66	20M	QPSK	1	0	Front	5mm	-	Reduced	132322	1745	16.06	16.50	1.107	1.000	0.01	1.007	1.114
	LTE Band 66	20M	QPSK	1	0	Front	5mm	-	Reduced	132072	1720	16.01	16.50	1.119	1.000	0.02	0.792	0.887
	LTE Band 66	20M	QPSK	1	0	Front	5mm	-	Reduced	132572	1770	15.98	16.50	1.127	1.000	0.06	1.025	1.155
	LTE Band 66	20M	QPSK	50	0	Front	5mm	-	Reduced	132322	1745	15.86	16.50	1.159	1.000	-0.01	1.070	1.240
	LTE Band 66	20M	QPSK	50	0	Front	5mm	-	Reduced	132072	1720	15.82	16.50	1.169	1.000	0.02	0.877	1.026
	LTE Band 66	20M	QPSK	50	0	Front	5mm	-	Reduced	132572	1770	15.75	16.50	1.189	1.000	0.17	1.110	1.319
	LTE Band 66	20M	QPSK	100	0	Front	5mm	-	Reduced	132322	1745	15.71	16.50	1.199	1.000	0.03	1.043	1.251
42	LTE Band 66	20M	QPSK	50	0	Front	5mm	Headset	Reduced	132572	1770	15.75	16.50	1.189	1.000	-0.04	1.200	1.426
	LTE Band 66	20M	QPSK	50	0	Front	5mm	Headset	Reduced	132322	1745	15.86	16.50	1.159	1.000	0.14	1.150	1.333
	LTE Band 66	20M	QPSK	50	0	Front	5mm	Headset	Reduced	132072	1720	15.82	16.50	1.169	1.000	0.11	0.982	1.148
	LTE Band 66	20M	QPSK	1	0	Back	5mm	-	Reduced	132322	1745	16.06	16.50	1.107	1.000	-0.02	1.020	1.129
	LTE Band 66	20M	QPSK	1	0	Back	5mm	-	Reduced	132072	1720	16.01	16.50	1.119	1.000	0.02	0.865	0.968
	LTE Band 66	20M	QPSK	1	0	Back	5mm	-	Reduced	132572	1770	15.98	16.50	1.127	1.000	0.07	1.007	1.135
	LTE Band 66	20M	QPSK	50	0	Back	5mm	-	Reduced	132322	1745	15.86	16.50	1.159	1.000	0.05	0.954	1.105
	LTE Band 66	20M	QPSK	50	0	Back	5mm	-	Reduced	132072	1720	15.82	16.50	1.169	1.000	-0.15	0.824	0.964
	LTE Band 66	20M	QPSK	50	0	Back	5mm	-	Reduced	132572	1770	15.75	16.50	1.189	1.000	0.05	1.060	1.260
	LTE Band 66	20M	QPSK	100	0	Back	5mm	-	Reduced	132322	1745	15.71	16.50	1.199	1.000	0.02	0.989	1.186
	LTE Band 66	20M	QPSK	1	0	Front	20mm	-	Full Power	132572	1770	23.33	24.00	1.167	1.000	0.03	0.753	0.879
	LTE Band 66	20M	QPSK	1	0	Back	23mm	-	Full Power	132572	1770	23.33	24.00	1.167	1.000	0.01	0.381	0.445

<WLAN2.4G SAR>

Plot No.	Band	Mode	Test Position	Gap (mm)	Headset	Power Reduction	Ch.	Freq. (MHz)	Average Power (dBm)	Tune-Up Limit (dBm)	Tune-up Scaling Factor	Duty Cycle %	Duty Cycle Scaling Factor	Power Drift (dB)	Measured 1g SAR (W/kg)	Reported 1g SAR (W/kg)
	WLAN2.4GHz	802.11b 1Mbps	Front	5mm	-	Full Power	11	2462	18.70	20.00	1.349	98.28	1.018	-0.06	0.429	0.589
43	WLAN2.4GHz	802.11b 1Mbps	Back	5mm	-	Full Power	11	2462	18.70	20.00	1.349	98.28	1.018	0.03	0.586	0.805
	WLAN2.4GHz	802.11b 1Mbps	Back	5mm	-	Full Power	6	2437	18.60	20.00	1.380	98.28	1.018	0.08	0.488	0.686

<Bluetooth SAR>

Plot No.	Band	Mode	Test Position	Gap (mm)	Headset	Power Reduction	Ch.	Freq. (MHz)	Average Power (dBm)	Tune-Up Limit (dBm)	Tune-up Scaling Factor	Duty Cycle %	Duty Cycle Scaling Factor	Power Drift (dB)	Measured 1g SAR (W/kg)	Reported 1g SAR (W/kg)
44	Bluetooth	1Mbps	Back	5mm	-	Full Power	39	2441	11.00	11.50	1.122	76.84	1.084	-0.02	0.130	0.158



<WLAN5G SAR>

Plot No.	Band	Mode	Test Position	Gap (mm)	Headset	Power Reduction	Ch.	Freq. (MHz)	Average Power (dBm)	Tune-Up Limit (dBm)	Tune-up Scaling Factor	Duty Cycle %	Duty Cycle Scaling Factor	Power Drift (dB)	Measured 1g SAR (W/kg)	Reported 1g SAR (W/kg)
	WLAN5.2GHz	802.11n-HT40 MCS0	Front	5mm	-	Reduced	38	5190	8.05	8.50	1.109	96.03	1.041	0.08	0.055	0.064
	WLAN5.2GHz	802.11n-HT40 MCS0	Back	5mm	-	Reduced	38	5190	8.05	8.50	1.109	96.03	1.041	-0.01	0.848	0.979
	WLAN5.2GHz	802.11n-HT40 MCS0	Back	5mm	-	Reduced	46	5230	7.92	8.50	1.143	96.03	1.041	0.08	0.948	1.128
	WLAN5.2GHz	802.11n-HT40 MCS0	Front	20mm	-	Full Power	46	5230	15.01	15.50	1.119	96.03	1.041	0.08	0.032	0.037
45	WLAN5.2GHz	802.11n-HT40 MCS0	Back	23mm	-	Full Power	46	5230	15.01	15.50	1.119	96.03	1.041	0.04	1.240	1.445
	WLAN5.2GHz	802.11n-HT40 MCS0	Back	23mm	-	Full Power	38	5190	12.13	12.50	1.089	96.03	1.041	0.01	0.495	0.561
	WLAN5.3GHz	802.11n-HT40 MCS0	Front	5mm	-	Reduced	54	5270	7.70	8.50	1.202	96.03	1.041	0.05	0.059	0.074
	WLAN5.3GHz	802.11n-HT40 MCS0	Back	5mm	-	Reduced	54	5270	7.70	8.50	1.202	96.03	1.041	-0.03	0.817	1.023
	WLAN5.3GHz	802.11n-HT40 MCS0	Back	5mm	-	Reduced	62	5310	7.99	8.50	1.125	96.03	1.041	-0.01	0.754	0.883
	WLAN5.3GHz	802.11n-HT40 MCS0	Front	20mm	-	Full Power	54	5270	16.47	17.00	1.131	96.03	1.041	0.05	0.021	0.025
46	WLAN5.3GHz	802.11n-HT40 MCS0	Back	23mm	-	Full Power	54	5270	16.47	17.00	1.131	96.03	1.041	0.04	1.210	1.424
	WLAN5.3GHz	802.11n-HT40 MCS0	Back	23mm	-	Full Power	62	5310	12.90	13.00	1.023	96.03	1.041	0.03	1.030	1.097
	WLAN5.5GHz	802.11n-HT40 MCS0	Front	5mm	-	Reduced	110	5550	12.06	13.00	1.242	96.03	1.041	0.08	0.049	0.063
	WLAN5.5GHz	802.11n-HT40 MCS0	Back	5mm	-	Reduced	110	5550	12.06	13.00	1.242	96.03	1.041	0.01	0.410	0.530
	WLAN5.5GHz	802.11n-HT40 MCS0	Back	5mm	-	Reduced	102	5510	12.01	13.00	1.256	96.03	1.041	-0.06	0.571	0.747
	WLAN5.5GHz	802.11n-HT40 MCS0	Front	20mm	-	Full Power	110	5550	17.82	18.50	1.169	96.03	1.041	0.08	0.026	0.032
	WLAN5.5GHz	802.11n-HT40 MCS0	Back	23mm	-	Full Power	110	5550	17.82	18.50	1.169	96.03	1.041	0.01	0.780	0.950
47	WLAN5.5GHz	802.11n-HT40 MCS0	Back	23mm	-	Full Power	142	5710	17.56	18.50	1.242	96.03	1.041	0.09	0.892	1.153
	WLAN5.8GHz	802.11n-HT40 MCS0	Front	5mm	-	Reduced	151	5755	8.38	9.00	1.153	96.03	1.041	0.03	0.071	0.085
	WLAN5.8GHz	802.11n-HT40 MCS0	Back	5mm	-	Reduced	151	5755	8.38	9.00	1.153	96.03	1.041	0.07	0.673	0.808
	WLAN5.8GHz	802.11n-HT40 MCS0	Back	5mm	-	Reduced	159	5795	8.37	9.00	1.156	96.03	1.041	0.04	0.911	1.096
	WLAN5.8GHz	802.11n-HT40 MCS0	Front	20mm	-	Full Power	151	5755	17.56	18.00	1.107	96.03	1.041	0.03	0.068	0.078
48	WLAN5.8GHz	802.11n-HT40 MCS0	Back	23mm	-	Full Power	159	5795	17.53	18.00	1.114	96.03	1.041	0.04	1.240	1.438
	WLAN5.8GHz	802.11n-HT40 MCS0	Back	23mm	-	Full Power	151	5755	17.56	18.00	1.107	96.03	1.041	0.02	1.220	1.405



15.4 Product specific 10g SAR

<GSM SAR>

Plot No.	Band	Mode	Test Position	Gap (mm)	Power Reduction	Ch.	Freq. (MHz)	Average Power (dBm)	Tune-Up Limit (dBm)	Tune-up Scaling Factor	Power Drift (dB)	Measured 10g SAR (W/kg)	Reported 10g SAR (W/kg)
49	GSM850	GPRS 2 Tx slots	Front	0mm	Full Power	189	836.4	29.11	30.50	1.377	-0.02	0.487	0.671
	GSM1900	GPRS 2 Tx slots	Front	0mm	Full Power	661	1880	26.35	27.50	1.303	0.05	2.200	2.867
50	GSM1900	GPRS 2 Tx slots	Front	0mm	Full Power	512	1850.2	26.34	27.50	1.306	0.09	2.440	3.187
	GSM1900	GPRS 2 Tx slots	Front	0mm	Full Power	810	1909.8	26.25	27.50	1.334	0.04	1.680	2.240
	GSM1900	GPRS 2 Tx slots	Back	0mm	Full Power	661	1880	26.35	27.50	1.303	0.03	2.140	2.789
	GSM1900	GPRS 2 Tx slots	Back	0mm	Full Power	512	1850.2	26.34	27.50	1.306	0.01	2.160	2.821
	GSM1900	GPRS 2 Tx slots	Back	0mm	Full Power	810	1909.8	26.25	27.50	1.334	-0.02	1.690	2.254
	GSM1900	GPRS 2 Tx slots	Bottom Side	0mm	Full Power	661	1880	26.35	27.50	1.303	0.01	1.330	1.733

<WCDMA SAR>

Plot No.	Band	Mode	Test Position	Gap (mm)	Power Reduction	Ch.	Freq. (MHz)	Average Power (dBm)	Tune-Up Limit (dBm)	Tune-up Scaling Factor	Power Drift (dB)	Measured 10g SAR (W/kg)	Reported 10g SAR (W/kg)
	WCDMA II	RMC 12.2Kbps	Front	0mm	Reduced	9400	1880	17.59	19.00	1.384	0.02	1.884	2.607
51	WCDMA II	RMC 12.2Kbps	Front	0mm	Reduced	9262	1852.4	17.58	19.00	1.387	0.07	2.210	3.065
	WCDMA II	RMC 12.2Kbps	Front	0mm	Reduced	9538	1907.6	17.23	19.00	1.503	0.05	1.622	2.438
	WCDMA II	RMC 12.2Kbps	Back	0mm	Reduced	9400	1880	17.59	19.00	1.384	-0.01	1.913	2.647
	WCDMA II	RMC 12.2Kbps	Back	0mm	Reduced	9262	1852.4	17.58	19.00	1.387	0.08	2.110	2.926
	WCDMA II	RMC 12.2Kbps	Back	0mm	Reduced	9538	1907.6	17.23	19.00	1.503	0.05	1.678	2.522
	WCDMA II	RMC 12.2Kbps	Bottom Side	0mm	Reduced	9400	1880	17.59	19.00	1.384	-0.04	1.350	1.868
	WCDMA II	RMC 12.2Kbps	Front	8mm	Full Power	9262	1852.4	22.96	24.00	1.271	0.03	1.640	2.084
	WCDMA II	RMC 12.2Kbps	Back	8mm	Full Power	9262	1852.4	22.96	24.00	1.271	-0.08	1.890	2.401
	WCDMA II	RMC 12.2Kbps	Bottom Side	13mm	Full Power	9538	1907.6	22.86	24.00	1.300	-0.1	2.140	2.782
	WCDMA II	RMC 12.2Kbps	Bottom Side	13mm	Full Power	9400	1880	23.05	24.00	1.245	-0.08	2.040	2.539
	WCDMA II	RMC 12.2Kbps	Bottom Side	13mm	Full Power	9262	1852.4	22.96	24.00	1.271	-0.08	1.940	2.465
	WCDMA IV	RMC 12.2Kbps	Front	0mm	Reduced	1413	1732.6	19.82	20.50	1.169	0.01	2.791	3.264
	WCDMA IV	RMC 12.2Kbps	Front	0mm	Reduced	1312	1712.4	19.77	20.50	1.183	0.06	2.840	3.360
	WCDMA IV	RMC 12.2Kbps	Front	0mm	Reduced	1513	1752.6	19.69	20.50	1.205	0.05	2.645	3.187
52	WCDMA IV	RMC 12.2Kbps	Back	0mm	Reduced	1413	1732.6	19.82	20.50	1.169	0.04	2.950	3.450
	WCDMA IV	RMC 12.2Kbps	Back	0mm	Reduced	1312	1712.4	19.77	20.50	1.183	0.01	2.730	3.230
	WCDMA IV	RMC 12.2Kbps	Back	0mm	Reduced	1513	1752.6	19.69	20.50	1.205	-0.06	2.660	3.205
	WCDMA IV	RMC 12.2Kbps	Bottom Side	0mm	Reduced	1413	1732.6	19.82	20.50	1.169	0.08	1.880	2.199
	WCDMA IV	RMC 12.2Kbps	Bottom Side	0mm	Reduced	1312	1712.4	19.77	20.50	1.183	0.07	2.070	2.449
	WCDMA IV	RMC 12.2Kbps	Bottom Side	0mm	Reduced	1513	1752.6	19.69	20.50	1.205	-0.05	1.740	2.097
	WCDMA IV	RMC 12.2Kbps	Front	8mm	Full Power	1312	1712.4	23.16	24.00	1.213	0.04	1.440	1.747
	WCDMA IV	RMC 12.2Kbps	Back	8mm	Full Power	1413	1732.6	23.23	24.00	1.194	-0.08	1.790	2.137
	WCDMA IV	RMC 12.2Kbps	Bottom Side	13mm	Full Power	1312	1712.4	23.16	24.00	1.213	0.09	1.600	1.941
53	WCDMA V	RMC 12.2Kbps	Front	0mm	Full Power	4182	836.4	23.29	24.00	1.178	0.09	1.290	1.519
	WCDMA V	RMC 12.2Kbps	Back	0mm	Full Power	4182	836.4	23.29	24.00	1.178	0.01	1.250	1.472



<FDD LTE SAR>

Plot No.	Band	BW (MHz)	Modulation	RB Size	RB offset	Test Position	Gap (mm)	Power Reduction	Ch.	Freq. (MHz)	Average Power (dBm)	Tune-Up Limit (dBm)	Tune-up Scaling Factor	Power Drift (dB)	Measured 10g SAR (W/kg)	Reported 10g SAR (W/kg)
	LTE Band 2	20M	QPSK	1	0	Front	0mm	Reduced	18900	1880	19.32	20.00	1.169	0.08	2.070	2.421
	LTE Band 2	20M	QPSK	1	0	Front	0mm	Reduced	18700	1860	19.23	20.00	1.194	0.09	2.250	2.686
	LTE Band 2	20M	QPSK	1	0	Front	0mm	Reduced	19100	1900	19.17	20.00	1.211	0.02	1.920	2.324
	LTE Band 2	20M	QPSK	50	0	Front	0mm	Reduced	18900	1880	19.14	20.00	1.219	0.05	2.060	2.511
	LTE Band 2	20M	QPSK	50	0	Front	0mm	Reduced	18700	1860	19.14	20.00	1.219	0.01	2.260	2.755
	LTE Band 2	20M	QPSK	50	0	Front	0mm	Reduced	19100	1900	18.97	20.00	1.268	0.06	1.820	2.307
	LTE Band 2	20M	QPSK	100	0	Front	0mm	Reduced	18900	1880	19.08	20.00	1.236	-0.05	2.040	2.521
	LTE Band 2	20M	QPSK	1	0	Back	0mm	Reduced	18900	1880	19.32	20.00	1.169	0.03	2.080	2.433
54	LTE Band 2	20M	QPSK	1	0	Back	0mm	Reduced	18700	1860	19.23	20.00	1.194	0.09	2.370	2.830
	LTE Band 2	20M	QPSK	1	0	Back	0mm	Reduced	19100	1900	19.17	20.00	1.211	-0.06	1.950	2.361
	LTE Band 2	20M	QPSK	50	0	Back	0mm	Reduced	18900	1880	19.14	20.00	1.219	0.05	2.030	2.475
	LTE Band 2	20M	QPSK	50	0	Back	0mm	Reduced	18700	1860	19.14	20.00	1.219	0.03	2.270	2.767
	LTE Band 2	20M	QPSK	50	0	Back	0mm	Reduced	19100	1900	18.97	20.00	1.268	-0.05	1.910	2.421
	LTE Band 2	20M	QPSK	100	0	Back	0mm	Reduced	18900	1880	19.08	20.00	1.236	0.04	2.060	2.546
	LTE Band 2	20M	QPSK	1	0	Bottom Side	0mm	Reduced	18900	1880	19.32	20.00	1.169	0.02	1.780	2.082
	LTE Band 2	20M	QPSK	1	0	Bottom Side	0mm	Reduced	18700	1860	19.23	20.00	1.194	-0.06	2.160	2.579
	LTE Band 2	20M	QPSK	1	0	Bottom Side	0mm	Reduced	19100	1900	19.17	20.00	1.211	0.03	1.660	2.010
	LTE Band 2	20M	QPSK	50	0	Bottom Side	0mm	Reduced	18900	1880	19.14	20.00	1.219	0.01	2.080	2.535
	LTE Band 2	20M	QPSK	50	0	Bottom Side	0mm	Reduced	18700	1860	19.14	20.00	1.219	0.05	1.950	2.377
	LTE Band 2	20M	QPSK	50	0	Bottom Side	0mm	Reduced	19100	1900	18.97	20.00	1.268	-0.03	1.920	2.434
	LTE Band 2	20M	QPSK	100	0	Bottom Side	0mm	Reduced	18900	1880	19.08	20.00	1.236	0.02	1.970	2.435
	LTE Band 2	20M	QPSK	1	0	Front	8mm	Full Power	18700	1860	23.21	24.00	1.199	0.03	1.430	1.715
	LTE Band 2	20M	QPSK	1	0	Back	8mm	Full Power	18700	1860	23.21	24.00	1.199	-0.08	1.610	1.931
	LTE Band 2	20M	QPSK	1	0	Bottom Side	13mm	Full Power	18700	1860	23.21	24.00	1.199	0.01	1.650	1.979
55	LTE Band 5	10M	QPSK	1	0	Front	0mm	Full Power	20525	836.5	23.24	24.00	1.191	0.04	2.030	2.418
	LTE Band 5	10M	QPSK	25	0	Front	0mm	Full Power	20525	836.5	22.51	23.00	1.119	-0.07	1.610	1.802
	LTE Band 5	10M	QPSK	50	0	Front	0mm	Full Power	20525	836.5	22.49	23.00	1.125	0.06	1.540	1.732
	LTE Band 5	10M	QPSK	1	0	Back	0mm	Full Power	20525	836.5	23.24	24.00	1.191	-0.08	1.550	1.846
	LTE Band 5	10M	QPSK	25	0	Back	0mm	Full Power	20525	836.5	22.51	23.00	1.119	0.01	1.210	1.355
	LTE Band 5	10M	QPSK	1	0	Bottom Side	0mm	Full Power	20525	836.5	23.24	24.00	1.191	-0.01	1.210	1.441
	LTE Band 5	10M	QPSK	25	0	Bottom Side	0mm	Full Power	20525	836.5	22.51	23.00	1.119	-0.02	0.875	0.980
56	LTE Band 14	10M	QPSK	1	0	Front	0mm	Full Power	23330	793	23.25	24.00	1.189	-0.04	1.670	1.985
	LTE Band 14	10M	QPSK	25	0	Front	0mm	Full Power	23330	793	22.53	23.00	1.114	0.08	1.110	1.237
	LTE Band 14	10M	QPSK	1	0	Back	0mm	Full Power	23330	793	23.25	24.00	1.189	0.09	1.540	1.830
	LTE Band 14	10M	QPSK	25	0	Back	0mm	Full Power	23330	793	22.53	23.00	1.114	0.05	1.120	1.248
57	LTE Band 30	10M	QPSK	1	0	Front	0mm	Reduced	27710	2310	21.83	22.50	1.167	0.09	2.800	3.267
	LTE Band 30	10M	QPSK	25	0	Front	0mm	Reduced	27710	2310	21.47	22.50	1.268	0.04	2.540	3.220
	LTE Band 30	10M	QPSK	50	0	Front	0mm	Reduced	27710	2310	21.61	22.50	1.227	-0.05	2.613	3.207
	LTE Band 30	10M	QPSK	1	0	Back	0mm	Reduced	27710	2310	21.83	22.50	1.167	0.02	2.789	3.254
	LTE Band 30	10M	QPSK	25	0	Back	0mm	Reduced	27710	2310	21.47	22.50	1.268	0.02	2.457	3.115
	LTE Band 30	10M	QPSK	50	0	Back	0mm	Reduced	27710	2310	21.61	22.50	1.227	0.02	2.610	3.204
	LTE Band 30	10M	QPSK	1	0	Left Side	0mm	Reduced	27710	2310	21.83	22.50	1.167	0.03	2.510	2.929
	LTE Band 30	10M	QPSK	25	0	Left Side	0mm	Reduced	27710	2310	21.47	22.50	1.268	-0.05	2.320	2.941
	LTE Band 30	10M	QPSK	50	0	Left Side	0mm	Reduced	27710	2310	21.61	22.50	1.227	-0.05	2.470	3.032
	LTE Band 30	10M	QPSK	1	0	Bottom Side	0mm	Reduced	27710	2310	21.83	22.50	1.167	0.07	2.060	2.404
	LTE Band 30	10M	QPSK	25	0	Bottom Side	0mm	Reduced	27710	2310	21.47	22.50	1.268	0.05	2.010	2.548
	LTE Band 30	10M	QPSK	50	0	Bottom Side	0mm	Reduced	27710	2310	21.61	22.50	1.227	0.05	2.020	2.479
	LTE Band 30	10M	QPSK	1	0	Front	7mm	Full Power	27710	2310	23.24	24.00	1.191	-0.12	0.569	0.678
	LTE Band 30	10M	QPSK	1	0	Back	6mm	Full Power	27710	2310	23.24	24.00	1.191	0.18	0.544	0.648
	LTE Band 30	10M	QPSK	1	0	Left Side	10mm	Full Power	27710	2310	23.24	24.00	1.191	0.03	0.415	0.494
	LTE Band 30	10M	QPSK	1	0	Bottom Side	9mm	Full Power	27710	2310	23.24	24.00	1.191	-0.01	0.264	0.314



Plot No.	Band	BW (MHz)	Modulation	RB Size	RB offset	Test Position	Gap (mm)	Power Reduction	Ch.	Freq. (MHz)	Average Power (dBm)	Tune-Up Limit (dBm)	Tune-up Scaling Factor	Power Drift (dB)	Measured 10g SAR (W/kg)	Reported 10g SAR (W/kg)
	LTE Band 66	20M	QPSK	1	0	Front	0mm	Reduced	132322	1745	19.33	20.00	1.167	0.09	2.820	3.290
	LTE Band 66	20M	QPSK	1	0	Front	0mm	Reduced	132072	1720	19.26	20.00	1.186	0.07	2.600	3.083
	LTE Band 66	20M	QPSK	1	0	Front	0mm	Reduced	132572	1770	19.27	20.00	1.183	0.05	2.750	3.253
58	LTE Band 66	20M	QPSK	50	0	Front	0mm	Reduced	132322	1745	19.22	20.00	1.197	0.09	2.930	3.506
	LTE Band 66	20M	QPSK	50	0	Front	0mm	Reduced	132072	1720	19.14	20.00	1.219	0.01	2.780	3.389
	LTE Band 66	20M	QPSK	50	0	Front	0mm	Reduced	132572	1770	19.11	20.00	1.227	0.01	2.790	3.425
	LTE Band 66	20M	QPSK	100	0	Front	0mm	Reduced	132322	1745	19.32	20.00	1.169	0.07	2.890	3.380
	LTE Band 66	20M	QPSK	1	0	Back	0mm	Reduced	132322	1745	19.33	20.00	1.167	0.01	2.500	2.917
	LTE Band 66	20M	QPSK	1	0	Back	0mm	Reduced	132072	1720	19.26	20.00	1.186	0.02	2.420	2.870
	LTE Band 66	20M	QPSK	1	0	Back	0mm	Reduced	132572	1770	19.27	20.00	1.183	-0.05	2.330	2.756
	LTE Band 66	20M	QPSK	50	0	Back	0mm	Reduced	132322	1745	19.22	20.00	1.197	0.07	2.540	3.040
	LTE Band 66	20M	QPSK	50	0	Back	0mm	Reduced	132072	1720	19.14	20.00	1.219	0.07	2.490	3.035
	LTE Band 66	20M	QPSK	50	0	Back	0mm	Reduced	132572	1770	19.11	20.00	1.227	-0.05	2.360	2.897
	LTE Band 66	20M	QPSK	100	0	Back	0mm	Reduced	132322	1745	19.32	20.00	1.169	0.08	2.520	2.947
	LTE Band 66	20M	QPSK	1	0	Bottom Side	0mm	Reduced	132322	1745	19.33	20.00	1.167	-0.05	1.870	2.182
	LTE Band 66	20M	QPSK	1	0	Bottom Side	0mm	Reduced	132072	1720	19.26	20.00	1.186	-0.01	2.010	2.383
	LTE Band 66	20M	QPSK	1	0	Bottom Side	0mm	Reduced	132572	1770	19.27	20.00	1.183	-0.07	1.720	2.035
	LTE Band 66	20M	QPSK	50	0	Bottom Side	0mm	Reduced	132322	1745	19.22	20.00	1.197	-0.03	1.900	2.274
	LTE Band 66	20M	QPSK	50	0	Bottom Side	0mm	Reduced	132072	1720	19.14	20.00	1.219	-0.15	2.060	2.511
	LTE Band 66	20M	QPSK	50	0	Bottom Side	0mm	Reduced	132572	1770	19.11	20.00	1.227	-0.03	1.730	2.123
	LTE Band 66	20M	QPSK	100	0	Bottom Side	0mm	Reduced	132322	1745	19.32	20.00	1.169	-0.05	1.860	2.175
	LTE Band 66	20M	QPSK	1	0	Front	8mm	Full Power	132322	1745	23.36	24.00	1.159	0.03	1.480	1.715
	LTE Band 66	20M	QPSK	1	0	Back	8mm	Full Power	132322	1745	23.36	24.00	1.159	0.05	1.530	1.773
	LTE Band 66	20M	QPSK	1	0	Bottom Side	13mm	Full Power	132072	1720	23.29	24.00	1.178	0.08	1.520	1.790

<WLAN5G SAR>

Plot No.	Band	Mode	Test Position	Gap (mm)	Power Reduction	Ch.	Freq. (MHz)	Average Power (dBm)	Tune-Up Limit (dBm)	Tune-up Scaling Factor	Duty Cycle %	Duty Cycle Scaling Factor	Power Drift (dB)	Measured 10g SAR (W/kg)	Reported 10g SAR (W/kg)
59	WLAN5.2GHz	802.11n-HT40 MCS0	Back	0mm	Full Power	46	5230	15.01	15.50	1.119	96.03	1.041	0.03	2.170	2.529
	WLAN5.2GHz	802.11n-HT40 MCS0	Back	0mm	Full Power	38	5190	12.13	12.50	1.089	96.03	1.041	0.01	0.864	0.979
	WLAN5.2GHz	802.11n-HT40 MCS0	Back	0mm	Reduced-Simultaneous	46	5230	14.12	14.50	1.091	96.03	1.041	0.01	1.780	2.022
	WLAN5.3GHz	802.11n-HT40 MCS0	Front	0mm	Full Power	54	5270	16.47	17.00	1.131	96.03	1.041	0.03	0.047	0.055
60	WLAN5.3GHz	802.11n-HT40 MCS0	Back	0mm	Full Power	54	5270	16.47	17.00	1.131	96.03	1.041	0.03	2.620	3.084
	WLAN5.3GHz	802.11n-HT40 MCS0	Back	0mm	Full Power	62	5310	12.90	13.00	1.023	96.03	1.041	0.05	0.657	0.700
	WLAN5.3GHz	802.11n-HT40 MCS0	Left Side	0mm	Full Power	54	5270	16.47	17.00	1.131	96.03	1.041	0.01	0.028	0.033
	WLAN5.3GHz	802.11n-HT40 MCS0	Right Side	0mm	Full Power	54	5270	16.47	17.00	1.131	96.03	1.041	0.05	0.371	0.437
	WLAN5.3GHz	802.11n-HT40 MCS0	Top Side	0mm	Full Power	54	5270	16.47	17.00	1.131	96.03	1.041	-0.08	0.066	0.077
	WLAN5.3GHz	802.11n-HT40 MCS0	Back	0mm	Reduced-Simultaneous	54	5270	14.92	16.00	1.282	96.03	1.041	-0.09	1.560	2.082
	WLAN5.5GHz	802.11n-HT40 MCS0	Front	0mm	Full Power	110	5550	17.82	18.50	1.169	96.03	1.041	0.02	0.017	0.021
	WLAN5.5GHz	802.11n-HT40 MCS0	Back	0mm	Full Power	110	5550	17.82	18.50	1.169	96.03	1.041	-0.08	1.650	2.009
	WLAN5.5GHz	802.11n-HT40 MCS0	Left Side	0mm	Full Power	110	5550	17.82	18.50	1.169	96.03	1.041	-0.02	0.023	0.028
	WLAN5.5GHz	802.11n-HT40 MCS0	Right Side	0mm	Full Power	110	5550	17.82	18.50	1.169	96.03	1.041	0.05	0.160	0.195
	WLAN5.5GHz	802.11n-HT40 MCS0	Top Side	0mm	Full Power	110	5550	17.82	18.50	1.169	96.03	1.041	0.04	0.038	0.046
61	WLAN5.5GHz	802.11n-HT40 MCS0	Back	0mm	Full Power	142	5710	17.56	18.50	1.242	96.03	1.041	-0.01	2.030	2.624
	WLAN5.5GHz	802.11n-HT40 MCS0	Back	0mm	Reduced-Simultaneous	142	5710	16.54	17.50	1.247	96.03	1.041	0.08	1.380	1.792
	WLAN5.8GHz	802.11n-HT40 MCS0	Back	0mm	Full Power	151	5755	17.56	18.00	1.107	96.03	1.041	0.01	2.280	2.627
62	WLAN5.8GHz	802.11n-HT40 MCS0	Back	0mm	Full Power	159	5795	17.53	18.00	1.114	96.03	1.041	-0.08	2.690	3.120
	WLAN5.8GHz	802.11n-HT40 MCS0	Back	0mm	Reduced-Simultaneous	159	5795	15.58	16.00	1.102	96.03	1.041	0.08	1.470	1.686



15.5 Repeated SAR Measurement

<1g>

No.	Band	BW (MHz)	Modulation	RB Size	RB offset	Mode	Test Position	Gap (mm)	Power Reduction	Ch.	Freq. (MHz)	Average Power (dBm)	Tune-Up Limit (dBm)	Tune-up Scaling Factor	Duty Cycle %	Duty Cycle Scaling Factor	Power Drift (dB)	Measured 1g SAR (W/kg)	Ratio	Reported 1g SAR (W/kg)
1st	LTE Band 2	20M	QPSK	1	0	-	Bottom Side	5mm	Reduced	19100	1900	13.00	14.00	1.259	-	-	-0.09	1.090	1	1.372
2nd	LTE Band 2	20M	QPSK	1	0	-	Bottom Side	5mm	Reduced	19100	1900	13.00	14.00	1.259	-	-	-0.02	1.040	1.048	1.309
1st	LTE Band 5	10M	QPSK	1	0	-	Front	5mm	Reduced	20525	836.5	22.44	23.00	1.138	-	-	-0.13	1.120	1	1.274
2nd	LTE Band 5	10M	QPSK	1	0	-	Front	5mm	Reduced	20525	836.5	22.44	23.00	1.138	-	-	-0.02	1.060	1.057	1.206
1st	LTE Band 14	10M	QPSK	1	0	-	Back	5mm	Full Power	23330	793	23.25	24.00	1.189	-	-	-0.15	1.210	1	1.438
2nd	LTE Band 14	10M	QPSK	1	0	-	Back	5mm	Full Power	23330	793	23.25	24.00	1.189	-	-	-0.03	1.140	1.061	1.355
1st	LTE Band 30	10M	QPSK	1	0	-	Back	5mm	Reduced	27710	2310	20.15	21.00	1.216	-	-	-0.11	1.180	1	1.435
2nd	LTE Band 30	10M	QPSK	1	0	-	Back	5mm	Reduced	27710	2310	20.15	21.00	1.216	-	-	-0.02	1.120	1.054	1.362
1st	LTE Band 66	20M	QPSK	50	0	-	Bottom Side	5mm	Reduced	132572	1770	13.86	14.50	1.159	-	-	-0.17	1.220	1	1.414
2nd	LTE Band 66	20M	QPSK	50	0	-	Bottom Side	5mm	Reduced	132572	1770	13.86	14.50	1.159	-	-	-0.02	1.170	1.043	1.356
1st	WLAN2.4GHz	-	-	-	-	802.11b 1Mbps	Top Side	5mm	Full Power	11	2462	18.70	20.00	1.349	98.28	1.018	-0.16	0.856	1	1.175
2nd	WLAN2.4GHz	-	-	-	-	802.11b 1Mbps	Top Side	5mm	Full Power	11	2462	18.70	20.00	1.349	98.28	1.018	-0.03	0.834	1.026	1.145
1st	WLAN5.2GHz	-	-	-	-	802.11n-HT40 MCS0	Back	23mm	Full Power	46	5230	15.01	15.50	1.119	96.03	1.041	0.04	1.240	1	1.445
2nd	WLAN5.2GHz	-	-	-	-	802.11n-HT40 MCS0	Back	23mm	Full Power	46	5230	15.01	15.50	1.119	96.03	1.041	0.05	1.190	1.042	1.387

<10g>

No.	Band	BW (MHz)	Modulation	RB Size	RB offset	Mode	Test Position	Gap (mm)	Power Reduction	Ch.	Freq. (MHz)	Average Power (dBm)	Tune-Up Limit (dBm)	Tune-up Scaling Factor	Duty Cycle %	Duty Cycle Scaling Factor	Power Drift (dB)	Measured 10g SAR (W/kg)	Ratio	Reported 10g SAR (W/kg)
1st	GSM1900	-	-	-	-	GPRS 2 Tx slots	Front	0mm	Full Power	512	1850.2	26.34	27.50	1.306	-	-	0.09	2.440	1	3.187
2nd	GSM1900	-	-	-	-	GPRS 2 Tx slots	Front	0mm	Full Power	512	1850.2	26.34	27.50	1.306	-	-	-0.02	2.410	1.012	3.148
1st	WCDMA IV	-	-	-	-	RMC 12.2Kbps	Back	0mm	Reduced	1413	1732.6	19.82	20.50	1.169	-	-	0.04	2.950	1	3.450
2nd	WCDMA IV	-	-	-	-	RMC 12.2Kbps	Back	0mm	Reduced	1413	1732.6	19.82	20.50	1.169	-	-	0.01	2.910	1.014	3.403
1st	LTE Band 5	10M	QPSK	1	0	-	Front	0mm	Full Power	20525	836.5	23.24	24.00	1.191	-	-	0.04	2.030	1	2.418
2nd	LTE Band 5	10M	QPSK	1	0	-	Front	0mm	Full Power	20525	836.5	23.24	24.00	1.191	-	-	0.02	1.980	1.025	2.359
1st	LTE Band 30	10M	QPSK	1	0	-	Front	0mm	Reduced	27710	2310	21.83	22.50	1.167	-	-	0.09	2.800	1	3.267
2nd	LTE Band 30	10M	QPSK	1	0	-	Front	0mm	Reduced	27710	2310	21.83	22.50	1.167	-	-	-0.03	2.760	1.014	3.220
1st	WLAN5.8GHz	-	-	-	-	802.11n-HT40 MCS0	Back	0mm	Full Power	159	5795	17.53	18.00	1.114	96.03	1.041	-0.08	2.690	1	3.120
2nd	WLAN5.8GHz	-	-	-	-	802.11n-HT40 MCS0	Back	0mm	Full Power	159	5795	17.53	18.00	1.114	96.03	1.041	-0.04	2.640	1.019	3.062

General Note:

- Per KDB 865664 D01v01r04, for each frequency band, repeated SAR measurement is required only when the measured SAR is $\geq 0.8W/kg$.
- Per KDB 865664 D01v01r04, if the ratio among the repeated measurement is ≤ 1.2 and the measured SAR $< 1.45W/kg$, only one repeated measurement is required.
- Per KDB 865664 D01v01r04, if the extremity repeated SAR is necessary, the same procedures should be adapted for measurements according to extremity and occupational exposure limits by applying a factor of 2.5 for extremity exposure and a factor of 5 for occupational exposure to the corresponding SAR thresholds.
- The ratio is the difference in percentage between original and repeated *measured SAR*.
- All measurement SAR result is scaled-up to account for tune-up tolerance and is compliant.



16. Simultaneous Transmission Analysis

No.	Simultaneous Transmission Configurations	Portable Handset			
		Head	Body-worn	Hotspot	Product specific 10g SAR
1.	GSM Voice + WLAN2.4GHz	Yes	Yes		Yes
2.	GPRS/EDGE + WLAN2.4GHz	Yes	Yes	Yes	Yes
3.	WCDMA + WLAN2.4GHz	Yes	Yes	Yes	Yes
4.	LTE + WLAN2.4GHz	Yes	Yes	Yes	Yes
5.	GSM Voice + WLAN5.3/5.5GHz	Yes	Yes		Yes
6.	GPRS/EDGE + WLAN5.3/5.5GHz	Yes	Yes		Yes
7.	WCDMA + WLAN5.3/5.5GHz	Yes	Yes		Yes
8.	LTE + WLAN5.3/5.5GHz	Yes	Yes		Yes
9.	GSM Voice + WLAN5.2/5.8GHz	Yes	Yes		Yes
10.	GPRS/EDGE + WLAN5.2/5.8GHz	Yes	Yes	Yes	Yes
11.	WCDMA + WLAN5.2/5.8GHz	Yes	Yes	Yes	Yes
12.	LTE + WLAN5.2/5.8GHz	Yes	Yes	Yes	Yes
13.	GSM Voice + Bluetooth	Yes	Yes		Yes
14.	GPRS/EDGE + Bluetooth	Yes	Yes	Yes	Yes
15.	WCDMA + Bluetooth	Yes	Yes	Yes	Yes
16.	LTE + Bluetooth	Yes	Yes	Yes	Yes

General Note:

- This device supports VoIP in GPRS, EGPRS, WCDMA and LTE (e.g. for 3rd-party VoIP), LTE supports VoLTE operation.
- EUT will choose each GSM, WCDMA and LTE according to the network signal condition; therefore, they will not operate simultaneously at any moment.
- This device 2.4GHz WLAN support hotspot operation and Bluetooth support tethering applications.
- This device 2.4GHz WLAN/ 5.2GHz WLAN/5.8GHz WLAN support hotspot operation, and 5.2GHz WLAN/5.8GHz WLAN supports WLAN Direct (GC/GO), and 5.3GHz / 5.5GHz supports WLAN Direct (GC only).
- EUT will choose either WLAN 2.4GHz or WLAN 5GHz according to the network signal condition; therefore, 2.4GHz WLAN and 5GHz WLAN will not operate simultaneously at any moment though they have independent antenna.
- WLAN 2.4GHz and Bluetooth share the same antenna so can't transmit simultaneously.
- According to the EUT character, WLAN 5GHz and Bluetooth can't transmit simultaneously.
- Chose the worst zoom scan SAR of WLAN correspondingly for co-located with WWAN analysis.
- The reported SAR summation is calculated based on the same configuration and test position.
- Per KDB 447498 D01v06, simultaneous transmission SAR is compliant if,
 - 1g Scalar SAR summation < 1.6W/kg and 10g Scalar SAR summation < 4.0W/kg.
 - $SPLSR = (SAR1 + SAR2)^{1.5} / (\text{min. separation distance, mm})$, and the peak separation distance is determined from the square root of $[(x1-x2)^2 + (y1-y2)^2 + (z1-z2)^2]$, where (x1, y1, z1) and (x2, y2, z2) are the coordinates of the extrapolated peak SAR locations in the zoom scan.
 - If $SPLSR \leq 0.04$ for 1g SAR and $SPLSR \leq 0.10$ for 10g SAR, simultaneously transmission SAR measurement is not necessary.
 - Simultaneously transmission SAR measurement, and the reported multi-band 1g SAR < 1.6W/kg and 10g SAR < 4.0W/kg.
 - The SPLSR calculated results please refer to section 16.5.



16.1 Head Exposure Conditions

WWAN Band		Exposure Position	1	2	3	4	1+2	1+3	1+4
			WWAN	2.4GHz WLAN	5GHz WLAN	Bluetooth	Summed	Summed	Summed
			1g SAR (W/kg)	1g SAR (W/kg)	1g SAR (W/kg)	1g SAR (W/kg)	1g SAR (W/kg)	1g SAR (W/kg)	1g SAR (W/kg)
GSM	GSM850	Right Cheek	0.488	0.312	0.098	0.324	0.80	0.59	0.81
		Right Tilted	0.207	0.370	0.089	0.324	0.58	0.30	0.53
		Left Cheek	0.263	0.682	0.159	0.324	0.95	0.42	0.59
		Left Tilted	0.191	0.440	0.088	0.324	0.63	0.28	0.52
	GSM1900	Right Cheek	0.051	0.312	0.098	0.324	0.36	0.15	0.38
		Right Tilted	0.014	0.370	0.089	0.324	0.38	0.10	0.34
		Left Cheek	0.032	0.682	0.159	0.324	0.71	0.19	0.36
		Left Tilted	0.022	0.440	0.088	0.324	0.46	0.11	0.35
WCDMA	WCDMA II	Right Cheek	0.223	0.312	0.098	0.324	0.54	0.32	0.55
		Right Tilted	0.085	0.370	0.089	0.324	0.46	0.17	0.41
		Left Cheek	0.093	0.682	0.159	0.324	0.78	0.25	0.42
		Left Tilted	0.072	0.440	0.088	0.324	0.51	0.16	0.40
	WCDMA IV	Right Cheek	0.130	0.312	0.098	0.324	0.44	0.23	0.45
		Right Tilted	0.096	0.370	0.089	0.324	0.47	0.19	0.42
		Left Cheek	0.211	0.682	0.159	0.324	0.89	0.37	0.54
		Left Tilted	0.087	0.440	0.088	0.324	0.53	0.18	0.41
	WCDMA V	Right Cheek	0.643	0.312	0.098	0.324	0.96	0.74	0.97
		Right Tilted	0.305	0.370	0.089	0.324	0.68	0.39	0.63
		Left Cheek	0.405	0.682	0.159	0.324	1.09	0.56	0.73
		Left Tilted	0.279	0.440	0.088	0.324	0.72	0.37	0.60
LTE	LTE Band 2	Right Cheek	0.130	0.312	0.098	0.324	0.44	0.23	0.45
		Right Tilted	0.071	0.370	0.089	0.324	0.44	0.16	0.40
		Left Cheek	0.070	0.682	0.159	0.324	0.75	0.23	0.39
		Left Tilted	0.095	0.440	0.088	0.324	0.54	0.18	0.42
	LTE Band 5	Right Cheek	0.454	0.312	0.098	0.324	0.77	0.55	0.78
		Right Tilted	0.264	0.370	0.089	0.324	0.63	0.35	0.59
		Left Cheek	0.361	0.682	0.159	0.324	1.04	0.52	0.69
		Left Tilted	0.236	0.440	0.088	0.324	0.68	0.32	0.56
	LTE Band 12	Right Cheek	0.438	0.312	0.098	0.324	0.75	0.54	0.76
		Right Tilted	0.231	0.370	0.089	0.324	0.60	0.32	0.56
		Left Cheek	0.321	0.682	0.159	0.324	1.00	0.48	0.65
		Left Tilted	0.185	0.440	0.088	0.324	0.63	0.27	0.51
	LTE Band 14	Right Cheek	0.475	0.312	0.098	0.324	0.79	0.57	0.80
		Right Tilted	0.250	0.370	0.089	0.324	0.62	0.34	0.57
		Left Cheek	0.313	0.682	0.159	0.324	1.00	0.47	0.64
		Left Tilted	0.198	0.440	0.088	0.324	0.64	0.29	0.52
	LTE Band 30	Right Cheek	0.340	0.312	0.098	0.324	0.65	0.44	0.66
		Right Tilted	0.264	0.370	0.089	0.324	0.63	0.35	0.59



FCC SAR Test Report

Report No. : FA080709-01

		Left Cheek	0.592	0.682	0.159	0.324	1.27	0.75	0.92
		Left Tilted	0.162	0.440	0.088	0.324	0.60	0.25	0.49
	LTE Band 66	Right Cheek	0.139	0.312	0.098	0.324	0.45	0.24	0.46
		Right Tilted	0.104	0.370	0.089	0.324	0.47	0.19	0.43
		Left Cheek	0.173	0.682	0.159	0.324	0.86	0.33	0.50
		Left Tilted	0.143	0.440	0.088	0.324	0.58	0.23	0.47



16.2 Hotspot Exposure Conditions

WWAN Band	Exposure Position	1	2	3	4	1+2	Case No	SPLSR	1+3	Case No	SPLSR	1+4 Summed 1g SAR (W/kg)	Case No	SPLSR	
		WWAN	2.4GHz WLAN	5GHz WLAN	Bluetooth	Summed			Summed						
		1g SAR (W/kg)	1g SAR (W/kg)	1g SAR (W/kg)	1g SAR (W/kg)	1g SAR (W/kg)			1g SAR (W/kg)						
GSM	GSM850	Front	1.282	0.589	0.085	0.180	1.87	#01	0.02	1.37			1.46		
		Back	1.131	0.805	1.128	0.158	1.94	#02	0.02	2.26	#03	0.03	1.29		
		Left side	0.398	0.158	0.088	0.180	0.56			0.49			0.58		
		Right side	0.724	0.367	0.140	0.180	1.09			0.86			0.90		
		Top side		1.175	0.146	0.180	1.18			0.15			0.18		
		Bottom side	1.009				1.01			1.01			1.01		
	GSM1900	Front	1.273	0.589	0.085	0.180	1.86	#04	0.02	1.36			1.45		
		Back	1.166	0.805	1.128	0.158	1.97	#05	0.02	2.29	#06	0.03	1.32		
		Left side	0.001	0.158	0.088	0.180	0.16			0.09			0.18		
		Right side	0.058	0.367	0.140	0.180	0.43			0.20			0.24		
		Top side		1.175	0.146	0.180	1.18			0.15			0.18		
		Bottom side	1.234				1.23			1.23			1.23		
WCDMA	WCDMA II	Front	1.223	0.589	0.085	0.180	1.81	#07	0.01	1.31			1.40		
		Back	1.112	0.805	1.128	0.158	1.92	#08	0.02	2.24	#09	0.03	1.27		
		Left side	0.029	0.158	0.088	0.180	0.19			0.12			0.21		
		Right side	0.001	0.367	0.140	0.180	0.37			0.14			0.18		
		Top side		1.175	0.146	0.180	1.18			0.15			0.18		
		Bottom side	1.384				1.38			1.38			1.38		
	WCDMA IV	Front	1.329	0.589	0.085	0.180	1.92	#10	0.02	1.41			1.51		
		Back	1.178	0.805	1.128	0.158	1.98	#11	0.02	2.31	#12	0.03	1.34		
		Left side	0.050	0.158	0.088	0.180	0.21			0.14			0.23		
		Right side	0.005	0.367	0.140	0.180	0.37			0.15			0.19		
		Top side		1.175	0.146	0.180	1.18			0.15			0.18		
		Bottom side	1.367				1.37			1.37			1.37		
	WCDMA V	Front	1.213	0.589	0.085	0.180	1.80	#13	0.01	1.30			1.39		
		Back	0.992	0.805	1.128	0.158	1.80	#14	0.02	2.12	#15	0.02	1.15		
		Left side	0.240	0.158	0.088	0.180	0.40			0.33			0.42		
		Right side	0.484	0.367	0.140	0.180	0.85			0.62			0.66		
		Top side		1.175	0.146	0.180	1.18			0.15			0.18		
		Bottom side	0.632				0.63			0.63			0.63		
LTE	LTE Band 2	Front	1.181	0.589	0.085	0.180	1.77	#16	0.01	1.27			1.36		
		Back	1.066	0.805	1.128	0.158	1.87	#17	0.02	2.19	#18	0.03	1.22		
		Left side	0.042	0.158	0.088	0.180	0.20			0.13			0.22		
		Right side	0.031	0.367	0.140	0.180	0.40			0.17			0.21		
		Top side		1.175	0.146	0.180	1.18			0.15			0.18		
		Bottom side	1.372				1.37			1.37			1.37		



FCC SAR Test Report

Report No. : FA080709-01

	LTE Band 5	Front	1.274	0.589	0.085	0.180	1.86	#19	0.02	1.36			1.45		
		Back	1.127	0.805	1.128	0.158	1.93	#20	0.02	2.26	#21	0.03	1.29		
		Left side	0.300	0.158	0.088	0.180	0.46			0.39			0.48		
		Right side	0.516	0.367	0.140	0.180	0.88			0.66			0.70		
		Top side		1.175	0.146	0.180	1.18			0.15			0.18		
		Bottom side	1.081				1.08			1.08			1.08		
	LTE Band 12	Front	1.076	0.589	0.085	0.180	1.67	#22	0.01	1.16			1.26		
		Back	1.000	0.805	1.128	0.158	1.81	#23	0.02	2.13	#24	0.03	1.16		
		Left side	0.562	0.158	0.088	0.180	0.72			0.65			0.74		
		Right side	0.836	0.367	0.140	0.180	1.20			0.98			1.02		
		Top side		1.175	0.146	0.180	1.18			0.15			0.18		
		Bottom side	0.751				0.75			0.75			0.75		
	LTE Band 14	Front	1.343	0.589	0.085	0.180	1.93	#25	0.02	1.43			1.52		
		Back	1.438	0.805	1.128	0.158	2.24	#26	0.02	2.57	#27	0.03	1.60	#48	0.01
		Left side	0.456	0.158	0.088	0.180	0.61			0.54			0.64		
		Right side	0.756	0.367	0.140	0.180	1.12			0.90			0.94		
		Top side		1.175	0.146	0.180	1.18			0.15			0.18		
		Bottom side	1.143				1.14			1.14			1.14		
	LTE Band 30	Front	1.132	0.589	0.085	0.180	1.72	#28	0.02	1.22			1.31		
		Back	1.435	0.805	1.128	0.158	2.24	#29	0.02	2.56	#30	0.03	1.59		
		Left side	1.058	0.158	0.088	0.180	1.22			1.15			1.24		
		Right side	0.077	0.367	0.140	0.180	0.44			0.22			0.26		
		Top side		1.175	0.146	0.180	1.18			0.15			0.18		
		Bottom side	0.816				0.82			0.82			0.82		
LTE Band 66	Front	1.319	0.589	0.085	0.180	1.91	#31	0.02	1.40			1.50			
	Back	1.260	0.805	1.128	0.158	2.07	#32	0.02	2.39	#33	0.03	1.42			
	Left side	0.052	0.158	0.088	0.180	0.21			0.14			0.23			
	Right side	0.047	0.367	0.140	0.180	0.41			0.19			0.23			
	Top side		1.175	0.146	0.180	1.18			0.15			0.18			
	Bottom side	1.414				1.41			1.41			1.41			



16.3 Body-Worn Accessory Exposure Conditions

WWAN Band	Exposure Position	1	2	3	4	1+2	Case No	SPLSR	1+3	Case No	SPLSR	1+4	Case No	SPLSR	
		WWAN	2.4GHz WLAN	5GHz WLAN	Bluetooth	Summed			Summed			Summed			
		1g SAR (W/kg)	1g SAR (W/kg)	1g SAR (W/kg)	1g SAR (W/kg)	1g SAR (W/kg)			1g SAR (W/kg)			1g SAR (W/kg)			
GSM	GSM850	Front	1.282	0.589	0.085	0.158	1.87	#01	0.02	1.37			1.44		
		Back	1.131	0.805	1.128	0.158	1.94	#02	0.02	2.26	#03	0.03	1.29		
		Front with Headset	1.230				1.23			1.23			1.23		
		Back with Headset					0.00			0.00			0.00		
	GSM1900	Front	1.273	0.589	0.085	0.158	1.86	#04	0.02	1.36			1.43		
		Back	1.166	0.805	1.128	0.158	1.97	#05	0.02	2.29	#06	0.03	1.32		
		Front with Headset	1.263				1.26			1.26			1.26		
		Back with Headset					0.00			0.00			0.00		
WCDMA	WCDMA II	Front	1.223	0.589	0.085	0.158	1.81	#07	0.01	1.31			1.38		
		Back	1.112	0.805	1.128	0.158	1.92	#08	0.02	2.24	#09	0.03	1.27		
		Front with Headset	1.179				1.18			1.18			1.18		
		Back with Headset					0.00			0.00			0.00		
	WCDMA IV	Front	1.329	0.589	0.085	0.158	1.92	#10	0.02	1.41			1.49		
		Back	1.178	0.805	1.128	0.158	1.98	#11	0.02	2.31	#12	0.03	1.34		
		Front with Headset	1.304				1.30			1.30			1.30		
		Back with Headset					0.00			0.00			0.00		
	WCDMA V	Front	1.213	0.589	0.085	0.158	1.80	#13	0.01	1.30			1.37		
		Back	0.992	0.805	1.128	0.158	1.80	#14	0.02	2.12	#15	0.02	1.15		
		Front with Headset	1.188				1.19			1.19			1.19		
		Back with Headset					0.00			0.00			0.00		
LTE	LTE Band 2	Front	1.181	0.589	0.085	0.158	1.77	#16	0.01	1.27			1.34		
		Back	1.066	0.805	1.128	0.158	1.87	#17	0.02	2.19	#18	0.03	1.22		
		Front with Headset					0.00			0.00			0.00		
		Back with Headset					0.00			0.00			0.00		
	LTE Band 5	Front	1.274	0.589	0.085	0.158	1.86	#19	0.02	1.36			1.43		
		Back	1.127	0.805	1.128	0.158	1.93	#20	0.02	2.26	#21	0.03	1.29		
		Front with Headset	1.263				1.26			1.26			1.26		
		Back with Headset					0.00			0.00			0.00		
	LTE Band 12	Front	1.076	0.589	0.085	0.158	1.67	#22	0.01	1.16			1.23		
		Back	1.000	0.805	1.128	0.158	1.81	#23	0.02	2.13	#24	0.03	1.16		
		Front with Headset					0.00			0.00			0.00		
		Back with Headset					0.00			0.00			0.00		
	LTE Band 14	Front	1.343	0.589	0.085	0.158	1.93	#25	0.02	1.43			1.50		
		Back	1.438	0.805	1.128	0.158	2.24	#26	0.02	2.57	#27	0.03	1.60	#48	0.01
		Front with Headset					0.00			0.00			0.00		
		Back with Headset	1.307				1.31			1.31			1.31		



FCC SAR Test Report

Report No. : FA080709-01

	LTE Band 30	Front	1.132	0.589	0.085	0.158	1.72	#28	0.02	1.22			1.29		
		Back	1.435	0.805	1.128	0.158	2.24	#29	0.02	2.56	#30	0.03	1.59		
		Front with Headset					0.00			0.00			0.00		
		Back with Headset	1.241				1.24			1.24			1.24		
	LTE Band 66	Front	1.319	0.589	0.085	0.158	1.91	#31	0.02	1.40			1.48		
		Back	1.260	0.805	1.128	0.158	2.07	#32	0.02	2.39	#33	0.03	1.42		
		Front with Headset	1.426				1.43			1.43			1.43		
		Back with Headset					0.00			0.00			0.00		



WWAN Band		Exposure Position	1	3	1+3	Case No	SPLSR
			WWAN	5GHz WLAN	Summed		
			1g SAR (W/kg)	1g SAR (W/kg)	1g SAR (W/kg)		
GSM	GSM1900	Front at 20mm	0.335	0.078	0.41		
		Back at 23mm	0.366	1.445	1.81	#40	0.02
WCDMA	WCDMA II	Front at 20mm	1.001	0.078	1.08		
		Back at 23mm	0.798	1.445	2.24	#41	0.03
	WCDMA IV	Front at 20mm	0.910	0.078	0.99		
		Back at 23mm	0.715	1.445	2.16	#42	0.02
	WCDMA V	Front at 20mm	0.260	0.078	0.34		
		Back at 23mm	0.354	1.445	1.80	#43	0.02
LTE	LTE Band 2	Front at 20mm	0.819	0.078	0.90		
		Back at 23mm	0.451	1.445	1.90	#44	0.02
	LTE Band 5	Front at 20mm	0.349	0.078	0.43		
		Back at 23mm	0.275	1.445	1.72	#45	0.02
	LTE Band 30	Front at 20mm	0.287	0.078	0.37		
		Back at 23mm	0.189	1.445	1.63	#46	0.02
	LTE Band 66	Front at 20mm	0.879	0.078	0.96		
		Back at 23mm	0.445	1.445	1.89	#47	0.02



16.4 Product specific 10g SAR Exposure Conditions

WWAN Band		Exposure Position	1	3	1+3 Summed 10g SAR (W/kg)	Case No	SPLSR
			WWAN	5GHz WLAN			
			10g SAR (W/kg)	10g SAR (W/kg)			
GSM	GSM850	Front	0.671	0.055	0.73		
		Back		2.082	2.08		
		Left side		0.033	0.03		
		Right side		0.437	0.44		
		Top side		0.077	0.08		
		Bottom side			0.00		
	GSM1900	Front	3.187	0.055	3.24		
		Back	2.821	2.082	4.90	#34	0.08
		Left side		0.033	0.03		
		Right side		0.437	0.44		
		Top side		0.077	0.08		
		Bottom side	1.733		1.73		
WCDMA	WCDMA II	Front	3.065	0.055	3.12		
		Back	2.926	2.082	5.01	#35	0.09
		Left side		0.033	0.03		
		Right side		0.437	0.44		
		Top side		0.077	0.08		
		Bottom side	1.868		1.87		
	WCDMA IV	Front	3.360	0.055	3.42		
		Back	3.450	2.082	5.53	#36	0.10
		Left side		0.033	0.03		
		Right side		0.437	0.44		
		Top side		0.077	0.08		
		Bottom side	2.449		2.45		
	WCDMA V	Front	1.519	0.055	1.57		
		Back	1.472	2.082	3.55		
		Left side		0.033	0.03		
		Right side		0.437	0.44		
		Top side		0.077	0.08		
		Bottom side			0.00		
LTE	LTE Band 2	Front	2.755	0.055	2.81		
		Back	2.830	2.082	4.91	#37	0.08
		Left side		0.033	0.03		
		Right side		0.437	0.44		
		Top side		0.077	0.08		
		Bottom side	2.579		2.58		



	LTE Band 5	Front	2.418	0.055	2.47		
		Back	1.846	2.082	3.93		
		Left side		0.033	0.03		
		Right side		0.437	0.44		
		Top side		0.077	0.08		
		Bottom side	1.441		1.44		
	LTE Band 12	Front		0.055	0.06		
		Back		2.082	2.08		
		Left side		0.033	0.03		
		Right side		0.437	0.44		
		Top side		0.077	0.08		
		Bottom side			0.00		
	LTE Band 14	Front	1.985	0.055	2.04		
		Back	1.830	2.082	3.91		
		Left side		0.033	0.03		
		Right side		0.437	0.44		
		Top side		0.077	0.08		
		Bottom side			0.00		
	LTE Band 30	Front	3.267	0.055	3.32		
		Back	3.254	2.082	5.34	#38	0.09
		Left side	3.032	0.033	3.07		
		Right side		0.437	0.44		
		Top side		0.077	0.08		
		Bottom side	2.548		2.55		
LTE Band 66	Front	3.506	0.055	3.56			
	Back	3.040	2.082	5.12	#39	0.09	
	Left side		0.033	0.03			
	Right side		0.437	0.44			
	Top side		0.077	0.08			
	Bottom side	2.511		2.51			

16.5 SPLSR Evaluation and Analysis

General Note:

1. When standalone SAR is measured for both antennas in the pair, the peak location separation distance is computed by the square root of $[(x1-x2)^2 + (y1-y2)^2 + (z1-z2)^2]$, where $(x1, y1, z1)$ and $(x2, y2, z2)$ are the coordinates in the area scans or extrapolated peak SAR locations in the zoom scans, as appropriate.
2. $SPLSR = (SAR1 + SAR2)1.5 / (\text{min. separation distance, mm})$. If $SPLSR \leq 0.04$ for 1g SAR and $SPLSR \leq 0.10$ for 10g SAR, simultaneously transmission SAR measurement is not necessary.

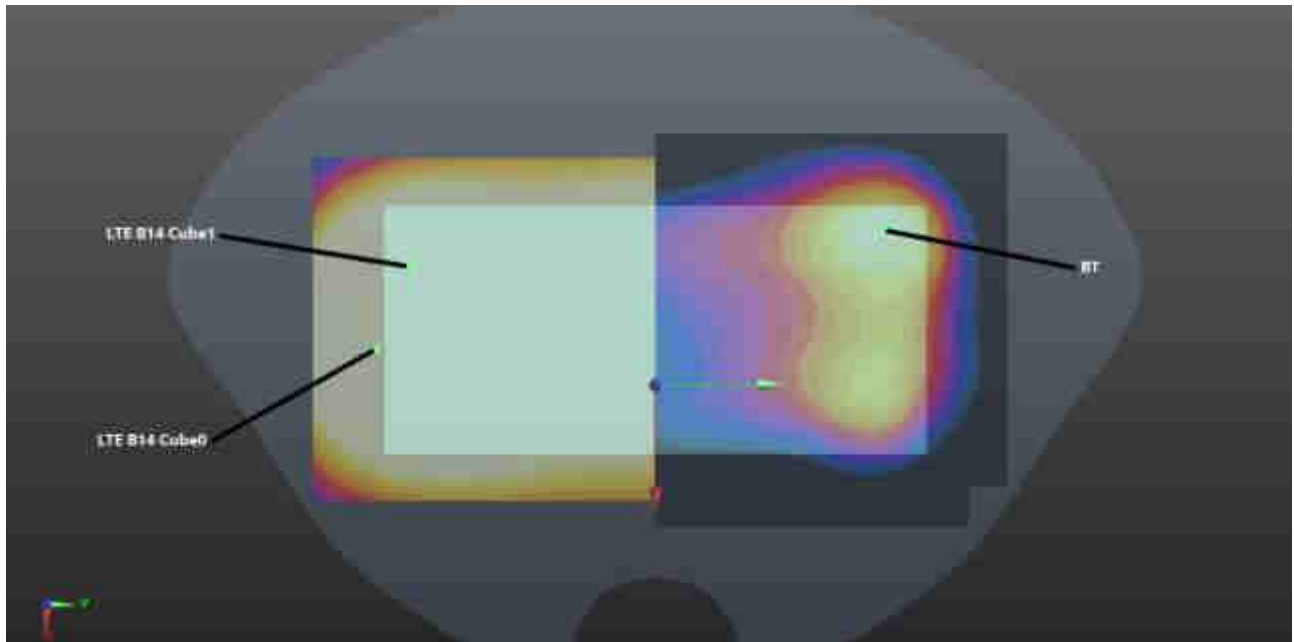

WWAN(5mm)+ BT (5mm) Back

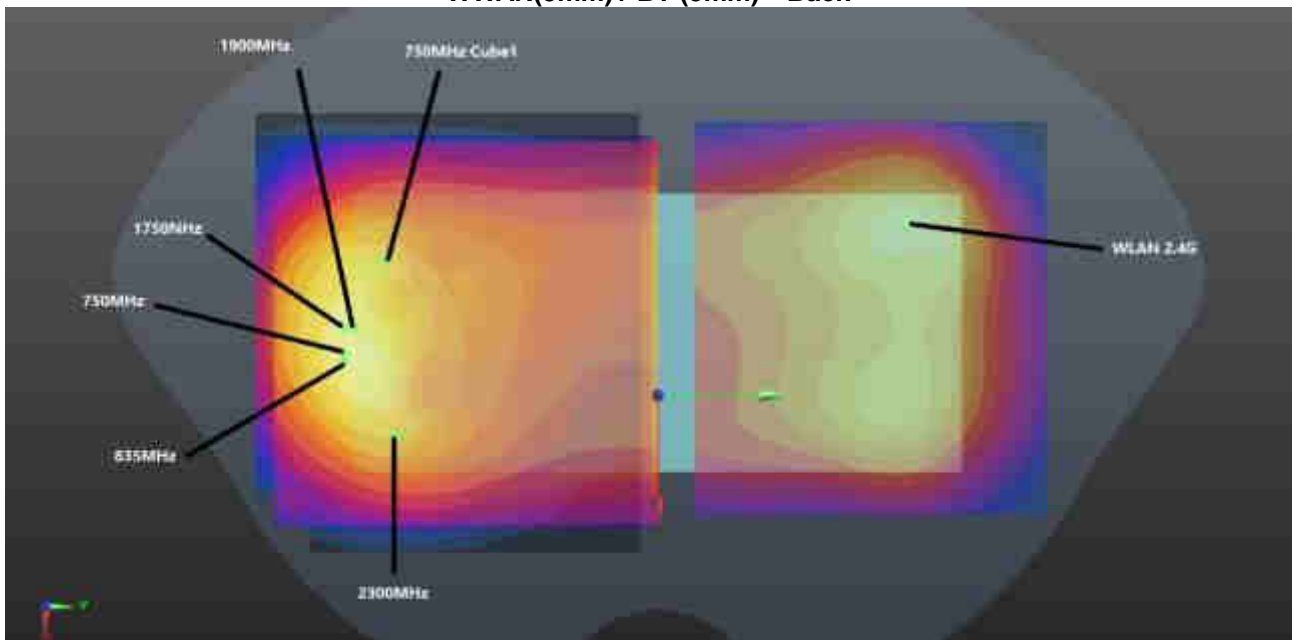

WWAN (5mm)+2.4G(5mm) Back

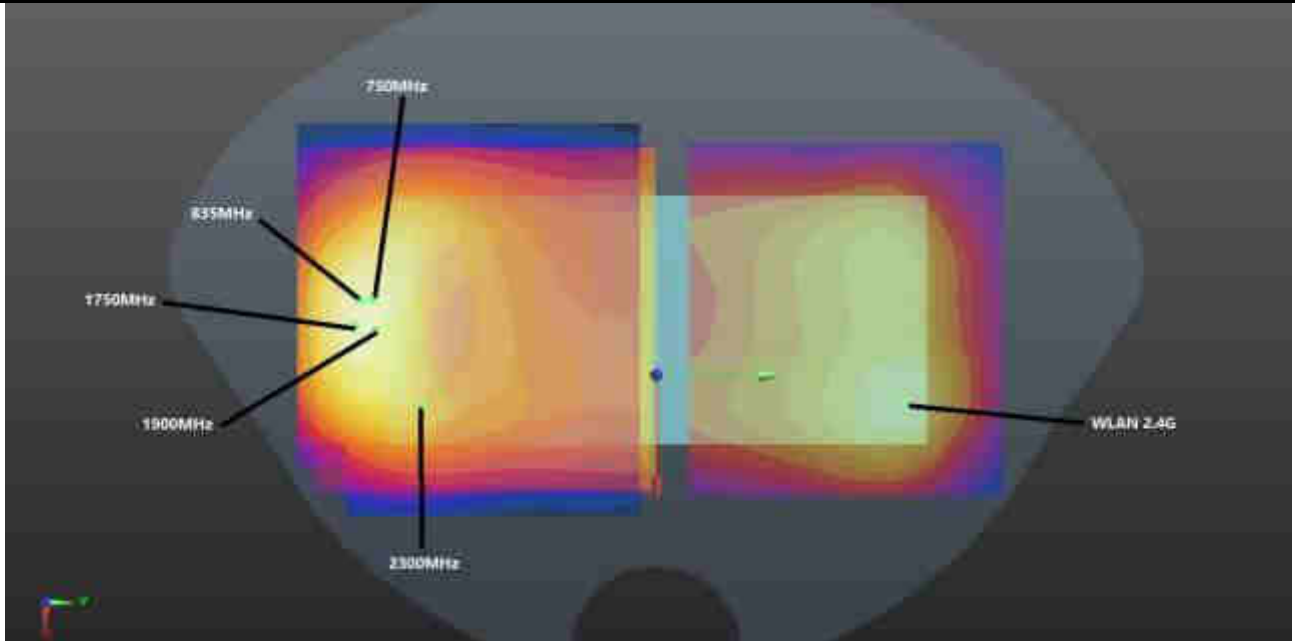

WWAN (5mm)+2.4G(5mm) Front

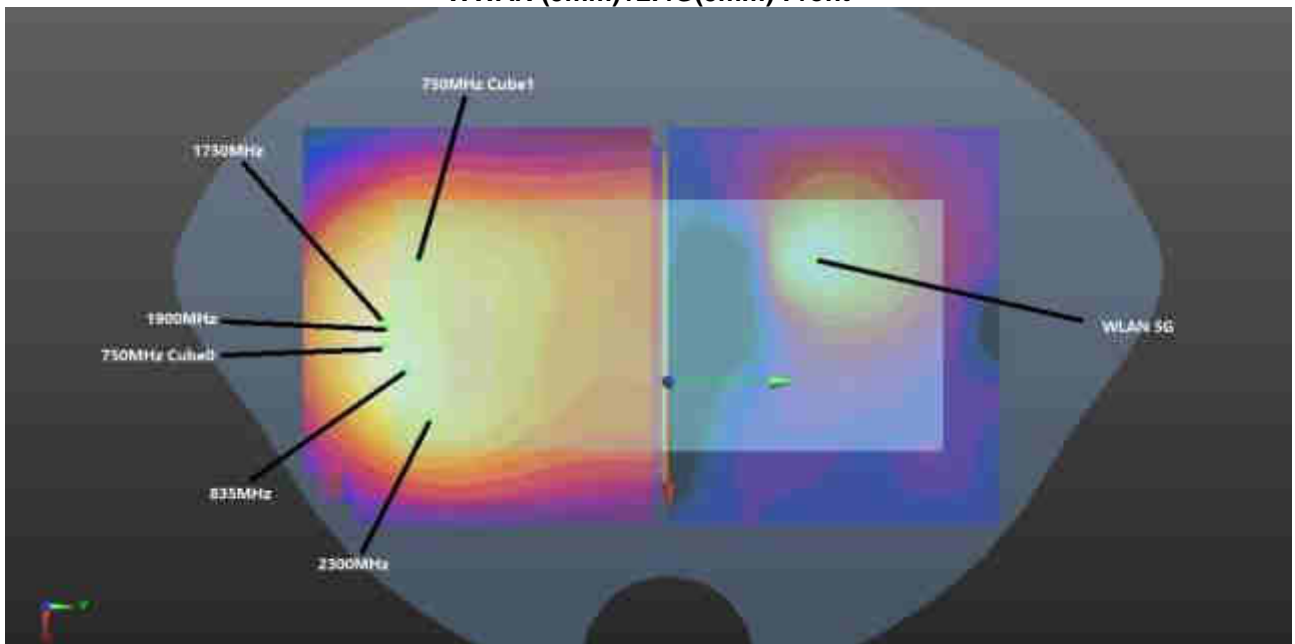

WWAN (5mm)+5G(5mm) Back

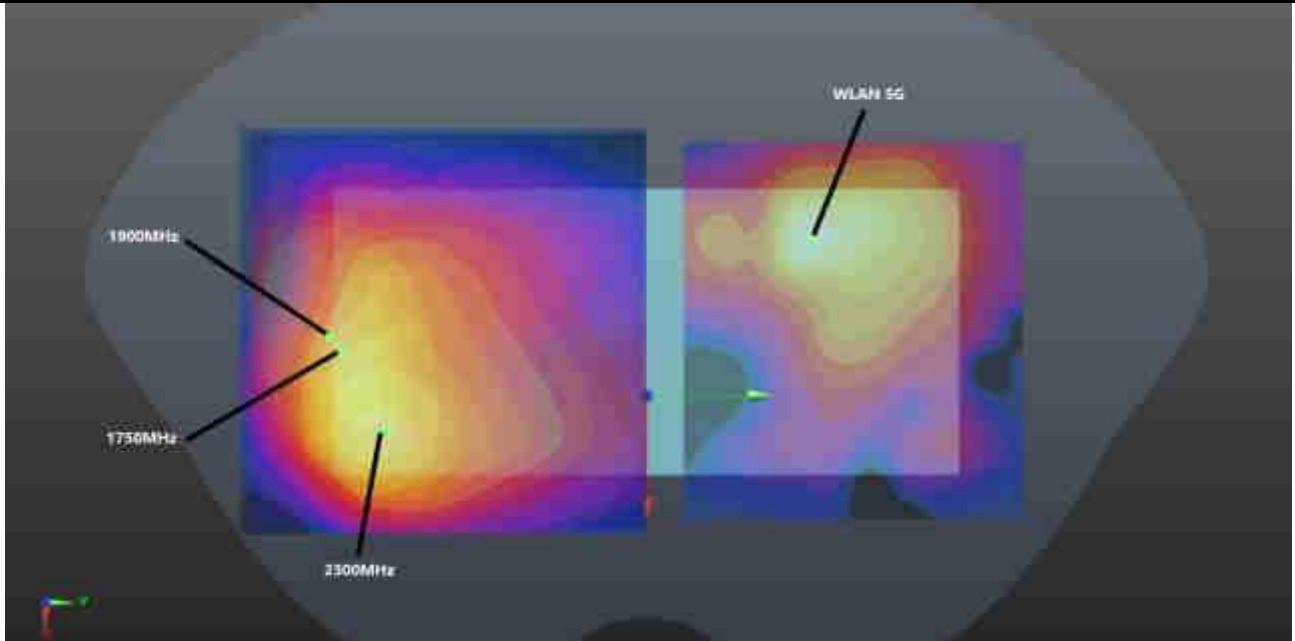

WWAN (0mm)+5G(0mm) Back

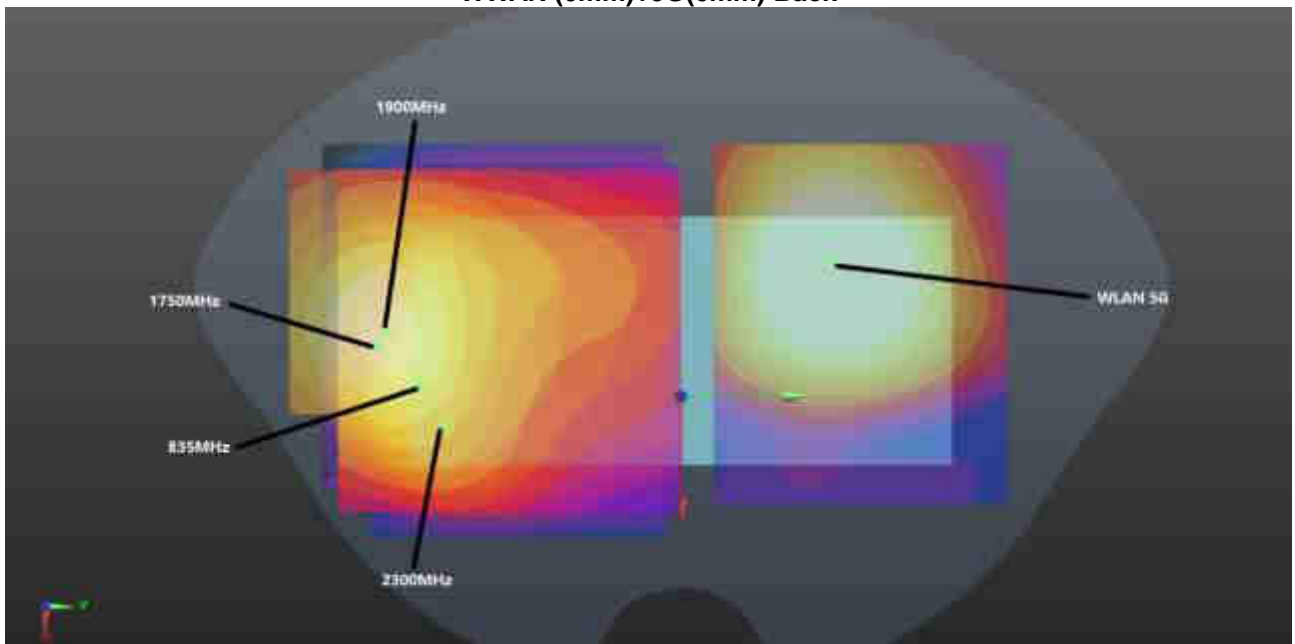

WWAN (23mm)+5G(23mm) Back



Body 5mm											
Case	Band	Position	SAR (W/kg)	Gap (mm)	SAR peak location (mm)			3D distance (mm)	Summed SAR (W/kg)	SPLSR Results	Simultaneous SAR
					X	Y	Z				
Case 1	GSM850	Front	1.282	5mm	-6	-85.4	-1.18	164.0	1.87	0.02	Not required
	WLAN2.4GHz		0.589	5mm	28.2	75	-1.02				
Case 2	GSM850	Back	1.131	5mm	13.9	-82.3	-1.05	157.7	1.94	0.02	Not required
	WLAN2.4GHz		0.805	5mm	-30.4	69	-1.33				
Case 3	GSM850	Back	1.131	5mm	13.9	-82.3	-1.05	129.5	2.26	0.03	Not required
	WLAN5GHz		1.128	5mm	-19.4	42.8	-1.16				
Case 4	GSM1900	Front	1.273	5mm	1.4	-86	-1.12	163.2	1.86	0.02	Not required
	WLAN2.4GHz		0.589	5mm	28.2	75	-1.02				
Case 5	GSM1900	Back	1.166	5mm	1.7	-81.4	-1.15	153.8	1.97	0.02	Not required
	WLAN2.4GHz		0.805	5mm	-30.4	69	-1.33				
Case 6	GSM1900	Back	1.166	5mm	1.7	-81.4	-1.15	126.0	2.29	0.03	Not required
	WLAN5GHz		1.128	5mm	-19.4	42.8	-1.16				
Case 7	WCDMA II	Front	1.223	5mm	-0.2	-88.9	-1.1	166.3	1.81	0.01	Not required
	WLAN2.4GHz		0.589	5mm	28.2	75	-1.02				



Case	Band	Position	SAR (W/kg)	Gap (mm)	SAR peak location (mm)			3D distance (mm)	Summed SAR (W/kg)	SPLSR Results	Simultaneous SAR
					X	Y	Z				
Case 8	WCDMA II	Back	1.112	5mm	0	-84.5	-1.17	156.5	1.92	0.02	Not required
	WLAN2.4GHz		0.805	5mm	-30.4	69	-1.33				
Case 9	WCDMA II	Back	1.112	5mm	0	-84.5	-1.17	128.8	2.24	0.03	Not required
	WLAN5GHz		1.128	5mm	-19.4	42.8	-1.16				
Case 10	WCDMA IV	Front	1.329	5mm	3.1	-88.8	-1.09	165.7	1.92	0.02	Not required
	WLAN2.4GHz		0.589	5mm	28.2	75	-1.02				
Case 11	WCDMA IV	Back	1.178	5mm	0	-84.5	-1.15	156.5	1.98	0.02	Not required
	WLAN2.4GHz		0.805	5mm	-30.4	69	-1.33				
Case 12	WCDMA IV	Back	1.178	5mm	0	-84.5	-1.15	128.8	2.31	0.03	Not required
	WLAN5GHz		1.128	5mm	-19.4	42.8	-1.16				
Case 13	WCDMA V	Front	1.213	5mm	-6	-88.9	-1.16	167.4	1.80	0.01	Not required
	WLAN2.4GHz		0.589	5mm	28.2	75	-1.02				
Case 14	WCDMA V	Back	0.992	5mm	11.9	-83.3	-1.07	158.1	1.80	0.02	Not required
	WLAN2.4GHz		0.805	5mm	-30.4	69	-1.33				
Case 15	WCDMA V	Back	0.992	5mm	11.9	-83.3	-1.07	129.9	2.12	0.02	Not required
	WLAN5GHz		1.128	5mm	-19.4	42.8	-1.16				



Case	Band	Position	SAR (W/kg)	Gap (mm)	SAR peak location (mm)			3D distance (mm)	Summed SAR (W/kg)	SPLSR Results	Simultaneous SAR
					X	Y	Z				
Case 16	LTE Band 2	Front	1.181	5mm	2.9	-88.3	-1.09	165.2	1.77	0.01	Not required
	WLAN2.4GHz		0.589	5mm	28.2	75	-1.02				
Case 17	LTE Band 2	Back	1.066	5mm	0	-84	-1.15	156.0	1.87	0.02	Not required
	WLAN2.4GHz		0.805	5mm	-30.4	69	-1.33				
Case 18	LTE Band 2	Back	1.066	5mm	0	-84	-1.15	128.3	2.19	0.03	Not required
	WLAN5GHz		1.128	5mm	-19.4	42.8	-1.16				
Case 19	LTE Band 5	Front	1.274	5mm	-6	-87	-1.16	165.6	1.86	0.02	Not required
	WLAN2.4GHz		0.589	5mm	28.2	75	-1.02				
Case 20	LTE Band 5	Back	1.127	5mm	12.3	-83.9	-1.04	158.8	1.93	0.02	Not required
	WLAN2.4GHz		0.805	5mm	-30.4	69	-1.33				
Case 21	LTE Band 5	Back	1.127	5mm	12.3	-83.9	-1.04	130.6	2.26	0.03	Not required
	WLAN5GHz		1.128	5mm	-19.4	42.8	-1.16				
Case 22	LTE Band 12	Front	1.076	5mm	-6	-87	-1.15	165.6	1.67	0.01	Not required
	WLAN2.4GHz		0.589	5mm	28.2	75	-1.02				



FCC SAR Test Report

Report No. : FA080709-01

Case 23	Band	Position	SAR (W/kg)	Gap (mm)	SAR peak location (mm)			3D distance (mm)	Summed SAR (W/kg)	SPLSR Results	Simultaneous SAR
					X	Y	Z				
	LTE Band 12	Back	1.000	5mm	10.7	-76.7	-1.16	151.4	1.81	0.02	Not required
WLAN2.4GHz	0.805		5mm	-30.4	69	-1.33					

Case 24	Band	Position	SAR (W/kg)	Gap (mm)	SAR peak location (mm)			3D distance (mm)	Summed SAR (W/kg)	SPLSR Results	Simultaneous SAR
					X	Y	Z				
	LTE Band 12	Back	1.000	5mm	10.7	-76.7	-1.16	123.2	2.13	0.03	Not required
WLAN5GHz	1.128		5mm	-19.4	42.8	-1.16					

Case 25	Band	Position	SAR (W/kg)	Gap (mm)	SAR peak location (mm)			3D distance (mm)	Summed SAR (W/kg)	SPLSR Results	Simultaneous SAR
					X	Y	Z				
	LTE Band 14	Front	1.343	5mm	-6	-87	-1.21	165.6	1.93	0.02	Not required
WLAN2.4GHz	0.589		5mm	28.2	75	-1.02					

Case 26	Band	Position	SAR (W/kg)	Gap (mm)	SAR peak location (mm)			3D distance (mm)	Summed SAR (W/kg)	SPLSR Results	Simultaneous SAR
					X	Y	Z				
	LTE Band 14 Cube0	Back	1.438	5mm	12.4	-82.3	-1.07	157.2	2.24	0.02	Not required
	WLAN2.4GHz		0.805	5mm	-30.4	69	-1.33				
LTE Band 14 Cube1	Back	1.438	5mm	-17.9	-83	-1.27	152.5	2.24	0.02	Not required	
WLAN2.4GHz		0.805	5mm	-30.4	69	-1.33					

Case 27	Band	Position	SAR (W/kg)	Gap (mm)	SAR peak location (mm)			3D distance (mm)	Summed SAR (W/kg)	SPLSR Results	Simultaneous SAR
					X	Y	Z				
	LTE Band 14 Cube0	Back	1.438	5mm	12.4	-82.3	-1.07	129.1	2.57	0.03	Not required
	WLAN5GHz		1.128	5mm	-19.4	42.8	-1.16				
LTE Band 14 Cube1	Back	1.438	5mm	-17.9	-83	-1.27	125.8	2.57	0.03	Not required	
WLAN5GHz		1.128	5mm	-19.4	42.8	-1.16					

Case 28	Band	Position	SAR (W/kg)	Gap (mm)	SAR peak location (mm)			3D distance (mm)	Summed SAR (W/kg)	SPLSR Results	Simultaneous SAR
					X	Y	Z				
	LTE Band 30	Front	1.132	5mm	26.4	-71.6	-1.2	146.6	1.72	0.02	Not required
WLAN2.4GHz	0.589		5mm	28.2	75	-1.02					

Case 29	Band	Position	SAR (W/kg)	Gap (mm)	SAR peak location (mm)			3D distance (mm)	Summed SAR (W/kg)	SPLSR Results	Simultaneous SAR
					X	Y	Z				
	LTE Band 30	Back	1.435	5mm	26.6	-72.6	-1.04	152.6	2.24	0.02	Not required
WLAN2.4GHz	0.805		5mm	-30.4	69	-1.33					



Case	Band	Position	SAR (W/kg)	Gap (mm)	SAR peak location (mm)			3D distance (mm)	Summed SAR (W/kg)	SPLSR Results	Simultaneous SAR
					X	Y	Z				
Case 30	LTE Band 30	Back	1.435	5mm	26.6	-72.6	-1.04	124.2	2.56	0.03	Not required
	WLAN5GHz		1.128	5mm	-19.4	42.8	-1.16				
Case 31	LTE Band 66	Front	1.319	5mm	-1.2	-85	-1.15	162.7	1.91	0.02	Not required
	WLAN2.4GHz		0.589	5mm	28.2	75	-1.02				
Case 32	LTE Band 66	Back	1.260	5mm	1.8	-87.4	-1.13	159.7	2.07	0.02	Not required
	WLAN2.4GHz		0.805	5mm	-30.4	69	-1.33				
Case 33	LTE Band 66	Back	1.260	5mm	1.8	-87.4	-1.13	131.9	2.39	0.03	Not required
	WLAN5GHz		1.128	5mm	-19.4	42.8	-1.16				
0mm											
Case 34	GSM1900	Back	2.821	0mm	12.4	-79.5	-1.03	131.9	4.90	0.08	Not required
	WLAN5GHz		2.082	0mm	-23	47.6	-1.66				
Case 35	WCDMA II	Back	2.926	0mm	10.9	-79.4	-1.09	131.4	5.01	0.09	Not required
	WLAN5GHz		2.082	0mm	-23	47.6	-1.66				
Case 36	WCDMA IV	Back	3.450	0mm	7.9	-80.8	-1.1	132.1	5.53	0.10	Not required
	WLAN5GHz		2.082	0mm	-23	47.6	-1.66				
Case 37	LTE Band 2	Back	2.830	0mm	9.5	-86.8	-1.05	138.3	4.91	0.08	Not required
	WLAN5GHz		2.082	0mm	-23	47.6	-1.66				



Case	Band	Position	SAR (W/kg)	Gap (mm)	SAR peak location (mm)			3D distance (mm)	Summed SAR (W/kg)	SPLSR Results	Simultaneous SAR
					X	Y	Z				
Case 38	LTE Band 30	Back	3.254	0mm	28.4	-76.6	-0.96	134.4	5.34	0.09	Not required
	WLAN5GHz		2.082	0mm	-23	47.6	-1.66				
Case 39	LTE Band 66	Back	3.040	0mm	12	-78.1	-1.04	130.5	5.12	0.09	Not required
	WLAN5GHz		2.082	0mm	-23	47.6	-1.66				
23mm											
Case 40	GSM1900	Back	0.366	23mm	-3.2	-86	-1.19	133.5	1.81	0.02	Not required
	WLAN5GHz		1.445	23mm	-23.2	46	-1.7				
Case 41	WCDMA II	Back	0.798	23mm	-1.5	-81	-1.29	128.8	2.24	0.03	Not required
	WLAN5GHz		1.445	23mm	-23.2	46	-1.7				
Case 42	WCDMA IV	Back	0.715	23mm	-3.2	-89.8	-1.07	137.3	2.16	0.02	Not required
	WLAN5GHz		1.445	23mm	-23.2	46	-1.7				
Case 43	WCDMA V	Back	0.354	23mm	-9	-80.5	-1.74	127.3	1.80	0.02	Not required
	WLAN5GHz		1.445	23mm	-23.2	46	-1.7				
Case 44	LTE Band 2	Back	0.451	23mm	14	-83.9	-1.01	135.1	1.90	0.02	Not required
	WLAN5GHz		1.445	23mm	-23.2	46	-1.7				
Case 45	LTE Band 5	Back	0.275	23mm	-17.9	-81.4	-1.23	127.5	1.72	0.02	Not required
	WLAN5GHz		1.445	23mm	-23.2	46	-1.7				
Case 46	LTE Band 30	Back	0.189	23mm	-14.2	-63.6	-1.36	110.0	1.63	0.02	Not required
	WLAN5GHz		1.445	23mm	-23.2	46	-1.7				



Case 47	Band	Position	SAR (W/kg)	Gap (mm)	SAR peak location (mm)			3D distance (mm)	Summed SAR (W/kg)	SPLSR Results	Simultaneous SAR
					X	Y	Z				
	LTE Band 66	Back	0.445	23mm	12	-78.1	-1.05	129.0	1.89	0.02	Not required
	WLAN5GHz		1.445	23mm	-23.2	46	-1.7				
Body 5mm											
Case 48	LTE Band 14 Cube0	Back	SAR (W/kg)	Gap (mm)	SAR peak location (mm)			3D distance (mm)	Summed SAR (W/kg)	SPLSR Results	Simultaneous SAR
					X	Y	Z				
		Bluetooth	0.158	5mm	-31.2	68.6	-1.4	157.1	1.60	0.01	Not required
		LTE Band 14 Cube1	1.438	5mm	-17.9	-83	-1.27				
	Bluetooth	0.158	5mm	-31.2	68.6	-1.4					



17. Supplemental Tuner Tests Results

General Note:

1. The following test procedure was followed to demonstrate that the SAR results in this report represent the appropriate SAR test conditions. For bands with dynamic tuning implemented, SAR will be measured according to the required FCC SAR test procedures with the dynamic tuner active to allow the device to automatically tune to the antenna state for the respective RF exposure test configurations. Additional single point SAR time-sweep measurements will be evaluated for other tuner states to determine that the other tuner configurations would result in equivalent or lower SAR values. The additional tuner hardware has no influence to the antenna characteristics, other than impedance matching.
2. To evaluate all of the tuner states, the 144 tuner states are divided evenly WCDMA Band V and LTE band 5/12/14, mode and exposure combinations so that at least one single point SAR measurement is measured in each configuration. Single point time-sweep measurements will be performed at the peak SAR location determined by the zoom scan of the configuration with the highest reported SAR for each combination. The tuner state will be established remotely so that the device is not moved for the entire series of single point SAR for the tuner states in each combination. The SAR probe will remain stationary at the same position throughout the entire series of single point measurements for each combination.
3. According to workshop 2019, if any single point SAR measurement result is $> 1.2 \text{ W/kg}$ for a band/exposure condition combination set, all supported tuner states are evaluated with single point SAR measurements for the combination. So we verified the single point SAR that bands with SAR value high than 1.2 W/Kg .
4. The operational decryption contains more information about the design and implementation of the dynamic antenna tuning.

17.1 Supplemental Tuner Head & Body SAR Results

Please refer to Appendix F.

Test Engineer : Nick Hu, Tony Zhang, Hank Chang, Yuankai Kong



18. Uncertainty Assessment

Per KDB 865664 D01 SAR measurement 100MHz to 6GHz, when the highest measured 1-g SAR within a frequency band is < 1.5 W/kg and the measured 10-g SAR within a frequency band is < 3.75 W/kg. The expanded SAR measurement uncertainty must be $\leq 30\%$, for a confidence interval of $k = 2$. If these conditions are met, extensive SAR measurement uncertainty analysis described in IEEE Std 1528-2013 is not required in SAR reports submitted for equipment approval. For this device, the highest measured 1-g SAR is less 1.5W/kg and highest measured 10-g SAR is less 3.75W/kg. Therefore, the measurement uncertainty table is not required in this report.



19. References

- [1] FCC 47 CFR Part 2 "Frequency Allocations and Radio Treaty Matters; General Rules and Regulations"
- [2] ANSI/IEEE Std. C95.1-1992, "IEEE Standard for Safety Levels with Respect to Human Exposure to Radio Frequency Electromagnetic Fields, 3 kHz to 300 GHz", September 1992
- [3] IEEE Std. 1528-2013, "IEEE Recommended Practice for Determining the Peak Spatial-Average Specific Absorption Rate (SAR) in the Human Head from Wireless Communications Devices: Measurement Techniques", Sep 2013
- [4] SPEAG DASY System Handbook
- [5] FCC KDB 865664 D01 v01r04, "SAR Measurement Requirements for 100 MHz to 6 GHz", Aug 2015.
- [6] FCC KDB 865664 D02 v01r02, "RF Exposure Compliance Reporting and Documentation Considerations" Oct 2015.
- [7] FCC KDB 447498 D01 v06, "Mobile and Portable Device RF Exposure Procedures and Equipment Authorization Policies", Oct 2015
- [8] FCC KDB 648474 D04 v01r03, "SAR Evaluation Considerations for Wireless Handsets", Oct 2015.
- [9] FCC KDB 248227 D01 v02r02, "SAR Guidance for IEEE 802.11 (WiFi) Transmitters", Oct 2015.
- [10] FCC KDB 616217 D04 v01r02, "SAR Evaluation Considerations for Laptop, Notebook, Netbook and Tablet Computers", Oct 2015
- [11] FCC KDB 941225 D01 v03r01, "3G SAR MEAUREMENT PROCEDURES", Oct 2015
- [12] FCC KDB 941225 D05 v02r05, "SAR Evaluation Considerations for LTE Devices", Dec 2015
- [13] FCC KDB 941225 D06 v02r01, "SAR Evaluation Procedures for Portable Devices with Wireless Router Capabilities", Oct 2015.

-----THE END-----



Appendix A. Plots of System Performance Check

The plots are shown as follows.

System Check_Head_750MHz

DUT: D750V3 - SN:1087

Communication System: UID 0, CW (0); Frequency: 750 MHz; Duty Cycle: 1:1

Medium: HSL_750 Medium parameters used: $f = 750 \text{ MHz}$; $\sigma = 0.911 \text{ S/m}$; $\epsilon_r = 42.231$; $\rho = 1000 \text{ kg/m}^3$

Ambient Temperature : 23.3 °C; Liquid Temperature : 22.7 °C

DASY5 Configuration:

- Probe: EX3DV4 - SN3935; ConvF(10.58, 10.58, 10.58); Calibrated: 2020.5.27
- Sensor-Surface: 1.4mm (Mechanical Surface Detection)
- Electronics: DAE4 Sn1358; Calibrated: 2020.4.28
- Phantom: SAM1; Type: SAM; Serial: TP-1753
- Measurement SW: DASY52, Version 52.10 (4); SEMCAD X Version 14.6.14 (7483)

Pin=250mW/Area Scan (61x61x1): Interpolated grid: $dx=1.500 \text{ mm}$, $dy=1.500 \text{ mm}$
Maximum value of SAR (interpolated) = 2.70 W/kg

Pin=250mW/Zoom Scan (5x5x7)/Cube 0: Measurement grid: $dx=8\text{mm}$, $dy=8\text{mm}$, $dz=5\text{mm}$

Reference Value = 49.18 V/m; Power Drift = 0.14 dB

Peak SAR (extrapolated) = 3.23 W/kg

SAR(1 g) = 2.18 W/kg; SAR(10 g) = 1.44 W/kg

Maximum value of SAR (measured) = 2.76 W/kg

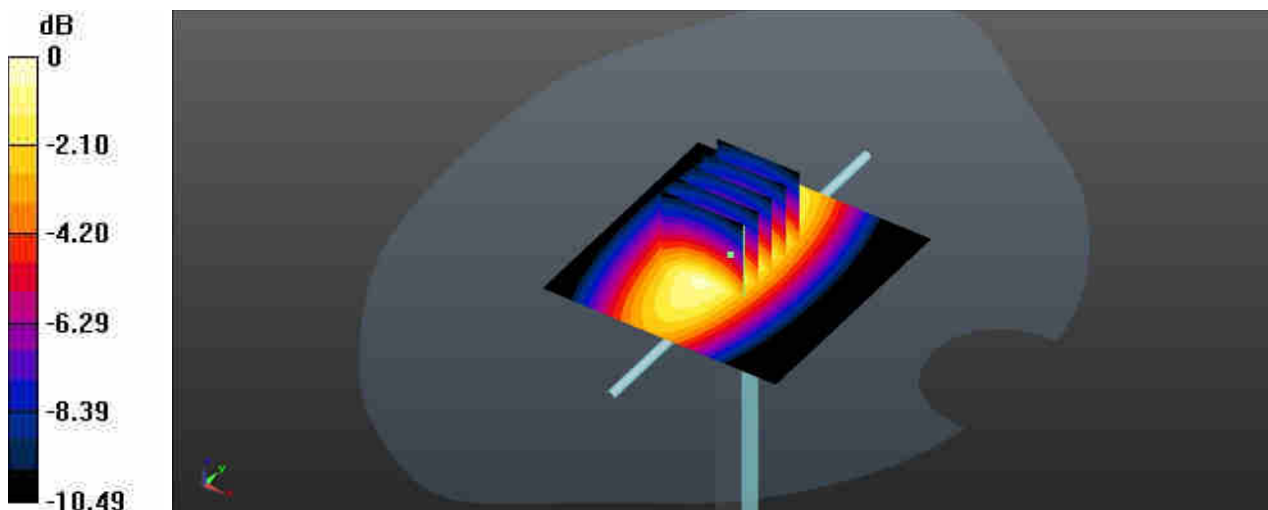

0 dB = 2.76 W/kg = 4.41 dBW/kg

System Check_Head_835MHz

DUT: D835V2 - SN:4d151

Communication System: UID 0, CW (0); Frequency: 835 MHz; Duty Cycle: 1:1

Medium: HSL_835 Medium parameters used: $f = 835 \text{ MHz}$; $\sigma = 0.915 \text{ S/m}$; $\epsilon_r = 41.263$; $\rho = 1000 \text{ kg/m}^3$

Ambient Temperature : 23.2 °C; Liquid Temperature : 22.9 °C

DASY5 Configuration:

- Probe: EX3DV4 - SN3935; ConvF(10.31, 10.31, 10.31); Calibrated: 2020.5.27
- Sensor-Surface: 1.4mm (Mechanical Surface Detection)
- Electronics: DAE4 Sn1358; Calibrated: 2020.4.28
- Phantom: SAM1; Type: SAM; Serial: TP-1753
- Measurement SW: DASY52, Version 52.10 (4); SEMCAD X Version 14.6.14 (7483)

Pin=250mW/Area Scan (61x61x1): Interpolated grid: $dx=1.500 \text{ mm}$, $dy=1.500 \text{ mm}$
Maximum value of SAR (interpolated) = 3.16 W/kg

Pin=250mW/Zoom Scan (5x5x7)/Cube 0: Measurement grid: $dx=8\text{mm}$, $dy=8\text{mm}$, $dz=5\text{mm}$

Reference Value = 53.04 V/m; Power Drift = 0.11 dB

Peak SAR (extrapolated) = 3.79 W/kg

SAR(1 g) = 2.51 W/kg; SAR(10 g) = 1.62 W/kg

Maximum value of SAR (measured) = 3.21 W/kg

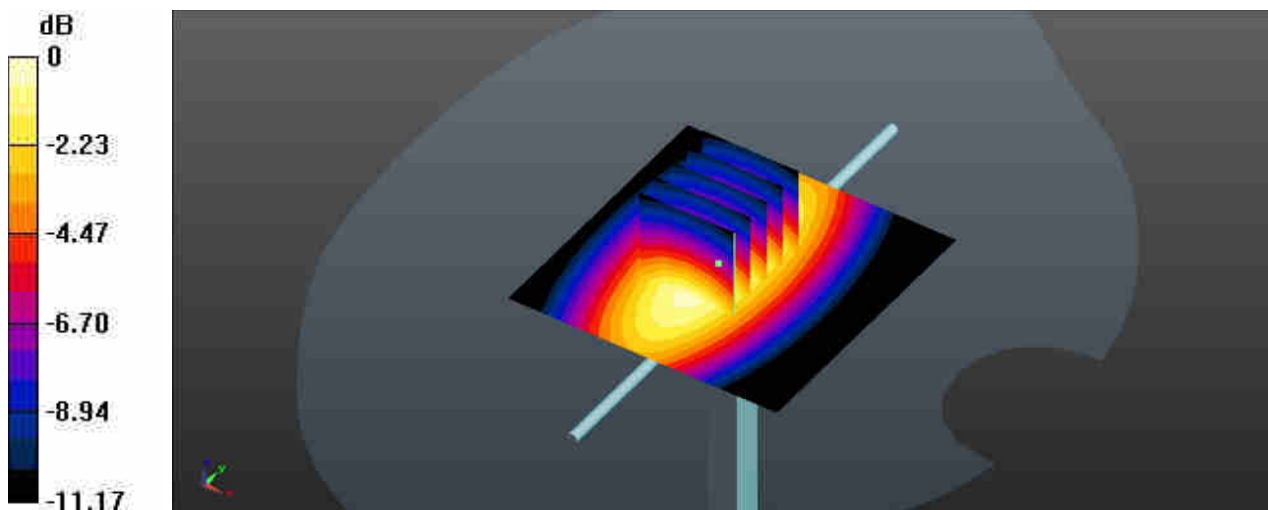

0 dB = 3.21 W/kg = 5.07 dBW/kg

System Check_Head_1750MHz

DUT: D1750V2 - SN:1090

Communication System: UID 0, CW; Frequency: 1750 MHz; Duty Cycle: 1:1

Medium: HSL_1750 Medium parameters used: $f = 1750$ MHz; $\sigma = 1.383$ S/m; $\epsilon_r = 41.08$; $\rho = 1000$ kg/m³

Ambient Temperature : 23.4 °C; Liquid Temperature : 22.8 °C

DASY5 Configuration:

- Probe: EX3DV4 - SN3935; ConvF(8.6, 8.6, 8.6); Calibrated: 2020.5.27
- Sensor-Surface: 1.4mm (Mechanical Surface Detection)
- Electronics: DAE4 Sn1358; Calibrated: 2020.4.28
- Phantom: SAM1; Type: SAM; Serial: TP-1753
- Measurement SW: DASY52, Version 52.10 (4); SEMCAD X Version 14.6.14 (7483)

Pin=250mW/Area Scan (61x61x1): Interpolated grid: dx=1.500 mm, dy=1.500 mm
Maximum value of SAR (interpolated) = 12.8 W/kg

Pin=250mW/Zoom Scan (5x5x7)/Cube 0: Measurement grid: dx=8mm, dy=8mm, dz=5mm

Reference Value = 79.89 V/m; Power Drift = 0.16 dB

Peak SAR (extrapolated) = 16.3 W/kg

SAR(1 g) = 9.11 W/kg; SAR(10 g) = 4.87 W/kg

Maximum value of SAR (measured) = 12.8 W/kg

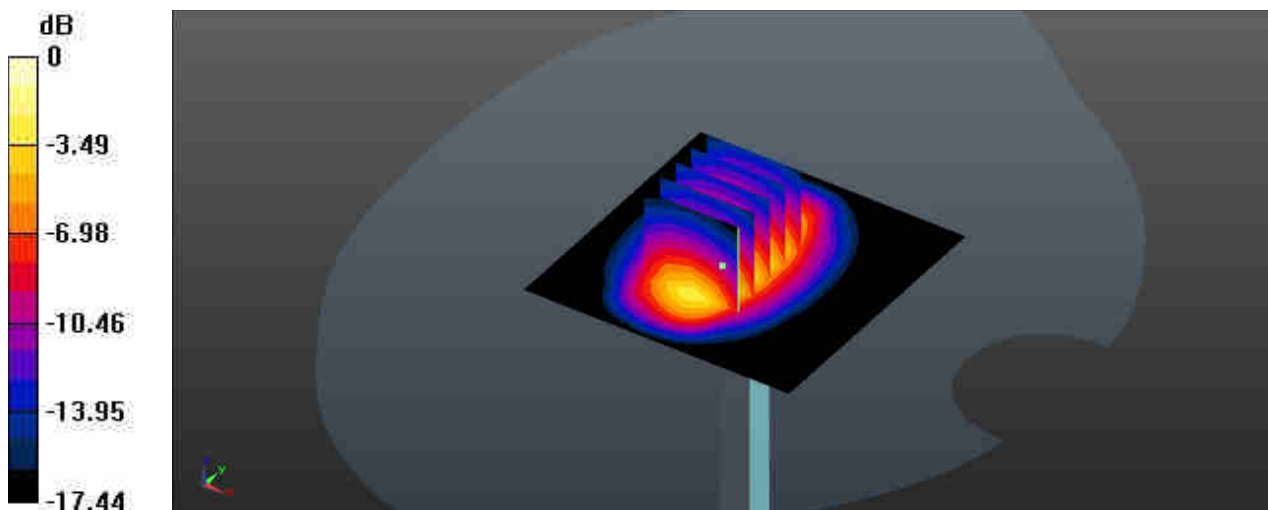

0 dB = 12.8 W/kg = 11.07 dBW/kg

System Check_Head_1900MHz

DUT: D1900V2 - SN:5d170

Communication System: UID 0, CW (0); Frequency: 1900 MHz; Duty Cycle: 1:1

Medium: HSL_1900 Medium parameters used: $f = 1900$ MHz; $\sigma = 1.401$ S/m; $\epsilon_r = 40.146$; $\rho = 1000$ kg/m³

Ambient Temperature : 23.2 °C; Liquid Temperature : 22.9 °C

DASY5 Configuration:

- Probe: EX3DV4 - SN3935; ConvF(8.35, 8.35, 8.35); Calibrated: 2020.5.27
- Sensor-Surface: 1.4mm (Mechanical Surface Detection)
- Electronics: DAE4 Sn1358; Calibrated: 2020.4.28
- Phantom: SAM1; Type: SAM; Serial: TP-1753
- Measurement SW: DASY52, Version 52.10 (4); SEMCAD X Version 14.6.14 (7483)

Pin=250mW/Area Scan (61x61x1): Interpolated grid: dx=1.500 mm, dy=1.500 mm
Maximum value of SAR (interpolated) = 14.8 W/kg

Pin=250mW/Zoom Scan (5x5x7)/Cube 0: Measurement grid: dx=8mm, dy=8mm, dz=5mm

Reference Value = 90.21 V/m; Power Drift = -0.05 dB

Peak SAR (extrapolated) = 19.1 W/kg

SAR(1 g) = 10.1 W/kg; SAR(10 g) = 5.18 W/kg

Maximum value of SAR (measured) = 14.8 W/kg

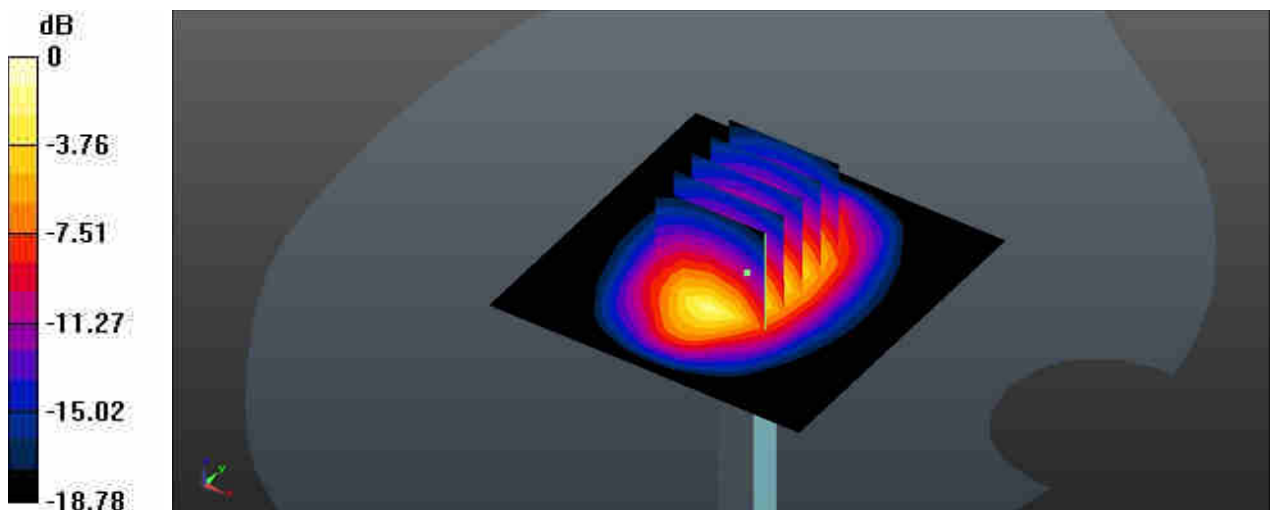

0 dB = 14.8 W/kg = 11.70 dBW/kg

System Check_Head_2300MHz

DUT: D2300V2 - SN:1055

Communication System: UID 0, CW (0); Frequency: 2300 MHz; Duty Cycle: 1:1

Medium: HSL_2300 Medium parameters used: $f = 2300$ MHz; $\sigma = 1.691$ S/m; $\epsilon_r = 39.197$; $\rho = 1000$ kg/m³

Ambient Temperature : 23.3 °C; Liquid Temperature : 22.8 °C

DASY5 Configuration:

- Probe: EX3DV4 - SN3935; ConvF(7.86, 7.86, 7.86); Calibrated: 2020.5.27
- Sensor-Surface: 1.4mm (Mechanical Surface Detection)
- Electronics: DAE4 Sn1358; Calibrated: 2020.4.28
- Phantom: SAM1; Type: SAM; Serial: TP-1753
- Measurement SW: DASY52, Version 52.10 (4); SEMCAD X Version 14.6.14 (7483)

Pin=250mW/Area Scan (71x71x1): Interpolated grid: dx=1.200 mm, dy=1.200 mm
Maximum value of SAR (interpolated) = 19.1 W/kg

Pin=250mW/Zoom Scan (7x7x7)/Cube 0: Measurement grid: dx=5mm, dy=5mm, dz=5mm

Reference Value = 92.34 V/m; Power Drift = -0.08 dB

Peak SAR (extrapolated) = 24.1 W/kg

SAR(1 g) = 12.9 W/kg; SAR(10 g) = 6.35 W/kg

Maximum value of SAR (measured) = 18.8 W/kg

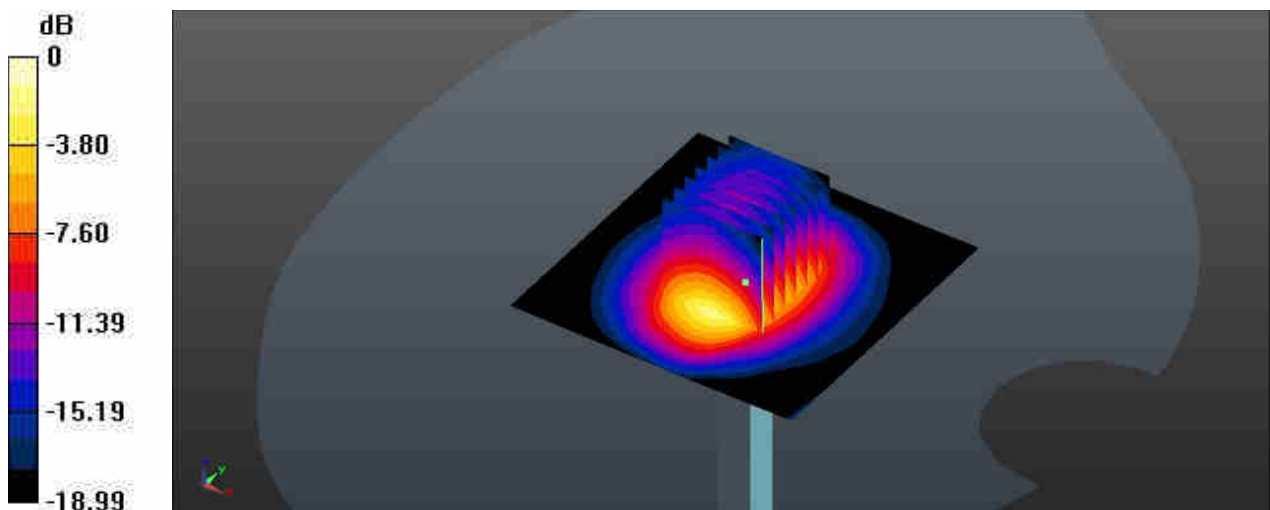

0 dB = 18.8 W/kg = 12.74 dBW/kg

System Check_Head_2450MHz

DUT: D2450V2 - SN:908

Communication System: UID 0, CW (0); Frequency: 2450 MHz; Duty Cycle: 1:1

Medium: HSL_2450 Medium parameters used: $f = 2450$ MHz; $\sigma = 1.863$ S/m; $\epsilon_r = 38.595$; $\rho = 1000$ kg/m³

Ambient Temperature : 23.3 °C; Liquid Temperature : 22.8 °C

DASY5 Configuration:

- Probe: EX3DV4 - SN3935; ConvF(7.6, 7.6, 7.6); Calibrated: 2020.5.27
- Sensor-Surface: 1.4mm (Mechanical Surface Detection)
- Electronics: DAE4 Sn1358; Calibrated: 2020.4.28
- Phantom: SAM1; Type: SAM; Serial: TP-1753
- Measurement SW: DASY52, Version 52.10 (4); SEMCAD X Version 14.6.14 (7483)

Pin=250mW/Area Scan (71x71x1): Interpolated grid: dx=1.200 mm, dy=1.200 mm
Maximum value of SAR (interpolated) = 19.1 W/kg

Pin=250mW/Zoom Scan (7x7x7)/Cube 0: Measurement grid: dx=5mm, dy=5mm, dz=5mm

Reference Value = 100.3 V/m; Power Drift = -0.08 dB

Peak SAR (extrapolated) = 28.2 W/kg

SAR(1 g) = 13.7 W/kg; SAR(10 g) = 6.29 W/kg

Maximum value of SAR (measured) = 18.0 W/kg

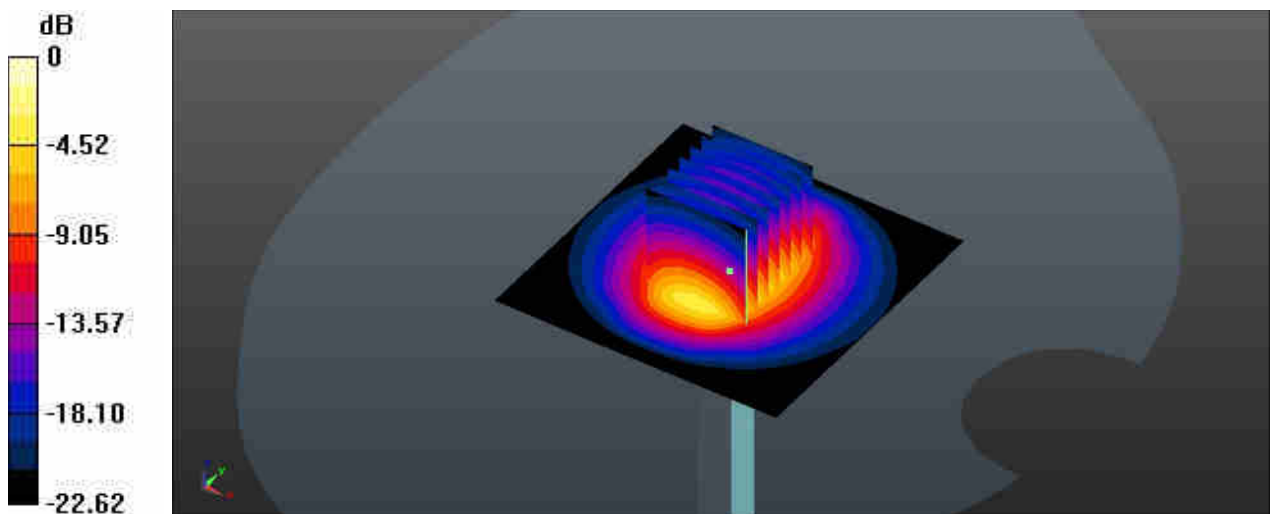

0 dB = 18.0 W/kg = 12.55 dBW/kg

System Check_Head_5250MHz

DUT: D5GHzV2 - SN:1113

Communication System: UID 0, CW (0); Frequency: 5250 MHz; Duty Cycle: 1:1

Medium: HSL_5000 Medium parameters used: $f = 5250$ MHz; $\sigma = 4.683$ S/m; $\epsilon_r = 35.318$; $\rho = 1000$ kg/m³

Ambient Temperature : 23.1 °C; Liquid Temperature : 22.7 °C

DASY5 Configuration:

- Probe: EX3DV4 - SN3935; ConvF(5.04, 5.04, 5.04); Calibrated: 2020.5.27
- Sensor-Surface: 1.4mm (Mechanical Surface Detection)
- Electronics: DAE4 Sn1358; Calibrated: 2020.4.28
- Phantom: SAM1; Type: SAM; Serial: TP-1753
- Measurement SW: DASY52, Version 52.10 (4); SEMCAD X Version 14.6.14 (7483)

Pin=100mW/Area Scan (71x71x1): Interpolated grid: dx=1.000 mm, dy=1.000 mm

Maximum value of SAR (interpolated) = 17.9 W/kg

Pin=100mW/Zoom Scan (8x8x7)/Cube 0: Measurement grid: dx=4mm, dy=4mm, dz=1.4mm

Reference Value = 42.51 V/m; Power Drift = -0.05 dB

Peak SAR (extrapolated) = 31.1 W/kg

SAR(1 g) = 7.34 W/kg; SAR(10 g) = 2.08 W/kg

Maximum value of SAR (measured) = 17.9 W/kg

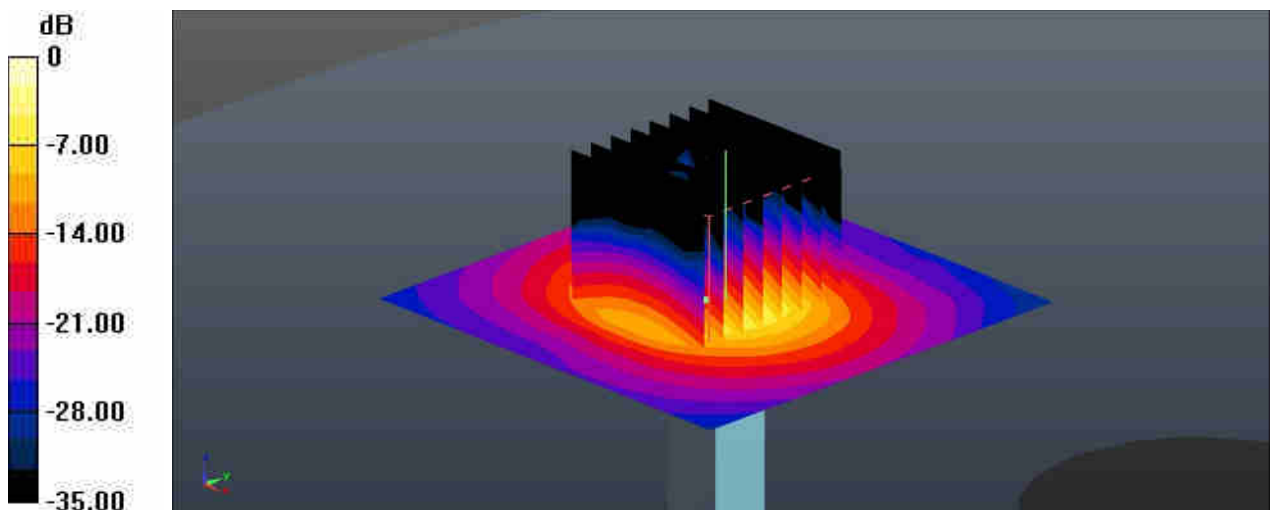

0 dB = 17.9 W/kg = 12.53 dBW/kg

System Check_Head_5600MHz

DUT: D5GHzV2 - SN:1113

Communication System: UID 0, CW (0); Frequency: 5600 MHz; Duty Cycle: 1:1

Medium: HSL_5000 Medium parameters used: $f = 5600$ MHz; $\sigma = 5.029$ S/m; $\epsilon_r = 34.778$; $\rho = 1000$ kg/m³

Ambient Temperature : 23.3 °C; Liquid Temperature : 22.6 °C

DASY5 Configuration:

- Probe: EX3DV4 - SN3935; ConvF(4.76, 4.76, 4.76); Calibrated: 2020.5.27
- Sensor-Surface: 1.4mm (Mechanical Surface Detection)
- Electronics: DAE4 Sn1358; Calibrated: 2020.4.28
- Phantom: SAM1; Type: SAM; Serial: TP-1753
- Measurement SW: DASY52, Version 52.10 (4); SEMCAD X Version 14.6.14 (7483)

Pin=100mW/Area Scan (71x71x1): Interpolated grid: dx=1.000 mm, dy=1.000 mm

Maximum value of SAR (interpolated) = 20.4 W/kg

Pin=100mW/Zoom Scan (8x8x7)/Cube 0: Measurement grid: dx=4mm, dy=4mm, dz=1.4mm

Reference Value = 43.78 V/m; Power Drift = 0.05 dB

Peak SAR (extrapolated) = 37.0 W/kg

SAR(1 g) = 8.72 W/kg; SAR(10 g) = 2.52 W/kg

Maximum value of SAR (measured) = 20.1 W/kg

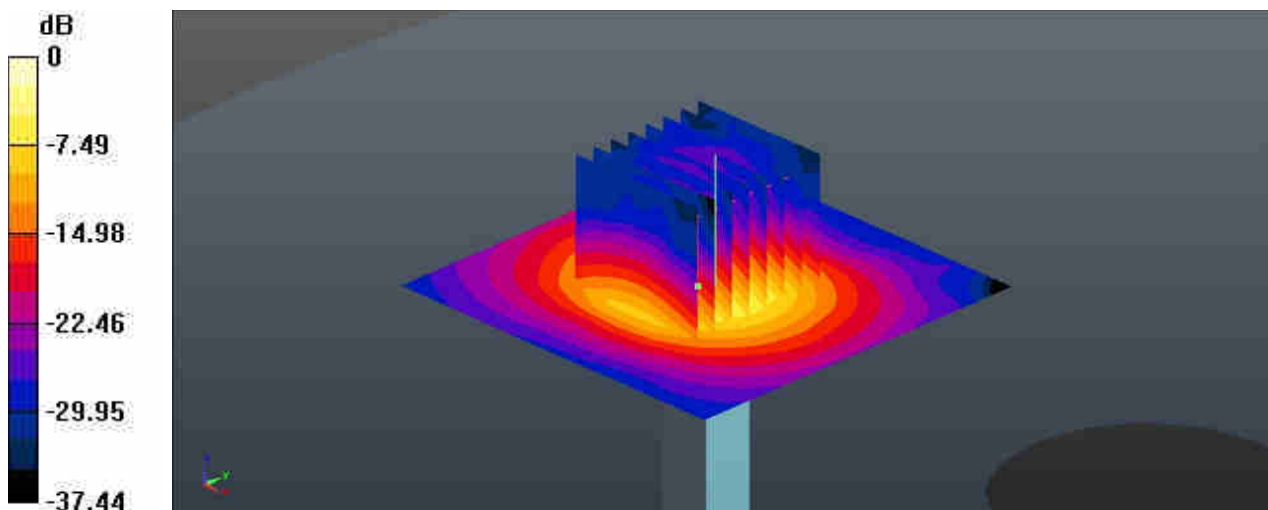

0 dB = 20.1 W/kg = 13.03 dBW/kg

System Check_Head_5750MHz

DUT: D5GHzV2 - SN:1113

Communication System: UID 0, CW (0); Frequency: 5750 MHz; Duty Cycle: 1:1
Medium: HSL_5000 Medium parameters used: $f = 5750$ MHz; $\sigma = 5.19$ S/m; $\epsilon_r = 34.53$; $\rho = 1000$ kg/m³

Ambient Temperature : 23.3 °C; Liquid Temperature : 22.7 °C

DASY5 Configuration:

- Probe: EX3DV4 - SN3935; ConvF(4.67, 4.67, 4.67); Calibrated: 2020.5.27
- Sensor-Surface: 1.4mm (Mechanical Surface Detection)
- Electronics: DAE4 Sn1358; Calibrated: 2020.4.28
- Phantom: SAM1; Type: SAM; Serial: TP-1753
- Measurement SW: DASY52, Version 52.10 (4); SEMCAD X Version 14.6.14 (7483)

Pin=100mW/Area Scan (71x71x1): Interpolated grid: dx=1.000 mm, dy=1.000 mm
Maximum value of SAR (interpolated) = 18.8 W/kg

Pin=100mW/Zoom Scan (8x8x7)/Cube 0: Measurement grid: dx=4mm, dy=4mm, dz=1.4mm
Reference Value = 41.31 V/m; Power Drift = 0.03 dB
Peak SAR (extrapolated) = 36.0 W/kg
SAR(1 g) = 8.2 W/kg; SAR(10 g) = 2.34 W/kg
Maximum value of SAR (measured) = 19.3 W/kg

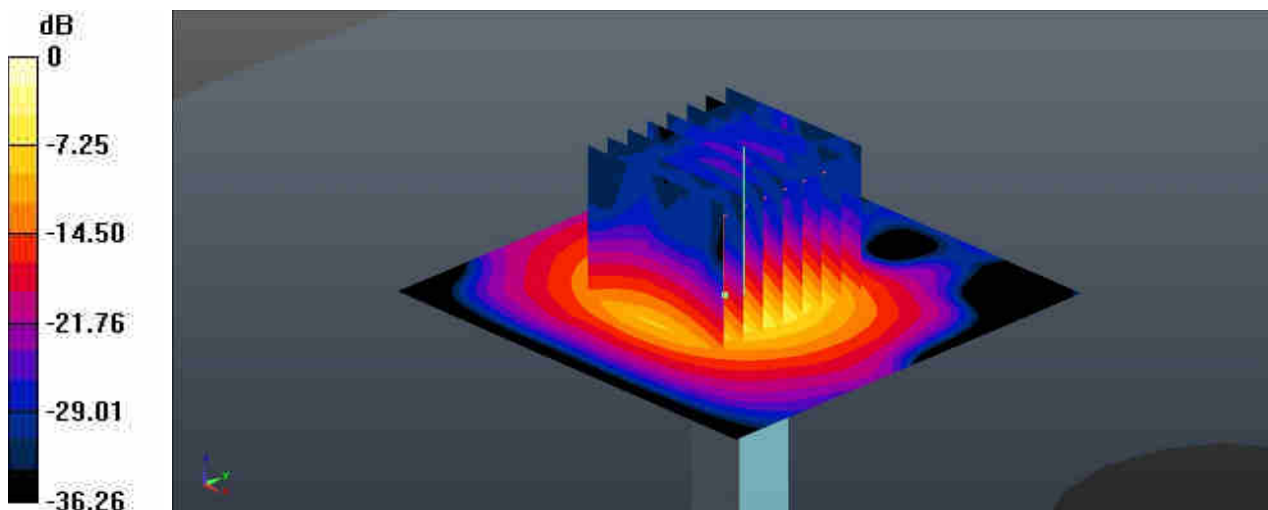

0 dB = 19.3 W/kg = 12.86 dBW/kg



Appendix B. Plots of High SAR Measurement

The plots are shown as follows.

01_GSM850_GPRS 2 Tx slots_Right Cheek_0mm_Ch189

Communication System: UID 0, GSM 2Tx slots (0); Frequency: 836.4 MHz; Duty Cycle: 1:4.15
 Medium: HSL_835 Medium parameters used: $f = 836.4$ MHz; $\sigma = 0.916$ S/m; $\epsilon_r = 41.246$; $\rho = 1000$ kg/m³

Ambient Temperature : 23.2 °C; Liquid Temperature : 22.9 °C

DASY5 Configuration:

- Probe: EX3DV4 - SN3935; ConvF(10.31, 10.31, 10.31); Calibrated: 2020.5.27
- Sensor-Surface: 1.4mm (Mechanical Surface Detection)
- Electronics: DAE4 Sn1358; Calibrated: 2020.4.28
- Phantom: SAM1; Type: SAM; Serial: TP-1753
- Measurement SW: DASY52, Version 52.10 (4); SEMCAD X Version 14.6.14 (7483)

Area Scan (71x71x1): Interpolated grid: dx=1.500 mm, dy=1.500 mm
 Maximum value of SAR (interpolated) = 0.438 W/kg

Zoom Scan (6x6x7)/Cube 0: Measurement grid: dx=8mm, dy=8mm, dz=5mm
 Reference Value = 5.927 V/m; Power Drift = 0.01 dB
 Peak SAR (extrapolated) = 0.470 W/kg
SAR(1 g) = 0.354 W/kg; SAR(10 g) = 0.267 W/kg
 Maximum value of SAR (measured) = 0.425 W/kg

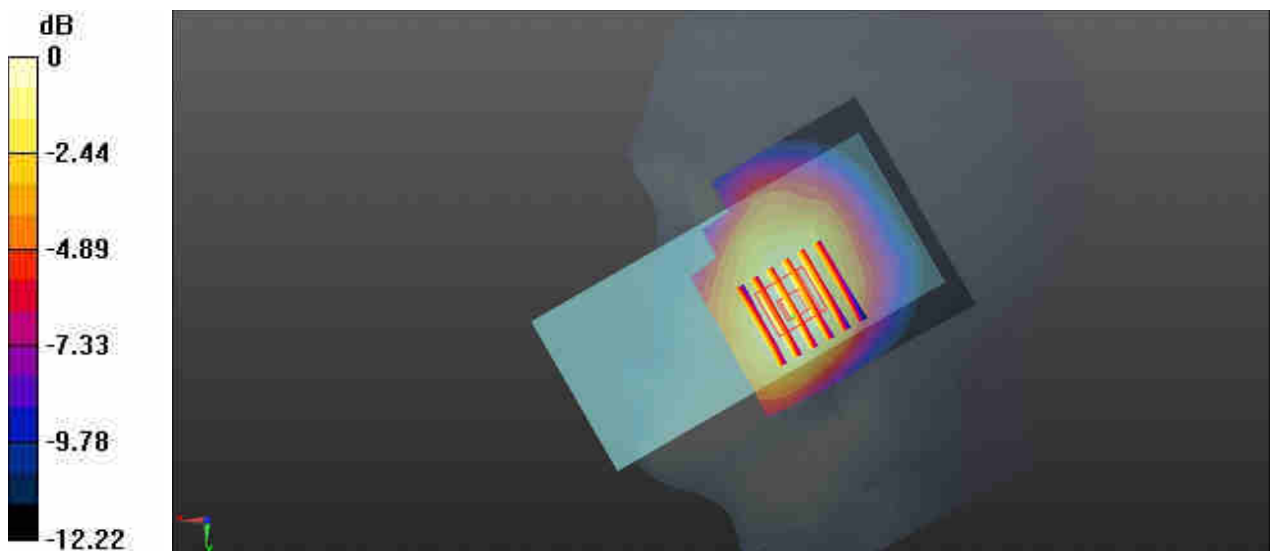

0 dB = 0.425 W/kg = -3.72 dBW/kg

02_GSM1900_GPRS 2 Tx slots_Right Cheek_0mm_Ch661

Communication System: UID 0, GSM 2Tx slots (0); Frequency: 1880 MHz; Duty Cycle: 1:4.15
Medium: HSL_1900 Medium parameters used: $f = 1880$ MHz; $\sigma = 1.38$ S/m; $\epsilon_r = 40.24$; $\rho = 1000$ kg/m³

Ambient Temperature : 23.2 °C; Liquid Temperature : 22.9 °C

DASY5 Configuration:

- Probe: EX3DV4 - SN3935; ConvF(8.35, 8.35, 8.35); Calibrated: 2020.5.27
- Sensor-Surface: 1.4mm (Mechanical Surface Detection)
- Electronics: DAE4 Sn1358; Calibrated: 2020.4.28
- Phantom: SAM1; Type: SAM; Serial: TP-1753
- Measurement SW: DASY52, Version 52.10 (4); SEMCAD X Version 14.6.14 (7483)

Area Scan (81x71x1): Interpolated grid: dx=1.500 mm, dy=1.500 mm
Maximum value of SAR (interpolated) = 0.0607 W/kg

Zoom Scan (5x5x7)/Cube 0: Measurement grid: dx=8mm, dy=8mm, dz=5mm
Reference Value = 1.895 V/m; Power Drift = -0.01 dB
Peak SAR (extrapolated) = 0.0640 W/kg
SAR(1 g) = 0.039 W/kg; SAR(10 g) = 0.024 W/kg
Maximum value of SAR (measured) = 0.0539 W/kg

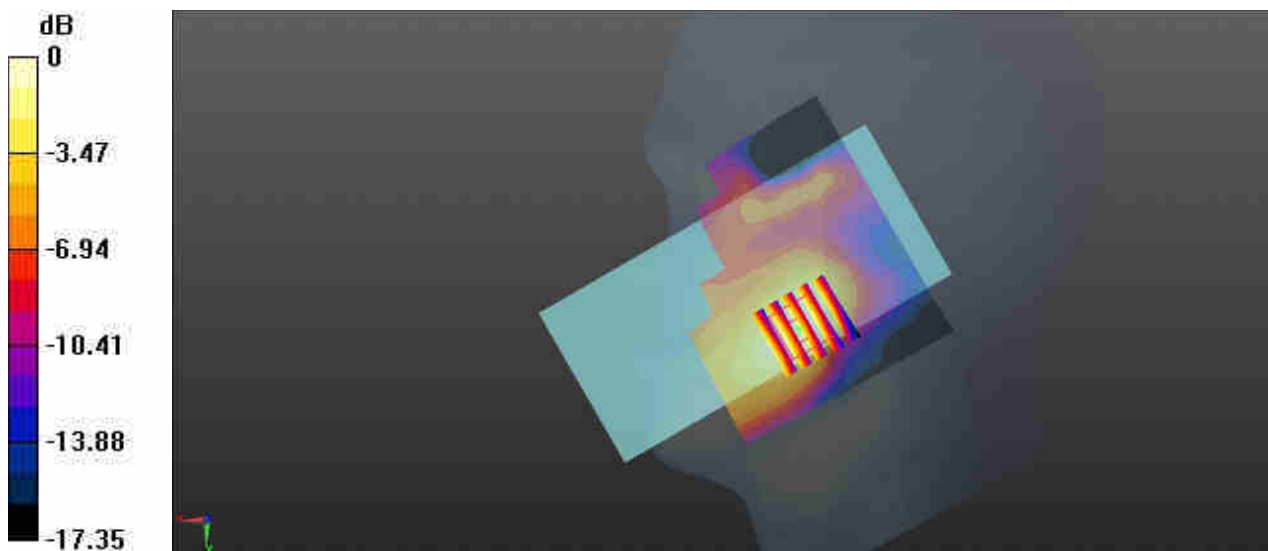

0 dB = 0.0539 W/kg = -12.68 dBW/kg

03_WCDMA II_RMC 12.2Kbps_Right Cheek_0mm_Ch9400

Communication System: UID 0, WCDMA (0); Frequency: 1880 MHz; Duty Cycle: 1:1
Medium: HSL_1900 Medium parameters used: $f = 1880$ MHz; $\sigma = 1.38$ S/m; $\epsilon_r = 40.24$; $\rho = 1000$ kg/m³

Ambient Temperature : 23.2 °C; Liquid Temperature : 22.9 °C

DASY5 Configuration:

- Probe: EX3DV4 - SN3935; ConvF(8.35, 8.35, 8.35); Calibrated: 2020.5.27
- Sensor-Surface: 1.4mm (Mechanical Surface Detection)
- Electronics: DAE4 Sn1358; Calibrated: 2020.4.28
- Phantom: SAM1; Type: SAM; Serial: TP-1753
- Measurement SW: DASY52, Version 52.10 (4); SEMCAD X Version 14.6.14 (7483)

Area Scan (71x71x1): Interpolated grid: dx=1.500 mm, dy=1.500 mm
Maximum value of SAR (interpolated) = 0.260 W/kg

Zoom Scan (5x5x7)/Cube 0: Measurement grid: dx=8mm, dy=8mm, dz=5mm

Reference Value = 3.584 V/m; Power Drift = -0.01 dB

Peak SAR (extrapolated) = 0.297 W/kg

SAR(1 g) = 0.179 W/kg; SAR(10 g) = 0.110 W/kg

Maximum value of SAR (measured) = 0.251 W/kg

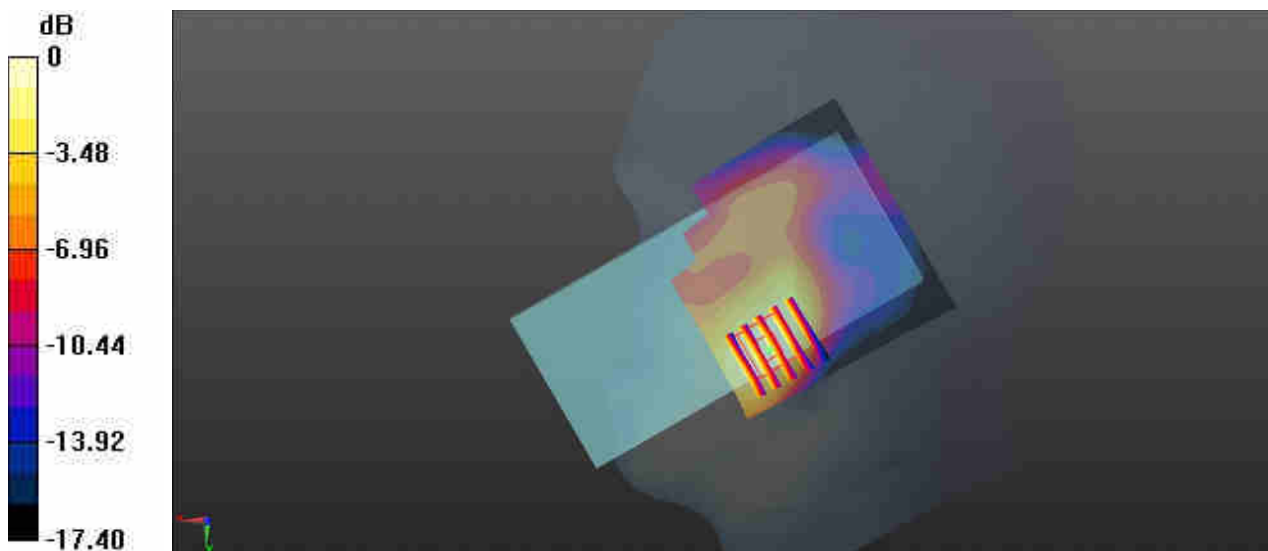

0 dB = 0.251 W/kg = -6.00 dBW/kg

04_WCDMA IV_RMC 12.2Kbps_Left Cheek_0mm_Ch1413

Communication System: UID 0, WCDMA (0); Frequency: 1732.6 MHz; Duty Cycle: 1:1
Medium: HSL_1750 Medium parameters used: $f = 1733$ MHz; $\sigma = 1.363$ S/m; $\epsilon_r = 41.154$; $\rho = 1000$ kg/m³

Ambient Temperature : 23.4 °C; Liquid Temperature : 22.8 °C

DASY5 Configuration:

- Probe: EX3DV4 - SN3935; ConvF(8.6, 8.6, 8.6); Calibrated: 2020.5.27
- Sensor-Surface: 1.4mm (Mechanical Surface Detection)
- Electronics: DAE4 Sn1358; Calibrated: 2020.4.28
- Phantom: SAM1; Type: SAM; Serial: TP-1753
- Measurement SW: DASY52, Version 52.10 (4); SEMCAD X Version 14.6.14 (7483)

Area Scan (71x71x1): Interpolated grid: dx=1.500 mm, dy=1.500 mm
Maximum value of SAR (interpolated) = 0.257 W/kg

Zoom Scan (5x5x7)/Cube 0: Measurement grid: dx=8mm, dy=8mm, dz=5mm

Reference Value = 4.639 V/m; Power Drift = 0.16 dB

Peak SAR (extrapolated) = 0.279 W/kg

SAR(1 g) = 0.177 W/kg; SAR(10 g) = 0.113 W/kg

Maximum value of SAR (measured) = 0.239 W/kg

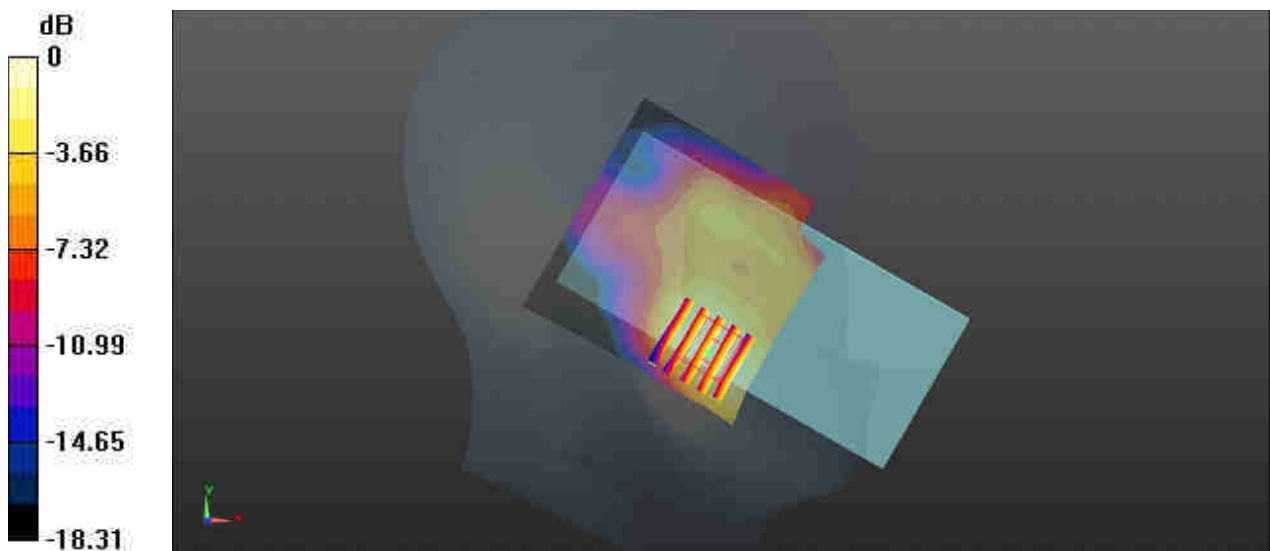

0 dB = 0.239 W/kg = -6.22 dBW/kg

05_WCDMA V_RMC 12.2Kbps_Right Cheek_0mm_Ch4182

Communication System: UID 0, WCDMA (0); Frequency: 836.4 MHz; Duty Cycle: 1:1
 Medium: HSL_835 Medium parameters used: $f = 836.4 \text{ MHz}$; $\sigma = 0.916 \text{ S/m}$; $\epsilon_r = 41.246$; $\rho = 1000 \text{ kg/m}^3$

Ambient Temperature : 23.2 °C; Liquid Temperature : 22.9 °C

DASY5 Configuration:

- Probe: EX3DV4 - SN3935; ConvF(10.31, 10.31, 10.31); Calibrated: 2020.5.27
- Sensor-Surface: 1.4mm (Mechanical Surface Detection)
- Electronics: DAE4 Sn1358; Calibrated: 2020.4.28
- Phantom: SAM1; Type: SAM; Serial: TP-1753
- Measurement SW: DASY52, Version 52.10 (4); SEMCAD X Version 14.6.14 (7483)

Area Scan (71x71x1): Interpolated grid: $dx=1.500 \text{ mm}$, $dy=1.500 \text{ mm}$
 Maximum value of SAR (interpolated) = 0.680 W/kg

Zoom Scan (6x6x7)/Cube 0: Measurement grid: $dx=8\text{mm}$, $dy=8\text{mm}$, $dz=5\text{mm}$
 Reference Value = 8.800 V/m; Power Drift = -0.10 dB
 Peak SAR (extrapolated) = 0.733 W/kg
SAR(1 g) = 0.546 W/kg; SAR(10 g) = 0.411 W/kg
 Maximum value of SAR (measured) = 0.665 W/kg

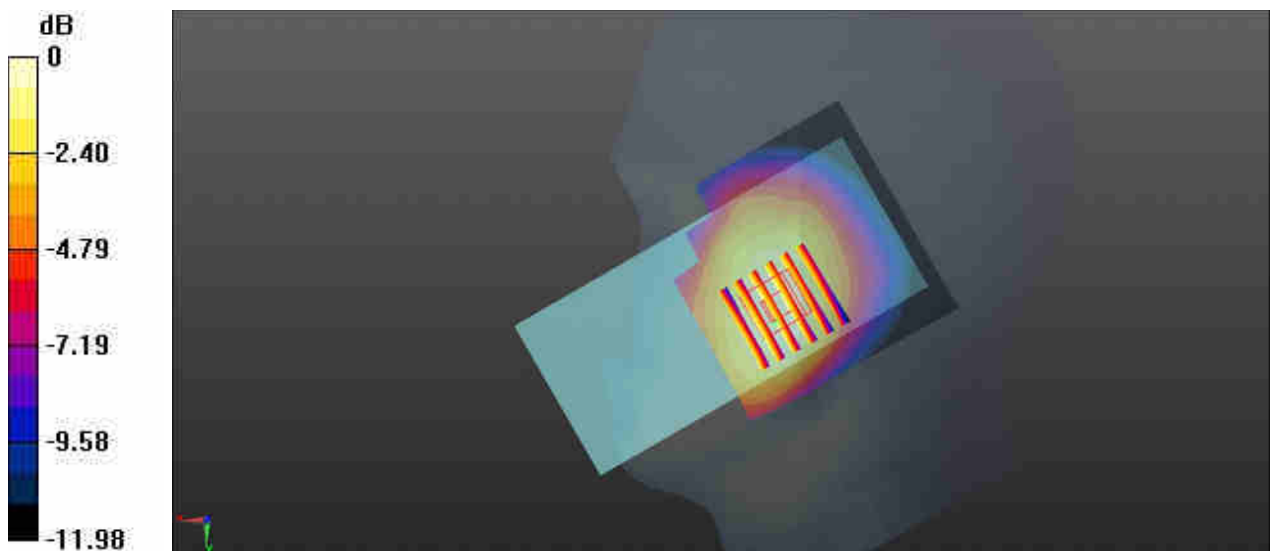

0 dB = 0.665 W/kg = -1.77 dBW/kg

06_LTE Band 2_20M_QPSK_1RB_0Offset_Right Cheek_0mm_Ch18900

Communication System: UID 0, LTE FDD (0); Frequency: 1880 MHz; Duty Cycle: 1:1
Medium: HSL_1900 Medium parameters used: $f = 1880$ MHz; $\sigma = 1.38$ S/m; $\epsilon_r = 40.24$; $\rho = 1000$ kg/m³

Ambient Temperature : 23.2 °C; Liquid Temperature : 22.9 °C

DASY5 Configuration:

- Probe: EX3DV4 - SN3935; ConvF(8.35, 8.35, 8.35); Calibrated: 2020.5.27
- Sensor-Surface: 1.4mm (Mechanical Surface Detection)
- Electronics: DAE4 Sn1358; Calibrated: 2020.4.28
- Phantom: SAM1; Type: SAM; Serial: TP-1753
- Measurement SW: DASY52, Version 52.10 (4); SEMCAD X Version 14.6.14 (7483)

Area Scan (81x71x1): Interpolated grid: dx=1.500 mm, dy=1.500 mm
Maximum value of SAR (interpolated) = 0.165 W/kg

Zoom Scan (5x5x7)/Cube 0: Measurement grid: dx=8mm, dy=8mm, dz=5mm

Reference Value = 2.606 V/m; Power Drift = 0.03 dB

Peak SAR (extrapolated) = 0.184 W/kg

SAR(1 g) = 0.110 W/kg; SAR(10 g) = 0.069 W/kg

Maximum value of SAR (measured) = 0.149 W/kg

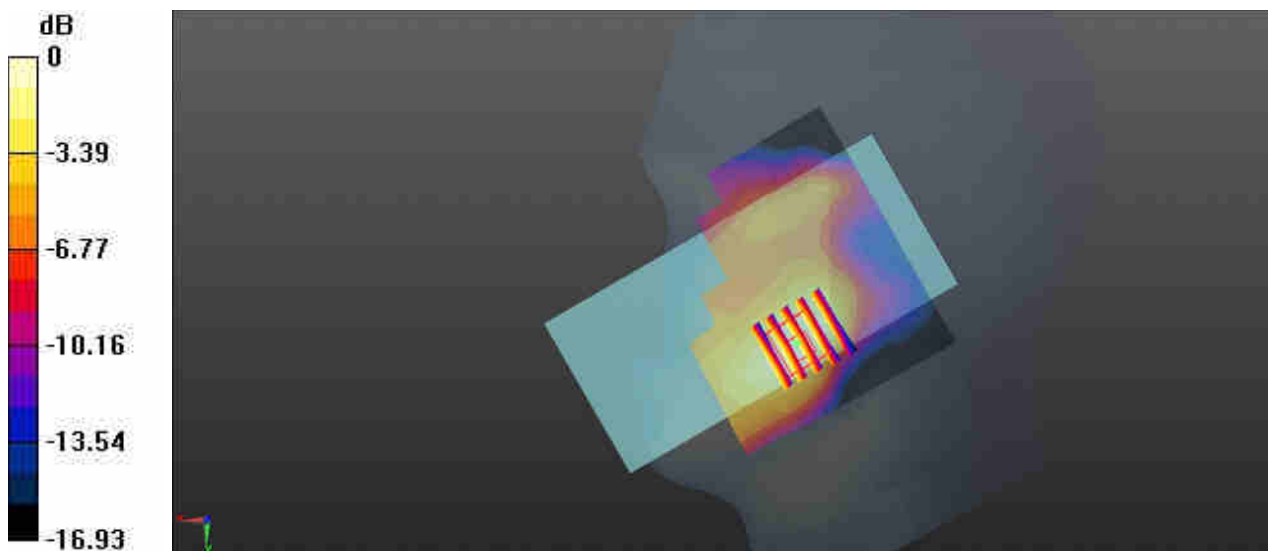

0 dB = 0.149 W/kg = -8.27 dBW/kg

07_LTE Band 5_10M_QPSK_1RB_0Offset_Right Cheek_0mm_Ch20525

Communication System: UID 0, LTE FDD (0); Frequency: 836.5 MHz; Duty Cycle: 1:1
Medium: HSL_835 Medium parameters used: $f = 836.5$ MHz; $\sigma = 0.916$ S/m; $\epsilon_r = 41.245$; $\rho = 1000$ kg/m³

Ambient Temperature : 23.2 °C; Liquid Temperature : 22.9 °C

DASY5 Configuration:

- Probe: EX3DV4 - SN3935; ConvF(10.31, 10.31, 10.31); Calibrated: 2020.5.27
- Sensor-Surface: 1.4mm (Mechanical Surface Detection)
- Electronics: DAE4 Sn1358; Calibrated: 2020.4.28
- Phantom: SAM1; Type: SAM; Serial: TP-1753
- Measurement SW: DASY52, Version 52.10 (4); SEMCAD X Version 14.6.14 (7483)

Area Scan (81x71x1): Interpolated grid: dx=1.500 mm, dy=1.500 mm
Maximum value of SAR (interpolated) = 0.464 W/kg

Zoom Scan (5x5x7)/Cube 0: Measurement grid: dx=8mm, dy=8mm, dz=5mm
Reference Value = 8.491 V/m; Power Drift = -0.06 dB
Peak SAR (extrapolated) = 0.564 W/kg
SAR(1 g) = 0.381 W/kg; SAR(10 g) = 0.281 W/kg
Maximum value of SAR (measured) = 0.507 W/kg

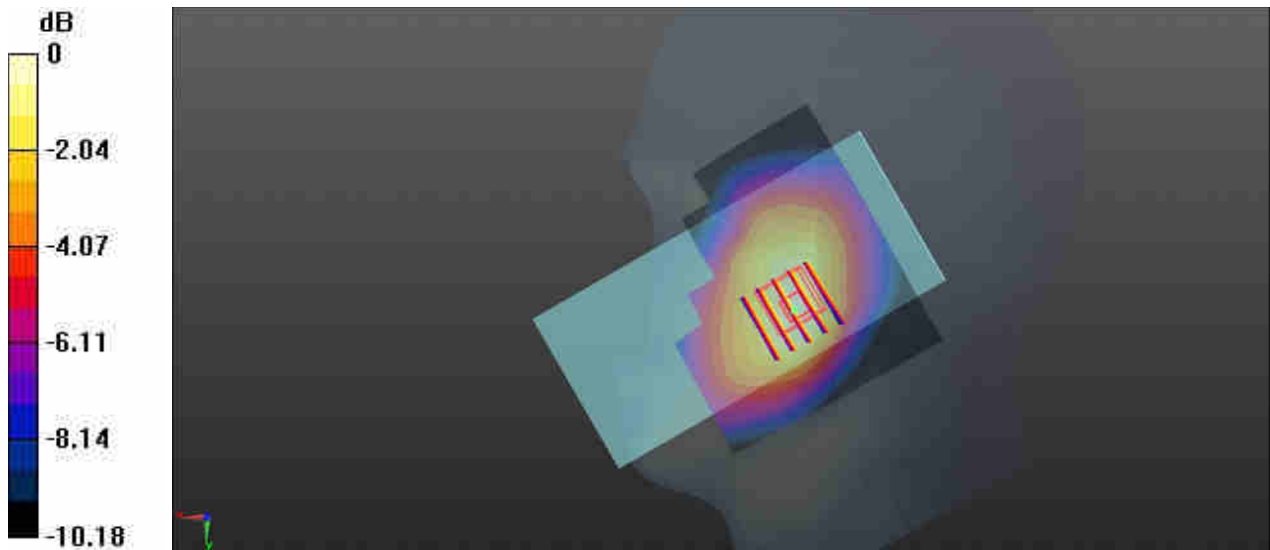

0 dB = 0.507 W/kg = -2.95 dBW/kg

08_LTE Band 12_10M_QPSK_1RB_0Offset_Right Cheek_0mm_Ch23095

Communication System: UID 0, LTE FDD (0); Frequency: 707.5 MHz; Duty Cycle: 1:1
Medium: HSL_750 Medium parameters used: $f = 707.5$ MHz; $\sigma = 0.871$ S/m; $\epsilon_r = 42.844$; $\rho = 1000$ kg/m³

Ambient Temperature : 23.3 °C; Liquid Temperature : 22.7 °C

DASY5 Configuration:

- Probe: EX3DV4 - SN3935; ConvF(10.58, 10.58, 10.58); Calibrated: 2020.5.27
- Sensor-Surface: 1.4mm (Mechanical Surface Detection)
- Electronics: DAE4 Sn1358; Calibrated: 2020.4.28
- Phantom: SAM1; Type: SAM; Serial: TP-1753
- Measurement SW: DASY52, Version 52.10 (4); SEMCAD X Version 14.6.14 (7483)

Area Scan (81x71x1): Interpolated grid: dx=1.500 mm, dy=1.500 mm
Maximum value of SAR (interpolated) = 0.435 W/kg

Zoom Scan (6x5x7)/Cube 0: Measurement grid: dx=8mm, dy=8mm, dz=5mm
Reference Value = 6.616 V/m; Power Drift = 0.01 dB
Peak SAR (extrapolated) = 0.459 W/kg
SAR(1 g) = 0.363 W/kg; SAR(10 g) = 0.281 W/kg
Maximum value of SAR (measured) = 0.423 W/kg

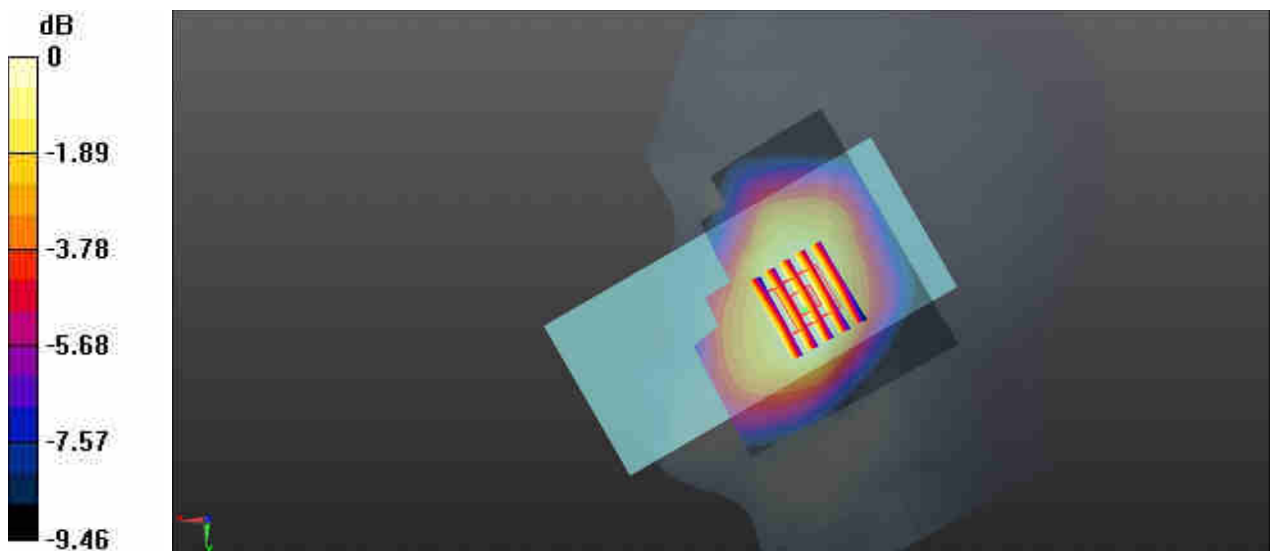

0 dB = 0.423 W/kg = -3.74 dBW/kg

09_LTE Band 14_10M_QPSK_1RB_0Offset_Right Cheek_0mm_Ch23330

Communication System: UID 0, LTE FDD (0); Frequency: 793 MHz;Duty Cycle: 1:1
Medium: HSL_750 Medium parameters used: $f = 793 \text{ MHz}$; $\sigma = 0.952 \text{ S/m}$; $\epsilon_r = 41.658$; $\rho = 1000 \text{ kg/m}^3$

Ambient Temperature : 23.3 °C; Liquid Temperature : 22.7 °C

DASY5 Configuration:

- Probe: EX3DV4 - SN3935; ConvF(10.58, 10.58, 10.58); Calibrated: 2020.5.27
- Sensor-Surface: 1.4mm (Mechanical Surface Detection)
- Electronics: DAE4 Sn1358; Calibrated: 2020.4.28
- Phantom: SAM1; Type: SAM; Serial: TP-1753
- Measurement SW: DASY52, Version 52.10 (4); SEMCAD X Version 14.6.14 (7483)

Area Scan (81x71x1): Interpolated grid: $dx=1.500 \text{ mm}$, $dy=1.500 \text{ mm}$
Maximum value of SAR (interpolated) = 0.482 W/kg

Zoom Scan (6x6x7)/Cube 0: Measurement grid: $dx=8\text{mm}$, $dy=8\text{mm}$, $dz=5\text{mm}$
Reference Value = 6.617 V/m; Power Drift = -0.18 dB
Peak SAR (extrapolated) = 0.566 W/kg
SAR(1 g) = 0.400 W/kg; SAR(10 g) = 0.306 W/kg
Maximum value of SAR (measured) = 0.514 W/kg

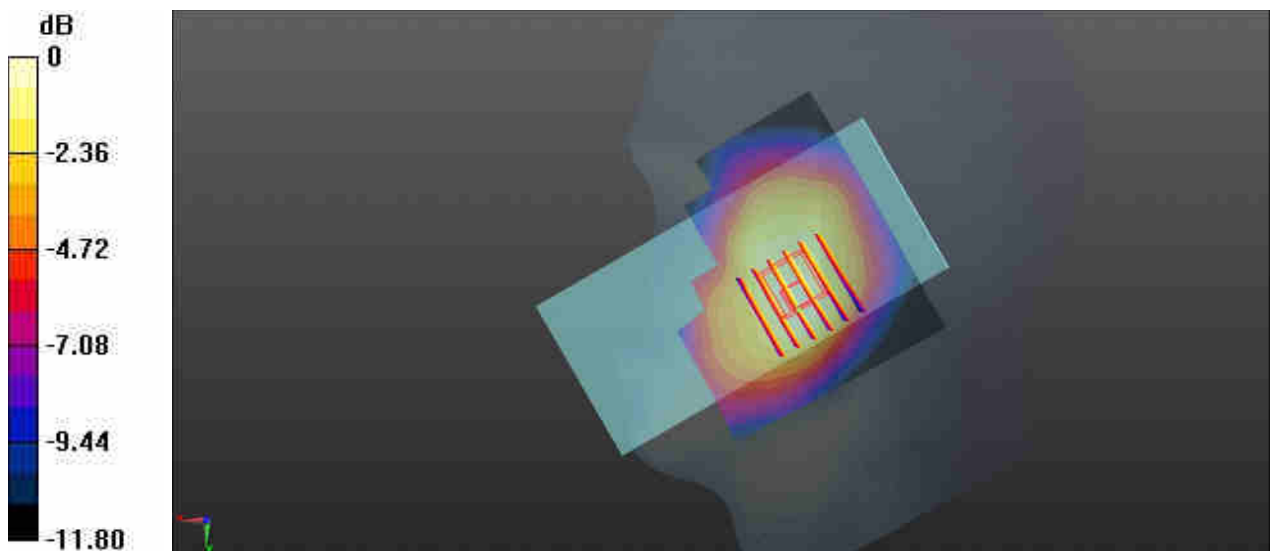

0 dB = 0.514 W/kg = -2.89 dBW/kg

10_LTE Band 30_10M_QPSK_1RB_0Offset_Left Cheek_0mm_Ch27710

Communication System: UID 0, LTE FDD (0); Frequency: 2310 MHz; Duty Cycle: 1:1
Medium: HSL_2300 Medium parameters used: $f = 2310$ MHz; $\sigma = 1.702$ S/m; $\epsilon_r = 39.158$; $\rho = 1000$ kg/m³

Ambient Temperature : 23.3 °C; Liquid Temperature : 22.8 °C

DASY5 Configuration:

- Probe: EX3DV4 - SN3935; ConvF(7.86, 7.86, 7.86); Calibrated: 2020.5.27
- Sensor-Surface: 1.4mm (Mechanical Surface Detection)
- Electronics: DAE4 Sn1358; Calibrated: 2020.4.28
- Phantom: SAM1; Type: SAM; Serial: TP-1753
- Measurement SW: DASY52, Version 52.10 (4); SEMCAD X Version 14.6.14 (7483)

Area Scan (101x81x1): Interpolated grid: $dx=1.200$ mm, $dy=1.200$ mm
Maximum value of SAR (interpolated) = 0.732 W/kg

Zoom Scan (7x7x7)/Cube 0: Measurement grid: $dx=5$ mm, $dy=5$ mm, $dz=5$ mm

Reference Value = 5.249 V/m; Power Drift = -0.18 dB

Peak SAR (extrapolated) = 0.868 W/kg

SAR(1 g) = 0.497 W/kg; SAR(10 g) = 0.290 W/kg

Maximum value of SAR (measured) = 0.732 W/kg

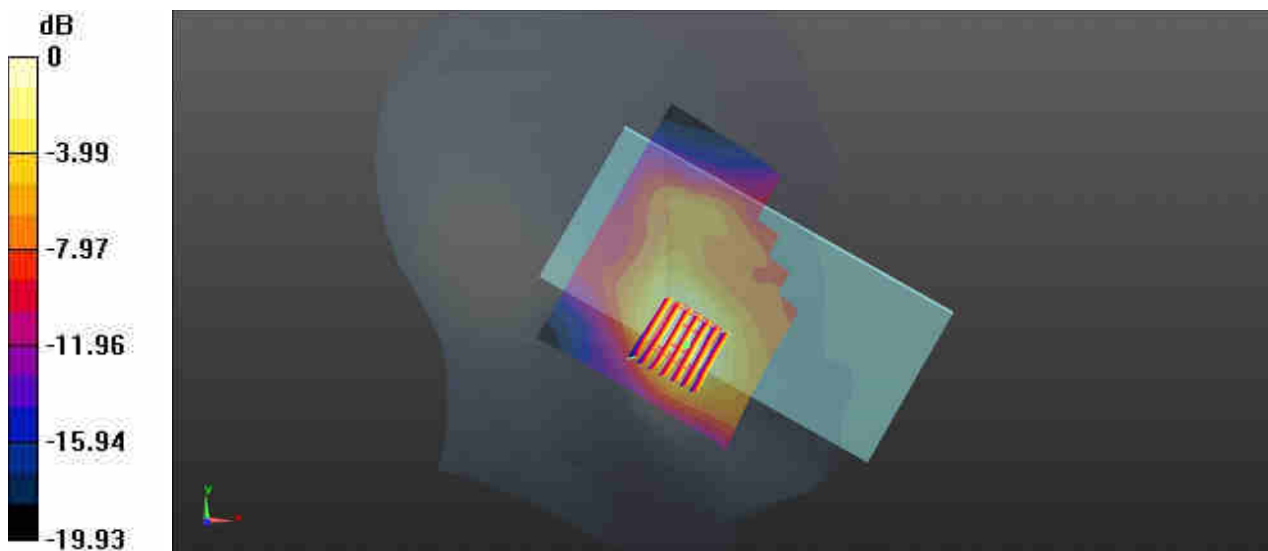

0 dB = 0.732 W/kg = -1.35 dBW/kg

11_LTE Band 66_20M_QPSK_1RB_0Offset_Left Cheek_0mm_Ch132322

Communication System: UID 0, LTE FDD (0); Frequency: 1745 MHz; Duty Cycle: 1:1
Medium: HSL_1750 Medium parameters used: $f = 1745$ MHz; $\sigma = 1.377$ S/m; $\epsilon_r = 41.098$; $\rho = 1000$ kg/m³

Ambient Temperature : 23.4 °C; Liquid Temperature : 22.8 °C

DASY5 Configuration:

- Probe: EX3DV4 - SN3935; ConvF(8.6, 8.6, 8.6); Calibrated: 2020.5.27
- Sensor-Surface: 1.4mm (Mechanical Surface Detection)
- Electronics: DAE4 Sn1358; Calibrated: 2020.4.28
- Phantom: SAM1; Type: SAM; Serial: TP-1753
- Measurement SW: DASY52, Version 52.10 (4); SEMCAD X Version 14.6.14 (7483)

Area Scan (81x71x1): Interpolated grid: dx=1.500 mm, dy=1.500 mm
Maximum value of SAR (interpolated) = 0.207 W/kg

Zoom Scan (5x5x7)/Cube 0: Measurement grid: dx=8mm, dy=8mm, dz=5mm
Reference Value = 4.875 V/m; Power Drift = 0.08 dB
Peak SAR (extrapolated) = 0.236 W/kg
SAR(1 g) = 0.149 W/kg; SAR(10 g) = 0.096 W/kg
Maximum value of SAR (measured) = 0.199 W/kg

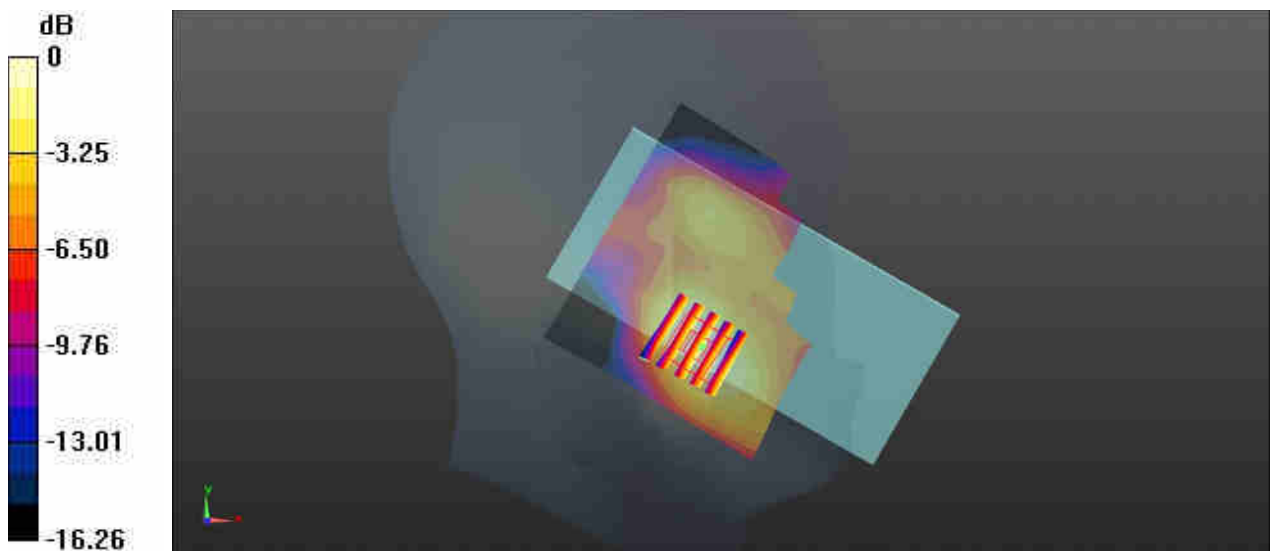

0 dB = 0.199 W/kg = -7.01 dBW/kg

12_WLAN2.4G_802.11b 1Mbps_Left Cheek_0mm_Ch1

Communication System: UID 0, WIFI2.4G (0); Frequency: 2412 MHz; Duty Cycle: 1:1.018
Medium: HSL_2450 Medium parameters used: $f = 2412$ MHz; $\sigma = 1.817$ S/m; $\epsilon_r = 38.756$; $\rho = 1000$ kg/m³

Ambient Temperature : 23.3 °C; Liquid Temperature : 22.8 °C

DASY5 Configuration:

- Probe: EX3DV4 - SN3935; ConvF(7.6, 7.6, 7.6); Calibrated: 2020.5.27
- Sensor-Surface: 1.4mm (Mechanical Surface Detection)
- Electronics: DAE4 Sn1358; Calibrated: 2020.4.28
- Phantom: SAM1; Type: SAM; Serial: TP-1753
- Measurement SW: DASY52, Version 52.10 (4); SEMCAD X Version 14.6.14 (7483)

Area Scan (81x71x1): Interpolated grid: dx=1.200 mm, dy=1.200 mm
Maximum value of SAR (interpolated) = 1.05 W/kg

Zoom Scan (8x8x7)/Cube 0: Measurement grid: dx=5mm, dy=5mm, dz=5mm
Reference Value = 22.47 V/m; Power Drift = -0.05 dB
Peak SAR (extrapolated) = 1.16 W/kg
SAR(1 g) = 0.570 W/kg; SAR(10 g) = 0.286 W/kg
Maximum value of SAR (measured) = 0.884 W/kg

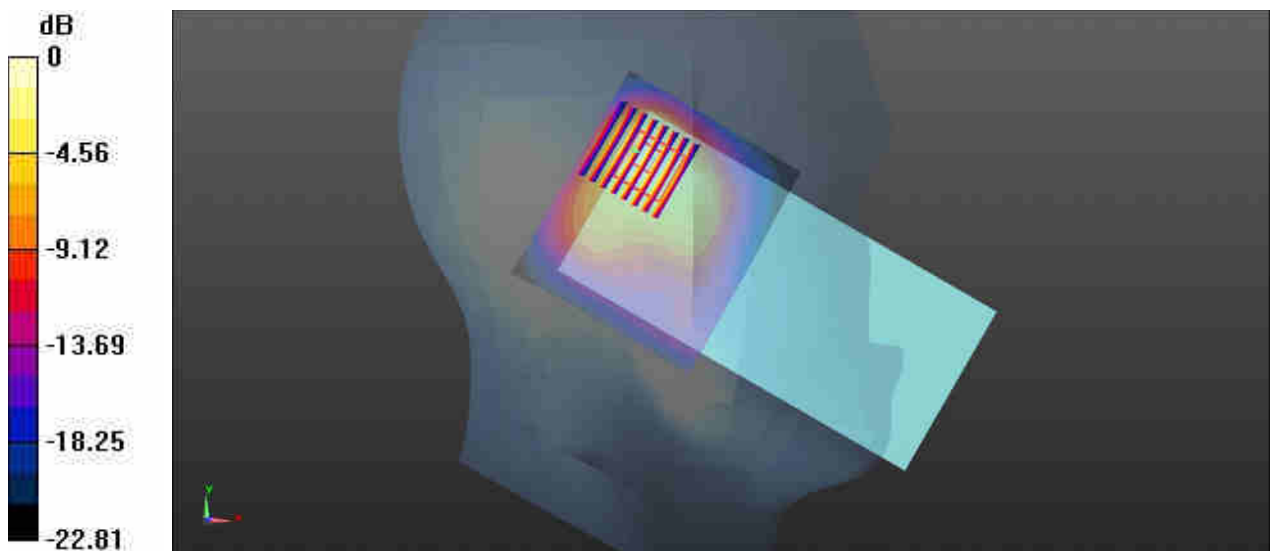

0 dB = 0.884 W/kg = -0.54 dBW/kg

13_Bluetooth_802.11b 1Mbps_Left Cheek_0mm_Ant 1_Ch39

Communication System: UID 0, Bluetooth (0); Frequency: 2441 MHz; Duty Cycle: 1:1.301
 Medium: HSL_2450 Medium parameters used: $f = 2441$ MHz; $\sigma = 1.851$ S/m; $\epsilon_r = 38.624$; $\rho = 1000$ kg/m³

Ambient Temperature : 23.3 °C; Liquid Temperature : 22.8 °C

DASY5 Configuration:

- Probe: EX3DV4 - SN3935; ConvF(7.6, 7.6, 7.6); Calibrated: 2020.5.27
- Sensor-Surface: 1.4mm (Mechanical Surface Detection)
- Electronics: DAE4 Sn1358; Calibrated: 2020.4.28
- Phantom: SAM1; Type: SAM; Serial: TP-1753
- Measurement SW: DASY52, Version 52.10 (4); SEMCAD X Version 14.6.14 (7483)

Area Scan (91x81x1): Interpolated grid: dx=1.200 mm, dy=1.200 mm
 Maximum value of SAR (interpolated) = 0.399 W/kg

Zoom Scan (8x7x7)/Cube 0: Measurement grid: dx=5mm, dy=5mm, dz=5mm
 Reference Value = 9.028 V/m; Power Drift = 0.05 dB
 Peak SAR (extrapolated) = 0.550 W/kg
SAR(1 g) = 0.266 W/kg; SAR(10 g) = 0.133 W/kg
 Maximum value of SAR (measured) = 0.420 W/kg

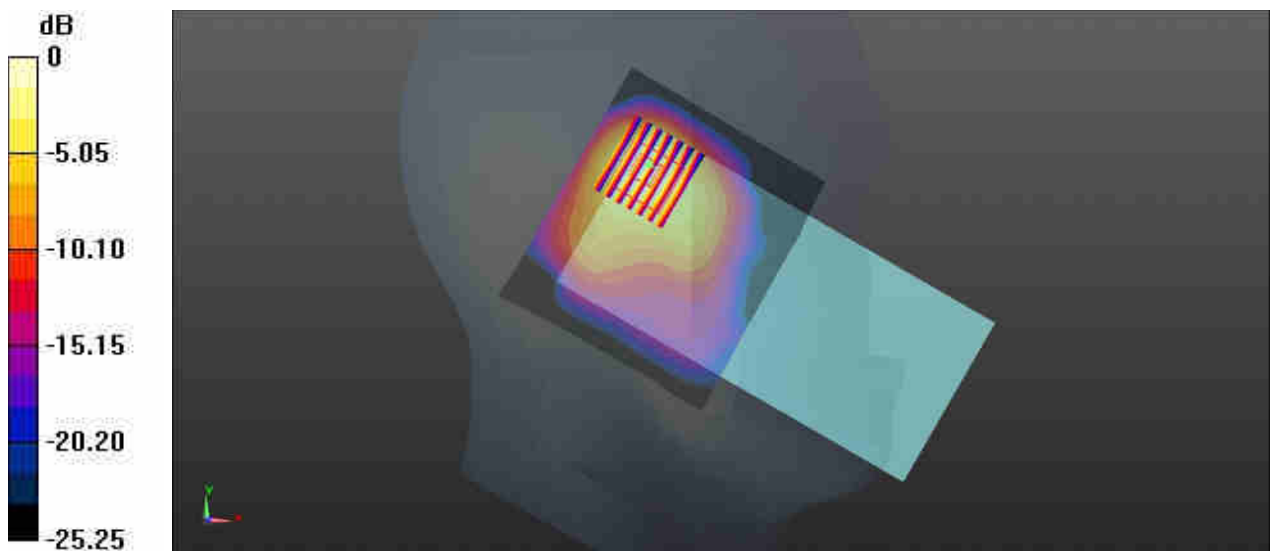

0 dB = 0.420 W/kg = -3.77 dBW/kg

14_WLAN5GHz_802.11n-HT40 MCS0_Right Cheek_0mm_Ch54

Communication System: UID 0, WLAN5G (0); Frequency: 5270 MHz; Duty Cycle: 1:1.041
Medium: HSL_5000 Medium parameters used: $f = 5270$ MHz; $\sigma = 4.703$ S/m; $\epsilon_r = 35.294$; $\rho = 1000$ kg/m³

Ambient Temperature : 23.1 °C; Liquid Temperature : 22.7 °C

DASY5 Configuration:

- Probe: EX3DV4 - SN3935; ConvF(5.04, 5.04, 5.04); Calibrated: 2020.5.27
- Sensor-Surface: 1.4mm (Mechanical Surface Detection)
- Electronics: DAE4 Sn1358; Calibrated: 2020.4.28
- Phantom: SAM1; Type: SAM; Serial: TP-1753
- Measurement SW: DASY52, Version 52.10 (4); SEMCAD X Version 14.6.14 (7483)

Area Scan (101x91x1): Interpolated grid: dx=1.000 mm, dy=1.000 mm
Maximum value of SAR (interpolated) = 0.179 W/kg

Zoom Scan (8x9x7)/Cube 0: Measurement grid: dx=4mm, dy=4mm, dz=1.4mm

Reference Value = 5.879 V/m; Power Drift = 0.07 dB

Peak SAR (extrapolated) = 0.209 W/kg

SAR(1 g) = 0.068 W/kg; SAR(10 g) = 0.032 W/kg

Maximum value of SAR (measured) = 0.140 W/kg

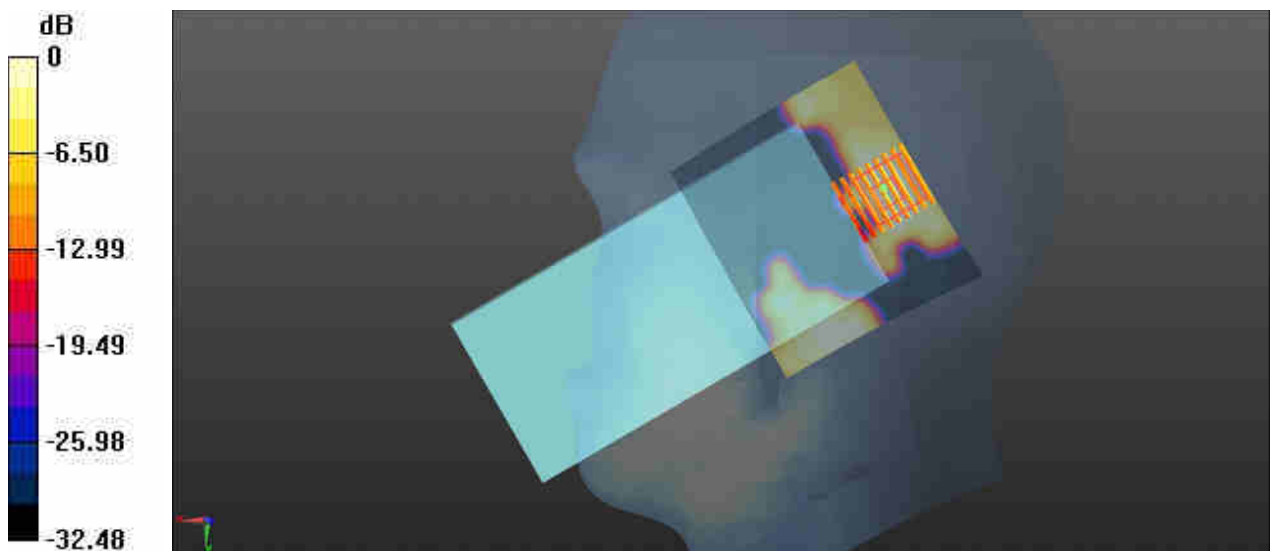

0 dB = 0.140 W/kg = -8.54 dBW/kg

15_WLAN5GHz_802.11n-HT40 MCS0_Right Cheek_0mm_Ch110

Communication System: UID 0, WLAN5G (0); Frequency: 5550 MHz; Duty Cycle: 1:1.041
Medium: HSL_5000 Medium parameters used: $f = 5550$ MHz; $\sigma = 4.982$ S/m; $\epsilon_r = 34.851$; $\rho = 1000$ kg/m³

Ambient Temperature : 23.3 °C; Liquid Temperature : 22.6 °C

DASY5 Configuration:

- Probe: EX3DV4 - SN3935; ConvF(4.76, 4.76, 4.76); Calibrated: 2020.5.27
- Sensor-Surface: 1.4mm (Mechanical Surface Detection)
- Electronics: DAE4 Sn1358; Calibrated: 2020.4.28
- Phantom: SAM1; Type: SAM; Serial: TP-1753
- Measurement SW: DASY52, Version 52.10 (4); SEMCAD X Version 14.6.14 (7483)

Area Scan (111x81x1): Interpolated grid: dx=1.000 mm, dy=1.000 mm
Maximum value of SAR (interpolated) = 0.140 W/kg

Zoom Scan (9x9x7)/Cube 0: Measurement grid: dx=4mm, dy=4mm, dz=1.4mm

Reference Value = 5.382 V/m; Power Drift = -0.15 dB

Peak SAR (extrapolated) = 0.288 W/kg

SAR(1 g) = 0.056 W/kg; SAR(10 g) = 0.029 W/kg

Maximum value of SAR (measured) = 0.117 W/kg

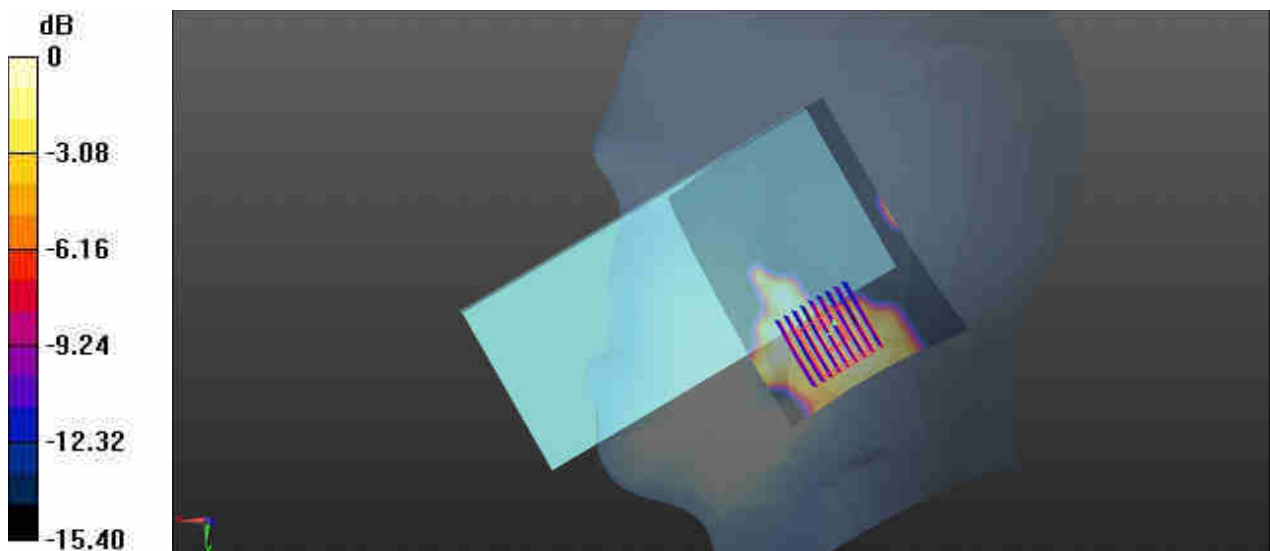

0 dB = 0.117 W/kg = -9.32 dBW/kg

16_WLAN5GHz_802.11n-HT40 MCS0_Left Cheek_0mm_Ch151

Communication System: UID 0, WLAN5G (0); Frequency: 5755 MHz; Duty Cycle: 1:1.041
Medium: HSL_5000 Medium parameters used: $f = 5755$ MHz; $\sigma = 5.196$ S/m; $\epsilon_r = 34.527$; $\rho = 1000$ kg/m³

Ambient Temperature : 23.3 °C; Liquid Temperature : 22.7 °C

DASY5 Configuration:

- Probe: EX3DV4 - SN3935; ConvF(4.67, 4.67, 4.67); Calibrated: 2020.5.27
- Sensor-Surface: 1.4mm (Mechanical Surface Detection)
- Electronics: DAE4 Sn1358; Calibrated: 2020.4.28
- Phantom: SAM1; Type: SAM; Serial: TP-1753
- Measurement SW: DASY52, Version 52.10 (4); SEMCAD X Version 14.6.14 (7483)

Area Scan (121x91x1): Interpolated grid: dx=1.000 mm, dy=1.000 mm
Maximum value of SAR (interpolated) = 0.304 W/kg

Zoom Scan (9x9x7)/Cube 0: Measurement grid: dx=4mm, dy=4mm, dz=1.4mm

Reference Value = 1.327 V/m; Power Drift = -0.01 dB

Peak SAR (extrapolated) = 0.485 W/kg

SAR(1 g) = 0.138 W/kg; SAR(10 g) = 0.053 W/kg

Maximum value of SAR (measured) = 0.307 W/kg

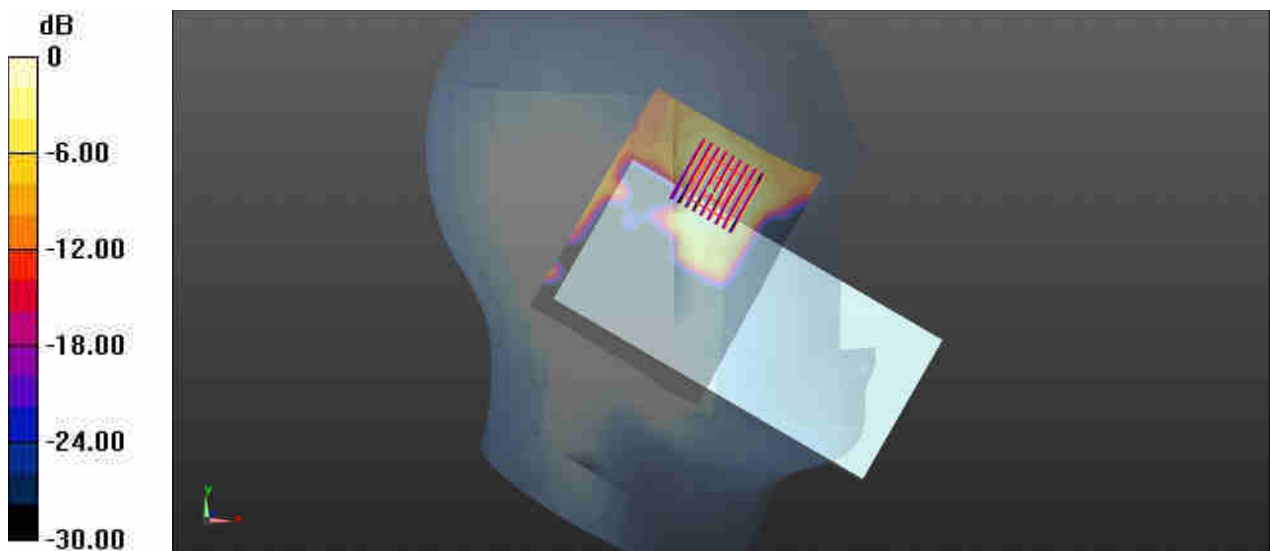

0 dB = 0.307 W/kg = -5.13 dBW/kg

17_GSM850_GPRS 2 Tx slots_Front_5mm_Ch128

Communication System: UID 0, GSM 2Tx slots (0); Frequency: 824.2 MHz; Duty Cycle: 1:4.15
Medium: HSL_835 Medium parameters used: $f = 824.2$ MHz; $\sigma = 0.905$ S/m; $\epsilon_r = 41.412$; $\rho = 1000$ kg/m³

Ambient Temperature : 23.2 °C; Liquid Temperature : 22.9 °C

DASY5 Configuration:

- Probe: EX3DV4 - SN3935; ConvF(10.31, 10.31, 10.31); Calibrated: 2020.5.27
- Sensor-Surface: 1.4mm (Mechanical Surface Detection)
- Electronics: DAE4 Sn1358; Calibrated: 2020.4.28
- Phantom: SAM1; Type: SAM; Serial: TP-1753
- Measurement SW: DASY52, Version 52.10 (4); SEMCAD X Version 14.6.14 (7483)

Area Scan (71x71x1): Interpolated grid: dx=1.500 mm, dy=1.500 mm
Maximum value of SAR (interpolated) = 1.25 W/kg

Zoom Scan (5x5x7)/Cube 0: Measurement grid: dx=8mm, dy=8mm, dz=5mm
Reference Value = 15.57 V/m; Power Drift = 0.06 dB
Peak SAR (extrapolated) = 1.85 W/kg
SAR(1 g) = 0.879 W/kg; SAR(10 g) = 0.477 W/kg
Maximum value of SAR (measured) = 1.44 W/kg

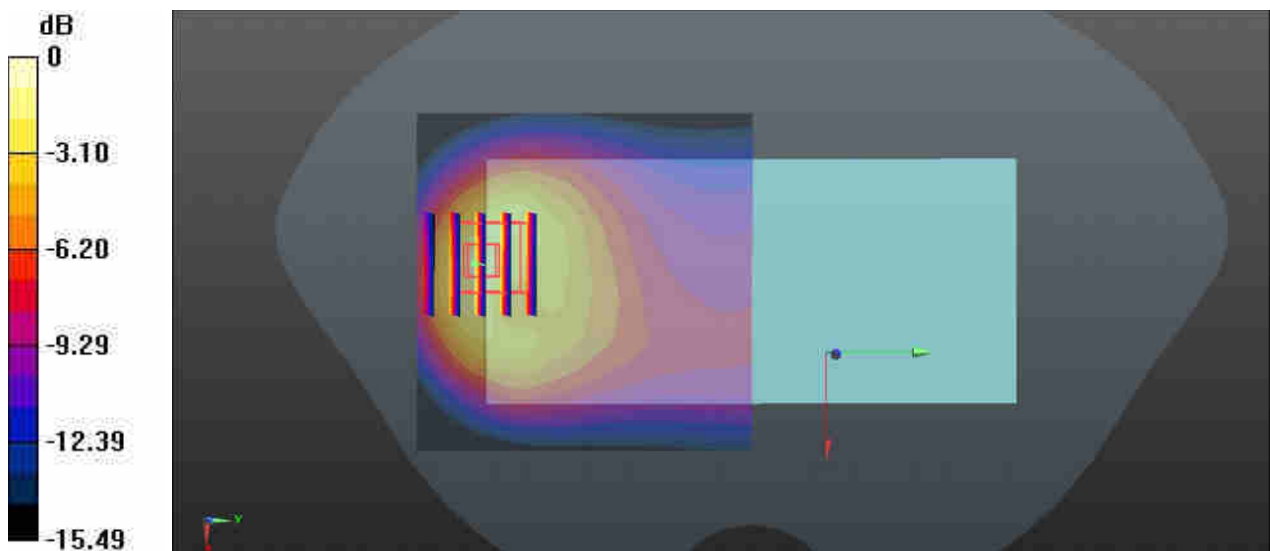

0 dB = 1.44 W/kg = 1.58 dBW/kg

18_GSM1900_GPRS 2 Tx slots_Front_5mm_Ch512

Communication System: UID 0, GSM 2Tx slots (0); Frequency: 1850.2 MHz; Duty Cycle: 1:4.15
Medium: HSL_1900 Medium parameters used: $f = 1850.2$ MHz; $\sigma = 1.35$ S/m; $\epsilon_r = 40.362$; $\rho = 1000$ kg/m³

Ambient Temperature : 23.2 °C; Liquid Temperature : 22.9 °C

DASY5 Configuration:

- Probe: EX3DV4 - SN3935; ConvF(8.35, 8.35, 8.35); Calibrated: 2020.5.27
- Sensor-Surface: 1.4mm (Mechanical Surface Detection)
- Electronics: DAE4 Sn1358; Calibrated: 2020.4.28
- Phantom: SAM1; Type: SAM; Serial: TP-1753
- Measurement SW: DASY52, Version 52.10 (4); SEMCAD X Version 14.6.14 (7483)

Area Scan (81x71x1): Interpolated grid: dx=1.500 mm, dy=1.500 mm
Maximum value of SAR (interpolated) = 1.30 W/kg

Zoom Scan (5x5x7)/Cube 0: Measurement grid: dx=8mm, dy=8mm, dz=5mm
Reference Value = 3.511 V/m; Power Drift = -0.06 dB
Peak SAR (extrapolated) = 1.76 W/kg
SAR(1 g) = 0.883 W/kg; SAR(10 g) = 0.427 W/kg
Maximum value of SAR (measured) = 1.45 W/kg

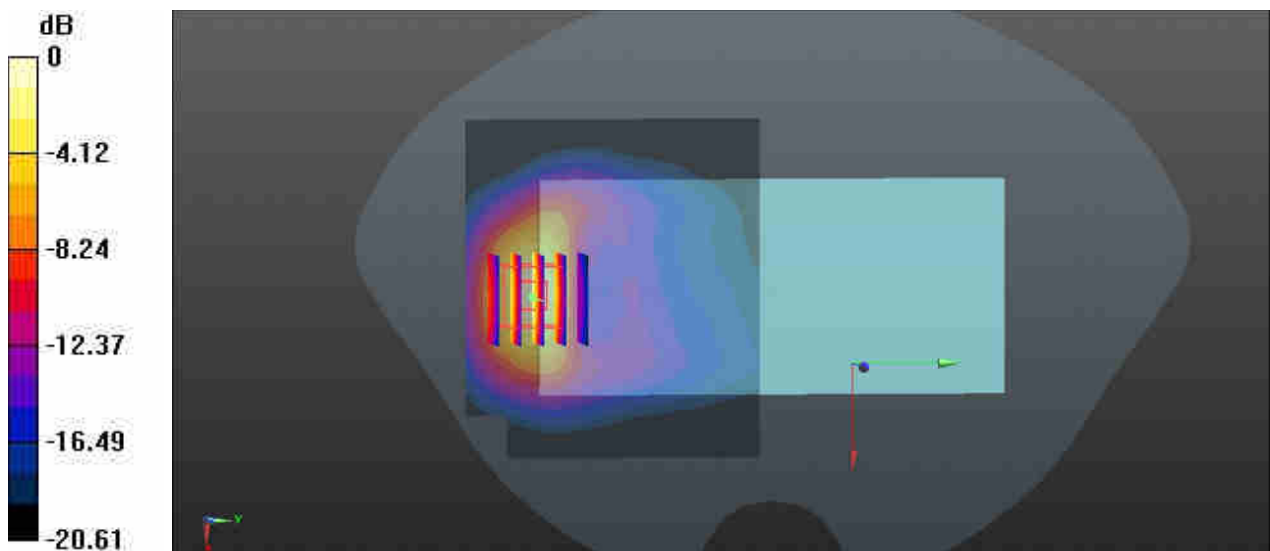

0 dB = 1.45 W/kg = 1.61 dBW/kg

19_WCDMA II_RMC 12.2Kbps_Bottom Side_5mm_Ch9538

Communication System: UID 0, WCDMA (0); Frequency: 1907.6 MHz; Duty Cycle: 1:1
Medium: HSL_1900 Medium parameters used: $f = 1908$ MHz; $\sigma = 1.41$ S/m; $\epsilon_r = 40.109$; $\rho = 1000$ kg/m³

Ambient Temperature : 23.2 °C; Liquid Temperature : 22.9 °C

DASY5 Configuration:

- Probe: EX3DV4 - SN3935; ConvF(8.35, 8.35, 8.35); Calibrated: 2020.5.27
- Sensor-Surface: 1.4mm (Mechanical Surface Detection)
- Electronics: DAE4 Sn1358; Calibrated: 2020.4.28
- Phantom: SAM1; Type: SAM; Serial: TP-1753
- Measurement SW: DASY52, Version 52.10 (4); SEMCAD X Version 14.6.14 (7483)

Area Scan (41x81x1): Interpolated grid: dx=1.500 mm, dy=1.500 mm
Maximum value of SAR (interpolated) = 1.70 W/kg

Zoom Scan (5x5x7)/Cube 0: Measurement grid: dx=8mm, dy=8mm, dz=5mm

Reference Value = 34.11 V/m; Power Drift = -0.07 dB

Peak SAR (extrapolated) = 2.06 W/kg

SAR(1 g) = 0.984 W/kg; SAR(10 g) = 0.464 W/kg

Maximum value of SAR (measured) = 1.64 W/kg

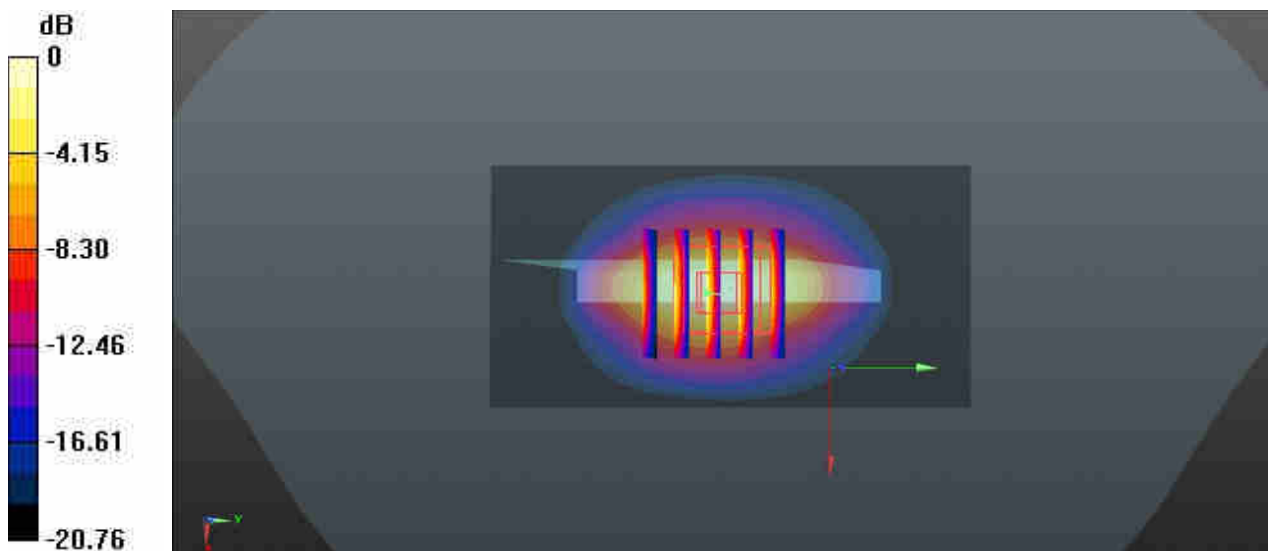

0 dB = 1.64 W/kg = 2.15 dBW/kg

20_WCDMA IV_RMC 12.2Kbps_Bottom Side_5mm_Ch1513

Communication System: UID 0, WCDMA (0); Frequency: 1752.6 MHz; Duty Cycle: 1:1
 Medium: HSL_1750 Medium parameters used: $f = 1752.6$ MHz; $\sigma = 1.339$ S/m; $\epsilon_r = 41.281$; $\rho = 1000$ kg/m³

Ambient Temperature : 23.4 °C; Liquid Temperature : 22.8 °C

DASY5 Configuration:

- Probe: EX3DV4 - SN3935; ConvF(8.6, 8.6, 8.6); Calibrated: 2020.5.27
- Sensor-Surface: 1.4mm (Mechanical Surface Detection)
- Electronics: DAE4 Sn1358; Calibrated: 2020.4.28
- Phantom: SAM1; Type: SAM; Serial: TP-1753
- Measurement SW: DASY52, Version 52.10 (4); SEMCAD X Version 14.6.14 (7483)

Area Scan (41x81x1): Interpolated grid: dx=1.500 mm, dy=1.500 mm
 Maximum value of SAR (interpolated) = 1.93 W/kg

Zoom Scan (5x5x7)/Cube 0: Measurement grid: dx=8mm, dy=8mm, dz=5mm
 Reference Value = 37.41 V/m; Power Drift = -0.07 dB
 Peak SAR (extrapolated) = 2.32 W/kg
SAR(1 g) = 1.14 W/kg; SAR(10 g) = 0.549 W/kg
 Maximum value of SAR (measured) = 1.88 W/kg

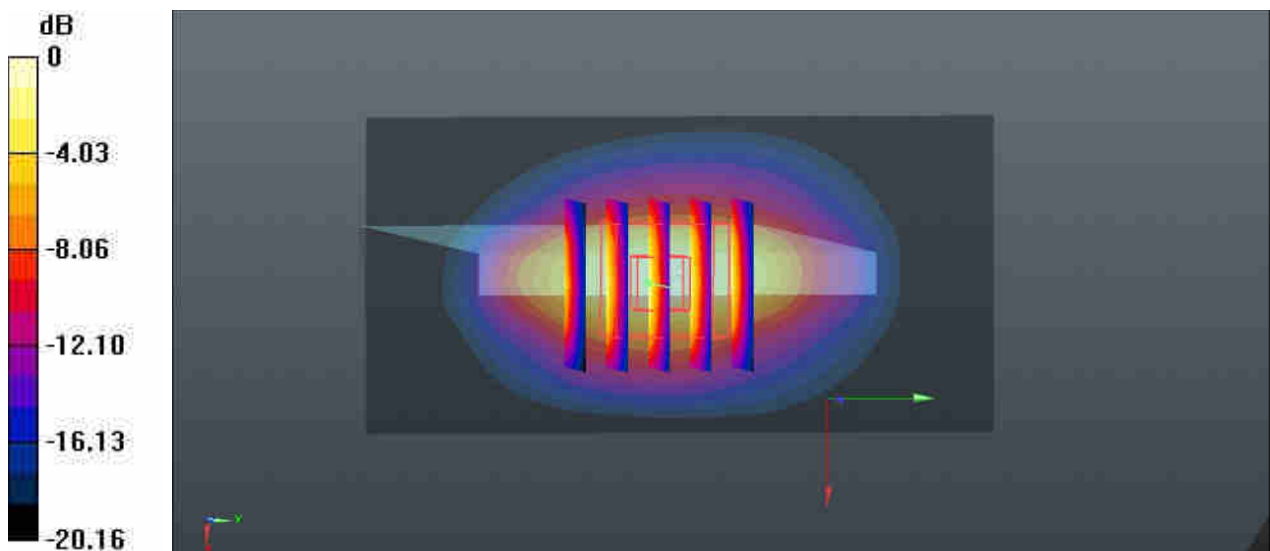

0 dB = 1.88 W/kg = 2.74 dBW/kg

21_WCDMA V_RMC 12.2Kbps_Front_5mm_Ch4233

Communication System: UID 0, WCDMA (0); Frequency: 846.6 MHz; Duty Cycle: 1:1
 Medium: HSL_835 Medium parameters used: $f = 847$ MHz; $\sigma = 0.926$ S/m; $\epsilon_r = 41.107$; $\rho = 1000$ kg/m³

Ambient Temperature : 23.2 °C; Liquid Temperature : 22.9 °C

DASY5 Configuration:

- Probe: EX3DV4 - SN3935; ConvF(10.31, 10.31, 10.31); Calibrated: 2020.5.27
- Sensor-Surface: 1.4mm (Mechanical Surface Detection)
- Electronics: DAE4 Sn1358; Calibrated: 2020.4.28
- Phantom: SAM1; Type: SAM; Serial: TP-1753
- Measurement SW: DASY52, Version 52.10 (4); SEMCAD X Version 14.6.14 (7483)

Area Scan (71x71x1): Interpolated grid: dx=1.500 mm, dy=1.500 mm
 Maximum value of SAR (interpolated) = 1.42 W/kg

Zoom Scan (5x5x7)/Cube 0: Measurement grid: dx=8mm, dy=8mm, dz=5mm
 Reference Value = 16.58 V/m; Power Drift = 0.03 dB
 Peak SAR (extrapolated) = 2.08 W/kg
SAR(1 g) = 0.988 W/kg; SAR(10 g) = 0.532 W/kg
 Maximum value of SAR (measured) = 1.66 W/kg

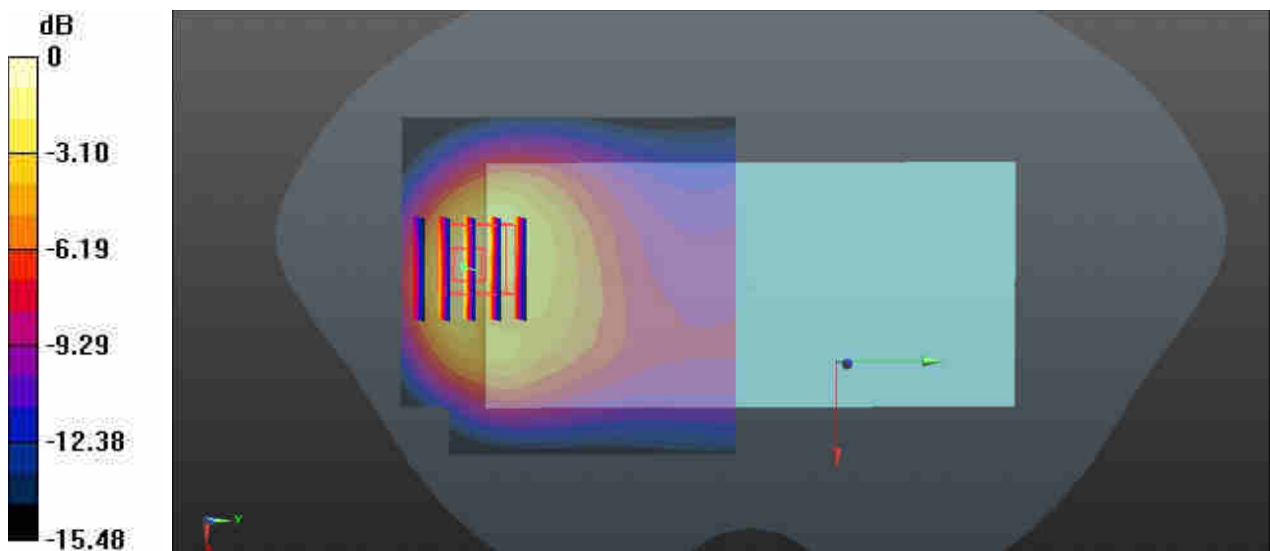

0 dB = 1.66 W/kg = 2.20 dBW/kg