



# FCC CO-LOCATION RADIO TEST REPORT

FCC ID : IHDT56ZB2  
Equipment : Mobile Cellular Phone  
Brand Name : Motorola  
Model Name : XT2071-4  
Applicant : Motorola Mobility, LLC  
222 W Merchandise Mart Plaza, Suite  
1800, Chicago, IL 60654, United States  
Manufacturer : Motorola Mobility, LLC  
222 W Merchandise Mart Plaza, Suite  
1800, Chicago, IL 60654, United States  
Standard : FCC Part 15 Subpart E §15.407

The product was received on May 12, 2020 and testing was started from Jun. 25, 2020 and completed on Jun. 29, 2020. We, SPORTON INTERNATIONAL INC., EMC & Wireless Communications Laboratory, would like to declare that the tested sample has been evaluated in accordance with the test procedures and has been in compliance with the applicable technical standards.

The test results in this report apply exclusively to the tested model / sample. Without written approval of SPORTON INTERNATIONAL INC. EMC & Wireless Communications Laboratory, the test report shall not be reproduced except in full.

*Louis Wu*

Approved by: Louis Wu

**SPORTON INTERNATIONAL INC. EMC & Wireless Communications Laboratory**  
No. 52, Huaya 1st Rd., Guishan Dist., Taoyuan City, Taiwan (R.O.C.)



## Table of Contents

**History of this test report ..... 3**

**Summary of Test Result..... 4**

**1 General Description ..... 5**

    1.1 Product Feature of Equipment Under Test.....5

    1.2 Product Specification of Equipment Under Test.....7

    1.3 Modification of EUT .....7

    1.4 Testing Location .....8

    1.5 Applicable Standards.....8

**2 Test Configuration of Equipment Under Test ..... 9**

    2.1 Carrier Frequency and Channel .....9

    2.2 Test Mode.....9

    2.3 Connection Diagram of Test System ..... 10

    2.4 Support Unit used in test configuration and system ..... 10

    2.5 EUT Operation Test Setup ..... 10

**3 Test Result ..... 11**

    3.1 Unwanted Emissions Measurement ..... 11

    3.2 Antenna Requirements ..... 15

**4 List of Measuring Equipment ..... 16**

**5 Uncertainty of Evaluation ..... 17**

**Appendix A. Radiated Spurious Emission**

**Appendix B. Radiated Spurious Emission Plots**

**Appendix C. Duty Cycle Plots**





### Summary of Test Result

Report Clause	Ref Std. Clause	Test Items	Result (PASS/FAIL)	Remark
3.1	15.407(b)	Unwanted Emissions	Pass	Under limit 4.60 dB at 2483.520 MHz
3.2	15.203 15.407(a)	Antenna Requirement	Pass	-

<b>Declaration of Conformity:</b>
The test results with all measurement uncertainty excluded are presented in accordance with the regulation limits or requirements declared by manufacturers.
<b>Comments and Explanations:</b>
The declared of product specification for EUT presented in the report are provided by the manufacturer, and the manufacturer takes all the responsibilities for the accuracy of product specification.

Reviewed by: **Wii Chang**  
Report Producer: **Amy Chen**



# 1 General Description

## 1.1 Product Feature of Equipment Under Test

Product Feature	
Equipment	Mobile Cellular Phone
Brand Name	Motorola
Model Name	XT2071-4
FCC ID	IHDT56ZB2
IMEI Code	<b>Radiation :</b> IMEI 1: 351648110009058 IMEI 2: 351648110009066
EUT supports Radios application	CDMA/EV-DO/GSM/EGPRS/WCDMA/HSPA/LTE/5G NR/ GNSS/NFC WLAN 11a/b/g/n HT20/HT40 WLAN 11ac VHT20/VHT40/VHT80 Bluetooth BR/EDR/LE
HW Version	DVT2
EUT Stage	Identical Prototype

**Remark:** The above EUT's information was declared by manufacturer.



<b>Accessory List</b>	
<b>AC Adapter 1 (US)</b>	Brand Name : Motorola
	Model Name : SC-51
	Manufacturer : Chenyang
<b>AC Adapter 1 (EU)</b>	Brand Name : Motorola
	Model Name : SC-52
	Manufacturer : Chenyang
<b>AC Adapter 1 (UK)</b>	Brand Name : Motorola
	Model Name : SC-53UK
	Manufacturer : Chenyang
<b>AC Adapter 1 (AR)</b>	Brand Name : Motorola
	Model Name : SC-56
	Manufacturer : Chenyang
<b>AC Adapter 1 (AU)</b>	Brand Name : Motorola
	Model Name : SC-55AU
	Manufacturer : Chenyang
<b>AC Adapter 2 (US)</b>	Brand Name : Motorola
	Model Name : SC-51
	Manufacturer : Acbel
<b>AC Adapter 2 (EU)</b>	Brand Name : Motorola
	Model Name : SC-52
	Manufacturer : Acbel
<b>AC Adapter 2 (AR)</b>	Brand Name : Motorola
	Model Name : SC-56
	Manufacturer : Acbel
<b>AC Adapter 3 (IN)</b>	Brand Name : Motorola
	Model Name : SC-54
	Manufacturer : Salom
<b>Battery 1</b>	Brand Name : Motorola
	Model Name : LS30
	Manufacturer : ATL
<b>Battery 2</b>	Brand Name : Motorola
	Model Name : LS40
	Manufacturer : ATL
<b>Standard 3.5mm Headset 1</b>	Brand Name : Motorola
	Model Name : SH38C37773
	Manufacturer : Lianyun
<b>Standard 3.5mm Headset 2</b>	Brand Name : Motorola
	Model Name : SH38C44959
	Manufacturer : Lianyun
<b>USB-C to 3.5mm headset adaptor 1</b>	Brand Name : Motorola
	Model Name : SC18C27844
<b>USB-C to 3.5mm headset adaptor 2</b>	Brand Name : Motorola
	Model Name : SC18C27845
<b>USB Cable 1</b>	Brand Name : Motorola
	Model Name : SC18C24367
	Manufacturer : Saibao
<b>USB Cable 2</b>	Brand Name : Motorola
	Model Name : SC18C24368
	Manufacturer : Luxshare

## 1.2 Product Specification of Equipment Under Test

Standards-related Product Specification	
<b>Tx/Rx Frequency Range</b>	2400 MHz ~ 2483.5 MHz 5260 MHz ~ 5320 MHz
<b>Antenna Type / Gain</b>	<b>Bluetooth-LE:</b> slot Antenna type with gain -2.00 dBi <b>WLAN:</b> <b>&lt;2400 MHz ~ 2483.5 MHz&gt;</b> <b>Ant. 4 :</b> slot Antenna type with gain -2.00 dBi <b>Ant. 3 :</b> ILA Antenna type with gain -1.90 dBi <b>&lt;5260 MHz ~ 5320 MHz&gt;</b> <b>Ant. 4 :</b> slot Antenna type with gain -1.15 dBi <b>Ant. 3 :</b> ILA Antenna type with gain 0.40 dBi
<b>Type of Modulation</b>	Bluetooth LE : GFSK 802.11n: OFDM (BPSK / QPSK / 16QAM / 64QAM)

## 1.3 Modification of EUT

No modifications are made to the EUT during all test items.



### 1.4 Testing Location

<b>Test Site</b>	SPORTON INTERNATIONAL INC. EMC & Wireless Communications Laboratory
<b>Test Site Location</b>	No.58, Aly. 75, Ln. 564, Wenhua 3rd, Rd., Guishan Dist., Taoyuan City, Taiwan (R.O.C.) TEL: +886-3-327-0868 FAX: +886-3-327-0855
<b>Test Site No.</b>	<b>Sporton Site No.</b> 03CH15-HY

**Note:** The test site complies with ANSI C63.4 2014 requirement.

FCC designation No.: TW0007

### 1.5 Applicable Standards

According to the specifications of the manufacturer, the EUT must comply with the requirements of the following standards:

- ♦ FCC Part 15 Subpart E
- ♦ FCC KDB 789033 D02 General UNII Test Procedures New Rules v02r01.
- ♦ FCC KDB Publication No. 558074 D01 DTS Meas. Guidance v05r02
- ♦ FCC KDB 971168 D01 Power Meas. License Digital Systems v03r01
- ♦ FCC KDB 414788 D01 Radiated Test Site v01r01.
- ♦ FCC KDB 662911 D01 Multiple Transmitter Output v02r01.
- ♦ ANSI C63.10-2013

**Remark:**

1. All test items were verified and recorded according to the standards and without any deviation during the test.
2. The TAF code is not including all the FCC KDB listed without accreditation.
3. This EUT has also been tested and complied with the requirements of FCC Part 15, Subpart B, recorded in a separate test report.





## 2 Test Configuration of Equipment Under Test

The EUT has been associated with peripherals and configuration operated in a manner tended to maximize its emission characteristics in a typical application. Frequency range investigated: radiation emission (9 kHz to the 10th harmonic of the highest fundamental frequency or to 40 GHz, whichever is lower). For radiated measurement, pre-scanned in three orthogonal panels, X, Y, Z and Accessory (Earphone or Adapter). The worst cases (Z Plane) were recorded in this report.

### 2.1 Carrier Frequency and Channel

2400-2483.5 MHz Bluetooth-LE		2400-2483.5 MHz 802.11n HT20		5250 MHz ~5350 MHz 802.11n HT20	
Channel	Freq. (MHz)	Channel	Freq. (MHz)	Channel	Freq. (MHz)
39	2480	11	2462	64	5320

**Remark:** During the Radiated Spurious Emission test, the EUT turn on the WWAN functions simultaneously.

### 2.2 Test Mode

Final test modes are considering the modulation and worse data rates as below table.

<Co-Location>

Modulation	Data Rate
Bluetooth-LE + 5GHz 802.11n HT20	2Mbps + MCS0
2.4GHz 802.11n HT20 + LTE Band 7	MCS0 + QPSK

**Remark:** For Radiated Test Cases, the tests were performed with AC Adapter 1 (US) and USB Cable 1.

### 2.3 Connection Diagram of Test System

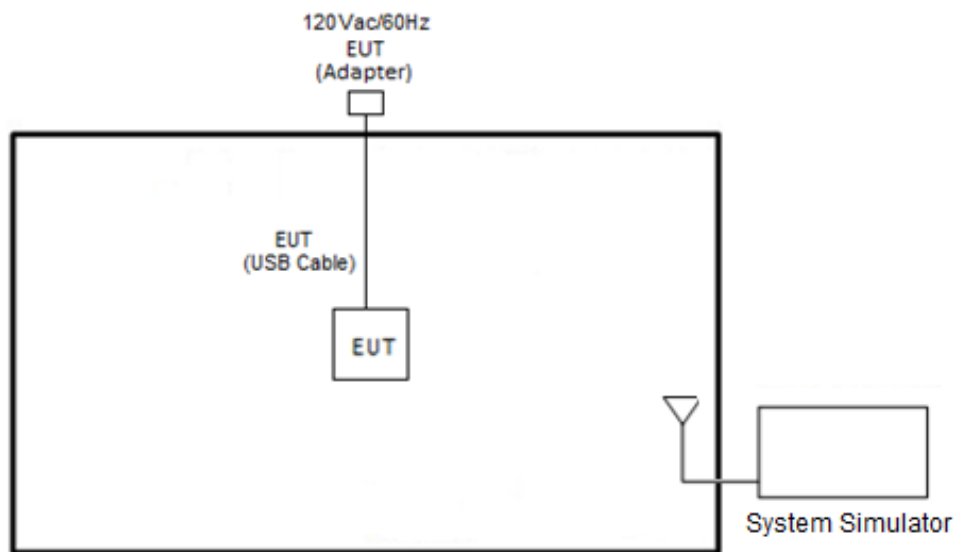
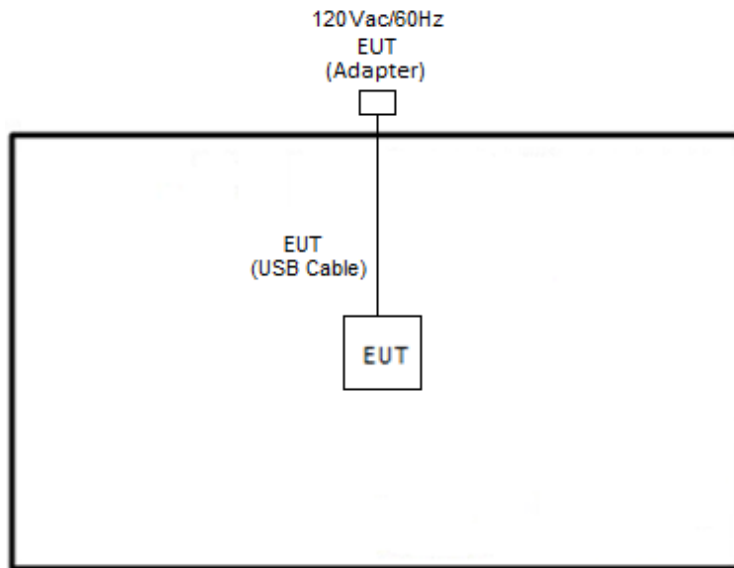

### 2.4 Support Unit used in test configuration and system

Item	Equipment	Trade Name	Model Name	FCC ID	Data Cable	Power Cord
1.	LTE Base Station	Anritsu	MT8820C	N/A	N/A	Unshielded, 1.8 m

### 2.5 EUT Operation Test Setup

The RF test items, utility “QRCT4 V4.0.00156.0” was installed in Notebook which was programmed in order to make the EUT get into the engineering modes to provide channel selection, power level, data rate and the application type and for continuous transmitting signals.

### 3 Test Result

#### 3.1 Unwanted Emissions Measurement

This section is to measure unwanted emissions through radiated measurement for band edge spurious emissions and out of band emissions measurement.

##### 3.1.1 Limit of Unwanted Emissions

(1) Unwanted spurious emissions fallen in restricted bands shall comply with the general field strength limits as below table:

Frequency (MHz)	Field Strength (microvolts/meter)	Measurement Distance (meters)
0.009 – 0.490	2400/F(kHz)	300
0.490 – 1.705	24000/F(kHz)	30
1.705 – 30.0	30	30
30 – 88	100	3
88 – 216	150	3
216 - 960	200	3
Above 960	500	3

**Note:** The following formula is used to convert the EIRP to field strength.

$$E = \frac{1000000\sqrt{30P}}{3} \mu\text{V/m, where P is the eirp (Watts)}$$

EIRP (dBm)	Field Strength at 3m (dBμV/m)
- 27	68.3

(2) KDB789033 D02 v02r01 G)2)c)

- (i) Sections 15.407(b)(1-3) specifies the unwanted emissions limit for the U-NII-1 and U-NII-2 bands. As specified, emissions above 1000 MHz that are outside of the restricted bands are subject to a peak emission limit of -27 dBm/MHz.
- (ii) Section 15.407(b)(4) specifies the unwanted emissions limit for the U-NII-3 band. A band emissions mask is specified in Section 15.407(b)(4)(i). The emission limits are based on the use of a peak detector.

##### 3.1.2 Measuring Instruments

See list of measuring equipment of this test report.



**3.1.3 Test Procedures**

1. The testing follows FCC KDB 789033 D02 General UNII Test Procedures New Rules v02r01. Section G) Unwanted emissions measurement.
  - (1) Procedure for Unwanted Emissions Measurements Below 1000MHz
    - RBW = 120 kHz
    - VBW = 300 kHz
    - Detector = Peak
    - Trace mode = max hold
  - (2) Procedure for Peak Unwanted Emissions Measurements Above 1000 MHz
    - RBW = 1 MHz
    - VBW  $\geq$  3 MHz
    - Detector = Peak
    - Sweep time = auto
    - Trace mode = max hold
  - (3) Procedures for Average Unwanted Emissions Measurements Above 1000MHz
    - RBW = 1 MHz
    - VBW = 10 Hz, when duty cycle is no less than 98 percent.
    - VBW  $\geq$  1/T, when duty cycle is less than 98 percent where T is the minimum transmission duration over which the transmitter is on and is transmitting at its maximum power control level for the tested mode of operation.
2. The EUT was placed on a turntable with 0.8 meter for frequency below 1GHz and 1.5 meter for frequency above 1GHz respectively above ground.
3. The EUT was set 3 meters from the interference receiving antenna which was mounted on the top of a variable height antenna tower.
4. The antenna is a broadband antenna and its height is adjusted between one meter and four meters above ground to find the maximum value of the field strength for both horizontal polarization and vertical polarization of the antenna.
5. For each suspected emission, the EUT was arranged to its worst case and then adjust the antenna tower (from 1 m to 4 m) and turntable (from 0 degree to 360 degrees) to find the maximum reading.
6. For testing below 1GHz, if the emission level of the EUT in peak mode was 3 dB lower than the limit specified, then peak values of EUT will be reported, otherwise, the emissions will be repeated one by one using the CISPR quasi-peak method and reported.
7. For testing above 1GHz, the emission level of the EUT in peak mode was 20dB lower than average limit (that means the emission level in average mode also complies with the limit in average mode), then peak values of EUT will be reported, otherwise, the emissions will be measured in average mode again and reported.

### 3.1.4 Test Setup

For radiated emissions below 30MHz

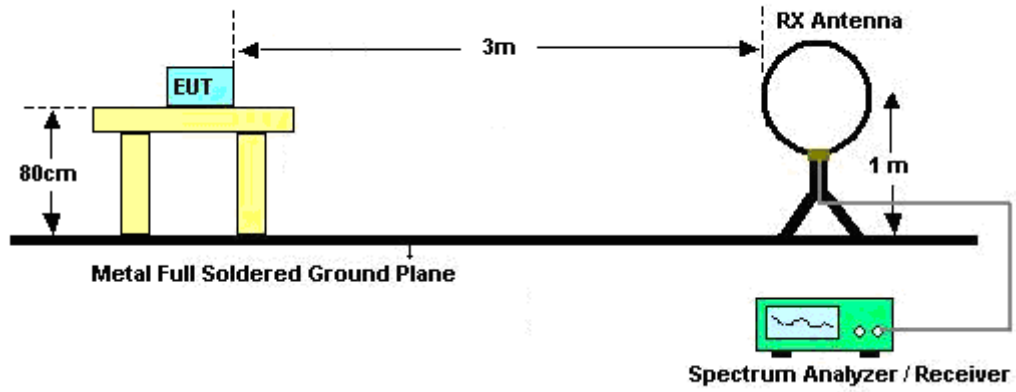

For radiated emissions from 30MHz to 1GHz

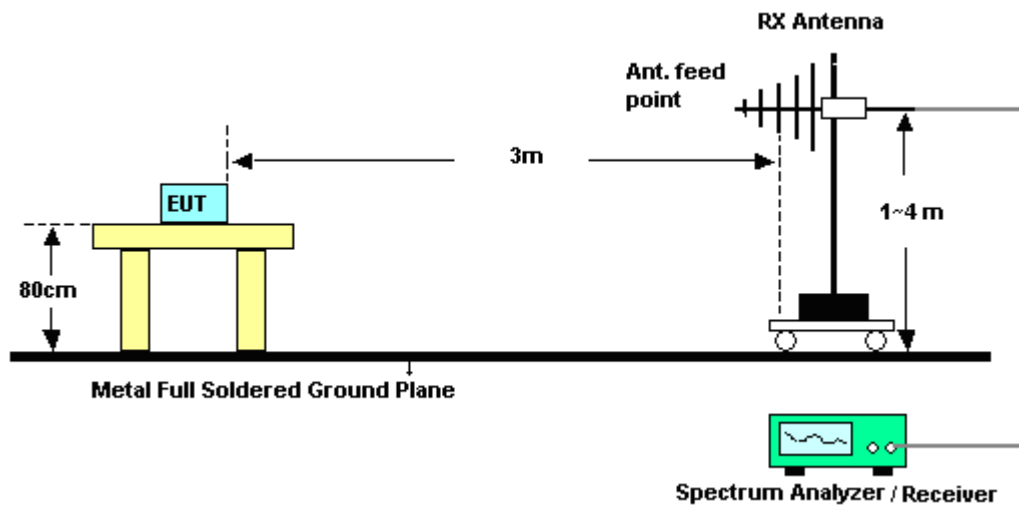

For radiated emissions above 1GHz

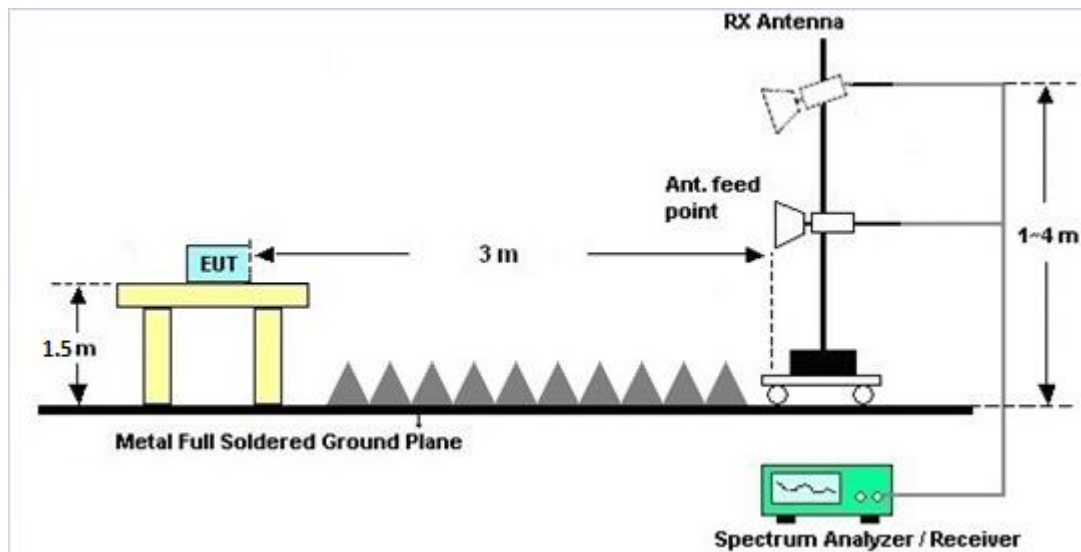

### 3.1.5 Test Results of Radiated Spurious Emissions (9 kHz ~ 30 MHz)

The low frequency, which started from 9 kHz to 30MHz, was pre-scanned and the result which was 20dB lower than the limit line was not reported.

There is a comparison data of both open-field test site and alternative test site - semi-Anechoic chamber according to 414788 D01 Radiated Test Site v01r01, and the result came out very similar.

### 3.1.6 Test Result of Radiated Spurious at Band Edges

Please refer to Appendix A and B.

### 3.1.7 Duty Cycle

Please refer to Appendix C.

### 3.1.8 Test Result of Radiated Spurious Emissions (30MHz ~ 10th Harmonic)

Please refer to Appendix A and B.



## **3.2 Antenna Requirements**

### **3.2.1 Standard Applicable**

If transmitting antenna directional gain is greater than 6 dBi, both the peak transmit power and the peak power spectral density shall be reduced by the amount in dB that the directional gain of the antenna exceeds 6 dBi.

### **3.2.2 Antenna Anti-Replacement Construction**

An embedded-in antenna design is used.

### **3.2.3 Antenna Gain**

The antenna peak gain of EUT is less than 6 dBi. Therefore, it is not necessary to reduce maximum peak output power limit.



## 4 List of Measuring Equipment

Instrument	Manufacturer	Model No.	Serial No.	Characteristics	Calibration Date	Test Date	Due Date	Remark
Bilog Antenna	TESEQ	CBL6111D&00800N1D01N-06	41912&05	30MHz to 1GHz	Feb. 09, 2020	Jun. 25, 2020~ Jun. 29, 2020	Feb. 08, 2021	Radiation (03CH15-HY)
Amplifier	SONOMA	310N	363440	9kHz~1GHz	Dec. 27, 2019	Jun. 25, 2020~ Jun. 29, 2020	Dec. 26, 2020	Radiation (03CH15-HY)
Horn Antenna	SCHWARZBECK	BBHA 9120 D	9120D-1620	1-18GHz	Oct. 28, 2019	Jun. 25, 2020~ Jun. 29, 2020	Oct. 27, 2020	Radiation (03CH15-HY)
SHF-EHF Horn Antenna	SCHWARZBECK	BBHA 9170	BBHA9170584	18GHz- 40GHz	Dec. 10, 2019	Jun. 25, 2020~ Jun. 29, 2020	Dec. 09, 2020	Radiation (03CH15-HY)
Preamplifier	Jet-Power	JPA0118-55-303	1710001800055006	1GHz~18GHz	May 07, 2020	Jun. 25, 2020~ Jun. 29, 2020	May 06, 2021	Radiation (03CH15-HY)
Preamplifier	Keysight	83017A	MY53270195	1GHz~26.5GHz	Aug. 23, 2019	Jun. 25, 2020~ Jun. 29, 2020	Aug. 22, 2020	Radiation (03CH15-HY)
Preamplifier	EMEC	EM18G40G	060715	18GHz ~ 40GHz	Dec. 13, 2019	Jun. 25, 2020~ Jun. 29, 2020	Dec. 12, 2020	Radiation (03CH15-HY)
EMI Test Receiver	Keysight	N9038A(MXE)	MY54130085	20MHz~8.4GHz	Nov. 01, 2019	Jun. 25, 2020~ Jun. 29, 2020	Oct. 31, 2020	Radiation (03CH15-HY)
Spectrum Analyzer	Agilent	E4446A	MY50180136	3Hz~44GHz	May 04, 2020	Jun. 25, 2020~ Jun. 29, 2020	May 03, 2021	Radiation (03CH15-HY)
Antenna Mast	ChainTek	MBS-520-1	N/A	1m~4m	N/A	Jun. 25, 2020~ Jun. 29, 2020	N/A	Radiation (03CH15-HY)
Turn Table	ChainTek	T-200-S-1	N/A	0~360 Degree	N/A	Jun. 25, 2020~ Jun. 29, 2020	N/A	Radiation (03CH15-HY)
Software	Audix	E3 6.2009-8-24(k5)	RK-000451	N/A	N/A	Jun. 25, 2020~ Jun. 29, 2020	N/A	Radiation (03CH15-HY)
RF Cable	HUBER + SUHNER	SUCOFLEX 104	MY36980/4	30M-18G	Apr. 14, 2020	Jun. 25, 2020~ Jun. 29, 2020	Apr. 13, 2021	Radiation (03CH15-HY)
RF Cable	HUBER + SUHNER	SUCOFLEX 104	MY9838/4PE	30M-18G	Apr. 14, 2020	Jun. 25, 2020~ Jun. 29, 2020	Apr. 13, 2021	Radiation (03CH15-HY)
RF Cable	HUBER + SUHNER	SUCOFLEX 104	MY37710/4	30M-18G	Apr. 17, 2020	Jun. 25, 2020~ Jun. 29, 2020	Apr. 16, 2021	Radiation (03CH15-HY)
RF Cable	HUBER + SUHNER	SUCOFLEX 102	505134/2	30MHz-40GHz	Feb. 25, 2020	Jun. 25, 2020~ Jun. 29, 2020	Feb. 24, 2021	Radiation (03CH15-HY)
RF Cable	HUBER + SUHNER	SUCOFLEX 102	800740/2	30MHz-40GHz	Feb. 25, 2020	Jun. 25, 2020~ Jun. 29, 2020	Feb. 24, 2021	Radiation (03CH15-HY)
Filter	Wainwright	WLK4-1000-1530-8000-40SS	SN4	1.53G Low Pass	Jul. 04, 2019	Jun. 25, 2020~ Jun. 29, 2020	Jul. 03, 2020	Radiation (03CH15-HY)
Filter	Wainwright	WHKX8-5872.5-6750-18000-40ST	SN6	6.75GHz High Pass Filter	Jul. 02, 2019	Jun. 25, 2020~ Jun. 29, 2020	Jul. 01, 2020	Radiation (03CH15-HY)





## 5 Uncertainty of Evaluation

### Uncertainty of Radiated Emission Measurement (30 MHz ~ 1000 MHz)

Measuring Uncertainty for a Level of Confidence of 95% ( $U = 2Uc(y)$ )	5.0
---	-----

### Uncertainty of Radiated Emission Measurement (1000 MHz ~ 18000 MHz)

Measuring Uncertainty for a Level of Confidence of 95% ( $U = 2Uc(y)$ )	5.4
---	-----

### Uncertainty of Radiated Emission Measurement (18000 MHz ~ 40000 MHz)

Measuring Uncertainty for a Level of Confidence of 95% ( $U = 2Uc(y)$ )	5.0
---	-----



## Appendix A. Radiated Spurious Emission

Test Engineer :	Leo Lee, Mancy Chou, and Bigshow Wang	Temperature :	21.4~22.9°C
		Relative Humidity :	52~61%

### BLE\_Tx\_Ch39+11n (n20)\_Tx\_Ch64 (Band Edge @ 3m)

WIFI Ant. Simultaneously	Note	Frequency ( MHz )	Level ( dBμV/m )	Over Limit ( dB )	Limit Line ( dBμV/m )	Read Level ( dBμV )	Antenna Factor ( dB/m )	Path Loss ( dB )	Preamp Factor ( dB )	Ant Pos ( cm )	Table Pos ( deg )	Peak Avg. ( P/A )	Pol. ( H/V )	
BLE_Tx_Ch39	*	2480	96.08	-	-	82.13	27.54	17.51	31.1	257	3	P	H	
	*	2480	95.52	-	-	81.57	27.54	17.51	31.1	257	3	A	H	
		2487.92	55.94	-18.06	74	42	27.52	17.52	31.1	257	3	P	H	
		2483.6	44.79	-9.21	54	30.84	27.53	17.52	31.1	257	3	A	H	
													H	
													H	
	*	2480	93.38	-	-	79.43	27.54	17.51	31.1	31.1	242	78	P	V
	*	2480	92.79	-	-	78.84	27.54	17.51	31.1	31.1	242	78	A	V
		2485.76	55.49	-18.51	74	41.54	27.53	17.52	31.1	31.1	242	78	P	V
		2483.64	44.76	-9.24	54	30.81	27.53	17.52	31.1	31.1	242	78	A	V
11n(n20)_Tx_Ch64	*	5320	110.81	-	-	99.22	31.4	10.62	30.43	100	61	P	H	
	*	5320	102.92	-	-	91.33	31.4	10.62	30.43	100	61	P	H	
		5351.68	55.26	-18.74	74	43.64	31.41	10.64	30.43	100	61	A	H	
		5350.24	46.85	-7.15	54	35.24	31.4	10.64	30.43	100	61	P	H	
													H	
													H	
	*	5320	111.03	-	-	99.44	31.4	10.62	30.43	328	320	P	V	
	*	5320	102.78	-	-	91.19	31.4	10.62	30.43	328	320	P	V	
		5351.68	56.73	-17.27	74	45.11	31.41	10.64	30.43	328	320	A	V	
		5350.08	45.98	-8.02	54	34.37	31.4	10.64	30.43	328	320	P	V	
												V		
												V		
Remark	1. No other spurious found. 2. All results are PASS against Peak and Average limit line.													



BLE\_Tx\_Ch39+11n(n20)\_Tx\_Ch64 (Harmonic @ 3m)

WIFI Ant. Simultaneously	Note	Frequency ( MHz )	Level ( dBμV/m )	Over Limit ( dB )	Limit Line ( dBμV/m )	Read Level ( dBμV )	Antenna Factor ( dB/m )	Path Loss ( dB )	Preamp Factor ( dB )	Ant Pos ( cm )	Table Pos ( deg )	Peak Avg. ( P/A )	Pol. ( H/V )	
BLE_Tx_Ch39 + 11n(n20)_Tx_Ch 64		4960	53.91	-20.09	74	68.78	31.54	11.85	58.26	225	313	P	H	
		4960	48.6	-5.4	54	63.47	31.54	11.85	58.26	225	313	A	H	
		7440	49.43	-24.57	74	58.06	36.56	13.4	58.59	100	0	P	H	
		10640	52.65	-21.35	74	57.83	40.16	15.51	60.85	100	0	P	H	
		15960	49.43	-24.57	74	53.86	36.92	19.02	60.37	100	0	P	H	
														H
														H
														H
			4960	53.46	-20.54	74	68.33	31.54	11.85	58.26	283	338	P	V
			4960	46.83	-7.17	54	61.7	31.54	11.85	58.26	283	338	A	V
			7440	48.69	-25.31	74	57.32	36.56	13.4	58.59	100	0	P	V
			10640	52.74	-21.26	74	57.92	40.16	15.51	60.85	100	0	P	V
			15960	49.35	-24.65	74	53.78	36.92	19.02	60.37	100	0	P	V
														V
														V
														V
<b>Remark</b>	1. No other spurious found. 2. All results are PASS against Peak and Average limit line.													



802.11n (n20)\_Tx\_Ch11+LTE Band 7 BW 20M (Band Edge @ 3m)

WIFI Ant. Simultaneously	Note	Frequency ( MHz )	Level ( dBμV/m )	Over Limit ( dB )	Limit Line ( dBμV/m )	Read Level ( dBμV )	Antenna Factor ( dB/m )	Path Loss ( dB )	Preamp Factor ( dB )	Ant Pos ( cm )	Table Pos ( deg )	Peak Avg. ( P/A )	Pol. ( H/V )
802.11n (n20)_Tx_Ch11 + LTE Band 7 BW 20M	*	2462	108.65	-	-	94.7	27.58	17.48	31.11	200	52	P	H
	*	2462	100.42	-	-	86.47	27.58	17.48	31.11	200	52	A	H
		2483.88	61.74	-12.26	74	47.79	27.53	17.52	31.1	200	52	P	H
		2483.52	49.4	-4.6	54	35.45	27.53	17.52	31.1	200	52	A	H
													H
													H
	*	2462	105.1	-	-	91.15	27.58	17.48	31.11	261	52	P	V
	*	2462	97.26	-	-	83.31	27.58	17.48	31.11	261	52	A	V
		2483.76	58.14	-15.86	74	44.19	27.53	17.52	31.1	261	52	P	V
		2483.64	47.86	-6.14	54	33.91	27.53	17.52	31.1	261	52	A	V
												V	
												V	
Remark	1. No other spurious found. 2. All results are PASS against Peak and Average limit line.												



802.11n(n20)\_Tx\_Ch11 (Harmonic @ 3m)

WIFI Ant. Simultaneously	Note	Frequency ( MHz )	Level ( dBμV/m )	Over Limit ( dB )	Limit Line ( dBμV/m )	Read Level ( dBμV )	Antenna Factor ( dB/m )	Path Loss ( dB )	Preamp Factor ( dB )	Ant Pos ( cm )	Table Pos ( deg )	Peak Avg. ( P/A )	Pol. ( H/V )	
802.11n(n20)_Tx_Ch11		4924	42.4	-31.6	74	59.44	31.34	10.77	59.15	100	0	P	H	
		7386	45.97	-28.03	74	55.3	36.46	12.67	58.46	100	0	P	H	
													H	
													H	
													H	
			4924	41.07	-32.93	74	58.11	31.34	10.77	59.15	100	0	P	V
			7386	45.96	-28.04	74	55.29	36.46	12.67	58.46	100	0	P	V
														V
														V
														V
<b>Remark</b>	1. No other spurious found. 2. All results are PASS against Peak and Average limit line.													



Emission below 1GHz

BLE\_Tx\_Ch39+802.11a (n20)\_Tx\_Ch64 (LF @ 3m)

WIFI	Note	Frequency	Level	Over	Limit	Read	Antenna	Path	Preamp	Ant	Table	Peak	Pol.	
Ant.				Limit	Line	Level	Factor	Loss	Factor	Pos	Pos	Avg.		
Simultaneously		( MHz )	( dBμV/m )	( dB )	( dBμV/m )	(dBμV)	( dB/m )	( dB )	( dB )	( cm )	( deg )	(P/A)	(H/V)	
BLE_Tx_Ch39+ 802.11n (n20)_Tx_Ch64		72.68	22.53	-17.47	40	41.25	12.74	1.12	32.58	-	-	P	H	
		162.89	20.72	-22.78	43.5	34.86	16.49	1.78	32.41	-	-	P	H	
		329.73	21.98	-24.02	46	32.35	19.65	2.45	32.47	-	-	P	H	
		367.56	22.27	-23.73	46	31.44	20.58	2.58	32.33	-	-	P	H	
		838.01	35.6	-10.4	46	34.9	28.49	4.05	31.84	-	-	P	H	
		885.54	39.41	-6.59	46	38.55	28.55	4.22	31.91	100	0	P	H	
														H
														H
														H
														H
														H
														H
			39.7	24.42	-15.58	40	36.48	19.53	0.75	32.34	-	-	P	V
			72.68	22.52	-17.48	40	41.24	12.74	1.12	32.58	-	-	P	V
			97.9	19.03	-24.47	43.5	34.12	15.91	1.28	32.28	-	-	P	V
			260.86	20.9	-25.1	46	31.44	19.65	2.24	32.43	-	-	P	V
			558.65	27.16	-18.84	46	30.5	25.72	3.29	32.35	-	-	P	V
			885.54	38.88	-7.12	46	38.02	28.55	4.22	31.91	100	0	P	V
														V
														V
													V	
													V	
													V	
													V	
<b>Remark</b>	1. No other spurious found. 2. All results are PASS against limit line.													



LTE Band 7 20M+11n(n20)\_Tx\_Ch11 (LF @ 3m)

WIFI Ant. Simultaneously	Note	Frequency ( MHz )	Level ( dBμV/m )	Over Limit ( dB )	Limit Line ( dBμV/m )	Read Level (dBμV)	Antenna Factor ( dB/m )	Path Loss ( dB )	Preamp Factor ( dB )	Ant Pos ( cm )	Table Pos ( deg )	Peak Avg. (P/A)	Pol. (H/V)
		60.07	21.03	-18.97	40	40.45	12.11	1	32.53	-	-	P	H
		73.65	26	-14	40	44.57	12.89	1.12	32.58	-	-	P	H
		97.9	24.61	-18.89	43.5	39.7	15.91	1.28	32.28	-	-	P	H
		127.97	24.25	-19.25	43.5	37.53	17.71	1.48	32.47	-	-	P	H
		835.1	32.66	-13.34	46	32.29	28.19	4.03	31.85	-	-	P	H
		903.97	32.82	-13.18	46	31.81	28.62	4.29	31.9	100	0	P	H
													H
													H
													H
													H
													H
													H
802.11n(n20)_Tx_Ch11+													H
LTE Band 7 BW 20M		41.64	29.09	-10.91	40	41.88	18.77	0.77	32.33	100	0	P	V
		68.8	27.86	-12.14	40	46.55	12.64	1.08	32.41	-	-	P	V
		98.87	19.38	-24.12	43.5	34.3	16.07	1.28	32.27	-	-	P	V
		265.71	19.87	-26.13	46	30.57	19.48	2.26	32.44	-	-	P	V
		730.34	31.61	-14.39	46	32.99	27.31	3.75	32.44	-	-	P	V
		897.18	32.14	-13.86	46	31.25	28.57	4.27	31.95	-	-	P	V
													V
													V
													V
													V
													V
													V
													V
Remark	1. No other spurious found. 2. All results are PASS against limit line.												



**Note symbol**

*	<b>Fundamental Frequency</b> which can be ignored. However, the level of any unwanted emissions shall not exceed the level of the fundamental frequency.
!	Test result is <b>over limit</b> line.
P/A	<b>Peak</b> or <b>Average</b>
H/V	<b>Horizontal</b> or <b>Vertical</b>





A calculation example for radiated spurious emission is shown as below:

WIFI	Note	Frequency	Level	Over	Limit	Read	Antenna	Path	Preamp	Ant	Table	Peak	Pol.
Ant.				Limit	Line	Level	Factor	Loss	Factor	Pos	Pos	Avg.	
1		( MHz )	( dBμV/m )	( dB )	( dBμV/m )	( dBμV )	( dB/m )	( dB )	( dB )	( cm )	( deg )	( P/A )	( H/V )
802.11b		2390	55.45	-18.55	74	54.51	32.22	4.58	35.86	103	308	P	H
CH 01													
2412MHz		2390	43.54	-10.46	54	42.6	32.22	4.58	35.86	103	308	A	H

1. Path Loss(dB) = Cable loss(dB) + Filter loss(dB) + Attenuator loss(dB)
2. Level(dBμV/m) =  
Antenna Factor(dB/m) + Path Loss(dB) + Read Level(dBμV) - Preamp Factor(dB)
3. Over Limit(dB) = Level(dBμV/m) – Limit Line(dBμV/m)

**For Peak Limit @ 2390MHz:**

1. Level(dBμV/m)  
= Antenna Factor(dB/m) + Path Loss(dB) + Read Level(dBμV) - Preamp Factor(dB)  
= 32.22(dB/m) + 4.58(dB) + 54.51(dBμV) – 35.86 (dB)  
= 55.45 (dBμV/m)
2. Over Limit(dB)  
= Level(dBμV/m) – Limit Line(dBμV/m)  
= 55.45(dBμV/m) – 74(dBμV/m)  
= -18.55(dB)

**For Average Limit @ 2390MHz:**

1. Level(dBμV/m)  
= Antenna Factor(dB/m) + Path Loss(dB) + Read Level(dBμV) - Preamp Factor(dB)  
= 32.22(dB/m) + 4.58(dB) + 42.6(dBμV) – 35.86 (dB)  
= 43.54 (dBμV/m)
2. Over Limit(dB)  
= Level(dBμV/m) – Limit Line(dBμV/m)  
= 43.54(dBμV/m) – 54(dBμV/m)  
= -10.46(dB)

**Both peak and average measured complies with the limit line, so test result is “PASS”.**



## Appendix B. Radiated Spurious Emission

Test Engineer :	Leo Lee, Mancy Chou, and Bigshow Wang	Temperature :	21.4~22.9°C
		Relative Humidity :	52~61%

### BLE 2400~2483.5MHz (Band Edge @ 3m)

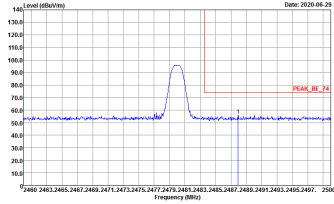
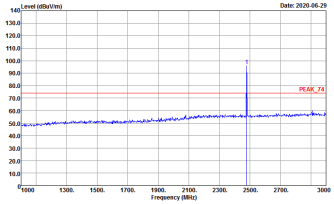
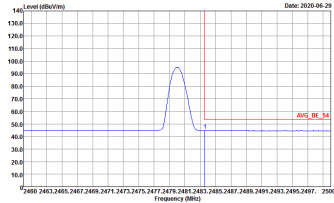
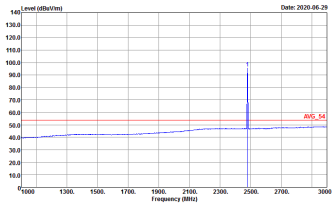
ANT	BLE_Tx_Ch39+802.11n (n20)_Tx_Ch64	
Simultaneously	Horizontal	Fundamental
Peak	 <p>144 Level (dBm/1m) Date: 2020-06-29</p> <p>Site : 03CH15-HY Condition : PEAK_BE_74 3m 91200_15_1620 HORIZONTAL Detector : Peak Project : 051232</p>	 <p>144 Level (dBm/1m) Date: 2020-06-29</p> <p>Site : 03CH15-HY Condition : PEAK_F4 3m 91200_15_1620 HORIZONTAL Detector : Peak Project : 051232</p>
Avg.	 <p>144 Level (dBm/1m) Date: 2020-06-29</p> <p>Site : 03CH15-HY Condition : AVG_BE_54 3m 91200_15_1620 HORIZONTAL Detector : Peak Project : 051232</p>	 <p>144 Level (dBm/1m) Date: 2020-06-29</p> <p>Site : 03CH15-HY Condition : AVG_F4 3m 91200_15_1620 HORIZONTAL Detector : Peak Project : 051232</p>



ANT	BLE_Tx_Ch39+802.11n (n20)_Tx_Ch64	
Simultaneously	Vertical	Fundamental
<p style="text-align: center;"><b>Peak</b></p>	<p>Site : 03CH15-HY            Condition : PEAK_BE_74 3m 91200_15_1620 VERTICAL            Detector : Peak            Project : 051232</p>	<p>Site : 03CH15-HY            Condition : PEAK_74 3m 91200_15_1620 VERTICAL            Detector : Peak            Project : 051232</p>
	<p>Site : 03CH15-HY            Condition : AVG_BE_54 3m 91200_15_1620 VERTICAL            Detector : Peak            Project : 051232</p>	<p>Site : 03CH15-HY            Condition : AVG_54 3m 91200_15_1620 VERTICAL            Detector : Peak            Project : 051232</p>

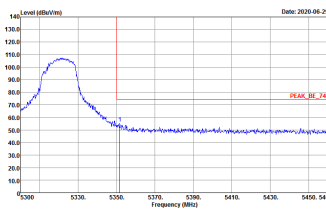
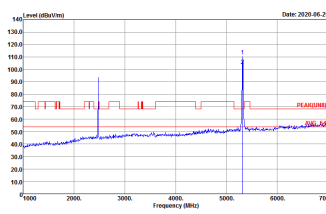
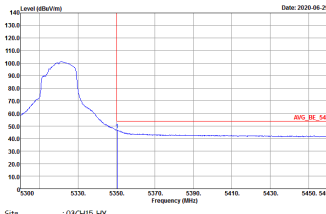

Band 2 - 5250~5350MHz (Band Edge @ 3m)

ANT	BLE_Tx_Ch39+802.11n (n20)_Tx_Ch64	
Simultaneously	Horizontal	Fundamental
Peak	 <p>Site : 03CH15-HY            Condition : PEAK_BE_74 3m 91200_15_1620 HORIZONTAL            RBW:1000.000KHz VBW:3000.000KHz SWT:Auto            Detector : Peak            Project : 051232</p>	 <p>Site : 03CH15-HY            Condition : PEAK(UNIT) 3m 91200_15_1620 HORIZONTAL            RBW:1000.000KHz VBW:3000.000KHz SWT:Auto            Detector : Peak            Project : 051232</p>
Avg.	 <p>Site : 03CH15-HY            Condition : AVG_BE_54 3m 91200_15_1620 HORIZONTAL            RBW:1000.000KHz VBW:1000KHz SWT:Auto            Detector : Peak            Project : 051232</p>	Left blank

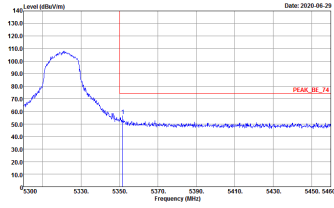
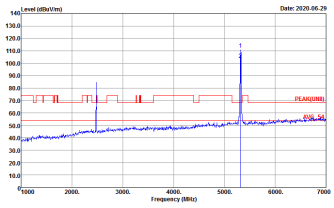
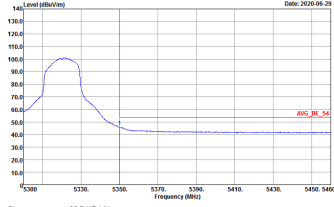

ANT	BLE_Tx_Ch39+802.11n (n20)_Tx_Ch64	
Simultaneously	Vertical	Fundamental
<p style="text-align: center;"><b>Peak</b></p>	 <p>Site : 03CH15-HY            Condition : PEAK_BE_74 3m 91200_15_1620 VERTICAL            Detector : Peak            Project : 051232</p>	 <p>Site : 03CH15-HY            Condition : PEAK(FUND) 3m 91200_15_1620 VERTICAL            Detector : Peak            Project : 051232</p>
<p style="text-align: center;"><b>Avg.</b></p>	 <p>Site : 03CH15-HY            Condition : AVG_BE_54 3m 91200_15_1620 VERTICAL            Detector : Peak            Project : 051232</p>	<p style="text-align: center;"><b>Left blank</b></p>

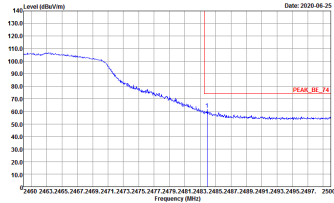
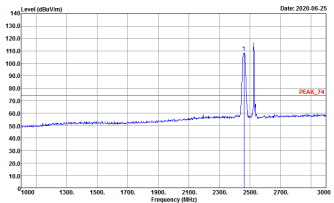
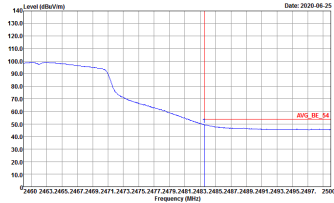
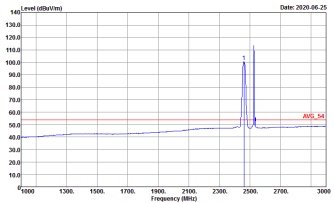

WLAN 2.4GHz 2400~2483.5MHz (Band Edge @ 3m)

ANT	802.11n (n20)_Tx_Ch11+LTE Band 7 BW 20M	
Simultaneously	Horizontal	Fundamental
Peak	 <p>Site : 03CH15-HY            Condition : PEAK_BE_74 3m 91200_15_1620 HORIZONTAL            : RBW:1000.0000kHz VBW:3000.0000kHz SWT:Auto            Detector : Peak            Project : 051232            Mode : LTE B7 20M1R80+11a(n20)_Tx_Ch11</p>	 <p>Site : 03CH15-HY            Condition : PEAK_74 3m 91200_15_1620 HORIZONTAL            : RBW:1000.0000kHz VBW:3000.0000kHz SWT:Auto            Detector : Peak            Project : 051232            Mode : LTE B7 20M1R80+11a(n20)_Tx_Ch11</p>
Avg.	 <p>Site : 03CH15-HY            Condition : AVG_BE_54 3m 91200_15_1620 HORIZONTAL            : RBW:1000.0000kHz VBW:10000Hz SWT:Auto            Detector : Peak            Project : 051232            Mode : LTE B7 20M1R80+11a(n20)_Tx_Ch11</p>	 <p>Site : 03CH15-HY            Condition : AVG_54 3m 91200_15_1620 HORIZONTAL            : RBW:1000.0000kHz VBW:10000Hz SWT:Auto            Detector : Peak            Project : 051232            Mode : LTE B7 20M1R80+11a(n20)_Tx_Ch11</p>

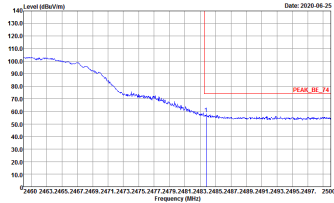
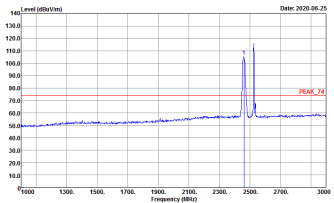
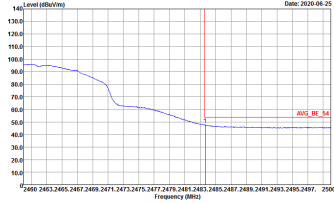
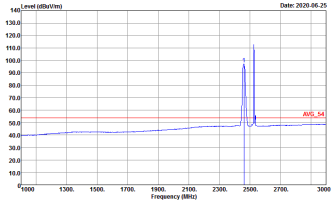

ANT	802.11n (n20)_Tx_Ch11+LTE Band 7 BW 20M	
Simultaneously	Vertical	Fundamental
<p style="text-align: center;"><b>Peak</b></p>	 <p>Site : 03CH15-HY            Condition : PEAK_95_74 3m 91200_15_1620 VERTICAL            Detector : Peak            Project : 051232            Mode : LTE B7 20MHzRB0+11a(n20)_Tx_Ch11</p>	 <p>Site : 03CH15-HY            Condition : PEAK_74 3m 91200_15_1620 VERTICAL            Detector : Peak            Project : 051232            Mode : LTE B7 20MHzRB0+11a(n20)_Tx_Ch11</p>
<p style="text-align: center;"><b>Avg.</b></p>	 <p>Site : 03CH15-HY            Condition : AVG_BE_54 3m 91200_15_1620 VERTICAL            Detector : Peak            Project : 051232            Mode : LTE B7 20MHzRB0+11a(n20)_Tx_Ch11</p>	 <p>Site : 03CH15-HY            Condition : AVG_54 3m 91200_15_1620 VERTICAL            Detector : Peak            Project : 051232            Mode : LTE B7 20MHzRB0+11a(n20)_Tx_Ch11</p>

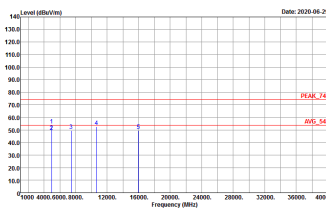
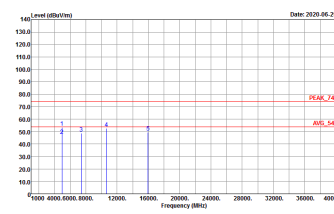

BLE\_Tx\_Ch39+11n(n20)\_Tx\_Ch64 (Harmonic @ 3m)

ANT	BLE_Tx_Ch39+802.11n (n20)_Tx_Ch64	
Simultaneously	Horizontal	Vertical
<p style="text-align: center;"><b>Peak</b> <b>Avg.</b></p>	 <p style="font-size: small;">Date: 2020-06-29</p> <p style="font-size: x-small;">Site : 03CH15-HY Condition : PEAK_74 3m 91200_15_1620 HORIZONTAL Detector : Peak Project : 051232 Setting : 7</p>	 <p style="font-size: small;">Date: 2020-06-29</p> <p style="font-size: x-small;">Site : 03CH15-HY Condition : PEAK_74 3m 91200_15_1620 VERTICAL Detector : Peak Project : 051232 Setting : 7</p>



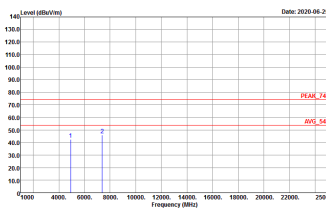
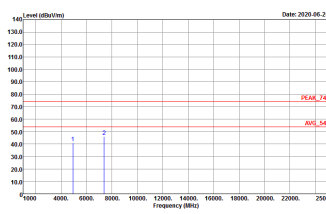

802.11n(n20)\_Tx\_Ch11+LTE Band 7 BW 20M (Harmonic @ 3m)

ANT	802.11n(n20)_Tx_Ch11+LTE Band 7 BW 20M	
Simultaneously	Horizontal	Vertical
<p style="text-align: center;"><b>Peak</b> <b>Avg.</b></p>	 <p>Site : 03CH15-HY            Condition : PEAK_74 3m 91200_15_1620 HORIZONTAL            Detector : Peak            Project : 051232            Mode : LTE B7 20MHzR8+11a(n20)_Tx_Ch11</p>	 <p>Site : 03CH15-HY            Condition : PEAK_74 3m 91200_15_1620 VERTICAL            Detector : Peak            Project : 051232            Mode : LTE B7 20MHzR8+11a(n20)_Tx_Ch11</p>



Emission below 1GHz

BLE\_Tx\_Ch39+802.11n (n20)\_Tx\_Ch64 (LF @ 3m)

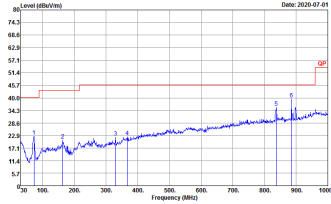
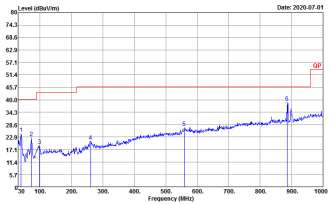
ANT	BLE_Tx_Ch39+802.11n (n20)_Tx_Ch64	
Simultaneously	Horizontal	Vertical
<p style="text-align: center;"><b>Peak</b> <b>Avg.</b></p>	 <p>Site : 03CHIS-HY Condition : QP 3m-BL005_15_41912 HORIZONTAL Detector : Peak Project : 051232 Mode : BLE_Tx_Ch39-11a(n20)_Tx_Ch64</p>	 <p>Site : 03CHIS-HY Condition : QP 3m-BL005_15_41912 VERTICAL Detector : Peak Project : 051232 Mode : BLE_Tx_Ch39-11a(n20)_Tx_Ch64</p>

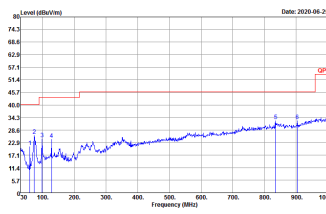
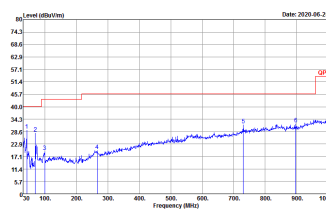

802.11n(n20)\_Tx\_Ch11+LTE Band 7 BW 20M (LF @ 3m)

ANT	802.11n(n20)_Tx_Ch11+LTE Band 7 BW 20M	
Simultaneously	Horizontal	Vertical
<p style="text-align: center;"><b>Peak</b> <b>Avg.</b></p>	 <p>Site : 03CH15-HY            Condition : QP 3m 81LOG_15_41912 HORIZONTAL            Detector : Peak            Project : 051232            Mode : LTE B7 20MHz80+11a(n20)_Tx_Ch11</p>	 <p>Site : 03CH15-HY            Condition : QP 3m 81LOG_15_41912 VERTICAL            Detector : Peak            Project : 051232            Mode : LTE B7 20MHz80+11a(n20)_Tx_Ch11</p>



### Appendix C. Duty Cycle Plots

Antenna	Band	Duty Cycle(%)	T(us)	1/T(kHz)	VBW Setting	Duty Factor(dB)
-	Bluetooth –LE for 2Mbps	31.75	200	5.00	10kHz	4.98
4 + 3	2.4GHz 802.11n HT20 for Ant. 4	98.19	-	-	10Hz	0.08
4 + 3	2.4GHz 802.11n HT20 for Ant. 3	98.19	-	-	10Hz	0.08
4 + 3	5GHz 802.11n HT20 for Ant. 4	98.19	-	-	10Hz	0.08
4 + 3	5GHz 802.11n HT20 for Ant. 3	97.93	1895	0.53	1kHz	0.09



Bluetooth – LE for 2Mbps

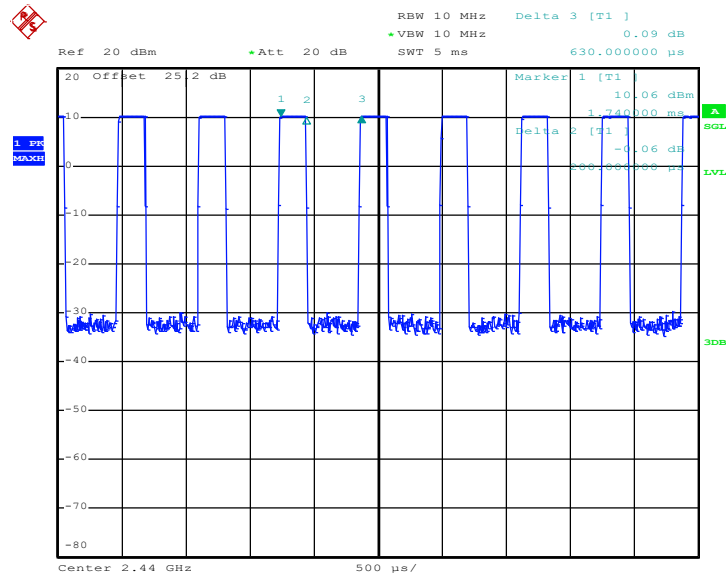



MIMO<Ant. 4 >

2.4G 802.11n HT20

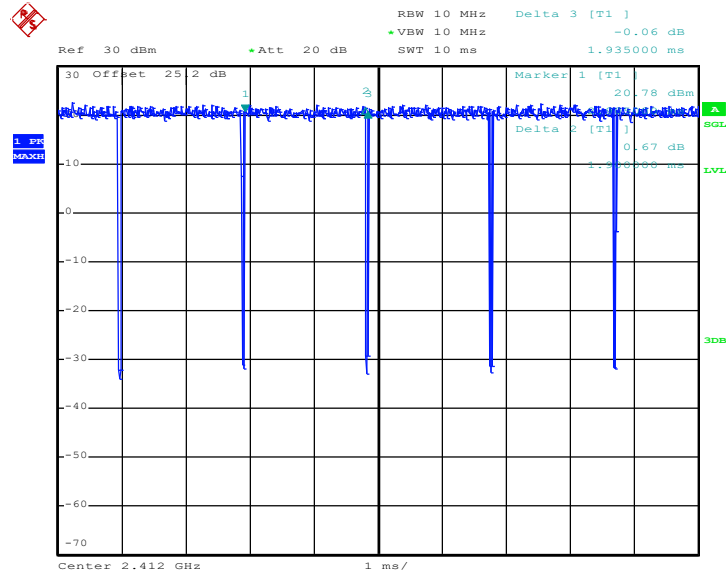

5G 802.11n HT20

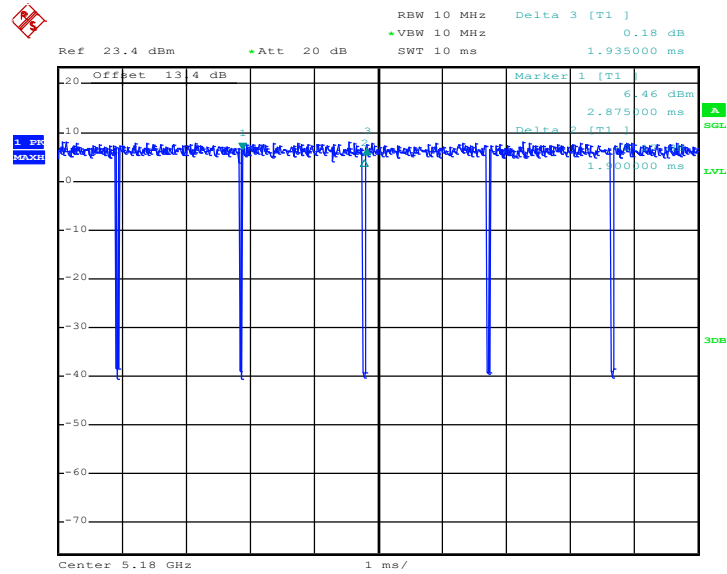



MIMO<Ant. 3>

2.4G 802.11n HT20

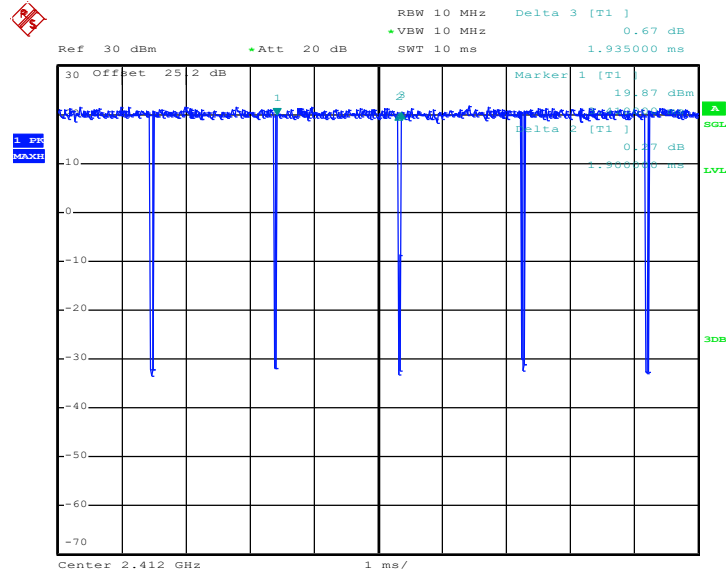

5G 802.11n HT20

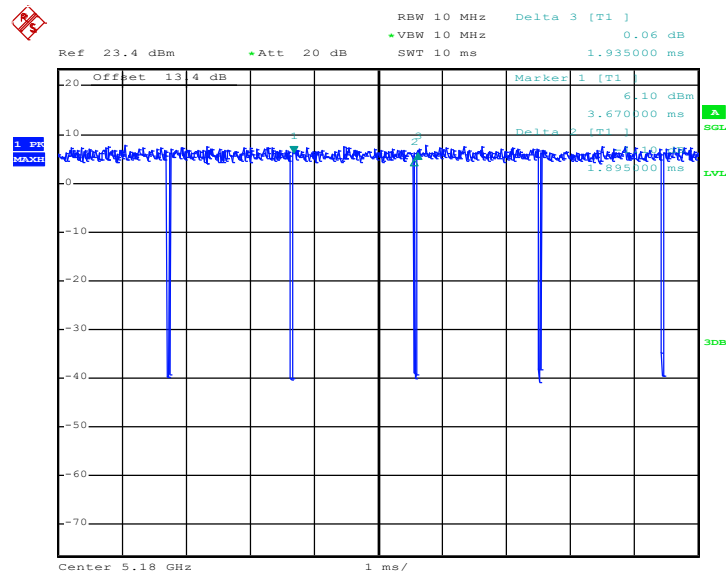

—THE END—