

FCC SAR Test Report

FCC ID : IHDT56ZA1
Equipment : Mobile Cellular Phone
Brand Name : Motorola
Model Name : XT2073-2
Applicant : Motorola Mobility LLC
222 W,Merchandise Mart Plaza, Chicago IL 60654 USA
Manufacturer : Motorola Mobility LLC
222 W,Merchandise Mart Plaza, Chicago IL 60654 USA
Standard : FCC 47 CFR Part 2 (2.1093)
ANSI/IEEE C95.1-1992
IEEE 1528-2013

The product was received on May 26, 2020 and testing was started from May 29, 2020 and completed on Jun. 11, 2020. We, Sporton International (Kunshan) Inc, would like to declare that the tested sample has been evaluated in accordance with the test procedures and has been in compliance with the applicable technical standards.

The report must not be used by the client to claim product certification, approval, or endorsement by TAF or any agency of government.

The test results in this report apply exclusively to the tested model / sample. Without written approval of Sporton International (Kunshan) Inc., the test report shall not be reproduced except in full.

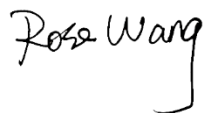

Reviewed by: Rose Wang / Supervisor

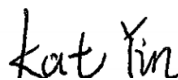

Approved by: Kat Yin / Manager



Sporton International (Kunshan) Inc.
No. 1098, Pengxi North Road, Kunshan Economic Development Zone Jiangsu Province 215300
People's Republic of China



Table of Contents

1. Statement of Compliance 4
2. Administration Data 5
3. Guidance Applied..... 5
4. Equipment Under Test (EUT) Information..... 6
4.1 General Information 6
4.2 General LTE SAR Test and Reporting Considerations 7
5. Proximity Sensor Triggering Test..... 9
6. RF Exposure Limits.....15
6.1 Uncontrolled Environment.....15
6.2 Controlled Environment.....15
7. Specific Absorption Rate (SAR).....16
7.1 Introduction16
7.2 SAR Definition.....16
8. System Description and Setup17
8.1 E-Field Probe18
8.2 Data Acquisition Electronics (DAE)18
8.3 Phantom.....19
8.4 Device Holder.....20
9. Measurement Procedures21
9.1 Spatial Peak SAR Evaluation.....21
9.2 Power Reference Measurement.....22
9.3 Area Scan22
9.4 Zoom Scan.....23
9.5 Volume Scan Procedures.....23
9.6 Power Drift Monitoring.....23
10. Test Equipment List.....24
11. System Verification25
11.1 Tissue Simulating Liquids25
11.2 Tissue Verification26
11.3 System Performance Check Results27
12. RF Exposure Positions28
12.1 Ear and handset reference point.....28
12.2 Definition of the cheek position29
12.3 Definition of the tilt position30
12.4 Body Worn Accessory30
12.5 Product Specific Exposure31
12.6 Wireless Router.....31
13. GSM/UMTS/LTE Output Power (Unit: dBm)32
14. Antenna Location.....38
15. SAR Test Results39
15.1 Hotspot SAR42
15.2 Body Worn Accessory SAR.....45
15.3 Product Specific SAR.....47
15.4 Repeated SAR Measurement49
16. Simultaneous Transmission Analysis.....50
16.1 Hotspot Exposure Conditions.....51
16.2 Body-Worn Accessory Exposure Conditions52
16.3 SPLSR Evaluation and Analysis.....53
17. Uncertainty Assessment55
18. References.....56
Appendix A. Plots of System Performance Check
Appendix B. Plots of High SAR Measurement
Appendix C. DASy Calibration Certificate
Appendix D. Antenna Location & Test Setup Photos
Appendix E. Conducted RF Output Power Table



History of this test report

Report No.	Version	Description	Issued Date
FA052606	01	Initial issue of report	Jun. 15, 2020



1. Statement of Compliance

The maximum results of Specific Absorption Rate (SAR) found during testing for **Motorola Mobility LLC, Mobile Cellular Phone, XT2073-2**, are as follows.

Equipment Class	Frequency Band	Highest SAR Summary			Highest Simultaneous Transmission 1g SAR (W/kg)
		Hotspot (Separation 5mm)	Body-worn (Separation 5mm)	Extremity (Separation 0mm)	
		1g SAR (W/kg)		10g SAR (W/kg)	
Equipment Class	GSM1900	1.17	1.16	1.61	1.55
	WCDMA II	1.33	1.16	2.45	
	WCDMA IV	1.23	1.18	3.19	
	LTE Band 2	1.35	1.35	2.47	
	LTE Band 7	1.29	1.29	2.85	
	LTE Band 4 / 66	1.13	1.12	2.95	
	2.4GHz WLAN				1.39
	Bluetooth				1.55
Date of Testing:		2020/5/29 ~ 2020/6/11			
Remark: This device supports LTE B4 and B66. Since the supported frequency span for LTE B4 falls completely within the supports frequency span for LTE B66, both LTE bands have the same target power, and both LTE bands share the same transmission path; therefore, SAR was only assessed for LTE B66.					

Declaration of Conformity:
The test results with all measurement uncertainty excluded are presented in accordance with the regulation limits or requirements declared by manufacturers.
Comments and Explanations:
The declared of product specification for EUT presented in the report are provided by the manufacturer, and the manufacturer takes all the responsibilities for the accuracy of product specification.

This device is in compliance with Specific Absorption Rate (SAR) for general population/uncontrolled exposure limits (1.6 W/kg for Partial-Body 1g SAR, 4.0 W/kg for Product Specific 10g SAR) specified in FCC 47 CFR part 2 (2.1093) and ANSI/IEEE C95.1-1992, and had been tested in accordance with the measurement methods and procedures specified in IEEE 1528-2013 and FCC KDB publications.



2. Administration Data

Sporton International (Kunshan) Inc. is accredited to ISO/IEC 17025:2017 by American Association for Laboratory Accreditation with Certificate Number 5145.02.

Testing Laboratory		
Test Firm	Sporton International (Kunshan) Inc.	
Test Site Location	No. 1098, Pengxi North Road, Kunshan Economic Development Zone Jiangsu Province 215300 People's Republic of China TEL : +86-512-57900158 FAX : +86-512-57900958	
Test Site No.	FCC Designation No.	FCC Test Firm Registration No.
	CN1257	314309

3. Guidance Applied

The Specific Absorption Rate (SAR) testing specification, method, and procedure for this device is in accordance with the following standards:

- FCC 47 CFR Part 2 (2.1093)
- ANSI/IEEE C95.1-1992
- IEEE 1528-2013
- FCC KDB 865664 D01 SAR Measurement 100 MHz to 6 GHz v01r04
- FCC KDB 865664 D02 SAR Reporting v01r02
- FCC KDB 447498 D01 General RF Exposure Guidance v06
- FCC KDB 648474 D04 SAR Evaluation Considerations for Wireless Handsets v01r03
- FCC KDB 248227 D01 802.11 Wi-Fi SAR v02r02
- FCC KDB 941225 D01 3G SAR Procedures v03r01
- FCC KDB 941225 D05 SAR for LTE Devices v02r05
- FCC KDB 941225 D06 Hotspot Mode SAR v02r01
- FCC KDB 941225 D07 UMPC Mini Tablet v01r02



4. Equipment Under Test (EUT) Information

4.1 General Information

Product Feature & Specification	
Equipment Name	Mobile Cellular Phone
Brand Name	Motorola
Model Name	XT2073-2
FCC ID	IHDT56ZA1
IMEI Code	SIM1: 353596110092087 SIM2: 353596110122082
Wireless Technology and Frequency Range	GSM850: 824.2 MHz ~ 848.8 MHz GSM1900: 1850.2 MHz ~ 1909.8 MHz WCDMA Band II: 1850 MHz ~ 1910 MHz WCDMA Band IV: 1710 MHz ~ 1755 MHz WCDMA Band V: 824 MHz ~ 849 MHz LTE Band 2: 1850 MHz ~ 1910 MHz LTE Band 4: 1710 MHz ~ 1755 MHz LTE Band 5: 824 MHz ~ 849 MHz LTE Band 7: 2500 MHz ~ 2570 MHz LTE Band 66: 1710 MHz ~ 1780 MHz WLAN 2.4GHz Band: 2400 MHz ~ 2483.5 MHz Bluetooth: 2400 MHz ~ 2483.5 MHz
Mode	GSM/GPRS/EGPRS RMC/AMR 12.2Kbps HSDPA HSUPA DC-HSDPA LTE: QPSK, 16QAM, 64QAM WLAN: 802.11b/g/n HT20 Bluetooth BR/EDR/LE
GSM / (E)GPRS Transfer mode	Class B – EUT cannot support Packet Switched and Circuit Switched Network simultaneously but can automatically switch between Packet and Circuit Switched Network.
EUT Stage	Identical Prototype
Remark: 1. This device WLAN 2.4GHz supports Hotspot operation and Bluetooth support tethering applications. 2. The device implements the power management for SAR compliance at different exposure conditions (head, body-worn, hotspot, extremity) and the device will manage to ensure the averaged power level not exceeding the associated tune-up power table. Proximity sensors are used to detect the exposure conditions and the verification is illustrated in section 5. Details about the power management decision are provided in the operational description. 3. The difference between battery1 and 2 is manufacturer so RF exposure is select battery1 to be tested. 4. There are three earphones, only chose one earphone to perform SAR testing. 5. This is a variant report for XT2073-2, for model change note, please refer to the product equality declaration exhibit submitted. Based on the similarity between two models, GSM1900, WCDMA Band II/IV and LTE B2/4/7/66 full SAR testing for Body Worn/Hotspot/Handheld for lower reduced power level. Proximity sensor trigger distance changed, so distance SAR with full power verified, other test data was performed on original report which can be refer to Sporton Report Number FA011726.	



4.2 General LTE SAR Test and Reporting Considerations

Summarized necessary items addressed in KDB 941225 D05 v02r05								
FCC ID	IHDT56ZA1							
Equipment Name	Mobile Cellular Phone							
Operating Frequency Range of each LTE transmission band	LTE Band 2: 1850 MHz ~ 1910 MHz LTE Band 4: 1710 MHz ~ 1755 MHz LTE Band 5: 824 MHz ~ 849 MHz LTE Band 7: 2500 MHz ~ 2570 MHz LTE Band 66: 1710 MHz ~ 1780 MHz							
Channel Bandwidth	LTE Band 02: 1.4MHz, 3MHz, 5MHz, 10MHz, 15MHz, 20MHz LTE Band 04: 1.4MHz, 3MHz, 5MHz, 10MHz, 15MHz, 20MHz LTE Band 05: 1.4MHz, 3MHz, 5MHz, 10MHz LTE Band 07: 5MHz, 10MHz, 15MHz, 20MHz LTE Band 66: 1.4MHz, 3MHz, 5MHz, 10MHz, 15MHz, 20MHz							
uplink modulations used	QPSK / 16QAM / 64QAM							
LTE Voice / Data requirements	Voice and Data							
LTE MPR permanently built-in by design	Table 6.2.3-1: Maximum Power Reduction (MPR) for Power Class 1, 2 and 3							
	Modulation	Channel bandwidth / Transmission bandwidth (N _{RB})						MPR (dB)
		1.4 MHz	3.0 MHz	5 MHz	10 MHz	15 MHz	20 MHz	
	QPSK	> 5	> 4	> 8	> 12	> 16	> 18	≤ 1
	16 QAM	≤ 5	≤ 4	≤ 8	≤ 12	≤ 16	≤ 18	≤ 1
	16 QAM	> 5	> 4	> 8	> 12	> 16	> 18	≤ 2
	64 QAM	≤ 5	≤ 4	≤ 8	≤ 12	≤ 16	≤ 18	≤ 2
64 QAM	> 5	> 4	> 8	> 12	> 16	> 18	≤ 3	
256 QAM	≥ 1						≤ 5	
LTE A-MPR	In the base station simulator configuration, Network Setting value is set to NS_01 to disable A-MPR during SAR testing and the LTE SAR tests was transmitting on all TTI frames (Maximum TTI)							
Spectrum plots for RB configuration	A properly configured base station simulator was used for the SAR and power measurement; therefore, spectrum plots for each RB allocation and offset configuration are not included in the SAR report.							
Power reduction applied to satisfy SAR compliance	Yes, when operating in hotspot / Body-worn and extremity mode that LTE B2/B4/B7/B66 power reduction applied to satisfy SAR compliance.							



Transmission (H, M, L) channel numbers and frequencies in each LTE band												
LTE Band 2												
	Bandwidth 1.4 MHz		Bandwidth 3 MHz		Bandwidth 5 MHz		Bandwidth 10 MHz		Bandwidth 15 MHz		Bandwidth 20 MHz	
	Ch. #	Freq. (MHz)	Ch. #	Freq. (MHz)	Ch. #	Freq. (MHz)	Ch. #	Freq. (MHz)	Ch. #	Freq. (MHz)	Ch. #	Freq. (MHz)
L	18607	1850.7	18615	1851.5	18625	1852.5	18650	1855	18675	1857.5	18700	1860
M	18900	1880	18900	1880	18900	1880	18900	1880	18900	1880	18900	1880
H	19193	1909.3	19185	1908.5	19175	1907.5	19150	1905	19125	1902.5	19100	1900
LTE Band 4												
	Bandwidth 1.4 MHz		Bandwidth 3 MHz		Bandwidth 5 MHz		Bandwidth 10 MHz		Bandwidth 15 MHz		Bandwidth 20 MHz	
	Ch. #	Freq. (MHz)	Ch. #	Freq. (MHz)	Ch. #	Freq. (MHz)	Ch. #	Freq. (MHz)	Ch. #	Freq. (MHz)	Ch. #	Freq. (MHz)
L	19957	1710.7	19965	1711.5	19975	1712.5	20000	1715	20025	1717.5	20050	1720
M	20175	1732.5	20175	1732.5	20175	1732.5	20175	1732.5	20175	1732.5	20175	1732.5
H	20393	1754.3	20385	1753.5	20375	1752.5	20350	1750	20325	1747.5	20300	1745
LTE Band 5												
	Bandwidth 1.4 MHz		Bandwidth 3 MHz		Bandwidth 5 MHz		Bandwidth 10 MHz					
	Ch. #	Freq. (MHz)	Ch. #	Freq. (MHz)	Ch. #	Freq. (MHz)	Ch. #	Freq. (MHz)	Ch. #	Freq. (MHz)	Ch. #	Freq. (MHz)
L	20407	824.7	20415	825.5	20425	826.5	20450	829				
M	20525	836.5	20525	836.5	20525	836.5	20525	836.5				
H	20643	848.3	20635	847.5	20625	846.5	20600	844				
LTE Band 7												
	Bandwidth 5 MHz		Bandwidth 10 MHz		Bandwidth 15 MHz		Bandwidth 20 MHz					
	Ch. #	Freq. (MHz)	Ch. #	Freq. (MHz)	Ch. #	Freq. (MHz)	Ch. #	Freq. (MHz)	Ch. #	Freq. (MHz)	Ch. #	Freq. (MHz)
L	20775	2502.5	20800	2505	20825	2507.5	20850	2510				
M	21100	2535	21100	2535	21100	2535	21100	2535				
H	21425	2567.5	21400	2565	21375	2562.5	21350	2560				
LTE Band 66												
	Bandwidth 1.4 MHz		Bandwidth 3 MHz		Bandwidth 5 MHz		Bandwidth 10 MHz		Bandwidth 15 MHz		Bandwidth 20 MHz	
	Ch. #	Freq. (MHz)	Ch. #	Freq. (MHz)	Ch. #	Freq. (MHz)	Ch. #	Freq. (MHz)	Ch. #	Freq. (MHz)	Ch. #	Freq. (MHz)
L	131979	1710.7	131987	1711.5	131997	1712.5	132022	1715	132047	1717.5	132072	1720
M	132322	1745	132322	1745	132322	1745	132322	1745	132322	1745	132322	1745
H	132665	1779.3	132657	1778.5	132647	1777.5	132622	1775	132597	1772.5	132572	1770

5. Proximity Sensor Triggering Test

<Proximity Sensor Triggering Distance>:

1. Proximity sensor triggering distance testing was performed according to the procedures outlined in KDB 616217 D04 section 6.2, and EUT moving further away from the flat phantom and EUT moving toward the flat phantom were both assessed and the tissue-equivalent medium for highest frequency (2600MHz) and lowest (1750MHz) frequency was used for proximity sensor triggering testing.
2. Capacitive proximity sensors placed coincident with antenna elements at the top and bottom ends of the phone are utilized to determine when the device comes in proximity of the user's body at the front or back and extremity at bottom side of the device.
3. The output power will reduce to body worn and extremity power level when top and bottom sensor pad be detected.
4. The sensors used to detect the proximity of the user's body (Body-Worn condition) at the front or back surface and extremity (Product Specific condition) at bottom side of the device use a detection threshold distance. The data shown in the sections below shows the distance(s).
5. The device additionally employs proximity sensors that detect the presence of tissue near the currently active transmit antenna (if that antenna may require reduced power relative the Default power table in order to meet extremity SAR limits). The control logic is such that, if the Body-Worn, At-Head or WiFi Hotspot conditions are not detected, but tissue (as a finger or hand, for example) is detected near the transmitting antenna, the Handheld Reduced power table will be applied
6. When the sensor is active, the device will reduced maximum output powers on the GSM1900, WCDMA BII/BIV and LTE B2/B4/B7/B66 transmitter.
7. Body-worn/Hotspot SAR was tested at 5mm separation and extremity SAR was tested at 0mm separation, at the reduced power level in each associated power table. For verification of compliance of power reduction scheme, additional SAR testing with EUT transmitting at full RF power at a conservative trigger distance was performed:
 - a. For Body-worn:
 - Front: [9 mm](#)
 - Back: [19 mm](#)
 - b. For Extremity, only base on the actual performed 0mm face SAR.
 - Back: [9 mm](#)
 - Bottom: [6 mm](#)

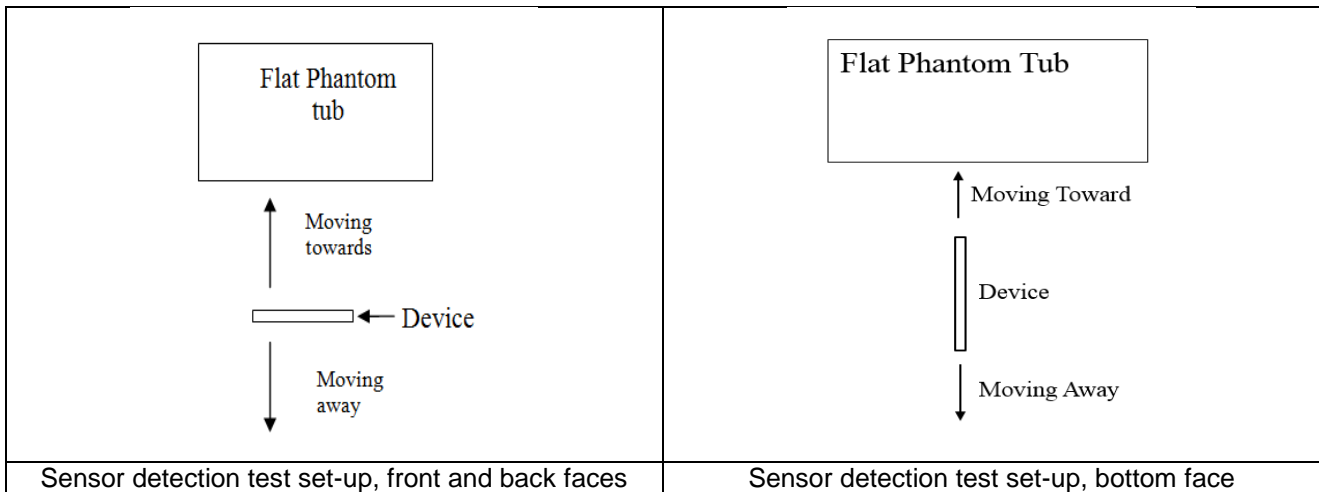

Proximity Sensor Trigger Distance (mm) of Body-worn				
Position	Front		Back	
Position	Moving towards	Moving away	Moving towards	Moving away
Minimum	10	12	20	25

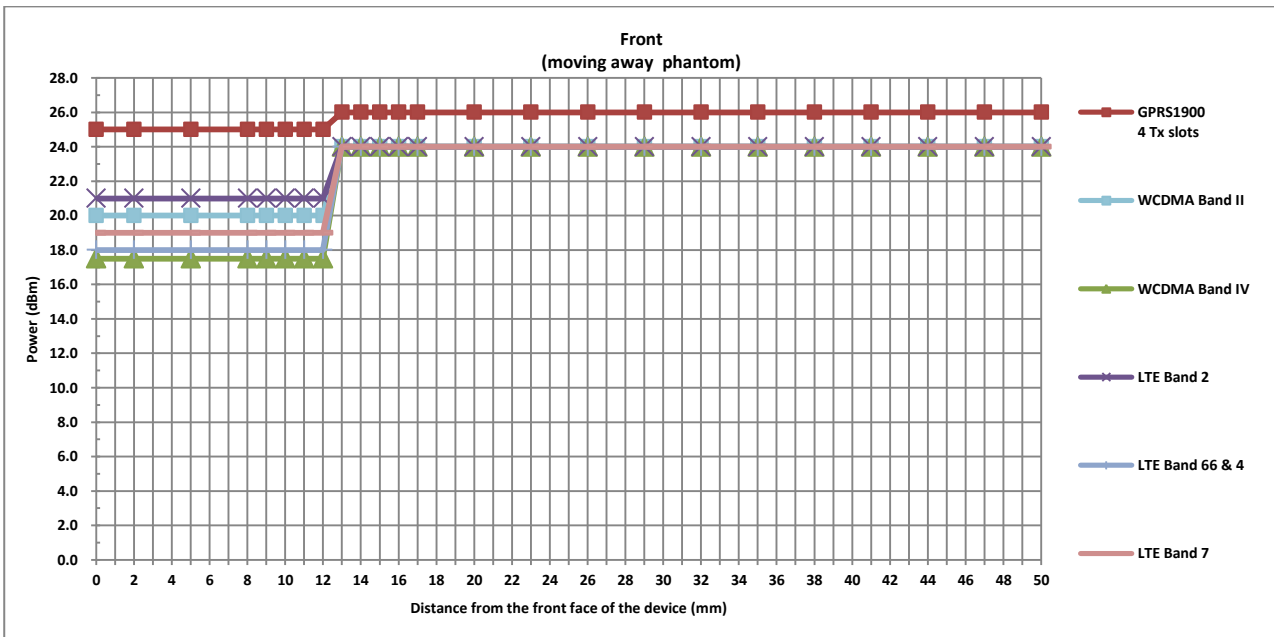
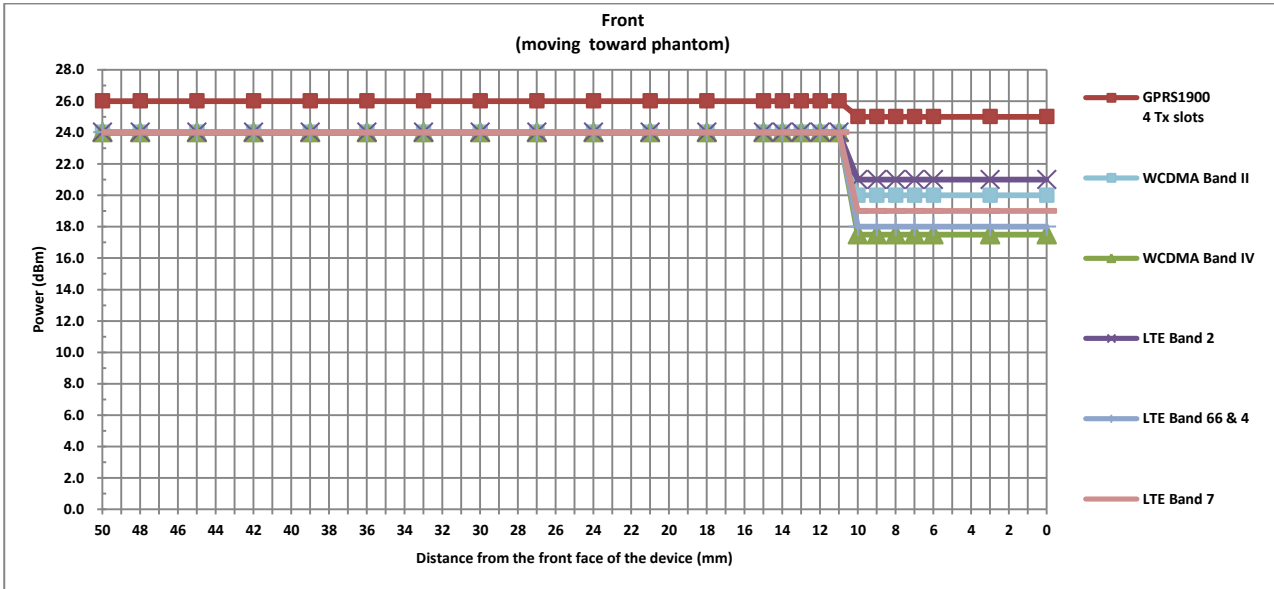

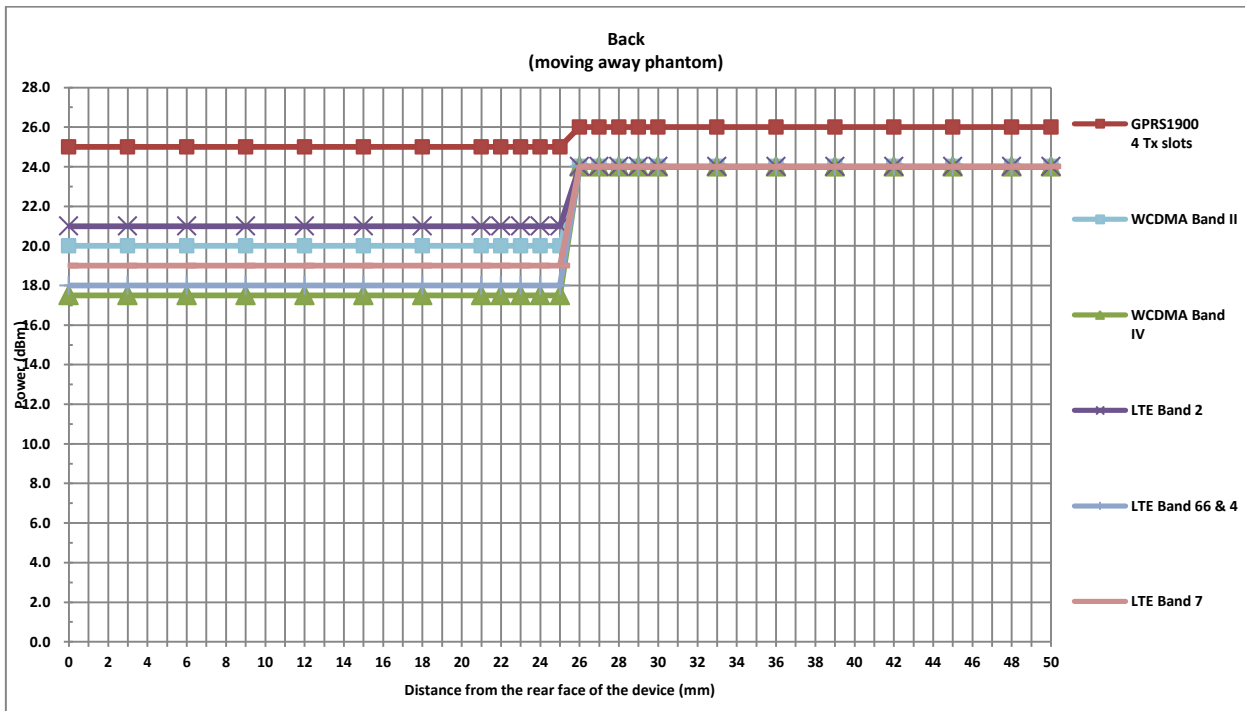
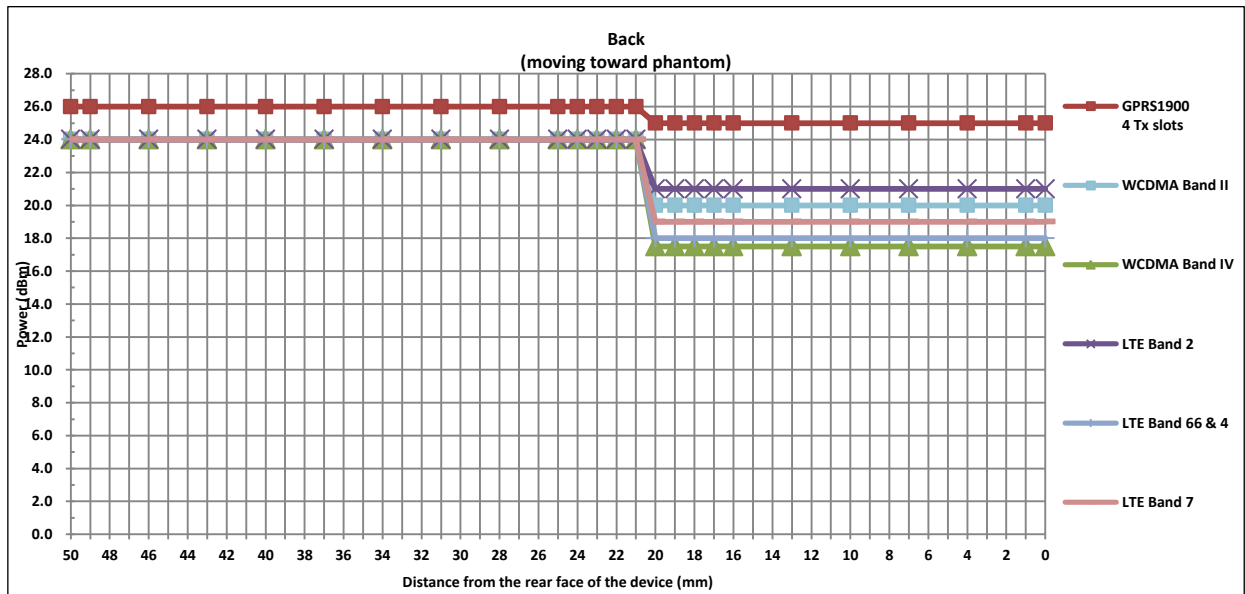

Proximity Sensor Trigger Distance (mm) of Extremity						
Position	Front		Back		Bottom Side	
Position	Moving towards	Moving away	Moving towards	Moving away	Moving towards	Moving away
Minimum	4	8	10	20	7	13

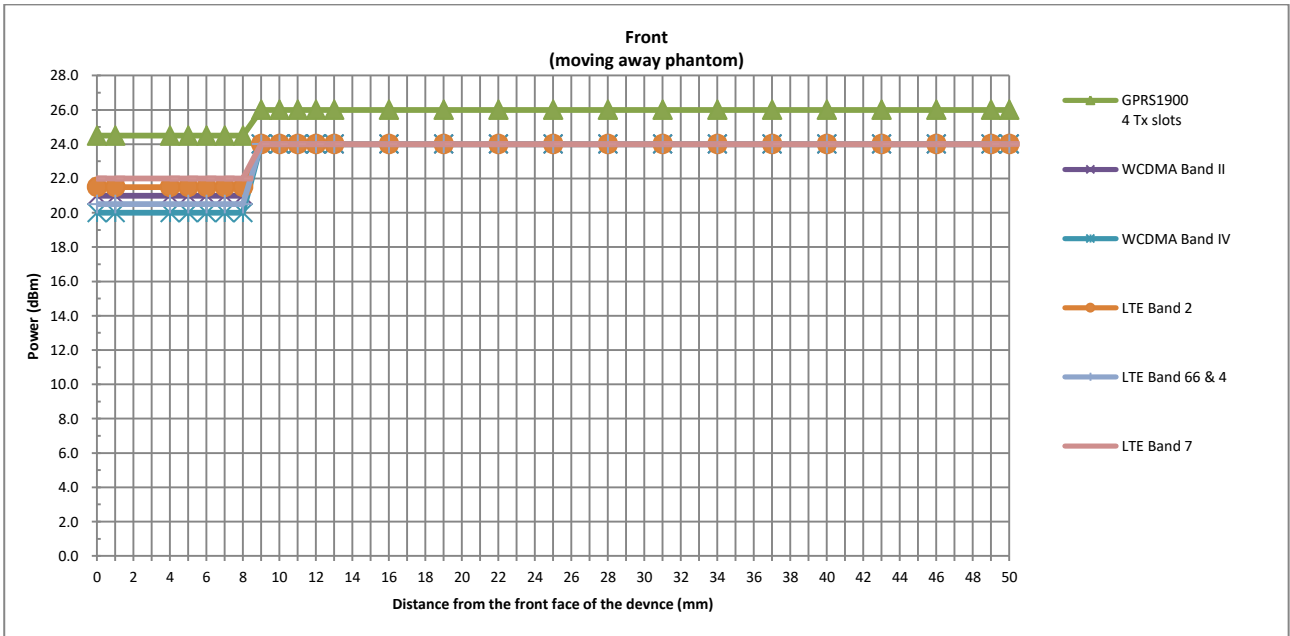
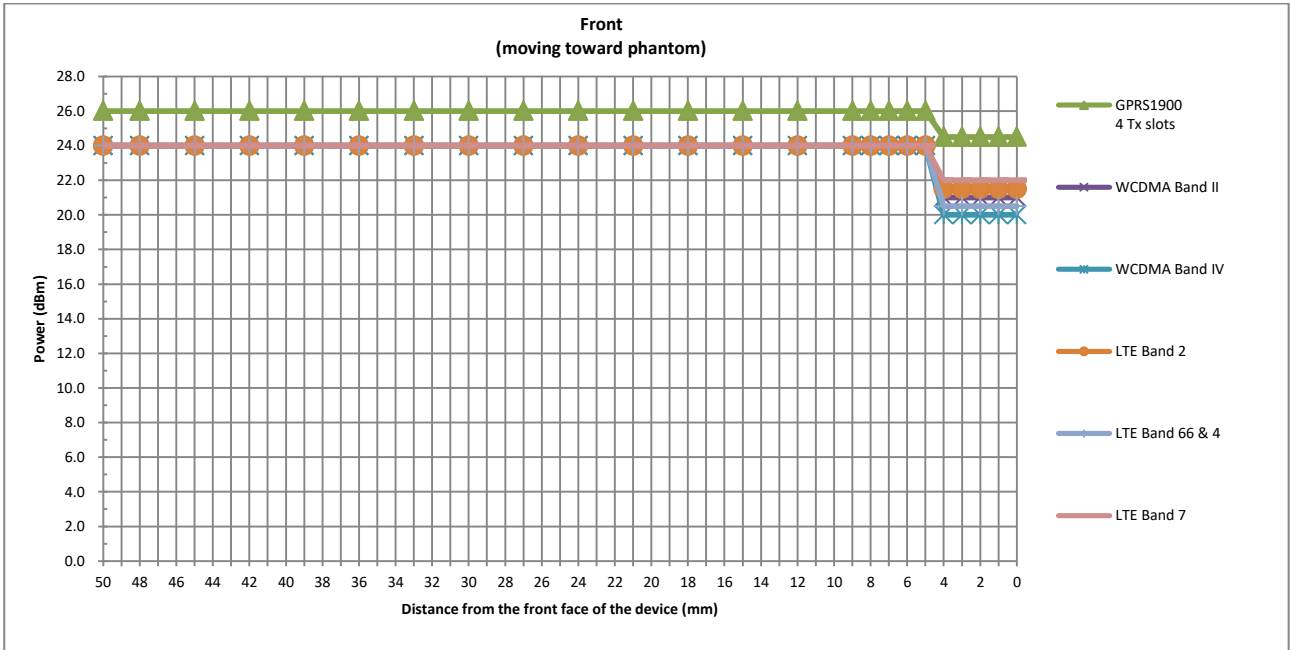

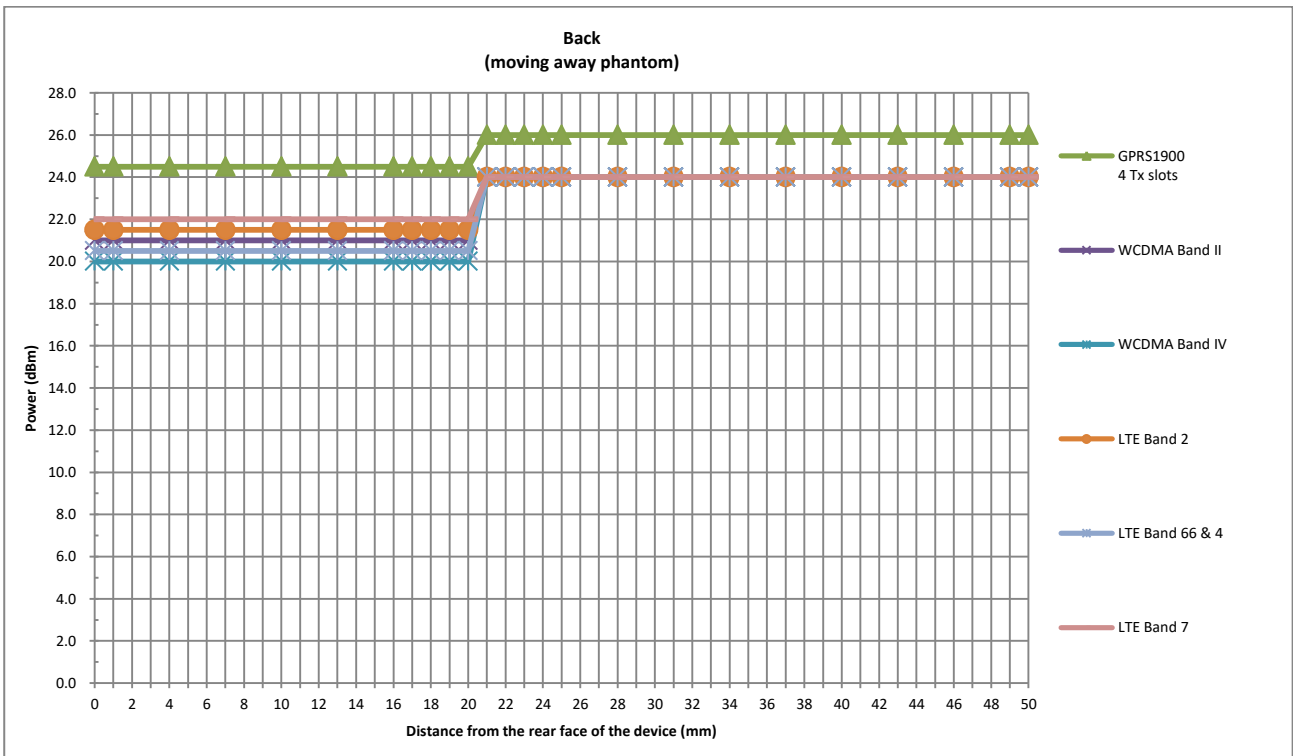
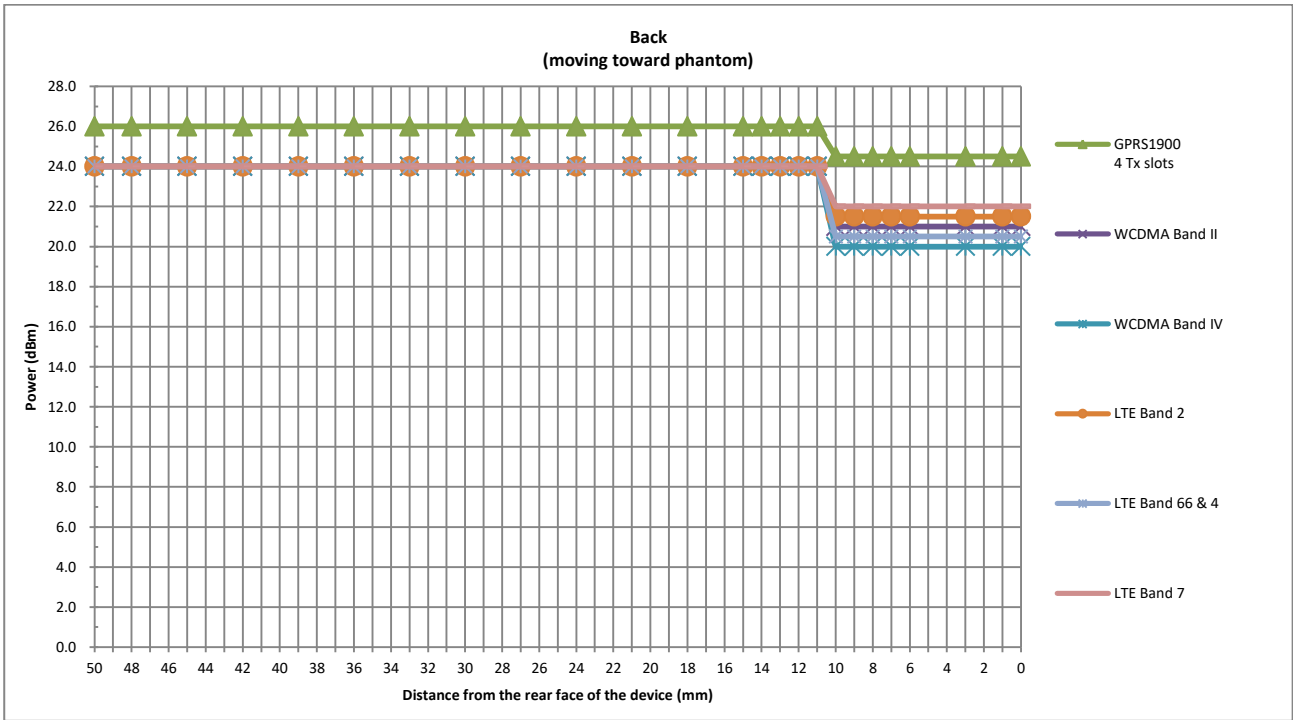

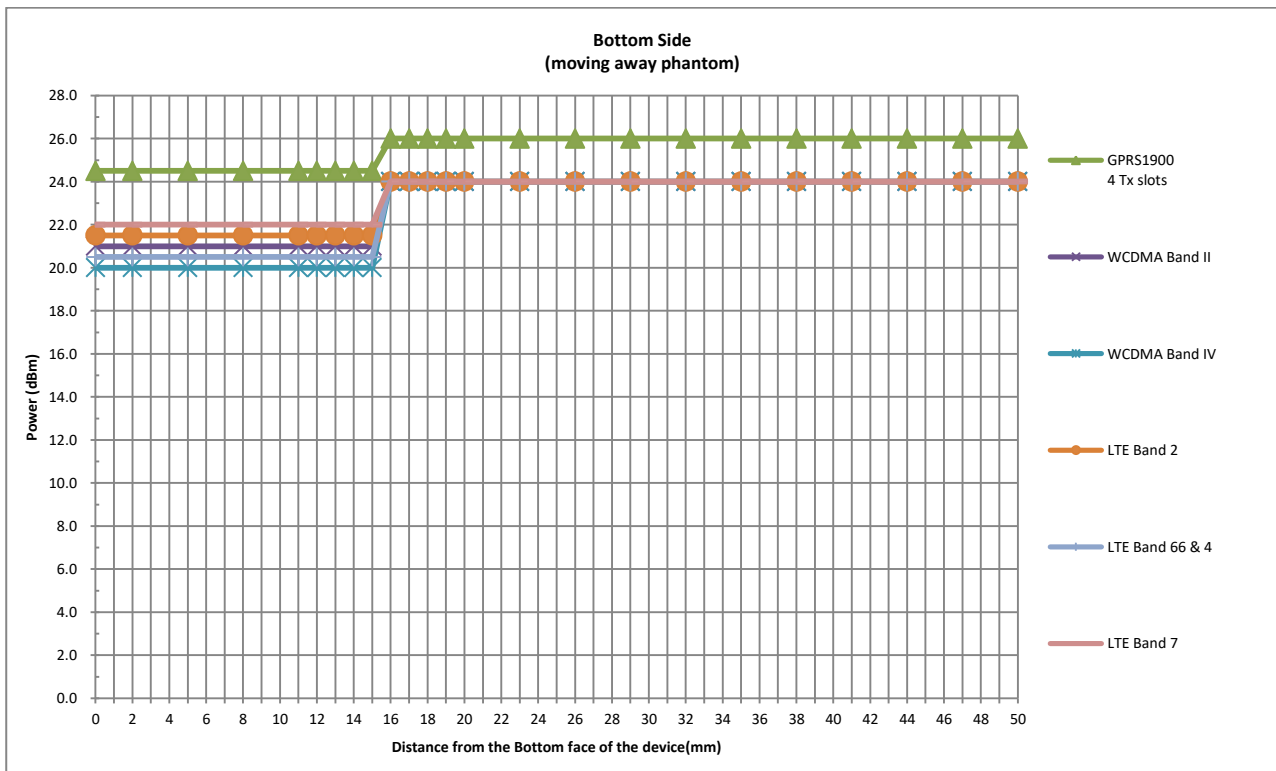
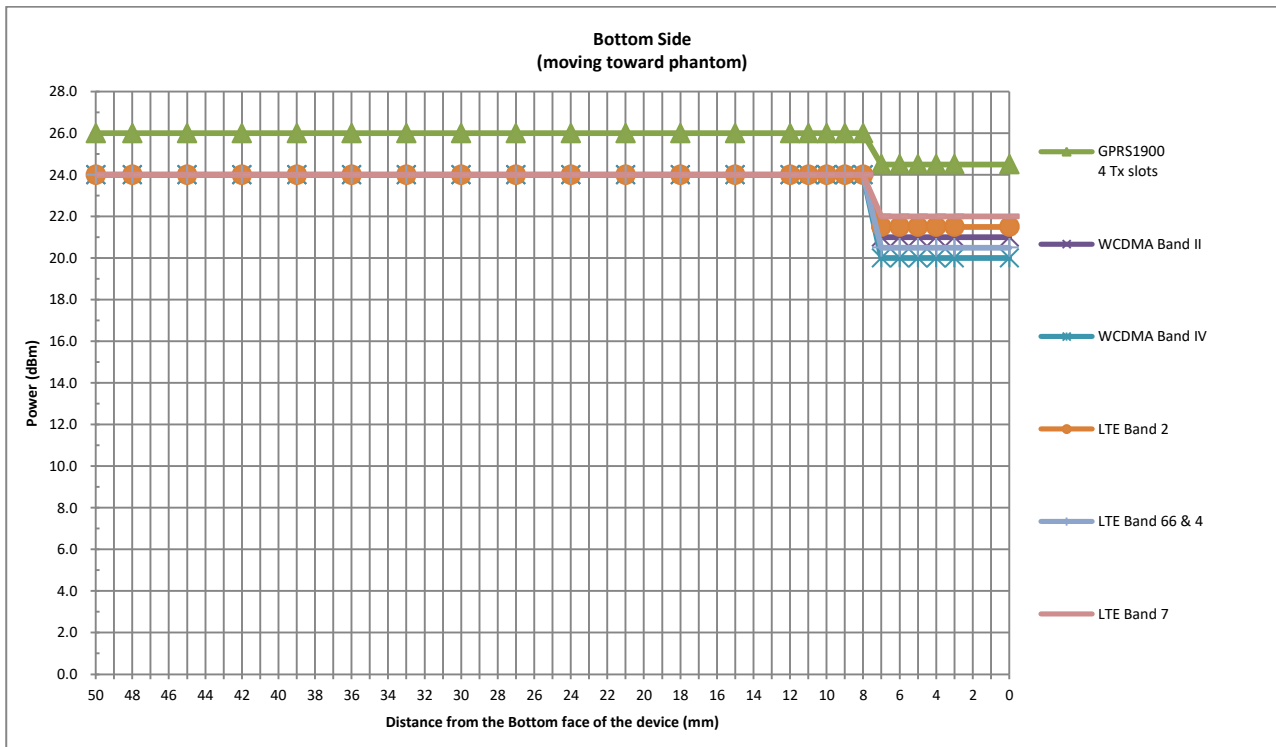

6. RF Exposure Limits

6.1 Uncontrolled Environment

Uncontrolled Environments are defined as locations where there is the exposure of individuals who have no knowledge or control of their exposure. The general population/uncontrolled exposure limits are applicable to situations in which the general public may be exposed or in which persons who are exposed as a consequence of their employment may not be made fully aware of the potential for exposure or cannot exercise control over their exposure. Members of the general public would come under this category when exposure is not employment-related; for example, in the case of a wireless transmitter that exposes persons in its vicinity.

6.2 Controlled Environment

Controlled Environments are defined as locations where there is exposure that may be incurred by persons who are aware of the potential for exposure, (i.e. as a result of employment or occupation). In general, occupational/controlled exposure limits are applicable to situations in which persons are exposed as a consequence of their employment, who have been made fully aware of the potential for exposure and can exercise control over their exposure. The exposure category is also applicable when the exposure is of a transient nature due to incidental passage through a location where the exposure levels may be higher than the general population/uncontrolled limits, but the exposed person is fully aware of the potential for exposure and can exercise control over his or her exposure by leaving the area or by some other appropriate means.

Limits for Occupational/Controlled Exposure (W/kg)

Whole-Body	Partial-Body	Hands, Wrists, Feet and Ankles
0.4	8.0	20.0

Limits for General Population/Uncontrolled Exposure (W/kg)

Whole-Body	Partial-Body	Hands, Wrists, Feet and Ankles
0.08	1.6	4.0

1. Whole-Body SAR is averaged over the entire body, partial-body SAR is averaged over any 1gram of tissue defined as a tissue volume in the shape of a cube. SAR for hands, wrists, feet and ankles is averaged over any 10 grams of tissue defined as a tissue volume in the shape of a cube.

7. Specific Absorption Rate (SAR)

7.1 Introduction

SAR is related to the rate at which energy is absorbed per unit mass in an object exposed to a radio field. The SAR distribution in a biological body is complicated and is usually carried out by experimental techniques or numerical modeling. The standard recommends limits for two tiers of groups, occupational/controlled and general population/uncontrolled, based on a person's awareness and ability to exercise control over his or her exposure. In general, occupational/controlled exposure limits are higher than the limits for general population/uncontrolled.

7.2 SAR Definition

The SAR definition is the time derivative (rate) of the incremental energy (dW) absorbed by (dissipated in) an incremental mass (dm) contained in a volume element (dv) of a given density (ρ). The equation description is as below:

$$SAR = \frac{d}{dt} \left(\frac{dW}{dm} \right) = \frac{d}{dt} \left(\frac{dW}{\rho dv} \right)$$

SAR is expressed in units of Watts per kilogram (W/kg)

$$SAR = \frac{\sigma |E|^2}{\rho}$$

Where: σ is the conductivity of the tissue, ρ is the mass density of the tissue and E is the RMS electrical field strength.

8. System Description and Setup

The DASY system used for performing compliance tests consists of the following items:

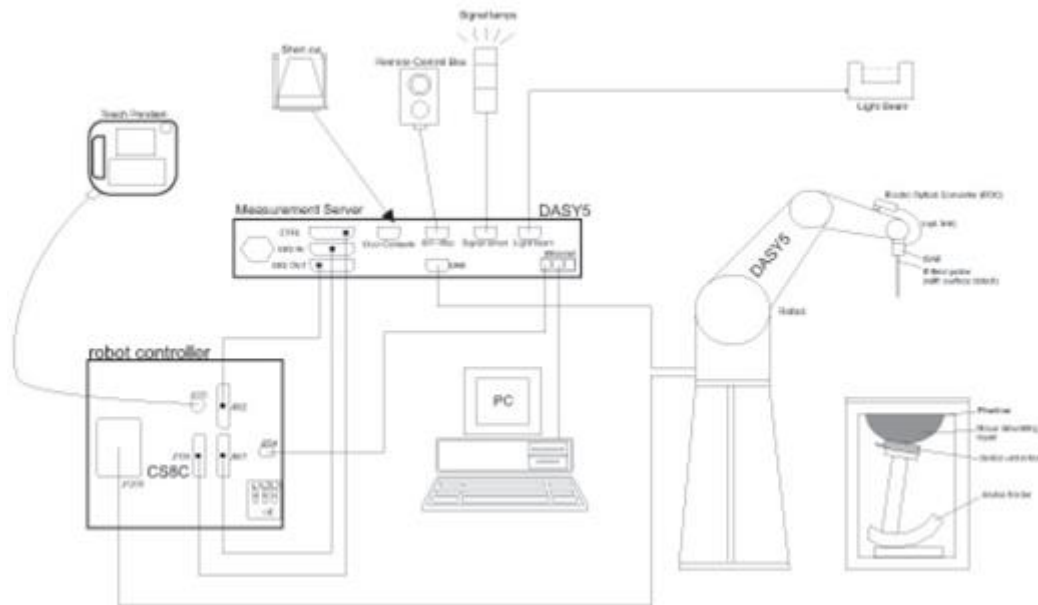

- A standard high precision 6-axis robot with controller, teach pendant and software. An arm extension for accommodating the data acquisition electronics (DAE).
- An isotropic Field probe optimized and calibrated for the targeted measurement.
- A data acquisition electronics (DAE) which performs the signal amplification, signal multiplexing, AD-conversion, offset measurements, mechanical surface detection, collision detection, etc. The unit is battery powered with standard or rechargeable batteries. The signal is optically transmitted to the EOC.
- The Electro-optical converter (EOC) performs the conversion from optical to electrical signals for the digital communication to the DAE. To use optical surface detection, a special version of the EOC is required. The EOC signal is transmitted to the measurement server.
- The function of the measurement server is to perform the time critical tasks such as signal filtering, control of the robot operation and fast movement interrupts.
- The Light Beam used is for probe alignment. This improves the (absolute) accuracy of the probe positioning.
- A computer running WinXP or Win7 and the DASY5 software.
- Remote control and teach pendant as well as additional circuitry for robot safety such as warning lamps, etc.
- The phantom, the device holder and other accessories according to the targeted measurement.

8.1 E-Field Probe

The SAR measurement is conducted with the dosimetric probe (manufactured by SPEAG). The probe is specially designed and calibrated for use in liquid with high permittivity. The dosimetric probe has special calibration in liquid at different frequency. This probe has a built in optical surface detection system to prevent from collision with phantom.

<ES3DV3 Probe>

Construction	Symmetric design with triangular core Interleaved sensors Built-in shielding against static charges PEEK enclosure material (resistant to organic solvents, e.g., DGBE)	
Frequency	10 MHz – 4 GHz; Linearity: ±0.2 dB (30 MHz – 4 GHz)	
Directivity	±0.2 dB in TSL (rotation around probe axis) ±0.3 dB in TSL (rotation normal to probe axis)	
Dynamic Range	5 µW/g – >100 mW/g; Linearity: ±0.2 dB	
Dimensions	Overall length: 337 mm (tip: 20 mm) Tip diameter: 3.9 mm (body: 12 mm) Distance from probe tip to dipole centers: 3.0 mm	

8.2 Data Acquisition Electronics (DAE)

The data acquisition electronics (DAE) consists of a highly sensitive electrometer-grade preamplifier with auto-zeroing, a channel and gain-switching multiplexer, a fast 16 bit AD-converter and a command decoder and control logic unit. Transmission to the measurement server is accomplished through an optical downlink for data and status information as well as an optical uplink for commands and the clock.

The input impedance of the DAE is 200 MOhm; the inputs are symmetrical and floating. Common mode rejection is above 80 dB.



Photo of DAE

8.3 Phantom

<SAM Twin Phantom>

Shell Thickness	2 ± 0.2 mm; Center ear point: 6 ± 0.2 mm	
Filling Volume	Approx. 25 liters	
Dimensions	Length: 1000 mm; Width: 500 mm; Height: adjustable feet	
Measurement Areas	Left Hand, Right Hand, Flat Phantom	

The bottom plate contains three pair of bolts for locking the device holder. The device holder positions are adjusted to the standard measurement positions in the three sections. A white cover is provided to tap the phantom during off-periods to prevent water evaporation and changes in the liquid parameters. On the phantom top, three reference markers are provided to identify the phantom position with respect to the robot.

<ELI Phantom>

Shell Thickness	2 ± 0.2 mm (sagging: <1%)	
Filling Volume	Approx. 30 liters	
Dimensions	Major ellipse axis: 600 mm Minor axis: 400 mm	

The ELI phantom is intended for compliance testing of handheld and body-mounted wireless devices in the frequency range of 30 MHz to 6 GHz. ELI4 is fully compatible with standard and all known tissue simulating liquids.

8.4 Device Holder

<Mounting Device for Hand-Held Transmitter>

In combination with the Twin SAM V5.0/V5.0c or ELI phantoms, the Mounting Device for Hand-Held Transmitters enables rotation of the mounted transmitter device to specified spherical coordinates. At the heads, the rotation axis is at the ear opening. Transmitter devices can be easily and accurately positioned according to IEC 62209-1, IEEE 1528, FCC, or other specifications. The device holder can be locked for positioning at different phantom sections (left head, right head, flat). And upgrade kit to Mounting Device to enable easy mounting of wider devices like big smart-phones, e-books, small tablets, etc. It holds devices with width up to 140 mm.



Mounting Device for Hand-Held Transmitters



Mounting Device Adaptor for Wide-Phones

<Mounting Device for Laptops and other Body-Worn Transmitters>

The extension is lightweight and made of POM, acrylic glass and foam. It fits easily on the upper part of the mounting device in place of the phone positioned. The extension is fully compatible with the SAM Twin and ELI phantoms.



Mounting Device for Laptops

9. Measurement Procedures

The measurement procedures are as follows:

<Conducted power measurement>

- (a) For WWAN power measurement, use base station simulator to configure EUT WWAN transmission in conducted connection with RF cable, at maximum power in each supported wireless interface and frequency band.
- (b) Read the WWAN RF power level from the base station simulator.
- (c) For WLAN/BT power measurement, use engineering software to configure EUT WLAN/BT continuously transmission, at maximum RF power in each supported wireless interface and frequency band
- (d) Connect EUT RF port through RF cable to the power meter, and measure WLAN/BT output power

<SAR measurement>

- (a) Use base station simulator to configure EUT WWAN transmission in radiated connection, and engineering software to configure EUT WLAN/BT continuously transmission, at maximum RF power, in the highest power channel.
- (b) Place the EUT in the positions as Appendix D demonstrates.
- (c) Set scan area, grid size and other setting on the DASY software.
- (d) Measure SAR results for the highest power channel on each testing position.
- (e) Find out the largest SAR result on these testing positions of each band
- (f) Measure SAR results for other channels in worst SAR testing position if the reported SAR of highest power channel is larger than 0.8 W/kg

According to the test standard, the recommended procedure for assessing the peak spatial-average SAR value consists of the following steps:

- (a) Power reference measurement
- (b) Area scan
- (c) Zoom scan
- (d) Power drift measurement

9.1 Spatial Peak SAR Evaluation

The procedure for spatial peak SAR evaluation has been implemented according to the test standard. It can be conducted for 1g and 10g, as well as for user-specific masses. The DASY software includes all numerical procedures necessary to evaluate the spatial peak SAR value.

The base for the evaluation is a "cube" measurement. The measured volume must include the 1g and 10g cubes with the highest averaged SAR values. For that purpose, the center of the measured volume is aligned to the interpolated peak SAR value of a previously performed area scan.

The entire evaluation of the spatial peak values is performed within the post-processing engine (SEMCAD). The system always gives the maximum values for the 1g and 10g cubes. The algorithm to find the cube with highest averaged SAR is divided into the following stages:

- (a) Extraction of the measured data (grid and values) from the Zoom Scan
- (b) Calculation of the SAR value at every measurement point based on all stored data (A/D values and measurement parameters)
- (c) Generation of a high-resolution mesh within the measured volume
- (d) Interpolation of all measured values from the measurement grid to the high-resolution grid
- (e) Extrapolation of the entire 3-D field distribution to the phantom surface over the distance from sensor to surface
- (f) Calculation of the averaged SAR within masses of 1g and 10g

9.2 Power Reference Measurement

The Power Reference Measurement and Power Drift Measurements are for monitoring the power drift of the device under test in the batch process. The minimum distance of probe sensors to surface determines the closest measurement point to phantom surface. This distance cannot be smaller than the distance of sensor calibration points to probe tip as defined in the probe properties.

9.3 Area Scan

The area scan is used as a fast scan in two dimensions to find the area of high field values, before doing a fine measurement around the hot spot. The sophisticated interpolation routines implemented in DASY software can find the maximum found in the scanned area, within a range of the global maximum. The range (in dB0 is specified in the standards for compliance testing. For example, a 2 dB range is required in IEEE standard 1528 and IEC 62209 standards, whereby 3 dB is a requirement when compliance is assessed in accordance with the ARIB standard (Japan), if only one zoom scan follows the area scan, then only the absolute maximum will be taken as reference. For cases where multiple maximums are detected, the number of zoom scans has to be increased accordingly.

Area scan parameters extracted from FCC KDB 865664 D01v01r04 SAR measurement 100 MHz to 6 GHz.

	≤ 3 GHz	> 3 GHz
Maximum distance from closest measurement point (geometric center of probe sensors) to phantom surface	5 ± 1 mm	$\frac{1}{2} \cdot \delta \cdot \ln(2) \pm 0.5$ mm
Maximum probe angle from probe axis to phantom surface normal at the measurement location	30° ± 1°	20° ± 1°
Maximum area scan spatial resolution: $\Delta x_{Area}, \Delta y_{Area}$	≤ 2 GHz: ≤ 15 mm 2 – 3 GHz: ≤ 12 mm	3 – 4 GHz: ≤ 12 mm 4 – 6 GHz: ≤ 10 mm
	When the x or y dimension of the test device, in the measurement plane orientation, is smaller than the above, the measurement resolution must be ≤ the corresponding x or y dimension of the test device with at least one measurement point on the test device.	

9.4 Zoom Scan

Zoom scans are used assess the peak spatial SAR values within a cubic averaging volume containing 1 gram and 10 gram of simulated tissue. The zoom scan measures points (refer to table below) within a cube shoes base faces are centered on the maxima found in a preceding area scan job within the same procedure. When the measurement is done, the zoom scan evaluates the averaged SAR for 1 gram and 10 gram and displays these values next to the job's label.

Zoom scan parameters extracted from FCC KDB 865664 D01v01r04 SAR measurement 100 MHz to 6 GHz.

		≤ 3 GHz	> 3 GHz	
Maximum zoom scan spatial resolution: $\Delta x_{Zoom}, \Delta y_{Zoom}$		≤ 2 GHz: ≤ 8 mm 2 – 3 GHz: ≤ 5 mm*	3 – 4 GHz: ≤ 5 mm* 4 – 6 GHz: ≤ 4 mm*	
Maximum zoom scan spatial resolution, normal to phantom surface	uniform grid: $\Delta z_{Zoom}(n)$	≤ 5 mm	3 – 4 GHz: ≤ 4 mm 4 – 5 GHz: ≤ 3 mm 5 – 6 GHz: ≤ 2 mm	
	graded grid	$\Delta z_{Zoom}(1)$: between 1 st two points closest to phantom surface	≤ 4 mm	3 – 4 GHz: ≤ 3 mm 4 – 5 GHz: ≤ 2.5 mm 5 – 6 GHz: ≤ 2 mm
		$\Delta z_{Zoom}(n>1)$: between subsequent points	$\leq 1.5 \cdot \Delta z_{Zoom}(n-1)$	
Minimum zoom scan volume	x, y, z	≥ 30 mm	3 – 4 GHz: ≥ 28 mm 4 – 5 GHz: ≥ 25 mm 5 – 6 GHz: ≥ 22 mm	
Note: δ is the penetration depth of a plane-wave at normal incidence to the tissue medium; see draft standard IEEE P1528-2011 for details. * When zoom scan is required and the <i>reported</i> SAR from the <i>area scan based 1-g SAR estimation</i> procedures of KDB 447498 is ≤ 1.4 W/kg, ≤ 8 mm, ≤ 7 mm and ≤ 5 mm zoom scan resolution may be applied, respectively, for 2 GHz to 3 GHz, 3 GHz to 4 GHz and 4 GHz to 6 GHz.				

9.5 Volume Scan Procedures

The volume scan is used for assess overlapping SAR distributions for antennas transmitting in different frequency bands. It is equivalent to an oversized zoom scan used in standalone measurements. The measurement volume will be used to enclose all the simultaneous transmitting antennas. For antennas transmitting simultaneously in different frequency bands, the volume scan is measured separately in each frequency band. In order to sum correctly to compute the 1g aggregate SAR, the EUT remain in the same test position for all measurements and all volume scan use the same spatial resolution and grid spacing. When all volume scan were completed, the software, SEMCAD postprocessor can combine and subsequently superpose these measurement data to calculating the multiband SAR.

9.6 Power Drift Monitoring

All SAR testing is under the EUT install full charged battery and transmit maximum output power. In DASy measurement software, the power reference measurement and power drift measurement procedures are used for monitoring the power drift of EUT during SAR test. Both these procedures measure the field at a specified reference position before and after the SAR testing. The software will calculate the field difference in dB. If the power drifts more than 5%, the SAR will be retested.



10. Test Equipment List

Manufacturer	Name of Equipment	Type/Model	Serial Number	Calibration	
				Last Cal.	Due Date
SPEAG	1750MHz System Validation Kit	D1750V2	1090	2019/3/27	2022/3/26
SPEAG	1900MHz System Validation Kit	D1900V2	5d170	2019/3/26	2022/3/25
SPEAG	2450MHz System Validation Kit	D2450V2	908	2019/3/25	2022/3/24
SPEAG	2600MHz System Validation Kit	D2600V2	1061	2018/12/7	2021/12/6
SPEAG	Data Acquisition Electronics	DAE4	1338	2019/11/20	2020/11/19
SPEAG	Dosimetric E-Field Probe	ES3DV3	3166	2020/3/2	2021/3/1
SPEAG	SAM Twin Phantom	QD 000 P40 CB	TP-1753	NCR	NCR
SPEAG	Phone Positioner	N/A	N/A	NCR	NCR
Anritsu	Radio Communication Analyzer	MT8821C	6201432831	2020/4/16	2021/4/15
Agilent	Wireless Communication Test Set	E5515C	MY52102706	2020/4/16	2021/4/15
Agilent	ENA Series Network Analyzer	E5071C	MY46111157	2020/4/16	2021/4/15
SPEAG	Dielectric Probe Kit	DAK-3.5	1071	2019/10/28	2020/10/27
Anritsu	Vector Signal Generator	MG3710A	6201682672	2020/1/8	2021/1/7
Rohde & Schwarz	Power Meter	NRVD	102081	2019/8/15	2020/8/14
Rohde & Schwarz	Power Sensor	NRV-Z5	100538	2019/8/14	2020/8/13
Rohde & Schwarz	Power Sensor	NRV-Z5	100539	2019/8/14	2020/8/13
Testo	Hygrometer	608-H1	1241332088	2020/1/8	2021/1/7
FLUKE	DIGITAC THERMOMETER	51II	97240029	2019/8/15	2020/8/14
R&S	CBT BLUETOOTH TESTER	CBT	101641	2020/1/8	2021/1/7
EXA	Spectrum Analyzer	FSV7	101631	2020/1/8	2021/1/7
BONN	POWER AMPLIFIER	BLMA 0830-3	087193A	Note 1	
BONN	POWER AMPLIFIER	BLMA 2060-2	087193B	Note 1	
ARRA	Power Divider	A3200-2	N/A	Note 1	
MCL	Attenuation1	BW-S10W5+	N/A	Note 1	
MCL	Attenuation2	BW-S10W5+	N/A	Note 1	
MCL	Attenuation3	BW-S10W5+	N/A	Note 1	
Agilent	Dual Directional Coupler	778D	20500	Note 1	
Agilent	Dual Directional Coupler	11691D	MY48151020	Note 1	

General Note:

1. Prior to system verification and validation, the path loss from the signal generator to the system check source and the power meter, which includes the amplifier, cable, attenuator and directional coupler, was measured by the network analyzer. The reading of the power meter was offset by the path loss difference between the path to the power meter and the path to the system check source to monitor the actual power level fed to the system check
2. Referring to KDB 865664 D01v01r04, the dipole calibration interval can be extended to 3 years with justification. The dipoles are also not physically damaged, or repaired during the interval.
3. The justification data of dipole can be found in appendix C. The return loss is < -20dB, within 20% of prior calibration, the impedance is within 5 ohm of prior calibration.

11. System Verification

11.1 Tissue Simulating Liquids

For the measurement of the field distribution inside the SAM phantom with DASY, the phantom must be filled with around 25 liters of homogeneous body tissue simulating liquid. For head SAR testing, the liquid height from the ear reference point (ERP) of the phantom to the liquid top surface is larger than 15 cm, which is shown in Fig. 10.1. For body SAR testing, the liquid height from the center of the flat phantom to the liquid top surface is larger than 15 cm, which is shown in Fig. 10.2.

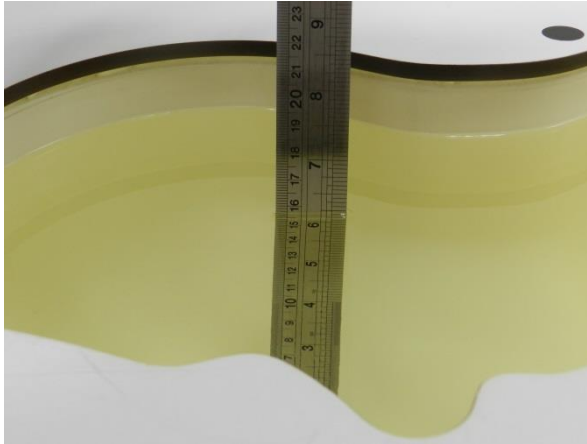

Fig 11.1Photo of Liquid Height for Head SAR

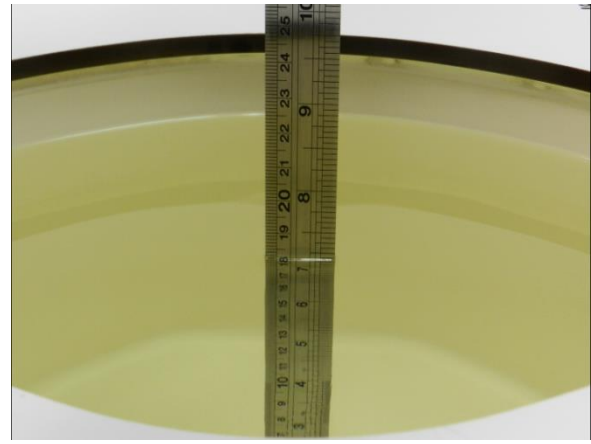

Fig 11.2 Photo of Liquid Height for Body SAR



11.2 Tissue Verification

The following tissue formulations are provided for reference only as some of the parameters have not been thoroughly verified. The composition of ingredients may be modified accordingly to achieve the desired target tissue parameters required for routine SAR evaluation.

Frequency (MHz)	Water (%)	Sugar (%)	Cellulose (%)	Salt (%)	Preventol (%)	DGBE (%)	Conductivity (σ)	Permittivity (ϵ_r)
1800, 1900, 2000	55.2	0	0	0.3	0	44.5	1.40	40.0
2450	55.0	0	0	0	0	45.0	1.80	39.2
2600	54.8	0	0	0.1	0	45.1	1.96	39.0

<Tissue Dielectric Parameter Check Results>

Frequency (MHz)	Tissue Type	Liquid Temp. (°C)	Conductivity (σ)	Permittivity (ϵ_r)	Conductivity Target (σ)	Permittivity Target (ϵ_r)	Delta (σ) (%)	Delta (ϵ_r) (%)	Limit (%)	Date
1750	Head	22.7	1.351	40.380	1.37	40.10	-1.39	0.70	±5	2020/5/29
1900	Head	22.8	1.451	39.630	1.40	40.00	3.64	-0.92	±5	2020/5/30
2450	Head	22.9	1.853	39.080	1.80	39.20	2.94	-0.31	±5	2020/6/11
2600	Head	22.6	1.978	39.041	1.96	39.00	0.92	0.11	±5	2020/5/31

11.3 System Performance Check Results

Comparing to the original SAR value provided by SPEAG, the verification data should be within its specification of 10 %. Below table shows the target SAR and measured SAR after normalized to 1W input power. The table below indicates the system performance check can meet the variation criterion and the plots can be referred to Appendix A of this report.

<1g SAR>

Date	Frequency (MHz)	Tissue Type	Input Power (mW)	Dipole S/N	Probe S/N	DAE S/N	Measured 1g SAR (W/kg)	Targeted 1g SAR (W/kg)	Normalized 1g SAR (W/kg)	Deviation (%)
2020/5/29	1750	Head	250	1090	3166	1338	9.27	36.40	37.08	1.87
2020/5/30	1900	Head	250	5d170	3166	1338	10.00	39.00	40	2.56
2020/6/11	2450	Head	250	908	3166	1338	13.20	52.80	52.8	0.00
2020/5/31	2600	Head	250	1061	3166	1338	15.40	57.70	61.6	6.76

<10g SAR>

Date	Frequency (MHz)	Tissue Type	Input Power (mW)	Dipole S/N	Probe S/N	DAE S/N	Measured 10g SAR (W/kg)	Targeted 10g SAR (W/kg)	Normalized 10g SAR (W/kg)	Deviation (%)
2020/5/29	1750	Head	250	1090	3166	1338	4.88	19.20	19.52	1.67
2020/5/30	1900	Head	250	5d170	3166	1338	5.20	20.30	20.8	2.46
2020/6/11	2450	Head	250	908	3166	1338	5.99	24.20	23.96	-0.99
2020/5/31	2600	Head	250	1061	3166	1338	6.68	25.90	26.72	3.17

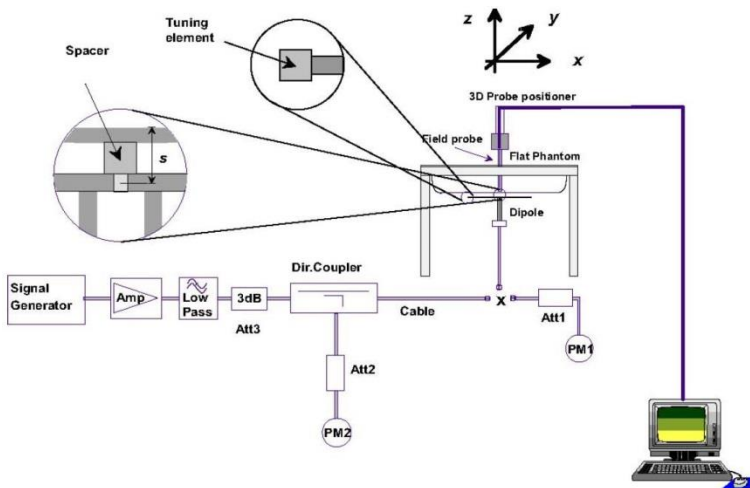

Fig 8.3.1 System Performance Check Setup



Fig 8.3.2 Setup Photo

12. RF Exposure Positions

12.1 Ear and handset reference point

Figure 9.1.1 shows the front, back, and side views of the SAM phantom. The center-of-mouth reference point is labeled “M,” the left ear reference point (ERP) is marked “LE,” and the right ERP is marked “RE.” Each ERP is 15 mm along the B-M (back-mouth) line behind the entrance-to-ear-canal (EEC) point, as shown in Figure 9.1.2 The Reference Plane is defined as passing through the two ear reference points and point M. The line N-F (neck-front), also called the reference pivoting line, is normal to the Reference Plane and perpendicular to both a line passing through RE and LE and the B-M line (see Figure 9.1.3). Both N-F and B-M lines should be marked on the exterior of the phantom shell to facilitate handset positioning. Posterior to the N-F line the ear shape is a flat surface with 6 mm thickness at each ERP, and forward of the N-F line the ear is truncated, as illustrated in Figure 9.1.2. The ear truncation is introduced to preclude the ear lobe from interfering with handset tilt, which could lead to unstable positioning at the cheek.

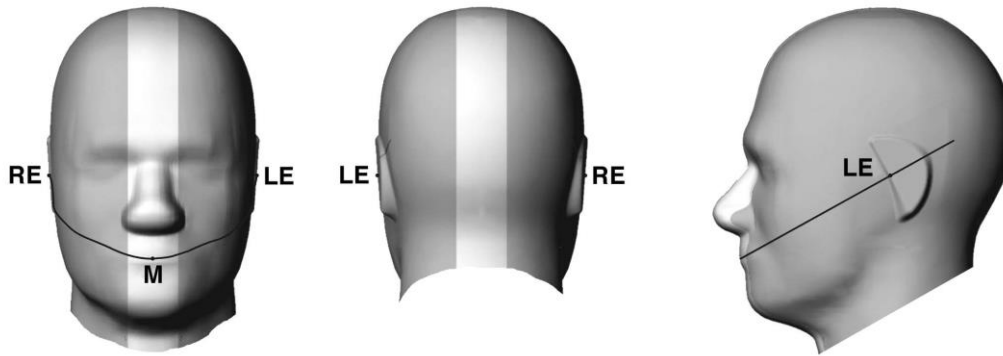

Fig 9.1.1 Front, back, and side views of SAM twin phantom

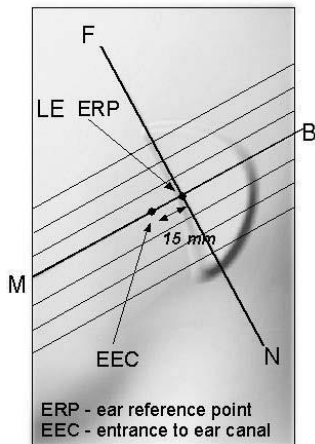

Fig 9.1.2 Close-up side view of phantom showing the ear region.

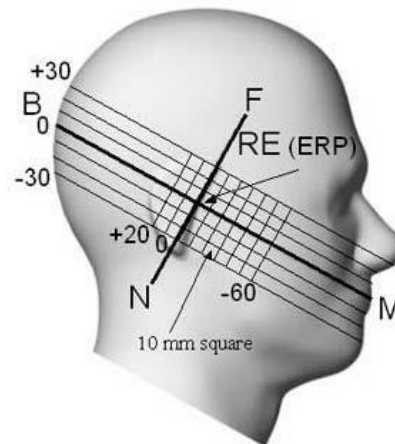

Fig 9.1.3 Side view of the phantom showing relevant markings and seven cross-sectional plane locations

12.2 Definition of the cheek position

1. Ready the handset for talk operation, if necessary. For example, for handsets with a cover piece (flip cover), open the cover. If the handset can transmit with the cover closed, both configurations must be tested.
2. Define two imaginary lines on the handset—the vertical centerline and the horizontal line. The vertical centerline passes through two points on the front side of the handset—the midpoint of the width w_t of the handset at the level of the acoustic output (point A in Figure 9.2.1 and Figure 9.2.2), and the midpoint of the width w_b of the bottom of the handset (point B). The horizontal line is perpendicular to the vertical centerline and passes through the center of the acoustic output (see Figure 9.2.1). The two lines intersect at point A. Note that for many handsets, point A coincides with the center of the acoustic output; however, the acoustic output may be located elsewhere on the horizontal line. Also note that the vertical centerline is not necessarily parallel to the front face of the handset (see Figure 9.2.2), especially for clamshell handsets, handsets with flip covers, and other irregularly-shaped handsets.
3. Position the handset close to the surface of the phantom such that point A is on the (virtual) extension of the line passing through points RE and LE on the phantom (see Figure 9.2.3), such that the plane defined by the vertical centerline and the horizontal line of the handset is approximately parallel to the sagittal plane of the phantom.
4. Translate the handset towards the phantom along the line passing through RE and LE until handset point A touches the pinna at the ERP.
5. While maintaining the handset in this plane, rotate it around the LE-RE line until the vertical centerline is in the plane normal to the plane containing B-M and N-F lines, i.e., the Reference Plane.
6. Rotate the handset around the vertical centerline until the handset (horizontal line) is parallel to the N-F line.
7. While maintaining the vertical centerline in the Reference Plane, keeping point A on the line passing through RE and LE, and maintaining the handset contact with the pinna, rotate the handset about the N-F line until any point on the handset is in contact with a phantom point below the pinna on the cheek. See Figure 9.2.3. The actual rotation angles should be documented in the test report.

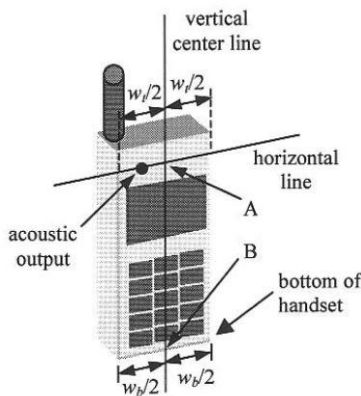

Fig 9.2.1 Handset vertical and horizontal reference lines—"fixed case"

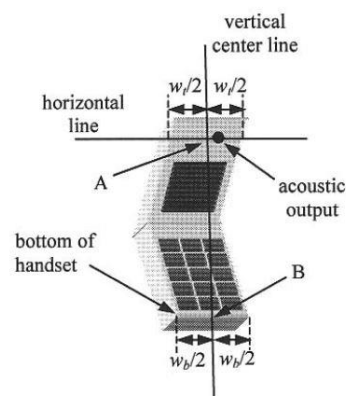

Fig 9.2.2 Handset vertical and horizontal reference lines—"clam-shell case"

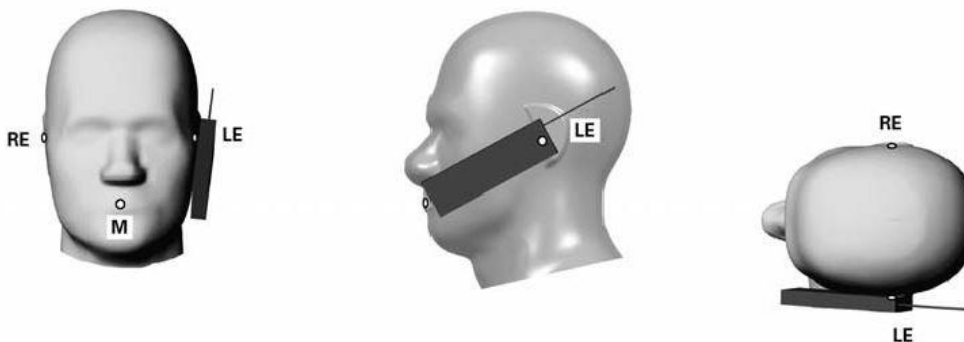

Fig 9.2.3 cheek or touch position. The reference points for the right ear (RE), left ear (LE), and mouth (M), which establish the Reference Plane for handset positioning, are indicated.

12.3 Definition of the tilt position

1. Ready the handset for talk operation, if necessary. For example, for handsets with a cover piece (flip cover), open the cover. If the handset can transmit with the cover closed, both configurations must be tested.
2. While maintaining the orientation of the handset, move the handset away from the pinna along the line passing through RE and LE far enough to allow a rotation of the handset away from the cheek by 15°.
3. Rotate the handset around the horizontal line by 15°.
4. While maintaining the orientation of the handset, move the handset towards the phantom on the line passing through RE and LE until any part of the handset touches the ear. The tilt position is obtained when the contact point is on the pinna. See Figure 9.3.1. If contact occurs at any location other than the pinna, e.g., the antenna at the back of the phantom head, the angle of the handset should be reduced. In this case, the tilt position is obtained if any point on the handset is in contact with the pinna and a second point

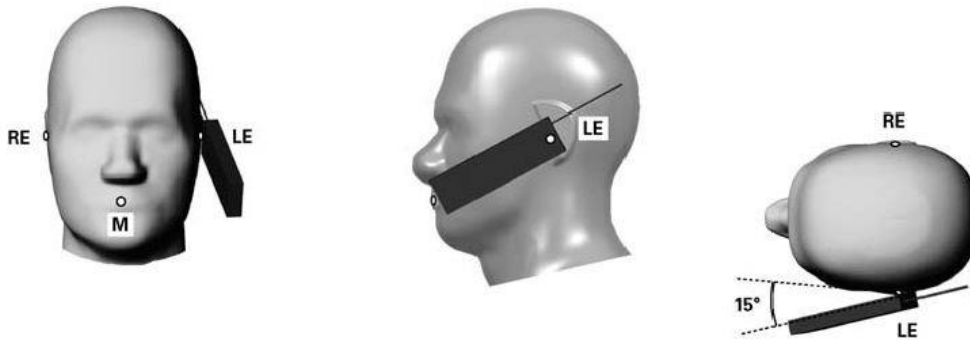

Fig 9.3.1 Tilt position. The reference points for the right ear (RE), left ear (LE), and mouth (M), which define the Reference Plane for handset positioning, are indicated.

12.4 Body Worn Accessory

Body-worn operating configurations are tested with the belt-clips and holsters attached to the device and positioned against a flat phantom in a normal use configuration (see Figure 9.4). Per KDB648474 D04v01r03, body-worn accessory exposure is typically related to voice mode operations when handsets are carried in body-worn accessories. The body-worn accessory procedures in FCC KDB 447498 D01v06 should be used to test for body-worn accessory SAR compliance, without a headset connected to it. This enables the test results for such configuration to be compatible with that required for hotspot mode when the body-worn accessory test separation distance is greater than or equal to that required for hotspot mode, when applicable. When the reported SAR for body-worn accessory, measured without a headset connected to the handset is $> 1.2 \text{ W/kg}$, the highest reported SAR configuration for that wireless mode and frequency band should be repeated for that body-worn accessory with a handset attached to the handset.

Accessories for body-worn operation configurations are divided into two categories: those that do not contain metallic components and those that do contain metallic components. When multiple accessories that do not contain metallic components are supplied with the device, the device is tested with only the accessory that dictates the closest spacing to the body. Then multiple accessories that contain metallic components are tested with the device with each accessory. If multiple accessories share an identical metallic component (i.e. the same metallic belt-chip used with different holsters with no other metallic components) only the accessory that dictates the closest spacing to the body is tested.

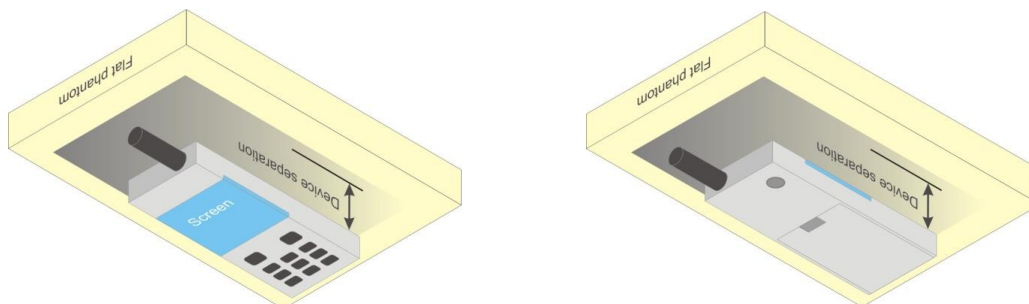

Fig 9.4 Body Worn Position



12.5 Product Specific Exposure

For smart phones with a display diagonal dimension > 15.0 cm or an overall diagonal dimension > 16.0 cm that provide similar mobile web access and multimedia support found in mini-tablets or UMPC mini-tablets that support voice calls next to the ear, According to KDB648474 D04v01r03, the following phablet procedures should be applied to evaluate SAR compliance for each applicable wireless modes and frequency band. Devices marketed as phablets, regardless of form factors and operating characteristics must be tested as a phablet to determine SAR compliance

1. The normally required head and body-worn accessory SAR test procedures for handsets, including hotspot mode, must be applied.
2. The UMPC mini-tablet procedures must also be applied to test the SAR of all surfaces and edges with an antenna located at ≤ 25 mm from that surface or edge, in direct contact with a flat phantom, for 10-g extremity SAR according to the body-equivalent tissue dielectric parameters in KDB 865664 to address interactive hand use exposure conditions.6 The UMPC mini-tablet 1-g SAR at 5 mm is not required. When hotspot mode applies, 10-g extremity SAR is required only for the surfaces and edges with hotspot mode 1-g reported SAR > 1.2 W/kg.

12.6 Wireless Router

Some battery-operated handsets have the capability to transmit and receive user through simultaneous transmission of WIFI simultaneously with a separate licensed transmitter. The FCC has provided guidance in FCC KDB Publication 941225 D06 v02r01 where SAR test considerations for handsets ($L \times W \geq 9$ cm x 5 cm) are based on a composite test separation distance of 10mm from the front, back and edges of the device containing transmitting antennas within 2.5cm of their edges, determined from general mixed use conditions for this type of devices. Since the hotspot SAR results may overlap with the body-worn accessory SAR requirements, the more conservative configurations can be considered, thus excluding some body-worn accessory SAR tests.

When the user enables the personal wireless router functions for the handset, actual operations include simultaneous transmission of both the WIFI transmitter and another licensed transmitter. Both transmitters often do not transmit at the same transmitting frequency and thus cannot be evaluated for SAR under actual use conditions due to the limitations of the SAR assessment probes. Therefore, SAR must be evaluated for each frequency transmission and mode separately and spatially summed with the WIFI transmitter according to FCC KDB Publication 447498 D01v06 publication procedures. The "Portable Hotspot" feature on the handset was NOT activated during SAR assessments, to ensure the SAR measurements were evaluated for a single transmission frequency RF signal at a time.



13. GSM/UMTS/LTE Output Power (Unit: dBm)

The detailed conducted power table can refer to Appendix E.

<GSM Conducted Power>

1. Per KDB 447498 D01v06, the maximum output power channel is used for SAR testing and for further SAR test reduction.
2. Per KDB 941225 D01v03r01, for SAR test reduction for GSM / GPRS / EDGE modes is determined by the source-based time-averaged output power including tune-up tolerance. The mode with highest specified time-averaged output power should be tested for SAR compliance in the applicable exposure conditions. For modes with the same specified maximum output power and tolerance, the higher number time-slot configuration should be tested. Therefore, the GPRS (4Tx slots) for GSM850/GSM1900 is considered as the primary mode.
3. Other configurations of GSM / GPRS / EDGE are considered as secondary modes. The 3G SAR test reduction procedure is applied, when the maximum output power and tune-up tolerance specified for production units in a secondary mode is $\leq \frac{1}{4}$ dB higher than the primary mode, SAR measurement is not required for the secondary mode
4. Power reduction which is implemented in GSM850/GSM1900 band, for SAR testing EUT was set in reduced power mode and GPRS 4Tx slot due to its highest frame-average power.

<WCDMA Conducted Power>

1. The following tests were conducted according to the test requirements outlines in 3GPP TS 34.121 specification.
2. The procedures in KDB 941225 D01v03r01 are applied for 3GPP Rel. 6 HSPA to configure the device in the required sub-test mode(s) to determine SAR test exclusion.
3. For DC-HSDPA, the device was configured according to the H-Set 12, Fixed Reference Channel (FRC) configuration in Table C.8.1.12 of 3GPP TS 34.121-1, with the primary and the secondary serving HS-DSCH Cell enabled during the power measurement.

A summary of these settings are illustrated below:

HSDPA Setup Configuration:

- a. The EUT was connected to Base Station Agilent E5515C referred to the Setup Configuration.
- b. The RF path losses were compensated into the measurements.
- c. A call was established between EUT and Base Station with following setting:
 - i. Set Gain Factors (β_c and β_d) and parameters were set according to each
 - ii. Specific sub-test in the following table, C10.1.4, quoted from the TS 34.121
 - iii. Set RMC 12.2Kbps + HSDPA mode.
 - iv. Set Cell Power = -86 dBm
 - v. Set HS-DSCH Configuration Type to FRC (H-set 1, QPSK)
 - vi. Select HSDPA Uplink Parameters
 - vii. Set Delta ACK, Delta NACK and Delta CQI = 8
 - viii. Set Ack-Nack Repetition Factor to 3
 - ix. Set CQI Feedback Cycle (k) to 4 ms
 - x. Set CQI Repetition Factor to 2
 - xi. Power Ctrl Mode = All Up bits
- d. The transmitted maximum output power was recorded.

Table C.10.1.4: β values for transmitter characteristics tests with HS-DPCCH

Sub-test	β_c	β_d	β_d (SF)	β_c/β_d	β_{HS} (Note 1, Note 2)	CM (dB) (Note 3)	MPR (dB) (Note 3)
1	2/15	15/15	64	2/15	4/15	0.0	0.0
2	12/15 (Note 4)	15/15 (Note 4)	64	12/15 (Note 4)	24/15	1.0	0.0
3	15/15	8/15	64	15/8	30/15	1.5	0.5
4	15/15	4/15	64	15/4	30/15	1.5	0.5

Note 1: Δ_{ACK} , Δ_{NACK} and $\Delta_{CQI} = 30/15$ with $\beta_{HS} = 30/15 * \beta_c$.

Note 2: For the HS-DPCCH power mask requirement test in clause 5.2C, 5.7A, and the Error Vector Magnitude (EVM) with HS-DPCCH test in clause 5.13.1A, and HSDPA EVM with phase discontinuity in clause 5.13.1AA, Δ_{ACK} and $\Delta_{NACK} = 30/15$ with $\beta_{HS} = 30/15 * \beta_c$, and $\Delta_{CQI} = 24/15$ with $\beta_{HS} = 24/15 * \beta_c$.

Note 3: CM = 1 for $\beta_c/\beta_d = 12/15$, $\beta_{HS}/\beta_c = 24/15$. For all other combinations of DPDCH, DPCCH and HS-DPCCH the MPR is based on the relative CM difference. This is applicable for only UEs that support HSDPA in release 6 and later releases.

Note 4: For subtest 2 the β_c/β_d ratio of 12/15 for the TFC during the measurement period (TF1, TF0) is achieved by setting the signalled gain factors for the reference TFC (TF1, TF1) to $\beta_c = 11/15$ and $\beta_d = 15/15$.

Setup Configuration

HSUPA Setup Configuration:

- a. The EUT was connected to Base Station Agilent E5515C referred to the Setup Configuration.
- b. The RF path losses were compensated into the measurements.
- c. A call was established between EUT and Base Station with following setting * :
 - i. Call Configs = 5.2B, 5.9B, 5.10B, and 5.13.2B with QPSK
 - ii. Set the Gain Factors (β_c and β_d) and parameters (AG Index) were set according to each specific sub-test in the following table, C11.1.3, quoted from the TS 34.121
 - iii. Set Cell Power = -86 dBm
 - iv. Set Channel Type = 12.2k + HSPA
 - v. Set UE Target Power
 - vi. Power Ctrl Mode= Alternating bits
 - vii. Set and observe the E-TFCl
 - viii. Confirm that E-TFCl is equal to the target E-TFCl of 75 for sub-test 1, and other subtest's E-TFCl
- d. The transmitted maximum output power was recorded.

Table C.11.1.3: β values for transmitter characteristics tests with HS-DPCCH and E-DCH

Sub-test	β_c	β_d	β_d (SF)	β_c/β_d	β_{HS} (Note1)	β_{ec}	β_{ed} (Note 4) (Note 5)	β_{ed} (SF)	β_{ed} (Codes)	CM (dB) (Note 2)	MPR (dB) (Note 2) (Note 6)	AG Index (Note 5)	E-TFCl
1	11/15 (Note 3)	15/15 (Note 3)	64	11/15 (Note 3)	22/15	209/25	1309/225	4	1	1.0	0.0	20	75
2	6/15	15/15	64	6/15	12/15	12/15	94/75	4	1	3.0	2.0	12	67
3	15/15	9/15	64	15/9	30/15	30/15	$\beta_{ed1}: 47/15$ $\beta_{ed2}: 47/15$	4 4	2	2.0	1.0	15	92
4	2/15	15/15	64	2/15	4/15	2/15	56/75	4	1	3.0	2.0	17	71
5	15/15	0	-	-	5/15	5/15	47/15	4	1	1.0	0.0	12	67

Note 1: For sub-test 1 to 4, Δ_{ACK} , Δ_{NACK} and $\Delta_{CQI} = 30/15$ with $\beta_{hs} = 30/15 * \beta_c$. For sub-test 5, Δ_{ACK} , Δ_{NACK} and $\Delta_{CQI} = 5/15$ with $\beta_{hs} = 5/15 * \beta_c$.

Note 2: CM = 1 for $\beta_c/\beta_d = 12/15$, $\beta_{hs}/\beta_c = 24/15$. For all other combinations of DPDCH, DPCCH, HS-DPCCH, E-DPDCH and E-DPCCH the MPR is based on the relative CM difference.

Note 3: For subtest 1 the β_c/β_d ratio of 11/15 for the TFC during the measurement period (TF1, TF0) is achieved by setting the signalled gain factors for the reference TFC (TF1, TF1) to $\beta_c = 10/15$ and $\beta_d = 15/15$.

Note 4: In case of testing by UE using E-DPDCH Physical Layer category 1, Sub-test 3 is omitted according to TS25.306 Table 5.1g.

Note 5: β_{ed} can not be set directly; it is set by Absolute Grant Value.

Note 6: For subtests 2, 3 and 4, UE may perform E-DPDCH power scaling at max power which could results in slightly smaller MPR values.

Setup Configuration

DC-HSDPA 3GPP release 8 Setup Configuration:

- a. The EUT was connected to Base Station Agilent E5515C referred to the Setup Configuration below
- b. The RF path losses were compensated into the measurements.
- c. A call was established between EUT and Base Station with following setting:
 - i. Set RMC 12.2Kbps + HSDPA mode.
 - ii. Set Cell Power = -25 dBm
 - iii. Set HS-DSCH Configuration Type to FRC (H-set 12, QPSK)
 - iv. Select HSDPA Uplink Parameters
 - v. Set Gain Factors (β_c and β_d) and parameters were set according to each Specific sub-test in the following table, C10.1.4, quoted from the TS 34.121
 - a). Subtest 1: $\beta_c/\beta_d=2/15$
 - b). Subtest 2: $\beta_c/\beta_d=12/15$
 - c). Subtest 3: $\beta_c/\beta_d=15/8$
 - d). Subtest 4: $\beta_c/\beta_d=15/4$
 - vi. Set Delta ACK, Delta NACK and Delta CQI = 8
 - vii. Set Ack-Nack Repetition Factor to 3
 - viii. Set CQI Feedback Cycle (k) to 4 ms
 - ix. Set CQI Repetition Factor to 2
 - x. Power Ctrl Mode = All Up bits
- d. The transmitted maximum output power was recorded.

The following tests were conducted according to the test requirements outlines in 3GPP TS 34.121 specification. A summary of these settings are illustrated below:

C.8.1.12 Fixed Reference Channel Definition H-Set 12

Table C.8.1.12: Fixed Reference Channel H-Set 12

Parameter	Unit	Value
Nominal Avg. Inf. Bit Rate	kbps	60
Inter-TTI Distance	TTI's	1
Number of HARQ Processes	Processes	6
Information Bit Payload (N_{INF})	Bits	120
Number Code Blocks	Blocks	1
Binary Channel Bits Per TTI	Bits	960
Total Available SML's in UE	SML's	19200
Number of SML's per HARQ Proc.	SML's	3200
Coding Rate		0.15
Number of Physical Channel Codes	Codes	1
Modulation		QPSK
Note 1: The RMC is intended to be used for DC-HSDPA mode and both cells shall transmit with identical parameters as listed in the table. Note 2: Maximum number of transmission is limited to 1, i.e., retransmission is not allowed. The redundancy and constellation version 0 shall be used.		

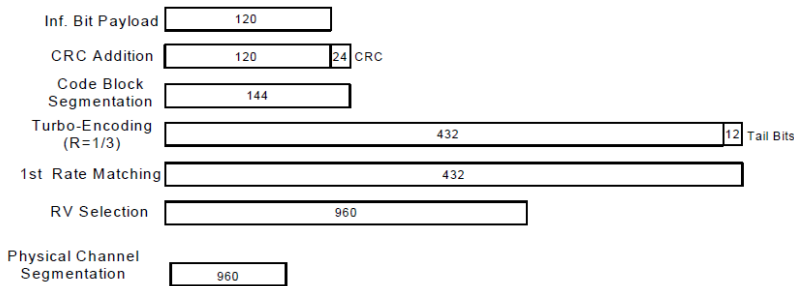

Figure C.8.19: Coding rate for Fixed reference Channel H-Set 12 (QPSK)

Setup Configuration

**<WCDMA Conducted Power>****General Note:**

1. Per KDB 941225 D01v03r01, for SAR testing is measured using a 12.2 kbps RMC with TPC bits configured to all "1's".
2. Per KDB 941225 D01v03r01, RMC 12.2kbps setting is used to evaluate SAR. The maximum output power and tune-up tolerance specified for production units in HSDPA / HSUPA / DC-HSDPA is $\leq \frac{1}{4}$ dB higher than RMC 12.2Kbps or when the highest reported SAR of the RMC12.2Kbps is scaled by the ratio of specified maximum output power and tune-up tolerance of HSDPA / HSUPA / DC-HSDPA to RMC12.2Kbps and the adjusted SAR is ≤ 1.2 W/kg, SAR measurement is not required for HSDPA / HSUPA / DC-HSDPA, and according to the following RF output power, the output power results of the secondary modes (HSUPA, HSDPA, DC-HSDPA) are less than $\frac{1}{4}$ dB higher than the primary modes; therefore, SAR measurement is not required for HSDPA / HSUPA / DC-HSDPA.

<LTE Conducted Power>

General Note:

1. Anritsu MT8820C base station simulator was used to setup the connection with EUT; the frequency band, channel bandwidth, RB allocation configuration, modulation type are set in the base station simulator to configure EUT transmitting at maximum power and at different configurations which are requested to be reported to FCC, for conducted power measurement and SAR testing.
2. Per KDB 941225 D05v02r05, when a properly configured base station simulator is used for the SAR and power measurements, spectrum plots for each RB allocation and offset configuration is not required.
3. Per KDB 941225 D05v02r05, start with the largest channel bandwidth and measure SAR for QPSK with 1 RB allocation, using the RB offset and required test channel combination with the highest maximum output power for RB offsets at the upper edge, middle and lower edge of each required test channel.
4. Per KDB 941225 D05v02r05, 50% RB allocation for QPSK SAR testing follows 1RB QPSK allocation procedure.
5. Per KDB 941225 D05v02r05, For QPSK with 100% RB allocation, SAR is not required when the highest maximum output power for 100 % RB allocation is less than the highest maximum output power in 50% and 1 RB allocations and the highest reported SAR for 1 RB and 50% RB allocation are ≤ 0.8 W/kg. Otherwise, SAR is measured for the highest output power channel; and if the reported SAR is > 1.45 W/kg, the remaining required test channels must also be tested.
6. Per KDB 941225 D05v02r05, 16QAM output power for each RB allocation configuration is $>$ not $\frac{1}{2}$ dB higher than the same configuration in QPSK and the reported SAR for the QPSK configuration is ≤ 1.45 W/kg; Per KDB 941225 D05v02r05, 16QAM SAR testing is not required.
7. Per KDB 941225 D05v02r05, Smaller bandwidth output power for each RB allocation configuration is $>$ not $\frac{1}{2}$ dB higher than the same configuration in the largest supported bandwidth, and the reported SAR for the largest supported bandwidth is ≤ 1.45 W/kg; Per KDB 941225 D05v02r05, smaller bandwidth SAR testing is not required.
8. For LTE B4 the maximum bandwidth does not support three non-overlapping channels, per KDB 941225 D05v02r05, when a device supports overlapping channel assignment in a channel bandwidth configuration, the middle channel of the group of overlapping channels should be selected for testing.
9. LTE band 4 SAR test was covered by Band 66; according to April 2015 TCB workshop, SAR test for overlapping LTE bands can be reduced if
 - a. the maximum output power, including tolerance, for the smaller band is \leq the larger band to qualify for the SAR test exclusion
 - b. the channel bandwidth and other operating parameters for the smaller band are fully supported by the larger band
10. According to 2017 TCB workshop, for 64 QAM and 16 QAM should be verified by checking the signal constellation with a call box to avoid incorrect maximum power levels due to MPR and other requirements associated with signal modulation, and the following figure is taken from the "Fundamental Measurement >> Modulation Analysis >> constellation" mode of the device connect to the MT8821C base station, therefore, the device 64QAM and 16QAM signal modulation are correct.

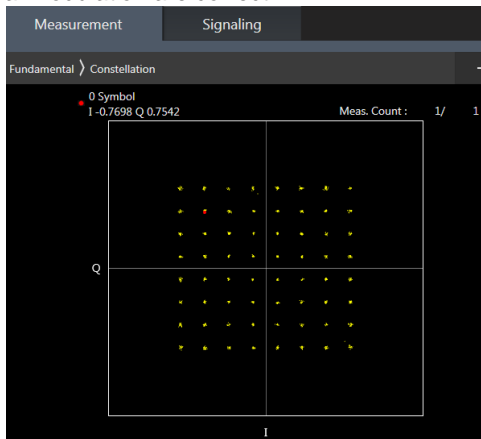

64QAM

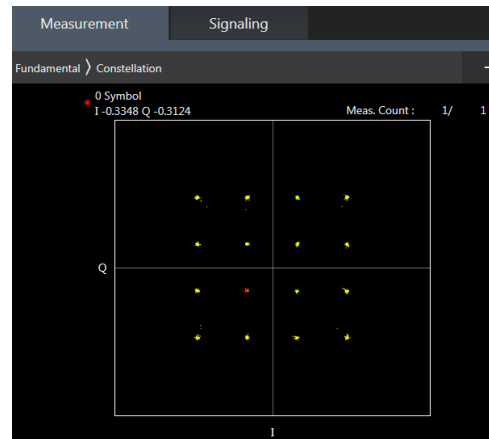

16QAM



14. Antenna Location

Detail antenna location refer to appendix D

15. SAR Test Results

General Note:

1. Per KDB 447498 D01v06, the reported SAR is the measured SAR value adjusted for maximum tune-up tolerance.
 - a. Tune-up scaling Factor = tune-up limit power (mW) / EUT RF power (mW), where tune-up limit is the maximum rated power among all production units.
 - b. For SAR testing of WLAN signal with non-100% duty cycle, the measured SAR is scaled-up by the duty cycle scaling factor which is equal to "1/(duty cycle)"
 - c. For WWAN: Reported SAR(W/kg)= Measured SAR(W/kg)*Tune-up Scaling Factor
 - d. For WLAN/Bluetooth: Reported SAR(W/kg)= Measured SAR(W/kg)* Duty Cycle scaling factor * Tune-up scaling factor
2. Per KDB 447498 D01v06, for each exposure position, testing of other required channels within the operating mode of a frequency band is not required when the *reported* 1-g or 10-g SAR for the mid-band or highest output power channel is:
 - ≤ 0.8 W/kg or 2.0 W/kg, for 1-g or 10-g respectively, when the transmission band is ≤ 100 MHz
 - ≤ 0.6 W/kg or 1.5 W/kg, for 1-g or 10-g respectively, when the transmission band is between 100 MHz and 200 MHz
 - ≤ 0.4 W/kg or 1.0 W/kg, for 1-g or 10-g respectively, when the transmission band is ≥ 200 MHz
3. Per KDB 865664 D01v01r04, for each frequency band, repeated SAR measurement is required only when the measured SAR is ≥ 0.8 W/kg.
4. Per KDB648474 D04v01r03, when the reported SAR for a body-worn accessory, measured without a headset connected to the handset, is > 1.2 W/kg, the highest reported SAR configuration for that wireless mode and frequency band should be repeated for that body-worn accessory with a headset attached to the handset.
5. Per KDB648474 D04v01r03, for smart phones with a display diagonal dimension > 15.0 cm or an overall diagonal dimension > 16.0 cm, when hotspot mode applies, 10-g product specific SAR is required only for the surfaces and edges with hotspot mode 1-g reported SAR > 1.2 W/kg, however, when power reduction applies to hotspot mode the measured SAR must be scaled to the maximum output power, including tolerance, allowed for phablet modes to compare with the 1.2 W/kg SAR test reduction threshold, for this device only bottom side SAR for WWAN transmitter scaled to maximum output power is higher than 1.2W/kg of GSM1900, WCDMA B2/B4 and LTE B2/B7/B66, therefore product specific SAR is necessary.
6. For front and back position at hotspot exposure condition was choose higher power level between hotspot power table and body-worn power table for SAR compliance.
7. Reduced power for different RF exposure conditions:
 - a. Body worn: The device employs proximity sensors that detect the presence of the user's body at the front or back faces of the device, when operating in near-body condition by end user, the device will reduced maximum output powers on the UMTS B2/B4 and LTE B2/B4/B7/B66 transmit and detail descriptions of the power reduction mechanism are included in the operational description.
 - b. Hotspot: When the mobile hotspot session is turn on by end user, the device will reduced output powers on the GSM1900, WCDMA B2/B4 and LTE B2/B4/B7/B66 transmit and detail descriptions of the power reduction mechanism are included in the operational description.
 - c. Handheld: The device additionally employs proximity sensors that detect the presence of tissue near the currently active transmit antenna, the device will reduced output powers on the LTE B7 transmitter and detail descriptions of the power reduction mechanism are included in the operational description.
8. Body-worn/Hotspot SAR was tested at 5mm separation and extremity SAR was tested at 0mm separation, at the reduced power level in each associated power table. For verification of compliance of power reduction scheme, additional SAR testing with EUT transmitting at full RF power at a conservative trigger distance was performed:
 - a. For Body-worn:
 - Front: [9 mm](#)
 - Back: [19 mm](#)
 - b. For Extremity, only base on the actual performed 0mm face SAR.
 - Back: [9 mm](#)
 - Bottom: [6 mm](#)



GSM Note:

1. Per KDB 941225 D01v03r01, for SAR test reduction for GSM / GPRS / EDGE modes is determined by the source-based time-averaged output power including tune-up tolerance. The mode with highest specified time-averaged output power should be tested for SAR compliance in the applicable exposure conditions. For modes with the same specified maximum output power and tolerance, the higher number time-slot configuration should be tested. Therefore, the GPRS (3Tx slots) for GSM850/GSM1900 is considered as the primary mode.
2. Other configurations of GSM / GPRS / EDGE are considered as secondary modes. The 3G SAR test reduction procedure is applied, when the maximum output power and tune-up tolerance specified for production units in a secondary mode is $\leq \frac{1}{4}$ dB higher than the primary mode, SAR measurement is not required for the secondary mode.
3. Power reduction which is implemented in GSM850/GSM1900 band, for SAR testing EUT was set in reduced power mode and GPRS 4Tx slot due to its highest frame-average power.

**UMTS Note:**

1. Per KDB 941225 D01v03r01, for SAR testing is measured using a 12.2 kbps RMC with TPC bits configured to all "1's".
2. Per KDB 941225 D01v03r01, RMC 12.2kbps setting is used to evaluate SAR. The maximum output power and tune-up tolerance specified for production units in HSDPA / HSUPA / DC-HSDPA is $\leq \frac{1}{4}$ dB higher than RMC 12.2Kbps or when the highest reported SAR of the RMC12.2Kbps is scaled by the ratio of specified maximum output power and tune-up tolerance of HSDPA / HSUPA / DC-HSDPA to RMC12.2Kbps and the adjusted SAR is ≤ 1.2 W/kg, SAR measurement is not required for HSDPA / HSUPA / DC-HSDPA, and according to the following RF output power, the output power results of the secondary modes (HSUPA, HSDPA, DC-HSDPA) are less than $\frac{1}{4}$ dB higher than the primary modes; therefore, SAR measurement is not required for HSDPA / HSUPA / DC-HSDPA.

LTE Note:

1. Per KDB 941225 D05v02r05, start with the largest channel bandwidth and measure SAR for QPSK with 1 RB allocation, using the RB offset and required test channel combination with the highest maximum output power for RB offsets at the upper edge, middle and lower edge of each required test channel.
2. Per KDB 941225 D05v02r05, 50% RB allocation for QPSK SAR testing follows 1RB QPSK allocation procedure.
3. Per KDB 941225 D05v02r05, For QPSK with 100% RB allocation, SAR is not required when the highest maximum output power for 100 % RB allocation is less than the highest maximum output power in 50% and 1 RB allocations and the highest reported SAR for 1 RB and 50% RB allocation are ≤ 0.8 W/kg. Otherwise, SAR is measured for the highest output power channel; and if the reported SAR is > 1.45 W/kg, the remaining required test channels must also be tested.
4. Per KDB 941225 D05v02r05, 16QAM output power for each RB allocation configuration is $>$ not $\frac{1}{2}$ dB higher than the same configuration in QPSK and the reported SAR for the QPSK configuration is ≤ 1.45 W/kg; Per KDB 941225 D05v02r05, 16QAM SAR testing is not required.
5. Per KDB 941225 D05v02r05, Smaller bandwidth output power for each RB allocation configuration is $>$ not $\frac{1}{2}$ dB higher than the same configuration in the largest supported bandwidth, and the reported SAR for the largest supported bandwidth is ≤ 1.45 W/kg; Per KDB 941225 D05v02r05, smaller bandwidth SAR testing is not required.
6. For LTE 4 the maximum bandwidth does not support three non-overlapping channels, per KDB 941225 D05v02r05, when a device supports overlapping channel assignment in a channel bandwidth configuration, the middle channel of the group of overlapping channels should be selected for testing.
7. LTE band 4 SAR test was covered by Band 66; according to TCB workshop, SAR test for overlapping LTE bands can be reduced if The maximum output power, including tolerance, for the smaller band is \leq the larger band to qualify for the SAR test exclusion.
 - a. The channel bandwidth and other operating parameters for the smaller band are fully supported by the larger band.

WLAN Note:

1. Per KDB 248227 D01v02r02, for 2.4GHz 802.11g/n SAR testing is not required when the highest reported SAR for DSSS is adjusted by the ratio of OFDM to DSSS specified maximum output power and the adjusted SAR is ≤ 1.2 W/kg.
2. When the reported SAR of the test position is > 0.4 W/kg, SAR is repeated for the 802.11 transmission mode configuration tested in the initial test position to measure the subsequent next closet/smallest test separation distance and maximum coupling test position on the highest maximum output power channel, until the report SAR is ≤ 0.8 W/kg or all required test position are tested.
3. For all positions / configurations, when the reported SAR is > 0.8 W/kg, SAR is measured for these test positions / configurations on the subsequent next highest measured output power channel(s) until the reported SAR is ≤ 1.2 W/kg or all required channels are tested.
4. During SAR testing the WLAN transmission was verified using a spectrum analyzer.



15.1 Hotspot SAR

<GSM SAR>

Plot No.	Band	Mode	Test Position	Gap (mm)	Power Reduction	Ch.	Freq. (MHz)	Average Power (dBm)	Tune-Up Limit (dBm)	Tune-up Scaling Factor	Power Drift (dB)	Measured 1g SAR (W/kg)	Reported 1g SAR (W/kg)
	GSM1900	GPRS 4 Tx slots	Front	5	Reduced	810	1909.8	23.49	25.00	1.416	0.07	0.417	0.590
	GSM1900	GPRS 4 Tx slots	Back	5	Reduced	810	1909.8	23.49	25.00	1.416	0.05	0.818	1.158
	GSM1900	GPRS 4 Tx slots	Back	5	Reduced	661	1880	23.24	25.00	1.500	0.02	0.692	1.038
	GSM1900	GPRS 4 Tx slots	Back	5	Reduced	512	1850.2	23.21	25.00	1.510	0.01	0.711	1.074
	GSM1900	GPRS 4 Tx slots	Left Side	5	Reduced	810	1909.8	22.70	23.50	1.202	0.03	0.064	0.077
	GSM1900	GPRS 4 Tx slots	Right Side	5	Reduced	810	1909.8	22.70	23.50	1.202	0.09	0.060	0.072
01	GSM1900	GPRS 4 Tx slots	Bottom Side	5	Reduced	810	1909.8	22.70	23.50	1.202	-0.17	0.976	1.173
	GSM1900	GPRS 4 Tx slots	Bottom Side	5	Reduced	661	1880	22.59	23.50	1.233	-0.14	0.851	1.049
	GSM1900	GPRS 4 Tx slots	Bottom Side	5	Reduced	512	1850.2	22.55	23.50	1.245	-0.14	0.867	1.079

<WCDMA SAR>

Plot No.	Band	Mode	Test Position	Gap (mm)	Power Reduction	Ch.	Freq. (MHz)	Average Power (dBm)	Tune-Up Limit (dBm)	Tune-up Scaling Factor	Power Drift (dB)	Measured 1g SAR (W/kg)	Reported 1g SAR (W/kg)
	WCDMA II	RMC 12.2Kbps	Front	5	Reduced	9400	1880	19.17	20.00	1.211	0.11	0.343	0.415
	WCDMA II	RMC 12.2Kbps	Back	5	Reduced	9400	1880	19.17	20.00	1.211	0.02	0.829	1.004
	WCDMA II	RMC 12.2Kbps	Back	5	Reduced	9262	1852.4	19.07	20.00	1.239	0.09	0.938	1.162
	WCDMA II	RMC 12.2Kbps	Back	5	Reduced	9538	1907.6	19.15	20.00	1.216	0.01	0.717	0.872
	WCDMA II	RMC 12.2Kbps	Left Side	5	Reduced	9400	1880	17.56	18.50	1.242	0.01	0.091	0.113
	WCDMA II	RMC 12.2Kbps	Right Side	5	Reduced	9400	1880	17.56	18.50	1.242	0.01	0.088	0.109
	WCDMA II	RMC 12.2Kbps	Bottom Side	5	Reduced	9400	1880	17.56	18.50	1.242	-0.09	0.986	1.224
02	WCDMA II	RMC 12.2Kbps	Bottom Side	5	Reduced	9262	1852.4	17.48	18.50	1.265	-0.08	1.050	1.328
	WCDMA II	RMC 12.2Kbps	Bottom Side	5	Reduced	9538	1907.6	17.54	18.50	1.247	-0.02	0.906	1.130
	WCDMA IV	RMC 12.2Kbps	Front	5	Reduced	1413	1732.6	16.63	17.50	1.222	0.04	0.278	0.340
	WCDMA IV	RMC 12.2Kbps	Back	5	Reduced	1413	1732.6	16.63	17.50	1.222	0.03	0.875	1.069
	WCDMA IV	RMC 12.2Kbps	Back	5	Reduced	1312	1712.4	16.56	17.50	1.242	0.04	0.903	1.121
	WCDMA IV	RMC 12.2Kbps	Back	5	Reduced	1513	1752.6	16.61	17.50	1.227	0.01	0.831	1.020
	WCDMA IV	RMC 12.2Kbps	Left Side	5	Reduced	1413	1732.6	16.34	17.00	1.164	0.09	0.013	0.015
	WCDMA IV	RMC 12.2Kbps	Right Side	5	Reduced	1413	1732.6	16.34	17.00	1.164	0.03	0.063	0.074
	WCDMA IV	RMC 12.2Kbps	Bottom Side	5	Reduced	1413	1732.6	16.34	17.00	1.163	-0.01	1.040	1.210
	WCDMA IV	RMC 12.2Kbps	Bottom Side	5	Reduced	1312	1712.4	16.33	17.00	1.167	-0.02	1.030	1.202
03	WCDMA IV	RMC 12.2Kbps	Bottom Side	5	Reduced	1513	1752.6	16.31	17.00	1.172	-0.02	1.050	1.231



<FDD LTE SAR>

Plot No.	Band	BW (MHz)	Modulation	RB Size	RB offset	Test Position	Gap (mm)	Power Reduction	Ch.	Freq. (MHz)	Average Power (dBm)	Tune-Up Limit (dBm)	Tune-up Scaling Factor	Power Drift (dB)	Measured 1g SAR (W/kg)	Reported 1g SAR (W/kg)
	LTE Band 2	20M	QPSK	1	0	Front	5	Reduced	18900	1880	20.42	21.00	1.143	0.02	0.413	0.472
	LTE Band 2	20M	QPSK	50	0	Front	5	Reduced	18900	1880	20.35	21.00	1.161	-0.05	0.416	0.483
	LTE Band 2	20M	QPSK	1	0	Back	5	Reduced	18900	1880	20.42	21.00	1.143	0.09	1.090	1.246
	LTE Band 2	20M	QPSK	1	0	Back	5	Reduced	18700	1860	20.35	21.00	1.161	0.07	1.050	1.220
	LTE Band 2	20M	QPSK	1	0	Back	5	Reduced	19100	1900	20.33	21.00	1.167	0.04	0.974	1.136
	LTE Band 2	20M	QPSK	50	0	Back	5	Reduced	18900	1880	20.35	21.00	1.161	0.08	1.080	1.254
04	LTE Band 2	20M	QPSK	50	0	Back	5	Reduced	18700	1860	20.31	21.00	1.172	0.01	1.150	1.348
	LTE Band 2	20M	QPSK	50	0	Back	5	Reduced	19100	1900	20.33	21.00	1.167	0.01	0.966	1.127
	LTE Band 2	20M	QPSK	100	0	Back	5	Reduced	18900	1880	20.04	21.00	1.247	0.06	0.926	1.155
	LTE Band 2	20M	QPSK	1	0	Left Side	5	Reduced	18900	1880	18.24	18.50	1.062	0.01	0.089	0.095
	LTE Band 2	20M	QPSK	50	0	Left Side	5	Reduced	18900	1880	18.15	18.50	1.084	0.02	0.092	0.100
	LTE Band 2	20M	QPSK	1	0	Right Side	5	Reduced	18900	1880	18.24	18.50	1.062	-0.02	0.086	0.091
	LTE Band 2	20M	QPSK	50	0	Right Side	5	Reduced	18900	1880	18.15	18.50	1.084	-0.12	0.084	0.091
	LTE Band 2	20M	QPSK	1	0	Bottom Side	5	Reduced	18900	1880	18.24	18.50	1.062	-0.03	1.010	1.072
	LTE Band 2	20M	QPSK	1	0	Bottom Side	5	Reduced	18700	1860	18.04	18.50	1.112	0.01	1.080	1.201
	LTE Band 2	20M	QPSK	1	0	Bottom Side	5	Reduced	19100	1900	17.99	18.50	1.125	0.02	0.945	1.063
	LTE Band 2	20M	QPSK	50	0	Bottom Side	5	Reduced	18900	1880	18.15	18.50	1.084	-0.02	1.000	1.084
	LTE Band 2	20M	QPSK	50	0	Bottom Side	5	Reduced	18700	1860	17.90	18.50	1.148	-0.12	1.020	1.171
	LTE Band 2	20M	QPSK	50	0	Bottom Side	5	Reduced	19100	1900	18.04	18.50	1.112	-0.03	0.948	1.054
	LTE Band 2	20M	QPSK	100	0	Bottom Side	5	Reduced	18700	1860	18.07	18.50	1.104	0.05	1.040	1.148
	LTE Band 7	20M	QPSK	1	0	Front	5	Reduced	21100	2535	18.60	19.00	1.096	0.05	0.322	0.353
	LTE Band 7	20M	QPSK	50	0	Front	5	Reduced	21100	2535	18.53	19.00	1.114	0.01	0.322	0.359
	LTE Band 7	20M	QPSK	1	0	Back	5	Reduced	21100	2535	18.60	19.00	1.096	0.02	1.030	1.129
05	LTE Band 7	20M	QPSK	1	0	Back	5	Reduced	20850	2510	18.45	19.00	1.135	0.08	1.140	1.294
	LTE Band 7	20M	QPSK	1	0	Back	5	Reduced	21350	2560	18.58	19.00	1.102	0.01	0.918	1.011
	LTE Band 7	20M	QPSK	50	0	Back	5	Reduced	21100	2535	18.53	19.00	1.114	0.02	1.020	1.137
	LTE Band 7	20M	QPSK	50	0	Back	5	Reduced	20850	2510	18.36	19.00	1.159	-0.02	1.090	1.263
	LTE Band 7	20M	QPSK	50	0	Back	5	Reduced	21350	2560	18.47	19.00	1.130	-0.12	0.911	1.029
	LTE Band 7	20M	QPSK	100	0	Back	5	Reduced	21100	2535	18.56	19.00	1.107	-0.03	1.000	1.107
	LTE Band 7	20M	QPSK	1	0	Left Side	5	Reduced	21100	2535	18.60	19.00	1.096	0.02	0.042	0.046
	LTE Band 7	20M	QPSK	50	0	Left Side	5	Reduced	21100	2535	18.53	19.00	1.114	0.03	0.043	0.048
	LTE Band 7	20M	QPSK	1	0	Right Side	5	Reduced	21100	2535	18.60	19.00	1.096	0.01	0.161	0.177
	LTE Band 7	20M	QPSK	50	0	Right Side	5	Reduced	21100	2535	18.53	19.00	1.114	-0.05	0.155	0.173
	LTE Band 7	20M	QPSK	1	0	Bottom Side	5	Reduced	21100	2535	18.60	19.00	1.096	0.04	0.874	0.958
	LTE Band 7	20M	QPSK	1	0	Bottom Side	5	Reduced	20850	2510	18.45	19.00	1.135	0.16	0.941	1.068
	LTE Band 7	20M	QPSK	1	0	Bottom Side	5	Reduced	21350	2560	18.58	19.00	1.102	0.06	0.786	0.866
	LTE Band 7	20M	QPSK	50	0	Bottom Side	5	Reduced	21100	2535	18.53	19.00	1.114	0.02	0.867	0.966
	LTE Band 7	20M	QPSK	50	0	Bottom Side	5	Reduced	20850	2510	18.36	19.00	1.159	0.06	1.060	1.228
	LTE Band 7	20M	QPSK	50	0	Bottom Side	5	Reduced	21350	2560	18.47	19.00	1.130	0.01	0.786	0.888
	LTE Band 7	20M	QPSK	100	0	Bottom Side	5	Reduced	21100	2535	18.56	19.00	1.107	0.12	0.869	0.962



Plot No.	Band	BW (MHz)	Modulation	RB Size	RB offset	Test Position	Gap (mm)	Power Reduction	Ch.	Freq. (MHz)	Average Power (dBm)	Tune-Up Limit (dBm)	Tune-up Scaling Factor	Power Drift (dB)	Measured 1g SAR (W/kg)	Reported 1g SAR (W/kg)
	LTE Band 66	20M	QPSK	1	0	Front	5	Reduced	132322	1745	17.14	18.00	1.219	-0.07	0.262	0.319
	LTE Band 66	20M	QPSK	50	0	Front	5	Reduced	132322	1745	17.00	18.00	1.259	0.04	0.258	0.325
	LTE Band 66	20M	QPSK	1	0	Back	5	Reduced	132322	1745	17.14	18.00	1.219	0.03	0.898	1.095
	LTE Band 66	20M	QPSK	1	0	Back	5	Reduced	132072	1720	17.13	18.00	1.222	0.06	0.911	1.113
	LTE Band 66	20M	QPSK	1	0	Back	5	Reduced	132572	1770	16.98	18.00	1.265	0.09	0.689	0.871
	LTE Band 66	20M	QPSK	50	0	Back	5	Reduced	132322	1745	17.00	18.00	1.259	0.14	0.891	1.122
	LTE Band 66	20M	QPSK	50	0	Back	5	Reduced	132072	1720	16.95	18.00	1.274	0.02	0.820	1.044
	LTE Band 66	20M	QPSK	50	0	Back	5	Reduced	132572	1770	16.93	18.00	1.279	0.03	0.683	0.874
	LTE Band 66	20M	QPSK	100	0	Back	5	Reduced	132322	1745	17.06	18.00	1.242	0.02	0.772	0.959
	LTE Band 66	20M	QPSK	1	0	Left Side	5	Reduced	132322	1745	16.51	17.00	1.119	0.02	0.012	0.013
	LTE Band 66	20M	QPSK	50	0	Left Side	5	Reduced	132322	1745	16.32	17.00	1.169	0.03	0.011	0.013
	LTE Band 66	20M	QPSK	1	0	Right Side	5	Reduced	132322	1745	16.51	17.00	1.119	0.01	0.066	0.074
	LTE Band 66	20M	QPSK	50	0	Right Side	5	Reduced	132322	1745	16.32	17.00	1.169	0.05	0.061	0.071
	LTE Band 66	20M	QPSK	1	0	Bottom Side	5	Reduced	132322	1745	16.51	17.00	1.119	-0.03	0.984	1.102
	LTE Band 66	20M	QPSK	1	0	Bottom Side	5	Reduced	132072	1720	16.35	17.00	1.161	0.01	0.961	1.116
	LTE Band 66	20M	QPSK	1	0	Bottom Side	5	Reduced	132572	1770	16.25	17.00	1.189	0.07	0.877	1.042
06	LTE Band 66	20M	QPSK	50	0	Bottom Side	5	Reduced	132322	1745	16.32	17.00	1.169	0.06	0.969	1.133
	LTE Band 66	20M	QPSK	50	0	Bottom Side	5	Reduced	132072	1720	16.16	17.00	1.213	0.05	0.921	1.118
	LTE Band 66	20M	QPSK	50	0	Bottom Side	5	Reduced	132572	1770	16.10	17.00	1.230	0.08	0.878	1.080
	LTE Band 66	20M	QPSK	100	0	Bottom Side	5	Reduced	132322	1745	16.30	17.00	1.175	0.03	0.953	1.120

15.2 Body Worn Accessory SAR

<GSM SAR>

Plot No.	Band	Mode	Test Position	Gap (mm)	Power Reduction	Ch.	Freq. (MHz)	Average Power (dBm)	Tune-Up Limit (dBm)	Tune-up Scaling Factor	Power Drift (dB)	Measured 1g SAR (W/kg)	Reported 1g SAR (W/kg)
	GSM1900	GPRS 4 Tx slots	Front	5	Reduced	810	1909.8	23.49	25.00	1.416	0.07	0.417	0.590
07	GSM1900	GPRS 4 Tx slots	Back	5	Reduced	810	1909.8	23.49	25.00	1.416	0.05	0.818	1.158
	GSM1900	GPRS 4 Tx slots	Back	5	Reduced	661	1880	23.24	25.00	1.500	0.02	0.692	1.038
	GSM1900	GPRS 4 Tx slots	Back	5	Reduced	512	1850.2	23.21	25.00	1.510	0.01	0.711	1.074
	GSM1900	GPRS 4 Tx slots	Front	9	Full	810	1909.8	25.27	26.00	1.183	0.01	0.437	0.517
	GSM1900	GPRS 4 Tx slots	Back	19	Full	810	1909.8	25.27	26.00	1.183	0.03	0.176	0.208

<WCDMA SAR>

Plot No.	Band	Mode	Test Position	Gap (mm)	Power Reduction	Ch.	Freq. (MHz)	Average Power (dBm)	Tune-Up Limit (dBm)	Tune-up Scaling Factor	Power Drift (dB)	Measured 1g SAR (W/kg)	Reported 1g SAR (W/kg)
	WCDMA II	RMC 12.2Kbps	Front	5	Reduced	9400	1880	19.17	20.00	1.211	0.11	0.343	0.415
	WCDMA II	RMC 12.2Kbps	Back	5	Reduced	9400	1880	19.17	20.00	1.211	0.02	0.829	1.004
08	WCDMA II	RMC 12.2Kbps	Back	5	Reduced	9262	1852.4	19.07	20.00	1.239	0.09	0.938	1.162
	WCDMA II	RMC 12.2Kbps	Back	5	Reduced	9538	1907.6	19.15	20.00	1.216	0.01	0.717	0.872
	WCDMA II	RMC 12.2Kbps	Front	9	Full	9400	1880	22.58	24.00	1.387	0.01	0.532	0.738
	WCDMA II	RMC 12.2Kbps	Back	19	Full	9262	1852.4	22.43	24.00	1.435	0.05	0.213	0.306
	WCDMA IV	RMC 12.2Kbps	Front	5	Reduced	1413	1732.6	16.63	17.50	1.222	0.04	0.278	0.340
	WCDMA IV	RMC 12.2Kbps	Back	5	Reduced	1413	1732.6	16.63	17.50	1.222	0.03	0.875	1.069
	WCDMA IV	RMC 12.2Kbps	Back	5	Reduced	1312	1712.4	16.56	17.50	1.242	0.04	0.903	1.121
	WCDMA IV	RMC 12.2Kbps	Back	5	Reduced	1513	1752.6	16.61	17.50	1.227	0.01	0.831	1.020
	WCDMA IV	RMC 12.2Kbps	Front	9	Full	1413	1732.6	22.25	24.00	1.496	-0.04	0.761	1.139
09	WCDMA IV	RMC 12.2Kbps	Front	9	Full	1312	1712.4	22.18	24.00	1.521	-0.04	0.777	1.181
	WCDMA IV	RMC 12.2Kbps	Front	9	Full	1513	1752.6	22.28	24.00	1.486	0.03	0.735	1.092
	WCDMA IV	RMC 12.2Kbps	Back	19	Full	1312	1712.4	22.18	24.00	1.521	0.09	0.711	1.081

<FDD LTE SAR>

Plot No.	Band	BW (MHz)	Modulation	RB Size	RB offset	Test Position	Gap (mm)	Headset	Power Reduction	Ch.	Freq. (MHz)	Average Power (dBm)	Tune-Up Limit (dBm)	Tune-up Scaling Factor	Power Drift (dB)	Measured 1g SAR (W/kg)	Reported 1g SAR (W/kg)
	LTE Band 2	20M	QPSK	1	0	Front	5	-	Reduced	18900	1880	20.42	21.00	1.143	0.02	0.413	0.472
	LTE Band 2	20M	QPSK	50	0	Front	5	-	Reduced	18900	1880	20.35	21.00	1.161	-0.05	0.416	0.483
	LTE Band 2	20M	QPSK	1	0	Back	5	-	Reduced	18900	1880	20.42	21.00	1.143	0.09	1.090	1.246
	LTE Band 2	20M	QPSK	1	0	Back	5	-	Reduced	18700	1860	20.35	21.00	1.161	0.07	1.050	1.220
	LTE Band 2	20M	QPSK	1	0	Back	5	-	Reduced	19100	1900	20.33	21.00	1.167	0.04	0.974	1.136
	LTE Band 2	20M	QPSK	50	0	Back	5	-	Reduced	18900	1880	20.35	21.00	1.161	0.08	1.080	1.254
10	LTE Band 2	20M	QPSK	50	0	Back	5	-	Reduced	18700	1860	20.31	21.00	1.172	0.01	1.150	1.348
	LTE Band 2	20M	QPSK	50	0	Back	5	-	Reduced	19100	1900	20.33	21.00	1.167	0.01	0.966	1.127
	LTE Band 2	20M	QPSK	100	0	Back	5	-	Reduced	18900	1880	20.04	21.00	1.247	0.06	0.926	1.155
	LTE Band 2	20M	QPSK	50	0	Back	5	Headset	Reduced	18700	1860	20.31	21.00	1.172	0.07	1.050	1.231
	LTE Band 2	20M	QPSK	1	0	Front	9	-	Full	18900	1880	22.78	24.00	1.324	0.03	0.533	0.706
	LTE Band 2	20M	QPSK	1	0	Back	19	-	Full	18700	1860	22.67	24.00	1.358	0.04	0.210	0.285
	LTE Band 7	20M	QPSK	1	0	Front	5	-	Reduced	21100	2535	18.60	19.00	1.096	0.05	0.322	0.353
	LTE Band 7	20M	QPSK	50	0	Front	5	-	Reduced	21100	2535	18.53	19.00	1.114	0.01	0.322	0.359
	LTE Band 7	20M	QPSK	1	0	Back	5	-	Reduced	21100	2535	18.60	19.00	1.096	0.02	1.030	1.129
11	LTE Band 7	20M	QPSK	1	0	Back	5	-	Reduced	20850	2510	18.45	19.00	1.135	0.08	1.140	1.294
	LTE Band 7	20M	QPSK	1	0	Back	5	-	Reduced	21350	2560	18.58	19.00	1.102	0.01	0.918	1.011
	LTE Band 7	20M	QPSK	50	0	Back	5	-	Reduced	21100	2535	18.53	19.00	1.114	0.02	1.020	1.137
	LTE Band 7	20M	QPSK	50	0	Back	5	-	Reduced	20850	2510	18.36	19.00	1.159	-0.02	1.090	1.263
	LTE Band 7	20M	QPSK	50	0	Back	5	-	Reduced	21350	2560	18.47	19.00	1.130	-0.12	0.911	1.029
	LTE Band 7	20M	QPSK	100	0	Back	5	-	Reduced	21100	2535	18.56	19.00	1.107	-0.03	1.000	1.107
	LTE Band 7	20M	QPSK	1	0	Back	5	Headset	Reduced	20850	2510	18.45	19.00	1.135	0.01	1.080	1.226
	LTE Band 7	20M	QPSK	1	0	Front	9	-	Full	21100	2535	22.88	24.00	1.294	0.03	0.463	0.599
	LTE Band 7	20M	QPSK	1	0	Back	19	-	Full	20850	2510	22.77	24.00	1.327	0.01	0.261	0.346
	LTE Band 66	20M	QPSK	1	0	Front	5	-	Reduced	132322	1745	17.14	18.00	1.219	-0.07	0.262	0.319
	LTE Band 66	20M	QPSK	50	0	Front	5	-	Reduced	132322	1745	17.00	18.00	1.259	0.04	0.258	0.325
	LTE Band 66	20M	QPSK	1	0	Back	5	-	Reduced	132322	1745	17.14	18.00	1.219	0.03	0.898	1.095
	LTE Band 66	20M	QPSK	1	0	Back	5	-	Reduced	132072	1720	17.13	18.00	1.222	0.06	0.911	1.113
	LTE Band 66	20M	QPSK	1	0	Back	5	-	Reduced	132572	1770	16.98	18.00	1.265	0.09	0.689	0.871
12	LTE Band 66	20M	QPSK	50	0	Back	5	-	Reduced	132322	1745	17.00	18.00	1.259	0.14	0.891	1.122
	LTE Band 66	20M	QPSK	50	0	Back	5	-	Reduced	132072	1720	16.95	18.00	1.274	0.02	0.820	1.044
	LTE Band 66	20M	QPSK	50	0	Back	5	-	Reduced	132572	1770	16.93	18.00	1.279	0.03	0.683	0.874
	LTE Band 66	20M	QPSK	100	0	Back	5	-	Reduced	132322	1745	17.06	18.00	1.242	0.02	0.772	0.959
	LTE Band 66	20M	QPSK	1	0	Front	9	-	Full	132322	1745	22.79	24.00	1.321	0.01	0.751	0.992
	LTE Band 66	20M	QPSK	1	0	Front	9	-	Full	132072	1720	22.78	24.00	1.324	0.01	0.811	1.074
	LTE Band 66	20M	QPSK	1	0	Front	9	-	Full	132572	1770	22.77	24.00	1.327	0.03	0.658	0.873
	LTE Band 66	20M	QPSK	1	0	Back	19	-	Full	132322	1745	22.79	24.00	1.321	0.01	0.576	0.761

<WLAN2.4G SAR>

Band	Mode	Test Position	Gap (mm)	Power Reduction	Ch.	Freq. (MHz)	Average Power (dBm)	Tune-Up Limit (dBm)	Tune-up Scaling Factor	Duty Cycle %	Duty Cycle Scaling Factor	Power Drift (dB)	Measured 1g SAR (W/kg)	Reported 1g SAR (W/kg)
WLAN2.4GHz	802.11b 1Mbps	Front	9	Full	6	2437	18.98	19.50	1.127	100	1.000	-0.06	0.182	0.205
WLAN2.4GHz	802.11b 1Mbps	Back	19	Full	6	2437	18.98	19.50	1.127	100	1.000	0.06	0.066	0.075

Note: WLAN2.4GHz distance SAR testing is only performed for collocated with WWAN analysis.



15.3 Product Specific SAR

<GSM SAR>

Plot No.	Band	Mode	Test Position	Gap (mm)	Power Reduction	Ch.	Freq. (MHz)	Average Power (dBm)	Tune-Up Limit (dBm)	Tune-up Scaling Factor	Power Drift (dB)	Measured 10g SAR (W/kg)	Reported 10g SAR (W/kg)
	GSM1900	GPRS 4 Tx slots	Back	0	Reduced	810	1909.8	23.45	24.50	1.274	0.03	0.934	1.189
14	GSM1900	GPRS 4 Tx slots	Bottom Side	0	Reduced	810	1909.8	23.45	24.50	1.274	0.02	1.260	1.605
	GSM1900	GPRS 4 Tx slots	Back	9	Full	810	1909.8	25.27	26.00	1.183	0.03	0.313	0.370
	GSM1900	GPRS 4 Tx slots	Bottom Side	6	Full	810	1909.8	25.27	26.00	1.183	0.06	0.678	0.802

<WCDMA SAR>

Plot No.	Band	Mode	Test Position	Gap (mm)	Power Reduction	Ch.	Freq. (MHz)	Average Power (dBm)	Tune-Up Limit (dBm)	Tune-up Scaling Factor	Power Drift (dB)	Measured 10g SAR (W/kg)	Reported 10g SAR (W/kg)
	WCDMA II	RMC 12.2Kbps	Back	0	Reduced	9400	1880	20.17	21.00	1.211	0.08	1.390	1.683
	WCDMA II	RMC 12.2Kbps	Bottom Side	0	Reduced	9400	1880	20.17	21.00	1.211	-0.01	1.960	2.373
15	WCDMA II	RMC 12.2Kbps	Bottom Side	0	Reduced	9262	1852.4	20.15	21.00	1.216	-0.09	2.010	2.445
	WCDMA II	RMC 12.2Kbps	Bottom Side	0	Reduced	9538	1907.6	20.15	21.00	1.216	0.02	1.610	1.958
	WCDMA II	RMC 12.2Kbps	Back	9	Full	9400	1880	22.58	24.00	1.387	0.08	0.461	0.639
	WCDMA II	RMC 12.2Kbps	Bottom Side	6	Full	9262	1852.4	22.43	24.00	1.435	0.03	1.410	2.024
	WCDMA IV	RMC 12.2Kbps	Back	0	Reduced	1413	1732.6	19.15	20.00	1.216	0.09	1.080	1.313
	WCDMA IV	RMC 12.2Kbps	Bottom Side	0	Reduced	1413	1732.6	19.15	20.00	1.216	-0.01	1.430	1.739
	WCDMA IV	RMC 12.2Kbps	Back	9	Full	1413	1732.6	22.25	24.00	1.496	0.09	1.200	1.795
	WCDMA IV	RMC 12.2Kbps	Bottom Side	6	Full	1413	1732.6	22.25	24.00	1.496	-0.01	2.010	3.007
16	WCDMA IV	RMC 12.2Kbps	Bottom Side	6	Full	1312	1712.4	22.18	24.00	1.521	0.07	2.100	3.193
	WCDMA IV	RMC 12.2Kbps	Bottom Side	6	Full	1513	1752.6	22.28	24.00	1.486	0.06	1.930	2.868



<FDD LTE SAR>

Plot No.	Band	BW (MHz)	Modulation	RB Size	RB offset	Test Position	Gap (mm)	Power Reduction	Ch.	Freq. (MHz)	Average Power (dBm)	Tune-Up Limit (dBm)	Tune-up Scaling Factor	Power Drift (dB)	Measured 10g SAR (W/kg)	Reported 10g SAR (W/kg)
	LTE Band 2	20M	QPSK	1	0	Back	0	Reduced	18900	1880	20.70	21.50	1.202	0.02	1.190	1.431
	LTE Band 2	20M	QPSK	50	0	Back	0	Reduced	18900	1880	20.67	21.50	1.211	0.04	1.190	1.441
	LTE Band 2	20M	QPSK	1	0	Bottom Side	0	Reduced	18900	1880	20.70	21.50	1.202	-0.01	1.930	2.320
	LTE Band 2	20M	QPSK	1	0	Bottom Side	0	Reduced	18700	1860	20.43	21.50	1.279	-0.04	1.920	2.456
	LTE Band 2	20M	QPSK	1	0	Bottom Side	0	Reduced	19100	1900	20.46	21.50	1.271	-0.02	1.830	2.325
	LTE Band 2	20M	QPSK	50	0	Bottom Side	0	Reduced	18900	1880	20.67	21.50	1.211	-0.01	1.950	2.361
17	LTE Band 2	20M	QPSK	50	0	Bottom Side	0	Reduced	18700	1860	20.47	21.50	1.268	-0.04	1.950	2.472
	LTE Band 2	20M	QPSK	50	0	Bottom Side	0	Reduced	19100	1900	20.57	21.50	1.239	-0.08	1.880	2.329
	LTE Band 2	20M	QPSK	100	0	Bottom Side	0	Reduced	18900	1880	20.58	21.50	1.236	-0.08	1.910	2.361
	LTE Band 2	20M	QPSK	1	0	Back	9	Full	18900	1880	22.78	24.00	1.324	0.01	0.434	0.575
	LTE Band 2	20M	QPSK	1	0	Bottom Side	6	Full	18700	1860	22.67	24.00	1.358	0.06	1.240	1.684
	LTE Band 7	20M	QPSK	1	0	Back	0	Reduced	21100	2535	21.39	22.00	1.151	0.02	2.220	2.555
18	LTE Band 7	20M	QPSK	1	0	Back	0	Reduced	20850	2510	21.23	22.00	1.194	0.05	2.390	2.854
	LTE Band 7	20M	QPSK	1	0	Back	0	Reduced	21350	2560	21.21	22.00	1.199	0.02	2.020	2.423
	LTE Band 7	20M	QPSK	50	0	Back	0	Reduced	21100	2535	21.38	22.00	1.153	0.02	2.250	2.595
	LTE Band 7	20M	QPSK	50	0	Back	0	Reduced	20850	2510	21.34	22.00	1.164	-0.03	2.350	2.736
	LTE Band 7	20M	QPSK	50	0	Back	0	Reduced	21350	2560	21.12	22.00	1.225	0.05	2.100	2.572
	LTE Band 7	20M	QPSK	100	0	Back	0	Reduced	21100	2535	21.25	22.00	1.189	-0.08	2.330	2.769
	LTE Band 7	20M	QPSK	1	0	Bottom Side	0	Reduced	21100	2535	21.39	22.00	1.151	0.06	1.850	2.129
	LTE Band 7	20M	QPSK	1	0	Bottom Side	0	Reduced	20850	2510	21.23	22.00	1.194	0.02	1.840	2.197
	LTE Band 7	20M	QPSK	1	0	Bottom Side	0	Reduced	21350	2560	21.21	22.00	1.199	0.09	1.730	2.075
	LTE Band 7	20M	QPSK	50	0	Bottom Side	0	Reduced	21100	2535	21.38	22.00	1.153	0.02	1.870	2.157
	LTE Band 7	20M	QPSK	50	0	Bottom Side	0	Reduced	20850	2510	21.34	22.00	1.164	-0.03	1.880	2.189
	LTE Band 7	20M	QPSK	50	0	Bottom Side	0	Reduced	21350	2560	21.12	22.00	1.225	0.04	1.700	2.082
	LTE Band 7	20M	QPSK	100	0	Bottom Side	0	Reduced	21100	2535	21.25	22.00	1.189	-0.07	1.850	2.199
	LTE Band 7	20M	QPSK	1	0	Back	9	Full	20850	2510	22.77	24.00	1.327	0.06	0.231	0.307
	LTE Band 7	20M	QPSK	1	0	Bottom Side	6	Full	21100	2535	22.88	24.00	1.294	0.02	0.885	1.145
	LTE Band 66	20M	QPSK	1	0	Back	0	Reduced	132322	1745	19.62	20.50	1.225	0.03	1.060	1.298
	LTE Band 66	20M	QPSK	50	0	Back	0	Reduced	132322	1745	19.61	20.50	1.227	0.04	1.090	1.338
	LTE Band 66	20M	QPSK	1	0	Bottom Side	0	Reduced	132322	1745	19.62	20.50	1.225	0.01	1.460	1.788
	LTE Band 66	20M	QPSK	50	0	Bottom Side	0	Reduced	132322	1745	19.61	20.50	1.227	-0.06	1.570	1.927
	LTE Band 66	20M	QPSK	1	0	Back	9	Reduced	132322	1745	22.79	24.00	1.321	0.03	1.180	1.559
19	LTE Band 66	20M	QPSK	1	0	Bottom Side	6	Reduced	132322	1745	22.79	24.00	1.321	0.09	2.230	2.946
	LTE Band 66	20M	QPSK	1	0	Bottom Side	6	Reduced	132072	1720	22.78	24.00	1.324	0.06	2.000	2.649
	LTE Band 66	20M	QPSK	1	0	Bottom Side	6	Reduced	132572	1770	22.77	24.00	1.327	0.09	1.500	1.991

15.4 Repeated SAR Measurement

No.	Band	Mode	Test Position	Gap (mm)	Power Reduction	Ch.	Freq. (MHz)	Average Power (dBm)	Tune-Up Limit (dBm)	Tune-up Scaling Factor	Duty Cycle %	Duty Cycle Scaling Factor	Power Drift (dB)	Measured 1g SAR (W/kg)	Ratio	Reported 1g SAR (W/kg)
1st	WCDMA IV	RMC 12.2Kbps	Bottom Side	5mm	Reduced	1513	1752.6	16.31	17.00	1.172	-	1.000	-0.02	1.050	-	1.231
2nd	WCDMA IV	RMC 12.2Kbps	Bottom Side	5mm	Reduced	1513	1752.6	16.31	17.00	1.172	-	1.000	0.09	1.010	1.04	1.184
1st	LTE Band 2	20M_QPSK_50_0	Back	5mm	Reduced	18700	1860	20.31	21.00	1.172	-	1.000	0.01	1.150	-	1.348
2nd	LTE Band 2	20M_QPSK_50_0	Back	5mm	Reduced	18700	1860	20.31	21.00	1.172	-	1.000	0.09	1.110	1.04	1.301
1st	LTE Band 7	20M_QPSK_1_0	Back	5mm	Reduced	20850	2510	18.45	19.00	1.135	-	1.000	0.08	1.140	-	1.294
2nd	LTE Band 7	20M_QPSK_1_0	Back	5mm	Reduced	20850	2510	18.45	19.00	1.135	-	1.000	-0.12	1.110	1.03	1.260

No.	Band	Mode	Test Position	Gap (mm)	Power Reduction	Ch.	Freq. (MHz)	Average Power (dBm)	Tune-Up Limit (dBm)	Tune-up Scaling Factor	Power Drift (dB)	Measured 10g SAR (W/kg)	Ratio	Reported 10g SAR (W/kg)
1st	WCDMA II	RMC 12.2Kbps	Bottom Side	0mm	Reduced	9262	1852.4	20.15	21.00	1.216	-0.09	2.010	-	2.445
2nd	WCDMA II	RMC 12.2Kbps	Bottom Side	0mm	Reduced	9262	1852.4	20.15	21.00	1.216	0.03	1.990	1.01	2.420
1st	LTE Band 7	20M_QPSK_1_0	Back	0mm	Reduced	20850	2510	21.23	22.00	1.194	0.05	2.390	-	2.854
2nd	LTE Band 7	20M_QPSK_1_0	Back	0mm	Reduced	20850	2510	21.23	22.00	1.194	-0.11	2.350	1.02	2.806
1st	LTE Band 66	20M_QPSK_1_0	Bottom Side	6mm	Reduced	132322	1745	22.79	24.00	1.321	0.09	2.230	-	2.946
2nd	LTE Band 66	20M_QPSK_1_0	Bottom Side	6mm	Reduced	132322	1745	22.79	24.00	1.321	-0.12	2.190	1.02	2.894

General Note:

1. Per KDB 865664 D01v01r04, for each frequency band, repeated SAR measurement is required only when the measured SAR is $\geq 0.8W/kg$.
2. Per KDB 865664 D01v01r04, if the ratio among the repeated measurement is ≤ 1.2 and the measured SAR $< 1.45W/kg$, only one repeated measurement is required.
3. Per KDB 865664 D01v01r04, if the extremity repeated SAR is necessary, the same procedures should be adapted for measurements according to extremity and occupational exposure limits by applying a factor of 2.5 for extremity exposure and a factor of 5 for occupational exposure to the corresponding SAR thresholds.
4. The ratio is the difference in percentage between original and repeated *measured* SAR.
5. All measurement SAR result is scaled-up to account for tune-up tolerance and is compliant.

16. Simultaneous Transmission Analysis

NO.	Simultaneous Transmission Configurations	Portable Handset			
		Head	Body-worn	Hotspot	Product Specific
1.	WWAN + WLAN2.4GHz	Yes	Yes	Yes	Yes
2.	WWAN + Bluetooth	Yes	Yes	Yes	Yes

General Note:

1. For simultaneously transmission SAR analysis, SAR values only considered which we did perform SAR testing on FA052606, and other test results were leverage from the parent model which referred to the test report number FA011726.
2. This device WLAN 2.4GHz supports Hotspot operation and Bluetooth support tethering applications.
3. All licensed modes share the same antenna part and cannot transmit simultaneously.
4. WLAN and Bluetooth share the same antenna, and cannot transmit simultaneously.
5. The Scaled SAR summation is calculated based on the same configuration and test position.
6. Per KDB 447498 D01v06, simultaneous transmission SAR is compliant if,
 - i) Scalar SAR summation < 1.6W/kg.
 - ii) $SPLSR = (SAR1 + SAR2)^{1.5} / (\min. \text{ separation distance, mm})$, and the peak separation distance is determined from the square root of $[(x1-x2)^2 + (y1-y2)^2 + (z1-z2)^2]$, where (x1, y1, z1) and (x2, y2, z2) are the coordinates of the extrapolated peak SAR locations in the zoom scan.
 - iii) If $SPLSR \leq 0.04$, simultaneously transmission SAR measurement is not necessary.
 - iv) Simultaneously transmission SAR measurement, and the reported multi-band SAR < 1.6W/kg.
 - v) The SPLSR calculated results please refer to section 16.3



16.1 Hotspot Exposure Conditions

WWAN Band	Exposure Position	1	2	3	1+2 Summed 1g SAR (W/kg)	SPLSR	Case No	1+3 Summed 1g SAR (W/kg)	SPLSR	Case No	
		WWAN 1g SAR (W/kg)	2.4GHz WLAN 1g SAR (W/kg)	Bluetooth 1g SAR (W/kg)							
GSM	GSM1900	Front	0.590	0.624	0.301	1.21			0.89		
		Back	1.158	0.909	0.390	2.07	0.02	#01	1.55		
		Left side	0.077			0.08			0.08		
		Right side	0.072	0.460	0.263	0.53			0.34		
		Top side		0.661	0.582	0.66			0.58		
		Bottom side	1.173			1.17			1.17		
WCDMA	WCDMA II	Front	0.415	0.624	0.301	1.04			0.72		
		Back	1.162	0.909	0.390	2.07	0.02	#02	1.55		
		Left side	0.113			0.11			0.11		
		Right side	0.109	0.460	0.263	0.57			0.37		
		Top side		0.661	0.582	0.66			0.58		
		Bottom side	1.328			1.33			1.33		
	WCDMA IV	Front	0.340	0.624	0.301	0.96			0.64		
		Back	1.121	0.909	0.390	2.03	0.02	#03	1.51		
		Left side	0.015			0.02			0.02		
		Right side	0.074	0.460	0.263	0.53			0.34		
		Top side		0.661	0.582	0.66			0.58		
		Bottom side	1.231			1.23			1.23		
LTE	LTE Band 2	Front	0.483	0.624	0.301	1.11			0.78		
		Back	1.348	0.909	0.390	2.26	0.02	#04	1.74	0.01	#05
		Left side	0.100			0.10			0.10		
		Right side	0.091	0.460	0.263	0.55			0.35		
		Top side		0.661	0.582	0.66			0.58		
		Bottom side	1.201			1.20			1.20		
	LTE Band 7	Front	0.359	0.624	0.301	0.98			0.66		
		Back	1.294	0.909	0.390	2.20	0.02	#06	1.68	0.01	#07
		Left side	0.048			0.05			0.05		
		Right side	0.177	0.460	0.263	0.64			0.44		
		Top side		0.661	0.582	0.66			0.58		
		Bottom side	1.228			1.23			1.23		
	LTE Band 66	Front	0.325	0.624	0.301	0.95			0.63		
		Back	1.122	0.909	0.390	2.03	0.02	#08	1.51		
		Left side	0.013			0.01			0.01		
		Right side	0.074	0.460	0.263	0.53			0.34		
		Top side		0.661	0.582	0.66			0.58		
		Bottom side	1.133			1.13			1.13		

16.2 Body-Worn Accessory Exposure Conditions

WWAN Band		Exposure Position	1	2	3	1+2 Summed 1g SAR (W/kg)	SPLSR	Case No	1+3 Summed 1g SAR (W/kg)	SPLSR	Case No
			WWAN	2.4GHz WLAN	Bluetooth						
			1g SAR (W/kg)	1g SAR (W/kg)	1g SAR (W/kg)						
GSM	GSM1900	Front	0.590	0.624	0.301	1.21			0.89		
		Back	1.158	0.909	0.390	2.07	0.02	#01	1.55		
		Front with Headset				0.00			0.00		
		Back with Headset		0.646		0.65			0.00		
		9mm	0.517	0.205	0.301	0.72			0.82		
		19mm	0.208	0.075	0.390	0.28			0.60		
WCDMA	WCDMA II	Front	0.415	0.624	0.301	1.04			0.72		
		Back	1.162	0.909	0.390	2.07	0.02	#02	1.55		
		Front with Headset				0.00			0.00		
		Back with Headset		0.646		0.65			0.00		
		9mm	0.738	0.205	0.301	0.94			1.04		
		19mm	0.306	0.075	0.390	0.38			0.70		
	WCDMA IV	Front	0.340	0.624	0.301	0.96			0.64		
		Back	1.121	0.909	0.390	2.03	0.02	#03	1.51		
		Front with Headset				0.00			0.00		
		Back with Headset		0.646		0.65			0.00		
		9mm	1.181	0.205	0.301	1.39			1.48		
		19mm	1.081	0.075	0.390	1.16			1.47		
LTE	LTE Band 2	Front	0.483	0.624	0.301	1.11			0.78		
		Back	1.348	0.909	0.390	2.26	0.02	#04	1.74	0.01	#05
		Front with Headset				0.00			0.00		
		Back with Headset	1.231	0.646		1.88	0.01	#09	1.23		
		9mm	0.706	0.205	0.301	0.91			1.01		
		19mm	0.285	0.075	0.390	0.36			0.68		
	LTE Band 7	Front	0.359	0.624	0.301	0.98			0.66		
		Back	1.294	0.909	0.390	2.20	0.02	#06	1.68	0.01	#07
		Front with Headset				0.00			0.00		
		Back with Headset	1.226	0.646		1.87	0.01	#10	1.23		
		9mm	0.599	0.205	0.301	0.80			0.90		
		19mm	0.346	0.075	0.390	0.42			0.74		
	LTE Band 66	Front	0.325	0.624	0.301	0.95			0.63		
		Back	1.122	0.909	0.390	2.03	0.02	#08	1.51		
		Front with Headset				0.00			0.00		
		Back with Headset		0.646		0.65			0.00		
		9mm	1.074	0.205	0.301	1.28			1.38		
		19mm	0.761	0.075	0.390	0.84			1.15		

16.3 SPLSR Evaluation and Analysis

General Note:

- SPLSR = $(SAR_1 + SAR_2)^{1.5} / (\text{min. separation distance, mm})$. If $SPLSR \leq 0.04$, simultaneously transmission SAR measurement is not necessary
- The detail hotspot point for each transmitter in each exposure condition are showing as below figure and the minimum 3D distance for each sum combination is used for SPLSR analysis.

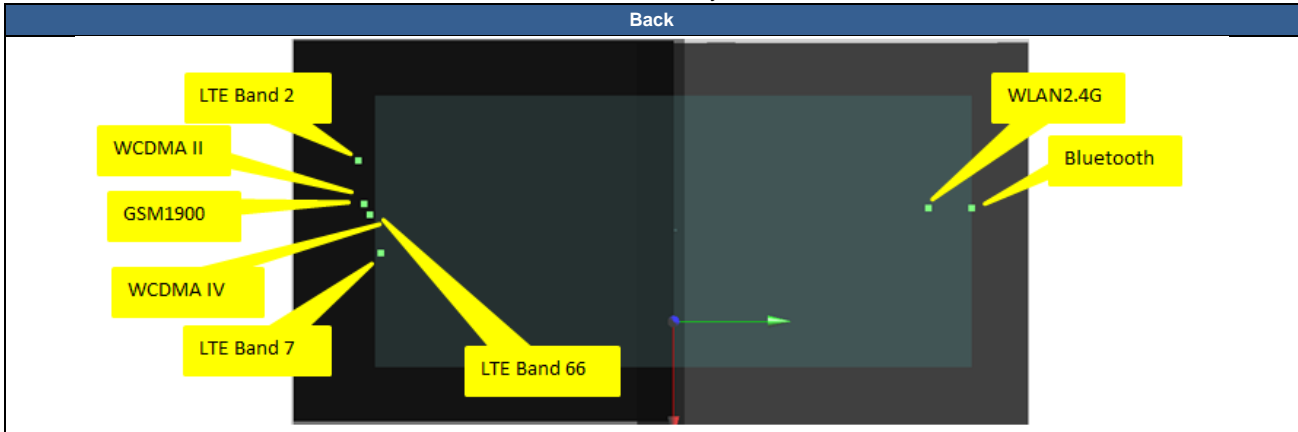

Case	Band	Position	SAR (W/kg)	Gap (mm)	SAR peak location (mm)			3D distance (mm)	Summed SAR (W/kg)	SPLSR Results	Simultaneous SAR
					X	Y	Z				
Case 1	GSM1900	Back	1.158	5mm	-12.3	-83.9	-0.91	175.0	2.07	0.02	Not required
	WLAN2.4G		0.909	5mm	-21.8	90.8	-0.9				
Case 2	WCDMA II	Back	1.162	5mm	-12.3	-83.9	-0.91	175.0	2.07	0.02	Not required
	WLAN2.4G		0.909	5mm	-21.8	90.8	-0.9				
Case 3	WCDMA IV	Back	1.121	5mm	-9.3	-82.4	-0.9	173.7	2.03	0.02	Not required
	WLAN2.4G		0.909	5mm	-21.8	90.8	-0.9				
Case 4	LTE Band 2	Back	1.348	5mm	-14.7	-83.8	-0.93	174.7	2.26	0.02	Not required
	WLAN2.4G		0.909	5mm	-21.8	90.8	-0.9				
Case 5	LTE Band 2	Back	1.348	5mm	-14.7	-83.8	-0.93	165.2	1.74	0.01	Not required
	Bluetooth		0.39	5mm	-15.34	81.41	-1.1				
Case 6	LTE Band 7	Back	1.294	5mm	9	-82	-0.67	175.5	2.20	0.02	Not required
	WLAN2.4G		0.909	5mm	-21.8	90.8	-0.9				



Case 7	Band	Position	SAR (W/kg)	Gap (mm)	SAR peak location (mm)			3D distance (mm)	Summed SAR (W/kg)	SPLSR Results	Simultaneous SAR
	LTE Band 7				X	Y	Z				
		Back	1.294	5mm	9	-82	-0.67	165.2	1.68	0.01	Not required
			0.39	5mm							

Case 8	Band	Position	SAR (W/kg)	Gap (mm)	SAR peak location (mm)			3D distance (mm)	Summed SAR (W/kg)	SPLSR Results	Simultaneous SAR
	LTE Band 66				X	Y	Z				
		Back	1.122	5mm	-10.8	-84.2	-0.89	175.3	2.03	0.02	Not required
			0.909	5mm							

Case 9	Band	Position	SAR (W/kg)	Gap (mm)	SAR peak location (mm)			3D distance (mm)	Summed SAR (W/kg)	SPLSR Results	Simultaneous SAR
	LTE Band 2				X	Y	Z				
		Back Headset	1.231	5mm	-12.4	-83.5	-0.91	174.6	1.88	0.01	Not required
			0.646	5mm							

Case 10	Band	Position	SAR (W/kg)	Gap (mm)	SAR peak location (mm)			3D distance (mm)	Summed SAR (W/kg)	SPLSR Results	Simultaneous SAR
	LTE Band 7				X	Y	Z				
		Back Headset	1.226	5mm	9.2	-82.1	-0.67	175.7	1.87	0.01	Not required
			0.646	5mm							

Test Engineer : Nick Hu, Yuan Zhao



17. Uncertainty Assessment

Per KDB 865664 D01 SAR measurement 100MHz to 6GHz, when the highest measured 1-g SAR within a frequency band is < 1.5 W/kg and the measured 10-g SAR within a frequency band is < 3.75 W/kg. The expanded SAR measurement uncertainty must be $\leq 30\%$, for a confidence interval of $k = 2$. If these conditions are met, extensive SAR measurement uncertainty analysis described in IEEE Std 1528-2013 is not required in SAR reports submitted for equipment approval. For this device, the highest measured 1-g SAR is less 1.5W/kg and highest measured 10-g SAR is less 3.75W/kg . Therefore, the measurement uncertainty table is not required in this report.



18. References

- [1] FCC 47 CFR Part 2 "Frequency Allocations and Radio Treaty Matters; General Rules and Regulations"
- [2] ANSI/IEEE Std. C95.1-1992, "IEEE Standard for Safety Levels with Respect to Human Exposure to Radio Frequency Electromagnetic Fields, 3 kHz to 300 GHz", September 1992
- [3] IEEE Std. 1528-2013, "IEEE Recommended Practice for Determining the Peak Spatial-Average Specific Absorption Rate (SAR) in the Human Head from Wireless Communications Devices: Measurement Techniques", Sep 2013
- [4] SPEAG DASY System Handbook
- [5] FCC KDB 248227 D01 v02r02, "SAR Guidance for IEEE 802.11 (WiFi) Transmitters", Oct 2015.
- [6] FCC KDB 447498 D01 v06, "Mobile and Portable Device RF Exposure Procedures and Equipment Authorization Policies", Oct 2015
- [7] FCC KDB 648474 D04 v01r03, "SAR Evaluation Considerations for Wireless Handsets", Oct 2015.
- [8] FCC KDB 941225 D01 v03r01, "3G SAR MEAUREMENT PROCEDURES", Oct 2015
- [9] FCC KDB 941225 D05 v02r05, "SAR Evaluation Considerations for LTE Devices", Dec 2015
- [10] FCC KDB 941225 D06 v02r01, "SAR Evaluation Procedures for Portable Devices with Wireless Router Capabilities", Oct 2015.
- [11] FCC KDB 941225 D07 v01r02, " SAR Evaluation Procedures for UMPC Mini-Tablet Devices", Oct 2015.
- [12] FCC KDB 865664 D01 v01r04, "SAR Measurement Requirements for 100 MHz to 6 GHz", Aug 2015.
- [13] FCC KDB 865664 D02 v01r02, "RF Exposure Compliance Reporting and Documentation Considerations" Oct 2015.



Appendix A. Plots of System Performance Check

The plots are shown as follows.

System Check_Head_1750MHz

DUT: D1750V2 - SN:1090

Communication System: UID 0, CW (0); Frequency: 1750 MHz; Duty Cycle: 1:1
Medium: HSL_1750 Medium parameters used: $f = 1750$ MHz; $\sigma = 1.351$ S/m; $\epsilon_r = 40.38$; $\rho = 1000$ kg/m³

Ambient Temperature : 23.3 °C; Liquid Temperature : 22.7 °C

DASY5 Configuration:

- Probe: ES3DV3 - SN3166; ConvF(5.35, 5.35, 5.35); Calibrated: 2020.3.2
- Sensor-Surface: 3mm (Mechanical Surface Detection)
- Electronics: DAE4 Sn1338; Calibrated: 2019.11.20
- Phantom: SAM1; Type: SAM; Serial: TP-1753
- Measurement SW: DASY52, Version 52.10 (4); SEMCAD X Version 14.6.14 (7483)

Pin=250mW/Area Scan (61x61x1): Interpolated grid: dx=1.500 mm, dy=1.500 mm
Maximum value of SAR (interpolated) = 11.6 W/kg

Pin=250mW/Zoom Scan (5x5x7)/Cube 0: Measurement grid: dx=8mm, dy=8mm, dz=5mm

Reference Value = 96.31 V/m; Power Drift = 0.05 dB

Peak SAR (extrapolated) = 16.9 W/kg

SAR(1 g) = 9.27 W/kg; SAR(10 g) = 4.88 W/kg

Maximum value of SAR (measured) = 11.6 W/kg

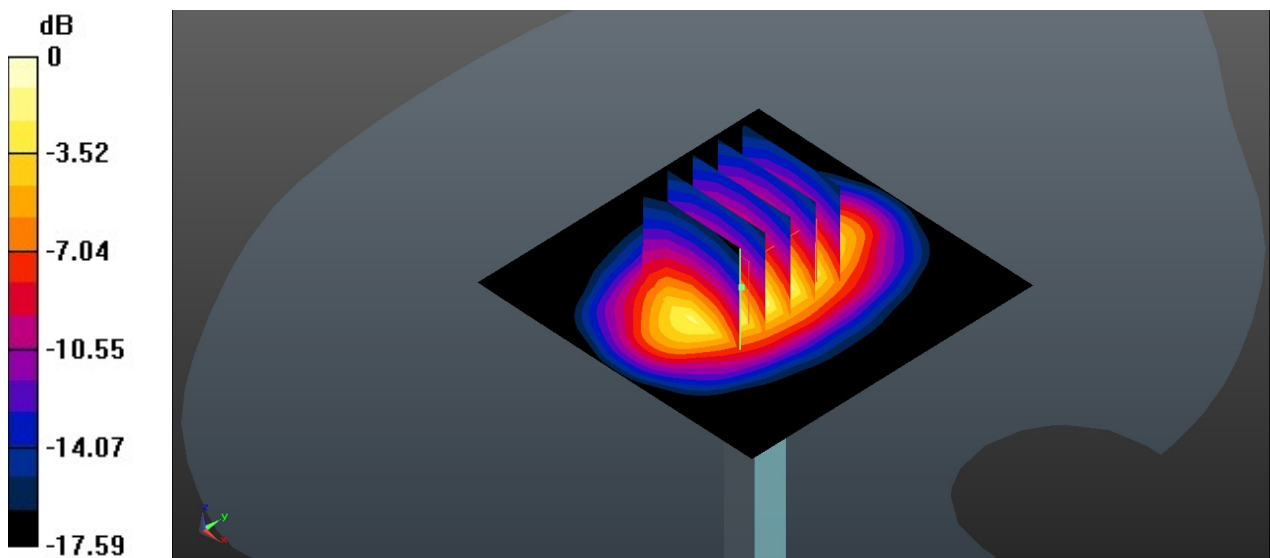

0 dB = 11.6 W/kg = 10.64 dBW/kg

System Check_Head_1900MHz

DUT: D1900V2 - SN:5d170

Communication System: UID 0, CW (0); Frequency: 1900 MHz; Duty Cycle: 1:1
Medium: HSL_1900 Medium parameters used: $f = 1900$ MHz; $\sigma = 1.451$ S/m; $\epsilon_r = 39.63$; $\rho = 1000$ kg/m³

Ambient Temperature : 23.2 °C; Liquid Temperature : 22.8 °C

DASY5 Configuration:

- Probe: ES3DV3 - SN3166; ConvF(5.16, 5.16, 5.16); Calibrated: 2020.3.2
- Sensor-Surface: 3mm (Mechanical Surface Detection)
- Electronics: DAE4 Sn1338; Calibrated: 2019.11.20
- Phantom: SAM1; Type: SAM; Serial: TP-1753
- Measurement SW: DASY52, Version 52.10 (4); SEMCAD X Version 14.6.14 (7483)

Pin=250mW/Area Scan (61x61x1): Interpolated grid: dx=1.500 mm, dy=1.500 mm
Maximum value of SAR (interpolated) = 12.8 W/kg

Pin=250mW/Zoom Scan (5x5x7)/Cube 0: Measurement grid: dx=8mm, dy=8mm, dz=5mm
Reference Value = 99.24 V/m; Power Drift = -0.12 dB
Peak SAR (extrapolated) = 18.4 W/kg
SAR(1 g) = 10 W/kg; SAR(10 g) = 5.2 W/kg
Maximum value of SAR (measured) = 12.8 W/kg

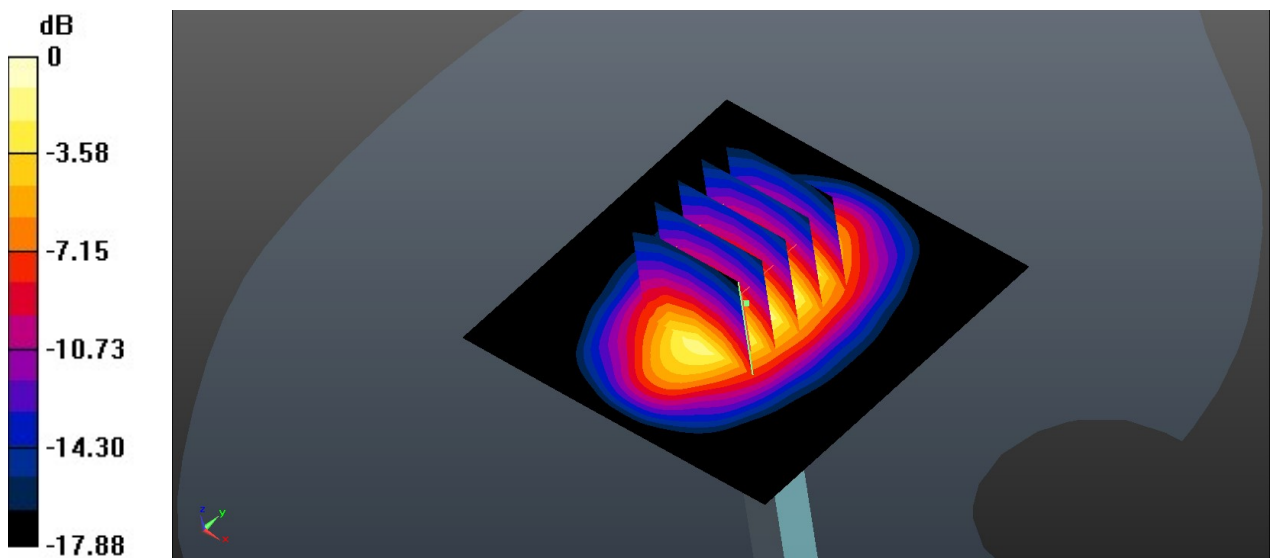

0 dB = 12.8 W/kg = 11.07 dBW/kg

System Check_Head_2450MHz

DUT: D2450V2 - SN:908

Communication System: UID 0, CW (0); Frequency: 2450 MHz;Duty Cycle: 1:1
Medium: HSL_2450 Medium parameters used: $f = 2450$ MHz; $\sigma = 1.853$ S/m; $\epsilon_r = 39.08$; $\rho = 1000$ kg/m³

Ambient Temperature : 23.2 °C; Liquid Temperature : 22.9 °C

DASY5 Configuration:

- Probe: ES3DV3 - SN3166; ConvF(4.76, 4.76, 4.76); Calibrated: 2020.3.2
- Sensor-Surface: 3mm (Mechanical Surface Detection)
- Electronics: DAE4 Sn1338; Calibrated: 2019.11.20
- Phantom: SAM1; Type: SAM; Serial: TP-1753
- Measurement SW: DASY52, Version 52.10 (4); SEMCAD X Version 14.6.14 (7483)

Pin=250mW/Area Scan (71x71x1): Interpolated grid: dx=1.200 mm, dy=1.200 mm
Maximum value of SAR (interpolated) = 18.0 W/kg

Pin=250mW/Zoom Scan (7x7x7)/Cube 0: Measurement grid: dx=5mm, dy=5mm, dz=5mm
Reference Value = 97.17 V/m; Power Drift = -0.01 dB
Peak SAR (extrapolated) = 28.0 W/kg
SAR(1 g) = 13.2 W/kg; SAR(10 g) = 5.99 W/kg
Maximum value of SAR (measured) = 17.3 W/kg

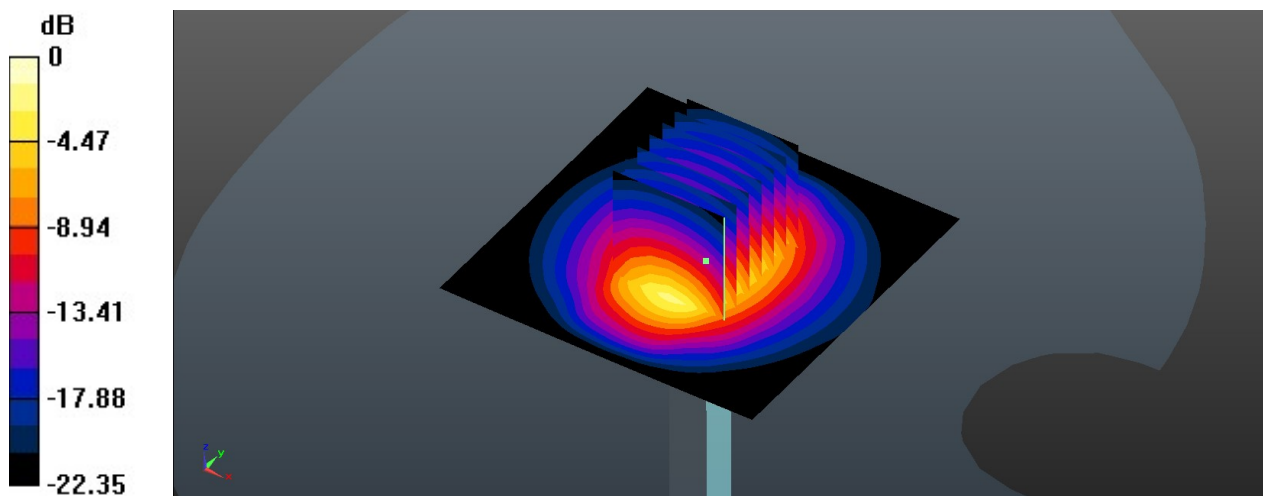

0 dB = 17.3 W/kg = 12.38 dBW/kg

System Check_Head_2600MHz

DUT: D2600V2 - SN:1061

Communication System: UID 0, CW (0); Frequency: 2600 MHz; Duty Cycle: 1:1

Medium: HSL_2600 Medium parameters used: $f = 2600$ MHz; $\sigma = 1.978$ S/m; $\epsilon_r = 39.041$; $\rho = 1000$ kg/m³

Ambient Temperature : 23.4 °C; Liquid Temperature : 22.6 °C

DASY5 Configuration:

- Probe: ES3DV3 - SN3166; ConvF(4.63, 4.63, 4.63); Calibrated: 2020.3.2
- Sensor-Surface: 3mm (Mechanical Surface Detection)
- Electronics: DAE4 Sn1338; Calibrated: 2019.11.20
- Phantom: SAM1; Type: SAM; Serial: TP-1753
- Measurement SW: DASY52, Version 52.10 (4); SEMCAD X Version 14.6.14 (7483)

Pin=250mW/Area Scan (71x71x1): Interpolated grid: dx=1.200 mm, dy=1.200 mm

Maximum value of SAR (interpolated) = 21.7 W/kg

Pin=250mW/Zoom Scan (7x7x7)/Cube 0: Measurement grid: dx=5mm, dy=5mm, dz=5mm

Reference Value = 101.5 V/m; Power Drift = -0.01 dB

Peak SAR (extrapolated) = 36.5 W/kg

SAR(1 g) = 15.4 W/kg; SAR(10 g) = 6.68 W/kg

Maximum value of SAR (measured) = 20.8 W/kg

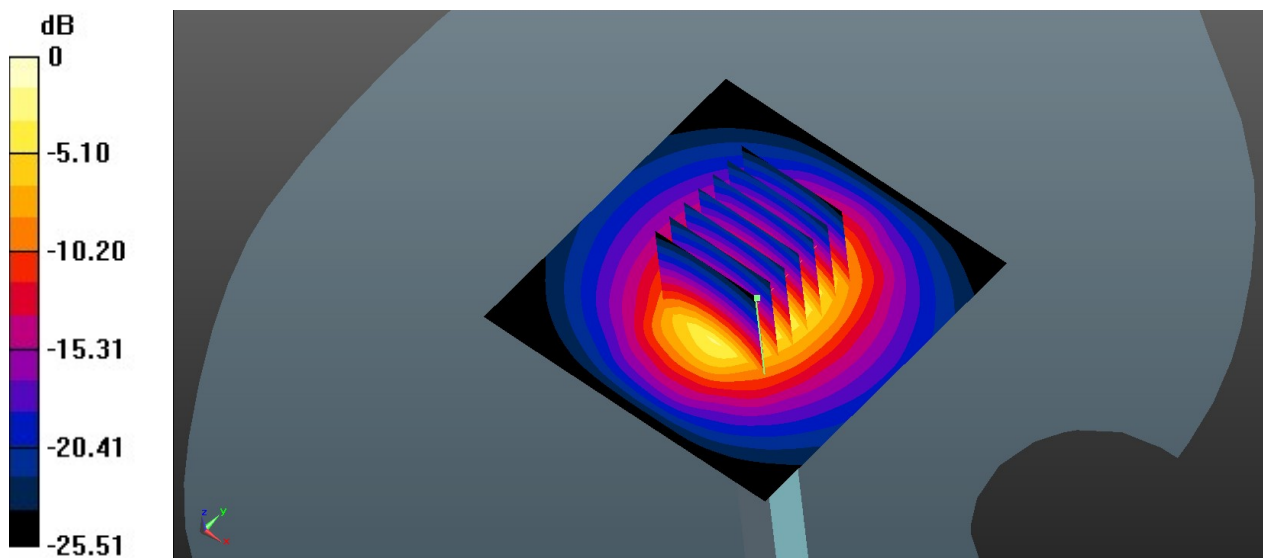

0 dB = 20.8 W/kg = 13.18 dBW/kg



Appendix B. Plots of SAR Measurement

The plots are shown as follows.

01_GSM1900_GPRS 4 Tx slots_Bottom Side_5mm_Ch810

Communication System: UID 0, GSM 4Tx slots (0); Frequency: 1909.8 MHz; Duty Cycle: 1:2.08
 Medium: HSL_1900 Medium parameters used: $f = 1910$ MHz; $\sigma = 1.458$ S/m; $\epsilon_r = 39.628$; $\rho = 1000$ kg/m³

Ambient Temperature : 23.2 °C; Liquid Temperature : 22.8 °C

DASY5 Configuration:

- Probe: ES3DV3 - SN3166; ConvF(5.16, 5.16, 5.16); Calibrated: 2020.3.2
- Sensor-Surface: 3mm (Mechanical Surface Detection)
- Electronics: DAE4 Sn1338; Calibrated: 2019.11.20
- Phantom: SAM1; Type: SAM; Serial: TP-1753
- Measurement SW: DASY52, Version 52.10 (4); SEMCAD X Version 14.6.14 (7483)

Area Scan (41x81x1): Interpolated grid: dx=1.500 mm, dy=1.500 mm
 Maximum value of SAR (interpolated) = 1.34 W/kg

Zoom Scan (5x5x7)/Cube 0: Measurement grid: dx=8mm, dy=8mm, dz=5mm
 Reference Value = 24.94 V/m; Power Drift = -0.17 dB
 Peak SAR (extrapolated) = 1.94 W/kg
SAR(1 g) = 0.976 W/kg; SAR(10 g) = 0.441 W/kg
 Maximum value of SAR (measured) = 1.32 W/kg

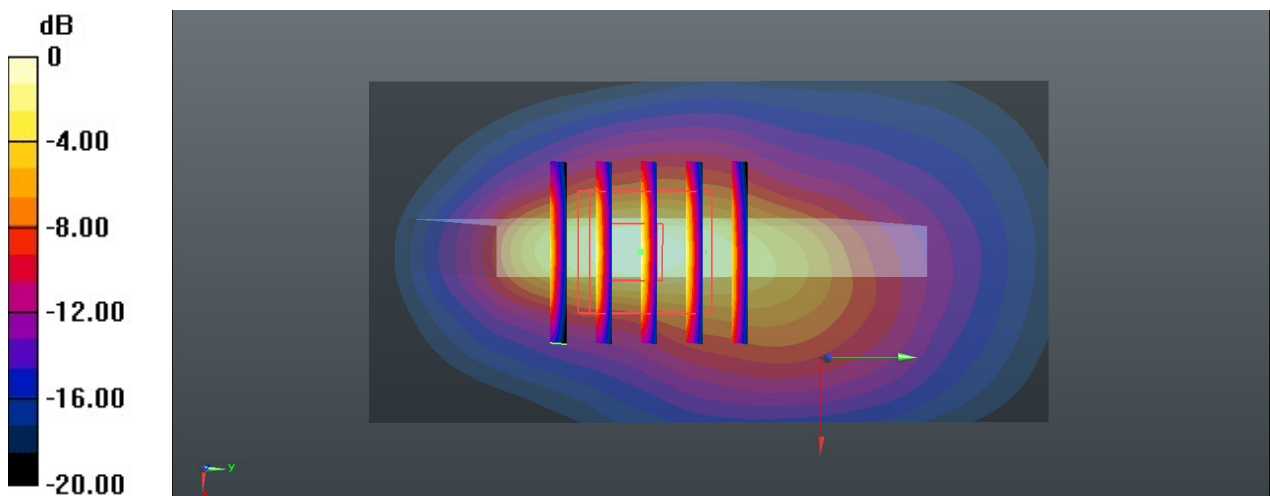

0 dB = 1.32 W/kg = 1.21 dBW/kg

02_WCDMA II_RMC 12.2Kbps_Bottom Side_5mm_Ch9262

Communication System: UID 0, WCDMA (0); Frequency: 1852.4 MHz; Duty Cycle: 1:1
 Medium: HSL_1900 Medium parameters used: $f = 1852.4$ MHz; $\sigma = 1.423$ S/m; $\epsilon_r = 39.673$; $\rho = 1000$ kg/m³

Ambient Temperature : 23.2 °C; Liquid Temperature : 22.8 °C

DASY5 Configuration:

- Probe: ES3DV3 - SN3166; ConvF(5.16, 5.16, 5.16); Calibrated: 2020.3.2
- Sensor-Surface: 3mm (Mechanical Surface Detection)
- Electronics: DAE4 Sn1338; Calibrated: 2019.11.20
- Phantom: SAM1; Type: SAM; Serial: TP-1753
- Measurement SW: DASY52, Version 52.10 (4); SEMCAD X Version 14.6.14 (7483)

Area Scan (41x81x1): Interpolated grid: dx=1.500 mm, dy=1.500 mm
 Maximum value of SAR (interpolated) = 1.44 W/kg

Zoom Scan (5x5x7)/Cube 0: Measurement grid: dx=8mm, dy=8mm, dz=5mm
 Reference Value = 26.72 V/m; Power Drift = -0.08 dB
 Peak SAR (extrapolated) = 2.13 W/kg
SAR(1 g) = 1.05 W/kg; SAR(10 g) = 0.479 W/kg
 Maximum value of SAR (measured) = 1.41 W/kg

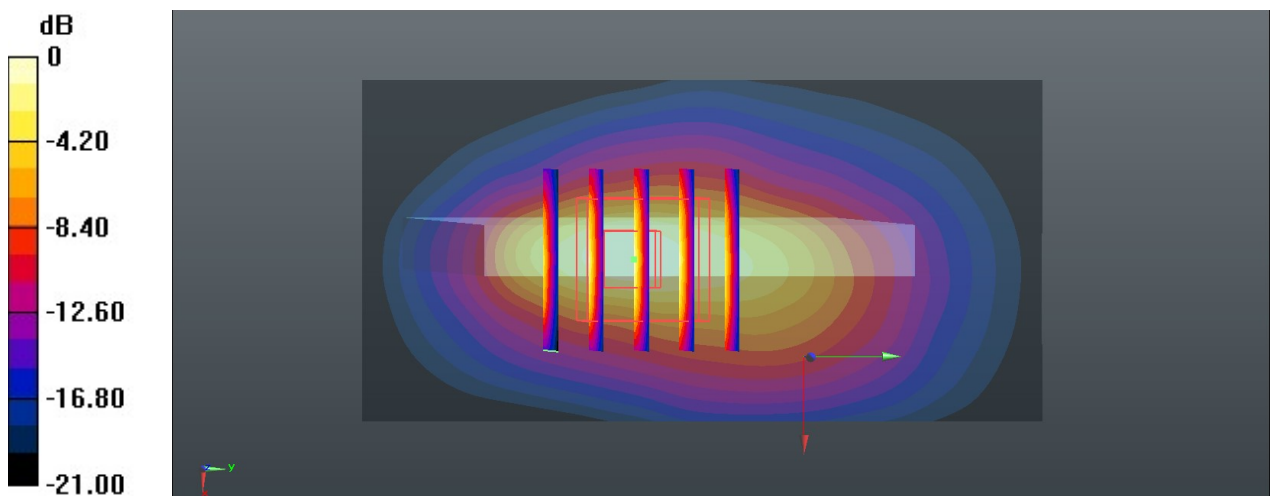

0 dB = 1.41 W/kg = 1.49 dBW/kg

03_WCDMA IV_RMC 12.2Kbps_Bottom Side_5mm_Ch1513

Communication System: UID 0, WCDMA (0); Frequency: 1752.6 MHz; Duty Cycle: 1:1
 Medium: HSL_1750 Medium parameters used: $f = 1753$ MHz; $\sigma = 1.354$ S/m; $\epsilon_r = 40.367$; $\rho = 1000$ kg/m³

Ambient Temperature : 23.3 °C; Liquid Temperature : 22.7 °C

DASY5 Configuration:

- Probe: ES3DV3 - SN3166; ConvF(5.35, 5.35, 5.35); Calibrated: 2020.3.2
- Sensor-Surface: 3mm (Mechanical Surface Detection)
- Electronics: DAE4 Sn1338; Calibrated: 2019.11.20
- Phantom: SAM1; Type: SAM; Serial: TP-1753
- Measurement SW: DASY52, Version 52.10 (4); SEMCAD X Version 14.6.14 (7483)

Area Scan (41x81x1): Interpolated grid: dx=1.500 mm, dy=1.500 mm
 Maximum value of SAR (interpolated) = 1.46 W/kg

Zoom Scan (5x5x7)/Cube 0: Measurement grid: dx=8mm, dy=8mm, dz=5mm
 Reference Value = 29.45 V/m; Power Drift = -0.02 dB
 Peak SAR (extrapolated) = 2.11 W/kg
SAR(1 g) = 1.05 W/kg; SAR(10 g) = 0.489 W/kg
 Maximum value of SAR (measured) = 1.36 W/kg

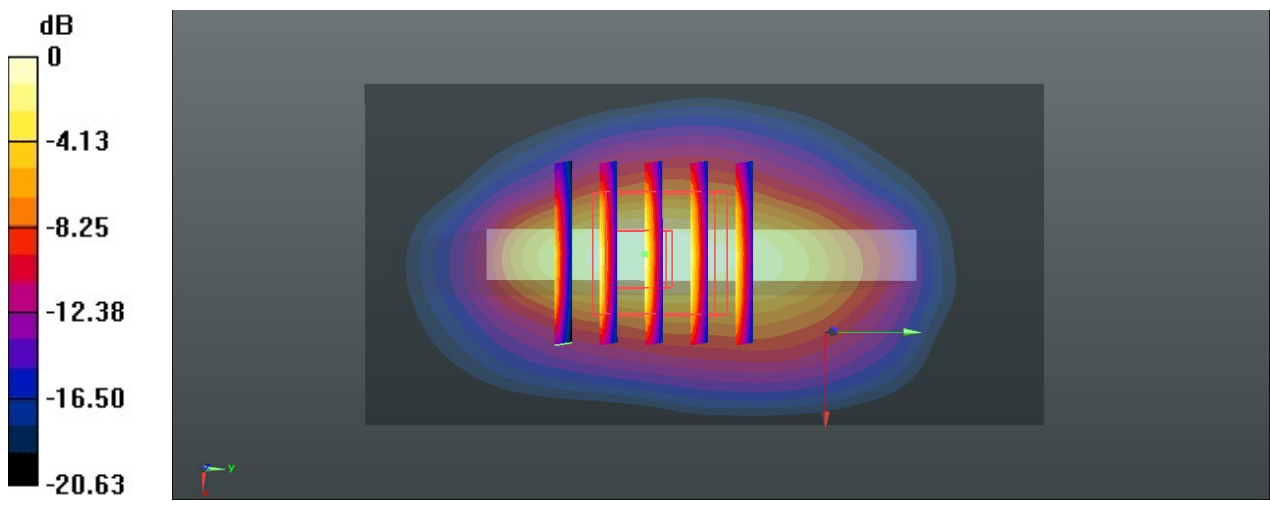

0 dB = 1.36 W/kg = 1.34 dBW/kg

04_LTE Band 2_20M_QPSK_50RB_0Offset_Back_5mm_Ch18700

Communication System: UID 0, LTE FDD (0); Frequency: 1860 MHz; Duty Cycle: 1:1
Medium: HSL_1900 Medium parameters used: $f = 1860$ MHz; $\sigma = 1.428$ S/m; $\epsilon_r = 39.666$; $\rho = 1000$ kg/m³

Ambient Temperature : 23.2 °C; Liquid Temperature : 22.8 °C

DASY5 Configuration:

- Probe: ES3DV3 - SN3166; ConvF(5.16, 5.16, 5.16); Calibrated: 2020.3.2
- Sensor-Surface: 3mm (Mechanical Surface Detection)
- Electronics: DAE4 Sn1338; Calibrated: 2019.11.20
- Phantom: SAM1; Type: SAM; Serial: TP-1753
- Measurement SW: DASY52, Version 52.10 (4); SEMCAD X Version 14.6.14 (7483)

Area Scan (71x71x1): Interpolated grid: dx=1.500 mm, dy=1.500 mm
Maximum value of SAR (interpolated) = 1.44 W/kg

Zoom Scan (5x5x7)/Cube 0: Measurement grid: dx=8mm, dy=8mm, dz=5mm
Reference Value = 7.536 V/m; Power Drift = 0.01 dB
Peak SAR (extrapolated) = 2.28 W/kg
SAR(1 g) = 1.15 W/kg; SAR(10 g) = 0.534 W/kg
Maximum value of SAR (measured) = 1.48 W/kg

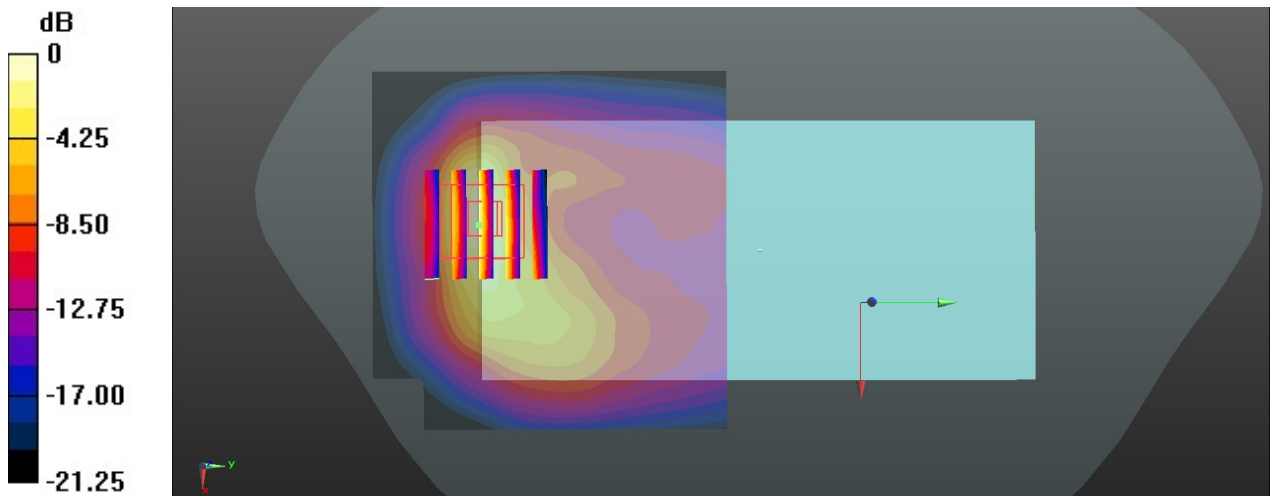

0 dB = 1.48 W/kg = 1.70 dBW/kg

05_LTE Band 7_20M_QPSK_1RB_0Offset_Back_5mm_Ch20850

Communication System: UID 0, LTE FDD (0); Frequency: 2510 MHz; Duty Cycle: 1:1
Medium: HSL_2600 Medium parameters used: $f = 2510$ MHz; $\sigma = 1.898$ S/m; $\epsilon_r = 39.12$; $\rho = 1000$ kg/m³

Ambient Temperature : 23.4 °C; Liquid Temperature : 22.6 °C

DASY5 Configuration:

- Probe: ES3DV3 - SN3166; ConvF(4.63, 4.63, 4.63); Calibrated: 2020.3.2
- Sensor-Surface: 3mm (Mechanical Surface Detection)
- Electronics: DAE4 Sn1338; Calibrated: 2019.11.20
- Phantom: SAM1; Type: SAM; Serial: TP-1753
- Measurement SW: DASY52, Version 52.10 (4); SEMCAD X Version 14.6.14 (7483)

Area Scan (91x81x1): Interpolated grid: dx=1.200 mm, dy=1.200 mm
Maximum value of SAR (interpolated) = 1.66 W/kg

Zoom Scan (7x7x7)/Cube 0: Measurement grid: dx=5mm, dy=5mm, dz=5mm
Reference Value = 3.115 V/m; Power Drift = 0.08 dB
Peak SAR (extrapolated) = 2.85 W/kg
SAR(1 g) = 1.14 W/kg; SAR(10 g) = 0.450 W/kg
Maximum value of SAR (measured) = 1.62 W/kg

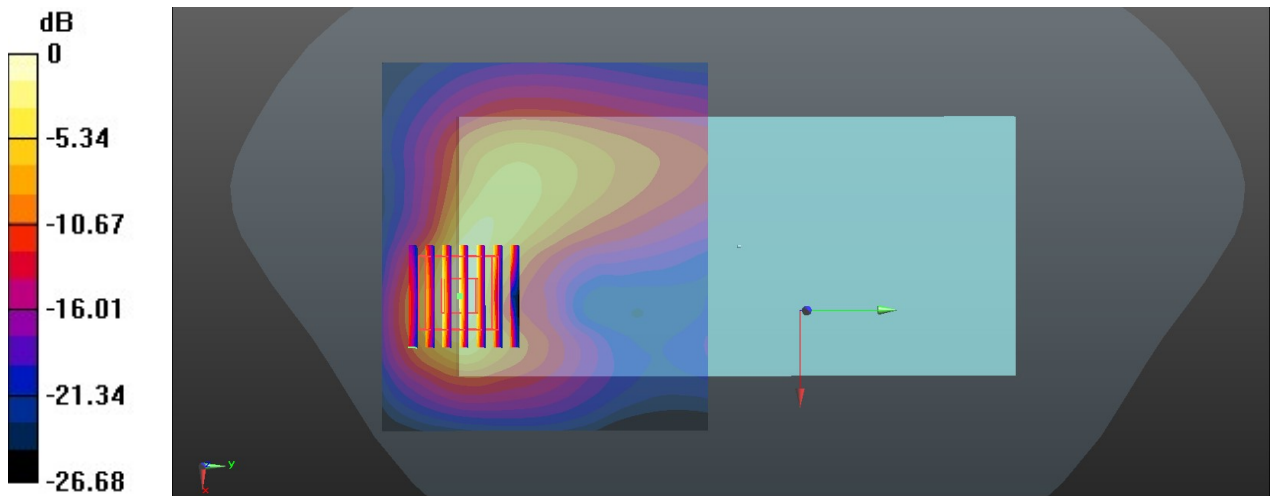

0 dB = 1.62 W/kg = 2.10 dBW/kg

06_LTE Band 66_20M_QPSK_50RB_0Offset_Bottom Side_5mm_Ch132322

Communication System: UID 0, LTE FDD (0); Frequency: 1745 MHz; Duty Cycle: 1:1
 Medium: HSL_1750 Medium parameters used: $f = 1745$ MHz; $\sigma = 1.345$ S/m; $\epsilon_r = 40.397$; $\rho = 1000$ kg/m³
 Ambient Temperature : 23.3 °C; Liquid Temperature : 22.7 °C

DASY5 Configuration:

- Probe: ES3DV3 - SN3166; ConvF(5.35, 5.35, 5.35); Calibrated: 2020.3.2
- Sensor-Surface: 3mm (Mechanical Surface Detection)
- Electronics: DAE4 Sn1338; Calibrated: 2019.11.20
- Phantom: SAM1; Type: SAM; Serial: TP-1753
- Measurement SW: DASY52, Version 52.10 (4); SEMCAD X Version 14.6.14 (7483)

Area Scan (41x81x1): Interpolated grid: dx=1.500 mm, dy=1.500 mm
 Maximum value of SAR (interpolated) = 1.40 W/kg

Zoom Scan (5x5x7)/Cube 0: Measurement grid: dx=8mm, dy=8mm, dz=5mm
 Reference Value = 28.53 V/m; Power Drift = 0.06 dB
 Peak SAR (extrapolated) = 1.91 W/kg
SAR(1 g) = 0.969 W/kg; SAR(10 g) = 0.466 W/kg
 Maximum value of SAR (measured) = 1.25 W/kg

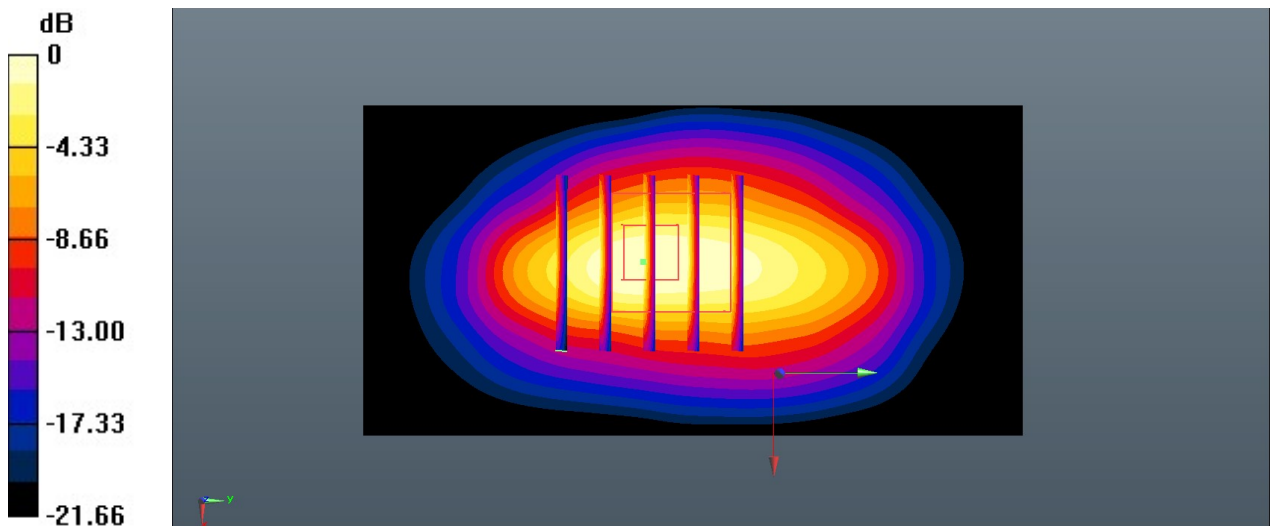

0 dB = 1.25 W/kg = 0.97 dBW/kg

07_GSM1900_GPRS 4 Tx slots_Back_5mm_Ch810

Communication System: UID 0, GSM 4Tx slots (0); Frequency: 1909.8 MHz; Duty Cycle: 1:2.08
 Medium: HSL_1900 Medium parameters used: $f = 1910$ MHz; $\sigma = 1.458$ S/m; $\epsilon_r = 39.628$; $\rho = 1000$ kg/m³

Ambient Temperature : 23.2 °C; Liquid Temperature : 22.8 °C

DASY5 Configuration:

- Probe: ES3DV3 - SN3166; ConvF(5.16, 5.16, 5.16); Calibrated: 2020.3.2
- Sensor-Surface: 3mm (Mechanical Surface Detection)
- Electronics: DAE4 Sn1338; Calibrated: 2019.11.20
- Phantom: SAM1; Type: SAM; Serial: TP-1753
- Measurement SW: DASY52, Version 52.10 (4); SEMCAD X Version 14.6.14 (7483)

Area Scan (71x81x1): Interpolated grid: dx=1.500 mm, dy=1.500 mm
 Maximum value of SAR (interpolated) = 1.08 W/kg

Zoom Scan (5x5x7)/Cube 0: Measurement grid: dx=8mm, dy=8mm, dz=5mm
 Reference Value = 7.343 V/m; Power Drift = 0.05 dB
 Peak SAR (extrapolated) = 1.61 W/kg
SAR(1 g) = 0.818 W/kg; SAR(10 g) = 0.380 W/kg
 Maximum value of SAR (measured) = 1.09 W/kg

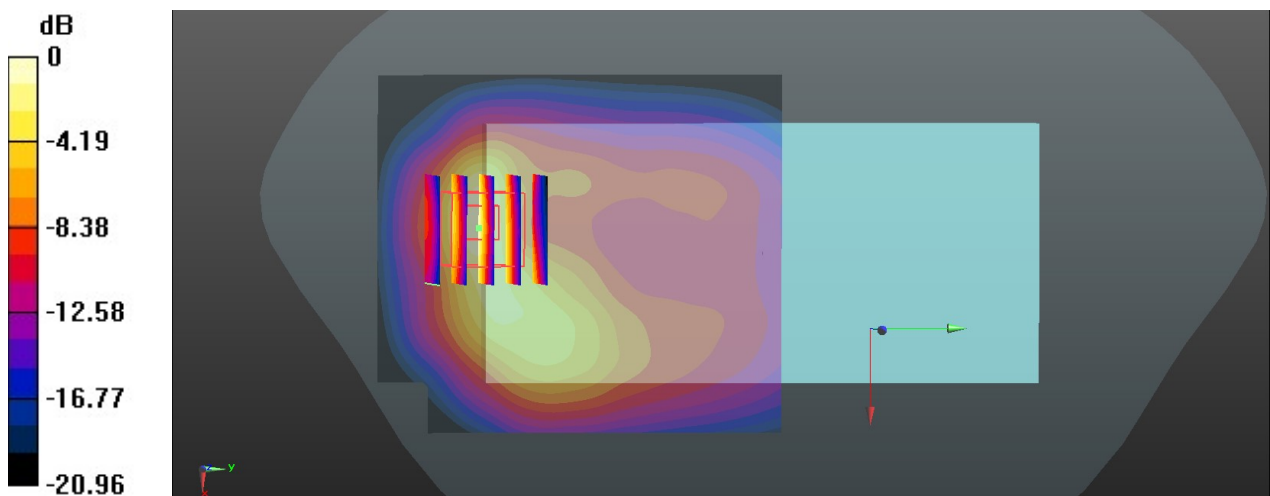

0 dB = 1.09 W/kg = 0.37 dBW/kg