



FCC RADIO TEST REPORT

FCC ID : IHDT56YU2
Equipment : Mobile Cellular Phone
Brand Name : Motorola
Model Name : XT2063-3
Applicant : Motorola Mobility, LLC
222 W Merchandise Mart Plaza, Suite 1800,
Chicago, IL 60654, United States
Manufacturer : Motorola Mobility, LLC
222 W Merchandise Mart Plaza, Suite 1800,
Chicago, IL 60654, United States
Standard : FCC 47 CFR Part 2, and 90(S)

The product was received on Jan. 30, 2020 and testing was started from Feb. 10, 2020 and completed on Mar. 12, 2020. We, SPORTON INTERNATIONAL INC. EMC & Wireless Communications Laboratory, would like to declare that the tested sample has been evaluated in accordance with the test procedures given in ANSI / TIA-603-E and has been in compliance with the applicable technical standards.

The report must not be used by the client to claim product certification, approval, or endorsement by TAF or any agency of government.

The test results in this report apply exclusively to the tested model / sample. Without written approval of SPORTON INTERNATIONAL INC. EMC & Wireless Communications Laboratory, the test report shall not be reproduced except in full.

Louis Wu

Approved by: Louis Wu

SPORTON INTERNATIONAL INC. EMC & Wireless Communications Laboratory
No. 52, Huaya 1st Rd., Guishan Dist., Taoyuan City, Taiwan (R.O.C.)



Table of Contents

History of this test report.....3
Summary of Test Result.....4
1 General Description5
1.1 Feature of Equipment Under Test.....5
1.2 Product Specification of Equipment Under Test6
1.3 Modification of EUT6
1.4 Emission Designator7
1.5 Testing Site7
1.6 Applied Standards8
2 Test Configuration of Equipment Under Test9
2.1 Test Mode.....9
2.2 Connection Diagram of Test System10
2.3 Support Unit used in test configuration and system.....10
2.4 Measurement Results Explanation Example10
2.5 Frequency List of Low/Middle/High Channels.....11
3 Conducted Test Items.....12
3.1 Measuring Instruments.....12
3.2 Conducted Output Power Measurement and ERP Measurement13
3.3 Peak-to-Average Ratio14
3.4 99% Occupied Bandwidth and 26dB Bandwidth Measurement.....15
3.5 Emissions Mask Measurement16
3.6 Emissions Mask – Out Of Band Emissions Measurement.....17
3.7 Frequency Stability Measurement.....18
3.8 Field Strength of Spurious Radiation Measurement19
4 List of Measuring Equipment.....22
5 Uncertainty of Evaluation.....24
Appendix A. Test Results of Conducted Test
Appendix B. Test Results of ERP and Radiated Test



History of this test report

Report No.	Version	Description	Issued Date
FG012201C	01	Initial issue of report	Apr. 10, 2020



Summary of Test Result

Report Clause	Ref Std. Clause	Test Items	Result (PASS/FAIL)	Remark
3.2	§2.1046 §90.635	Conducted Output Power and Effective Radiated Power	Pass	-
3.3	-	Peak-to-Average Ratio	Reporting only	-
3.4	§2.1049 §90.209	Occupied Bandwidth and 26dB Bandwidth	Reporting only	-
3.5	§2.1051 §90.691	Emission masks – In-band emissions	Pass	-
3.6	§2.1051 §90.691	Emission masks – Out of band emissions	Pass	-
3.7	§2.1055 §90.213	Frequency Stability for Temperature & Voltage	Pass	-
3.8	§2.1053 §90.691	Field Strength of Spurious Radiation	Pass	Under limit 30.47 dB at 2458.000 MHz

Declaration of Conformity:

The test results with all measurement uncertainty excluded are presented in accordance with the regulation limits or requirements declared by manufacturers.

Comments and Explanations:

The declared of product specification for EUT presented in the report are provided by the manufacturer, and the manufacturer takes all the responsibilities for the accuracy of product specification.

Reviewed by: Wii Chang

Report Producer: Ann Lee



1 General Description

1.1 Feature of Equipment Under Test

Product Feature	
Equipment	Mobile Cellular Phone
Brand Name	Motorola
Model Name	XT2063-3
FCC ID	IHDT56YU2
IMEI Code	Conducted : IMEI : 353585110016535 IMEI : 353585110016543 Radiation : IMEI : 353585110016733 IMEI : 353585110016741
EUT supports Radios application	GSM/EGPRS/WCDMA/HSPA/LTE/GNSS/NFC/FM WLAN 11b/g/n HT20 WLAN 11a/n HT20/HT40 WLAN 11ac VHT20/VHT40/VHT80 Bluetooth BR/EDR/LE
HW Version	DVT2
EUT Stage	Identical Prototype

Remark: The above EUT's information was declared by manufacturer.

Accessory List	
AC Adapter 1 (US)	Brand Name : Motorola
	Model Name : SC-51
	Manufacturer : Chenyang
AC Adapter 1 (EU)	Brand Name : Motorola
	Model Name : SC-52
	Manufacturer : Chenyang
AC Adapter 1 (UK)	Brand Name : Motorola
	Model Name : SC-53UK
	Manufacturer : Chenyang
AC Adapter 1 (AU)	Brand Name : Motorola
	Model Name : SC-55AU
	Manufacturer : Chenyang
AC Adapter 1 (AR)	Brand Name : Motorola
	Model Name : SC-56
	Manufacturer : Chenyang
AC Adapter 2 (US)	Brand Name : Motorola
	Model Name : SC-51
	Manufacturer : Acbel
AC Adapter 2 (EU)	Brand Name : Motorola
	Model Name : SC-52
	Manufacturer : Acbel
AC Adapter 2 (AR)	Brand Name : Motorola
	Model Name : SC-56
	Manufacturer : Acbel

Accessory List	
AC Adapter 3 (Chile)	Brand Name : Motorola
	Model Name : SC-52
	Manufacturer : Salom
AC Adapter 3 (BR)	Brand Name : Motorola
	Model Name : SC-57
	Manufacturer : Salom
AC Adapter 3 (BR Local Build)	Brand Name : Motorola
	Model Name : SC-57
	Manufacturer : Flex/Salom
AC Adapter 4 (IN)	Brand Name : Motorola
	Model Name : SC-54
	Manufacturer : Salom
AC Adapter 5 (BR Local Build)	Brand Name : Motorola
	Model Name : SC-57
	Manufacturer : Cliptech/Tenpao
Battery	Brand Name : ATL
	Model Name : LR50
Earphone 1	Brand Name : Motorola
	Model Name : SH38C37773
Earphone 2	Brand Name : Motorola
	Model Name : SH38C44959
USB Cable 1	Brand Name : Motorola
	Model Name : SC18C24367
	Manufacturer : Saibao
USB Cable 2	Brand Name : Motorola
	Model Name : SC18C24368
	Manufacturer : Luxshare
USB Cable 3	Brand Name : Motorola
	Model Name : SC18C28955
	Manufacturer : I SHENG

1.2 Product Specification of Equipment Under Test

Product Specification subjective to this standard	
Tx Frequency	LTE Band 26 : 814.7 ~ 823.3 MHz
Rx Frequency	LTE Band 26 : 859.7 ~ 868.3 MHz
Bandwidth	1.4MHz / 3MHz / 5MHz / 10MHz / 15MHz
Maximum Output Power to Antenna	23.51 dBm
Antenna Type	Fixed Internal Antenna
Antenna Gain	-1.33 dBi
Type of Modulation	QPSK / 16QAM / 64QAM

1.3 Modification of EUT

No modifications are made to the EUT during all test items.



1.4 Emission Designator

LTE Band 26		QPSK			16QAM			64QAM		
BW (MHz)	Frequency Range (MHz)	Emission Designator (99%OBW)	Frequency Tolerance (ppm)	Maximum ERP(W)	Emission Designator (99%OBW)	Frequency Tolerance (ppm)	Maximum ERP(W)	Emission Designator (99%OBW)	Frequency Tolerance (ppm)	Maximum ERP(W)
1.4	814.7~823.3	1M10G7D	-	-	1M09W7D	-	-	1M10W7D	-	-
3	815.5~822.5	2M73G7D	-	-	2M73W7D	-	-	2M73W7D	-	-
5	816.5~821.5	4M49G7D	-	-	4M49W7D	-	-	4M51W7D	-	-
10	819.0	8M97G7D	0.0255	-	9M01W7D	-	-	9M03W7D	-	-
15	821.5	13M5G7D	0.0251	0.0942	13M4W7D	-	0.1007	13M5W7D	-	0.0879

1.5 Testing Site

Test Site	SPORTON INTERNATIONAL INC. EMC & Wireless Communications Laboratory
Test Site Location	No.52, Huaya 1st Rd., Guishan Dist., Taoyuan City, Taiwan (R.O.C.) TEL: +886-3-327-3456 FAX: +886-3-328-4978
Test Site No.	Sporton Site No. TH05-HY
Test Engineer	Benjamin Lin
Temperature	23~26 °C
Relative Humidity	50~55 %

Note: The test site complies with ANSI C63.4 2014 requirement.

Test Site	SPORTON INTERNATIONAL INC. EMC & Wireless Communications Laboratory
Test Site Location	No.58, Aly. 75, Ln. 564, Wenhua 3rd, Rd., Guishan Dist., Taoyuan City, Taiwan (R.O.C.) TEL: +886-3-327-0868 FAX: +886-3-327-0855
Test Site No.	Sporton Site No. 03CH12-HY
Test Engineer	Jack Cheng, Lance Chiang, and Chuan Chu
Temperature	22.3~25.3°C
Relative Humidity	55.7~61.9%

Note: The test site complies with ANSI C63.4 2014 requirement.

FCC Designation No.: TW1190 and TW0007



1.6 Applied Standards

According to the specifications of the manufacturer, the EUT must comply with the requirements of the following standards:

- ♦ FCC 47 CFR Part 2, 90
- ♦ ANSI / TIA-603-E
- ♦ ANSI C63.26-2015
- ♦ FCC KDB 971168 D01 Power Meas. License Digital Systems v03r01
- ♦ FCC KDB 412172 D01 Determining ERP and EIRP v01r01
- ♦ FCC KDB 414788 D01 Radiated Test Site v01r01
- ♦ Interim Guidance for Equipment Authorization of Devices with Channel Bandwidths Combined Across Two Contiguous Service Rule Allocations OET/Lab/EACB, June 6, 2013

Remark:

1. All test items were verified and recorded according to the standards and without any deviation during the test.
2. This EUT has also been tested and complied with the requirements of FCC Part 15, Subpart B, recorded in a separate test report.



2 Test Configuration of Equipment Under Test

2.1 Test Mode

During all testing, EUT is in link mode with base station emulator at maximum power level.

For radiated measurement, pre-scanned in three orthogonal panels, X, Y, Z. The worst cases (Y plane) were recorded in this report.

Frequency range investigated for radiated emission is 30 MHz to 9000 MHz.

Conducted Test Cases	Band	Bandwidth (MHz)						Modulation			RB #			Test Channel		
		1.4	3	5	10	15	20	QPSK	16QAM	64QAM	1	Half	Full	L	M	H
Max. Output Power	26	v	v	v	v	v	-	v	v	v	v	v	v	v	v	v
Peak-to-Average Ratio	26					v	-	v	v	v	v		v	v	v	v
26dB and 99% Bandwidth	26	v	v	v	v	v	-	v	v	v			v	v	v	v
Emission masks In-band emissions	26	v	v	v	v	v	-	v	v	v	v		v	v		v
Emission masks – Out of band emissions	26	v	v	v	v	v	-	v	v	v	v			v	v	v
Frequency Stability	26	-	-		v	v	-	v	v	v			v		v	
E.R.P.	26	v	v	v	v	v	-	v	v	v	v	v		v	v	v
Radiated Spurious Emission	26	Worst Case											v	v	v	
Remark	<ol style="list-style-type: none"> The mark "v" means that this configuration is chosen for testing The mark "-" means that this bandwidth is not supported. LTE Band26 transmit frequency for part22 rule is 824MHz-849MHz, for part90 rule is 814MHz-824MHz. ERP over 15MHz bandwidth complies the ERP limit line of part22 rule, therefore ERP of the partial frequency spectrum which falls within part 22 also complies. All the radiated test cases were performed with Adapter 1 (US) and USB Cable 1. 															

2.2 Connection Diagram of Test System



2.3 Support Unit used in test configuration and system

Item	Equipment	Trade Name	Model No.	FCC ID	Data Cable	Power Cord
1.	System Simulator	Anritsu	MT8820C	N/A	N/A	Unshielded, 1.8 m

2.4 Measurement Results Explanation Example

For all conducted test items:

The offset level is set in the spectrum analyzer to compensate the RF cable loss and attenuator factor between RF conducted output port and spectrum analyzer. With the offset compensation, the spectrum analyzer reading level will be exactly the RF output level.

The spectrum analyzer offset is derived from RF cable loss and attenuator factor.

Offset = RF cable loss + attenuator factor.

The following shows an offset computation example with RF cable loss 4.2 dB and a 10dB attenuator.

Example :

$$\begin{aligned} \text{Offset(dB)} &= \text{RF cable loss(dB)} + \text{attenuator factor(dB)}. \\ &= 4.2 + 10 = 14.2 \text{ (dB)} \end{aligned}$$



2.5 Frequency List of Low/Middle/High Channels

LTE Band 26 Channel and Frequency List				
BW [MHz]	Channel/Frequency(MHz)	Lowest	Middle	Highest
15	Channel	26765	-	-
	Frequency	821.5	-	-
10	Channel	-	26740	-
	Frequency	-	819.0	-
5	Channel	26715	26740	26765
	Frequency	816.5	819.0	821.5
3	Channel	26705	26740	26775
	Frequency	815.5	819.0	822.5
1.4	Channel	26697	26740	26783
	Frequency	814.7	819.0	823.3

3 Conducted Test Items

3.1 Measuring Instruments

See list of measuring instruments of this test report.

3.1.1 Test Setup

3.1.2 Conducted Output Power

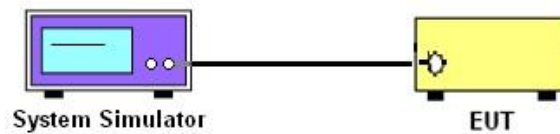

3.1.3 Peak-to-Average Ratio, Occupied Bandwidth, Conducted Band-Edge, Emission Mask, Emissions Mask – Out Of Band Emissions, and Conducted Spurious Emission

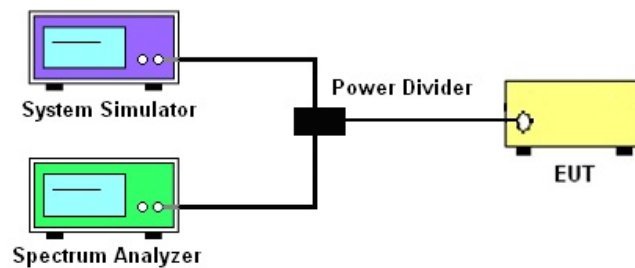

3.1.4 Frequency Stability

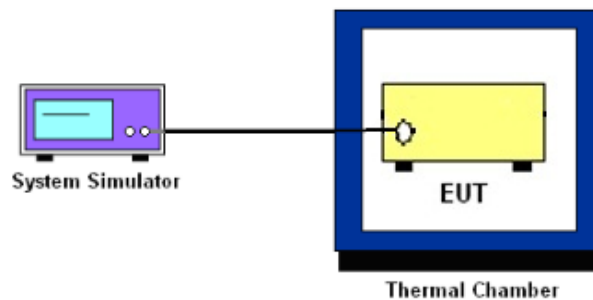

3.1.5 Test Result of Conducted Test

Please refer to Appendix A.



3.2 Conducted Output Power Measurement and ERP Measurement

3.2.1 Description of the Conducted Output Power Measurement and ERP Measurement

A system simulator was used to establish communication with the EUT. Its parameters were set to enforce EUT transmitting at the maximum power. The measured power in the radio frequency on the transmitter output terminals shall be reported.

The ERP of mobile transmitters must not exceed 7 Watts for LTE Band 26.

According to KDB 412172 D01 Power Approach,

$EIRP = P_T + G_T - L_C$, where

P_T = transmitter output power in dBm

G_T = gain of the transmitting antenna in dBi

L_C = signal attenuation in the connecting cable between the transmitter and antenna in dB

3.2.2 Test Procedures

1. The transmitter output port was connected to the system simulator.
2. Set EUT at maximum power through system simulator.
3. Select lowest, middle, and highest channels for each band and different modulation.
4. Measure and record the power level from the system simulator.



3.3 Peak-to-Average Ratio

3.3.1 Description of the PAR Measurement

Reporting only

3.3.2 Test Procedures

1. The EUT was connected to spectrum and system simulator via a power divider.
2. Set the CCDF (Complementary Cumulative Distribution Function) option in spectrum analyzer.
3. The highest RF powers were measured and recorded the maximum PAPR level associated with a probability of 0.1 %.
4. Record the deviation as Peak to Average Ratio.



3.4 99% Occupied Bandwidth and 26dB Bandwidth Measurement

3.4.1 Description of (Occupied) Bandwidth Limitations Measurement

The 99% occupied bandwidth is the width of a frequency band such that, below the lower and above the upper frequency limits, the mean powers emitted are each equal to a specified percentage 0.5% of the total mean transmitted power.

The emission bandwidth is defined as the width of the signal between two points, located at the 2 sides of the carrier frequency, outside of which all emissions are attenuated at least 26 dB below the transmitter power.

3.4.2 Test Procedures

1. The EUT was connected to spectrum analyzer and system simulator via a power divider.
2. The 26dB and 99% occupied bandwidth (BW) of the middle channel for the highest RF power with full RB sizes were measured.



3.5 Emissions Mask Measurement

3.5.1 Description of Emissions Mask Measurement

Equipment used in this licensed to EA or non-EA systems shall comply with the emission mask provisions of FCC Part 90.691.(a)

(a) Out-of-band emission requirement shall apply only to the “outer” channels included in an EA license and to spectrum adjacent to interior channels used by incumbent licensees. The emission limits are as follows:

(1) For any frequency removed from the EA licensee's frequency block by up to and including 37.5 kHz, the power of any emission shall be attenuated below the transmitter power (P) in watts by at least $116 \text{Log}_{10}(f/6.1)$ decibels or $50 + 10 \text{Log}_{10}(P)$ decibels or 80 decibels, whichever is the lesser attenuation, where f is the frequency removed from the center of the outer channel in the block in kilohertz and where f is greater than 12.5 kHz.

(2) For any frequency removed from the EA licensee's frequency block greater than 37.5 kHz, the power of any emission shall be attenuated below the transmitter power (P) in watts by at least $43 + 10\text{Log}_{10}(P)$ decibels or 80 decibels, whichever is the lesser attenuation, where f is the frequency removed from the center of the outer channel in the block in kilohertz and where f is greater than 37.5 kHz.

3.5.2 Test Procedures

1. The EUT was connected to spectrum analyzer and base station via power divider.
2. The emissions mask of low and high channels for the highest RF powers were measured.
3. Set RBW and VBW 3 times of RBW to make the measurement with the spectrum analyzer's, and according to KDB 971168 D02 Misc Rev Approve License Devices v02r01 standards, set RBW = 300 Hz to make offsets less than 37.5 kHz from a channel edge , RBW = 100 kHz to make offsets greater than 37.5 kHz, that is allowed.
4. The test results were shown below plots with a correction offset factor including cable loss, insertion loss of power divider.



3.6 Emissions Mask – Out Of Band Emissions Measurement

3.6.1 Description of Conducted Emissions Out of band emissions measurement

The power of any emission FCC Part 90.691 (a)(2) on any frequency removed from the assigned frequency by out of the authorized bandwidth at least $43 + 10 \log (P)$ dB. It is measured by means of a calibrated spectrum analyzer and scanned from 30 MHz up to a frequency including its 10th harmonic.

3.6.2 Test Procedures

1. The EUT was connected to spectrum analyzer and system simulator via a power divider.
2. The RF output of EUT was connected to the spectrum analyzer by RF cable and attenuator. The path loss was compensated to the results for each measurement.
3. The middle channel for the highest RF power within the transmitting frequency was measured.
4. The conducted spurious emission for the whole frequency range was taken.
5. For testing below 1GHz, make the measurement with the spectrum analyzer's RBW = 100 kHz, VBW = 3MHz, taking the record of maximum spurious emission.
6. For testing above 1GHz, make the measurement with the spectrum analyzer's RBW = 1MHz, VBW = 3MHz, taking the record of maximum spurious emission.
7. The RF fundamental frequency should be excluded against the limit line in the operating frequency band.
8. The limit line is derived from $43 + 10\log(P)$ dB below the transmitter power P(Watts)



3.7 Frequency Stability Measurement

3.7.1 Description of Frequency Stability Measurement

The frequency stability shall be sufficient to ensure that the fundamental emission stays within the authorized frequency block.

3.7.2 Measuring Instruments

The measuring equipment is listed in the section 4 of this test report.

3.7.3 Test Procedures for Temperature Variation

1. The EUT was set up in the thermal chamber and connected with the base station.
2. With power OFF, the temperature was decreased to -30°C and the EUT was stabilized for three hours. Power was applied and the maximum change in frequency was recorded within one minute.
3. With power OFF, the temperature was raised in 10°C step up to 50°C. The EUT was stabilized at each step for at least half an hour. Power was applied and the maximum frequency change was recorded within one minute.

3.7.4 Test Procedures for Voltage Variation

1. The EUT was placed in a temperature chamber at 20±5° C and connected with the base station.
2. The power supply voltage to the EUT was varied from BEP to 115% of the nominal value measured at the input to the EUT.
3. The variation in frequency was measured for the worst case.



3.8 Field Strength of Spurious Radiation Measurement

3.8.1 Description of Field Strength of Spurious Radiated Measurement

The radiated spurious emission was measured by substitution method according to ANSI / TIA-603-E. The power of any emission FCC Part 90.691 on any frequency removed from the assigned frequency by more than 250 percent of the authorized bandwidth at least $43 + 10 \log (P)$ dB. The spectrum is scanned from 30 MHz up to a frequency including its 10th harmonic.

The power of any emission outside of the authorized operating frequency ranges must be attenuated below the transmitter power (P) by a factor of at least $43+10\log_{10}(P[\text{Watts}])$ dB. The spectrum is scanned from 30 MHz up to a frequency including its 10th harmonic.

3.8.2 Test Procedures

1. The EUT was placed on a turntable with 0.8 meter for frequency below 1GHz and 1.5 meter for frequency above 1GHz respectively above ground.
2. The EUT was set 3 meters from the receiving antenna, which was mounted on the antenna tower.
3. The table was rotated 360 degrees to determine the position of the highest spurious emission.
4. The height of the receiving antenna is varied between one meter and four meters to search the maximum spurious emission for both horizontal and vertical polarizations.
5. For testing below 1GHz, make the measurement with the spectrum analyzer's RBW = 100 kHz, VBW = 3MHz, Sweep = 500ms, Taking the record of maximum spurious emission.
6. For testing above 1GHz, make the measurement with the spectrum analyzer's RBW = 1MHz, VBW = 3MHz, Sweep = 500ms, Taking the record of maximum spurious emission.
7. A horn antenna was substituted in place of the EUT and was driven by a signal generator.
8. Tune the output power of signal generator to the same emission level with EUT maximum spurious emission.
9. Taking the record of output power at antenna port.
10. Repeat step 7 to step 8 for another polarization.
11. $\text{EIRP (dBm)} = \text{S.G. Power} - \text{Tx Cable Loss} + \text{Tx Antenna Gain}$
12. $\text{ERP (dBm)} = \text{EIRP} - 2.15$
13. The RF fundamental frequency should be excluded against the limit line in the operating frequency band.
14. The limit line is derived from $43 + 10\log(P)$ dB below the transmitter power P(Watts)

3.8.3 Test Setup

For radiated emissions below 30MHz

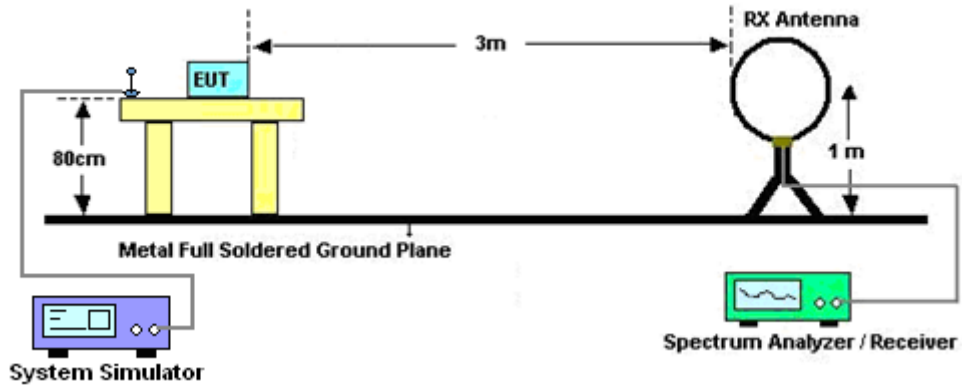

For radiated test from 30MHz to 1GHz

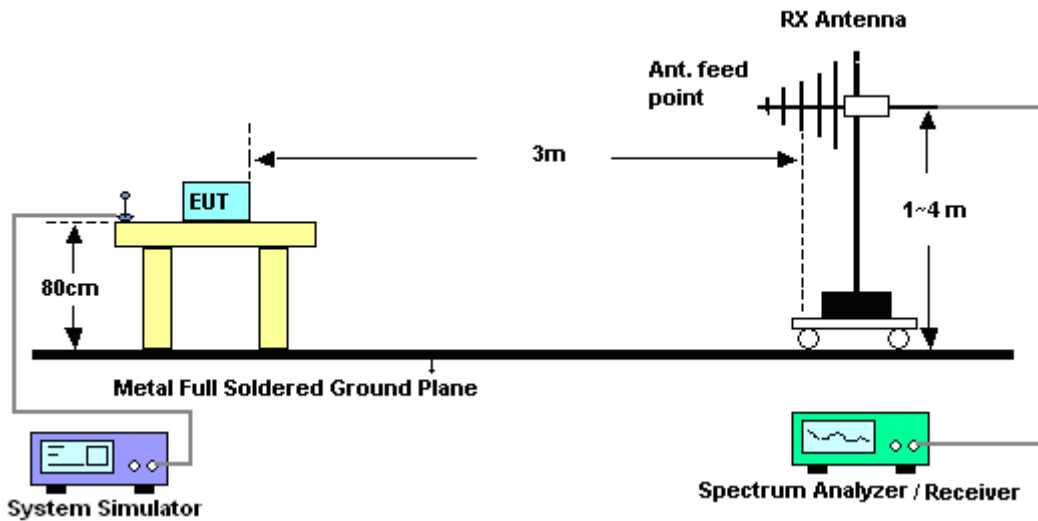

For radiated test above 1GHz

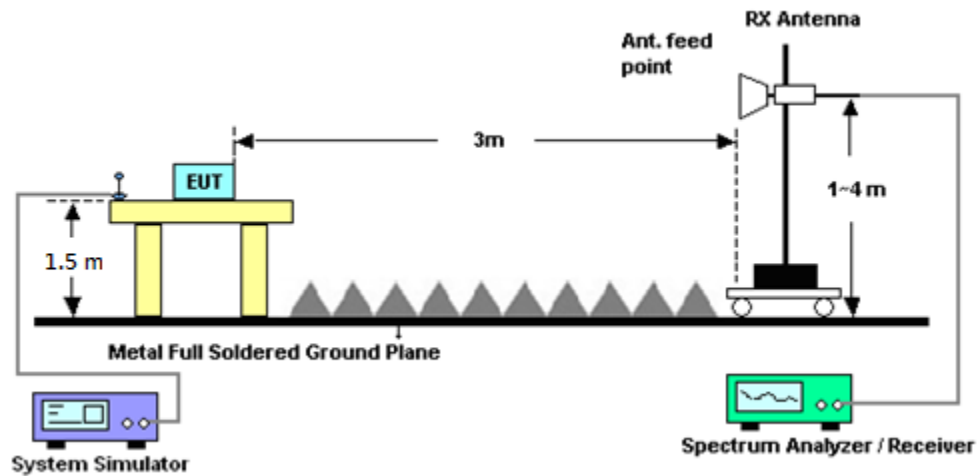

3.8.4 Test Result of Field Strength of Spurious Radiated

Please refer to Appendix B.

Note:

The low frequency, which started from 9 kHz to 30MHz, was pre-scanned and the result which was 20dB lower than the limit line was not reported.

There is a comparison data of both open-field test site and alternative test site - semi-Anechoic chamber according to 414788 D01 Radiated Test Site v01r01, and the result came out very similar.



4 List of Measuring Equipment

Instrument	Manufacturer	Model No.	Serial No.	Characteristics	Calibration Date	Test Date	Due Date	Remark
Loop Antenna	Rohde & Schwarz	HFH2-Z2	100315	9 kHz~30 MHz	Dec. 26, 2019	Feb. 11, 2020~ Feb. 13, 2020	Dec. 25, 2020	Radiation (03CH12-HY)
Bilog Antenna	TESEQ	CBL 6111D & 00800N1D01 N-06	37059 & 01	30MHz~1GHz	Oct. 12, 2019	Feb. 11, 2020~ Feb. 13, 2020	Oct 11, 2020	Radiation (03CH12-HY)
Horn Antenna	SCHWARZBE CK	BBHA 9120D	9120D-132 8	1GHz ~ 18GHz	Nov. 14, 2019	Feb. 11, 2020~ Feb. 13, 2020	Nov. 13, 2020	Radiation (03CH12-HY)
SHF-EHF Horn Antenna	SCHWARZBE CK	BBHA 9170	BBHA9170 584	18GHz ~ 40GHz	Dec. 10, 2019	Feb. 11, 2020~ Feb. 13, 2020	Dec. 09, 2020	Radiation (03CH12-HY)
Preamplifier	COM-POWER	PA-103	161075	10MHz~1GHz	Mar. 25, 2019	Feb. 11, 2020~ Feb. 13, 2020	Mar. 24, 2020	Radiation (03CH12-HY)
Preamplifier	Jet-Power	JPA00101800 -30-10P	160118000 2	1GHz~18GHz	Aug. 01, 2019	Feb. 11, 2020~ Feb. 13, 2020	Jul. 31, 2020	Radiation (03CH12-HY)
Preamplifier	EMEC	EM18G40G	060715	18GHz ~ 40GHz	Dec. 13, 2019	Feb. 11, 2020~ Feb. 13, 2020	Dec. 12, 2020	Radiation (03CH12-HY)
Preamplifier	Agilent	8449B	3008A023 75	1GHz~26.5GHz	May 27, 2019	Feb. 11, 2020~ Feb. 13, 2020	May 26, 2020	Radiation (03CH12-HY)
Spectrum Analyzer	Keysight	N9010A	MY553705 26	10Hz~44GHz	Mar. 19, 2019	Feb. 11, 2020~ Feb. 13, 2020	Mar. 18, 2020	Radiation (03CH12-HY)
Signal Generator	Rohde & Schwarz	SMB100A	101107	100kHz~40GHz	Aug. 27, 2019	Feb. 11, 2020~ Feb. 13, 2020	Aug. 26, 2020	Radiation (03CH12-HY)
Hygrometer	TECEPEL	DTM-303B	TP161243	N/A	May 11, 2019	Feb. 11, 2020~ Feb. 13, 2020	May 10, 2020	Radiation (03CH12-HY)
RF Cable	HUBER + SUHNER	SUCOFLEX 126E	0058/126E	30M-18G	Mar. 13, 2019	Feb. 11, 2020~ Feb. 13, 2020	Mar. 12, 2020	Radiation (03CH12-HY)
RF Cable	HUBER + SUHNER	SUCOFLEX 102	505134/2	30M~40GHz	Feb. 26, 2019	Feb. 11, 2020~ Feb. 13, 2020	Feb. 25, 2020	Radiation (03CH12-HY)
RF Cable	HUBER + SUHNER	SUCOFLEX 102	800740/2	30M~40GHz	Feb. 26, 2019	Feb. 11, 2020~ Feb. 13, 2020	Feb. 25, 2020	Radiation (03CH12-HY)
Controller	EMEC	EM1000	N/A	Control Turn table & Ant Mast	N/A	Feb. 11, 2020~ Feb. 13, 2020	N/A	Radiation (03CH12-HY)
Antenna Mast	EMEC	AM-BS-4500- B	N/A	1m~4m	N/A	Feb. 11, 2020~ Feb. 13, 2020	N/A	Radiation (03CH12-HY)
Turn Table	EMEC	TT2000	N/A	0~360 Degree	N/A	Feb. 11, 2020~ Feb. 13, 2020	N/A	Radiation (03CH12-HY)
Software	Audix	E3 6.2009-8-24	RK-00098 9	N/A	N/A	Feb. 11, 2020~ Feb. 13, 2020	N/A	Radiation (03CH12-HY)



Instrument	Manufacturer	Model No.	Serial No.	Characteristics	Calibration Date	Test Date	Due Date	Remark
EMI Test Receiver	Agilent	N9038A (MXE)	MY532900 45	20MHz~8.4GHz	Jan. 18, 2020	Feb. 11, 2020~ Feb. 13, 2020	Jan. 17, 2021	Radiation (03CH12-HY)
Notch Filter	Wainwright	WRCG1710/1 755-1690/177 5-45/7SS	SN2	AWS Band	Nov. 05, 2019	Feb. 11, 2020~ Feb. 13, 2020	Nov. 04, 2020	Radiation (03CH12-HY)
Notch Filter	Wainwright	WRCT2500/2 570-10/40-10 SSK	SN1 R	LTE Band 7	Aug. 22, 2019	Feb. 11, 2020~ Feb. 13, 2020	Aug. 21, 2020	Radiation (03CH12-HY)
Filter	Wainwright	WLKS1200-1 2SS	SN2	1.2GHz Low Pass	Mar. 22, 2019	Feb. 11, 2020~ Feb. 13, 2020	Mar. 21, 2020	Radiation (03CH12-HY)
Filter	Wainwright	WHKX12-108 0-1200-1500-60ST	SN1	1.2G High Pass	Mar. 19, 2019	Feb. 11, 2020~ Feb. 13, 2020	Mar. 18, 2020	Radiation (03CH12-HY)
Filter	Wainwright	WHKX12-270 0-3000-18000 -60ST	SN2	3G High Pass	Jul. 15, 2019	Feb. 11, 2020~ Feb. 13, 2020	Jul. 14, 2020	Radiation (03CH12-HY)
Base Station(Measure)	Anritsu	MT8821C	626202534 1	GSM / GPRS /WCDMA / LTE FDD/TDD with 44) /LTE-3CC DLCA,2CC ULCA	Oct. 24, 2019	Feb. 10, 2020~ Mar. 12, 2020	Oct. 23, 2020	Conducted (TH05-HY)
Spectrum Analyzer	Rohde & Schwarz	FSV30	101749	10Hz~30GHz	Jan. 10, 2020	Feb. 10, 2020~ Mar. 12, 2020	Jan. 09, 2021	Conducted (TH05-HY)
Temperature Chamber	ESPEC	SH-641	92013720	-40°C ~90°C	Sep. 02, 2019	Feb. 10, 2020~ Mar. 12, 2020	Sep. 01, 2020	Conducted (TH05-HY)
Programmable Power Supply	GW Instek	PSS-2005	EL890094	1V~20V 0.5A~5A	Oct. 09, 2019	Feb. 10, 2020~ Mar. 12, 2020	Oct. 08, 2020	Conducted (TH05-HY)
Coupler	Warison	20dB 25W SMA Directional Coupler	#A	1-18GHz	Jan. 13, 2020	Feb. 10, 2020~ Mar. 12, 2020	Jan. 12, 2021	Conducted (TH05-HY)



5 Uncertainty of Evaluation

Uncertainty of Radiated Emission Measurement (30 MHz ~ 1000 MHz)

Measuring Uncertainty for a Level of Confidence of 95% ($U = 2Uc(y)$)	3.24
---	------

Uncertainty of Radiated Emission Measurement (1 GHz ~ 18 GHz)

Measuring Uncertainty for a Level of Confidence of 95% ($U = 2Uc(y)$)	3.62
---	------

Uncertainty of Radiated Emission Measurement (18 GHz ~ 40 GHz)

Measuring Uncertainty for a Level of Confidence of 95% ($U = 2Uc(y)$)	4.06
---	------



Appendix A. Test Results of Conducted Test

Conducted Output Power(Average power)

LTE Band 26 Maximum Average Power [dBm]						
BW [MHz]	RB Size	RB Offset	Mod	Lowest	Middle	Highest
15	1	0	QPSK	23.04	-	-
15	1	37		22.93	-	-
15	1	74		22.89	-	-
15	36	0		23.10	-	-
15	36	20		23.07	-	-
15	36	39		23.22	-	-
15	75	0		22.95	-	-
15	1	0	16-QAM	23.51	-	-
15	1	37		23.27	-	-
15	1	74		23.28	-	-
15	36	0		22.82	-	-
15	36	20		22.67	-	-
15	36	39		22.71	-	-
15	75	0		22.60	-	-
15	1	0	64-QAM	22.74	-	-
15	1	37		22.73	-	-
15	1	74		22.92	-	-
15	36	0		21.62	-	-
15	36	20		21.76	-	-
15	36	39		21.76	-	-
15	75	0		21.69	-	-
10	1	0	QPSK	-	23.03	-
10	1	25		-	22.87	-
10	1	49		-	22.88	-
10	25	0		-	22.75	-
10	25	12		-	22.95	-
10	25	25		-	22.91	-
10	50	0		-	22.94	-
10	1	0	16-QAM	-	23.10	-
10	1	25		-	23.31	-
10	1	49		-	23.19	-
10	25	0		-	22.65	-
10	25	12		-	22.69	-
10	25	25		-	22.67	-
10	50	0		-	22.66	-
10	1	0	64-QAM	-	22.90	-
10	1	25		-	22.74	-
10	1	49		-	22.75	-
10	25	0		-	21.64	-
10	25	12		-	21.72	-
10	25	25		-	21.74	-
10	50	0		-	21.71	-



LTE Band 26 Maximum Average Power [dBm]						
BW [MHz]	RB Size	RB Offset	Mod	Lowest	Middle	Highest
5	1	0	QPSK	22.95	22.76	22.88
5	1	12		22.97	22.90	22.85
5	1	24		22.88	22.92	22.87
5	12	0		22.98	22.95	23.04
5	12	7		22.98	23.09	22.95
5	12	13		23.05	22.87	22.90
5	25	0		22.89	23.02	22.94
5	1	0	16-QAM	23.31	23.18	23.35
5	1	12		23.17	23.24	23.27
5	1	24		23.08	23.28	23.24
5	12	0		22.62	22.79	22.58
5	12	7		22.70	22.81	22.72
5	12	13		22.69	22.65	22.69
5	25	0		22.74	22.68	22.67
5	1	0	64-QAM	22.60	22.75	22.73
5	1	12		22.37	22.75	22.42
5	1	24		22.36	22.85	22.83
5	12	0		21.62	21.84	21.50
5	12	7		21.36	21.69	21.44
5	12	13		21.36	21.64	21.58
5	25	0		21.33	21.65	21.43
3	1	0	QPSK	23.08	22.73	22.94
3	1	8		22.96	22.89	22.97
3	1	14		22.92	23.00	22.85
3	8	0		22.91	22.92	22.94
3	8	4		23.11	23.05	22.90
3	8	7		22.93	22.89	22.90
3	15	0		22.95	22.86	22.82
3	1	0	16-QAM	23.23	23.22	23.23
3	1	8		23.29	23.40	23.19
3	1	14		23.07	23.19	23.13
3	8	0		22.77	22.69	22.68
3	8	4		22.76	22.87	22.68
3	8	7		22.70	22.81	22.51
3	15	0		22.64	22.75	22.65
3	1	0	64-QAM	22.76	22.85	22.49
3	1	8		22.68	22.88	22.78
3	1	14		22.61	22.71	22.74
3	8	0		21.59	21.74	21.42
3	8	4		21.66	21.80	21.68
3	8	7		21.49	21.71	21.64
3	15	0		21.53	21.64	21.60



LTE Band 26 Maximum Average Power [dBm]						
BW [MHz]	RB Size	RB Offset	Mod	Lowest	Middle	Highest
1.4	1	0	QPSK	22.81	22.70	22.77
1.4	1	3		22.92	22.96	22.80
1.4	1	5		22.95	22.77	22.64
1.4	3	0		22.92	22.72	22.82
1.4	3	1		22.88	22.89	22.82
1.4	3	3		22.84	22.78	22.76
1.4	6	0		23.00	22.93	22.80
1.4	1	0	16-QAM	23.19	23.16	23.16
1.4	1	3		23.19	23.24	23.10
1.4	1	5		22.95	23.05	23.18
1.4	3	0		22.92	22.81	22.94
1.4	3	1		22.90	22.89	22.81
1.4	3	3		22.99	22.82	22.75
1.4	6	0		22.77	22.81	22.60
1.4	1	0	64-QAM	22.11	22.16	21.90
1.4	1	3		22.13	22.04	22.40
1.4	1	5		21.95	22.14	21.89
1.4	3	0		21.90	22.14	21.88
1.4	3	1		22.09	21.93	22.05
1.4	3	3		22.05	22.25	22.11
1.4	6	0		21.73	21.64	21.50



LTE Band 26

Peak-to-Average Ratio

Mode	LTE Band 26 / 10MHz				
Mod.	QPSK		16QAM		Limit: 13dB
RB Size	1RB	Full RB	1RB	Full RB	Result
Lowest CH	-	-	-	-	PASS
Middle CH	3.68	4.49	4.41	5.51	
Highest CH	-	-	-	-	
Mode	LTE Band 26 / 10MHz				
Mod.	64QAM				Limit: 13dB
RB Size	1RB	Full RB			Result
Lowest CH	-	-	-	-	PASS
Middle CH	6.14	6.46	-	-	
Highest CH	-	-	-	-	



LTE Band 26 / 10MHz / QPSK

Middle Channel / 1RB

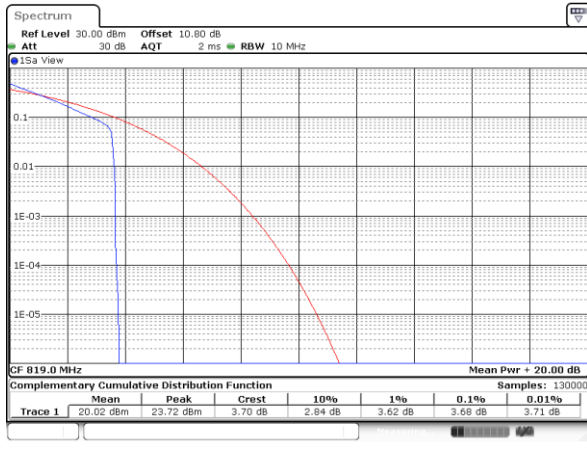

Date: 15.FEB.2020 04:33:48

Middle Channel / Full RB

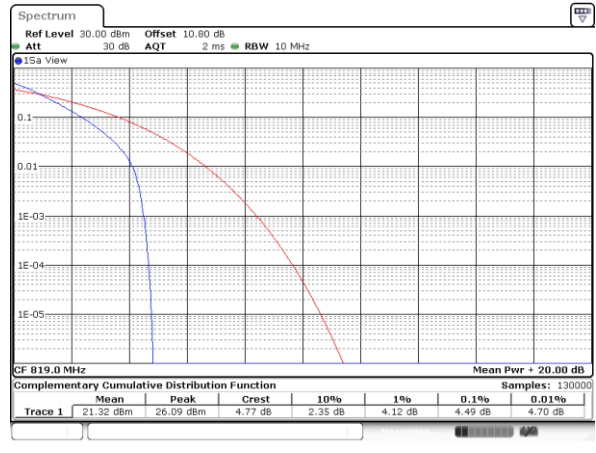

Date: 15.FEB.2020 04:38:18

LTE Band 26 / 10MHz / 16QAM

Middle Channel / 1RB

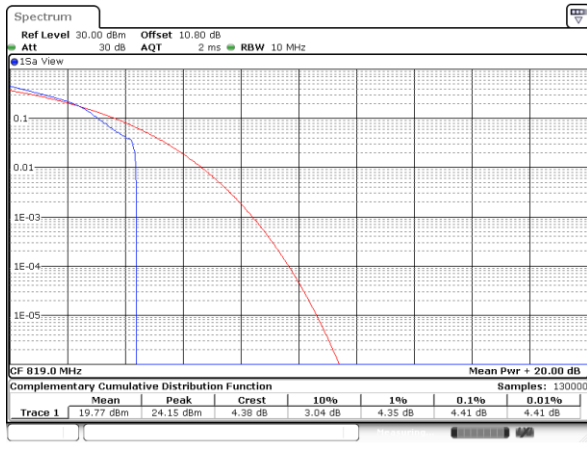

Date: 15.FEB.2020 04:37:12

Middle Channel / Full RB

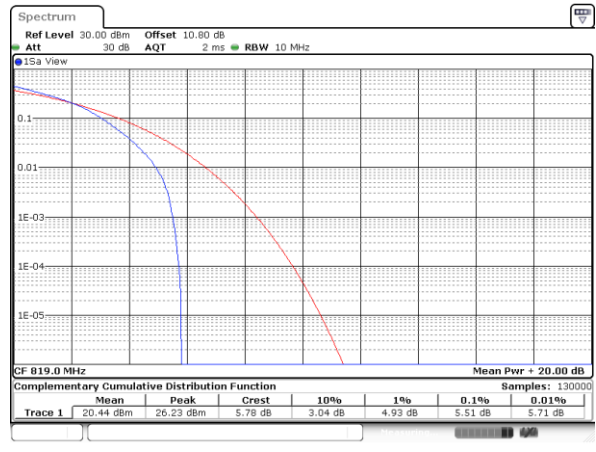

Date: 15.FEB.2020 04:37:46



LTE Band 26 / 10MHz / 64QAM

Middle Channel / 1RB

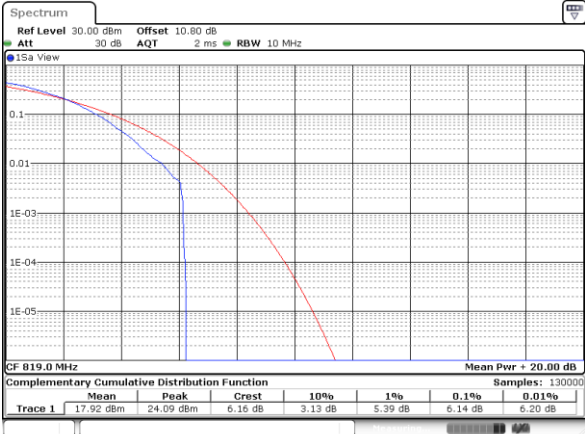

Date: 15.FEB.2020 04:38:34

Middle Channel / Full RB

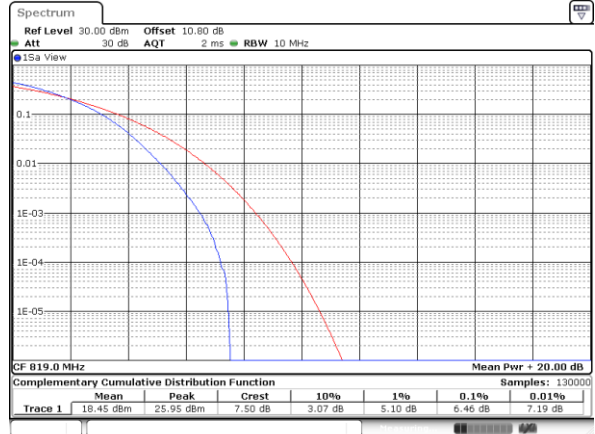

Date: 15.FEB.2020 04:38:50



26dB Bandwidth

Mode	LTE Band 26 : 26dB BW(MHz)											
BW	1.4MHz		3MHz		5MHz		10MHz		15MHz		20MHz	
Mod.	QPSK	16QAM	QPSK	16QAM	QPSK	16QAM	QPSK	16QAM	QPSK	16QAM	QPSK	16QAM
Lowest CH	1.23	1.23	3.02	3.01	4.92	4.92	-	-	14.51	14.48	-	-
Middle CH	1.22	1.22	3.02	3.05	4.93	4.91	9.79	9.85	-	-	-	-
Highest CH	1.23	1.23	3.00	3.00	4.91	4.86	-	-	-	-	-	-
Mode	LTE Band 26 : 26dB BW(MHz)											
BW	1.4MHz		3MHz		5MHz		10MHz		15MHz		20MHz	
Mod.	64QAM		64QAM		64QAM		64QAM		64QAM		64QAM	
Lowest CH	1.24	-	3.01	-	4.94	-	-	-	14.39	-	-	-
Middle CH	1.24	-	3.03	-	4.95	-	9.83	-	-	-	-	-
Highest CH	1.22	-	3.01	-	4.82	-	-	-	-	-	-	-



LTE Band 26

Lowest Channel / 1.4MHz / QPSK

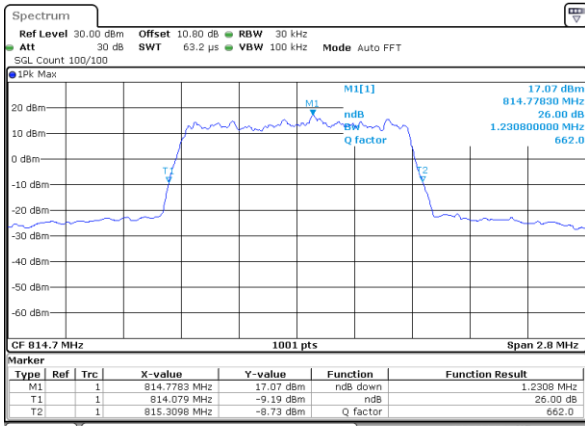

Date: 15.FEB.2020 04:24:59

Lowest Channel / 1.4MHz / 16QAM

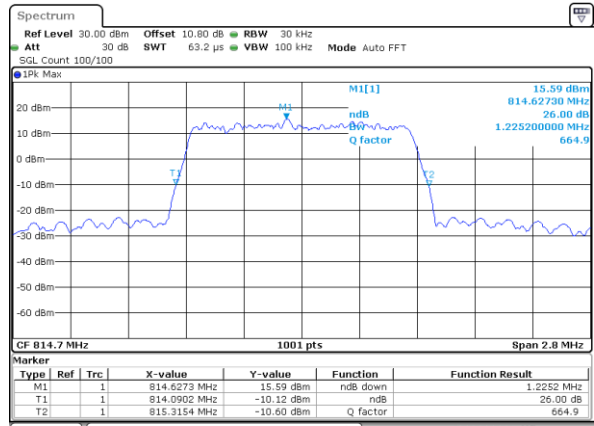

Date: 15.FEB.2020 04:24:46

Middle Channel / 1.4MHz / QPSK

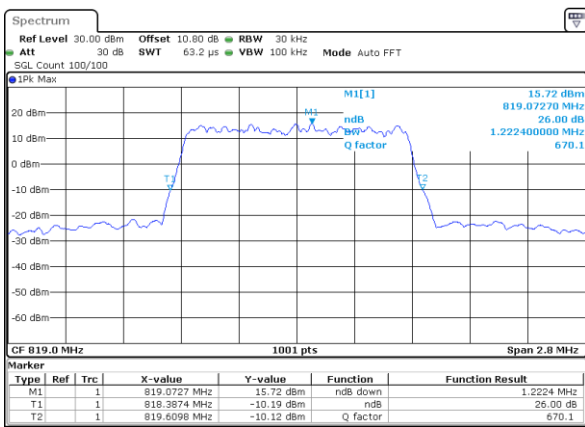

Date: 15.FEB.2020 04:27:55

Middle Channel / 1.4MHz / 16QAM

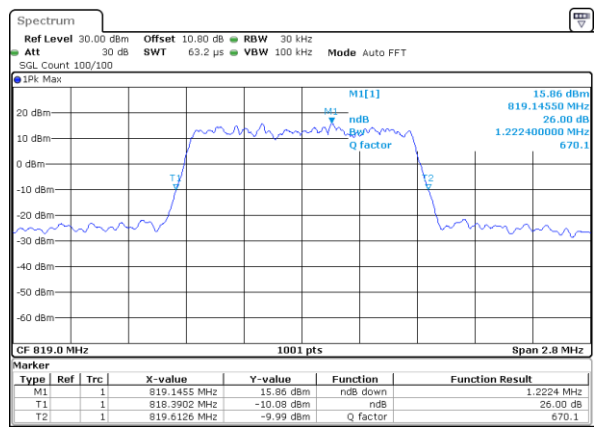

Date: 15.FEB.2020 04:28:08

Highest Channel / 1.4MHz / QPSK

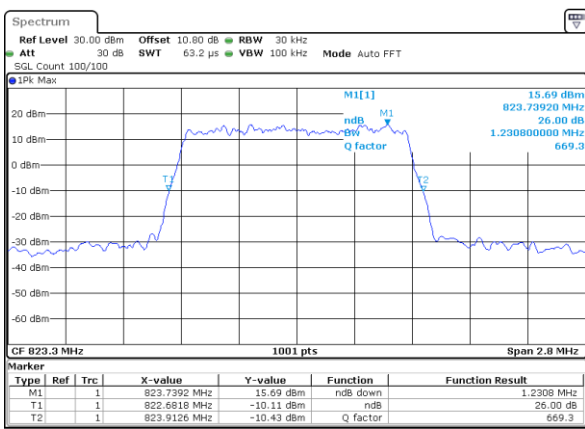

Date: 15.FEB.2020 04:31:04

Highest Channel / 1.4MHz / 16QAM

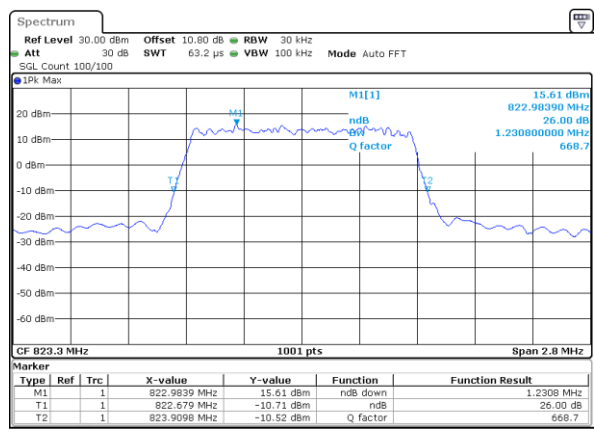

Date: 15.FEB.2020 04:31:18



LTE Band 26

Lowest Channel / 3MHz / QPSK

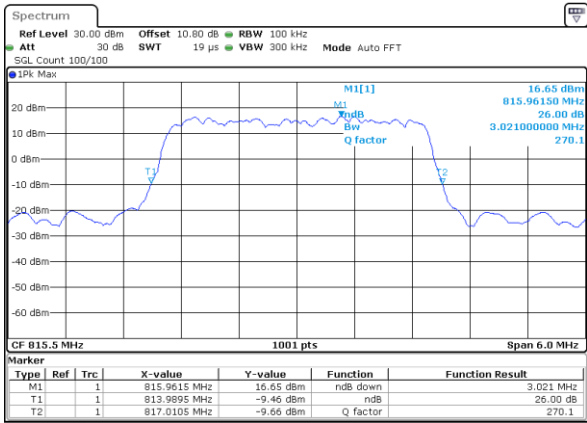

Date: 15.FEB.2020 03:55:00

Lowest Channel / 3MHz / 16QAM

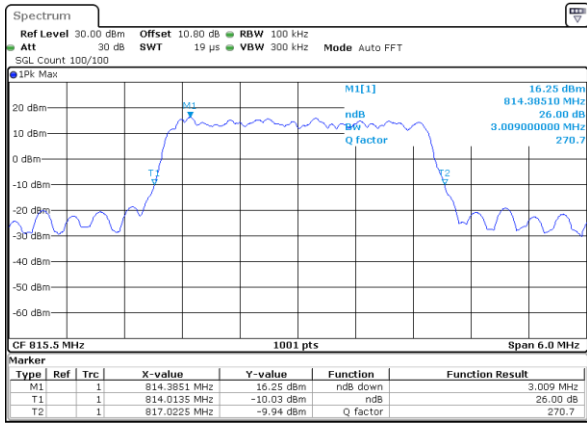

Date: 15.FEB.2020 03:55:13

Middle Channel / 3MHz / QPSK

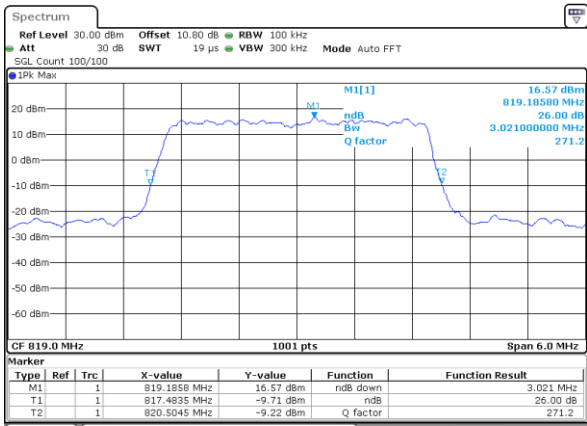

Date: 15.FEB.2020 03:58:09

Middle Channel / 3MHz / 16QAM

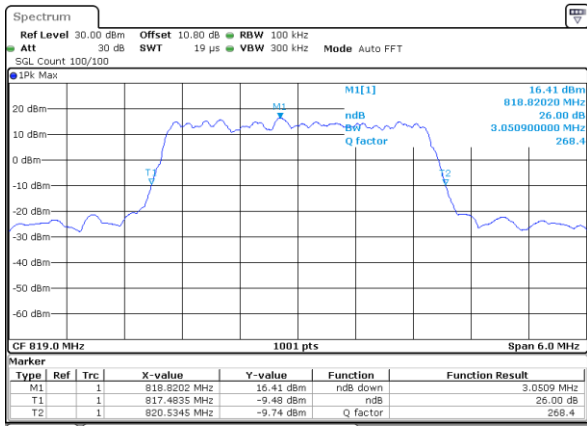

Date: 15.FEB.2020 03:58:23

Highest Channel / 3MHz / QPSK

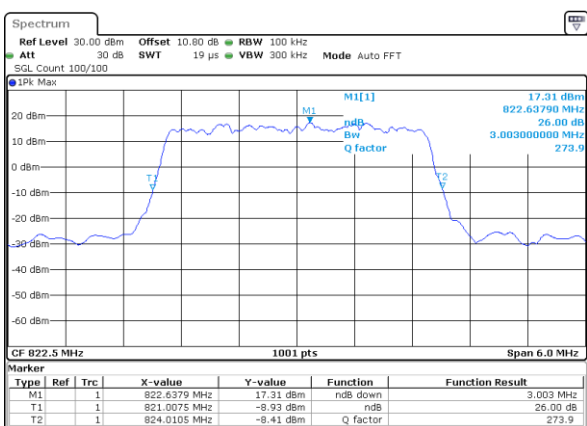

Date: 15.FEB.2020 04:01:18

Highest Channel / 3MHz / 16QAM

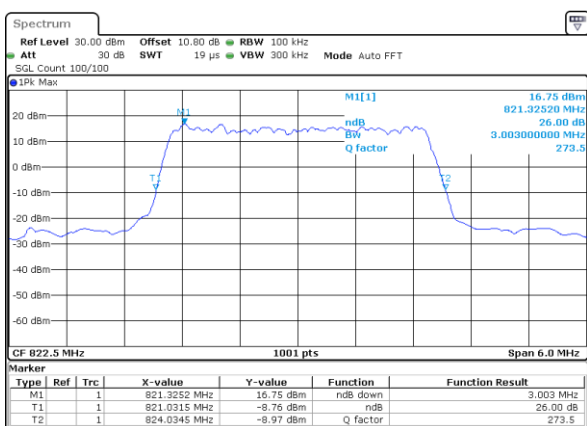

Date: 15.FEB.2020 04:01:32



LTE Band 26

Lowest Channel / 5MHz / QPSK

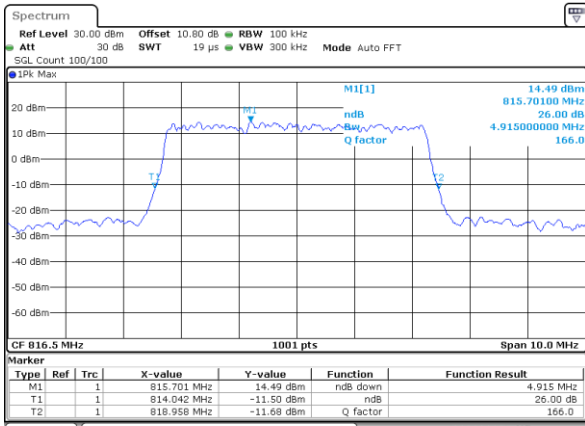

Date: 15.FEB.2020 04:04:29

Lowest Channel / 5MHz / 16QAM

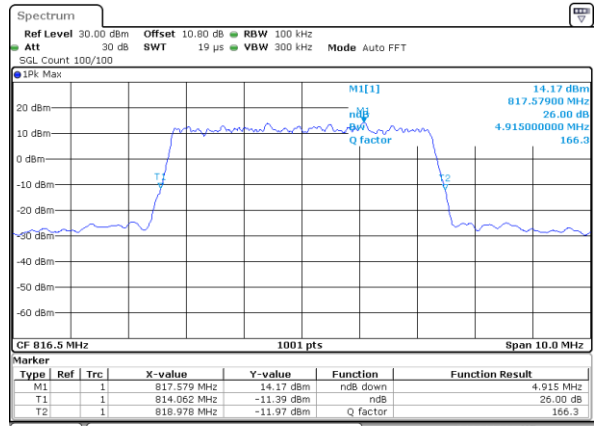

Date: 15.FEB.2020 04:04:43

Middle Channel / 5MHz / QPSK

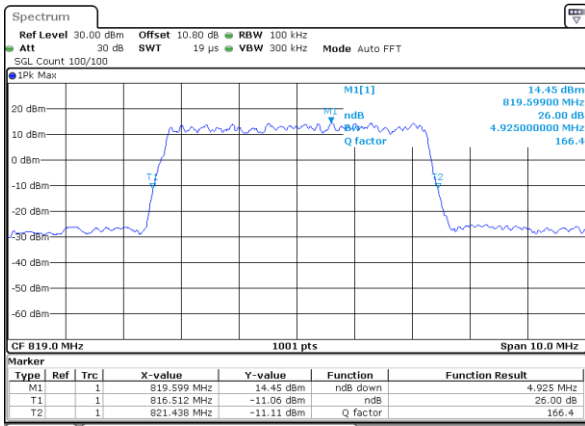

Date: 15.FEB.2020 04:07:38

Middle Channel / 5MHz / 16QAM

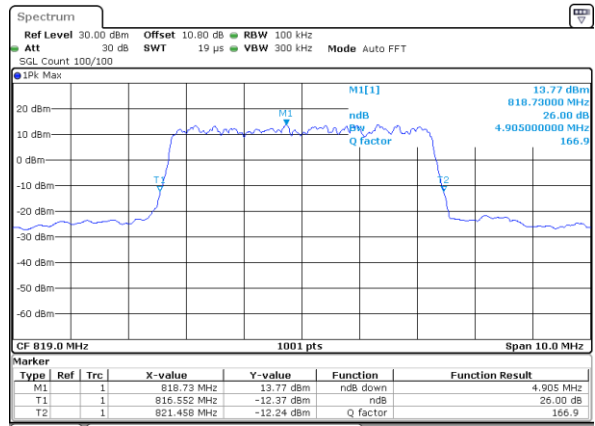

Date: 15.FEB.2020 04:07:52

Highest Channel / 5MHz / QPSK

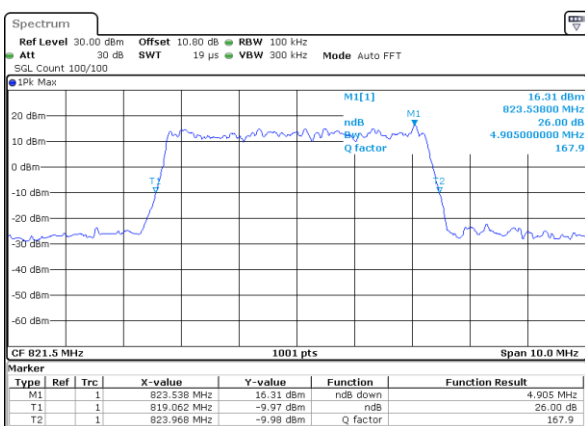

Date: 15.FEB.2020 04:10:48

Highest Channel / 5MHz / 16QAM

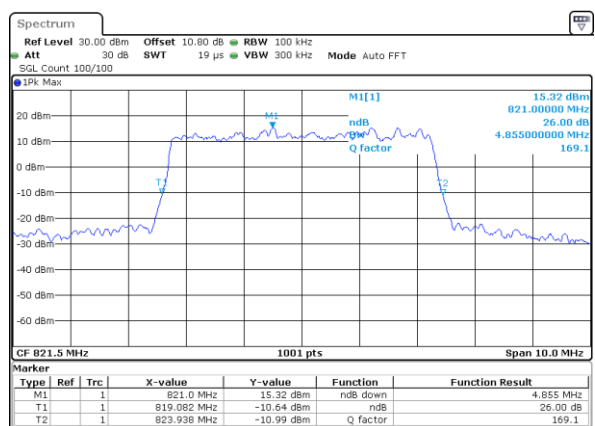

Date: 15.FEB.2020 04:11:02



LTE Band 26

Middle Channel / 10MHz / QPSK

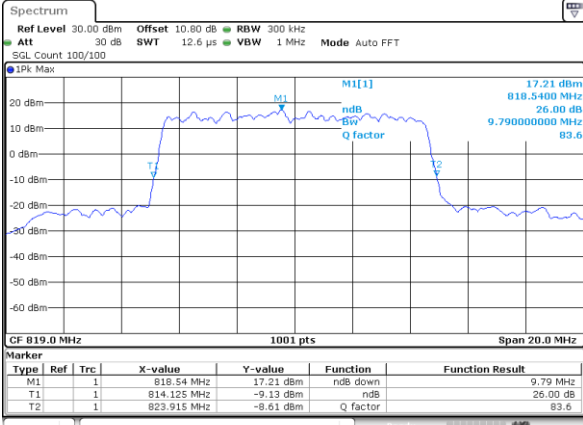

Date: 15.FEB.2020 04:13:58

Middle Channel / 10MHz / 16QAM

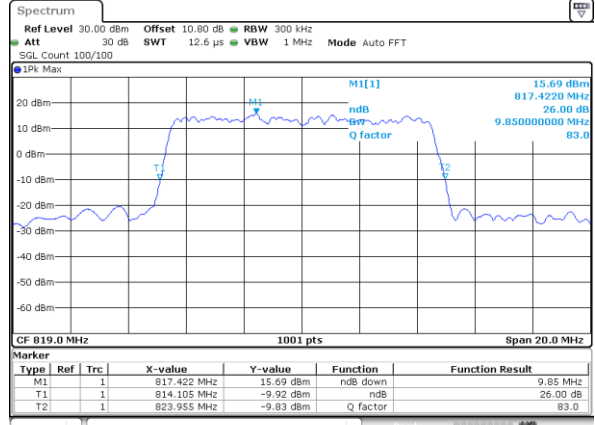

Date: 15.FEB.2020 04:14:12

Lowest Channel / 15MHz / QPSK

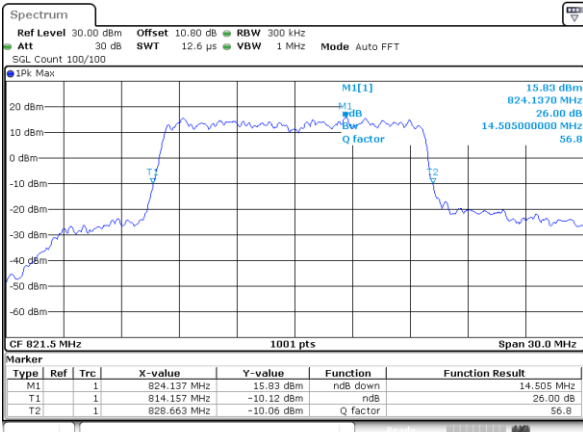

Date: 15.FEB.2020 04:17:09

Lowest Channel / 15MHz / 16QAM

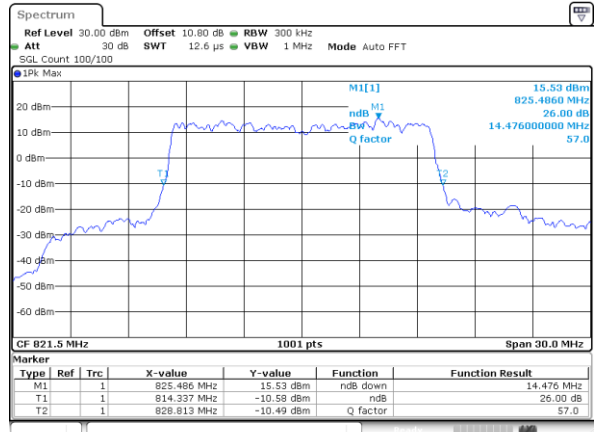

Date: 15.FEB.2020 04:17:23



LTE Band 26

Lowest Channel / 1.4MHz / 64QAM

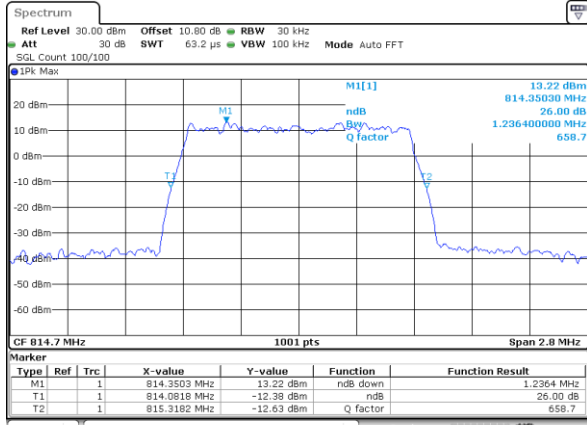

Date: 15.FEB.2020 03:50:00

Lowest Channel / 3MHz / 64QAM

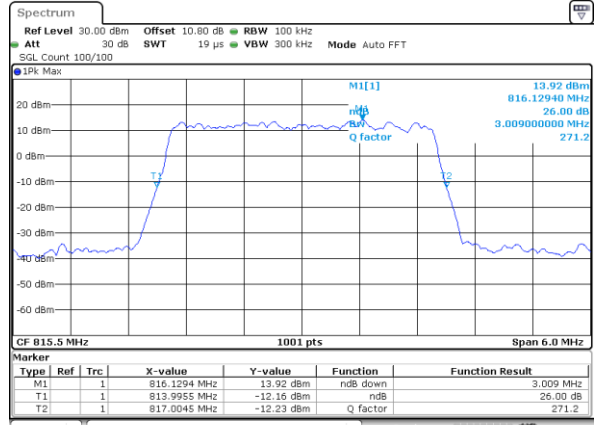

Date: 15.FEB.2020 03:35:04

Middle Channel / 1.4MHz / 64QAM

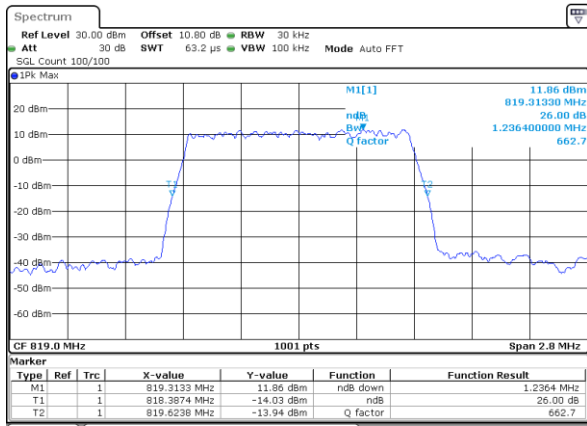

Date: 15.FEB.2020 03:51:35

Middle Channel / 3MHz / 64QAM

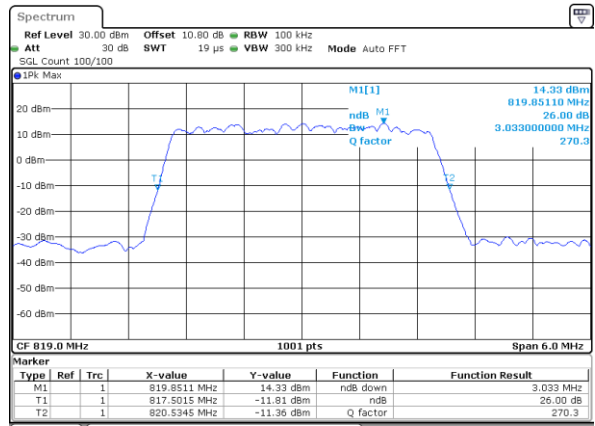

Date: 15.FEB.2020 03:36:39

Highest Channel / 1.4MHz / 64QAM

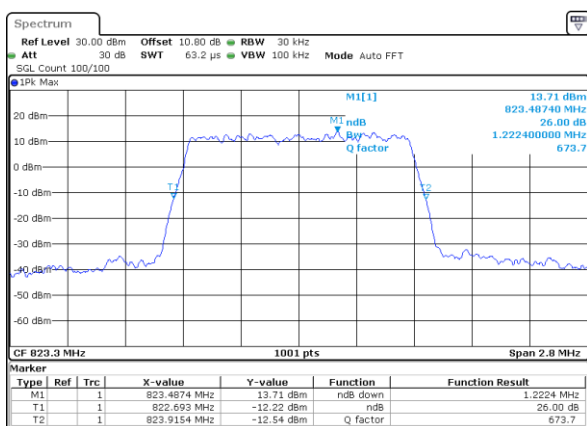

Date: 15.FEB.2020 03:53:09

Highest Channel / 3MHz / 64QAM

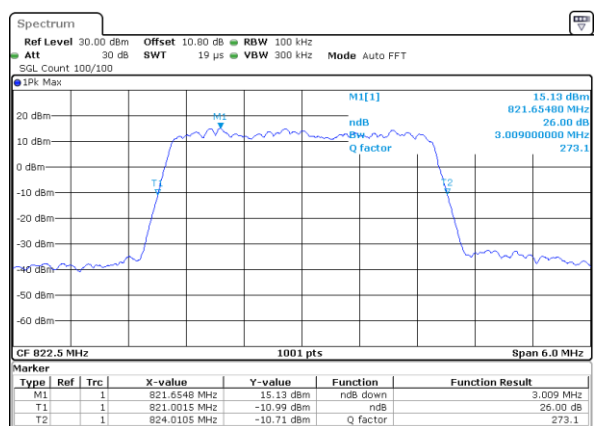

Date: 15.FEB.2020 03:38:13



LTE Band 26

Lowest Channel / 5MHz / 64QAM

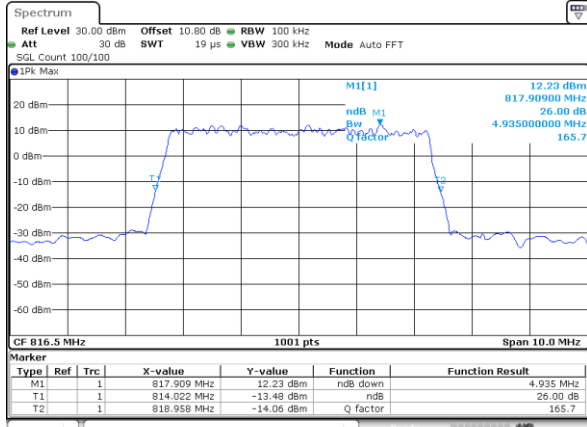

Date: 15.FEB.2020 03:39:49

Middle Channel / 5MHz / 64QAM

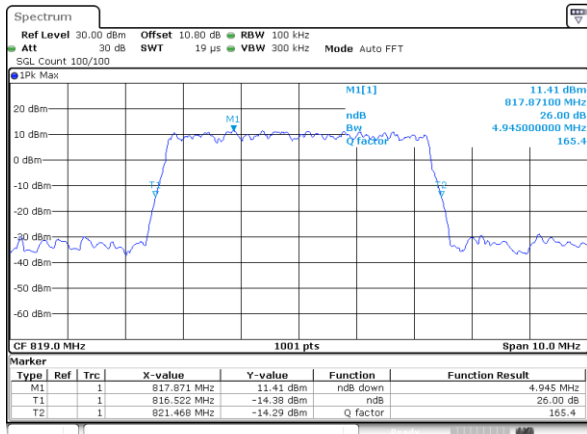

Date: 15.FEB.2020 03:41:24

Middle Channel / 10MHz / 64QAM

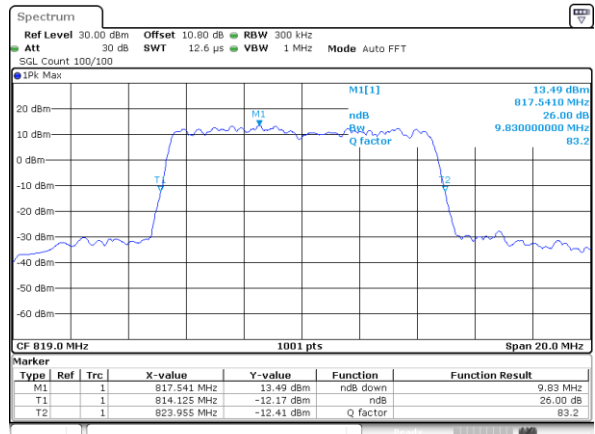

Date: 15.FEB.2020 03:44:35

Highest Channel / 5MHz / 64QAM

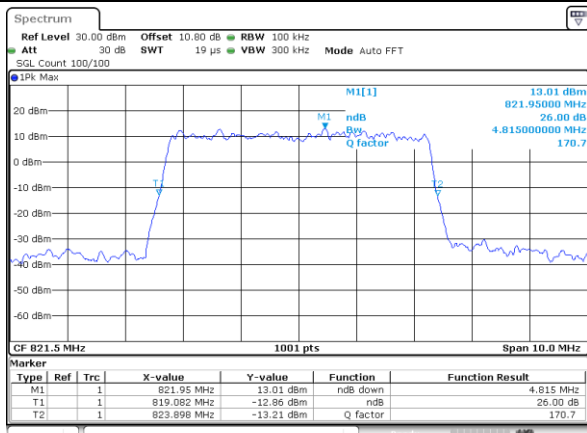

Date: 15.FEB.2020 03:42:58



LTE Band 26

Lowest Channel / 15MHz / 64QAM

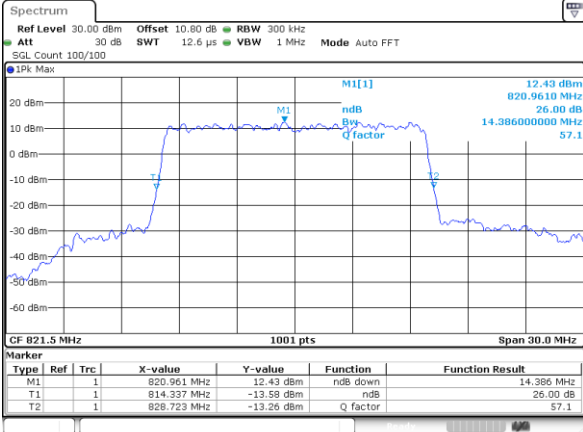

Date: 15.FEB.2020 03:46:11



Occupied Bandwidth

Mode	LTE Band 26 : 99%OBW(MHz)											
BW	1.4MHz		3MHz		5MHz		10MHz		15MHz		20MHz	
Mod.	QPSK	16QAM	QPSK	16QAM	QPSK	16QAM	QPSK	16QAM	QPSK	16QAM	QPSK	16QAM
Lowest CH	1.09	1.09	2.72	2.71	4.49	4.49	-	-	13.46	13.40	-	-
Middle CH	1.09	1.09	2.70	2.71	4.48	4.49	8.97	9.01	-	-	-	-
Highest CH	1.10	1.08	2.73	2.73	4.48	4.47	-	-	-	-	-	-
Mode	LTE Band 26 : 99%OBW(MHz)											
BW	1.4MHz		3MHz		5MHz		10MHz		15MHz		20MHz	
Mod.	64QAM		64QAM		64QAM		64QAM		64QAM		64QAM	
Lowest CH	1.09	-	2.72	-	4.50	-	-	-	13.46	-	-	-
Middle CH	1.09	-	2.71	-	4.51	-	9.03	-	-	-	-	-
Highest CH	1.10	-	2.73	-	4.47	-	-	-	-	-	-	-



LTE Band 26

Lowest Channel / 1.4MHz / QPSK

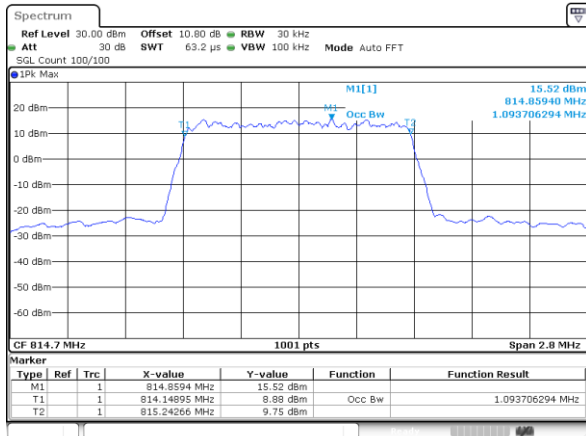

Date: 15.FEB.2020 04:24:18

Lowest Channel / 1.4MHz / 16QAM

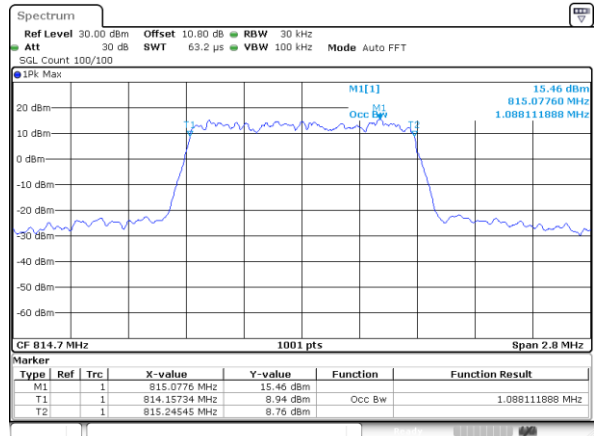

Date: 15.FEB.2020 04:24:32

Middle Channel / 1.4MHz / QPSK

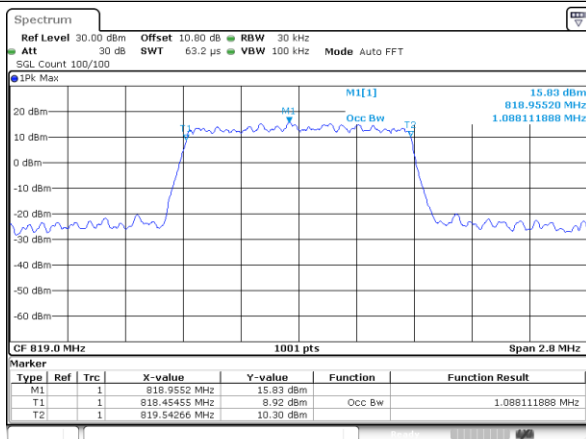

Date: 15.FEB.2020 04:27:27

Middle Channel / 1.4MHz / 16QAM

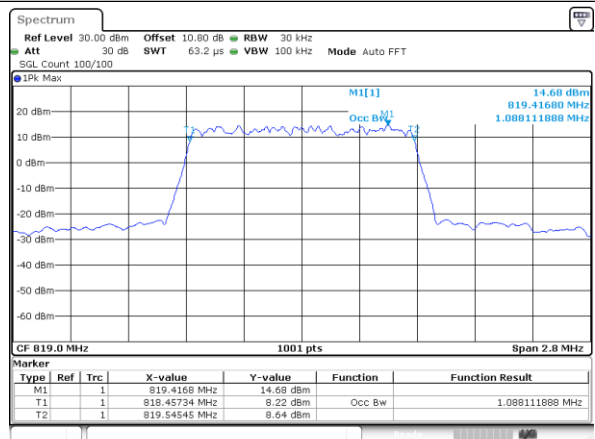

Date: 15.FEB.2020 04:27:41

Highest Channel / 1.4MHz / QPSK

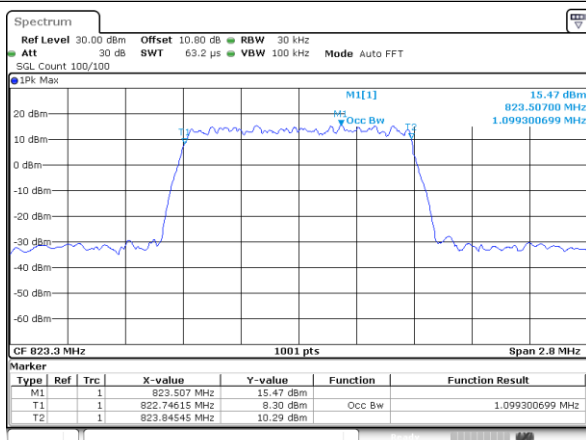

Date: 15.FEB.2020 04:30:36

Highest Channel / 1.4MHz / 16QAM

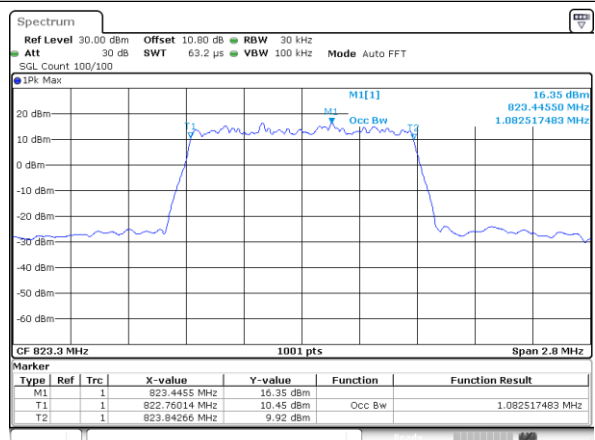

Date: 15.FEB.2020 04:30:50



LTE Band 26

Lowest Channel / 3MHz / QPSK

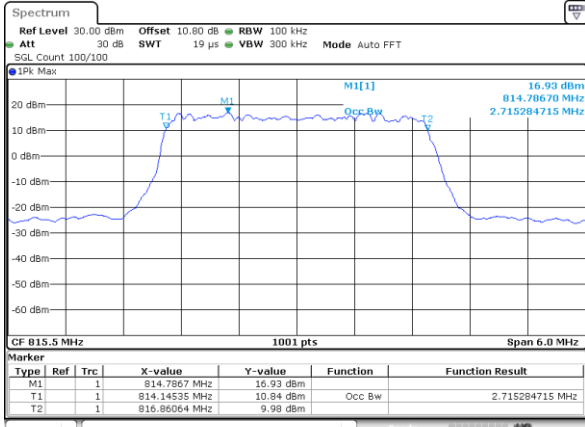

Date: 15.FEB.2020 03:54:32

Lowest Channel / 3MHz / 16QAM

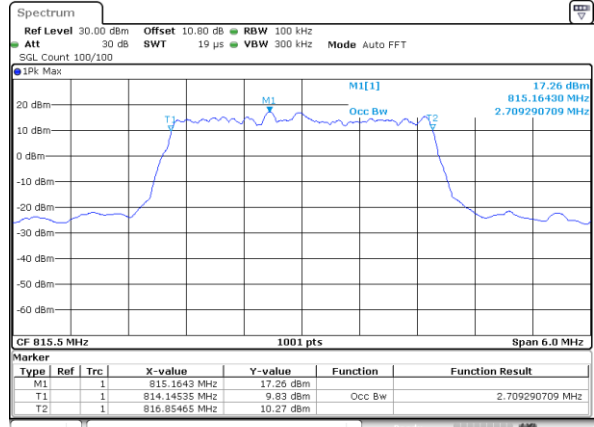

Date: 15.FEB.2020 03:54:46

Middle Channel / 3MHz / QPSK

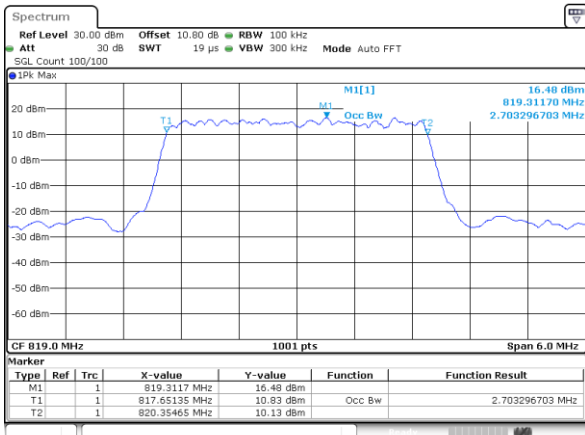

Date: 15.FEB.2020 03:57:41

Middle Channel / 3MHz / 16QAM

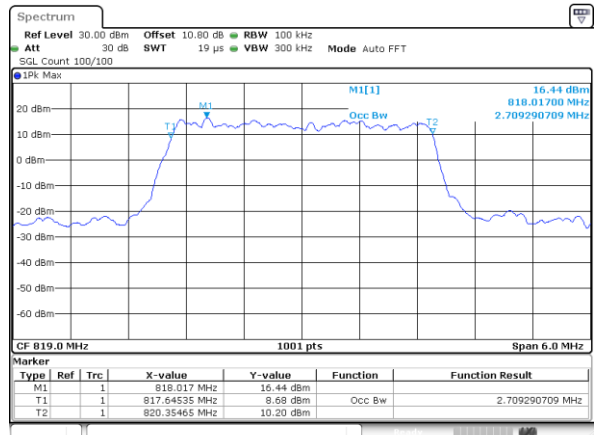

Date: 15.FEB.2020 03:57:55

Highest Channel / 3MHz / QPSK

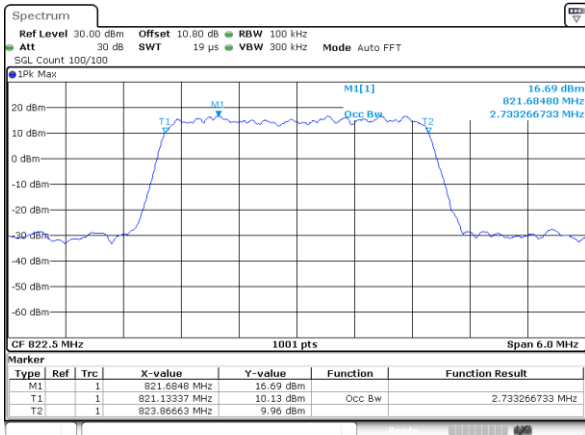

Date: 15.FEB.2020 04:00:50

Highest Channel / 3MHz / 16QAM

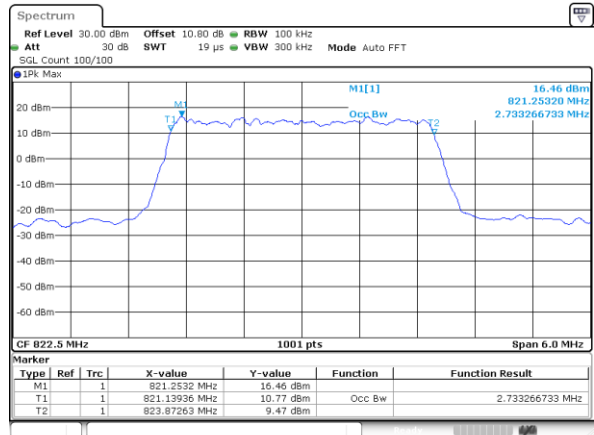

Date: 15.FEB.2020 04:01:04



LTE Band 26

Lowest Channel / 5MHz / QPSK

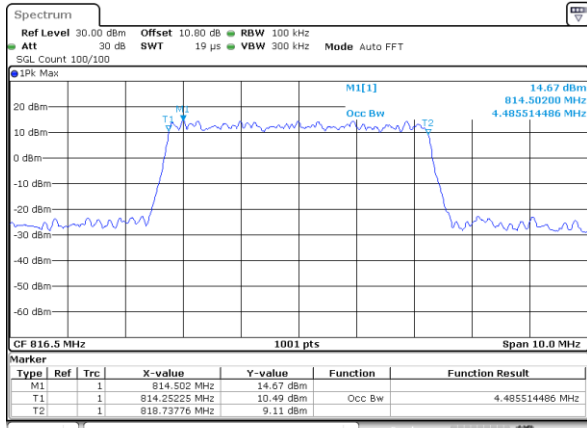

Date: 15.FEB.2020 04:04:02

Lowest Channel / 5MHz / 16QAM

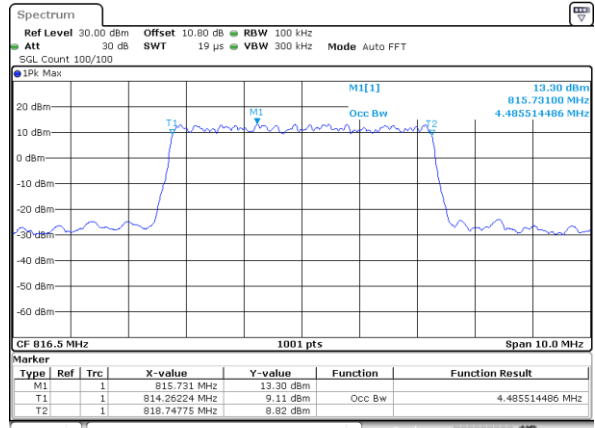

Date: 15.FEB.2020 04:10:16

Middle Channel / 5MHz / QPSK

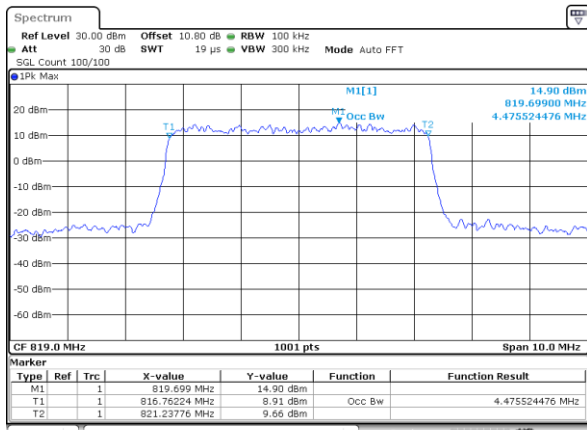

Date: 15.FEB.2020 04:07:11

Middle Channel / 5MHz / 16QAM

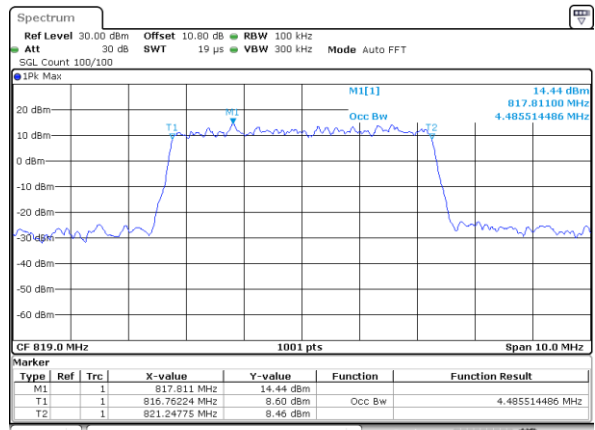

Date: 15.FEB.2020 04:07:25

Highest Channel / 5MHz / QPSK

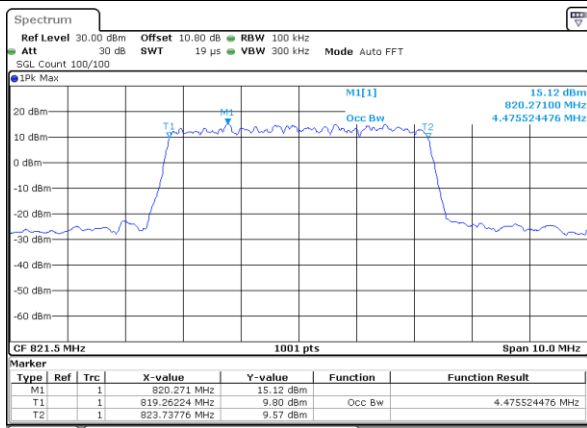

Date: 15.FEB.2020 04:10:20

Highest Channel / 5MHz / 16QAM

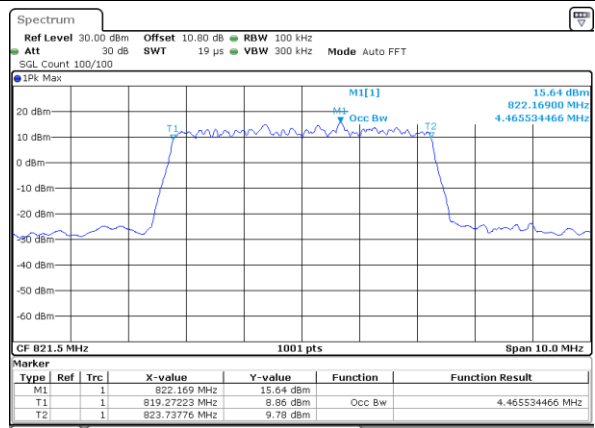

Date: 15.FEB.2020 04:10:34



LTE Band 26

Middle Channel / 10MHz / QPSK

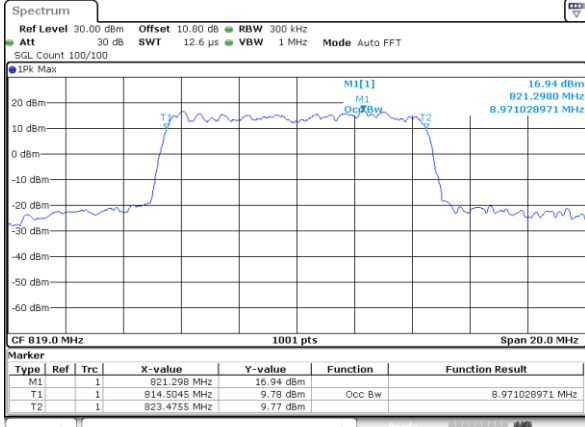

Date: 15.FEB.2020 04:13:31

Middle Channel / 10MHz / 16QAM

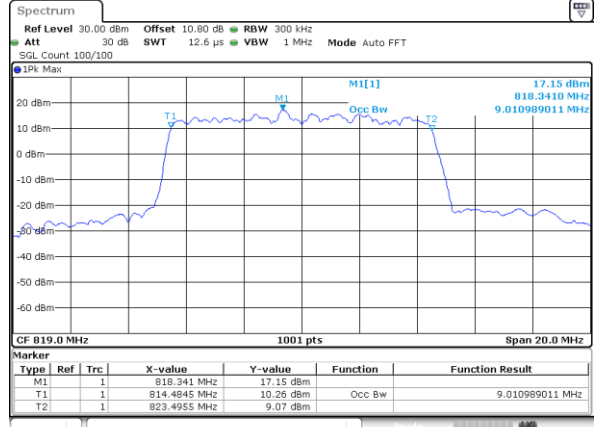

Date: 15.FEB.2020 04:13:45

LTE Band 26

Lowest Channel / 15MHz / QPSK

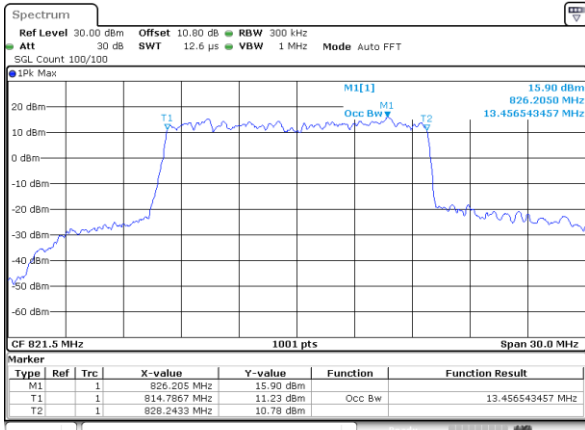

Date: 15.FEB.2020 04:16:41

Lowest Channel / 15MHz / 16QAM

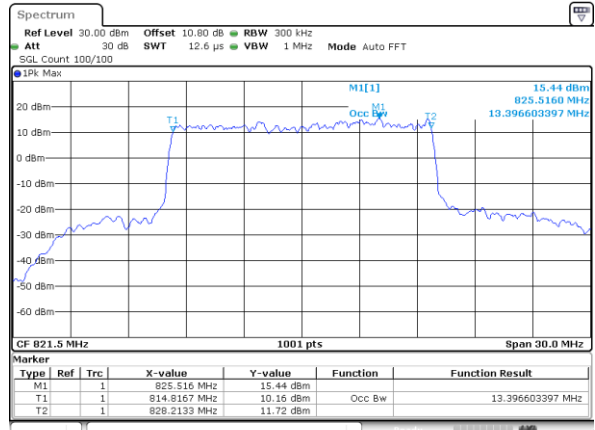

Date: 15.FEB.2020 04:16:55



LTE Band 26

Lowest Channel / 1.4MHz / 64QAM

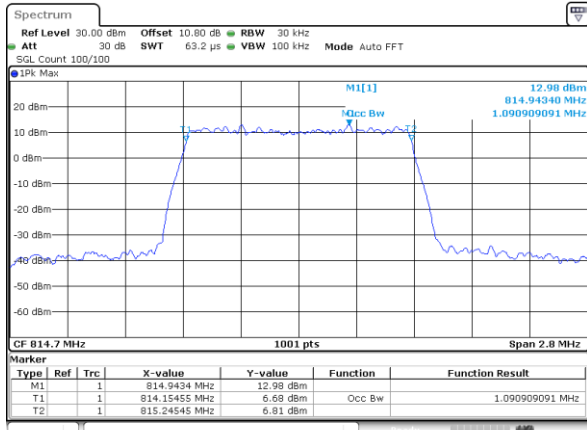

Date: 15.FEB.2020 03:49:46

Lowest Channel / 3MHz / 64QAM

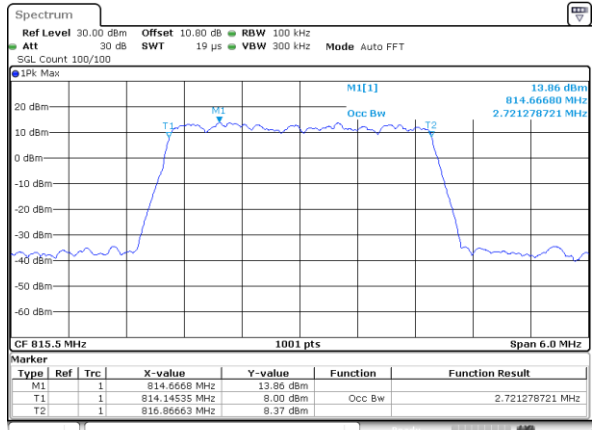

Date: 15.FEB.2020 03:13:150

Middle Channel / 1.4MHz / 64QAM

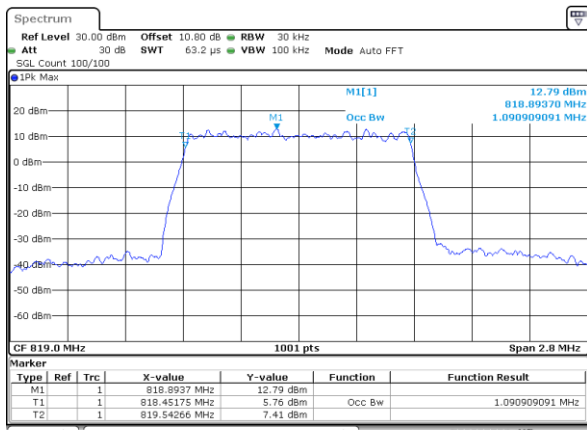

Date: 15.FEB.2020 03:51:21

Middle Channel / 3MHz / 64QAM

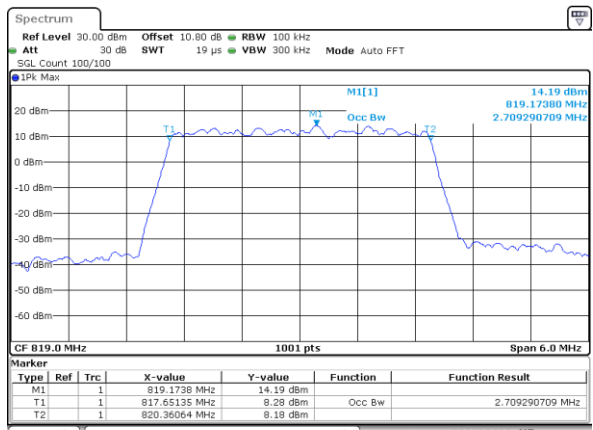

Date: 15.FEB.2020 03:13:625

Highest Channel / 1.4MHz / 64QAM

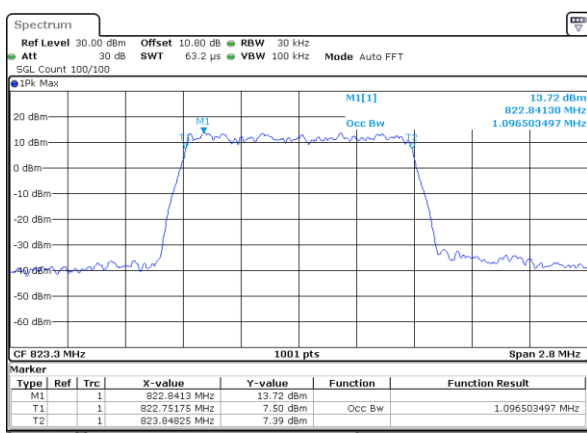

Date: 15.FEB.2020 03:52:16

Highest Channel / 3MHz / 64QAM

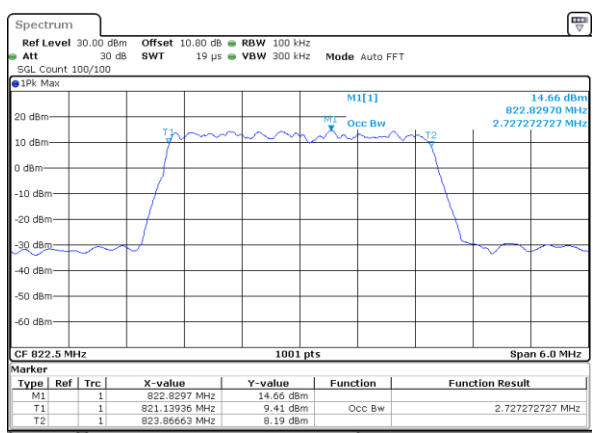

Date: 15.FEB.2020 03:13:800



LTE Band 26

Lowest Channel / 5MHz / 64QAM

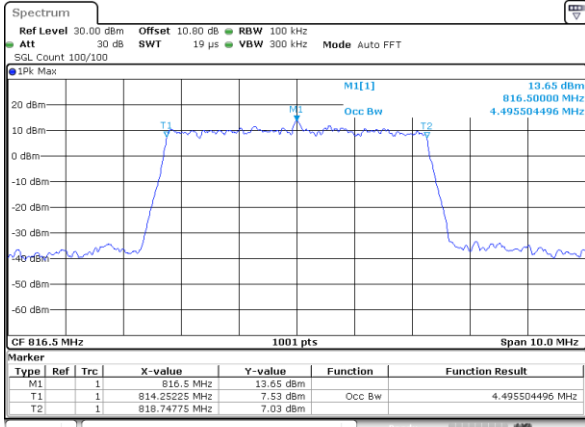

Date: 15.FEB.2020 03:39:35

Middle Channel / 5MHz / 64QAM

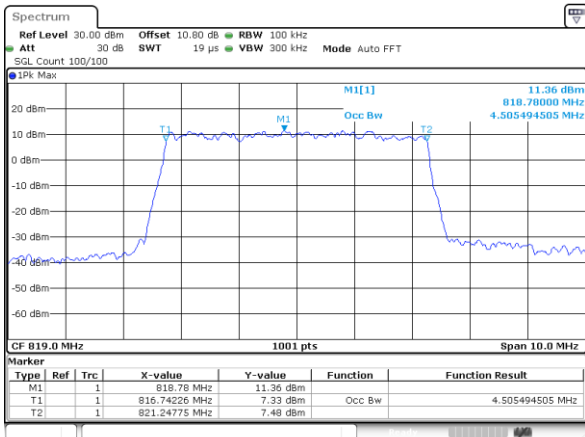

Date: 15.FEB.2020 03:41:10

Middle Channel / 10MHz / 64QAM

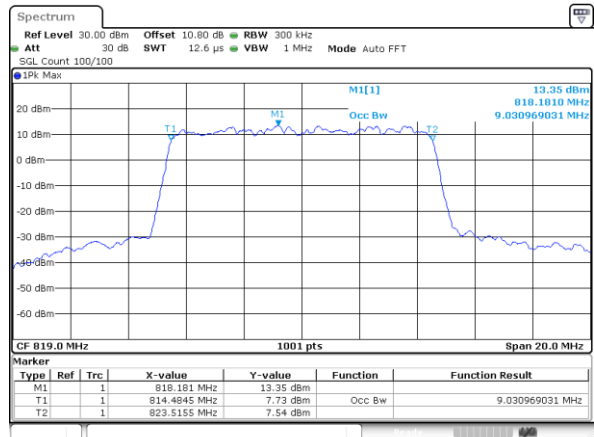

Date: 15.FEB.2020 03:44:21

Highest Channel / 5MHz / 64QAM

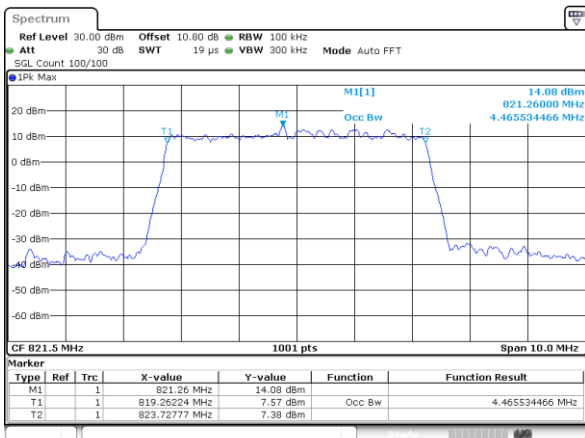

Date: 15.FEB.2020 03:42:45



LTE Band 26

Lowest Channel / 15MHz / 64QAM

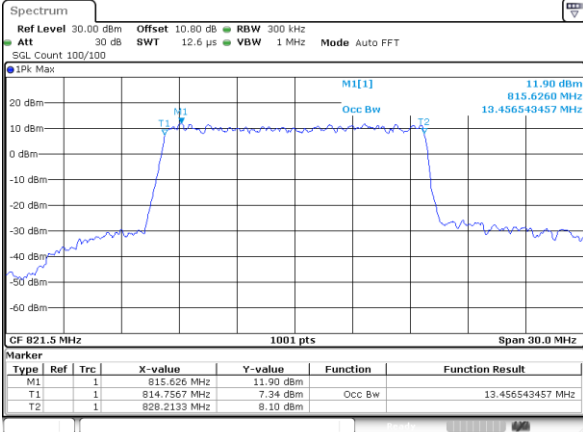



Conducted Band Edge

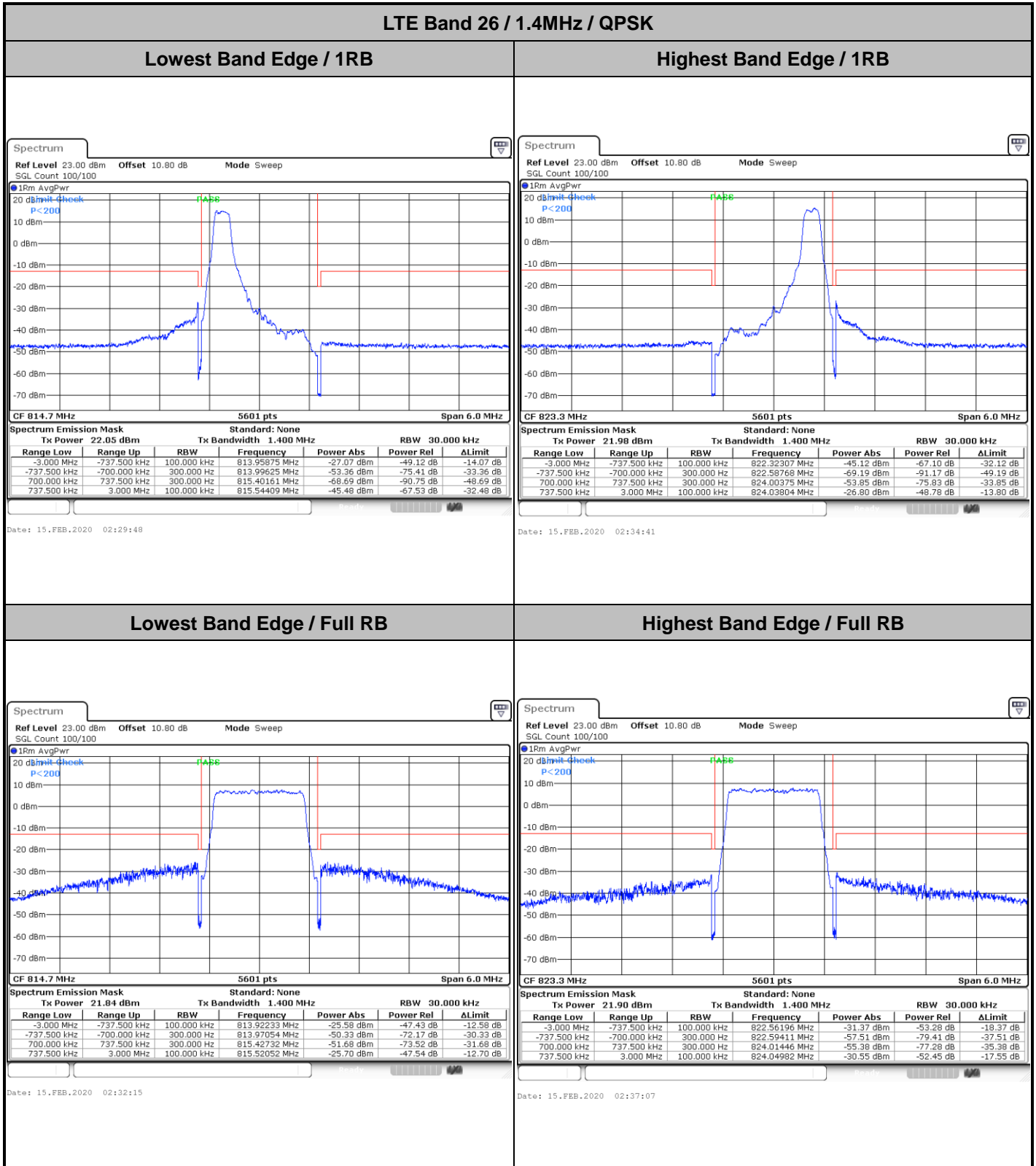



LTE Band 26 / 1.4MHz / 16QAM

Lowest Band Edge / 1 RB

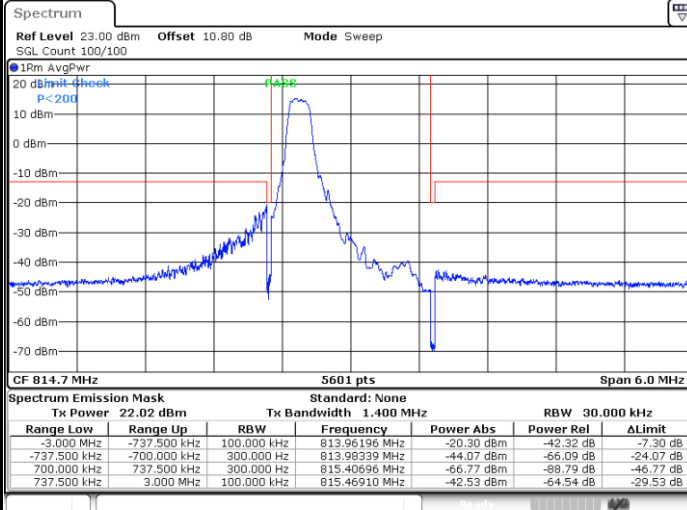

Date: 15.FEB.2020 02:31:01

Highest Band Edge / 1 RB

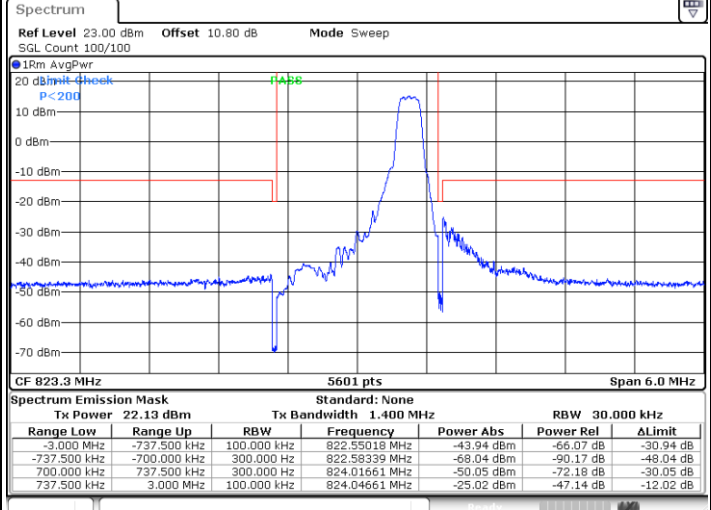

Date: 15.FEB.2020 02:35:54

Lowest Band Edge / Full RB

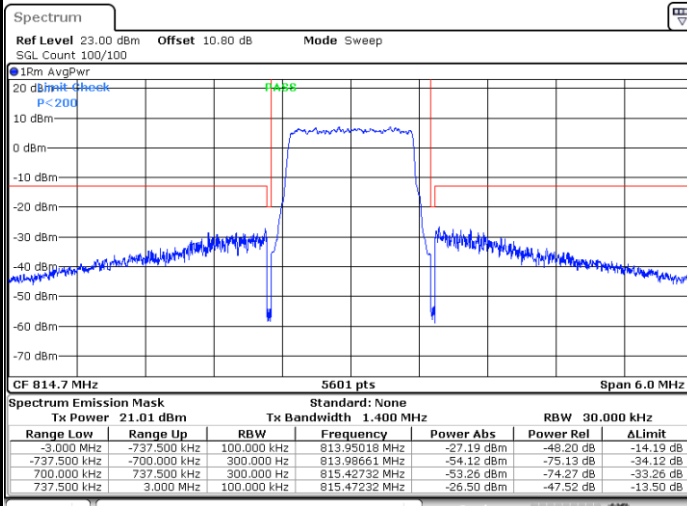

Date: 15.FEB.2020 02:33:28

Highest Band Edge / Full RB

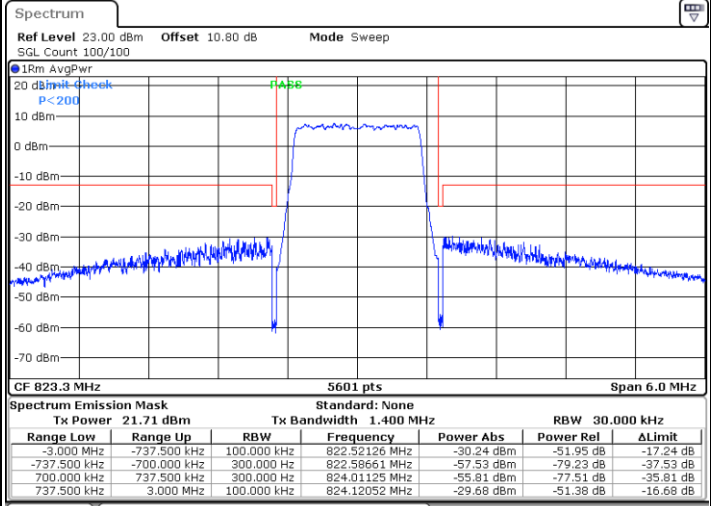

Date: 15.FEB.2020 02:38:20



LTE Band 26 / 1.4MHz / 64QAM

Lowest Band Edge / 1 RB

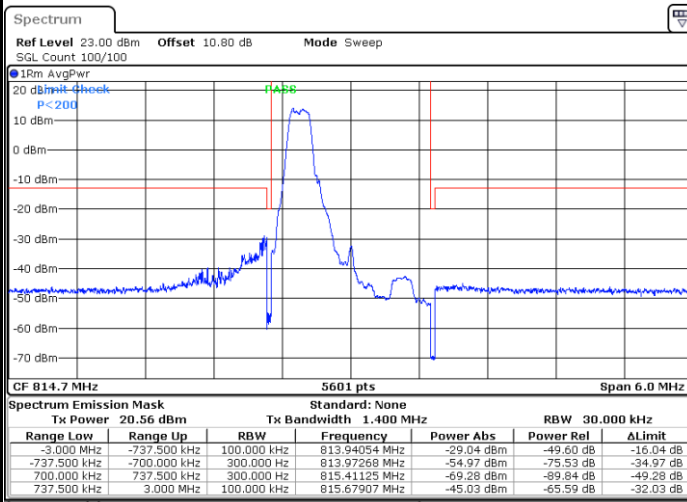

Date: 15.FEB.2020 03:13:47

Highest Band Edge / 1 RB

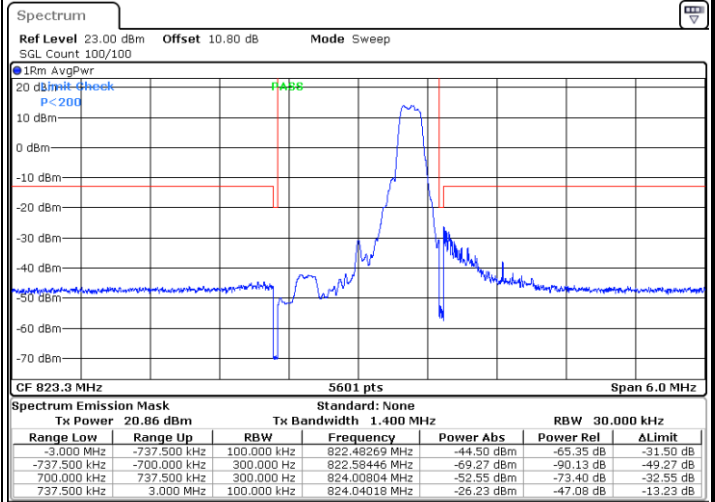

Date: 15.FEB.2020 03:16:13

Lowest Band Edge / Full RB

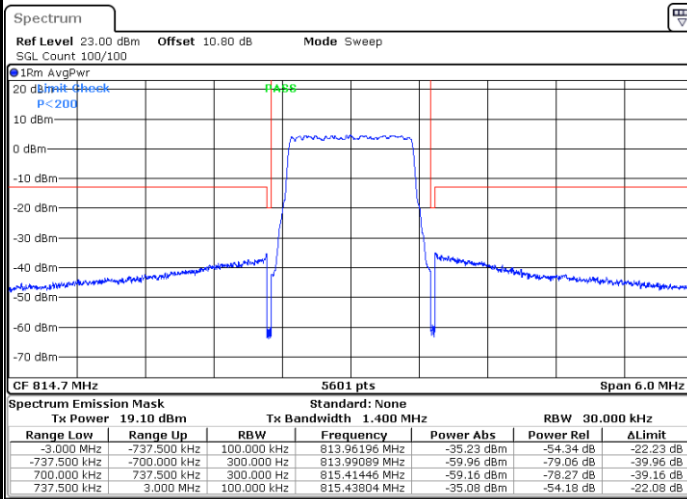

Date: 15.FEB.2020 03:15:00

Highest Band Edge / Full RB

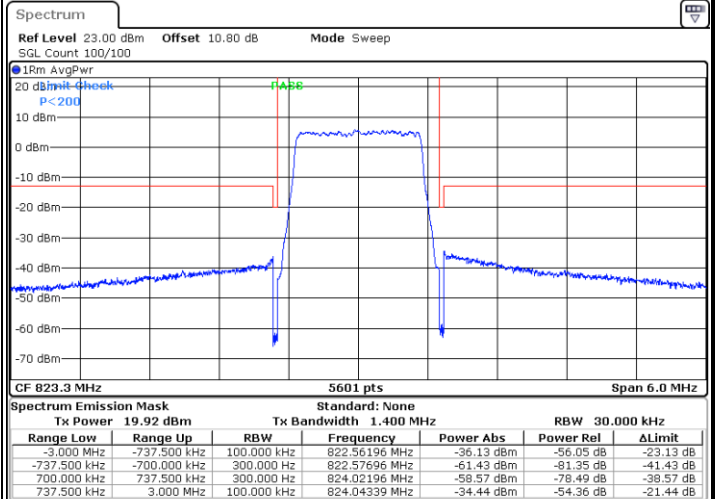

Date: 15.FEB.2020 03:17:26



LTE Band 26 / 3MHz / QPSK

Lowest Band Edge / 1RB

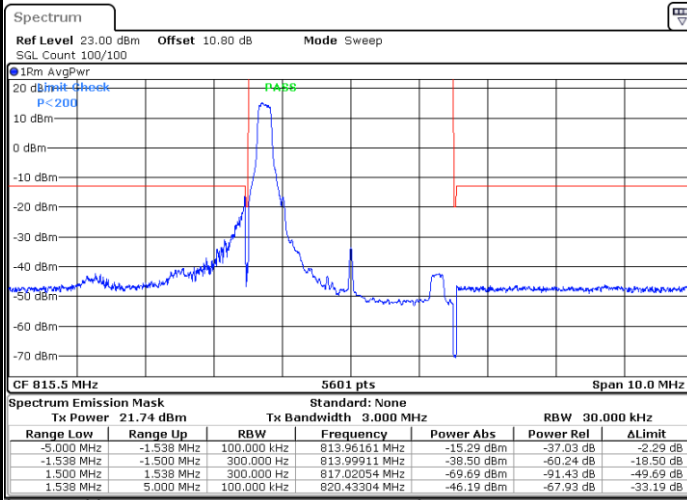

Date: 15.FEB.2020 02:40:51

Highest Band Edge / 1 RB

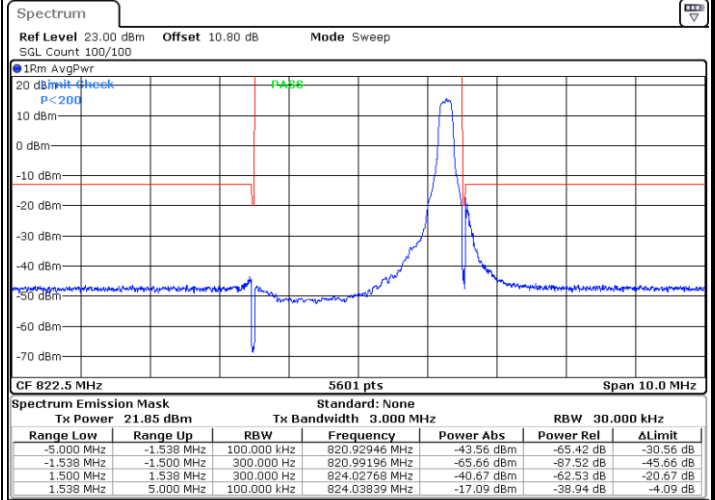

Date: 15.FEB.2020 02:44:35

Lowest Band Edge / Full RB

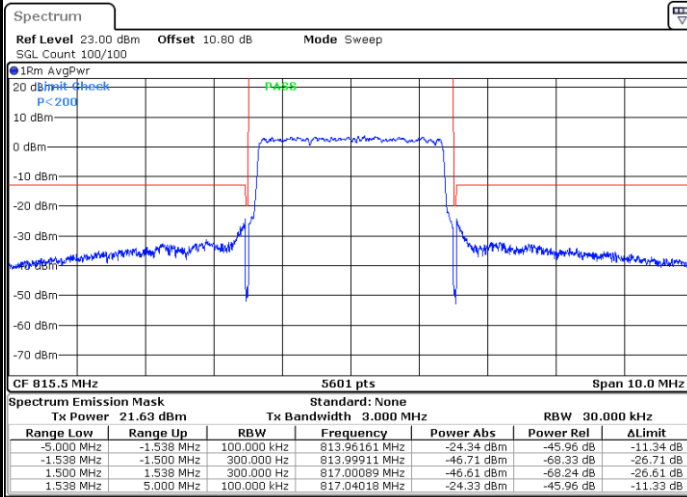

Date: 15.FEB.2020 02:42:06

Highest Band Edge / Full RB

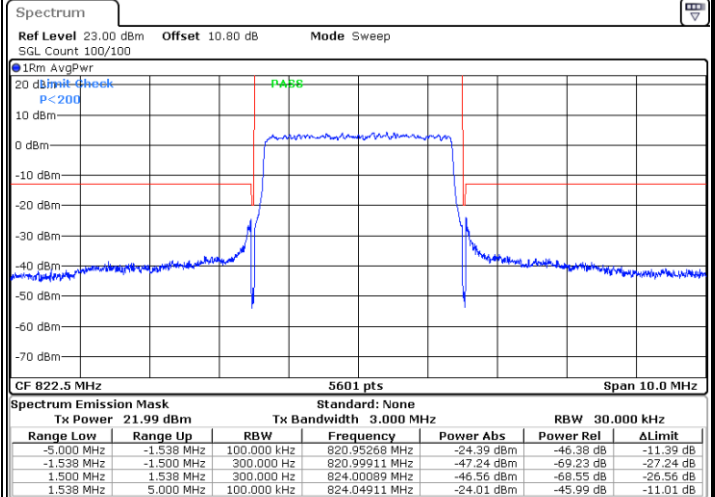

Date: 15.FEB.2020 02:47:04



LTE Band 26 / 3MHz / 16QAM

Lowest Band Edge / 1 RB

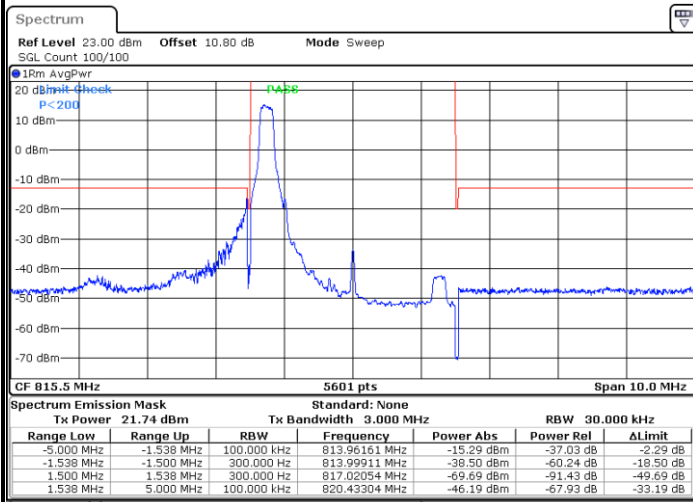

Date: 15.FEB.2020 02:40:51

Highest Band Edge / 1 RB

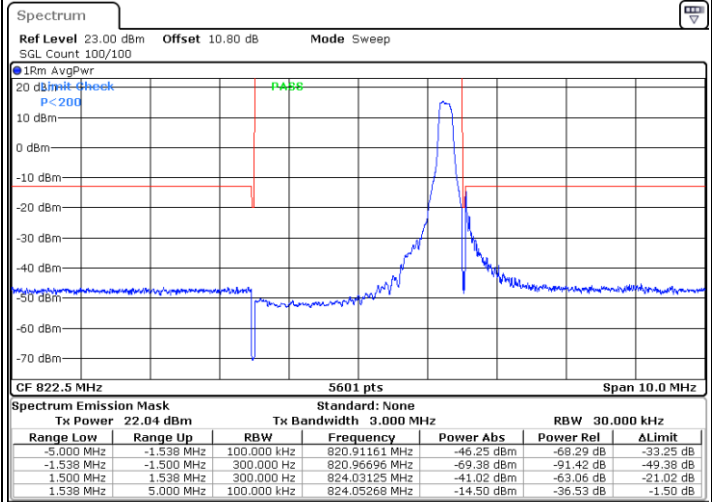

Date: 15.FEB.2020 02:45:50

Lowest Band Edge / Full RB

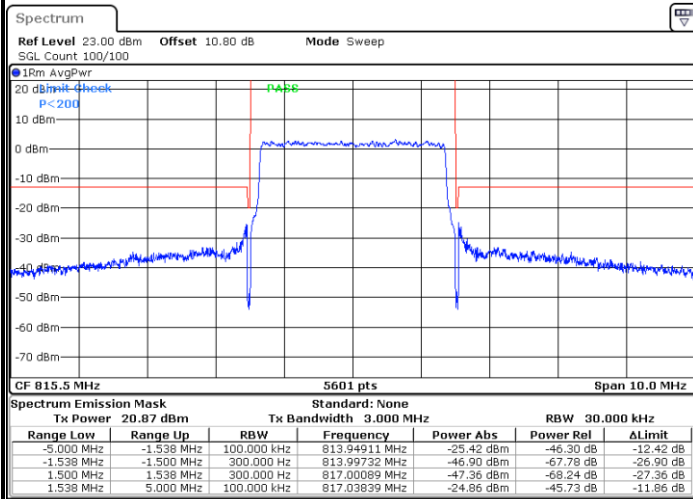

Date: 15.FEB.2020 02:43:21

Highest Band Edge / Full RB

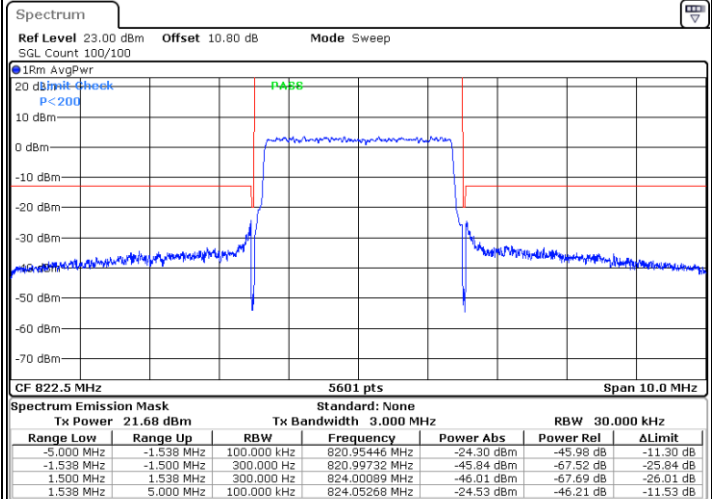

Date: 15.FEB.2020 02:48:19



LTE Band 26 / 3MHz / 64QAM

Lowest Band Edge / 1 RB

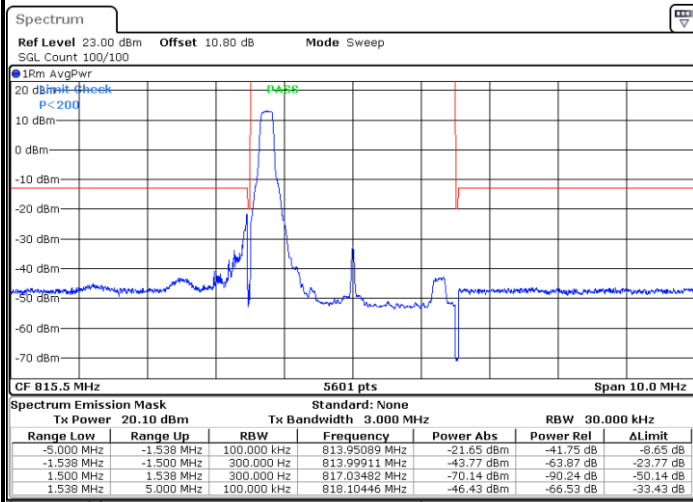

Date: 15.FEB.2020 03:18:43

Highest Band Edge / 1 RB

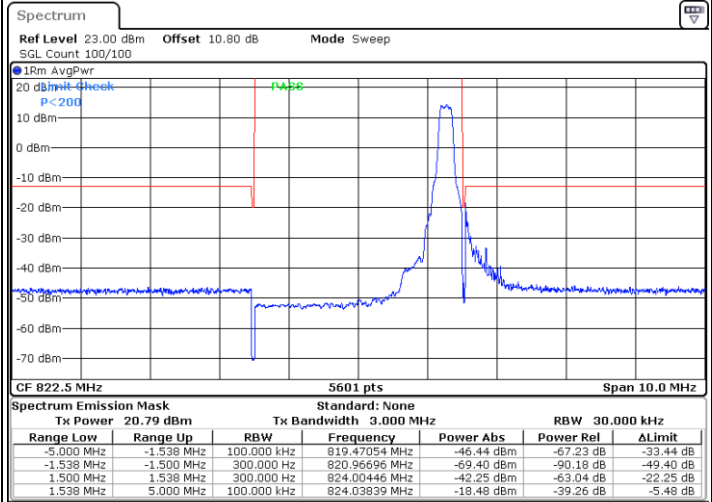

Date: 15.FEB.2020 03:21:12

Lowest Band Edge / Full RB

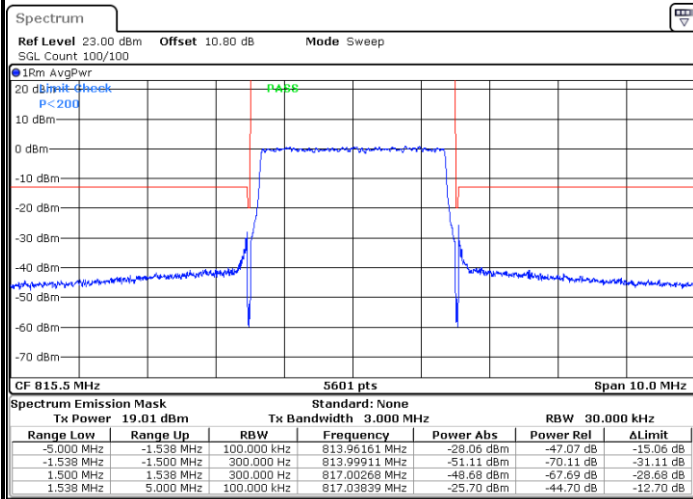

Date: 15.FEB.2020 03:19:57

Highest Band Edge / Full RB

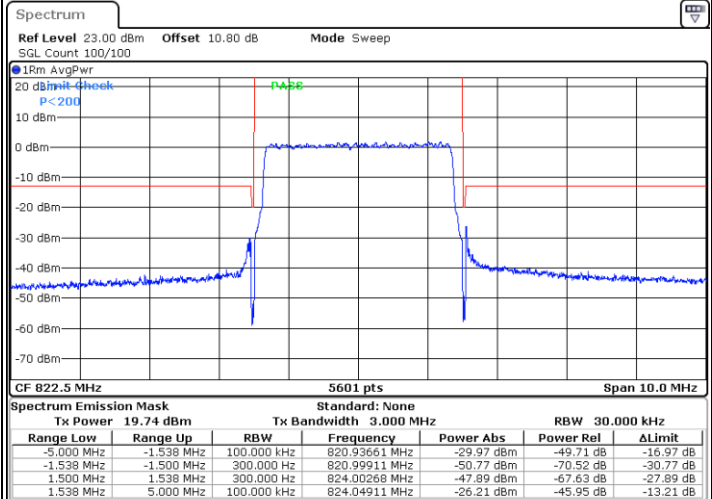

Date: 15.FEB.2020 03:22:26



LTE Band 26 / 5MHz / QPSK

Lowest Band Edge / 1 RB

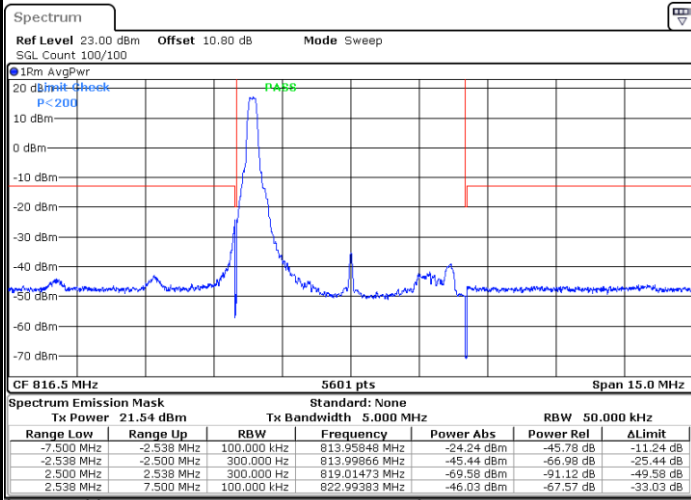

Date: 15.FEB.2020 02:49:33

Highest Band Edge / 1 RB

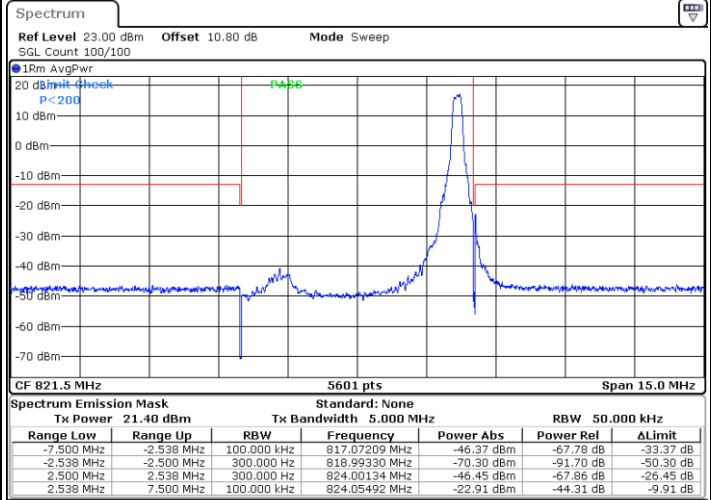

Date: 15.FEB.2020 02:54:23

Lowest Band Edge / Full RB

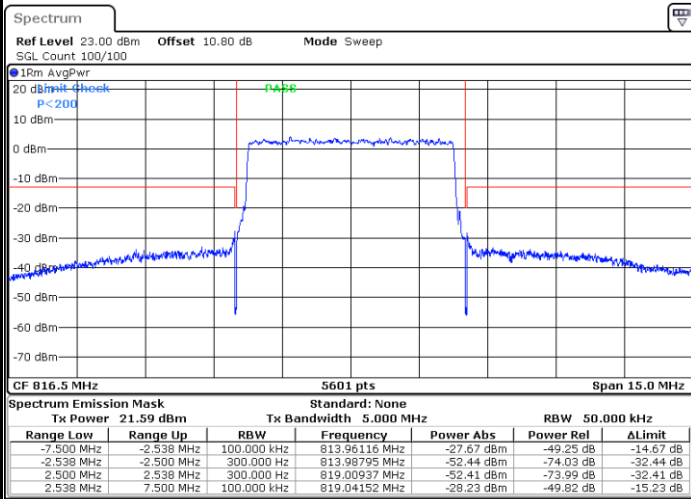

Date: 15.FEB.2020 02:51:58

Highest Band Edge / Full RB

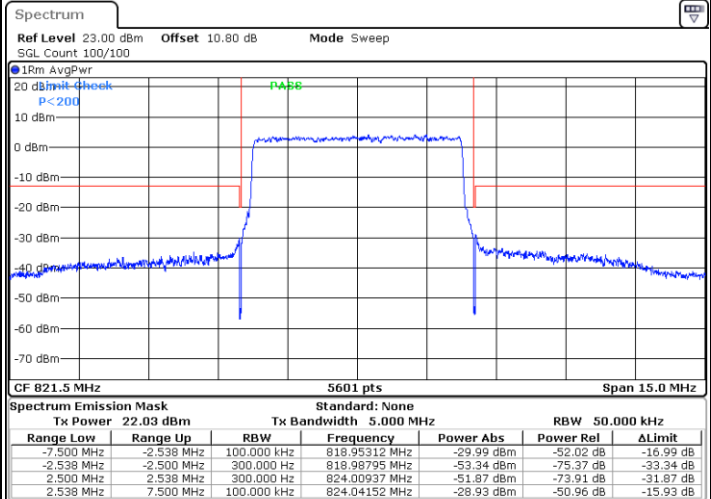

Date: 15.FEB.2020 02:56:49



LTE Band 26 / 5MHz / 16QAM

Lowest Band Edge / 1RB

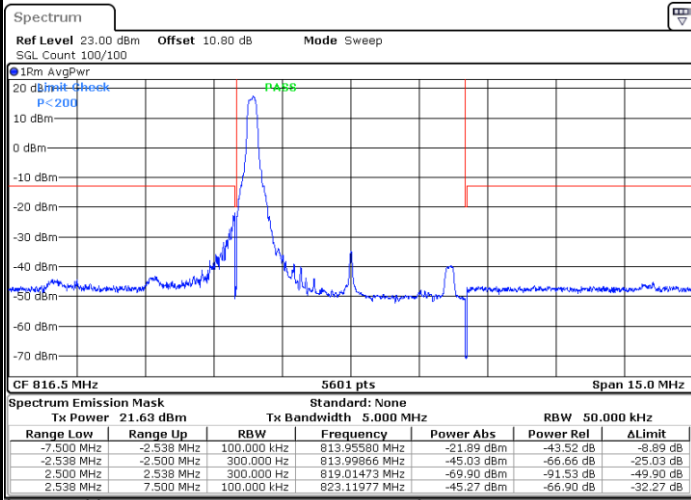

Date: 15.FEB.2020 02:50:46

Highest Band Edge / 1 RB

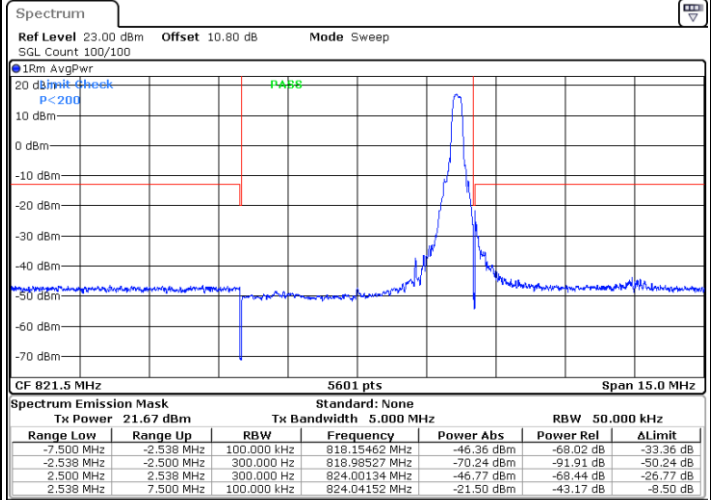

Date: 15.FEB.2020 02:55:36

Lowest Band Edge / Full RB

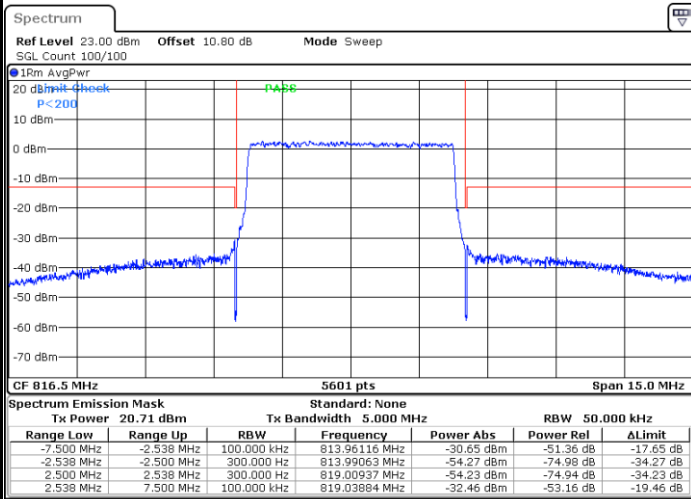

Date: 15.FEB.2020 02:53:11

Highest Band Edge / Full RB

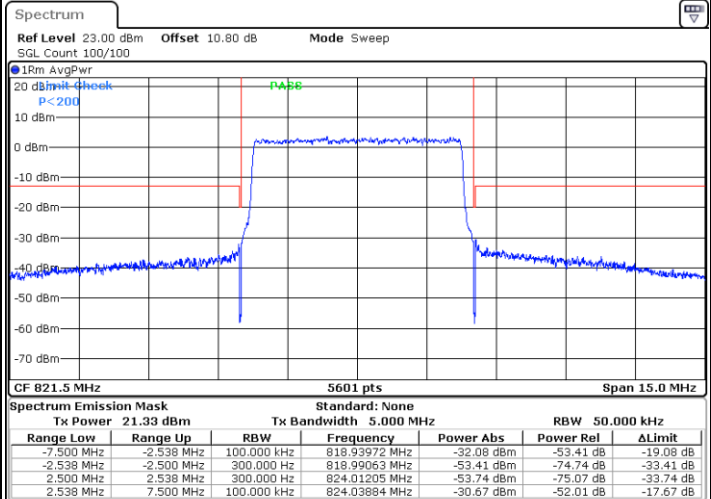

Date: 15.FEB.2020 02:58:01