



FCC RF Test Report

APPLICANT : Motorola Mobility LLC
EQUIPMENT : Mobile Phone
BRAND NAME : Motorola
MODEL NAME : XT2055-2
FCC ID : IHDT56YT1
STANDARD : 47 CFR Part 2, 22(H), 24(E), 27(L), 27(M)
CLASSIFICATION : PCS Licensed Transmitter Held to Ear (PCE)

The product was received on Dec. 10, 2019 and completely tested on Dec. 30, 2019. We, Sporton International (Kunshan) Inc., would like to declare that the tested sample has been evaluated in accordance with the procedures given in ANSI C63.26-2015 and shown compliance with the applicable technical standards.

The test results in this report apply exclusively to the tested model / sample. Without written approval of Sporton International (Kunshan) Inc., the test report shall not be reproduced except in full.

Jason Jia

Reviewed by: Jason Jia / Supervisor

James Huang

Approved by: James Huang / Manager



Sporton International (Kunshan) Inc.

No. 1098, Pengxi North Road, Kunshan Economic Development Zone Jiangsu Province 215300
People's Republic of China



TABLE OF CONTENTS

REVISION HISTORY...3
SUMMARY OF TEST RESULT...4
1 GENERAL DESCRIPTION...5
1.1 Applicant...5
1.2 Manufacturer...5
1.3 Product Feature of Equipment Under Test...5
1.4 Product Specification of Equipment Under Test...6
1.5 Specification of Accessory...7
1.6 Modification of EUT...7
1.7 Maximum ERP/EIRP Power, Frequency Tolerance, and Emission Designator...8
1.8 Testing Location...11
1.9 Test Software...11
1.10 Applicable Standards...11
2 TEST CONFIGURATION OF EQUIPMENT UNDER TEST...12
2.1 Test Mode...12
2.2 Connection Diagram of Test System...13
2.3 Support Unit used in test configuration and system...14
2.4 Measurement Results Explanation Example...14
2.5 Frequency List of Low/Middle/High Channels...15
3 CONDUCTED TEST ITEMS...18
3.1 Measuring Instruments...18
3.2 Test Setup...18
3.3 Test Result of Conducted Test...18
3.4 Conducted Output Power and ERP/EIRP...19
3.5 Peak-to-Average Ratio...20
3.6 Occupied Bandwidth...21
3.7 Conducted Band Edge...22
3.8 Conducted Spurious Emission...24
3.9 Frequency Stability...25
4 RADIATED TEST ITEMS...26
4.1 Measuring Instruments...26
4.2 Test Setup...26
4.3 Test Result of Radiated Test...26
4.4 Radiated Spurious Emission...27
5 LIST OF MEASURING EQUIPMENT...28
6 UNCERTAINTY OF EVALUATION...29
APPENDIX A. TEST RESULTS OF CONDUCTED TEST
APPENDIX B. TEST RESULTS OF RADIATED TEST
APPENDIX C. TEST SETUP PHOTOGRAPHS



REVISION HISTORY

REPORT NO.	VERSION	DESCRIPTION	ISSUED DATE
FG9D1003-01B	Rev. 01	Initial issue of report	Jan. 14, 2020
FG9D1003-01B	Rev. 02	Updated Accessory	Jan. 17, 2020



SUMMARY OF TEST RESULT

Report Section	FCC Rule	Description	Limit	Result	Remark
3.4	§2.1046	Conducted Output Power	Reporting Only	PASS	-
	§22.913(a)(5)	Effective Radiated Power (Band 5)	ERP < 7 Watt	PASS	-
	§24.232(c) §27.50(h)(2)	Equivalent Isotropic Radiated Power (Band 2) (Band 7)	EIRP < 2Watt	PASS	-
	§27.50(d)(4)	Equivalent Isotropic Radiated Power (Band 4) (Band 66)	EIRP < 1Watt	PASS	-
3.5	§24.232(d)	Peak-to-Average Ratio	<13 dB	PASS	-
3.6	§2.1049	Occupied Bandwidth	Reporting Only	PASS	-
3.7	§2.1051 §22.917(a) §24.238(a) §27.53(h)	Conducted Band Edge Measurement (Band 2) (Band 4) (Band 5) (Band 66)	< 43+10log ₁₀ (P[Watts])	PASS	-
	§27.53(m)(4)	Conducted Band Edge Measurement (Band 7)	§27.53(m)(4)		
3.8	§2.1051 §22.917(a) §24.238(a) §27.53(h)	Conducted Spurious Emission (Band 2) (Band 4) (Band 5) (Band 66)	< 43+10log ₁₀ (P[Watts])	PASS	-
	§2.1051 §27.53(m)(4)	Conducted Spurious Emission (Band 7)	< 55+10log ₁₀ (P[Watts])		
3.9	§2.1055 §22.355	Frequency Stability Temperature & Voltage	< 2.5 ppm for Part 22	PASS	-
	§2.1055 §24.235 §27.54		Within Authorized Band		
4.4	§2.1053 §22.917(a) §24.238(a) §27.53(h)	Radiated Spurious Emission (Band 2) (Band 4) (Band 5) (Band 66)	< 43+10log ₁₀ (P[Watts])	PASS	Under limit 27.85 dB at 7580.00 MHz
	§2.1053 §27.53(m)(4)	Radiated Spurious Emission (Band 7)	< 55+10log ₁₀ (P[Watts])		

Declaration of Conformity:

The test results with all measurement uncertainty excluded are presented in accordance with the regulation limits or requirements declared by manufacturers.

Comments and Explanations:

The declared of product specification for EUT presented in the report are provided by the manufacturer, and the manufacturer takes all the responsibilities for the accuracy of product specification.



1 General Description

1.1 Applicant

Motorola Mobility LLC
222 W, Merchandise Mart Plaza,Chicago,IL60654 USA

1.2 Manufacturer

Motorola Mobility LLC
222 W, Merchandise Mart Plaza,Chicago,IL60654 USA

1.3 Product Feature of Equipment Under Test

Product Feature	
Equipment	Mobile Phone
Brand Name	Motorola
Model Name	XT2055-2
FCC ID	IHDT56YT1
EUT supports Radios application	GSM/WCDMA/LTE WLAN 2.4GHz 802.11b/g/n HT20 Bluetooth BR/EDR/LE GNSS/FM Receiver
IMEI Code	Conducted: 351621110012356/351621110020854 Radiation: 351621110012398/351621110020896
HW Version	DVT2
SW Version	POD29.236
EUT Stage	Identical Prototype



1.4 Product Specification of Equipment Under Test

Standards-related Product Specification	
Tx Frequency	LTE Band 2 : 1850.7 MHz ~ 1909.3 MHz LTE Band 4 : 1710.7 MHz ~ 1754.3 MHz LTE Band 5 : 824.7 MHz ~ 848.3 MHz LTE Band 7 : 2502.5 MHz ~ 2567.5 MHz LTE Band 66 : 1710.7 MHz ~ 1779.3 MHz
Rx Frequency	LTE Band 2 : 1930.7 MHz ~ 1989.3 MHz LTE Band 4 : 2110.7 MHz ~ 2154.3 MHz LTE Band 5 : 869.7 MHz ~ 893.3 MHz LTE Band 7 : 2622.5MHz ~ 2687.5 MHz LTE Band 66 : 2110.7 MHz~ 2179.3 MHz
Bandwidth	LTE Band 2 : 1.4MHz / 3MHz / 5MHz / 10MHz / 15MHz / 20MHz LTE Band 4 : 1.4MHz / 3MHz / 5MHz / 10MHz / 15MHz / 20MHz LTE Band 5 : 1.4MHz / 3MHz / 5MHz / 10MHz LTE Band 7 : 5MHz / 10MHz / 15MHz / 20MHz LTE Band 66 : 1.4MHz / 3MHz / 5MHz / 10MHz / 15MHz / 20MHz
Maximum Output Power to Antenna	LTE Band 2 : 23.67 dBi LTE Band 4 : 23.81 dBi LTE Band 5 : 23.89 dBi LTE Band 7 : 23.46 dBi LTE Band 66 : 23.85 dBi
Antenna Gain	LTE Band 2 : -5.79 dBm LTE Band 4 : -1.78 dBm LTE Band 5 : -3.77 dBm LTE Band 7 : -0.90 dBm LTE Band 66 : -1.78 dBm
Type of Modulation	QPSK / 16QAM / 64QAM

1.5 Specification of Accessory

Specification of Accessory				
AC Adapter 1(US)	Brand Name	Motorola (Acbel)	Model Name	SC-41
	Power Rating	I/P: 100-240 Vac, 300mA, O/P: 5Vdc, 2000mA		
AC Adapter 1(EU)	Brand Name	Motorola (Acbel)	Model Name	SC-42
	Power Rating	I/P: 100-240 Vac, 300mA, O/P: 5Vdc, 2000mA		
AC Adapter 1(AR)	Brand Name	Motorola (Acbel)	Model Name	SC-46
	Power Rating	I/P: 100-240 Vac, 300mA, O/P: 5Vdc, 2000mA		
AC Adapter 2(US)	Brand Name	Motorola (Chenyang)	Model Name	SC-41
	Power Rating	I/P: 100-240 Vac, 300mA, O/P: 5Vdc, 2000mA		
AC Adapter 2(EU)	Brand Name	Motorola (Chenyang)	Model Name	SC-42
	Power Rating	I/P: 100-240 Vac, 300mA, O/P: 5Vdc, 2000mA		
AC Adapter 2(AR)	Brand Name	Motorola (Chenyang)	Model Name	SC-46
	Power Rating	I/P: 100-240 Vac, 300mA, O/P: 5Vdc, 2000mA		
AC Adapter 3(Chile)	Brand Name	Motorola (Salom)	Model Name	SC-42
	Power Rating	I/P: 100-240 Vac, 300mA, O/P: 5Vdc, 2000mA		
AC Adapter 4(BR)	Brand Name	Motorola (Salom/Flex)	Model Name	SC-47
	Power Rating	I/P: 100-240 Vac, 130mA, O/P: 5Vdc, 2000mA		
AC Adapter 5(BR)	Brand Name	Motorola (Cliptech/Tenpao)	Model Name	SC-47
	Power Rating	I/P: 100-240 Vac, 130mA, O/P: 5Vdc, 2000mA		
Battery 1	Brand Name	Motorola(SCUD)	Model Name	JK50
	Power Rating	4.4Vdc, 5000mAh	Type	Li-ion polymer
Battery 2	Brand Name	Motorola(ATL)	Model Name	JK50
	Power Rating	4.4Vdc, 5000mAh	Type	Li-ion polymer
Earphone 1	Brand Name	Motorola (New Leader)	Model Name	NLD-EM303H-13SF
	Signal Line Type	1.2 meter, non-shielded cable, without ferrite core		
Earphone 2	Brand Name	Motorola (Ju wei)	Model Name	JWEP1141-ZN01
	Signal Line Type	1.2 meter, non-shielded cable, without ferrite core		
USB Cable 1	Brand Name	Motorola (SaiBao)	Model Name	SZN-A007A
	Signal Line Type	1.0 meter, shielded cable, without ferrite core		
USB Cable 2	Brand Name	Motorola (Ju wei)	Model Name	JWUB1451-ZN01
	Signal Line Type	1.0 meter, shielded cable, without ferrite core		
USB Cable 3	Brand Name	Motorola (I SHENG)	Model Name	SKN6472A
	Signal Line Type	1.0 meter, shielded cable, without ferrite core		

1.6 Modification of EUT

No modifications are made to the EUT during all test items.



1.7 Maximum ERP/EIRP Power, Frequency Tolerance, and Emission Designator

LTE Band 2		QPSK			16QAM		
BW (MHz)	Frequency Range (MHz)	Emission Designator (99%OBW)	Frequency Tolerance (ppm)	Maximum EIRP(W)	Emission Designator (99%OBW)	Frequency Tolerance (ppm)	Maximum EIRP(W)
1.4	1850.7 ~ 1909.3	1M09G7D	-	0.0610	1M10W7D	-	0.0511
3	1851.5 ~ 1908.5	2M72G7D	-	0.0603	2M73W7D	-	0.0502
5	1852.5 ~ 1907.5	4M49G7D	-	0.0596	4M50W7D	-	0.0522
10	1855.0 ~ 1905.0	9M09G7D	0.0026	0.0612	9M07W7D	-	0.0518
15	1857.5 ~ 1902.5	13M5G7D	-	0.0611	13M5W7D	-	0.0521
20	1860.0 ~ 1900.0	18M5G7D	-	0.0614	18M4W7D	-	0.0490
LTE Band 2		64QAM					
BW (MHz)	Frequency Range (MHz)	Emission Designator (99%OBW)	Frequency Tolerance (ppm)		Maximum EIRP(W)		
1.4	1850.7 ~ 1909.3	1M10W7D	-		0.0391		
3	1851.5 ~ 1908.5	2M72W7D	-		0.0389		
5	1852.5 ~ 1907.5	4M48W7D	-		0.0402		
10	1855.0 ~ 1905.0	9M07W7D	-		0.0396		
15	1857.5 ~ 1902.5	13M5W7D	-		0.0402		
20	1860.0 ~ 1900.0	18M4W7D	-		0.0381		



LTE Band 4		QPSK			16QAM		
BW (MHz)	Frequency Range (MHz)	Emission Designator (99%OBW)	Frequency Tolerance (ppm)	Maximum EIRP(W)	Emission Designator (99%OBW)	Frequency Tolerance (ppm)	Maximum EIRP(W)
1.4	1710.7 ~ 1754.3	1M09G7D	-	0.1600	1M09W7D	-	0.1318
3	1711.5 ~ 1753.5	2M72G7D	-	0.1581	2M72W7D	-	0.1324
5	1712.5 ~ 1752.5	4M49G7D	-	0.1592	4M50W7D	-	0.1303
10	1715.0 ~ 1750.0	9M05G7D	0.0043	0.1592	9M05W7D	-	0.1315
15	1717.5 ~ 1747.5	13M5G7D	-	0.1607	13M5W7D	-	0.1309
20	1720.0 ~ 1745.0	18M4G7D	-	0.1611	18M5W7D	-	0.1291
LTE Band 4		64QAM					
BW (MHz)	Frequency Range (MHz)	Emission Designator (99%OBW)	Frequency Tolerance (ppm)		Maximum EIRP(W)		
1.4	1710.7 ~ 1754.3	1M09W7D	-		0.1030		
3	1711.5 ~ 1753.5	2M72W7D	-		0.1033		
5	1712.5 ~ 1752.5	4M49W7D	-		0.1033		
10	1715.0 ~ 1750.0	9M03W7D	-		0.1050		
15	1717.5 ~ 1747.5	13M6W7D	-		0.1038		
20	1720.0 ~ 1745.0	18M5W7D	-		0.1005		
LTE Band 5		QPSK			16QAM		
BW (MHz)	Frequency Range (MHz)	Emission Designator (99%OBW)	Frequency Tolerance (ppm)	Maximum ERP(W)	Emission Designator (99%OBW)	Frequency Tolerance (ppm)	Maximum ERP(W)
1.4	824.7 ~ 848.3	1M09G7D	-	0.0625	1M10W7D	-	0.0528
3	825.5 ~ 847.5	2M71G7D	-	0.0598	2M72W7D	-	0.0512
5	826.5 ~ 846.5	4M50G7D	-	0.0618	4M51W7D	-	0.0526
10	829.0 ~ 844.0	9M09G7D	0.0060	0.0627	9M05W7D	-	0.0531
LTE Band 5		64QAM					
BW (MHz)	Frequency Range (MHz)	Emission Designator (99%OBW)	Frequency Tolerance (ppm)		Maximum ERP(W)		
1.4	824.7 ~ 848.3	1M09W7D	-		0.0407		
3	825.5 ~ 847.5	2M73W7D	-		0.0394		
5	826.5 ~ 846.5	4M51W7D	-		0.0409		
10	829.0 ~ 844.0	9M07W7D	-		0.0406		



LTE Band 7		QPSK			16QAM		
BW (MHz)	Frequency Range (MHz)	Emission Designator (99%OBW)	Frequency Tolerance (ppm)	Maximum EIRP(W)	Emission Designator (99%OBW)	Frequency Tolerance (ppm)	Maximum EIRP(W)
5	2502.5 ~ 2567.5	4M51G7D	-	0.1799	4M50W7D	-	0.1483
10	2505.0 ~ 2565.0	9M03G7D	0.0038	0.1782	9M07W7D	-	0.1493
15	2507.5 ~ 2562.5	13M5G7D	-	0.1791	13M5W7D	-	0.1496
20	2510.0 ~ 2560.0	18M4G7D	-	0.1803	18M4W7D	-	0.1459
LTE Band 7		64QAM					
BW (MHz)	Frequency Range (MHz)	Emission Designator (99%OBW)	Frequency Tolerance (ppm)		Maximum EIRP(W)		
5	2502.5 ~ 2567.5	4M49W7D	-		0.1245		
10	2505.0 ~ 2565.0	9M05W7D	-		0.1222		
15	2507.5 ~ 2562.5	13M4W7D	-		0.1230		
20	2510.0 ~ 2560.0	18M4W7D	-		0.1189		
LTE Band 66		QPSK			16QAM		
BW (MHz)	Frequency Range (MHz)	Emission Designator (99%OBW)	Frequency Tolerance (ppm)	Maximum EIRP(W)	Emission Designator (99%OBW)	Frequency Tolerance (ppm)	Maximum EIRP(W)
1.4	1710.7 ~ 1779.3	1M09G7D	-	0.1600	1M09W7D	-	0.1318
3	1711.5 ~ 1778.5	2M72G7D	-	0.1581	2M72W7D	-	0.1324
5	1712.5 ~ 1777.5	4M49G7D	-	0.1592	4M50W7D	-	0.1303
10	1715.0 ~ 1775.0	9M05G7D	0.0043	0.1592	9M05W7D	-	0.1315
15	1717.5 ~ 1772.5	13M5G7D	-	0.1607	13M5W7D	-	0.1309
20	1720.0 ~ 1770.0	18M4G7D	-	0.1611	18M5W7D	-	0.1291
LTE Band 66		64QAM					
BW (MHz)	Frequency Range (MHz)	Emission Designator (99%OBW)	Frequency Tolerance (ppm)		Maximum EIRP(W)		
1.4	1710.7 ~ 1779.3	1M09W7D	-		0.1030		
3	1711.5 ~ 1778.5	2M72W7D	-		0.1033		
5	1712.5 ~ 1777.5	4M49W7D	-		0.1033		
10	1715.0 ~ 1775.0	9M03W7D	-		0.1050		
15	1717.5 ~ 1772.5	13M6W7D	-		0.1038		
20	1720.0 ~ 1770.0	18M5W7D	-		0.1005		

Note: LTE Band 66 overlaps the entire frequency range of LTE Band 4. Therefore, the test results provided in this report covers Band 66 as well as Band 4.



1.8 Testing Location

Sporton International (Kunshan) Inc. is accredited to ISO/IEC 17025:2017 by American Association for Laboratory Accreditation with Certificate Number 5145.02.

Test Firm	Sporton International (Kunshan) Inc.		
Test Site Location	No. 1098, Pengxi North Road, Kunshan Economic Development Zone Jiangsu Province 215300 People's Republic of China TEL : +86-512-57900158 FAX : +86-512-57900958		
Test Site No.	Sporton Site No.	FCC Designation No.	FCC Test Firm Registration No.
	03CH04-KS TH01-KS	CN1257	314309

1.9 Test Software

Item	Site	Manufacture	Name	Version
1.	03CH04-KS	AUDIX	E3	6.2009-8-24a

1.10 Applicable Standards

According to the specifications of the manufacturer, the EUT must comply with the requirements of the following standards:

- ♦ 47 CFR Part 2, 22(H), 24(E), 27(L), 27(M)
- ♦ ANSI C63.26-2015
- ♦ FCC KDB 971168 D01 Power Meas License Digital Systems v03r01
- ♦ FCC KDB 412172 D01 Determining ERP and EIRP v01r01

Remark:

1. All test items were verified and recorded according to the standards and without any deviation during the test.
2. This EUT has also been tested and complied with the requirements of FCC Part 15, Subpart B, recorded in a separate test report.



2 Test Configuration of Equipment Under Test

2.1 Test Mode

Antenna port conducted and radiated test items listed below are performed according to KDB 971168 D01 Power Meas License Digital Systems v03r01 with maximum output power.

Radiated measurements are performed by rotating the EUT in three different orthogonal test planes to find the maximum emission.

Test Items	Band	Bandwidth (MHz)						Modulation			RB #			Test Channel		
		1.4	3	5	10	15	20	QPSK	16QAM	64QAM	1	Half	Full	L	M	H
Max. Output Power	2	v	v	v	v	v	v	v	v	v	v	v	v	v	v	v
	4	v	v	v	v	v	v	v	v	v	v	v	v	v	v	v
	5	v	v	v	v	-	-	v	v	v	v	v	v	v	v	v
	7	-	-	v	v	v	v	v	v	v	v	v	v	v	v	v
	66	v	v	v	v	v	v	v	v	v	v	v	v	v	v	v
Peak-to-Average Ratio	2						v	v	v	v	v		v	v	v	v
	5				v	-	-	v	v	v	v		v	v	v	v
	7	-	-				v	v	v	v	v		v	v	v	v
	66						v	v	v	v	v		v	v	v	v
26dB and 99% Bandwidth	2	v	v	v	v	v	v	v	v	v			v	v	v	v
	5	v	v	v	v	-	-	v	v	v			v	v	v	v
	7	-	-	v	v	v	v	v	v	v			v	v	v	v
	66	v	v	v	v	v	v	v	v	v			v	v	v	v
Conducted Band Edge	2	v	v	v	v	v	v	v	v	v	v		v	v		v
	5	v	v	v	v	-	-	v	v	v	v		v	v		v
	7	-	-	v	v	v	v	v	v	v	v		v	v		v
	66	v	v	v	v	v	v	v	v	v	v		v	v		v
Conducted Spurious Emission	2	v	v	v	v	v	v	v	v	v	v			v	v	v
	5	v	v	v	v	-	-	v	v	v	v			v	v	v
	7	-	-	v	v	v	v	v	v	v	v			v	v	v
	66	v	v	v	v	v	v	v	v	v	v			v	v	v
Frequency Stability	2				v			v					v		v	
	5				v	-	-	v					v		v	
	7	-	-		v			v					v		v	
	66				v			v					v		v	

Test Items	Band	Bandwidth (MHz)						Modulation			RB #			Test Channel				
		1.4	3	5	10	15	20	QPSK	16QAM	64QAM	1	Half	Full	L	M	H		
E.R.P / E.I.R.P	2	v	v	v	v	v	v	v	v	v	v			v	v	v		
	5	v	v	v	v	-	-	v	v	v	v			v	v	v		
	7	-	-	v	v	v	v	v	v	v	v			v	v	v		
	66	v	v	v	v	v	v	v	v	v	v			v	v	v		
Radiated Spurious Emission	2	Worst Case															v	
	5	Worst Case															v	
	7	Worst Case															v	
	66	Worst Case															v	
Note	<ol style="list-style-type: none"> The mark "v" means that this configuration is chosen for testing The mark "-" means that this bandwidth is not supported. The device is investigated from 30MHz to 10 times of fundamental signal for radiated spurious emission test under different RB size/offset and modulations in exploratory test. Subsequently, only the worst case emissions are reported. LTE Band 66 overlaps the entire frequency range of LTE Band 4. Therefore, the test results provided in this report covers Band 66 as well as Band 4. 																	

2.2 Connection Diagram of Test System

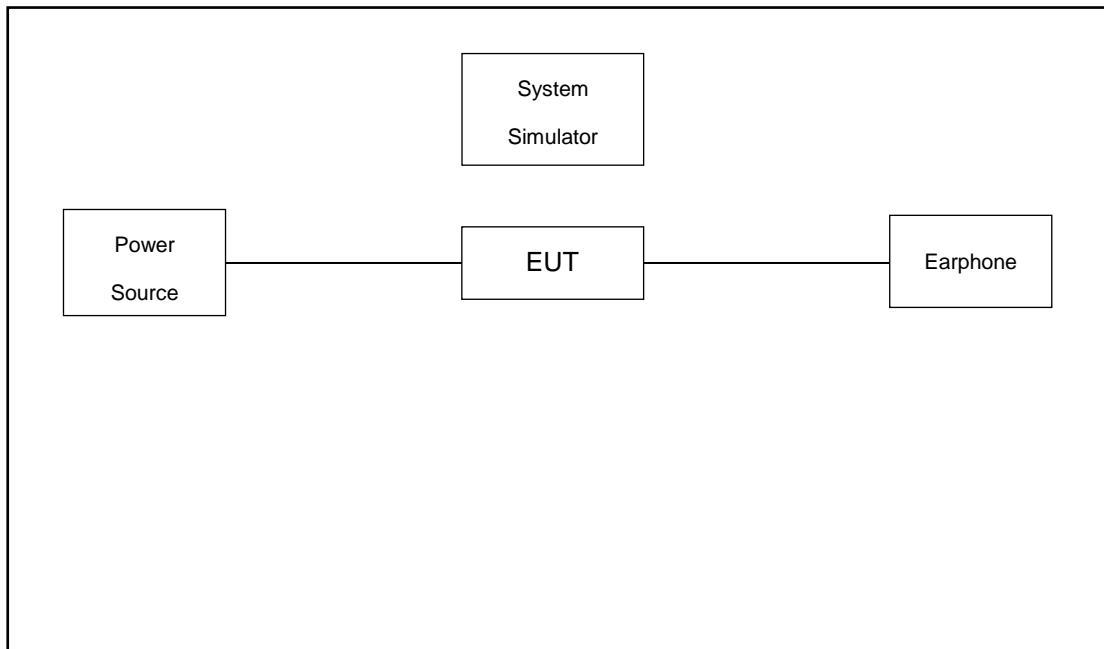



2.3 Support Unit used in test configuration and system

Item	Equipment	Trade Name	Model No.	FCC ID	Data Cable	Power Cord
1.	Power Supply	GWINSTEK	PSS-2002	N/A	N/A	Unshielded, 1.8 m
2.	LTE Base Station	Anritsu	MT8820C	N/A	N/A	Unshielded, 1.8 m

2.4 Measurement Results Explanation Example

For all conducted test items:

The offset level is set in the spectrum analyzer to compensate the RF cable loss and attenuator factor between EUT conducted output port and spectrum analyzer. With the offset compensation, the spectrum analyzer reading level is exactly the EUT RF output level.

The spectrum analyzer offset is derived from RF cable loss and attenuator factor.

Offset = RF cable loss + attenuator factor.

Following shows an offset computation example with cable loss 5.4dB.

Example :

$$\begin{aligned} \text{Offset(dB)} &= \text{RF cable loss(dB)}. \\ &= 5.4 \text{ (dB)} \end{aligned}$$



2.5 Frequency List of Low/Middle/High Channels

LTE Band 2 Channel and Frequency List				
BW [MHz]	Channel/Frequency(MHz)	Lowest	Middle	Highest
20	Channel	18700	18900	19100
	Frequency	1860	1880	1900
15	Channel	18675	18900	19125
	Frequency	1857.5	1880	1902.5
10	Channel	18650	18900	19150
	Frequency	1855	1880	1905
5	Channel	18625	18900	19175
	Frequency	1852.5	1880	1907.5
3	Channel	18615	18900	19185
	Frequency	1851.5	1880	1908.5
1.4	Channel	18607	18900	19193
	Frequency	1850.7	1880	1909.3

LTE Band 4 Channel and Frequency List				
BW [MHz]	Channel/Frequency(MHz)	Lowest	Middle	Highest
20	Channel	20050	20175	20300
	Frequency	1720	1732.5	1745
15	Channel	20025	20175	20325
	Frequency	1717.5	1732.5	1747.5
10	Channel	20000	20175	20350
	Frequency	1715	1732.5	1750
5	Channel	19975	20175	20375
	Frequency	1712.5	1732.5	1752.5
3	Channel	19965	20175	20385
	Frequency	1711.5	1732.5	1753.5
1.4	Channel	19957	20175	20393
	Frequency	1710.7	1732.5	1754.3



LTE Band 5 Channel and Frequency List				
BW [MHz]	Channel/Frequency(MHz)	Lowest	Middle	Highest
10	Channel	20450	20525	20600
	Frequency	829	836.5	844
5	Channel	20425	20525	20625
	Frequency	826.5	836.5	846.5
3	Channel	20415	20525	20635
	Frequency	825.5	836.5	847.5
1.4	Channel	20407	20525	20643
	Frequency	824.7	836.5	848.3

LTE Band 7 Channel and Frequency List				
BW [MHz]	Channel/Frequency(MHz)	Lowest	Middle	Highest
20	Channel	20850	21100	21350
	Frequency	2510	2535	2560
15	Channel	20825	21100	21375
	Frequency	2507.5	2535	2562.5
10	Channel	20800	21100	21400
	Frequency	2505	2535	2565
5	Channel	20775	21100	21425
	Frequency	2502.5	2535	2567.5



LTE Band 66 Channel and Frequency List				
BW [MHz]	Channel/Frequency(MHz)	Lowest	Middle	Highest
20	Channel	132072	132322	132572
	Frequency	1720	1745	1770
15	Channel	132047	132322	132597
	Frequency	1717.5	1745	1772.5
10	Channel	132022	132322	132622
	Frequency	1715	1745	1775
5	Channel	131997	132322	132647
	Frequency	1712.5	1745	1777.5
3	Channel	131987	132322	132657
	Frequency	1711.5	1745	1778.5
1.4	Channel	131979	132322	132665
	Frequency	1710.7	1745	1779.3

3 Conducted Test Items

3.1 Measuring Instruments

See list of measuring instruments of this test report.

3.2 Test Setup

3.2.1 Conducted Output Power

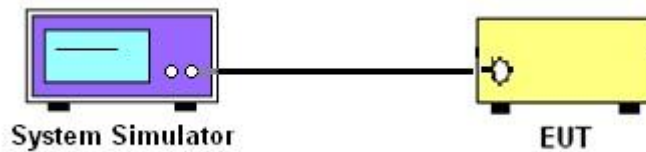

3.2.2 Peak-to-Average Ratio, Occupied Bandwidth ,Conducted Band-Edge and Conducted Spurious Emission

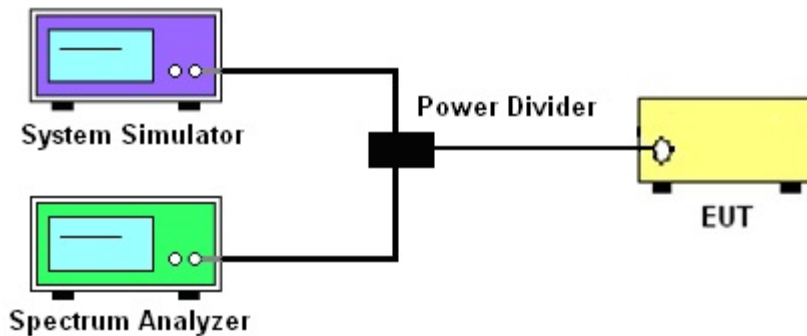

3.2.3 Frequency Stability

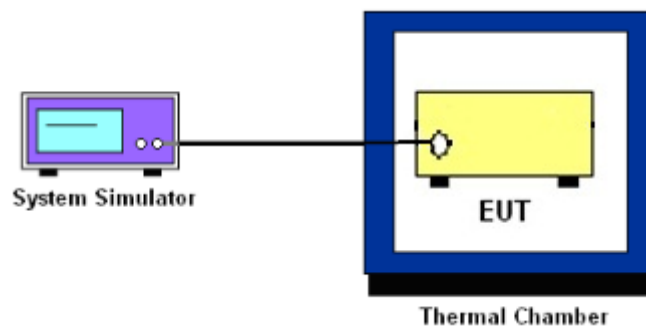

3.3 Test Result of Conducted Test

Please refer to Appendix A.



3.4 Conducted Output Power and ERP/EIRP

3.4.1 Description of the Conducted Output Power Measurement and ERP/EIRP Measurement

A system simulator was used to establish communication with the EUT. Its parameters were set to force the EUT transmitting at maximum output power. The measured power in the radio frequency on the transmitter output terminals shall be reported.

The ERP of mobile transmitters must not exceed 7 Watts for LTE Band 5.

The EIRP of mobile transmitters must not exceed 2 Watts for LTE Band 2 and Band 7.

The EIRP of mobile transmitters must not exceed 1 Watts for LTE Band 4 and Band 66.

According to KDB 412172 D01 Power Approach,

$EIRP = P_T + G_T - L_C$, $ERP = EIRP - 2.15$, where

P_T = transmitter output power in dBm

G_T = gain of the transmitting antenna in dBi

L_C = signal attenuation in the connecting cable between the transmitter and antenna in dB

3.4.2 Test Procedures

1. The testing follows ANSI C63.26 Section 5.2
2. The transmitter output port was connected to the system simulator.
3. Set EUT at maximum power through the system simulator.
4. Select lowest, middle, and highest channels for each band and different modulation.
5. Measure and record the power level from the system simulator.



3.5 Peak-to-Average Ratio

3.5.1 Description of the PAR Measurement

Power Complementary Cumulative Distribution Function (CCDF) curves provide a means for characterizing the power peaks of a digitally modulated signal on a statistical basis. A CCDF curve depicts the probability of the peak signal amplitude exceeding the average power level. Most contemporary measurement instrumentation include the capability to produce CCDF curves for an input signal provided that the instrument's resolution bandwidth can be set wide enough to accommodate the entire input signal bandwidth. In measuring transmissions in this band using an average power technique, the peak-to-average ratio (PAR) of the transmission may not exceed 13 dB.

3.5.2 Test Procedures

1. The testing follows ANSI C63.26 Section 5.2.3.4 (CCDF).
2. The EUT was connected to spectrum and system simulator via a power divider.
3. Set the CCDF (Complementary Cumulative Distribution Function) option in spectrum analyzer.
4. The highest RF powers were measured and recorded the maximum PAPR level associated with a probability of 0.1 %.
5. Record the deviation as Peak to Average Ratio.



3.6 Occupied Bandwidth

3.6.1 Description of Occupied Bandwidth Measurement

The occupied bandwidth is the width of a frequency band such that, below the lower and above the upper frequency limits, the mean powers emitted are each equal to a specified percentage 0.5% of the total mean transmitted power.

The 26 dB emission bandwidth is defined as the frequency range between two points, one above and one below the carrier frequency, at which the spectral density of the emission is attenuated 26 dB below the maximum in-band spectral density of the modulated signal. Spectral density (power per unit bandwidth) is to be measured with a detector of resolution bandwidth equal to approximately 1.0% of the emission bandwidth.

3.6.2 Test Procedures

1. The testing follows ANSI C63.26 Section 5.4
2. The EUT was connected to spectrum analyzer and system simulator via a power divider.
3. The spectrum analyzer center frequency is set to the nominal EUT channel center frequency. The span range for the spectrum analyzer shall be between two and five times the anticipated OBW.
4. The nominal resolution bandwidth (RBW) shall be in the range of 1 to 5 % of the anticipated OBW, and the VBW shall be at least 3 times the RBW.
5. Set the detection mode to peak, and the trace mode to max hold.
6. Determine the reference value: Set the EUT to transmit a modulated signal. Allow the trace to stabilize. Set the spectrum analyzer marker to the highest level of the displayed trace.
(this is the reference value)
7. Determine the “-26 dB down amplitude” as equal to (Reference Value – X).
8. Place two markers, one at the lowest and the other at the highest frequency of the envelope of the spectral display such that each marker is at or slightly below the “-X dB down amplitude” determined in step 6. If a marker is below this “-X dB down amplitude” value it shall be placed as close as possible to this value. The OBW is the positive frequency difference between the two markers.
9. Use the 99 % power bandwidth function of the spectrum analyzer and report the measured bandwidth.



3.7 Conducted Band Edge

3.7.1 Description of Conducted Band Edge Measurement

22.917(a)

For operations in the 824 – 849 MHz band, the FCC limit is $43 + 10\log_{10}(P[\text{Watts}])$ dB below the transmitter power $P(\text{Watts})$ in a 100kHz bandwidth. However, in the 1MHz bands immediately outside and adjacent to the licensee's frequency block, a resolution bandwidth of at least one percent of the emission bandwidth of the fundamental emission of the transmitter may be employed.

24.238 (a)

For operations in the 1850-1910 and 1930-1990 MHz band, the FCC limit is $43 + 10\log_{10}(P[\text{Watts}])$ dB below the transmitter power $P(\text{Watts})$ in a 1MHz bandwidth. However, in the 1 MHz bands immediately outside and adjacent to the frequency block a resolution bandwidth of at least one percent of the emission bandwidth of the fundamental emission of the transmitter may be employed.

27.53 (h)

For operations in the 1710 – 1755 MHz band, the FCC limit is $43 + 10\log_{10}(P[\text{Watts}])$ dB below the transmitter power $P(\text{Watts})$ in a 1 MHz bandwidth. However, in the 1MHz bands immediately outside and adjacent to the licensee's frequency block, a resolution bandwidth of at least one percent of the emission bandwidth of the fundamental emission of the transmitter may be employed.

27.53(m)(4)

For mobile digital stations, the attenuation factor shall be not less than $40 + 10 \log (P)$ dB on all frequencies between the channel edge and 5 megahertz from the channel edge, $43 + 10 \log (P)$ dB on all frequencies between 5 megahertz and X megahertz from the channel edge, and $55 + 10 \log (P)$ dB on all frequencies more than X megahertz from the channel edge, where X is the greater of 6 megahertz or the actual emission bandwidth as defined in paragraph (m)(6) of this section. In addition, the attenuation factor shall not be less that $43 + 10 \log (P)$ dB on all frequencies between 2490.5 MHz and 2496 MHz and $55 + 10 \log (P)$ dB at or below 2490.5 MHz. Mobile Satellite Service licensees operating on frequencies below 2495 MHz may also submit a documented interference complaint against BRS licensees operating on channel BRS Channel 1 on the same terms and conditions as adjacent channel BRS or EBS licensees.



3.7.2 Test Procedures

1. The testing follows ANSI C63.26 section 5.7
2. The EUT was connected to spectrum analyzer and system simulator via a power divider.
3. The band edges of low and high channels for the highest RF powers were measured.
4. Set RBW \geq 1% EBW in the 1MHz band immediately outside and adjacent to the band edge.
5. Beyond the 1 MHz band from the band edge, RBW=1MHz was used.
6. Set spectrum analyzer with RMS detector.
7. The RF fundamental frequency should be excluded against the limit line in the operating frequency band.
8. Checked that all the results comply with the emission limit line.

Example:

The limit line is derived from $43 + 10\log(P)$ dB below the transmitter power P(Watts)
= P(W)- [43 + 10log(P)] (dB)
= [30 + 10log(P)] (dBm) - [43 + 10log(P)] (dB) = -13dBm.

9. For LTE Band 7, the other 40 dB, and 55 dB have additionally applied same calculation above.



3.8 Conducted Spurious Emission

3.8.1 Description of Conducted Spurious Emission Measurement

The power of any emission outside of the authorized operating frequency ranges must be lower than the transmitter power (P) by a factor of at least $43 + 10 \log (P)$ dB.

For Band 7:

The power of any emission outside of the authorized operating frequency ranges must be lower than the transmitter power (P) by a factor of at least $55 + 10 \log (P)$ dB.

It is measured by means of a calibrated spectrum analyzer and scanned from 30 MHz up to a frequency including its 10th harmonic.

3.8.2 Test Procedures

1. The testing follows ANSI C63.26 section 5.7
2. The EUT was connected to spectrum analyzer and system simulator via a power divider.
3. The RF output of EUT was connected to the spectrum analyzer by RF cable and attenuator. The path loss was compensated to the results for each measurement.
4. The middle channel for the highest RF power within the transmitting frequency was measured.
5. The conducted spurious emission for the whole frequency range was taken.
6. Make the measurement with the spectrum analyzer's RBW = 1MHz, VBW = 3MHz.
7. Set spectrum analyzer with RMS detector.
8. Taking the record of maximum spurious emission.
9. The RF fundamental frequency should be excluded against the limit line in the operating frequency band.
10. The limit line is derived from $43 + 10\log(P)$ dB below the transmitter power P(Watts)
 $= P(W) - [43 + 10\log(P)]$ (dB)
 $= [30 + 10\log(P)]$ (dBm) - $[43 + 10\log(P)]$ (dB)
 $= -13$ dBm.
11. For Band 7
The limit line is derived from $55 + 10\log(P)$ dB below the transmitter power P(Watts)
 $= P(W) - [55 + 10\log(P)]$ (dB)
 $= [30 + 10\log(P)]$ (dBm) - $[55 + 10\log(P)]$ (dB)
 $= -25$ dBm.



3.9 Frequency Stability

3.9.1 Description of Frequency Stability Measurement

The frequency stability shall be measured by variation of ambient temperature and variation of primary supply voltage to ensure that the fundamental emission stays within the authorized frequency block. The frequency stability of the transmitter shall be maintained within $\pm 0.00025\%$ ($\pm 2.5\text{ppm}$) of the center frequency.

3.9.2 Test Procedures for Temperature Variation

1. The testing follows ANSI C63.26 section 5.6.4
2. The EUT was set up in the thermal chamber and connected with the system simulator.
3. With power OFF, the temperature was decreased to -30°C and the EUT was stabilized before testing. Power was applied and the maximum change in frequency was recorded within one minute.
4. With power OFF, the temperature was raised in 10°C step up to 50°C . The EUT was stabilized at each step for at least half an hour. Power was applied and the maximum frequency change was recorded within one minute.

3.9.3 Test Procedures for Voltage Variation

1. The testing follows ANSI C63.26 section 5.6.5
2. The EUT was placed in a temperature chamber at $20\pm 5^{\circ}\text{C}$ and connected with the system simulator.
3. The power supply voltage to the EUT was varied from 85% to 115% of the nominal value for other than hand carried battery equipment.
4. For hand carried, battery powered equipment, reduce the primary ac or dc supply voltage to the battery operating end point, which shall be specified by the manufacturer.
5. The variation in frequency was measured for the worst case.

4 Radiated Test Items

4.1 Measuring Instruments

See list of measuring instruments of this test report.

4.2 Test Setup

4.2.1 For radiated test from 30MHz to 1GHz

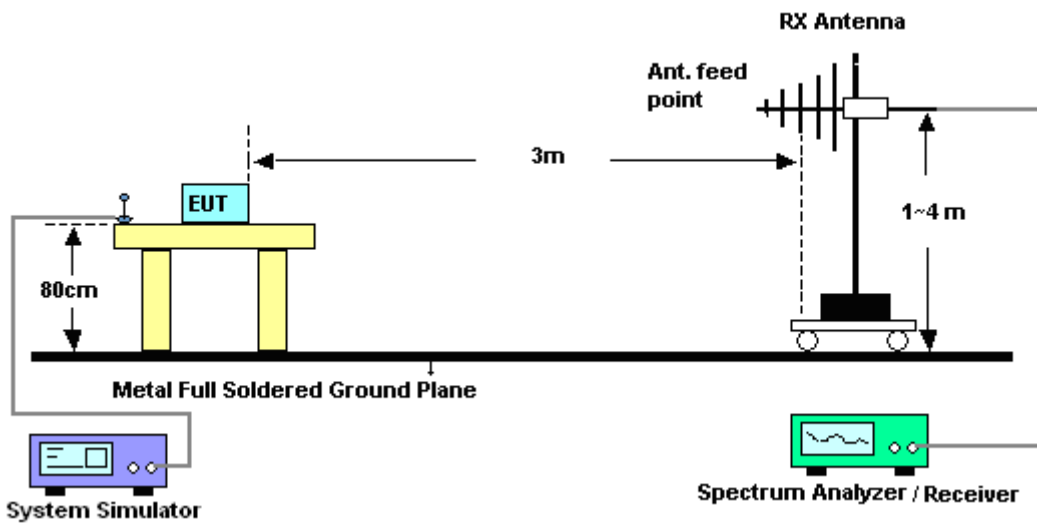

4.2.2 For radiated test above 1GHz

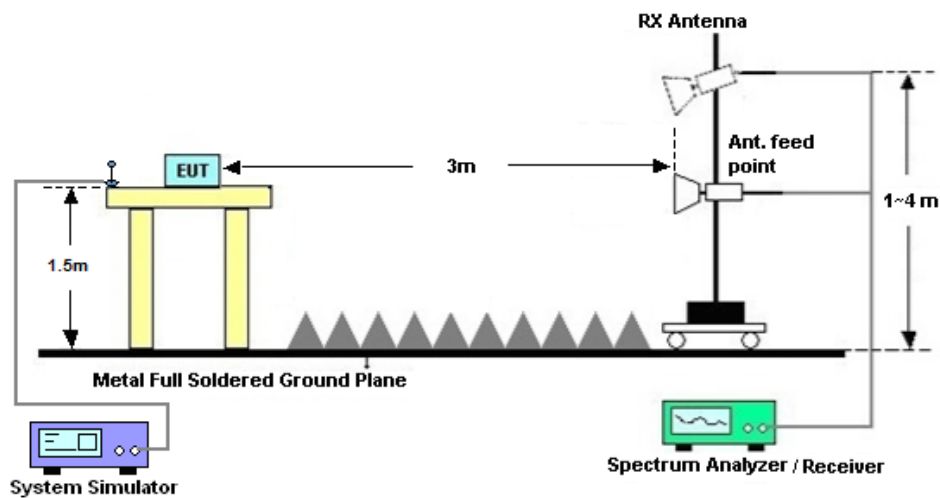

4.3 Test Result of Radiated Test

Please refer to Appendix B.



4.4 Radiated Spurious Emission

4.4.1 Description of Radiated Spurious Emission

The radiated spurious emission was measured by substitution method according to ANSI C63.26. The power of any emission outside of the authorized operating frequency ranges must be attenuated below the transmitter power (P) by a factor of at least $43 + 10 \log (P)$ dB.

For Band 7

The power of any emission outside of the authorized operating frequency ranges must be attenuated below the transmitter power (P) by a factor of at least $55 + 10 \log (P)$ dB.

The spectrum is scanned from 30 MHz up to a frequency including its 10th harmonic.

4.4.2 Test Procedures

1. The testing follows ANSI C63.26 Section 5.5
2. The EUT was placed on a turntable with 0.8 meter height for frequency below 1GHz and 1.5 meter height for frequency above 1GHz respectively above ground.
3. The EUT was set 3 meters from the receiving antenna mounted on the antenna tower.
4. The table was rotated 360 degrees to determine the position of the highest spurious emission.
5. The height of the receiving antenna is varied between 1m to 4m to search the maximum spurious emission for both horizontal and vertical polarizations.
6. During the measurement, the system simulator parameters were set to force the EUT transmitting at maximum output power.
7. Make the measurement with the spectrum analyzer's RBW = 1MHz, VBW = 3MHz, taking the record of maximum spurious emission.
8. A horn antenna was substituted in place of the EUT and was driven by a signal generator.
9. Tune the output power of signal generator to the same emission level with EUT maximum spurious emission.
10. $EIRP (dBm) = S.G. Power - Tx Cable Loss + Tx Antenna Gain$
11. $ERP (dBm) = EIRP - 2.15$
12. The RF fundamental frequency should be excluded against the limit line in the operating frequency band.

The limit line is derived from $43 + 10\log(P)$ dB below the transmitter power P(Watts)
 $= P(W) - [43 + 10\log(P)] (dB)$
 $= [30 + 10\log(P)] (dBm) - [43 + 10\log(P)] (dB)$
 $= -13dBm.$

13. For Band 7, 38, 41:

The limit line is derived from $55 + 10\log(P)$ dB below the transmitter power P(Watts)



5 List of Measuring Equipment

Instrument	Manufacturer	Model No.	Serial No.	Characteristics	Calibration Date	Test Date	Due Date	Remark
Spectrum Analyzer	R&S	FSV40	101040	10Hz~40GHz	Aug. 07, 2019	Dec. 20, 2019~ Dec. 30, 2019	Aug. 06, 2020	Conducted (TH01-KS)
Temperature & humidity chamber	Hongzhan	LP-150U	H2014011440	-40~+150°C 20%~95%RH	Jul. 04, 2019	Dec. 20, 2019~ Dec. 30, 2019	Jul. 03, 2020	Conducted (TH01-KS)
EXA Spectrum Analyzer	Keysight	N9010A	MY55150244	10Hz-44G,MAX 30dB	Apr. 16, 2019	Dec. 27, 2019	Apr. 15, 2020	Radiation (03CH04-KS)
Bilog Antenna	TeseQ	CBL6111D	44483	30MHz-1GHz	Dec. 28, 2018	Dec. 27, 2019	Dec. 27, 2019	Radiation (03CH04-KS)
Horn Antenna	Schwarzbeck	BBHA9120D	1648	1GHz~18GHz	Jan. 27, 2019	Dec. 27, 2019	Jan. 26, 2020	Radiation (03CH04-KS)
SHF-EHF Horn	Com-power	AH-840	101070	18GHz~40GHz	Jan. 05, 2019	Dec. 27, 2019	Jan. 04, 2020	Radiation (03CH04-KS)
Amplifier	SONOMA	310N	187289	9KHz-1GHz	Aug. 06, 2019	Dec. 27, 2019	Aug. 05, 2020	Radiation (03CH04-KS)
Amplifier	Keysight	83017A	MY57280106	500MHz~26.5GHz	Apr. 15, 2019	Dec. 27, 2019	Apr. 14, 2020	Radiation (03CH04-KS)
Amplifier	MITEQ	TTA1840-35 -HG	2014749	18~40GHz	Jan. 14, 2019	Dec. 27, 2019	Jan. 13, 2020	Radiation (03CH04-KS)
AC Power Source	Chroma	61601	F104090004	N/A	NCR	Dec. 27, 2019	NCR	Radiation (03CH04-KS)
Turn Table	ChamPro	EM 1000-T	060762-T	0~360 degree	NCR	Dec. 27, 2019	NCR	Radiation (03CH04-KS)
Antenna Mast	ChamPro	EM 1000-A	060762-A	1 m~4 m	NCR	Dec. 27, 2019	NCR	Radiation (03CH04-KS)

NCR: No Calibration Required



6 Uncertainty of Evaluation

The measurement uncertainties shown below were calculated in accordance with the requirements of ANSI 63.26-2015. All the measurement uncertainty value were shown with a coverage K=2 to indicate 95% level of confidence. The measurement data show herein meets or exceeds the CISPR measurement uncertainty values specified in CISPR 16-4-2 and can be compared directly to specified limit to determine compliance.

Uncertainty of Radiated Emission Measurement (30 MHz ~ 1000 MHz)

Measuring Uncertainty for a Level of Confidence of 95% (U = 2Uc(y))	3.3 dB
---	--------

Uncertainty of Radiated Emission Measurement (1 GHz ~ 40 GHz)

Measuring Uncertainty for a Level of Confidence of 95% (U = 2Uc(y))	2.8 dB
---	--------



Appendix A. Test Results of Conducted Test

Conducted Output Power(Average power)

LTE Band 2 Maximum Average Power [dBm]						
BW [MHz]	RB Size	RB Offset	Mod	Lowest	Middle	Highest
20	1	0	QPSK	23.35	23.67	23.54
20	1	49		23.50	23.51	23.42
20	1	99		23.23	23.23	23.45
20	50	0		22.62	22.67	22.54
20	50	24		22.60	22.62	22.46
20	50	50		22.46	22.63	22.46
20	100	0		22.53	22.65	22.50
20	1	0	16-QAM	22.59	22.43	22.46
20	1	49		22.60	22.65	22.69
20	1	99		22.34	22.37	22.30
20	50	0		21.65	21.67	21.57
20	50	24		21.62	21.62	21.49
20	50	50		21.49	21.64	21.48
20	100	0		21.56	21.65	21.53
20	1	0	64-QAM	21.47	21.34	21.33
20	1	49		21.56	21.60	21.59
20	1	99		21.18	21.34	21.20
20	50	0		20.62	20.63	20.57
20	50	24		20.61	20.61	20.49
20	50	50		20.47	20.64	20.46
20	100	0		20.56	20.65	20.54



LTE Band 2 Maximum Average Power [dBm]						
BW [MHz]	RB Size	RB Offset	Mod	Lowest	Middle	Highest
15	1	0	QPSK	23.50	23.38	23.34
15	1	37		23.56	23.65	23.50
15	1	74		23.21	23.43	23.24
15	36	0		22.64	22.63	22.48
15	36	20		22.62	22.66	22.45
15	36	39		22.56	22.65	22.45
15	75	0		22.59	22.61	22.45
15	1	0	16-QAM	22.76	22.62	22.61
15	1	37		22.96	22.92	22.78
15	1	74		22.47	22.59	22.49
15	36	0		21.66	21.62	21.49
15	36	20		21.61	21.64	21.46
15	36	39		21.54	21.61	21.44
15	75	0		21.62	21.62	21.48
15	1	0	64-QAM	21.62	21.53	21.50
15	1	37		21.77	21.83	21.61
15	1	74		21.36	21.51	21.36
15	36	0		20.64	20.62	20.48
15	36	20		20.59	20.62	20.44
15	36	39		20.57	20.62	20.44
15	75	0		20.63	20.63	20.49



LTE Band 2 Maximum Average Power [dBm]						
BW [MHz]	RB Size	RB Offset	Mod	Lowest	Middle	Highest
10	1	0	QPSK	23.60	23.43	23.57
10	1	25		23.61	23.45	23.66
10	1	49		23.51	23.35	23.55
10	25	0		22.65	22.47	22.66
10	25	12		22.61	22.44	22.63
10	25	25		22.60	22.47	22.66
10	50	0		22.63	22.48	22.65
10	1	0	16-QAM	22.79	22.65	22.78
10	1	25		22.86	22.69	22.93
10	1	49		22.74	22.59	22.70
10	25	0		21.66	21.52	21.68
10	25	12		21.64	21.50	21.66
10	25	25		21.64	21.51	21.70
10	50	0		21.64	21.51	21.65
10	1	0	64-QAM	21.71	21.53	21.68
10	1	25		21.73	21.58	21.77
10	1	49		21.65	21.47	21.59
10	25	0		20.65	20.51	20.68
10	25	12		20.62	20.48	20.67
10	25	25		20.63	20.52	20.67
10	50	0		20.64	20.49	20.65



LTE Band 2 Maximum Average Power [dBm]						
BW [MHz]	RB Size	RB Offset	Mod	Lowest	Middle	Highest
5	1	0	QPSK	23.47	23.24	23.48
5	1	12		23.54	23.54	23.50
5	1	24		23.38	23.27	23.44
5	12	0		22.62	22.39	22.60
5	12	7		22.67	22.46	22.67
5	12	13		22.59	22.44	22.63
5	25	0		22.61	22.42	22.62
5	1	0	16-QAM	22.71	22.55	22.70
5	1	12		22.97	22.77	22.89
5	1	24		22.64	22.51	22.58
5	12	0		21.64	21.41	21.59
5	12	7		21.65	21.46	21.66
5	12	13		21.60	21.43	21.61
5	25	0		21.64	21.44	21.63
5	1	0	64QAM	21.61	21.38	21.59
5	1	12		21.83	21.65	21.83
5	1	24		21.55	21.40	21.50
5	12	0		20.62	20.38	20.59
5	12	7		20.65	20.45	20.66
5	12	13		20.60	20.43	20.60
5	25	0		20.64	20.46	20.62



LTE Band 2 Maximum Average Power [dBm]						
BW [MHz]	RB Size	RB Offset	Mod	Lowest	Middle	Highest
3	1	0	QPSK	23.58	23.35	23.54
3	1	8		23.59	23.35	23.56
3	1	14		23.52	23.35	23.55
3	8	0		22.64	22.40	22.62
3	8	4		22.62	22.45	22.66
3	8	7		22.59	22.39	22.60
3	15	0		22.59	22.39	22.63
3	1	0	16-QAM	22.80	22.61	22.72
3	1	8		22.79	22.63	22.73
3	1	14		22.80	22.59	22.70
3	8	0		21.70	21.49	21.69
3	8	4		21.71	21.53	21.69
3	8	7		21.67	21.50	21.64
3	15	0		21.63	21.43	21.64
3	1	0	64-QAM	21.68	21.49	21.62
3	1	8		21.69	21.49	21.65
3	1	14		21.66	21.47	21.59
3	8	0		20.65	20.42	20.66
3	8	4		20.66	20.49	20.65
3	8	7		20.62	20.42	20.61
3	15	0		20.61	20.41	20.60



LTE Band 2 Maximum Average Power [dBm]						
BW [MHz]	RB Size	RB Offset	Mod	Lowest	Middle	Highest
1.4	1	0	QPSK	23.51	23.29	23.46
1.4	1	3		23.61	23.44	23.59
1.4	1	5		23.52	23.30	23.46
1.4	3	0		23.62	23.39	23.58
1.4	3	1		23.60	23.46	23.64
1.4	3	3		23.64	23.40	23.58
1.4	6	0		22.65	22.41	22.59
1.4	1	0	16-QAM	22.74	22.54	22.60
1.4	1	3		22.87	22.64	22.76
1.4	1	5		22.73	22.52	22.61
1.4	3	0		22.58	22.36	22.51
1.4	3	1		22.64	22.44	22.55
1.4	3	3		22.56	22.39	22.49
1.4	6	0		21.72	21.51	21.66
1.4	1	0	64-QAM	21.67	21.41	21.58
1.4	1	3		21.71	21.54	21.63
1.4	1	5		21.64	21.39	21.55
1.4	3	0		21.61	21.39	21.55
1.4	3	1		21.68	21.43	21.59
1.4	3	3		21.61	21.41	21.53
1.4	6	0		20.65	20.44	20.59



LTE Band 4 Maximum Average Power [dBm]						
BW [MHz]	RB Size	RB Offset	Mod	Lowest	Middle	Highest
20	1	0	QPSK	23.51	23.81	23.70
20	1	49		23.56	23.55	23.80
20	1	99		23.54	23.45	23.50
20	50	0		22.57	22.84	22.65
20	50	24		22.55	22.80	22.60
20	50	50		22.48	22.59	22.45
20	100	0		22.54	22.53	22.84
20	1	0	16-QAM	22.53	22.53	22.54
20	1	49		22.87	22.81	22.87
20	1	99		22.60	22.39	22.77
20	50	0		21.60	21.64	21.80
20	50	24		21.58	21.59	21.85
20	50	50		21.53	21.54	21.88
20	100	0		21.60	21.56	21.85
20	1	0	64-QAM	21.40	21.46	21.43
20	1	49		21.70	21.72	21.65
20	1	99		21.42	21.28	21.67
20	50	0		20.60	20.62	20.80
20	50	24		20.59	20.55	20.86
20	50	50		20.52	20.50	20.86
20	100	0		20.61	20.57	20.86



LTE Band 4 Maximum Average Power [dBm]						
BW [MHz]	RB Size	RB Offset	Mod	Lowest	Middle	Highest
15	1	0	QPSK	23.47	23.42	23.56
15	1	37		23.60	23.69	23.65
15	1	74		23.31	23.40	23.51
15	36	0		22.56	22.54	22.84
15	36	20		22.50	22.54	22.88
15	36	39		22.43	22.55	22.90
15	75	0		22.48	22.54	22.88
15	1	0	16-QAM	22.68	22.69	22.54
15	1	37		22.88	22.94	22.85
15	1	74		22.61	22.67	22.75
15	36	0		21.56	21.57	21.87
15	36	20		21.52	21.56	21.89
15	36	39		21.48	21.57	21.93
15	75	0		21.51	21.56	21.91
15	1	0	64-QAM	21.58	21.61	21.78
15	1	37		21.77	21.78	21.87
15	1	74		21.48	21.58	21.92
15	36	0		20.56	20.57	20.85
15	36	20		20.53	20.56	20.88
15	36	39		20.46	20.54	20.93
15	75	0		20.52	20.57	20.91



LTE Band 4 Maximum Average Power [dBm]						
BW [MHz]	RB Size	RB Offset	Mod	Lowest	Middle	Highest
10	1	0	QPSK	23.54	23.50	23.78
10	1	25		23.56	23.56	23.74
10	1	49		23.37	23.46	23.76
10	25	0		22.57	22.59	22.65
10	25	12		22.53	22.55	22.45
10	25	25		22.45	22.51	22.60
10	50	0		22.50	22.53	22.94
10	1	0	16-QAM	22.77	22.78	22.81
10	1	25		22.85	22.86	22.80
10	1	49		22.62	22.74	22.74
10	25	0		21.61	21.58	21.45
10	25	12		21.56	21.59	21.56
10	25	25		21.48	21.59	21.60
10	50	0		21.54	21.60	21.98
10	1	0	64-QAM	21.68	21.66	21.65
10	1	25		21.72	21.73	21.70
10	1	49		21.52	21.62	21.72
10	25	0		20.58	20.59	20.56
10	25	12		20.58	20.59	20.65
10	25	25		20.47	20.55	20.54
10	50	0		20.55	20.55	20.56



LTE Band 4 Maximum Average Power [dBm]						
BW [MHz]	RB Size	RB Offset	Mod	Lowest	Middle	Highest
5	1	0	QPSK	23.44	23.38	23.78
5	1	12		23.64	23.62	23.56
5	1	24		23.36	23.37	23.80
5	12	0		22.51	22.49	22.86
5	12	7		22.57	22.53	22.96
5	12	13		22.50	22.49	22.92
5	25	0		22.50	22.50	22.91
5	1	0	16-QAM	22.69	22.70	22.75
5	1	12		22.88	22.88	22.85
5	1	24		22.61	22.64	22.65
5	12	0		21.54	21.53	21.89
5	12	7		21.58	21.59	21.99
5	12	13		21.54	21.53	21.98
5	25	0		21.52	21.54	21.96
5	1	0	64-QAM	21.60	21.58	21.45
5	1	12		21.80	21.79	21.81
5	1	24		21.47	21.54	21.65
5	12	0		20.50	20.52	20.88
5	12	7		20.59	20.54	20.95
5	12	13		20.50	20.54	20.95
5	25	0		20.55	20.54	20.94



LTE Band 4 Maximum Average Power [dBm]						
BW [MHz]	RB Size	RB Offset	Mod	Lowest	Middle	Highest
3	1	0	QPSK	23.54	23.50	23.71
3	1	8		23.49	23.45	23.74
3	1	14		23.49	23.47	23.75
3	8	0		22.53	22.48	22.92
3	8	4		22.58	22.53	22.97
3	8	7		22.52	22.48	22.92
3	15	0		22.52	22.49	22.89
3	1	0	16-QAM	22.78	22.80	22.87
3	1	8		22.76	22.73	22.85
3	1	14		22.76	22.71	22.89
3	8	0		21.62	21.62	21.65
3	8	4		21.66	21.62	21.75
3	8	7		21.61	21.58	21.65
3	15	0		21.58	21.56	21.92
3	1	0	64-QAM	21.66	21.66	21.56
3	1	8		21.63	21.65	21.65
3	1	14		21.64	21.67	21.54
3	8	0		20.59	20.58	20.58
3	8	4		20.61	20.59	20.65
3	8	7		20.56	20.54	20.45
3	15	0		20.55	20.53	20.56



LTE Band 4 Maximum Average Power [dBm]						
BW [MHz]	RB Size	RB Offset	Mod	Lowest	Middle	Highest
1.4	1	0	QPSK	23.46	23.44	23.70
1.4	1	3		23.59	23.58	23.56
1.4	1	5		23.46	23.42	23.71
1.4	3	0		23.57	23.57	23.61
1.4	3	1		23.63	23.60	23.60
1.4	3	3		23.57	23.54	23.56
1.4	6	0		22.58	22.54	22.98
1.4	1	0	16-QAM	22.71	22.72	22.87
1.4	1	3		22.86	22.83	22.81
1.4	1	5		22.72	22.73	22.82
1.4	3	0		22.54	22.54	22.45
1.4	3	1		22.60	22.58	22.65
1.4	3	3		22.53	22.51	22.45
1.4	6	0		21.68	21.66	21.65
1.4	1	0	64-QAM	21.59	21.62	21.65
1.4	1	3		21.74	21.74	21.60
1.4	1	5		21.62	21.63	21.76
1.4	3	0		21.59	21.61	22.00
1.4	3	1		21.64	21.66	21.66
1.4	3	3		21.57	21.54	21.51
1.4	6	0		20.61	20.57	20.65



LTE Band 5 Maximum Average Power [dBm]						
BW [MHz]	RB Size	RB Offset	Mod	Lowest	Middle	Highest
10	1	0	QPSK	23.76	23.89	23.70
10	1	25		23.61	23.83	23.65
10	1	49		23.50	23.74	23.57
10	25	0		22.55	22.79	22.67
10	25	12		22.57	22.74	22.69
10	25	25		22.61	22.72	22.62
10	50	0		22.62	22.72	22.65
10	1	0	16-QAM	22.71	22.83	22.75
10	1	25		22.89	23.17	22.90
10	1	49		22.80	23.06	22.88
10	25	0		21.59	21.83	21.72
10	25	12		21.61	21.84	21.72
10	25	25		21.65	21.77	21.71
10	50	0		21.63	21.80	21.67
10	1	0	64-QAM	21.56	21.71	21.66
10	1	25		21.81	22.01	21.81
10	1	49		21.67	21.92	21.76
10	25	0		20.58	20.84	20.71
10	25	12		20.60	20.85	20.74
10	25	25		20.65	20.79	20.69
10	50	0		20.61	20.79	20.69



LTE Band 5 Maximum Average Power [dBm]						
BW [MHz]	RB Size	RB Offset	Mod	Lowest	Middle	Highest
5	1	0	QPSK	23.35	23.60	23.46
5	1	12		23.63	23.83	23.68
5	1	24		23.41	23.66	23.49
5	12	0		22.50	22.72	22.61
5	12	7		22.58	22.79	22.66
5	12	13		22.55	22.75	22.63
5	25	0		22.51	22.74	22.62
5	1	0	16-QAM	22.66	22.88	22.75
5	1	12		22.93	23.13	22.92
5	1	24		22.67	22.95	22.77
5	12	0		21.51	21.78	21.65
5	12	7		21.62	21.82	21.68
5	12	13		21.58	21.81	21.65
5	25	0		21.58	21.81	21.67
5	1	0	64-QAM	21.54	21.80	21.62
5	1	12		21.86	22.04	21.83
5	1	24		21.57	21.89	21.69
5	12	0		20.48	20.75	20.61
5	12	7		20.60	20.82	20.68
5	12	13		20.57	20.79	20.65
5	25	0		20.56	20.79	20.66



LTE Band 5 Maximum Average Power [dBm]						
BW [MHz]	RB Size	RB Offset	Mod	Lowest	Middle	Highest
3	1	0	QPSK	23.39	23.48	23.63
3	1	8		23.43	23.49	23.66
3	1	14		23.39	23.52	23.69
3	8	0		22.42	22.51	22.65
3	8	4		22.46	22.55	22.72
3	8	7		22.45	22.52	22.72
3	15	0		22.41	22.52	22.66
3	1	0	16-QAM	22.67	22.69	22.91
3	1	8		22.72	22.69	22.96
3	1	14		22.67	22.77	23.01
3	8	0		21.54	21.61	21.79
3	8	4		21.58	21.65	21.83
3	8	7		21.55	21.61	21.83
3	15	0		21.49	21.57	21.74
3	1	0	64-QAM	21.56	21.58	21.84
3	1	8		21.60	21.65	21.83
3	1	14		21.58	21.68	21.87
3	8	0		20.54	20.54	20.73
3	8	4		20.54	20.61	20.78
3	8	7		20.52	20.57	20.78
3	15	0		20.46	20.55	20.71



LTE Band 5 Maximum Average Power [dBm]						
BW [MHz]	RB Size	RB Offset	Mod	Lowest	Middle	Highest
1.4	1	0	QPSK	23.44	23.51	23.69
1.4	1	3		23.59	23.64	23.86
1.4	1	5		23.48	23.54	23.76
1.4	3	0		23.54	23.59	23.83
1.4	3	1		23.57	23.69	23.87
1.4	3	3		23.58	23.64	23.88
1.4	6	0		22.54	22.64	22.84
1.4	1	0	16-QAM	22.72	22.74	23.01
1.4	1	3		22.87	22.86	23.15
1.4	1	5		22.75	22.81	23.09
1.4	3	0		22.53	22.60	22.82
1.4	3	1		22.59	22.66	22.88
1.4	3	3		22.55	22.62	22.84
1.4	6	0		21.64	21.80	21.99
1.4	1	0	64-QAM	21.63	21.64	21.89
1.4	1	3		21.73	21.78	22.02
1.4	1	5		21.65	21.69	21.93
1.4	3	0		21.56	21.64	21.89
1.4	3	1		21.64	21.71	21.91
1.4	3	3		21.60	21.68	21.88
1.4	6	0		20.61	20.71	20.88



LTE Band 7 Maximum Average Power [dBm]						
BW [MHz]	RB Size	RB Offset	Mod	Lowest	Middle	Highest
20	1	0	QPSK	23.12	23.46	23.03
20	1	49		23.07	23.45	23.44
20	1	99		23.00	23.12	23.13
20	50	0		22.12	22.42	22.36
20	50	24		22.01	22.39	22.39
20	50	50		22.02	22.41	22.39
20	100	0		21.94	22.34	22.36
20	1	0	16-QAM	22.10	22.18	22.34
20	1	49		22.30	22.45	22.54
20	1	99		22.14	22.40	22.43
20	50	0		21.23	21.30	21.34
20	50	24		21.06	21.40	21.41
20	50	50		21.09	21.41	21.42
20	100	0		20.96	21.35	21.37
20	1	0	64-QAM	21.23	21.26	21.43
20	1	49		21.42	21.65	21.65
20	1	99		21.23	21.50	21.48
20	50	0		20.32	20.49	20.52
20	50	24		20.24	20.59	20.59
20	50	50		20.26	20.57	20.60
20	100	0		20.17	20.55	20.58



LTE Band 7 Maximum Average Power [dBm]						
BW [MHz]	RB Size	RB Offset	Mod	Lowest	Middle	Highest
15	1	0	QPSK	23.00	23.14	23.26
15	1	37		23.07	23.40	23.43
15	1	74		22.93	23.25	23.30
15	36	0		22.21	22.35	22.38
15	36	20		22.01	22.40	22.38
15	36	39		22.05	22.44	22.43
15	75	0		21.96	22.40	22.39
15	1	0	16-QAM	22.42	22.45	22.55
15	1	37		22.51	22.65	22.50
15	1	74		22.21	22.56	22.55
15	36	0		20.95	21.32	21.34
15	36	20		21.06	21.38	21.42
15	36	39		21.09	21.39	21.39
15	75	0		20.99	21.38	21.38
15	1	0	64-QAM	21.43	21.52	21.63
15	1	37		21.46	21.80	21.70
15	1	74		21.30	21.64	21.64
15	36	0		20.13	20.51	20.55
15	36	20		20.24	20.57	20.62
15	36	39		20.29	20.60	20.59
15	75	0		20.21	20.57	20.58



LTE Band 7 Maximum Average Power [dBm]						
BW [MHz]	RB Size	RB Offset	Mod	Lowest	Middle	Highest
10	1	0	QPSK	23.10	23.23	23.27
10	1	25		23.03	23.41	23.39
10	1	49		23.01	23.31	23.30
10	25	0		22.12	22.33	22.32
10	25	12		21.96	22.38	22.33
10	25	25		22.04	22.41	22.38
10	50	0		21.97	22.36	22.36
10	1	0	16-QAM	22.23	22.52	22.54
10	1	25		22.33	22.60	22.64
10	1	49		22.18	22.60	22.58
10	25	0		21.02	21.40	21.37
10	25	12		21.02	21.40	21.38
10	25	25		21.12	21.44	21.43
10	50	0		21.03	21.42	21.42
10	1	0	64-QAM	21.32	21.60	21.64
10	1	25		21.39	21.70	21.77
10	1	49		21.29	21.67	21.69
10	25	0		20.22	20.55	20.57
10	25	12		20.22	20.59	20.59
10	25	25		20.32	20.64	20.64
10	50	0		20.23	20.58	20.59



LTE Band 7 Maximum Average Power [dBm]						
BW [MHz]	RB Size	RB Offset	Mod	Lowest	Middle	Highest
5	1	0	QPSK	23.21	23.16	23.13
5	1	12		23.06	23.42	23.45
5	1	24		23.02	23.22	23.21
5	12	0		22.12	22.28	22.27
5	12	7		21.94	22.39	22.37
5	12	13		21.94	22.36	22.32
5	25	0		21.90	22.35	22.32
5	1	0	16-QAM	22.20	22.50	22.43
5	1	12		22.33	22.50	22.61
5	1	24		22.23	22.52	22.50
5	12	0		20.91	21.33	21.30
5	12	7		20.97	21.37	21.41
5	12	13		21.00	21.37	21.35
5	25	0		20.95	21.36	21.38
5	1	0	64-QAM	21.40	21.53	21.52
5	1	12		21.45	21.76	21.85
5	1	24		21.39	21.59	21.59
5	12	0		20.20	20.50	20.47
5	12	7		20.16	20.54	20.58
5	12	13		20.16	20.50	20.53
5	25	0		20.12	20.55	20.55



LTE Band 66 Maximum Average Power [dBm]						
BW [MHz]	RB Size	RB Offset	Mod	Lowest	Middle	Highest
20	1	0	QPSK	23.58	23.85	23.76
20	1	49		23.45	23.75	23.57
20	1	99		23.40	23.75	23.51
20	50	0		22.56	22.88	22.80
20	50	24		22.55	22.86	22.75
20	50	50		22.47	22.84	22.67
20	100	0		22.52	22.87	22.80
20	1	0	16-QAM	22.43	22.71	22.85
20	1	49		22.83	22.85	22.89
20	1	99		22.51	22.73	22.52
20	50	0		21.63	21.91	21.85
20	50	24		21.61	21.92	21.87
20	50	50		21.56	21.86	21.73
20	100	0		21.58	21.89	21.85
20	1	0	64-QAM	21.33	21.62	21.78
20	1	49		21.75	21.65	21.80
20	1	99		21.39	21.64	21.41
20	50	0		20.61	20.88	21.00
20	50	24		20.61	20.89	20.87
20	50	50		20.57	20.85	20.71
20	100	0		20.57	20.92	20.83



LTE Band 66 Maximum Average Power [dBm]						
BW [MHz]	RB Size	RB Offset	Mod	Lowest	Middle	Highest
15	1	0	QPSK	23.65	23.84	23.74
15	1	37		23.59	23.79	23.81
15	1	74		23.60	23.63	23.41
15	36	0		22.48	22.89	22.86
15	36	20		22.51	22.85	22.74
15	36	39		22.45	22.84	22.65
15	75	0		22.46	22.84	22.76
15	1	0	16-QAM	22.61	22.95	22.95
15	1	37		22.88	22.89	22.90
15	1	74		22.66	22.90	22.66
15	36	0		21.52	21.90	21.88
15	36	20		21.52	21.87	21.76
15	36	39		21.51	21.85	21.67
15	75	0		21.52	21.89	21.80
15	1	0	64-QAM	21.49	21.83	21.86
15	1	37		21.75	21.87	21.94
15	1	74		21.53	21.77	21.56
15	36	0		20.49	20.90	20.89
15	36	20		20.55	20.86	20.76
15	36	39		20.49	20.84	20.67
15	75	0		20.53	20.90	20.82



LTE Band 66 Maximum Average Power [dBm]						
BW [MHz]	RB Size	RB Offset	Mod	Lowest	Middle	Highest
10	1	0	QPSK	23.36	23.80	23.66
10	1	25		23.47	23.75	23.71
10	1	49		23.39	23.70	23.47
10	25	0		22.45	22.88	22.81
10	25	12		22.46	22.83	22.71
10	25	25		22.43	22.83	22.68
10	50	0		22.44	22.87	22.73
10	1	0	16-QAM	22.64	22.85	22.95
10	1	25		22.76	22.86	22.84
10	1	49		22.66	22.97	22.79
10	25	0		21.48	21.94	21.88
10	25	12		21.50	21.88	21.77
10	25	25		21.46	21.88	21.74
10	50	0		21.48	21.91	21.80
10	1	0	64-QAM	21.53	21.92	21.88
10	1	25		21.68	21.99	21.92
10	1	49		21.56	21.87	21.67
10	25	0		20.49	20.92	20.86
10	25	12		20.51	20.89	20.77
10	25	25		20.45	20.88	20.74
10	50	0		20.47	20.89	20.78



LTE Band 66 Maximum Average Power [dBm]						
BW [MHz]	RB Size	RB Offset	Mod	Lowest	Middle	Highest
5	1	0	QPSK	23.45	23.80	23.54
5	1	12		23.52	23.80	23.73
5	1	24		23.41	23.63	23.40
5	12	0		22.40	22.81	22.63
5	12	7		22.47	22.85	22.67
5	12	13		22.42	22.81	22.64
5	25	0		22.37	22.80	22.63
5	1	0	16-QAM	22.56	22.93	22.83
5	1	12		22.85	22.89	22.89
5	1	24		22.53	22.90	22.69
5	12	0		21.45	21.83	21.66
5	12	7		21.50	21.89	21.69
5	12	13		21.46	21.85	21.66
5	25	0		21.43	21.86	21.67
5	1	0	64-QAM	21.65	21.82	21.70
5	1	12		21.73	21.82	21.92
5	1	24		21.60	21.79	21.55
5	12	0		20.37	20.81	20.66
5	12	7		20.47	20.86	20.69
5	12	13		20.45	20.84	20.62
5	25	0		20.43	20.84	20.67



LTE Band 66 Maximum Average Power [dBm]						
BW [MHz]	RB Size	RB Offset	Mod	Lowest	Middle	Highest
3	1	0	QPSK	23.37	23.75	23.62
3	1	8		23.39	23.77	23.56
3	1	14		23.36	23.73	23.51
3	8	0		22.44	22.77	22.58
3	8	4		22.47	22.83	22.63
3	8	7		22.42	22.79	22.57
3	15	0		22.43	22.80	22.57
3	1	0	16-QAM	22.67	22.87	22.85
3	1	8		22.64	23.00	22.85
3	1	14		22.59	22.86	22.78
3	8	0		21.48	21.91	21.68
3	8	4		21.53	21.91	21.72
3	8	7		21.53	21.92	21.66
3	15	0		21.45	21.83	21.64
3	1	0	64-QAM	21.57	21.91	21.76
3	1	8		21.52	21.89	21.72
3	1	14		21.49	21.92	21.69
3	8	0		20.45	20.85	20.69
3	8	4		20.49	20.85	20.72
3	8	7		20.45	20.82	20.67
3	15	0		20.40	20.82	20.62



LTE Band 66 Maximum Average Power [dBm]						
BW [MHz]	RB Size	RB Offset	Mod	Lowest	Middle	Highest
1.4	1	0	QPSK	23.31	23.71	23.52
1.4	1	3		23.45	23.70	23.66
1.4	1	5		23.30	23.73	23.51
1.4	3	0		23.42	23.81	23.62
1.4	3	1		23.46	23.76	23.68
1.4	3	3		23.42	23.82	23.64
1.4	6	0		22.47	22.82	22.62
1.4	1	0	16-QAM	22.63	22.98	22.82
1.4	1	3		22.72	22.85	22.89
1.4	1	5		22.59	22.84	22.76
1.4	3	0		22.45	22.83	22.62
1.4	3	1		22.50	22.85	22.67
1.4	3	3		22.41	22.82	22.62
1.4	6	0		21.55	21.95	21.72
1.4	1	0	64-QAM	21.46	21.90	21.70
1.4	1	3		21.58	21.87	21.77
1.4	1	5		21.52	21.87	21.72
1.4	3	0		21.49	21.85	21.63
1.4	3	1		21.52	21.91	21.68
1.4	3	3		21.46	21.84	21.62
1.4	6	0		20.50	20.89	20.67



ERP/EIRP

LTE Band 2 (GT - LC = -5.79 dB) QPSK									
Bandwidth	1.4M			3M			5M		
Channel	18607	18900	19193	18615	18900	19185	18625	18900	19175
	(Low)	(Mid)	(High)	(Low)	(Mid)	(High)	(Low)	(Mid)	(High)
Frequency	1850.7	1880	1909.3	1851.5	1880	1908.5	1852.5	1880	1907.5
(MHz)									
Conducted Power (dBm)	23.60	23.46	23.64	23.59	23.35	23.56	23.54	23.54	23.50
Conducted Power (Watts)	0.2291	0.2218	0.2312	0.2286	0.2163	0.2270	0.2259	0.2259	0.2239
EIRP(dBm)	17.81	17.67	17.85	17.80	17.56	17.77	17.75	17.75	17.71
EIRP(Watts)	0.0604	0.0585	0.0610	0.0603	0.0570	0.0598	0.0596	0.0596	0.0590

LTE Band 2 (GT - LC = -5.79 dB) QPSK									
Bandwidth	10M			15M			20M		
Channel	18650	18900	19150	18675	18900	19125	18650	18900	19100
	(Low)	(Mid)	(High)	(Low)	(Mid)	(High)	(Low)	(Mid)	(High)
Frequency	1855	1880	1905	1857.5	1880	1902.5	1860	1880	1900
(MHz)									
Conducted Power (dBm)	23.61	23.45	23.66	23.56	23.65	23.50	23.35	23.67	23.54
Conducted Power (Watts)	0.2296	0.2213	0.2323	0.2270	0.2317	0.2239	0.2163	0.2328	0.2259
EIRP(dBm)	17.82	17.66	17.87	17.77	17.86	17.71	17.56	17.88	17.75
EIRP(Watts)	0.0605	0.0583	0.0612	0.0598	0.0611	0.0590	0.0570	0.0614	0.0596



LTE Band 2 (GT - LC = -5.79 dB) 16QAM									
Bandwidth	1.4M			3M			5M		
Channel	18607	18900	19193	18615	18900	19185	18625	18900	19175
	(Low)	(Mid)	(High)	(Low)	(Mid)	(High)	(Low)	(Mid)	(High)
Frequency (MHz)	1850.7	1880	1909.3	1851.5	1880	1908.5	1852.5	1880	1907.5
Conducted Power (dBm)	22.87	22.64	22.76	22.80	22.61	22.72	22.97	22.77	22.89
Conducted Power (Watts)	0.1936	0.1837	0.1888	0.1905	0.1824	0.1871	0.1982	0.1892	0.1945
EIRP(dBm)	17.08	16.85	16.97	17.01	16.82	16.93	17.18	16.98	17.10
EIRP(Watts)	0.0511	0.0484	0.0498	0.0502	0.0481	0.0493	0.0522	0.0499	0.0513

LTE Band 2 (GT - LC = -5.79 dB) 16QAM									
Bandwidth	10M			15M			20M		
Channel	18650	18900	19150	18675	18900	19125	18650	18900	19100
	(Low)	(Mid)	(High)	(Low)	(Mid)	(High)	(Low)	(Mid)	(High)
Frequency (MHz)	1855	1880	1905	1857.5	1880	1902.5	1860	1880	1900
Conducted Power (dBm)	22.86	22.69	22.93	22.96	22.92	22.78	22.60	22.65	22.69
Conducted Power (Watts)	0.1932	0.1858	0.1963	0.1977	0.1959	0.1897	0.1820	0.1841	0.1858
EIRP(dBm)	17.07	16.90	17.14	17.17	17.13	16.99	16.81	16.86	16.90
EIRP(Watts)	0.0509	0.0490	0.0518	0.0521	0.0516	0.0500	0.0480	0.0485	0.0490



LTE Band 2 (GT - LC = -5.79 dB) 64QAM									
Bandwidth	1.4M			3M			5M		
Channel	18607	18900	19193	18615	18900	19185	18625	18900	19175
	(Low)	(Mid)	(High)	(Low)	(Mid)	(High)	(Low)	(Mid)	(High)
Frequency (MHz)	1850.7	1880	1909.3	1851.5	1880	1908.5	1852.5	1880	1907.5
Conducted Power (dBm)	21.71	21.54	21.63	21.69	21.49	21.65	21.83	21.65	21.83
Conducted Power (Watts)	0.1483	0.1426	0.1455	0.1476	0.1409	0.1462	0.1524	0.1462	0.1524
EIRP(dBm)	15.92	15.75	15.84	15.90	15.70	15.86	16.04	15.86	16.04
EIRP(Watts)	0.0391	0.0376	0.0384	0.0389	0.0372	0.0385	0.0402	0.0385	0.0402

LTE Band 2 (GT - LC = -5.79 dB) 64QAM									
Bandwidth	10M			15M			20M		
Channel	18650	18900	19150	18675	18900	19125	18650	18900	19100
	(Low)	(Mid)	(High)	(Low)	(Mid)	(High)	(Low)	(Mid)	(High)
Frequency (MHz)	1855	1880	1905	1857.5	1880	1902.5	1860	1880	1900
Conducted Power (dBm)	21.73	21.58	21.77	21.77	21.83	21.61	21.56	21.60	21.59
Conducted Power (Watts)	0.1489	0.1439	0.1503	0.1503	0.1524	0.1449	0.1432	0.1445	0.1442
EIRP(dBm)	15.94	15.79	15.98	15.98	16.04	15.82	15.77	15.81	15.80
EIRP(Watts)	0.0393	0.0379	0.0396	0.0396	0.0402	0.0382	0.0378	0.0381	0.0380



LTE Band 5 (GT - LC = -3.77 dB) QPSK									
Bandwidth	1.4M			3M			5M		
Channel	20407	20525	20643	20415	20525	20635	20425	20525	20625
	(Low)	(Mid)	(High)	(Low)	(Mid)	(High)	(Low)	(Mid)	(High)
Frequency (MHz)	824.7	836.5	848.3	825.5	836.5	847.5	826.5	836.5	846.5
Conducted Power (dBm)	23.58	23.64	23.88	23.39	23.52	23.69	23.63	23.83	23.68
Conducted Power (Watts)	0.2280	0.2312	0.2443	0.2183	0.2249	0.2339	0.2307	0.2415	0.2333
ERP(dBm)	17.66	17.72	17.96	17.47	17.60	17.77	17.71	17.91	17.76
ERP(Watts)	0.0583	0.0592	0.0625	0.0558	0.0575	0.0598	0.0590	0.0618	0.0597

LTE Band 5 (GT - LC = -3.77 dB) QPSK			
Bandwidth	10M		
Channel	20450	20525	20600
	(Low)	(Mid)	(High)
Frequency (MHz)	829	836.5	844
Conducted Power (dBm)	23.76	23.89	23.70
Conducted Power (Watts)	0.2377	0.2449	0.2344
ERP(dBm)	17.84	17.97	17.78
ERP(Watts)	0.0608	0.0627	0.0600



LTE Band 5 (GT - LC = -3.77 dB) 16QAM									
Bandwidth	1.4M			3M			5M		
Channel	20407	20525	20643	20415	20525	20635	20425	20525	20625
	(Low)	(Mid)	(High)	(Low)	(Mid)	(High)	(Low)	(Mid)	(High)
Frequency (MHz)	824.7	836.5	848.3	825.5	836.5	847.5	826.5	836.5	846.5
Conducted Power (dBm)	22.87	22.86	23.15	22.67	22.77	23.01	22.93	23.13	22.92
Conducted Power (Watts)	0.1936	0.1932	0.2065	0.1849	0.1892	0.2000	0.1963	0.2056	0.1959
ERP(dBm)	16.95	16.94	17.23	16.75	16.85	17.09	17.01	17.21	17.00
ERP(Watts)	0.0495	0.0494	0.0528	0.0473	0.0484	0.0512	0.0502	0.0526	0.0501

LTE Band 5 (GT - LC = -3.77 dB) 16QAM			
Bandwidth	10M		
Channel	20450	20525	20600
	(Low)	(Mid)	(High)
Frequency (MHz)	829	836.5	844
Conducted Power (dBm)	22.89	23.17	22.90
Conducted Power (Watts)	0.1945	0.2075	0.1950
ERP(dBm)	16.97	17.25	16.98
ERP(Watts)	0.0498	0.0531	0.0499



LTE Band 5 (GT - LC = -3.77 dB) 64QAM									
Bandwidth	1.4M			3M			5M		
Channel	20407	20525	20643	20415	20525	20635	20425	20525	20625
	(Low)	(Mid)	(High)	(Low)	(Mid)	(High)	(Low)	(Mid)	(High)
Frequency (MHz)	824.7	836.5	848.3	825.5	836.5	847.5	826.5	836.5	846.5
Conducted Power (dBm)	21.73	21.78	22.02	21.58	21.68	21.87	21.86	22.04	21.83
Conducted Power (Watts)	0.1489	0.1507	0.1592	0.1439	0.1472	0.1538	0.1535	0.1600	0.1524
ERP(dBm)	15.81	15.86	16.10	15.66	15.76	15.95	15.94	16.12	15.91
ERP(Watts)	0.0381	0.0385	0.0407	0.0368	0.0377	0.0394	0.0393	0.0409	0.0390

LTE Band 5 (GT - LC = -3.77 dB) 64QAM			
Bandwidth	10M		
Channel	20450	20525	20600
	(Low)	(Mid)	(High)
Frequency (MHz)	829	836.5	844
Conducted Power (dBm)	21.81	22.01	21.81
Conducted Power (Watts)	0.1517	0.1589	0.1517
ERP(dBm)	15.89	16.09	15.89
ERP(Watts)	0.0388	0.0406	0.0388



LTE Band 7 (GT - LC = -0.90 dB) QPSK			
Bandwidth	5M		
Channel	20775	21100	21425
	(Low)	(Mid)	(High)
Frequency	2502.5	2535	2567.5
(MHz)			
Conducted Power (dBm)	23.06	23.42	23.45
Conducted Power (Watts)	0.2023	0.2198	0.2213
EIRP(dBm)	22.16	22.52	22.55
EIRP(Watts)	0.1644	0.1786	0.1799

LTE Band 7 (GT - LC = -0.90 dB) QPSK									
Bandwidth	10M			15M			20M		
Channel	20800	21100	21400	20825	21100	21375	20850	21100	21350
	(Low)	(Mid)	(High)	(Low)	(Mid)	(High)	(Low)	(Mid)	(High)
Frequency	2505	2535	2565	2507.5	2535	2562.5	2510	2535	2560
(MHz)									
Conducted Power (dBm)	23.03	23.41	23.39	23.07	23.40	23.43	23.12	23.46	23.03
Conducted Power (Watts)	0.2009	0.2193	0.2183	0.2028	0.2188	0.2203	0.2051	0.2218	0.2009
EIRP(dBm)	22.13	22.51	22.49	22.17	22.50	22.53	22.22	22.56	22.13
EIRP(Watts)	0.1633	0.1782	0.1774	0.1648	0.1778	0.1791	0.1667	0.1803	0.1633



LTE Band 7 (GT - LC = -0.90 dB) 16QAM			
Bandwidth	5M		
Channel	20775	21100	21425
	(Low)	(Mid)	(High)
Frequency (MHz)	2502.5	2535	2567.5
	Conducted Power (dBm)	22.33	22.50
Conducted Power (Watts)	0.1710	0.1778	0.1824
EIRP(dBm)	21.43	21.60	21.71
EIRP(Watts)	0.1390	0.1445	0.1483

LTE Band 7 (GT - LC = -0.90 dB) 16QAM									
Bandwidth	10M			15M			20M		
Channel	20800	21100	21400	20825	21100	21375	20850	21100	21350
	(Low)	(Mid)	(High)	(Low)	(Mid)	(High)	(Low)	(Mid)	(High)
Frequency (MHz)	2505	2535	2565	2507.5	2535	2562.5	2510	2535	2560
	Conducted Power (dBm)	22.33	22.60	22.64	22.51	22.65	22.50	22.30	22.45
Conducted Power (Watts)	0.1710	0.1820	0.1837	0.1782	0.1841	0.1778	0.1698	0.1758	0.1795
EIRP(dBm)	21.43	21.70	21.74	21.61	21.75	21.60	21.40	21.55	21.64
EIRP(Watts)	0.1390	0.1479	0.1493	0.1449	0.1496	0.1445	0.1380	0.1429	0.1459



LTE Band 7 (GT - LC = -0.90 dB) 64QAM			
Bandwidth	5M		
Channel	20775	21100	21425
	(Low)	(Mid)	(High)
Frequency	2502.5	2535	2567.5
(MHz)			
Conducted Power (dBm)	21.45	21.76	21.85
Conducted Power (Watts)	0.1396	0.1500	0.1531
EIRP(dBm)	20.55	20.86	20.95
EIRP(Watts)	0.1135	0.1219	0.1245

LTE Band 7 (GT - LC = -0.90 dB) 64QAM									
Bandwidth	10M			15M			20M		
Channel	20800	21100	21400	20825	21100	21375	20850	21100	21350
	(Low)	(Mid)	(High)	(Low)	(Mid)	(High)	(Low)	(Mid)	(High)
Frequency	2505	2535	2565	2507.5	2535	2562.5	2510	2535	2560
(MHz)									
Conducted Power (dBm)	21.39	21.70	21.77	21.46	21.80	21.70	21.42	21.65	21.65
Conducted Power (Watts)	0.1377	0.1479	0.1503	0.1400	0.1514	0.1479	0.1387	0.1462	0.1462
EIRP(dBm)	20.49	20.80	20.87	20.56	20.90	20.80	20.52	20.75	20.75
EIRP(Watts)	0.1119	0.1202	0.1222	0.1138	0.1230	0.1202	0.1127	0.1189	0.1189



LTE Band 66 (GT - LC = -1.78 dB) QPSK									
Bandwidth	1.4M			3M			5M		
Channel	131979	132322	132665	131987	132322	132657	131997	132322	132647
	(Low)	(Mid)	(High)	(Low)	(Mid)	(High)	(Low)	(Mid)	(High)
Frequency (MHz)	1710.7	1745	1779.3	1711.5	1745	1778.5	1712.5	1745	1777.5
Conducted Power (dBm)	23.42	23.82	23.64	23.39	23.77	23.56	23.52	23.80	23.73
Conducted Power (Watts)	0.2198	0.2410	0.2312	0.2183	0.2382	0.2270	0.2249	0.2399	0.2360
EIRP(dBm)	21.64	22.04	21.86	21.61	21.99	21.78	21.74	22.02	21.95
EIRP(Watts)	0.1459	0.1600	0.1535	0.1449	0.1581	0.1507	0.1493	0.1592	0.1567

LTE Band 66 (GT - LC = -1.78 dB) QPSK									
Bandwidth	10M			15M			20M		
Channel	132022	132322	132622	132047	132322	132597	132072	132322	132572
	(Low)	(Mid)	(High)	(Low)	(Mid)	(High)	(Low)	(Mid)	(Mid)
Frequency (MHz)	1715	1745	1775	1717.5	1745	1772.5	1720	1745	1770
Conducted Power (dBm)	23.36	23.80	23.66	23.65	23.84	23.74	23.58	23.85	23.76
Conducted Power (Watts)	0.2168	0.2399	0.2323	0.2317	0.2421	0.2366	0.2280	0.2427	0.2377
EIRP(dBm)	21.58	22.02	21.88	21.87	22.06	21.96	21.80	22.07	21.98
EIRP(Watts)	0.1439	0.1592	0.1542	0.1538	0.1607	0.1570	0.1514	0.1611	0.1578



LTE Band 66 (GT - LC = -1.78 dB) 16QAM									
Bandwidth	1.4M			3M			5M		
Channel	131979	132322	132665	131987	132322	132657	131997	132322	132647
	(Low)	(Mid)	(High)	(Low)	(Mid)	(High)	(Low)	(Mid)	(High)
Frequency (MHz)	1710.7	1745	1779.3	1711.5	1745	1778.5	1712.5	1745	1777.5
Conducted Power (dBm)	22.63	22.98	22.82	22.64	23.00	22.85	22.56	22.93	22.83
Conducted Power (Watts)	0.1832	0.1986	0.1914	0.1837	0.1995	0.1928	0.1803	0.1963	0.1919
EIRP(dBm)	20.85	21.20	21.04	20.86	21.22	21.07	20.78	21.15	21.05
EIRP(Watts)	0.1216	0.1318	0.1271	0.1219	0.1324	0.1279	0.1197	0.1303	0.1274

LTE Band 66 (GT - LC = -1.78 dB) 16QAM									
Bandwidth	10M			15M			20M		
Channel	132022	132322	132622	132047	132322	132597	132072	132322	132572
	(Low)	(Mid)	(High)	(Low)	(Mid)	(High)	(Low)	(Mid)	(Mid)
Frequency (MHz)	1715	1745	1775	1717.5	1745	1772.5	1720	1745	1770
Conducted Power (dBm)	22.66	22.97	22.79	22.61	22.95	22.95	22.83	22.85	22.89
Conducted Power (Watts)	0.1845	0.1982	0.1901	0.1824	0.1972	0.1972	0.1919	0.1928	0.1945
EIRP(dBm)	20.88	21.19	21.01	20.83	21.17	21.17	21.05	21.07	21.11
EIRP(Watts)	0.1225	0.1315	0.1262	0.1211	0.1309	0.1309	0.1274	0.1279	0.1291



LTE Band 66 (GT - LC = -1.78 dB) 64QAM									
Bandwidth	1.4M			3M			5M		
Channel	131979	132322	132665	131987	132322	132657	131997	132322	132647
	(Low)	(Mid)	(High)	(Low)	(Mid)	(High)	(Low)	(Mid)	(High)
Frequency (MHz)	1710.7	1745	1779.3	1711.5	1745	1778.5	1712.5	1745	1777.5
Conducted Power (dBm)	21.52	21.91	21.68	21.49	21.92	21.69	21.73	21.82	21.92
Conducted Power (Watts)	0.1419	0.1552	0.1472	0.1409	0.1556	0.1476	0.1489	0.1521	0.1556
EIRP(dBm)	19.74	20.13	19.90	19.71	20.14	19.91	19.95	20.04	20.14
EIRP(Watts)	0.0942	0.1030	0.0977	0.0935	0.1033	0.0979	0.0989	0.1009	0.1033

LTE Band 66 (GT - LC = -1.78 dB) 64QAM									
Bandwidth	10M			15M			20M		
Channel	132022	132322	132622	132047	132322	132597	132072	132322	132572
	(Low)	(Mid)	(High)	(Low)	(Mid)	(High)	(Low)	(Mid)	(Mid)
Frequency (MHz)	1715	1745	1775	1717.5	1745	1772.5	1720	1745	1770
Conducted Power (dBm)	21.68	21.99	21.92	21.75	21.87	21.94	21.75	21.65	21.80
Conducted Power (Watts)	0.1472	0.1581	0.1556	0.1496	0.1538	0.1563	0.1496	0.1462	0.1514
EIRP(dBm)	19.90	20.21	20.14	19.97	20.09	20.16	19.97	19.87	20.02
EIRP(Watts)	0.0977	0.1050	0.1033	0.0993	0.1021	0.1038	0.0993	0.0971	0.1005



LTE Band 2

Peak-to-Average Ratio

Mode	LTE Band 2 / 20MHz				
Mod.	QPSK		16QAM		Limit: 13dB
RB Size	1RB	Full RB	1RB	Full RB	Result
Lowest CH	4.93	5.07	5.68	6.00	PASS
Middle CH	4.93	5.04	5.54	5.80	
Highest CH	4.78	4.99	5.54	5.71	
Mode	LTE Band 2 / 20MHz				
Mod.	64QAM		-		Limit: 13dB
RB Size	1RB	Full RB	-	-	Result
Lowest CH	6.38	6.26	-	-	PASS
Middle CH	6.32	6.23	-	-	
Highest CH	6.26	6.20	-	-	



LTE Band 2 / 20MHz / QPSK

Lowest Channel / 1RB

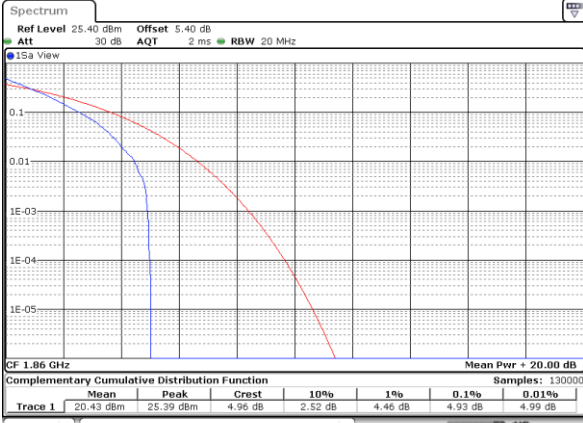

Date: 22 DEC 2019 22:44:55

Lowest Channel / Full RB

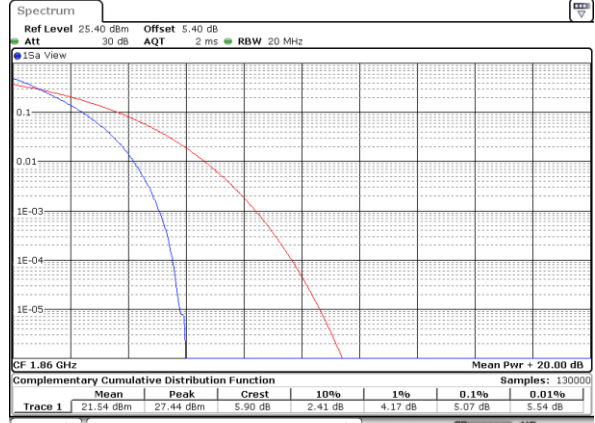

Date: 22 DEC 2019 22:45:14

Middle Channel / 1RB

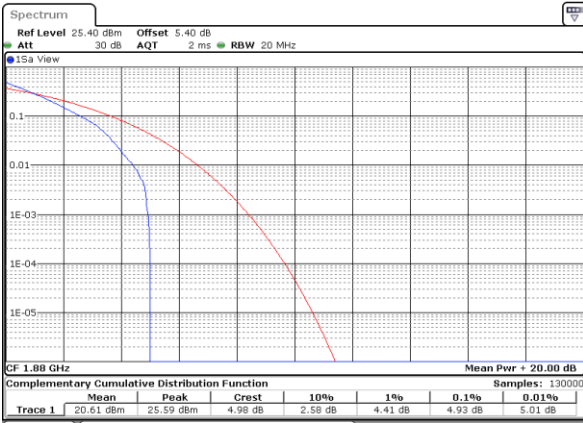

Date: 22 DEC 2019 22:44:44

Middle Channel / Full RB

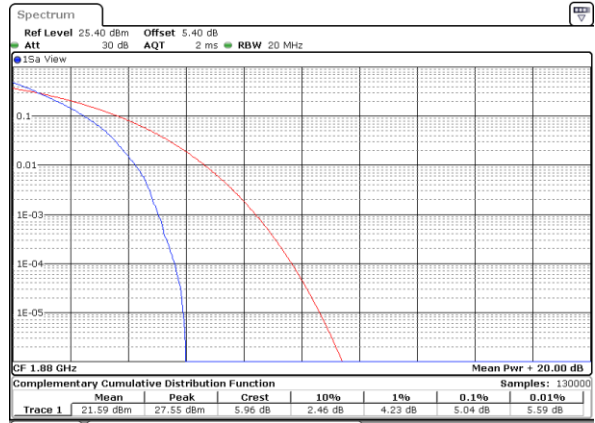

Date: 22 DEC 2019 22:45:26

Highest Channel / 1RB

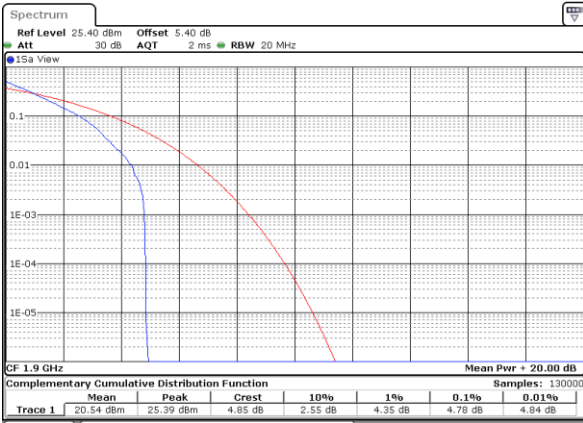

Date: 22 DEC 2019 22:44:33

Highest Channel / Full RB

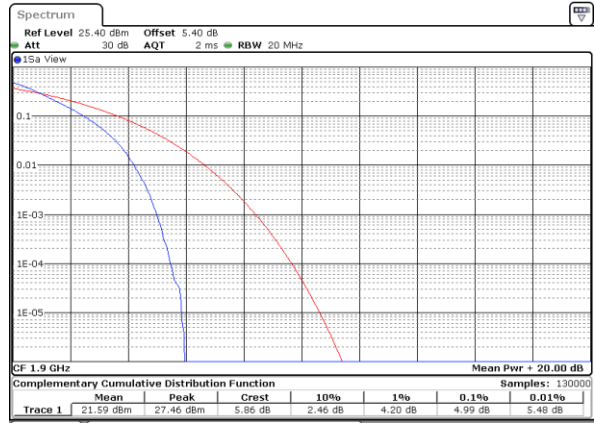

Date: 22 DEC 2019 22:45:37



LTE Band 2 / 20MHz / 16QAM

Lowest Channel / 1RB

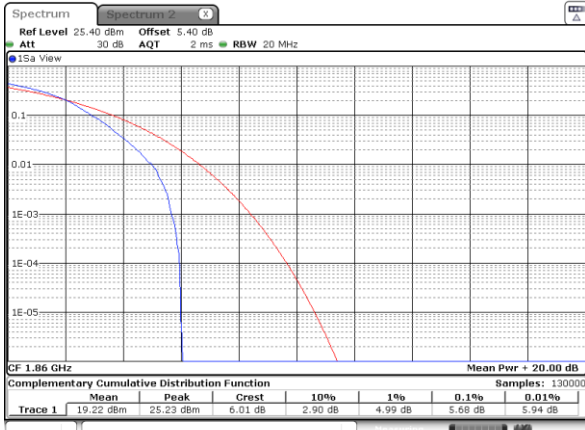

Date: 20 DEC 2019 16:43:44

Lowest Channel / Full RB

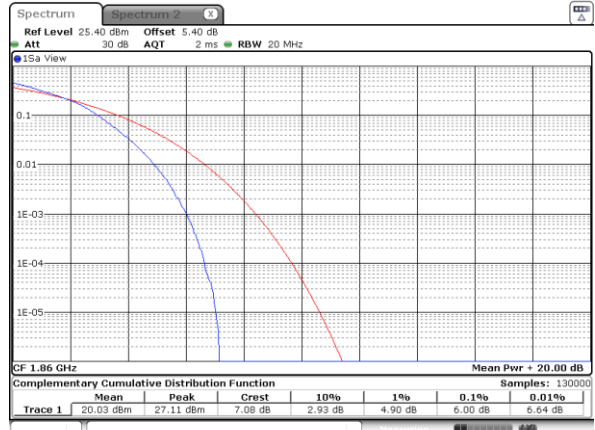

Date: 20 DEC 2019 16:43:53

Middle Channel / 1RB

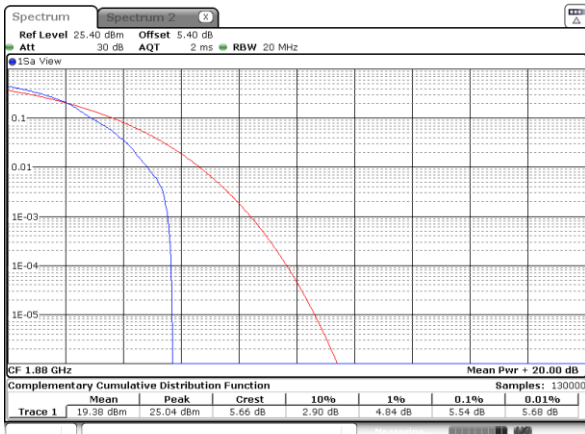

Date: 20 DEC 2019 16:44:02

Middle Channel / Full RB

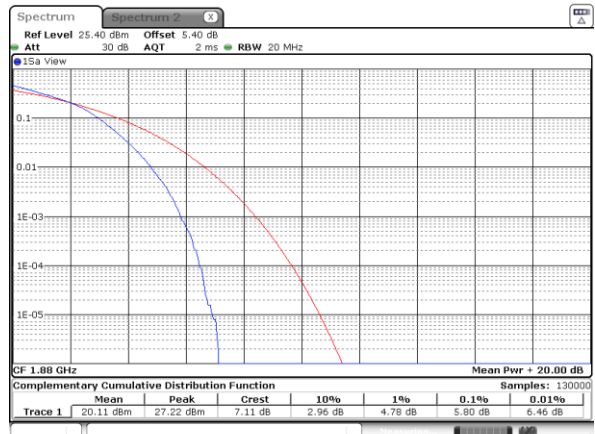

Date: 20 DEC 2019 16:44:11

Highest Channel / 1RB

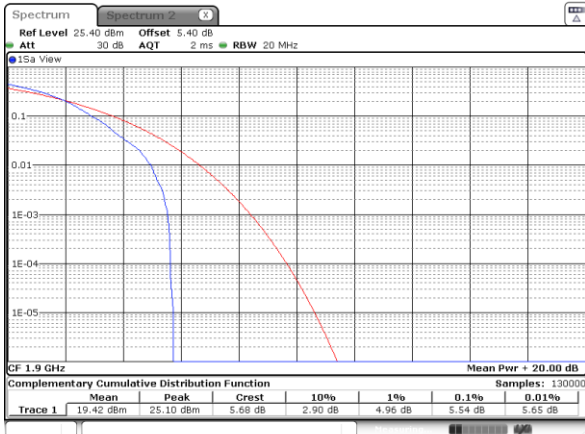

Date: 20 DEC 2019 16:44:20

Highest Channel / Full RB

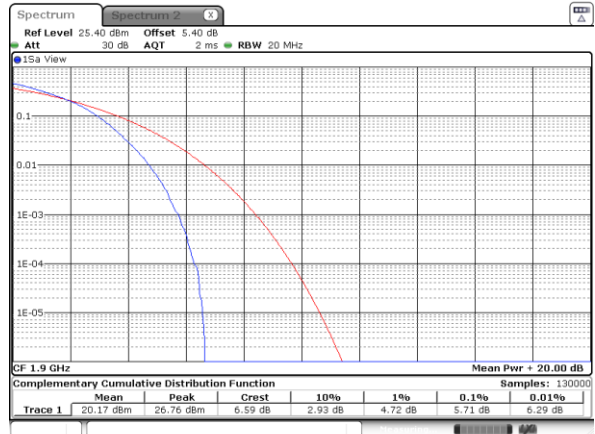

Date: 20 DEC 2019 16:44:29



LTE Band 2 / 20MHz / 64QAM

Lowest Channel / 1RB

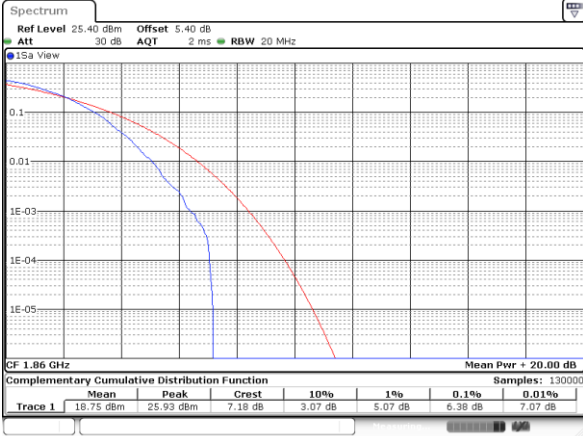

Date: 22 DEC 2019 22:43:59

Lowest Channel / Full RB

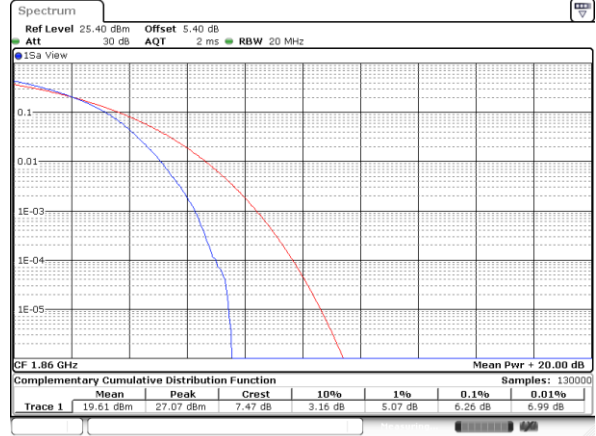

Date: 22 DEC 2019 22:46:13

Middle Channel / 1RB



Date: 22 DEC 2019 22:44:11

Middle Channel / Full RB

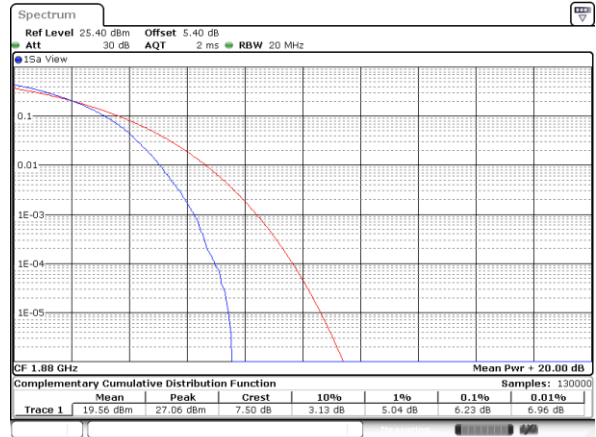

Date: 22 DEC 2019 22:46:00

Highest Channel / 1RB

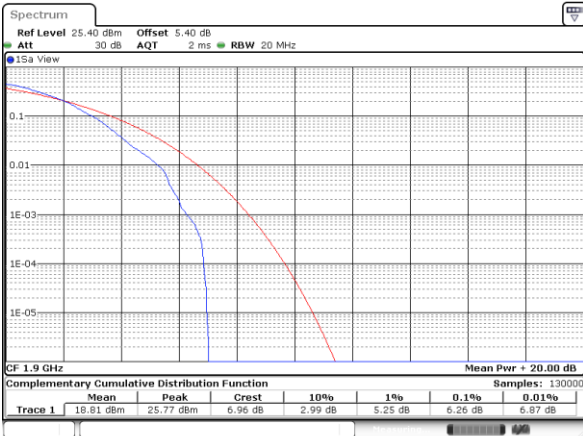

Date: 22 DEC 2019 22:44:22

Highest Channel / Full RB

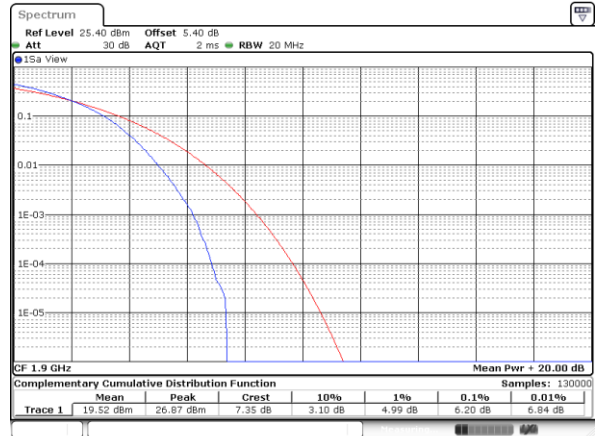

Date: 22 DEC 2019 22:45:48



26dB Bandwidth

Mode	LTE Band 2 : 26dB BW(MHz)											
BW	1.4MHz		3MHz		5MHz		10MHz		15MHz		20MHz	
Mod.	QPSK	16QAM	QPSK	16QAM	QPSK	16QAM	QPSK	16QAM	QPSK	16QAM	QPSK	16QAM
Lowest CH	1.284	1.284	2.931	2.937	4.775	4.865	9.73	10.01	14.296	14.206	20.06	20.22
Middle CH	1.262	1.301	2.961	2.961	4.905	4.865	9.75	9.85	14.206	14.236	20.18	20.30
Highest CH	1.264	1.231	2.937	2.967	4.855	4.785	9.73	9.67	14.326	14.236	20.18	20.10
Mode	LTE Band 2 : 26dB BW(MHz)											
BW	1.4MHz		3MHz		5MHz		10MHz		15MHz		20MHz	
Mod.	64QAM	-	64QAM	-	64QAM	-	64QAM	-	64QAM	-	64QAM	-
Lowest CH	1.281	-	2.979	-	4.795	-	9.71	-	14.266	-	20.18	-
Middle CH	1.281	-	2.937	-	4.835	-	9.61	-	14.326	-	20.26	-
Highest CH	1.290	-	2.949	-	4.895	-	9.77	-	14.476	-	20.26	-



LTE Band 2

Lowest Channel / 1.4MHz / QPSK

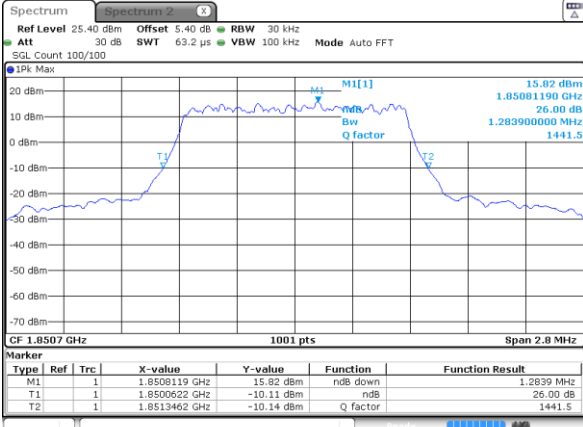

Date: 20 DEC 2019 15:05:22

Lowest Channel / 1.4MHz / 16QAM

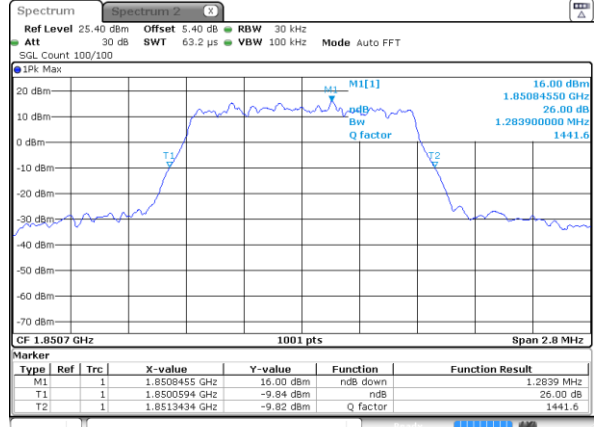

Date: 20 DEC 2019 15:05:32

Middle Channel / 1.4MHz / QPSK

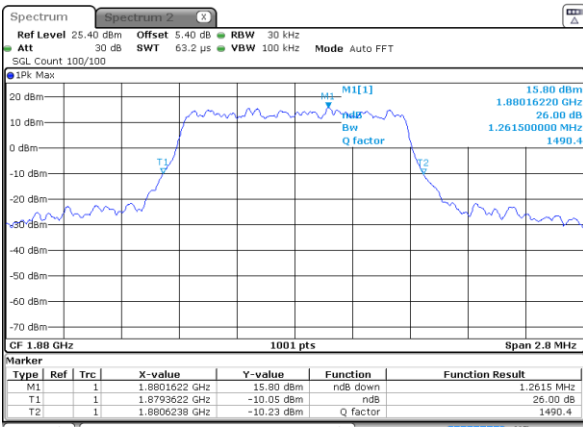

Date: 20 DEC 2019 15:12:20

Middle Channel / 1.4MHz / 16QAM

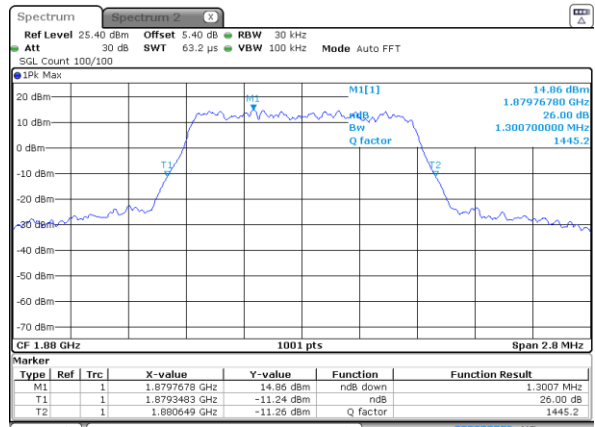

Date: 20 DEC 2019 15:12:30

Highest Channel / 1.4MHz / QPSK

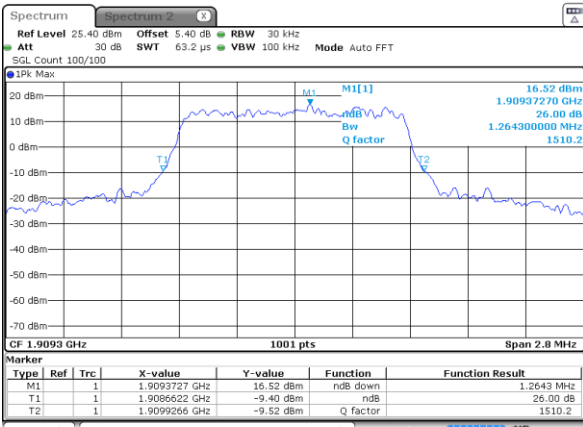

Date: 20 DEC 2019 15:14:49

Highest Channel / 1.4MHz / 16QAM

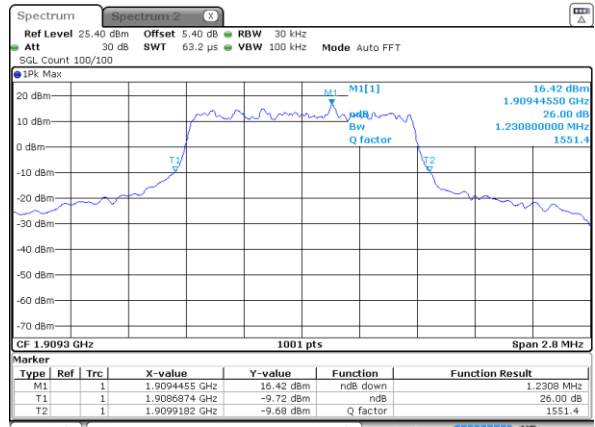

Date: 20 DEC 2019 15:14:59



LTE Band 2

Lowest Channel / 3MHz / QPSK

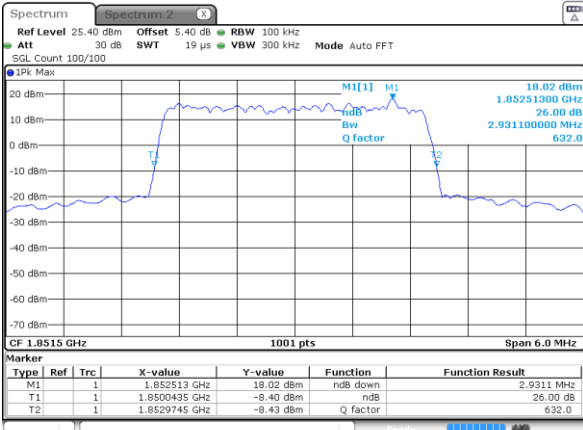

Date: 20 DEC 2019 15:21:47

Lowest Channel / 3MHz / 16QAM

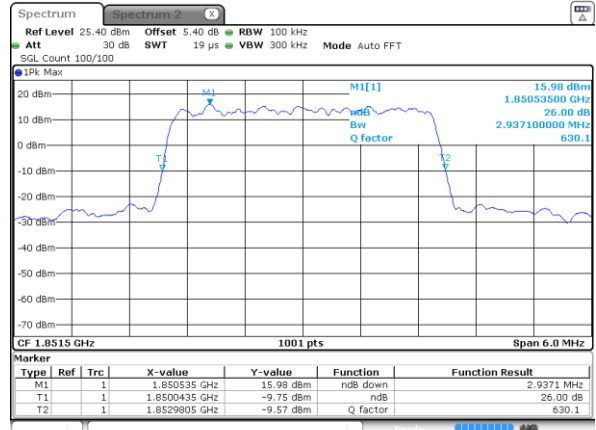

Date: 20 DEC 2019 15:21:57

Middle Channel / 3MHz / QPSK

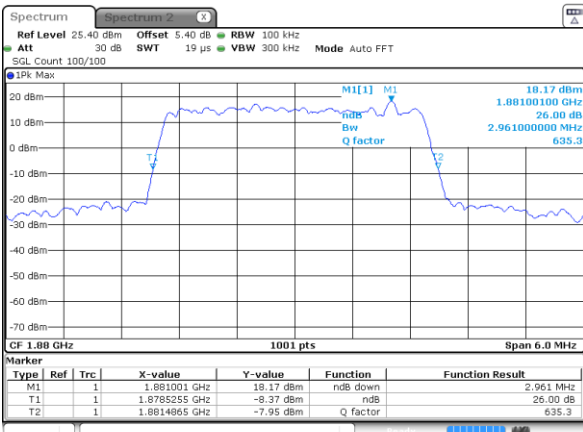

Date: 20 DEC 2019 15:28:46

Middle Channel / 3MHz / 16QAM

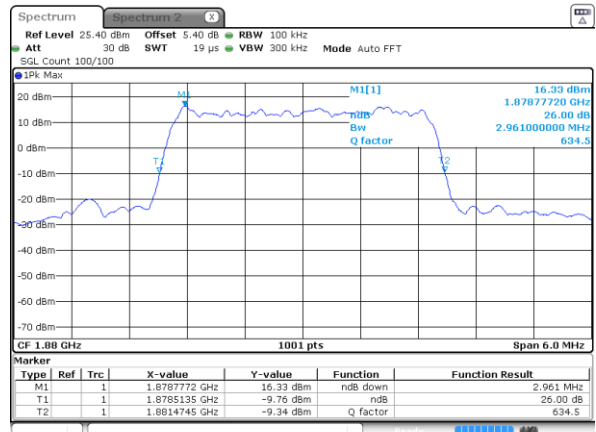

Date: 20 DEC 2019 15:28:56

Highest Channel / 3MHz / QPSK

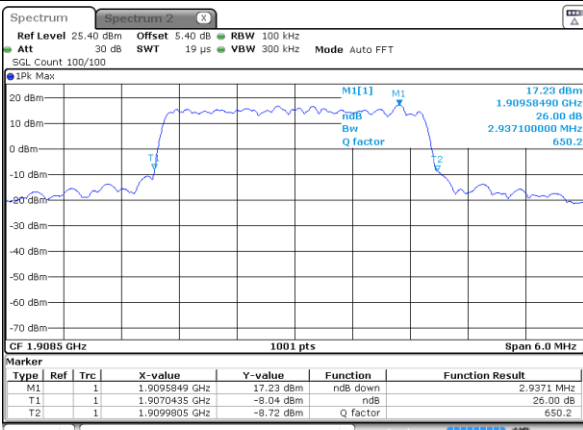

Date: 20 DEC 2019 15:31:14

Highest Channel / 3MHz / 16QAM

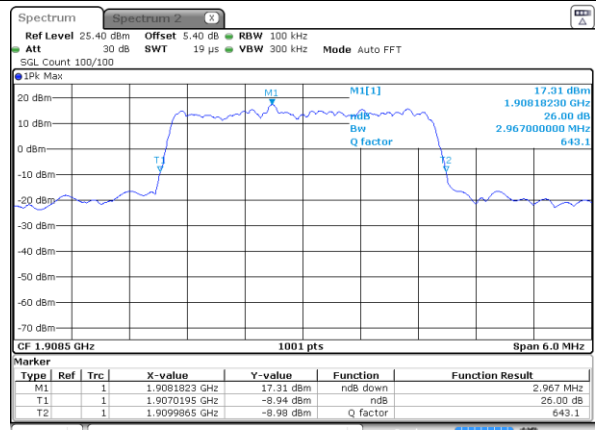

Date: 20 DEC 2019 15:31:24



LTE Band 2

Lowest Channel / 5MHz / QPSK

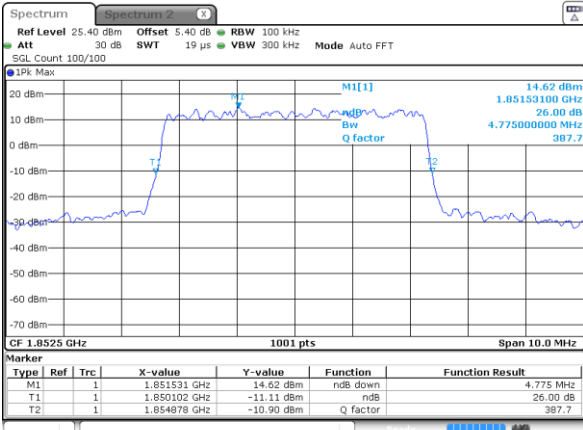

Date: 20 DEC 2019 15:38:13

Lowest Channel / 5MHz / 16QAM

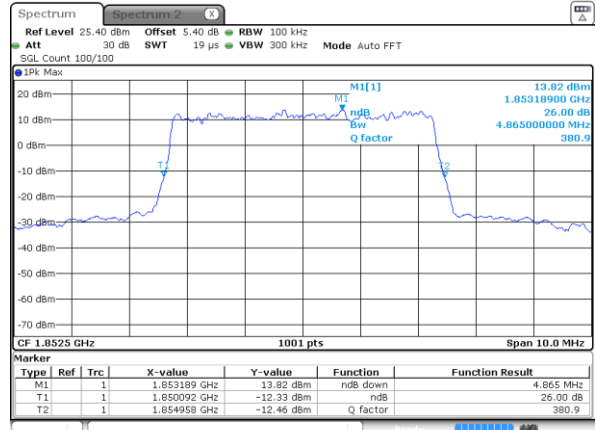

Date: 20 DEC 2019 15:38:23

Middle Channel / 5MHz / QPSK

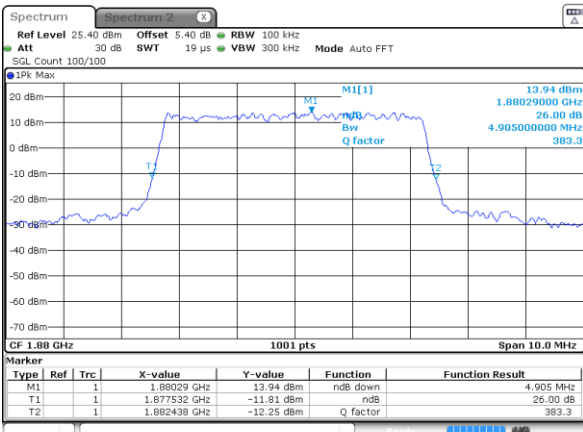

Date: 20 DEC 2019 15:45:11

Middle Channel / 5MHz / 16QAM

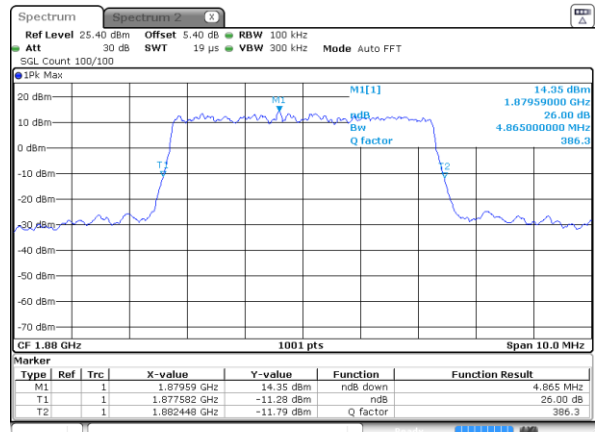

Date: 20 DEC 2019 15:45:21

Highest Channel / 5MHz / QPSK

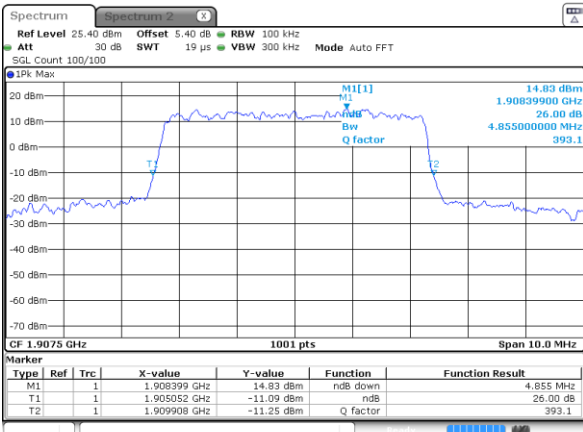

Date: 20 DEC 2019 15:47:40

Highest Channel / 5MHz / 16QAM

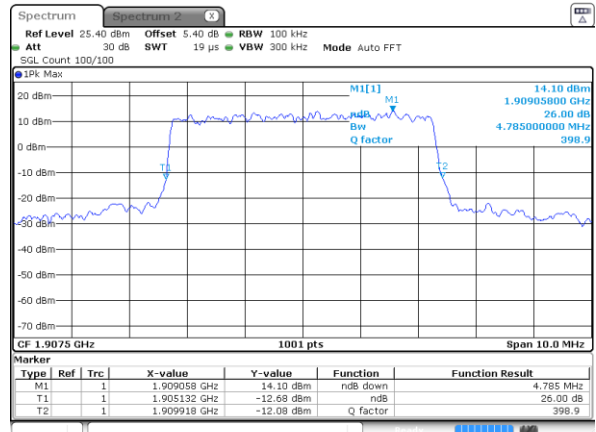

Date: 20 DEC 2019 15:47:50



LTE Band 2

Lowest Channel / 10MHz / QPSK

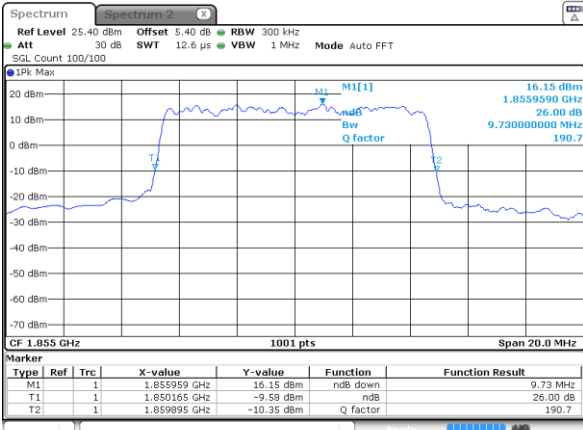

Date: 20 DEC 2019 15:54:38

Lowest Channel / 10MHz / 16QAM

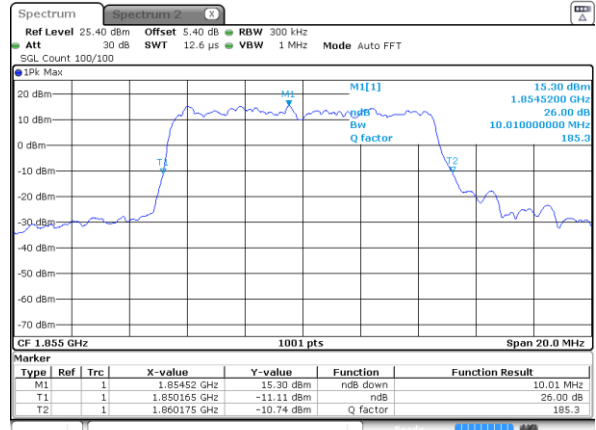

Date: 20 DEC 2019 15:54:48

Middle Channel / 10MHz / QPSK

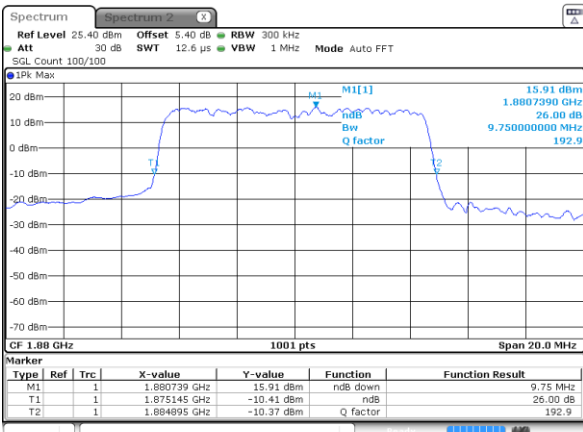

Date: 20 DEC 2019 18:01:38

Middle Channel / 10MHz / 16QAM

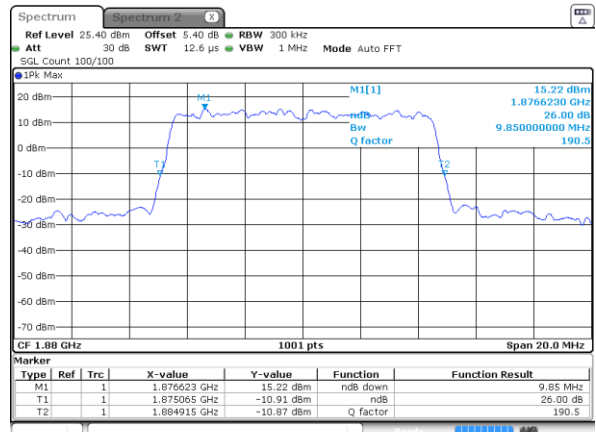

Date: 20 DEC 2019 18:01:46

Highest Channel / 10MHz / QPSK

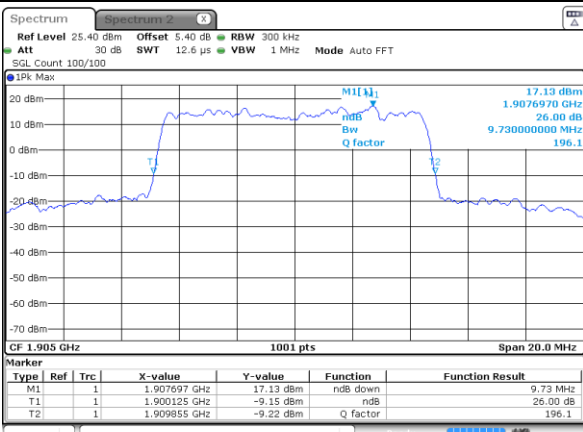

Date: 20 DEC 2019 18:04:05

Highest Channel / 10MHz / 16QAM

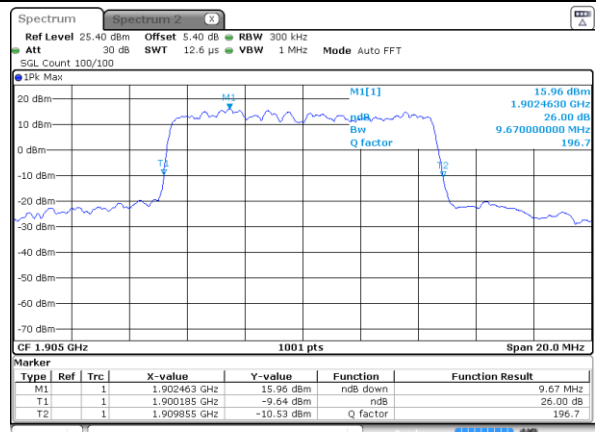

Date: 20 DEC 2019 18:04:15



LTE Band 2

Lowest Channel / 15MHz / QPSK

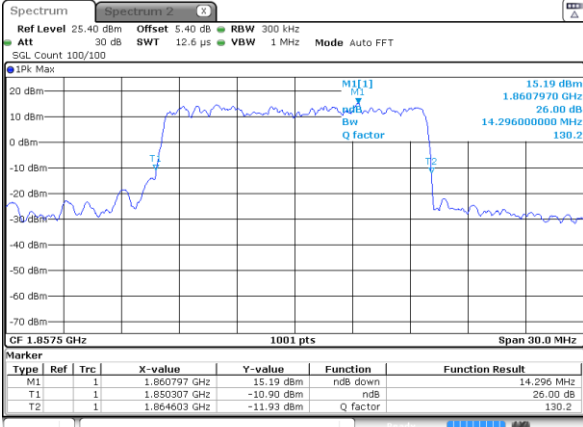

Date: 20 DEC 2019 16:11:03

Lowest Channel / 15MHz / 16QAM

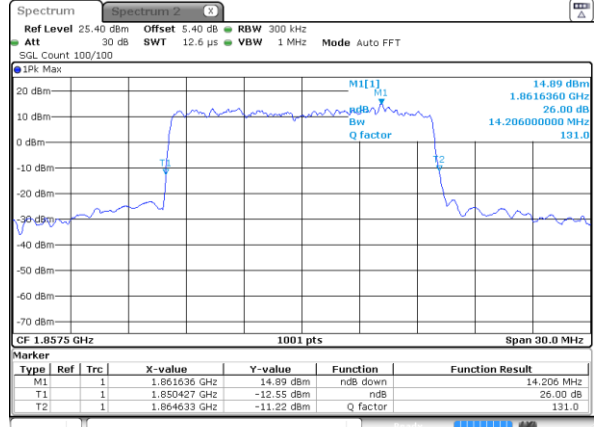

Date: 20 DEC 2019 16:11:13

Middle Channel / 15MHz / QPSK

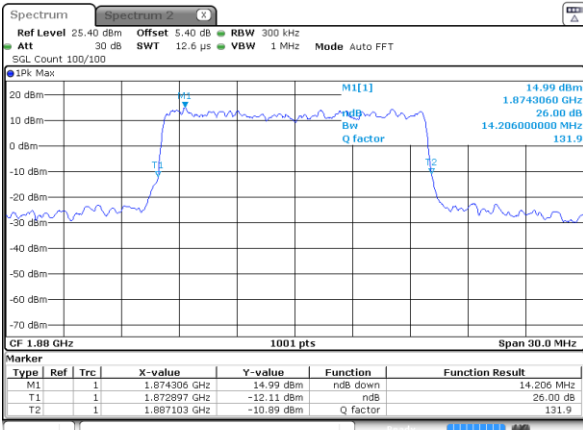

Date: 20 DEC 2019 16:18:01

Middle Channel / 15MHz / 16QAM

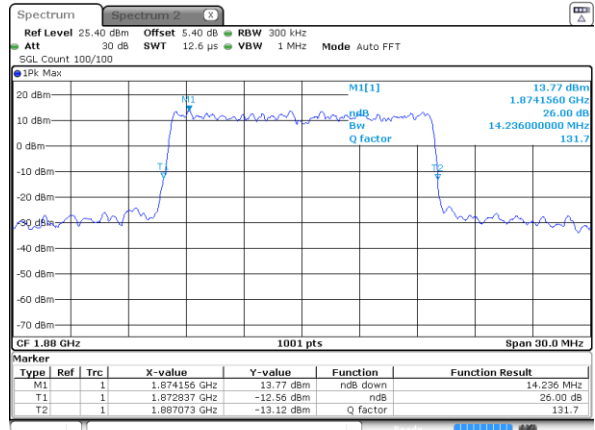

Date: 20 DEC 2019 16:18:11

Highest Channel / 15MHz / QPSK

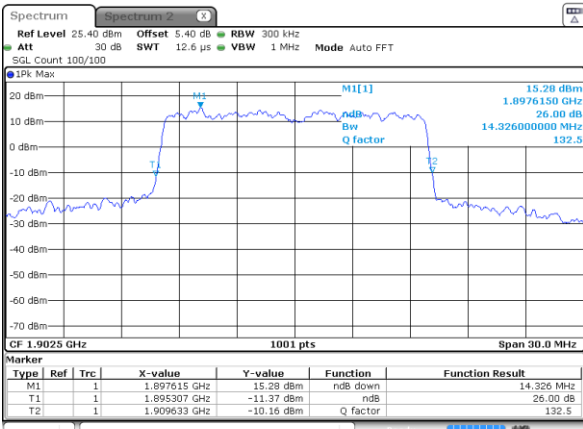

Date: 20 DEC 2019 16:20:30

Highest Channel / 15MHz / 16QAM

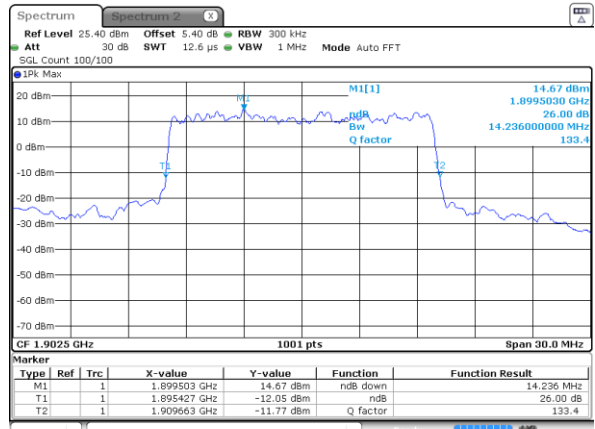

Date: 20 DEC 2019 16:20:40



LTE Band 2

Lowest Channel / 20MHz / QPSK

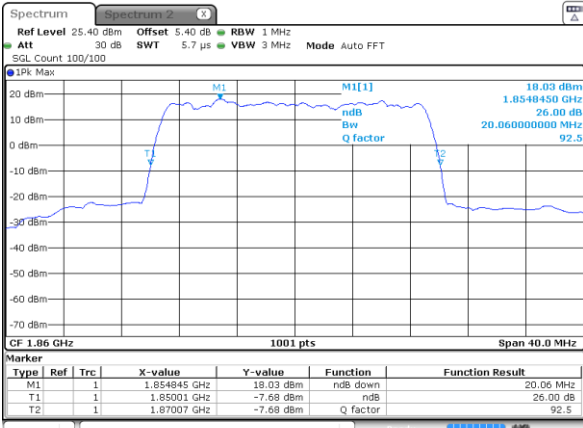

Date: 20 DEC 2019 16:27:29

Lowest Channel / 20MHz / 16QAM

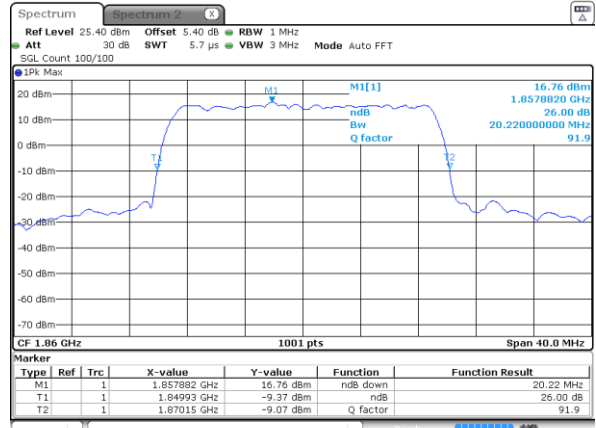

Date: 20 DEC 2019 16:27:39

Middle Channel / 20MHz / QPSK

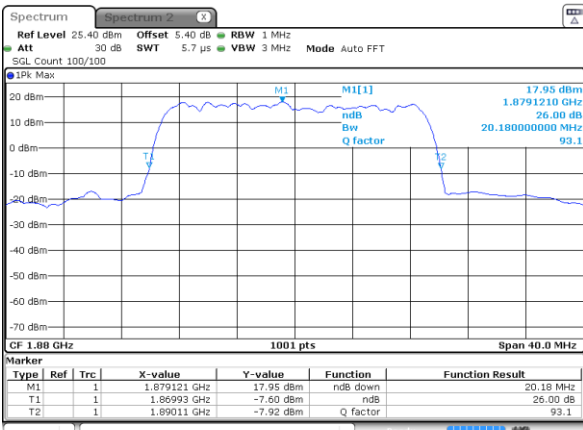

Date: 20 DEC 2019 16:34:27

Middle Channel / 20MHz / 16QAM

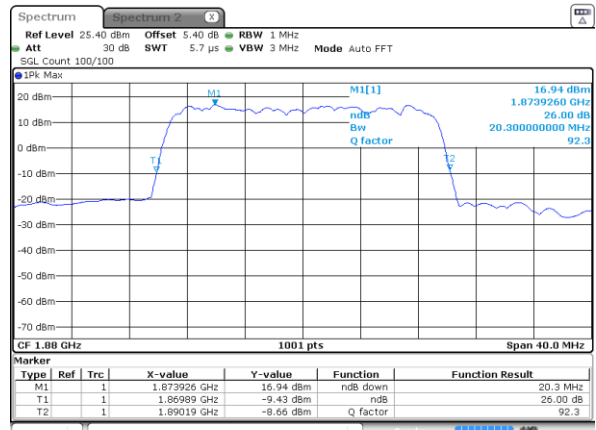

Date: 20 DEC 2019 16:34:37

Highest Channel / 20MHz / QPSK

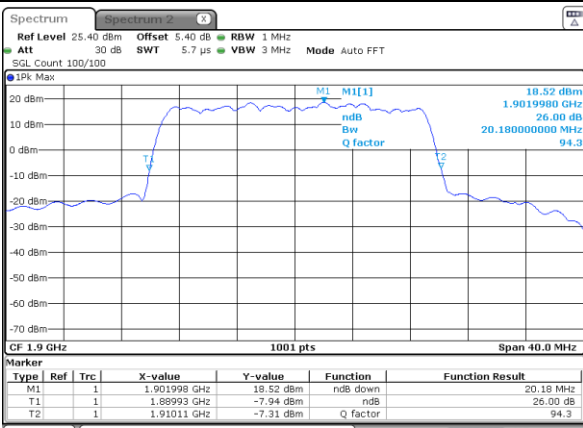

Date: 20 DEC 2019 16:36:56

Highest Channel / 20MHz / 16QAM

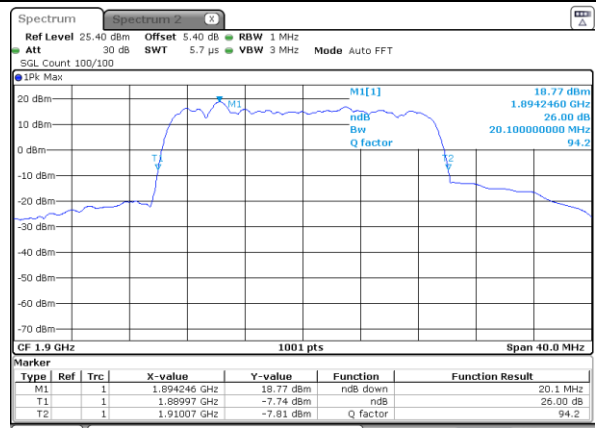

Date: 20 DEC 2019 16:37:06



LTE Band 2

Lowest Channel / 1.4MHz / 64QAM

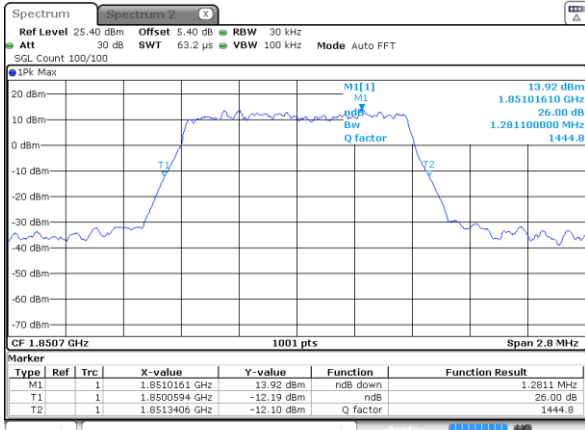

Date: 20 DEC 2019 16:47:38

Lowest Channel / 3MHz / 64QAM

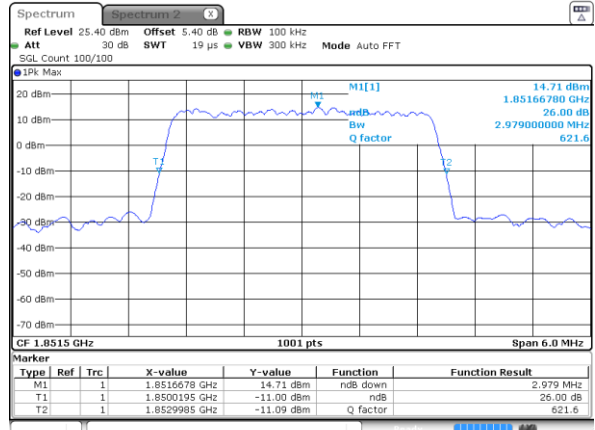

Date: 20 DEC 2019 16:48:08

Middle Channel / 1.4MHz / 64QAM

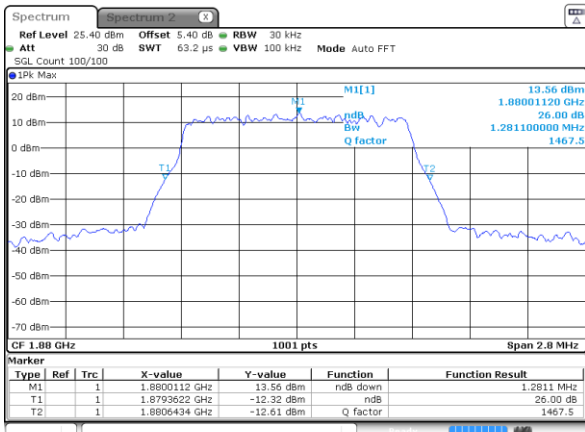

Date: 20 DEC 2019 16:47:48

Middle Channel / 3MHz / 64QAM

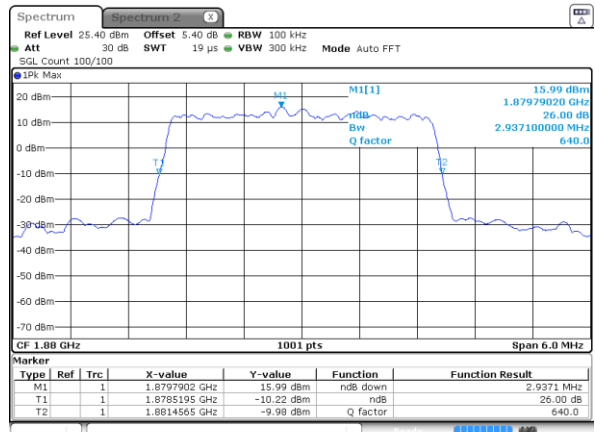

Date: 20 DEC 2019 16:48:18

Highest Channel / 1.4MHz / 64QAM

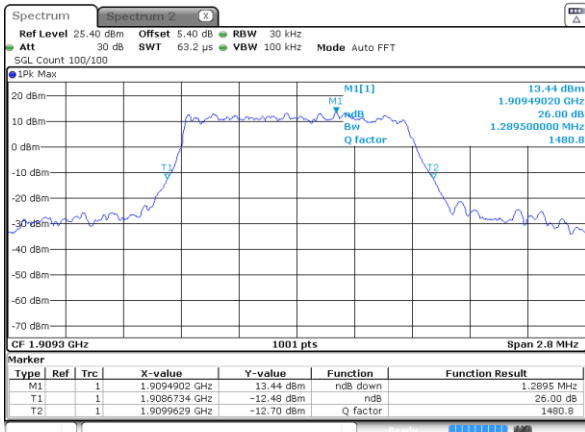

Date: 20 DEC 2019 16:47:58

Highest Channel / 3MHz / 64QAM

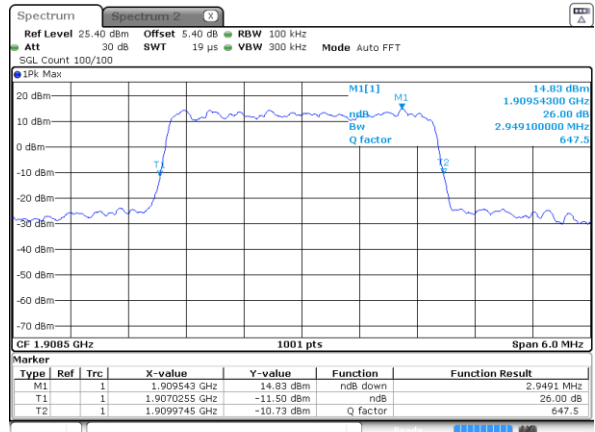

Date: 20 DEC 2019 16:48:28



LTE Band 2

Lowest Channel / 5MHz / 64QAM

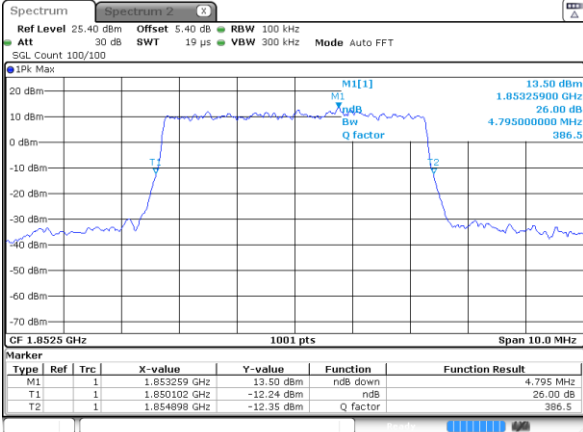

Date: 20 DEC 2019 16:48:37

Lowest Channel / 10MHz / 64QAM

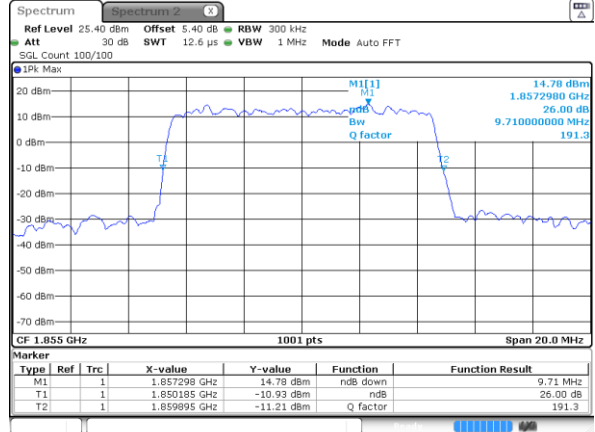

Date: 20 DEC 2019 16:49:07

Middle Channel / 5MHz / 64QAM

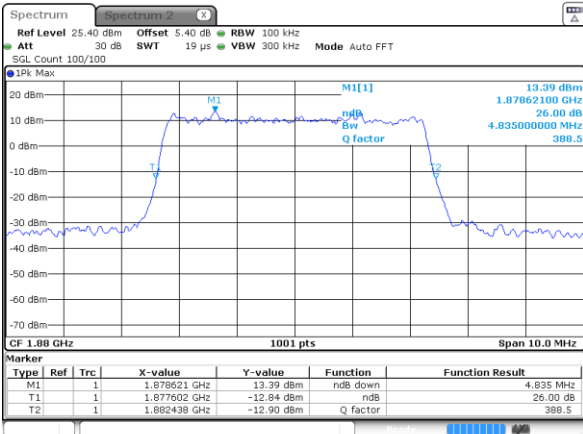

Date: 20 DEC 2019 16:48:47

Middle Channel / 10MHz / 64QAM

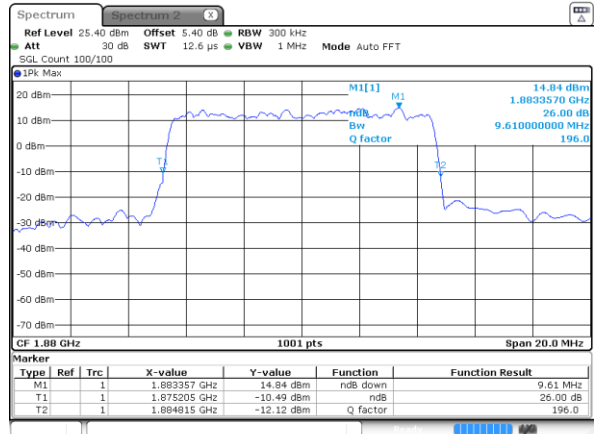

Date: 20 DEC 2019 16:49:17

Highest Channel / 5MHz / 64QAM

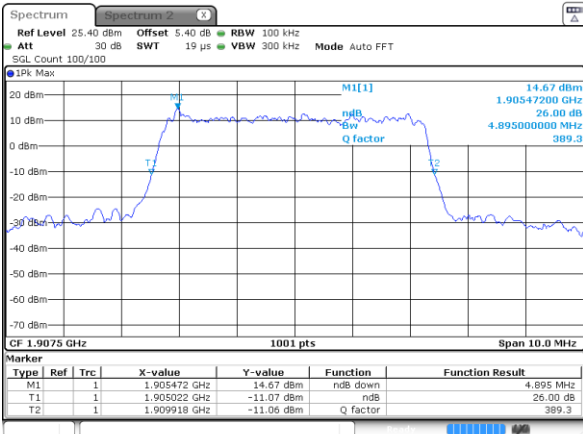

Date: 20 DEC 2019 16:48:57

Highest Channel / 10MHz / 64QAM

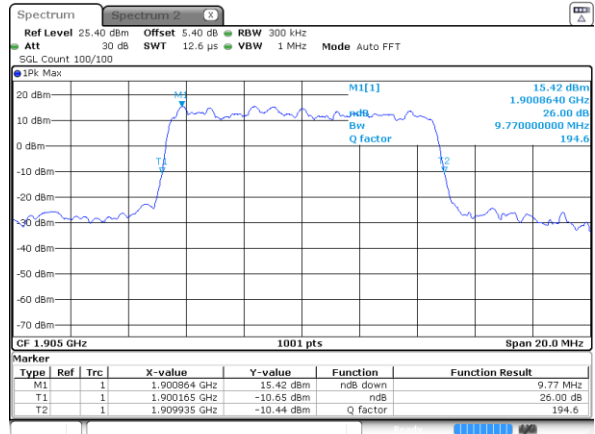

Date: 20 DEC 2019 16:49:27



LTE Band 2

Lowest Channel / 15MHz / 64QAM

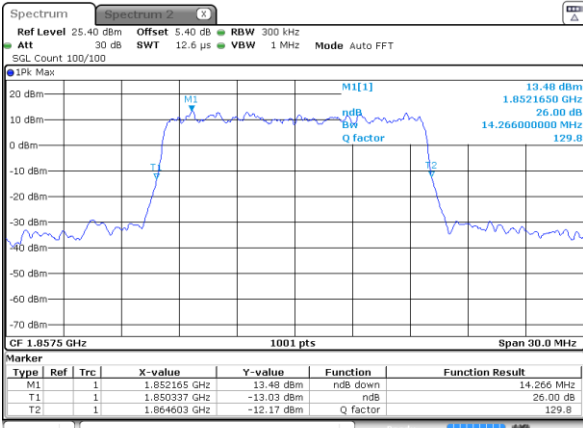

Date: 20 DEC 2019 16:49:37

Lowest Channel / 20MHz / 64QAM

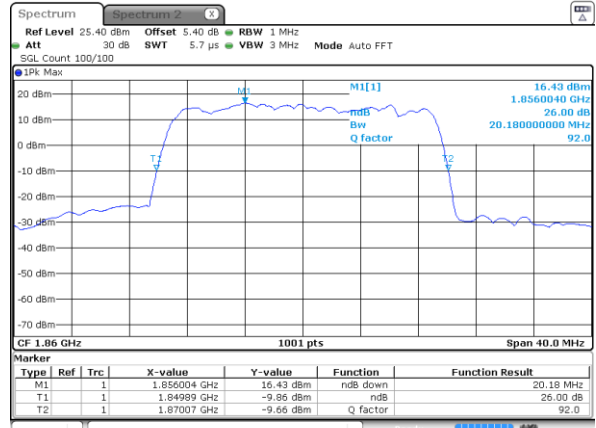

Date: 20 DEC 2019 16:50:07

Middle Channel / 15MHz / 64QAM

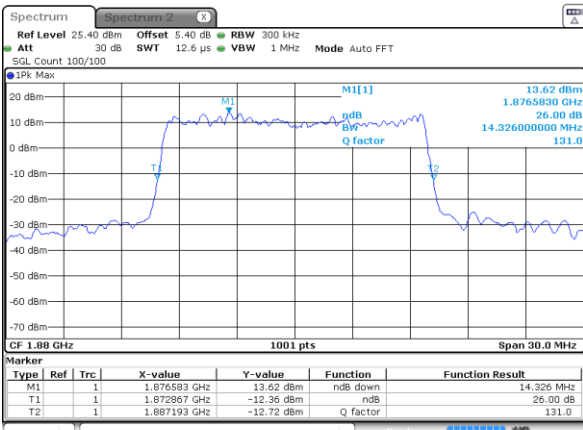

Date: 20 DEC 2019 16:49:47

Middle Channel / 20MHz / 64QAM

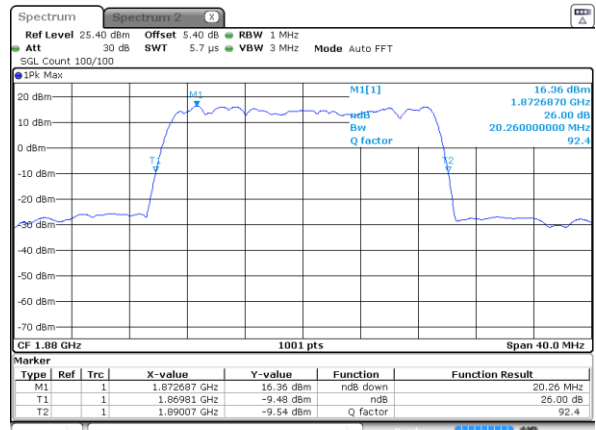

Date: 20 DEC 2019 16:50:17

Highest Channel / 15MHz / 64QAM

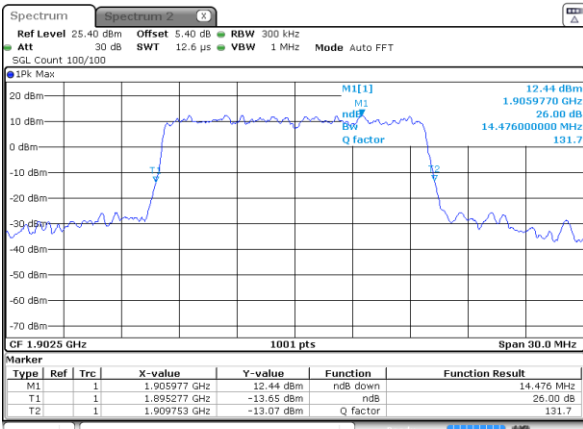

Date: 20 DEC 2019 16:49:57

Highest Channel / 20MHz / 64QAM

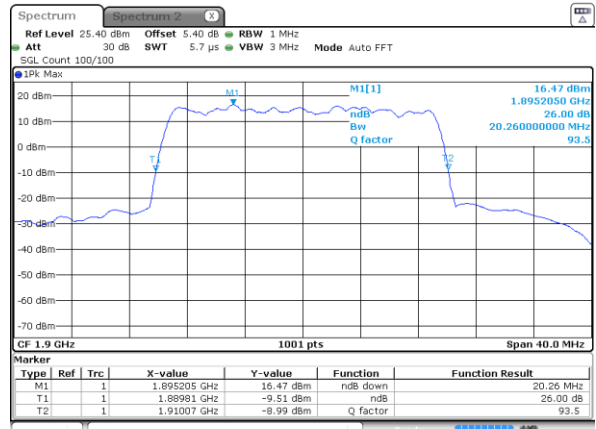

Date: 20 DEC 2019 16:50:27



Occupied Bandwidth

Mode	LTE Band 2 : 99%OBW(MHz)											
BW	1.4MHz		3MHz		5MHz		10MHz		15MHz		20MHz	
Mod.	QPSK	16QAM	QPSK	16QAM	QPSK	16QAM	QPSK	16QAM	QPSK	16QAM	QPSK	16QAM
Lowest CH	1.08	1.08	2.70	2.73	4.49	4.48	8.99	8.99	13.40	13.52	18.50	18.42
Middle CH	1.09	1.09	2.70	2.72	4.48	4.50	9.09	9.03	13.46	13.46	18.46	18.38
Highest CH	1.09	1.10	2.72	2.71	4.48	4.49	9.05	9.07	13.43	13.43	18.26	18.42
Mode	LTE Band 2 : 99%OBW(MHz)											
BW	1.4MHz		3MHz		5MHz		10MHz		15MHz		20MHz	
Mod.	64QAM	-	64QAM	-	64QAM	-	64QAM	-	64QAM	-	64QAM	-
Lowest CH	1.09	-	2.70	-	4.47	-	9.01	-	13.40	-	18.30	-
Middle CH	1.10	-	2.72	-	4.48	-	9.07	-	13.40	-	18.42	-
Highest CH	1.09	-	2.72	-	4.48	-	8.99	-	13.46	-	18.42	-



LTE Band 2

Lowest Channel / 1.4MHz / QPSK

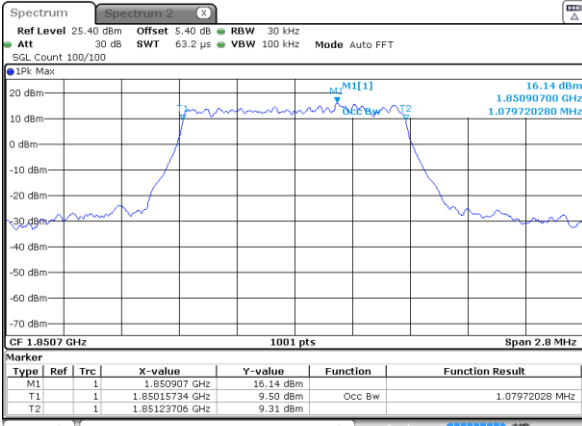

Date: 20 DEC 2019 15:05:02

Lowest Channel / 1.4MHz / 16QAM

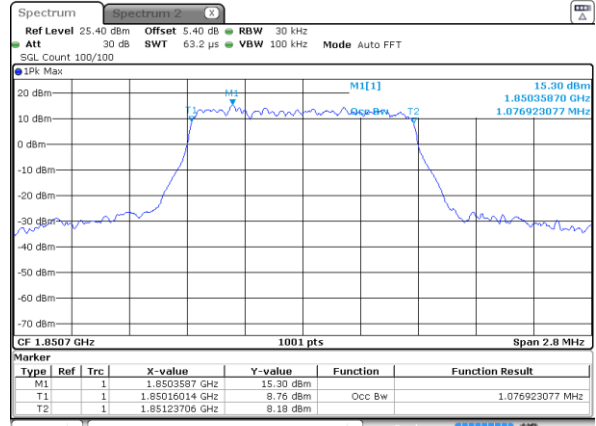

Date: 20 DEC 2019 15:05:12

Middle Channel / 1.4MHz / QPSK

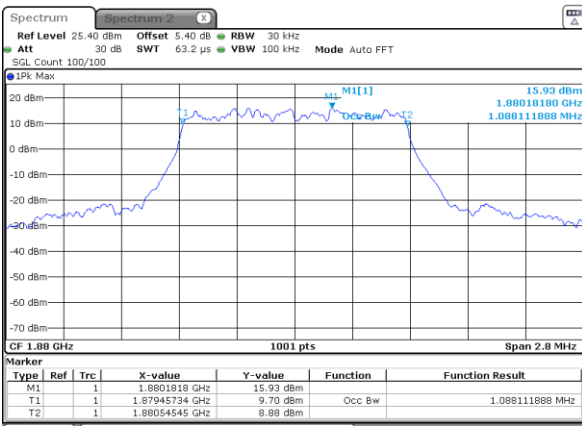

Date: 20 DEC 2019 15:12:01

Middle Channel / 1.4MHz / 16QAM

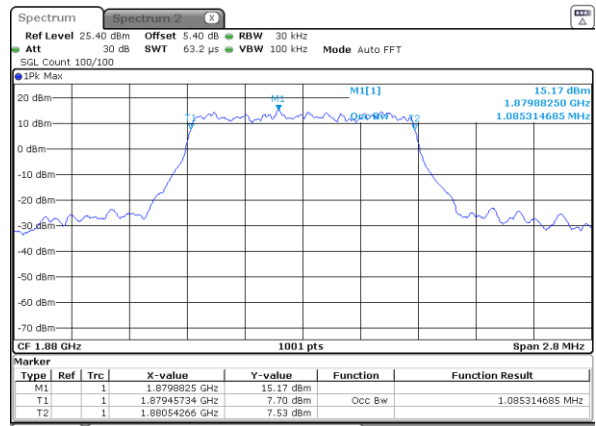

Date: 20 DEC 2019 15:12:11

Highest Channel / 1.4MHz / QPSK

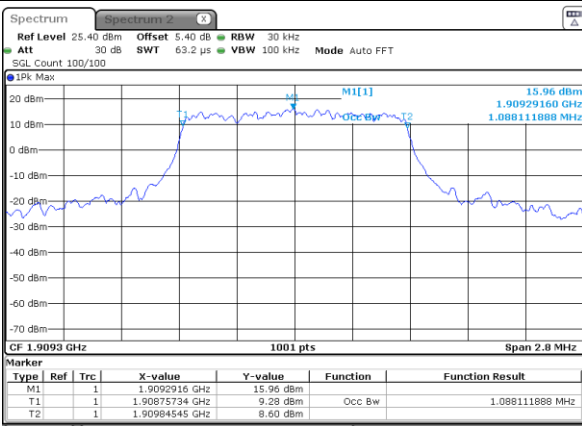

Date: 20 DEC 2019 15:14:29

Highest Channel / 1.4MHz / 16QAM

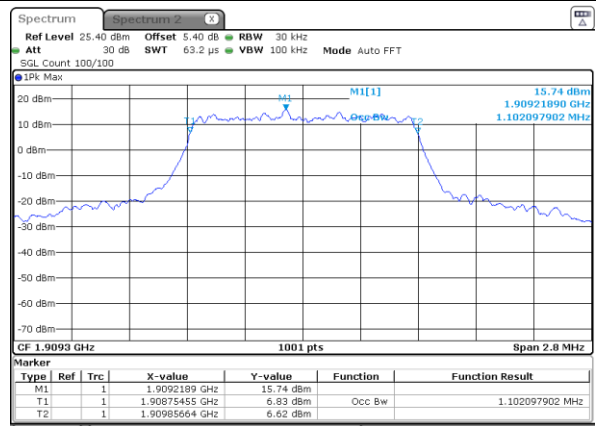

Date: 20 DEC 2019 15:14:39



LTE Band 2

Lowest Channel / 3MHz / QPSK

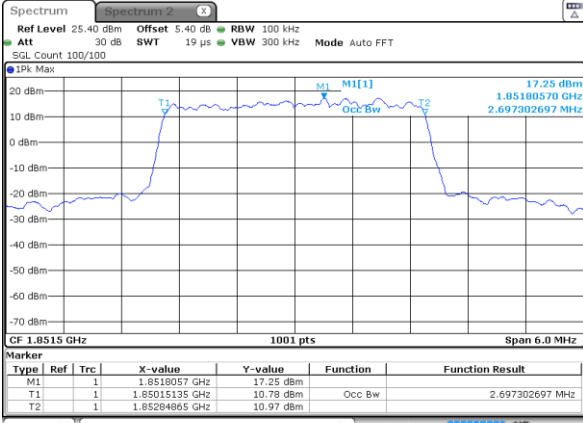

Date: 20 DEC 2019 15:21:27

Lowest Channel / 3MHz / 16QAM

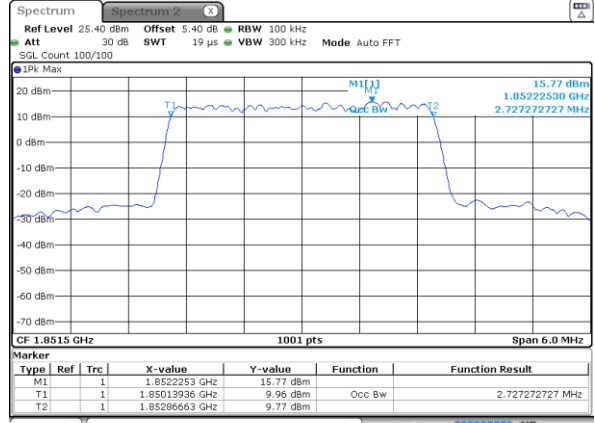

Date: 20 DEC 2019 15:21:37

Middle Channel / 3MHz / QPSK

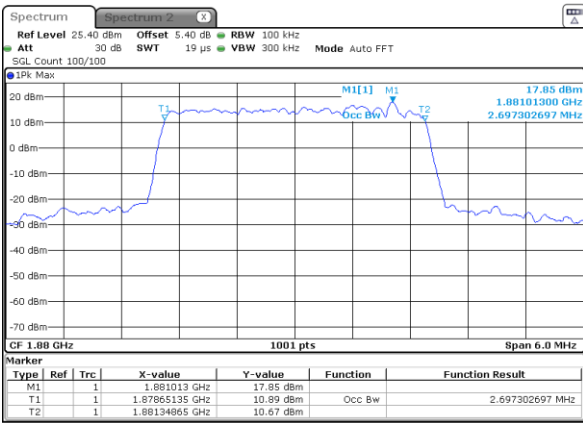

Date: 20 DEC 2019 15:28:26

Middle Channel / 3MHz / 16QAM

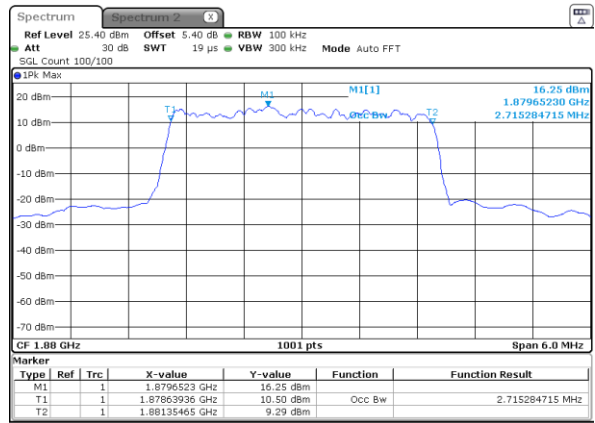

Date: 20 DEC 2019 15:28:36

Highest Channel / 3MHz / QPSK

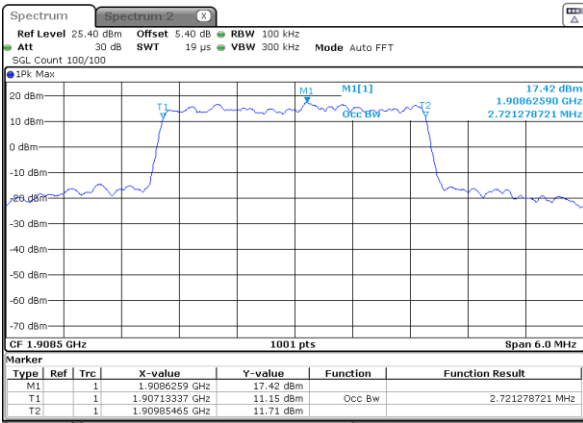

Date: 20 DEC 2019 15:30:54

Highest Channel / 3MHz / 16QAM

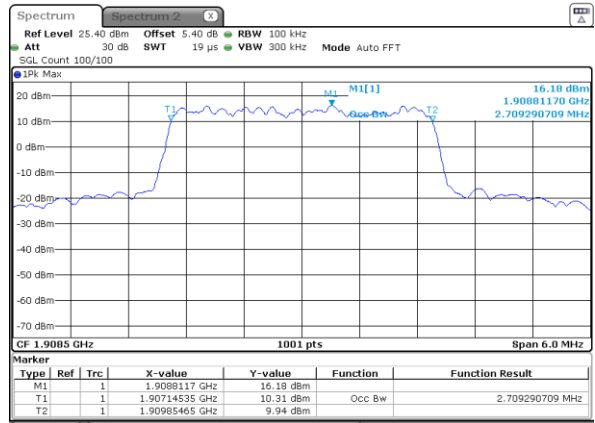

Date: 20 DEC 2019 15:31:04



LTE Band 2

Lowest Channel / 5MHz / QPSK

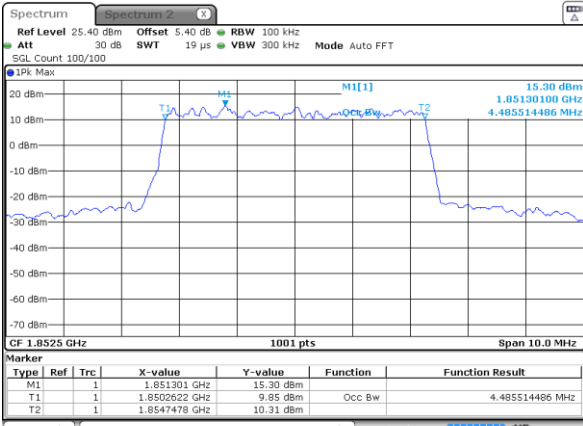

Date: 20 DEC 2019 15:37:52

Lowest Channel / 5MHz / 16QAM

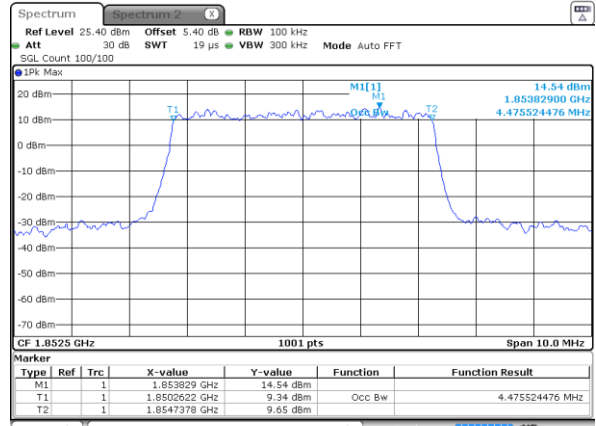

Date: 20 DEC 2019 15:38:03

Middle Channel / 5MHz / QPSK

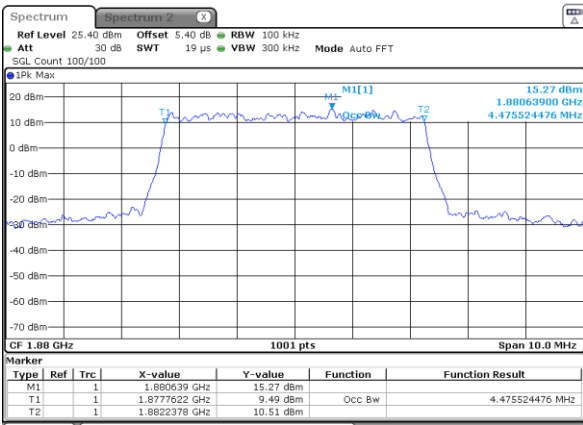

Date: 20 DEC 2019 15:44:51

Middle Channel / 5MHz / 16QAM

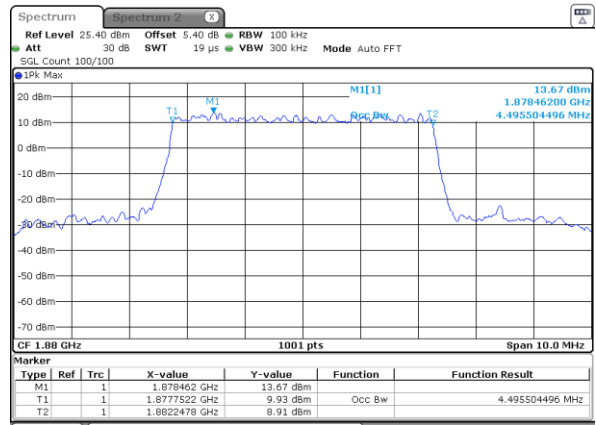

Date: 20 DEC 2019 15:45:01

Highest Channel / 5MHz / QPSK

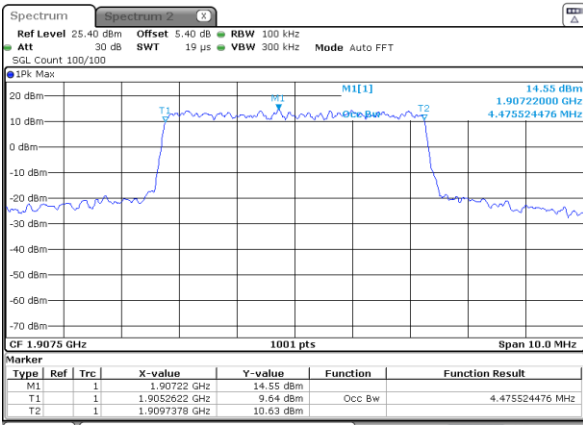

Date: 20 DEC 2019 15:47:20

Highest Channel / 5MHz / 16QAM

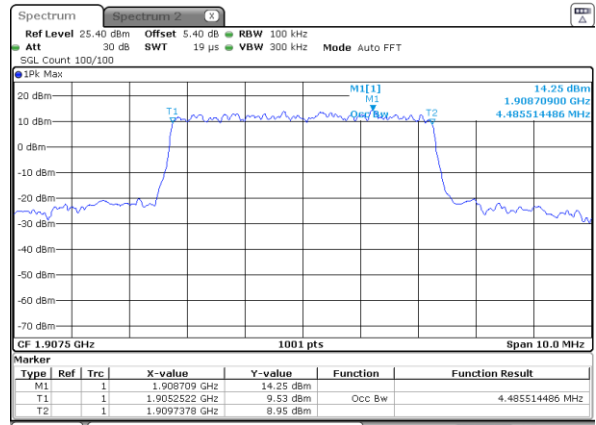

Date: 20 DEC 2019 15:47:30



LTE Band 2

Lowest Channel / 10MHz / QPSK

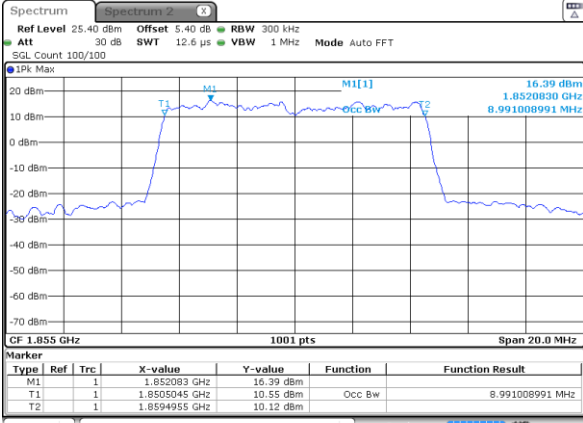

Date: 20 DEC 2019 15:54:18

Lowest Channel / 10MHz / 16QAM

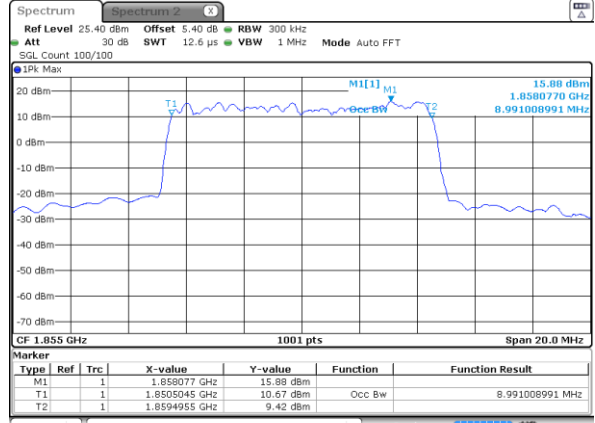

Date: 20 DEC 2019 15:54:28

Middle Channel / 10MHz / QPSK

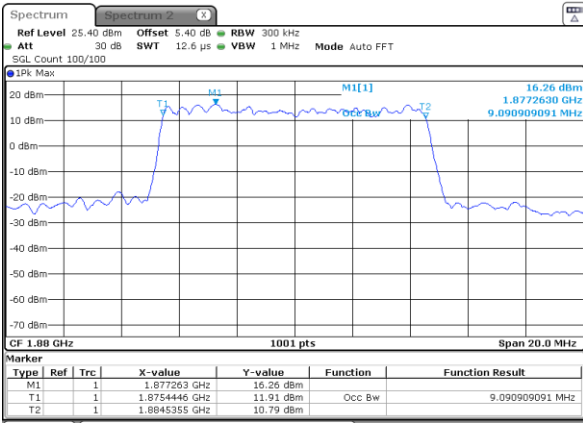

Date: 20 DEC 2019 16:01:16

Middle Channel / 10MHz / 16QAM

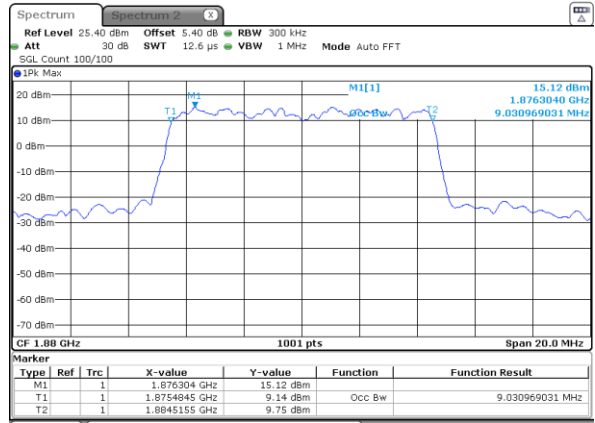

Date: 20 DEC 2019 16:01:26

Highest Channel / 10MHz / QPSK

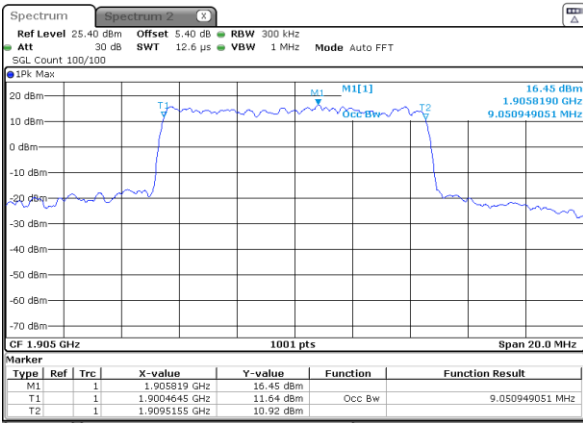

Date: 20 DEC 2019 16:03:45

Highest Channel / 10MHz / 16QAM

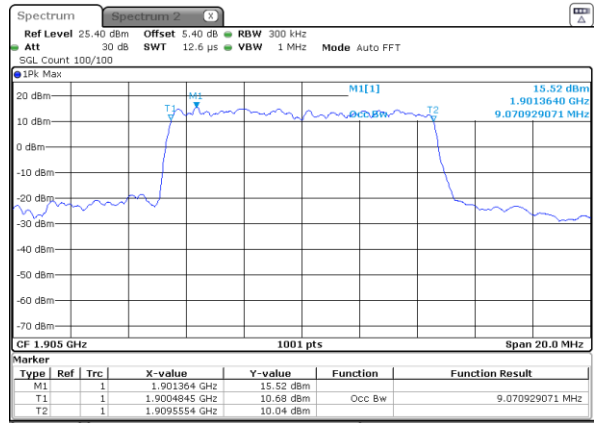

Date: 20 DEC 2019 16:03:55



LTE Band 2

Lowest Channel / 15MHz / QPSK

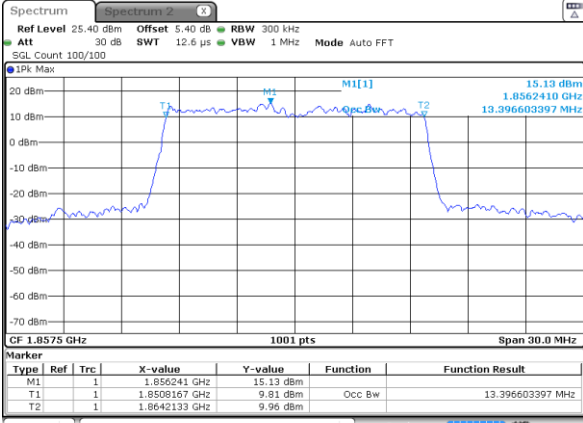

Date: 20 DEC 2019 16:10:43

Lowest Channel / 15MHz / 16QAM

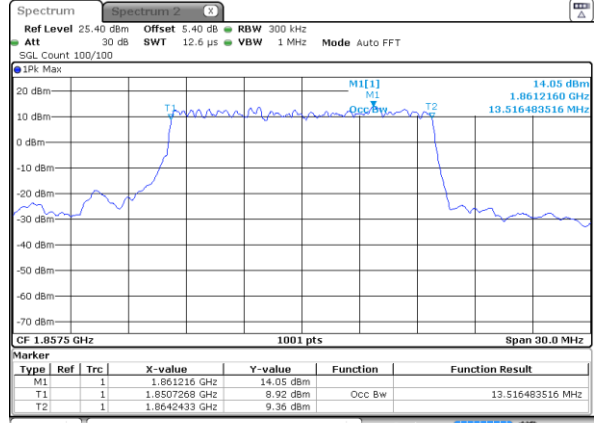

Date: 20 DEC 2019 16:10:53

Middle Channel / 15MHz / QPSK

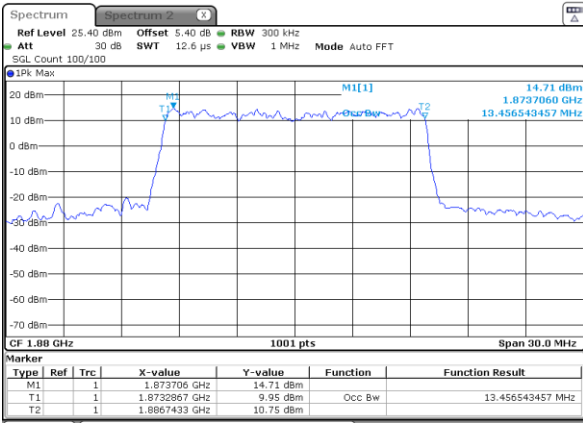

Date: 20 DEC 2019 16:17:41

Middle Channel / 15MHz / 16QAM

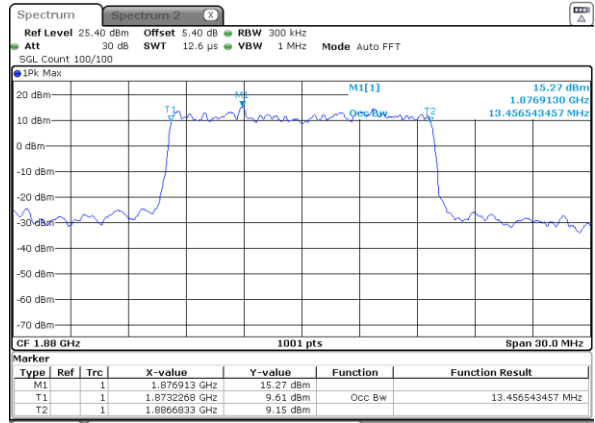

Date: 20 DEC 2019 16:17:51

Highest Channel / 15MHz / QPSK

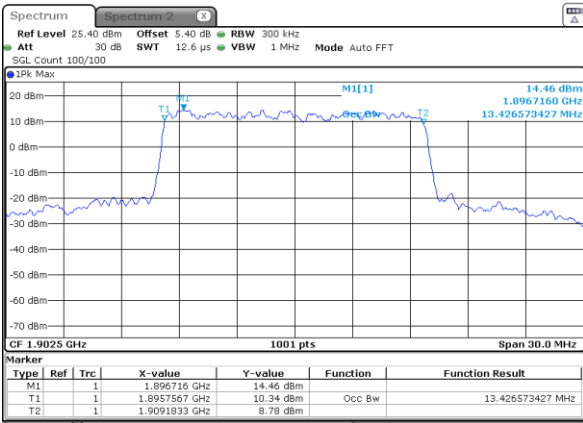

Date: 20 DEC 2019 16:20:10

Highest Channel / 15MHz / 16QAM

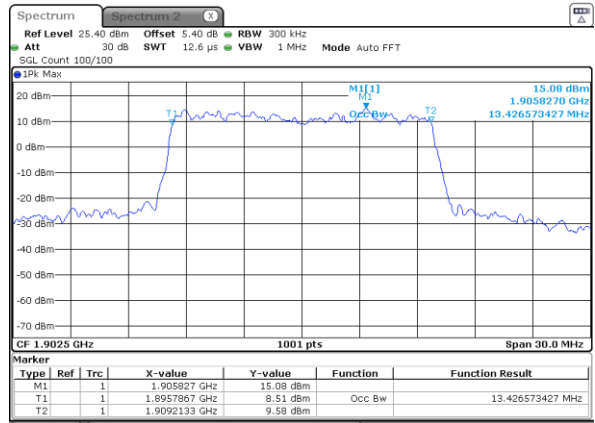

Date: 20 DEC 2019 16:20:20



LTE Band 2

Lowest Channel / 20MHz / QPSK

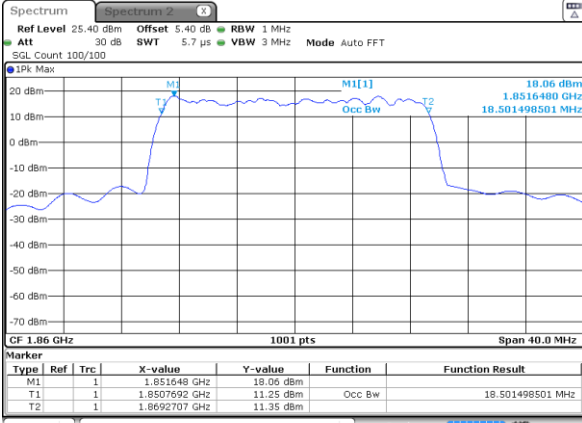

Date: 20 DEC 2019 16:27:09

Lowest Channel / 20MHz / 16QAM

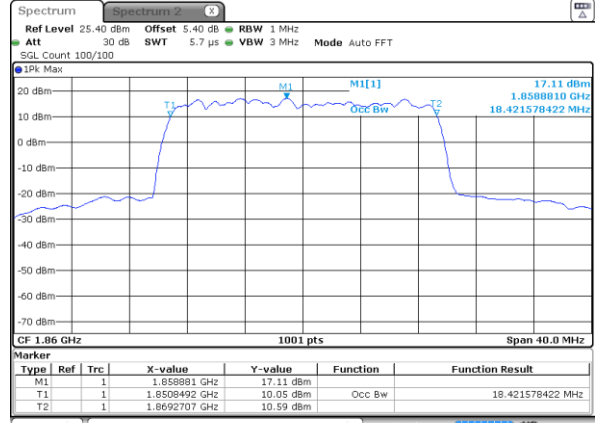

Date: 20 DEC 2019 16:27:19

Middle Channel / 20MHz / QPSK

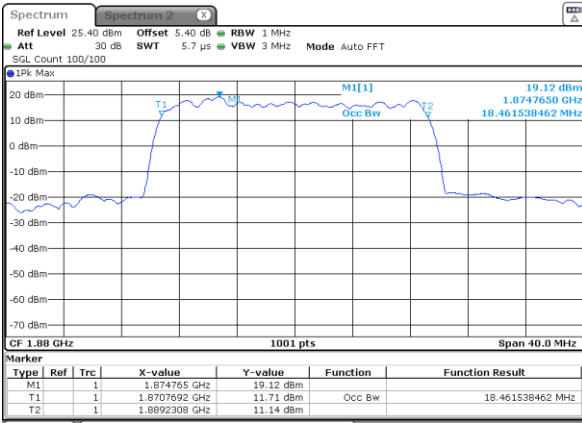

Date: 20 DEC 2019 16:34:07

Middle Channel / 20MHz / 16QAM

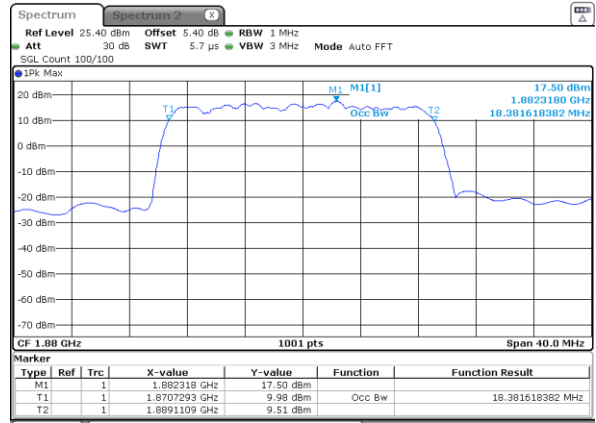

Date: 20 DEC 2019 16:34:17

Highest Channel / 20MHz / QPSK

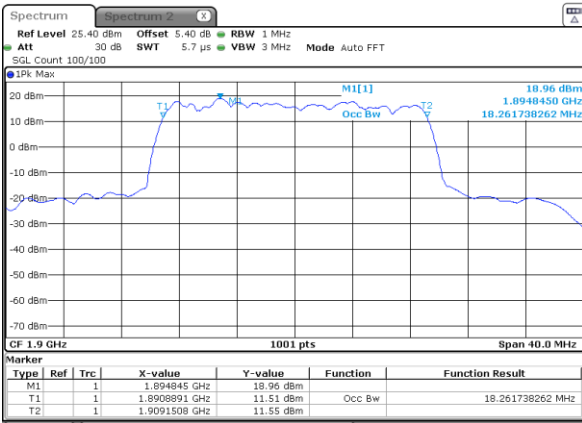

Date: 20 DEC 2019 16:36:36

Highest Channel / 20MHz / 16QAM

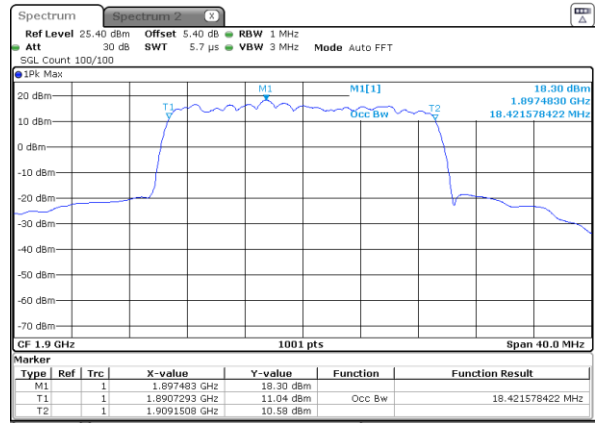

Date: 20 DEC 2019 16:36:46