

#01_GSM850_GPRS (3 Tx slots)_Left Cheek_Ch251

Communication System: GSM850 ; Frequency: 848.8 MHz;Duty Cycle: 1:2.77

Medium: HSL_850_200407 Medium parameters used: $f = 849$ MHz; $\sigma = 0.904$ S/m; $\epsilon_r = 40.368$; $\rho = 1000$ kg/m³

Ambient Temperature : 23.4 °C ; Liquid Temperature : 22.4 °C

DASY5 Configuration:

- Probe: EX3DV4 - SN3728; ConvF(9.51, 9.51, 9.51) @ 848.8 MHz; Calibrated: 2020/2/4
- Sensor-Surface: 1.4mm (Mechanical Surface Detection)
- Electronics: DAE3 Sn495; Calibrated: 2019/5/21
- Phantom: SAM LEFT; Type: QD000P40CD; Serial: TP:1718
- Measurement SW: DASY52, Version 52.10 (4);SEMCAD X Version 14.6.14 (7483)

Area Scan (71x121x1): Interpolated grid: dx=1.500 mm, dy=1.500 mm

Maximum value of SAR (interpolated) = 0.390 W/kg

Zoom Scan (5x5x7)/Cube 0: Measurement grid: dx=8mm, dy=8mm, dz=5mm

Reference Value = 21.42 V/m; Power Drift = 0.18 dB

Peak SAR (extrapolated) = 0.419 W/kg

SAR(1 g) = 0.319 W/kg; SAR(10 g) = 0.240 W/kg

Maximum value of SAR (measured) = 0.387 W/kg

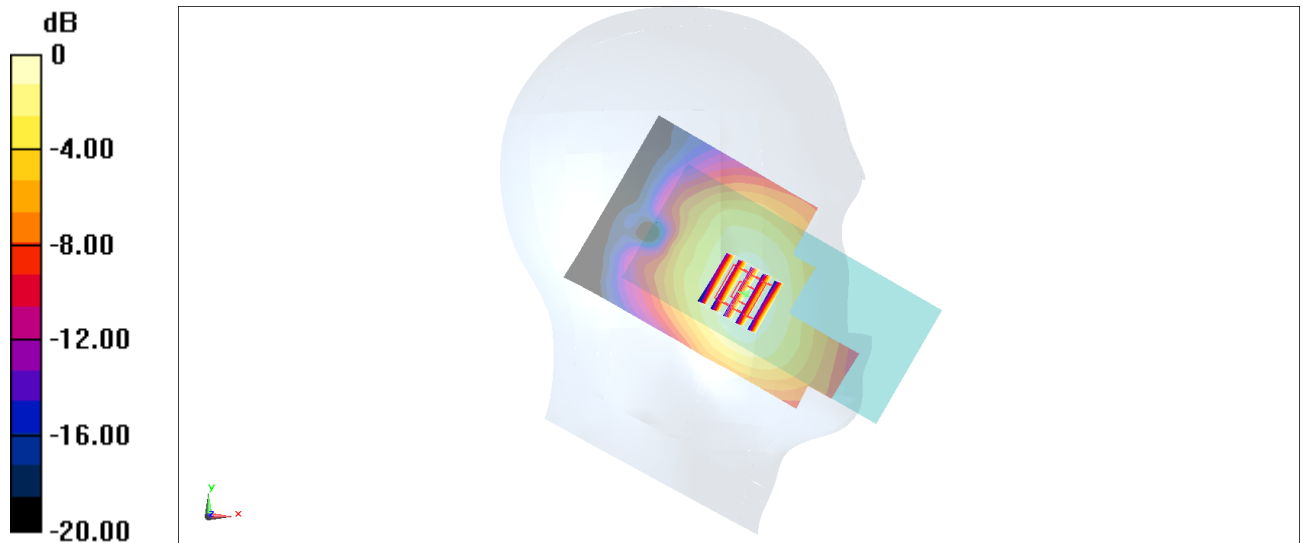

0 dB = 0.390 W/kg = -4.09 dBW/kg

#02_GSM1900_GPRS (3 Tx slots)_Left Cheek_Ch810

Communication System: PCS ; Frequency: 1909.8 MHz;Duty Cycle: 1:2.77

Medium: HSL_1900_200407 Medium parameters used: $f = 1910$ MHz; $\sigma = 1.463$ S/m; $\epsilon_r = 41$; $\rho = 1000$ kg/m³

Ambient Temperature : 23.4 °C ; Liquid Temperature : 22.4 °C

DASY5 Configuration:

- Probe: EX3DV4 - SN3728; ConvF(7.82, 7.82, 7.82) @ 1909.8 MHz; Calibrated: 2020/2/4
- Sensor-Surface: 1.4mm (Mechanical Surface Detection)
- Electronics: DAE3 Sn495; Calibrated: 2019/5/21
- Phantom: SAM LEFT; Type: QD000P40CD; Serial: TP:1718
- Measurement SW: DASY52, Version 52.10 (4);SEMCAD X Version 14.6.14 (7483)

Area Scan (71x131x1): Interpolated grid: dx=1.500 mm, dy=1.500 mm

Maximum value of SAR (interpolated) = 0.271 W/kg

Zoom Scan (5x5x7)/Cube 0: Measurement grid: dx=8mm, dy=8mm, dz=5mm

Reference Value = 12.00 V/m; Power Drift = 0.06 dB

Peak SAR (extrapolated) = 0.304 W/kg

SAR(1 g) = 0.197 W/kg; SAR(10 g) = 0.126 W/kg

Maximum value of SAR (measured) = 0.263 W/kg

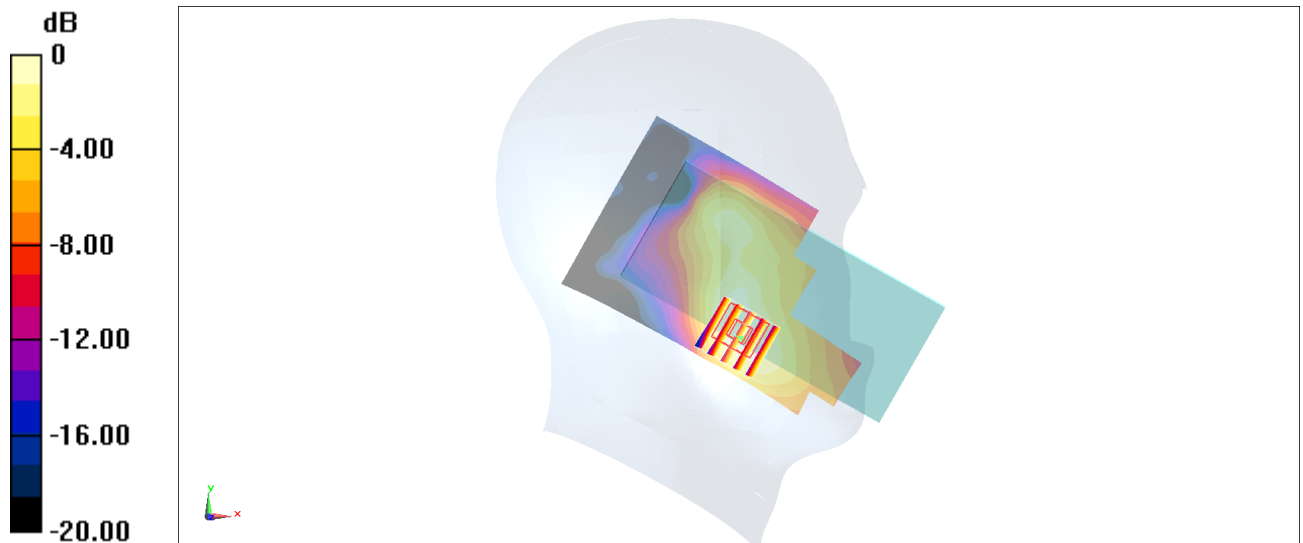

0 dB = 0.271 W/kg = -5.67 dBW/kg

#03_WCDMA II_RMC 12.2Kbps_Left Cheek_Ch9400

Communication System: WCDMA; Frequency: 1880 MHz; Duty Cycle: 1:1

Medium: HSL_1900_200407 Medium parameters used: $f = 1880$ MHz; $\sigma = 1.435$ S/m; $\epsilon_r = 41.17$; $\rho = 1000$ kg/m³

Ambient Temperature : 23.4 °C ; Liquid Temperature : 22.4 °C

DASY5 Configuration:

- Probe: EX3DV4 - SN3728; ConvF(7.82, 7.82, 7.82) @ 1880 MHz; Calibrated: 2020/2/4
- Sensor-Surface: 1.4mm (Mechanical Surface Detection)
- Electronics: DAE3 Sn495; Calibrated: 2019/5/21
- Phantom: SAM LEFT; Type: QD000P40CD; Serial: TP:1718
- Measurement SW: DASY52, Version 52.10 (4); SEMCAD X Version 14.6.14 (7483)

Area Scan (71x131x1): Interpolated grid: dx=1.500 mm, dy=1.500 mm

Maximum value of SAR (interpolated) = 0.273 W/kg

Zoom Scan (5x5x7)/Cube 0: Measurement grid: dx=8mm, dy=8mm, dz=5mm

Reference Value = 6.825 V/m; Power Drift = 0.17 dB

Peak SAR (extrapolated) = 0.299 W/kg

SAR(1 g) = 0.186 W/kg; SAR(10 g) = 0.117 W/kg

Maximum value of SAR (measured) = 0.257 W/kg

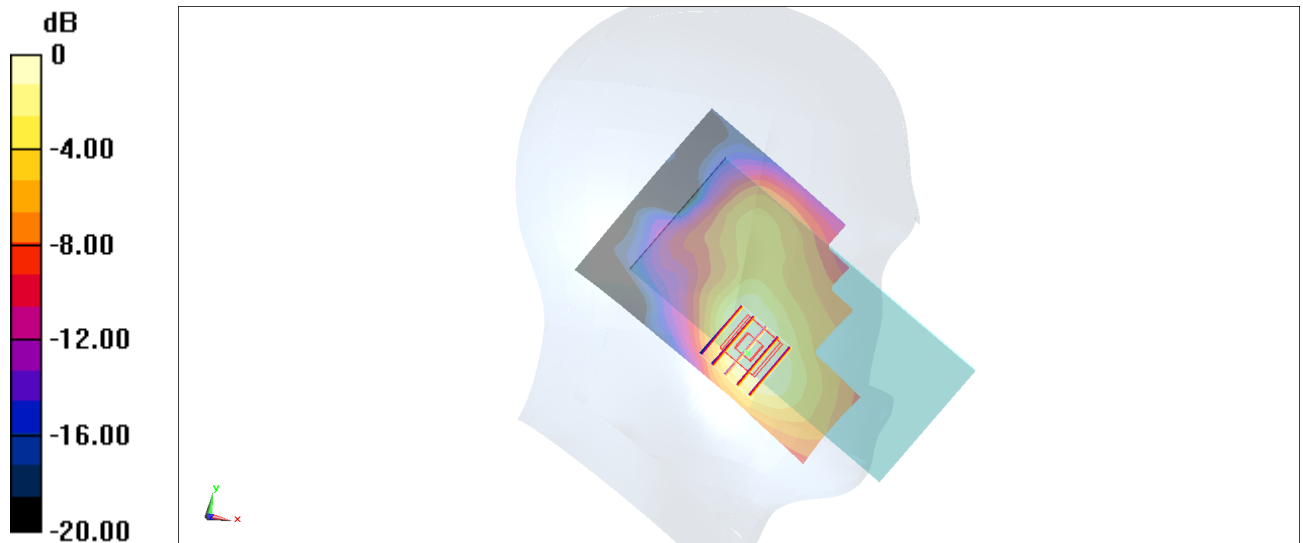

0 dB = 0.273 W/kg = -5.64 dBW/kg

#04_WCDMA IV_RMC 12.2Kbps_Right Cheek_Ch1413

Communication System: WCDMA; Frequency: 1732.6 MHz; Duty Cycle: 1:1

Medium: HSL_1750_200408 Medium parameters used: $f = 1733$ MHz; $\sigma = 1.346$ S/m; $\epsilon_r = 40.745$; $\rho = 1000$ kg/m³

Ambient Temperature : 23.4 °C; Liquid Temperature : 22.4 °C

DASY5 Configuration:

- Probe: EX3DV4 - SN3728; ConvF(8.06, 8.06, 8.06) @ 1732.6 MHz; Calibrated: 2020/2/4
- Sensor-Surface: 1.4mm (Mechanical Surface Detection)
- Electronics: DAE3 Sn495; Calibrated: 2019/5/21
- Phantom: SAM LEFT; Type: QD000P40CD; Serial: TP:1718
- Measurement SW: DASY52, Version 52.10 (4); SEMCAD X Version 14.6.14 (7483)

Area Scan (71x131x1): Interpolated grid: dx=1.500 mm, dy=1.500 mm

Maximum value of SAR (interpolated) = 0.399 W/kg

Zoom Scan (5x5x7)/Cube 0: Measurement grid: dx=8mm, dy=8mm, dz=5mm

Reference Value = 8.926 V/m; Power Drift = -0.03 dB

Peak SAR (extrapolated) = 0.470 W/kg

SAR(1 g) = 0.288 W/kg; SAR(10 g) = 0.178 W/kg

Maximum value of SAR (measured) = 0.390 W/kg

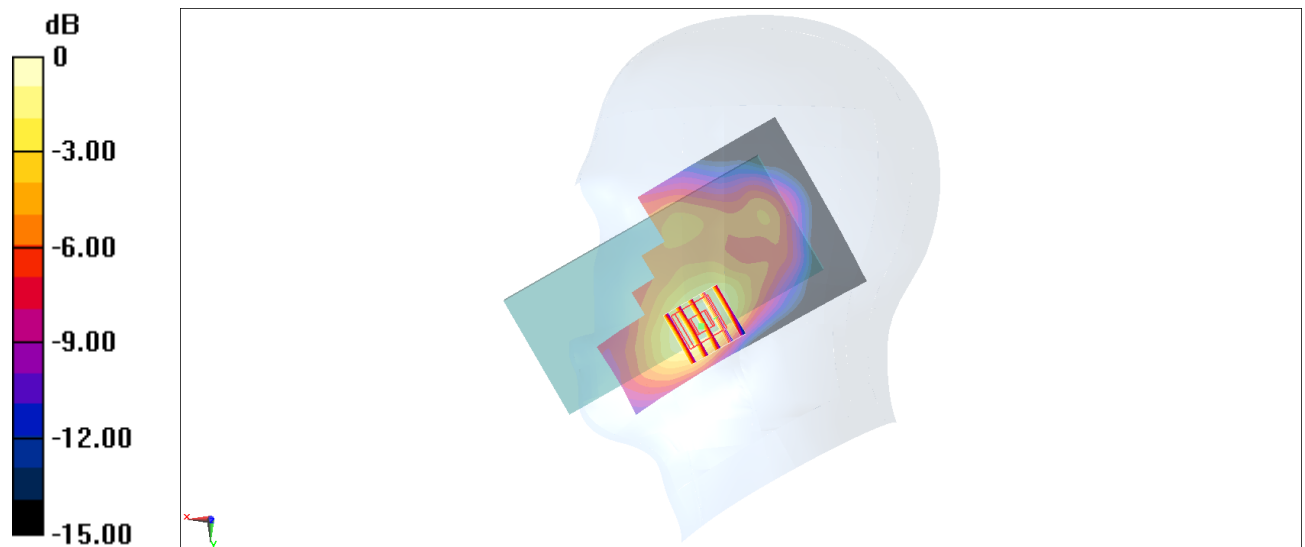

0 dB = 0.399 W/kg = -3.99 dBW/kg

#05_WCDMA V_RMC 12.2Kbps_Left Cheek_Ch4182

Communication System: WCDMA; Frequency: 836.4 MHz; Duty Cycle: 1:1

Medium: HSL_850_200407 Medium parameters used : $f = 836.4$ MHz; $\sigma = 0.892$ S/m; $\epsilon_r = 40.514$; $\rho = 1000$ kg/m³

Ambient Temperature : 23.4 °C; Liquid Temperature : 22.4 °C

DASY5 Configuration:

- Probe: EX3DV4 - SN3728; ConvF(9.51, 9.51, 9.51) @ 836.4 MHz; Calibrated: 2020/2/4
- Sensor-Surface: 1.4mm (Mechanical Surface Detection)
- Electronics: DAE3 Sn495; Calibrated: 2019/5/21
- Phantom: SAM LEFT; Type: QD000P40CD; Serial: TP:1718
- Measurement SW: DASY52, Version 52.10 (4); SEMCAD X Version 14.6.14 (7483)

Area Scan (71x131x1): Interpolated grid: dx=1.500 mm, dy=1.500 mm

Maximum value of SAR (interpolated) = 0.389 W/kg

Zoom Scan (5x5x7)/Cube 0: Measurement grid: dx=8mm, dy=8mm, dz=5mm

Reference Value = 11.86 V/m; Power Drift = 0.12 dB

Peak SAR (extrapolated) = 0.421 W/kg

SAR(1 g) = 0.289 W/kg; SAR(10 g) = 0.215 W/kg

Maximum value of SAR (measured) = 0.369 W/kg

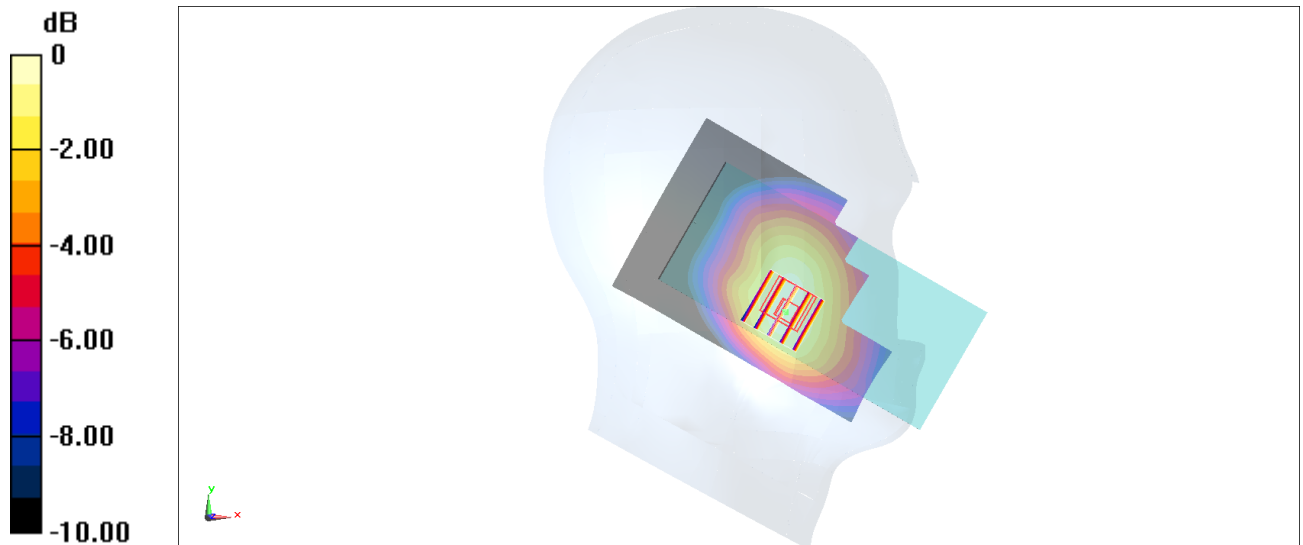

0 dB = 0.389 W/kg = -4.10 dBW/kg

#06_LTE Band 2_20M_QPSK_1_0_Right Cheek_Ch18900

Communication System: LTE; Frequency: 1880 MHz; Duty Cycle: 1:1

Medium: HSL_1900_200407 Medium parameters used: $f = 1880$ MHz; $\sigma = 1.435$ S/m; $\epsilon_r = 41.17$; $\rho = 1000$ kg/m³

Ambient Temperature : 23.4 °C ; Liquid Temperature : 22.4 °C

DASY5 Configuration:

- Probe: EX3DV4 - SN3728; ConvF(7.82, 7.82, 7.82) @ 1880 MHz; Calibrated: 2020/2/4
- Sensor-Surface: 1.4mm (Mechanical Surface Detection)
- Electronics: DAE3 Sn495; Calibrated: 2019/5/21
- Phantom: SAM LEFT; Type: QD000P40CD; Serial: TP:1718
- Measurement SW: DASY52, Version 52.10 (4); SEMCAD X Version 14.6.14 (7483)

Area Scan (71x131x1): Interpolated grid: dx=1.500 mm, dy=1.500 mm

Maximum value of SAR (interpolated) = 0.375 W/kg

Zoom Scan (5x5x7)/Cube 0: Measurement grid: dx=8mm, dy=8mm, dz=5mm

Reference Value = 11.77 V/m; Power Drift = -0.01 dB

Peak SAR (extrapolated) = 0.411 W/kg

SAR(1 g) = 0.261 W/kg; SAR(10 g) = 0.161 W/kg

Maximum value of SAR (measured) = 0.350 W/kg

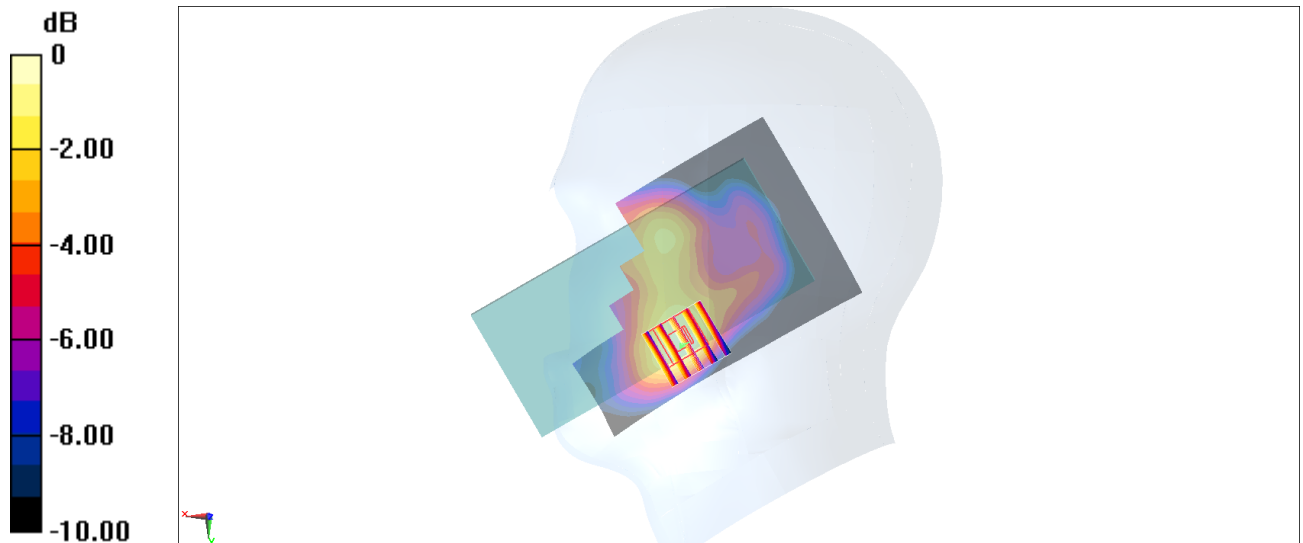

0 dB = 0.375 W/kg = -4.26 dBW/kg

#07_LTE Band 5_10M_QPSK_1_0_Right Cheek_Ch20525

Communication System: LTE; Frequency: 836.5 MHz; Duty Cycle: 1:1

Medium: HSL_850_200407 Medium parameters used : $f = 836.5$ MHz; $\sigma = 0.892$ S/m; $\epsilon_r = 40.513$; $\rho = 1000$ kg/m³

Ambient Temperature : 23.4 °C; Liquid Temperature : 22.4 °C

DASY5 Configuration:

- Probe: EX3DV4 - SN3728; ConvF(9.51, 9.51, 9.51) @ 836.5 MHz; Calibrated: 2020/2/4
- Sensor-Surface: 1.4mm (Mechanical Surface Detection)
- Electronics: DAE3 Sn495; Calibrated: 2019/5/21
- Phantom: SAM LEFT; Type: QD000P40CD; Serial: TP:1718
- Measurement SW: DASY52, Version 52.10 (4); SEMCAD X Version 14.6.14 (7483)

Area Scan (71x131x1): Interpolated grid: dx=1.500 mm, dy=1.500 mm

Maximum value of SAR (interpolated) = 0.396 W/kg

Zoom Scan (5x5x7)/Cube 0: Measurement grid: dx=8mm, dy=8mm, dz=5mm

Reference Value = 21.32 V/m; Power Drift = 0.12 dB

Peak SAR (extrapolated) = 0.465 W/kg

SAR(1 g) = 0.308 W/kg; SAR(10 g) = 0.231 W/kg

Maximum value of SAR (measured) = 0.407 W/kg

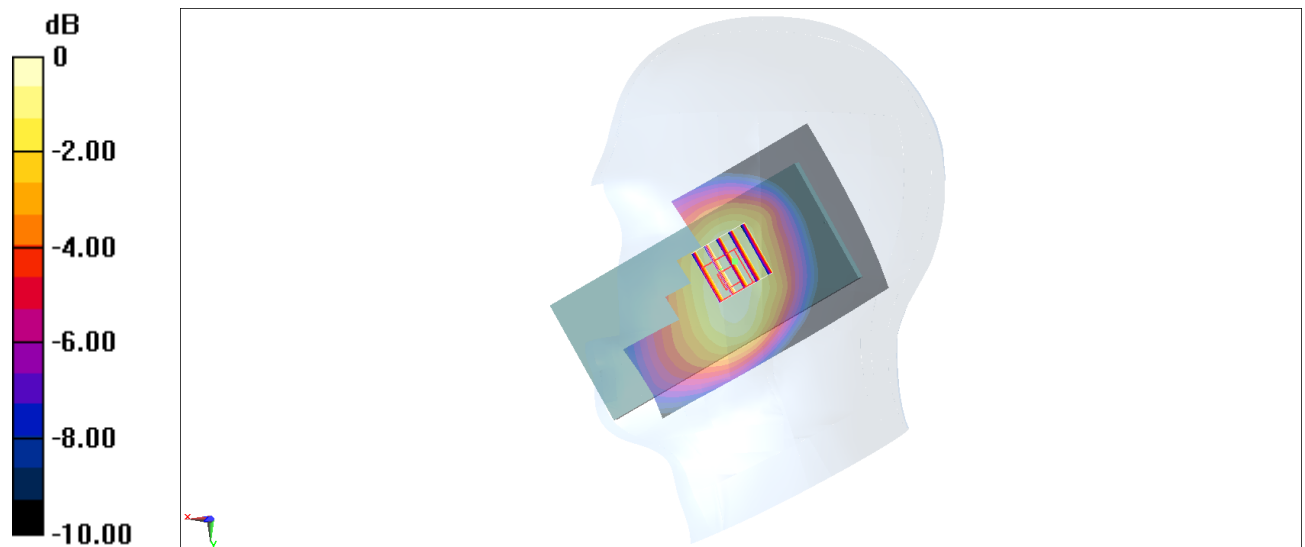

0 dB = 0.396 W/kg = -4.02 dBW/kg

#08_LTE Band 7_20M_QPSK_1_0_Right Cheek_Ch21100

Communication System: LTE; Frequency: 2535 MHz; Duty Cycle: 1:1

Medium: HSL_2600_200413 Medium parameters used : $f = 2535$ MHz; $\sigma = 1.841$ S/m; $\epsilon_r = 37.698$; $\rho = 1000$ kg/m³

Ambient Temperature : 23.6 °C ; Liquid Temperature : 22.6 °C

DASY5 Configuration:

- Probe: EX3DV4 - SN3728; ConvF(7.08, 7.08, 7.08) @ 2535 MHz; Calibrated: 2020/2/4
- Sensor-Surface: 1.4mm (Mechanical Surface Detection)
- Electronics: DAE3 Sn495; Calibrated: 2019/5/21
- Phantom: SAM_Left; Type: QD000P40CD; Serial: TP:1801
- Measurement SW: DASY52, Version 52.10 (4); SEMCAD X Version 14.6.14 (7483)

Area Scan (91x151x1): Interpolated grid: dx=1.200 mm, dy=1.200 mm

Maximum value of SAR (interpolated) = 0.232 W/kg

Zoom Scan (7x7x7)/Cube 0: Measurement grid: dx=5mm, dy=5mm, dz=5mm

Reference Value = 11.03 V/m; Power Drift = -0.12 dB

Peak SAR (extrapolated) = 0.261 W/kg

SAR(1 g) = 0.159 W/kg; SAR(10 g) = 0.095 W/kg

Maximum value of SAR (measured) = 0.226 W/kg

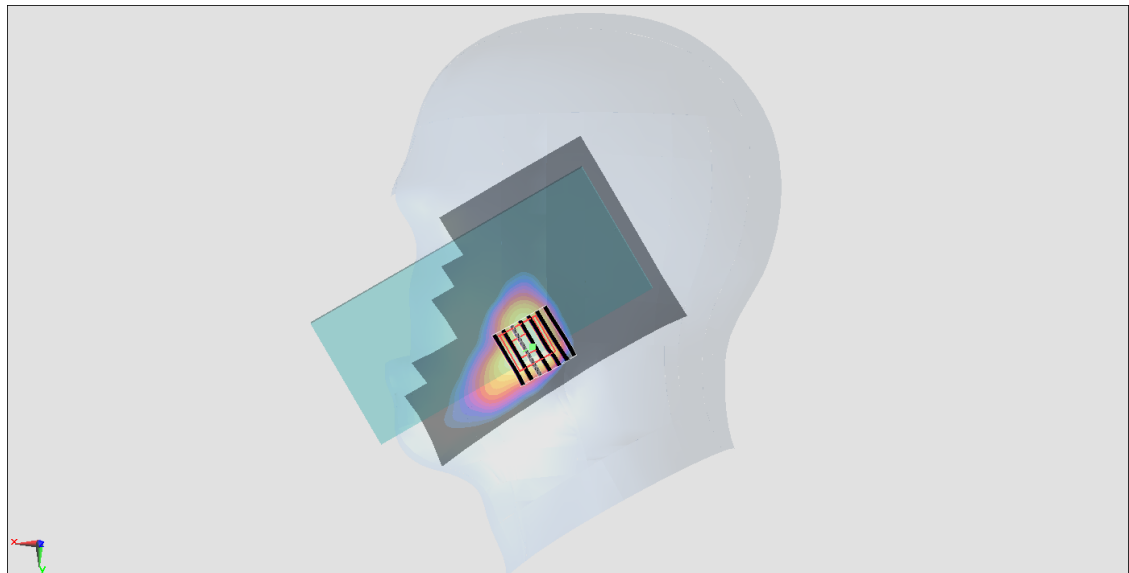
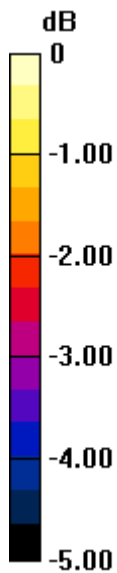

0 dB = 0.226 W/kg = -6.46 dBW/kg

#09_LTE Band 66_20M_QPSK_1_0_Right Cheek_Ch132322

Communication System: LTE; Frequency: 1745 MHz; Duty Cycle: 1:1

Medium: HSL_1750_200408 Medium parameters used : $f = 1745$ MHz; $\sigma = 1.358$ S/m; $\epsilon_r = 40.686$; $\rho = 1000$ kg/m³

Ambient Temperature : 23.4 °C; Liquid Temperature : 22.4 °C

DASY5 Configuration:

- Probe: EX3DV4 - SN3728; ConvF(8.06, 8.06, 8.06) @ 1745 MHz; Calibrated: 2020/2/4
- Sensor-Surface: 1.4mm (Mechanical Surface Detection)
- Electronics: DAE3 Sn495; Calibrated: 2019/5/21
- Phantom: SAM LEFT; Type: QD000P40CD; Serial: TP:1718
- Measurement SW: DASY52, Version 52.10 (4); SEMCAD X Version 14.6.14 (7483)

Area Scan (71x131x1): Interpolated grid: dx=1.500 mm, dy=1.500 mm

Maximum value of SAR (interpolated) = 0.308 W/kg

Zoom Scan (5x5x7)/Cube 0: Measurement grid: dx=8mm, dy=8mm, dz=5mm

Reference Value = 11.90 V/m; Power Drift = 0.13 dB

Peak SAR (extrapolated) = 0.348 W/kg

SAR(1 g) = 0.222 W/kg; SAR(10 g) = 0.139 W/kg

Maximum value of SAR (measured) = 0.296 W/kg

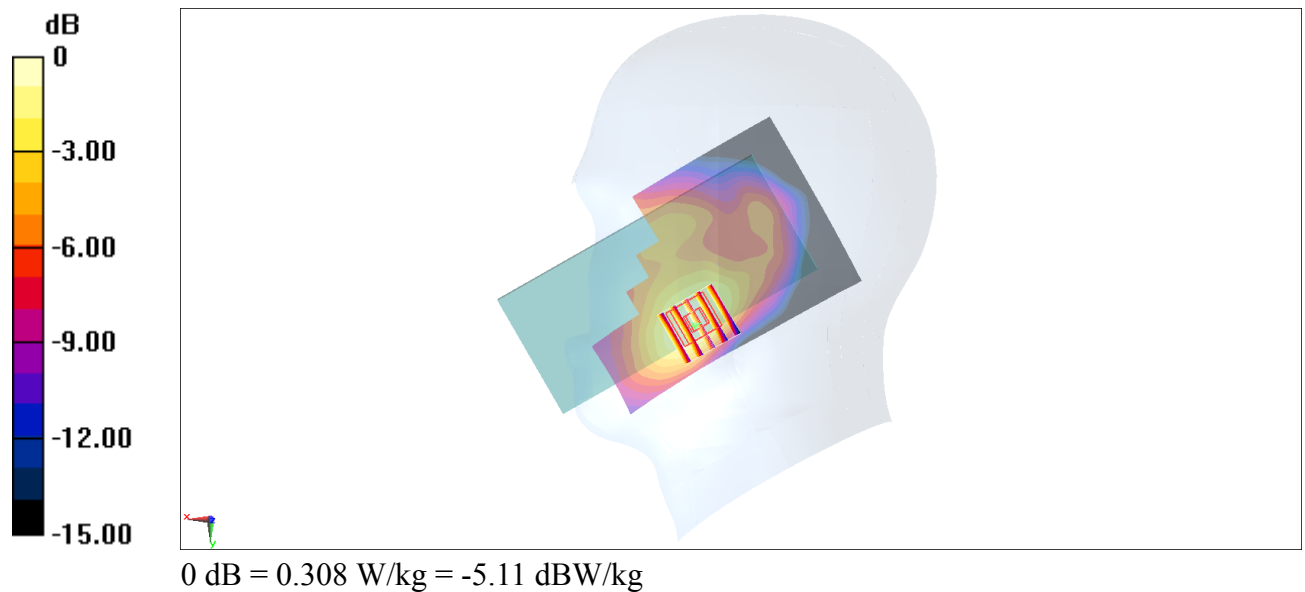

#10_WLAN2.4GHz_802.11b 1Mbps_Left Cheek_Ch11

Communication System: 802.11b; Frequency: 2462 MHz; Duty Cycle: 1:1

Medium: HSL_2450_200407 Medium parameters used: $f = 2462$ MHz; $\sigma = 1.802$ S/m; $\epsilon_r = 39.286$; $\rho = 1000$ kg/m³

Ambient Temperature : 23.4 °C; Liquid Temperature : 22.4 °C

DASY5 Configuration:

- Probe: EX3DV4 - SN3728; ConvF(7.33, 7.33, 7.33) @ 2462 MHz; Calibrated: 2020/2/4
- Sensor-Surface: 1.4mm (Mechanical Surface Detection)
- Electronics: DAE3 Sn495; Calibrated: 2019/5/21
- Phantom: SAM LEFT; Type: QD000P40CD; Serial: TP:1718
- Measurement SW: DASY52, Version 52.10 (4); SEMCAD X Version 14.6.14 (7483)

Area Scan (71x71x1): Interpolated grid: dx=1.200 mm, dy=1.200 mm

Maximum value of SAR (interpolated) = 0.582 W/kg

Zoom Scan (7x7x7)/Cube 0: Measurement grid: dx=5mm, dy=5mm, dz=5mm

Reference Value = 17.52 V/m; Power Drift = 0.09 dB

Peak SAR (extrapolated) = 0.709 W/kg

SAR(1 g) = 0.367 W/kg; SAR(10 g) = 0.184 W/kg

Maximum value of SAR (measured) = 0.576 W/kg



0 dB = 0.582 W/kg = -2.35 dBW/kg

#11_WLAN5GHz_802.11a 6Mbps_Left Tilted_Ch60

Communication System: 802.11a; Frequency: 5300 MHz; Duty Cycle: 1:1.017

Medium: HSL_5G_200417 Medium parameters used: $f = 5300$ MHz; $\sigma = 4.636$ S/m; $\epsilon_r = 36.88$; $\rho = 1000$ kg/m³

Ambient Temperature : 23.5 °C ; Liquid Temperature : 22.5 °C

DASY5 Configuration:

- Probe: EX3DV4 - SN7306; ConvF(5.34, 5.34, 5.34) @ 5300 MHz; Calibrated: 2019/7/22
- Sensor-Surface: 1.4mm (Mechanical Surface Detection)
- Electronics: DAE3 Sn577; Calibrated: 2019/9/17
- Phantom: SAM_Left; Type: QD000P40CD; Serial: TP:1801
- Measurement SW: DASY52, Version 52.10 (4); SEMCAD X Version 14.6.14 (7483)

Area Scan (91x91x1): Interpolated grid: dx=1.000 mm, dy=1.000 mm

Maximum value of SAR (interpolated) = 1.16 W/kg

Zoom Scan (7x7x7)/Cube 0: Measurement grid: dx=4mm, dy=4mm, dz=1.4mm

Reference Value = 13.50 V/m; Power Drift = -0.11 dB

Peak SAR (extrapolated) = 2.05 W/kg

SAR(1 g) = 0.526 W/kg; SAR(10 g) = 0.192 W/kg

Maximum value of SAR (measured) = 1.22 W/kg

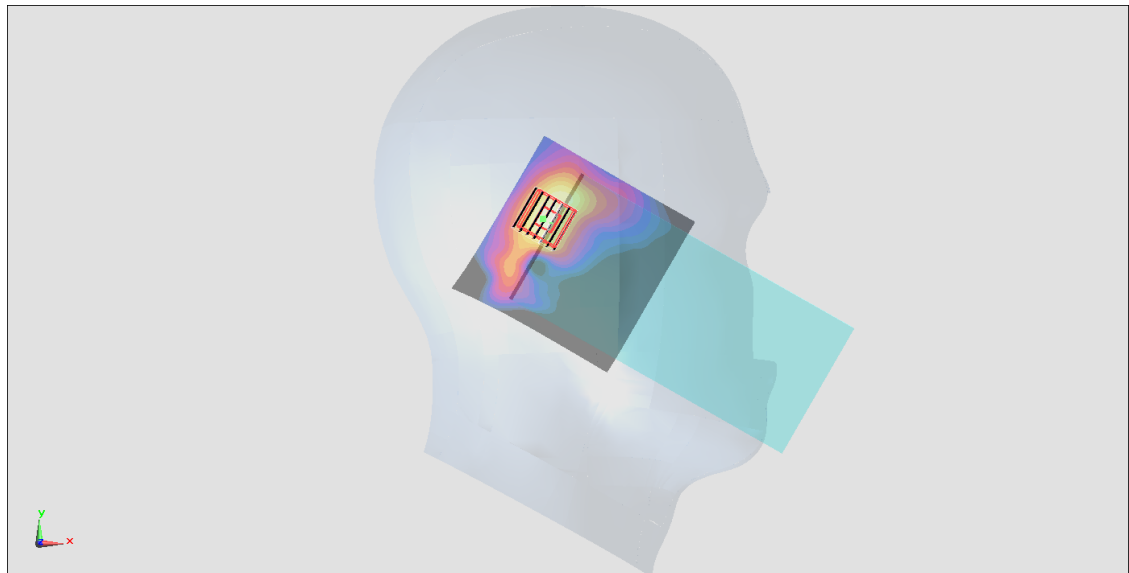
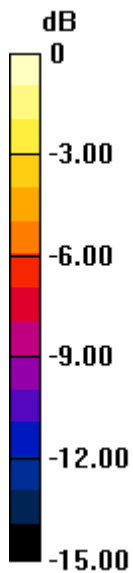

0 dB = 1.22 W/kg = 0.86 dBW/kg

#12_WLAN5GHz_802.11a_6Mbps_Left Tilted_Ch132

Communication System: 802.11a; Frequency: 5660 MHz; Duty Cycle: 1:1.017

Medium: HSL_5G_200417 Medium parameters used: $f = 5660$ MHz; $\sigma = 5.149$ S/m; $\epsilon_r = 36.184$; $\rho = 1000$ kg/m³

Ambient Temperature : 23.5 °C ; Liquid Temperature : 22.5 °C

DASY5 Configuration:

- Probe: EX3DV4 - SN7306; ConvF(4.79, 4.79, 4.79) @ 5660 MHz; Calibrated: 2019/7/22
- Sensor-Surface: 1.4mm (Mechanical Surface Detection)
- Electronics: DAE3 Sn577; Calibrated: 2019/9/17
- Phantom: SAM_Left; Type: QD000P40CD; Serial: TP:1801
- Measurement SW: DASY52, Version 52.10 (4); SEMCAD X Version 14.6.14 (7483)

Area Scan (91x91x1): Interpolated grid: dx=1.000 mm, dy=1.000 mm

Maximum value of SAR (interpolated) = 1.42 W/kg

Zoom Scan (7x7x7)/Cube 0: Measurement grid: dx=4mm, dy=4mm, dz=1.4mm

Reference Value = 14.20 V/m; Power Drift = -0.10 dB

Peak SAR (extrapolated) = 2.14 W/kg

SAR(1 g) = 0.528 W/kg; SAR(10 g) = 0.195 W/kg

Maximum value of SAR (measured) = 1.25 W/kg

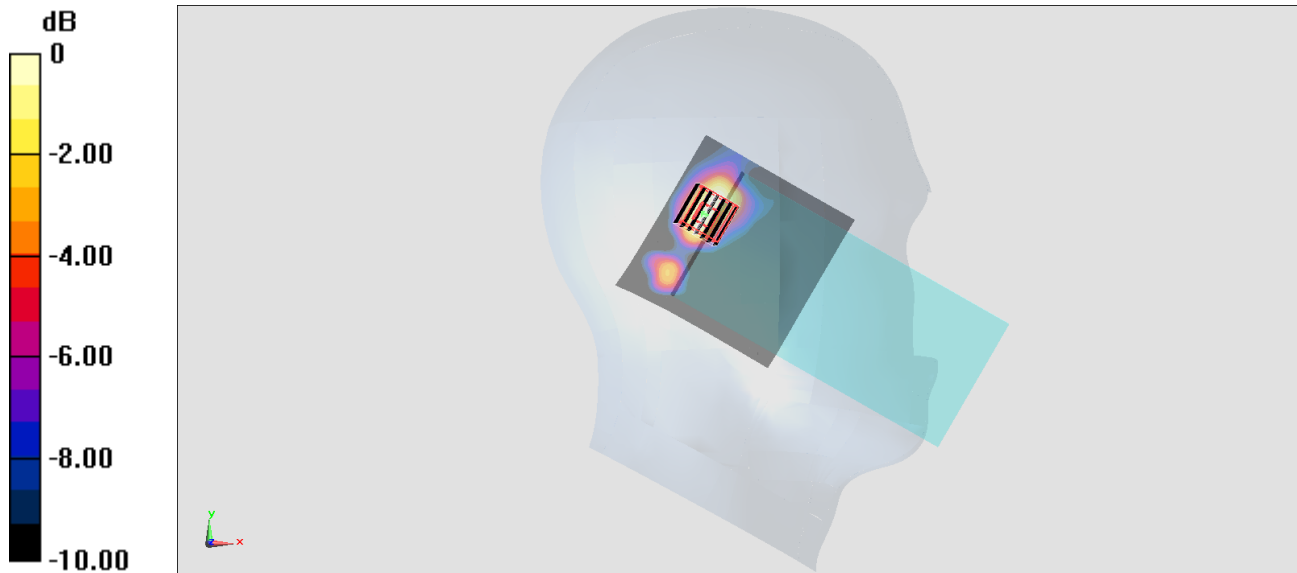

0 dB = 1.25 W/kg = 0.97 dBW/kg

#13_WLAN5GHz_802.11a 6Mbps_Left Tilted_Ch165

Communication System: 802.11a; Frequency: 5825 MHz; Duty Cycle: 1:1.017

Medium: HSL_5G_200417 Medium parameters used : $f = 5825$ MHz; $\sigma = 5.081$ S/m; $\epsilon_r = 36.074$; $\rho = 1000$ kg/m³

Ambient Temperature : 23.5 °C ; Liquid Temperature : 22.5 °C

DASY5 Configuration:

- Probe: EX3DV4 - SN7306; ConvF(4.93, 4.93, 4.93) @ 5825 MHz; Calibrated: 2019/7/22
- Sensor-Surface: 1.4mm (Mechanical Surface Detection)
- Electronics: DAE3 Sn577; Calibrated: 2019/9/17
- Phantom: SAM_Left; Type: QD000P40CD; Serial: TP:1801
- Measurement SW: DASY52, Version 52.10 (4); SEMCAD X Version 14.6.14 (7483)

Area Scan (91x91x1): Interpolated grid: dx=1.000 mm, dy=1.000 mm

Maximum value of SAR (interpolated) = 1.08 W/kg

Zoom Scan (7x7x7)/Cube 0: Measurement grid: dx=4mm, dy=4mm, dz=1.4mm

Reference Value = 12.00 V/m; Power Drift = -0.1 dB

Peak SAR (extrapolated) = 1.68 W/kg

SAR(1 g) = 0.414 W/kg; SAR(10 g) = 0.142 W/kg

Maximum value of SAR (measured) = 0.996 W/kg

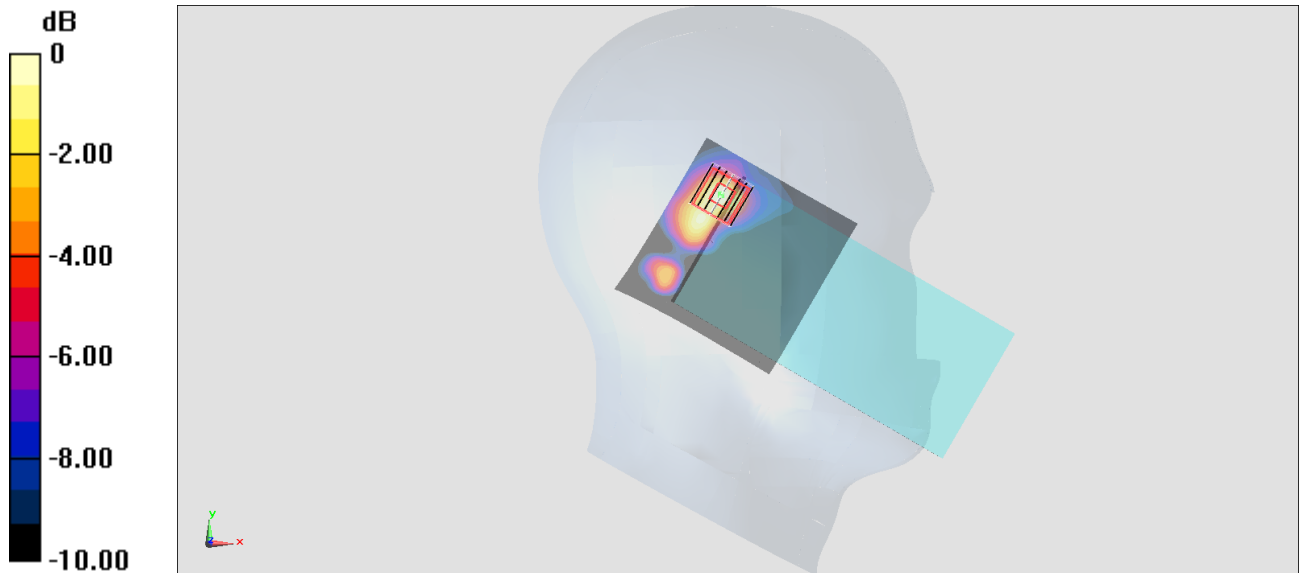

0 dB = 0.996 W/kg = -0.02 dBW/kg

#14_Bluetooth_1Mbps_Left Cheek_Ch78

Communication System: Bluetooth; Frequency: 2480 MHz; Duty Cycle: 1:1.302

Medium: HSL2450_200416 Medium parameters used : $f = 2480$ MHz; $\sigma = 1.809$ S/m; $\epsilon_r = 39.01$; $\rho = 1000$ kg/m³

Ambient Temperature : 23.6 °C ; Liquid Temperature : 22.6 °C

DASY5 Configuration:

- Probe: ES3DV3 - SN3270; ConvF(4.57, 4.57, 4.57) @ 2480 MHz; Calibrated: 2019/9/25
- Sensor-Surface: 3mm (Mechanical Surface Detection)
- Electronics: DAE4 Sn778; Calibrated: 2019/5/21
- Phantom: Twin-SAM V5.0 (30deg probe tilt); Type: QD 000 P40 CD; Serial: 1885
- Measurement SW: DASY52, Version 52.10 (4); SEMCAD X Version 14.6.14 (7483)

Area Scan (91x61x1): Interpolated grid: dx=1.200 mm, dy=1.200 mm

Maximum value of SAR (interpolated) = 0.0794 W/kg

Zoom Scan (7x7x7)/Cube 0: Measurement grid: dx=5mm, dy=5mm, dz=5mm

Reference Value = 5.615 V/m; Power Drift = 0.19 dB

Peak SAR (extrapolated) = 0.126 W/kg

SAR(1 g) = 0.056 W/kg; SAR(10 g) = 0.026 W/kg

Maximum value of SAR (measured) = 0.0752 W/kg

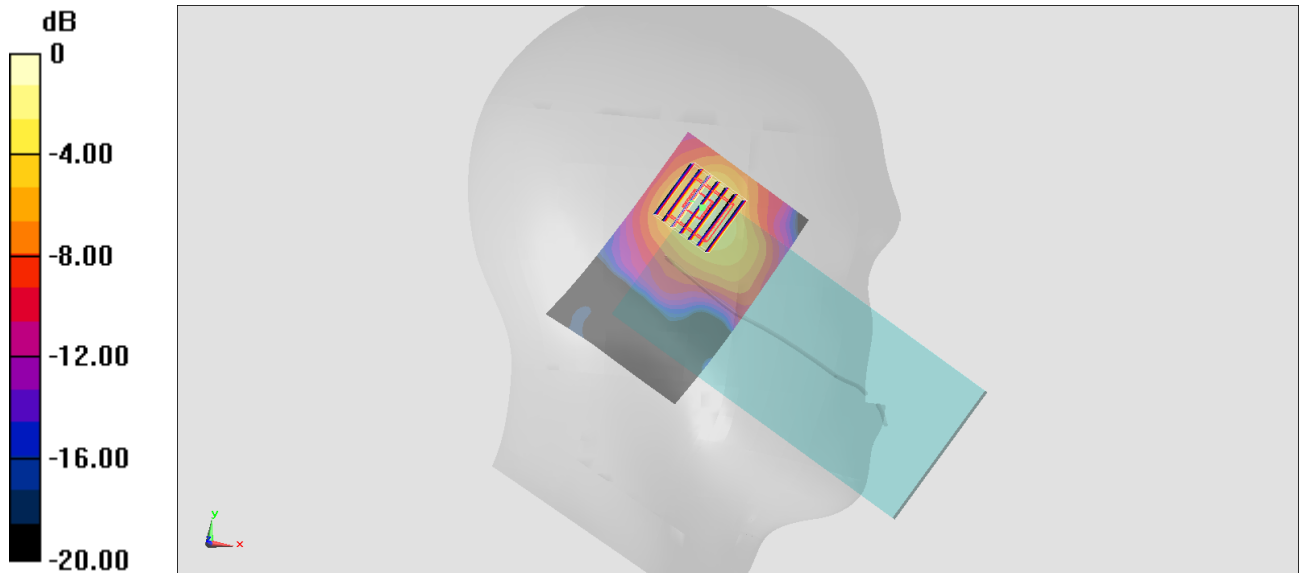

0 dB = 0.0752 W/kg = -11.24 dBW/kg

#15_GSM850_GPRS (3 Tx slots)_Back_5mm_Ch251

Communication System: GSM850; Frequency: 848.8 MHz; Duty Cycle: 1:2.77

Medium: HSL_850_200412 Medium parameters used: $f = 849$ MHz; $\sigma = 0.918$ S/m; $\epsilon_r = 41.048$; $\rho = 1000$ kg/m³

Ambient Temperature : 23.6 °C ; Liquid Temperature : 22.6 °C

DASY5 Configuration:

- Probe: EX3DV4 - SN3728; ConvF(9.51, 9.51, 9.51) @ 848.8 MHz; Calibrated: 2020/2/4
- Sensor-Surface: 1.4mm (Mechanical Surface Detection)
- Electronics: DAE3 Sn495; Calibrated: 2019/5/21
- Phantom: SAM_Left; Type: QD000P40CD; Serial: TP:1801
- Measurement SW: DASY52, Version 52.10 (4); SEMCAD X Version 14.6.14 (7483)

Area Scan (71x61x1): Interpolated grid: dx=1.500 mm, dy=1.500 mm

Maximum value of SAR (interpolated) = 1.39 W/kg

Zoom Scan (5x5x7)/Cube 0: Measurement grid: dx=8mm, dy=8mm, dz=5mm

Reference Value = 35.14 V/m; Power Drift = -0.04 dB

Peak SAR (extrapolated) = 1.85 W/kg

SAR(1 g) = 0.944 W/kg; SAR(10 g) = 0.536 W/kg

Maximum value of SAR (measured) = 1.40 W/kg

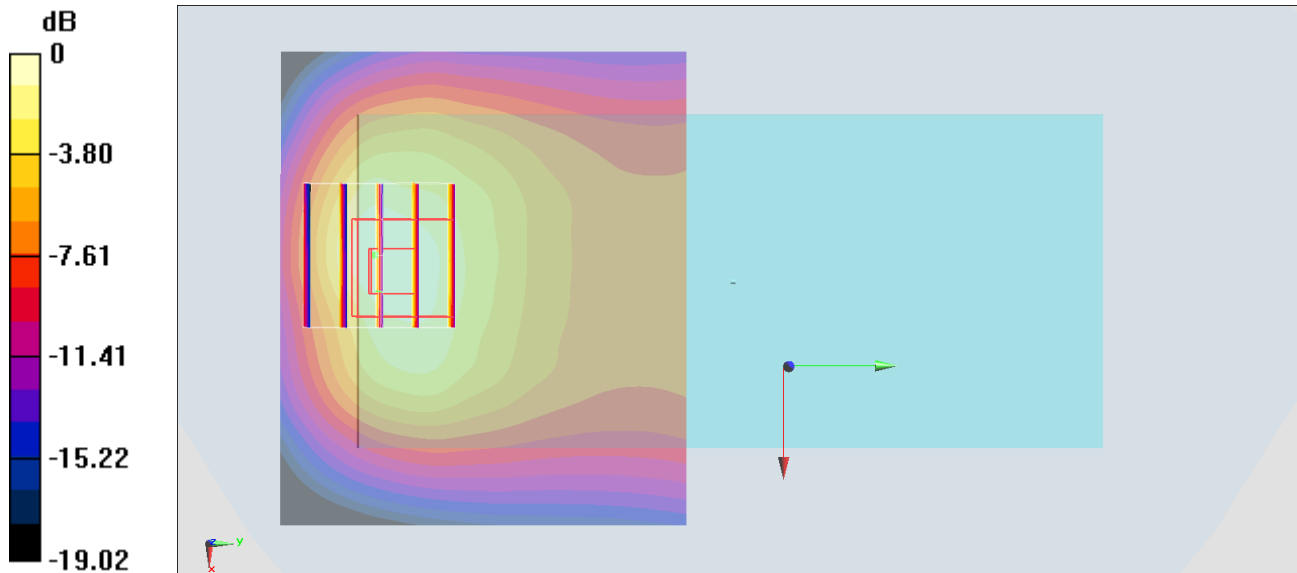

#16_GSM1900_GPRS (3 Tx slots)_Back_5mm_Ch810

Communication System: PCS; Frequency: 1909.8 MHz; Duty Cycle: 1:2.77

Medium: HSL_1900_200411 Medium parameters used: $f = 1910$ MHz; $\sigma = 1.383$ S/m; $\epsilon_r = 40.032$; $\rho = 1000$ kg/m³

Ambient Temperature : 23.6 °C ; Liquid Temperature : 22.6 °C

DASY5 Configuration:

- Probe: EX3DV4 - SN3728; ConvF(7.82, 7.82, 7.82) @ 1909.8 MHz; Calibrated: 2020/2/4
- Sensor-Surface: 1.4mm (Mechanical Surface Detection)
- Electronics: DAE3 Sn495; Calibrated: 2019/5/21
- Phantom: SAM_Left; Type: QD000P40CD; Serial: TP:1801
- Measurement SW: DASY52, Version 52.10 (4); SEMCAD X Version 14.6.14 (7483)

Area Scan (61x51x1): Interpolated grid: dx=1.500 mm, dy=1.500 mm

Maximum value of SAR (interpolated) = 1.79 W/kg

Zoom Scan (5x5x7)/Cube 0: Measurement grid: dx=8mm, dy=8mm, dz=5mm

Reference Value = 26.71 V/m; Power Drift = -0.12 dB

Peak SAR (extrapolated) = 13.3 W/kg

SAR(1 g) = 1.1 W/kg; SAR(10 g) = 0.600 W/kg

Maximum value of SAR (measured) = 4.93 W/kg

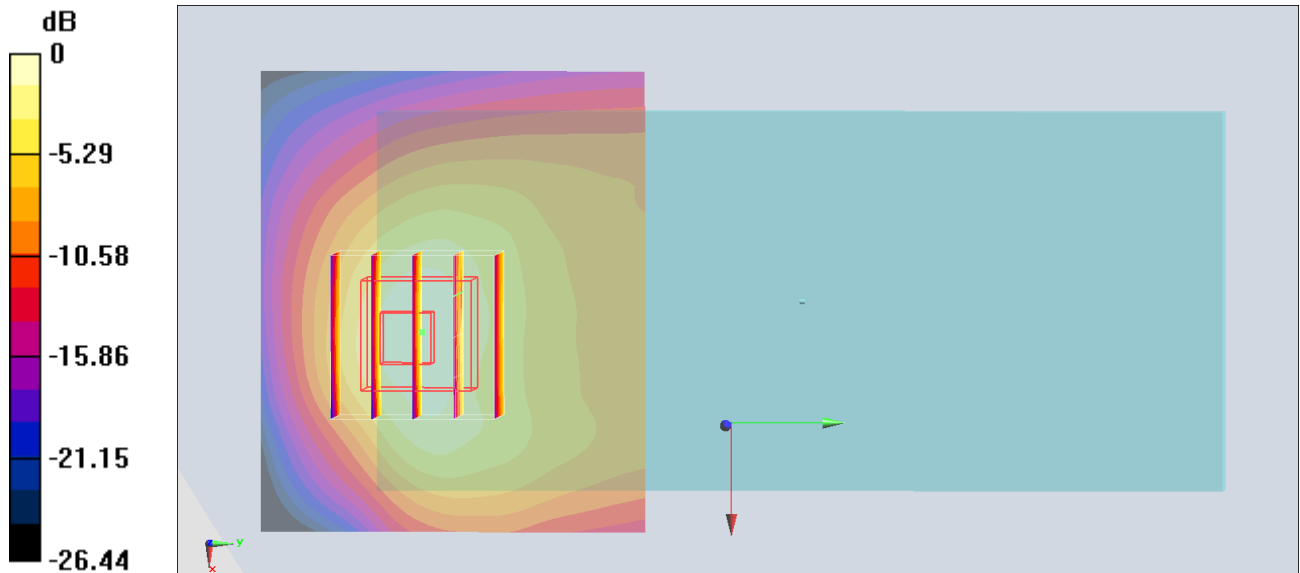

0 dB = 1.79 W/kg = 2.53 dBW/kg

#17_WCDMA II_RMC 12.2Kbps_Back_5mm_Ch9538

Communication System: WCDMA; Frequency: 1907.6 MHz; Duty Cycle: 1:1

Medium: HSL_1900_200411 Medium parameters used: $f = 1908$ MHz; $\sigma = 1.381$ S/m; $\epsilon_r = 40.039$; $\rho = 1000$ kg/m³

Ambient Temperature : 23.6 °C ; Liquid Temperature : 22.6 °C

DASY5 Configuration:

- Probe: EX3DV4 - SN3728; ConvF(7.82, 7.82, 7.82) @ 1907.6 MHz; Calibrated: 2020/2/4
- Sensor-Surface: 1.4mm (Mechanical Surface Detection)
- Electronics: DAE3 Sn495; Calibrated: 2019/5/21
- Phantom: SAM_Left; Type: QD000P40CD; Serial: TP:1801
- Measurement SW: DASY52, Version 52.10 (4); SEMCAD X Version 14.6.14 (7483)

Area Scan (61x51x1): Interpolated grid: dx=1.500 mm, dy=1.500 mm

Maximum value of SAR (interpolated) = 1.79 W/kg

Zoom Scan (5x5x7)/Cube 0: Measurement grid: dx=8mm, dy=8mm, dz=5mm

Reference Value = 27.00 V/m; Power Drift = -0.13 dB

Peak SAR (extrapolated) = 2.15 W/kg

SAR(1 g) = 1.17 W/kg; SAR(10 g) = 0.618 W/kg

Maximum value of SAR (measured) = 1.80 W/kg

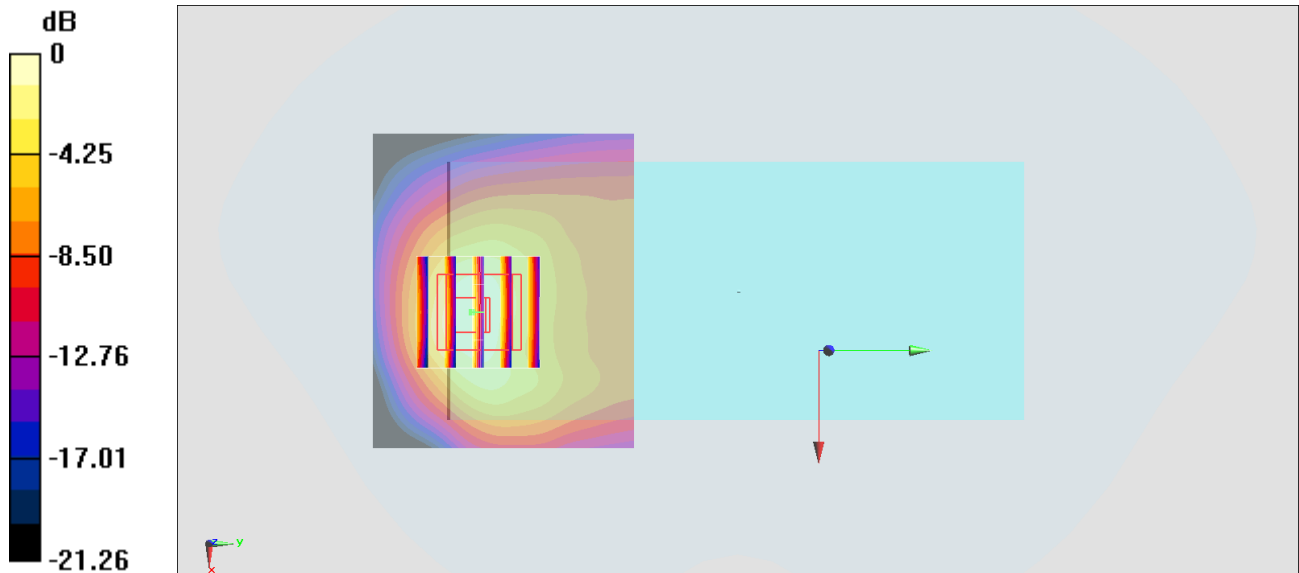

0 dB = 1.80 W/kg = 2.55 dBW/kg

#18_WCDMA IV_RMC 12.2Kbps_Bottom Side_5mm_Ch1513

Communication System:WCDMA; Frequency: 1752.6 MHz;Duty Cycle: 1:1

Medium: HSL_1750_200413 Medium parameters used: $f = 1753$ MHz; $\sigma = 1.372$ S/m; $\epsilon_r = 40.616$; $\rho = 1000$ kg/m³

Ambient Temperature : 23.6 °C ; Liquid Temperature : 22.6 °C

DASY5 Configuration:

- Probe: EX3DV4 - SN3728;ConvF(8.06, 8.06, 8.06) @ 1752.6 MHz;Calibrated: 2020/2/4
- Sensor-Surface: 1.4mm (Mechanical Surface Detection)
- Electronics: DAE3 Sn495; Calibrated: 2019/5/21
- Phantom: SAM_Left; Type: QD000P40CD; Serial: TP:1801
- Measurement SW: DASY52, Version 52.10 (4);SEMCAD X Version 14.6.14 (7483)

Area Scan (31x61x1): Interpolated grid: dx=1.500 mm, dy=1.500 mm

Maximum value of SAR (interpolated) = 1.91 W/kg

Zoom Scan (5x5x7)/Cube 0: Measurement grid: dx=8mm, dy=8mm, dz=5mm

Reference Value = 35.37 V/m; Power Drift = -0.06 dB

Peak SAR (extrapolated) = 2.30 W/kg

SAR(1 g) = 1.27 W/kg; SAR(10 g) = 0.655 W/kg

Maximum value of SAR (measured) = 1.97 W/kg

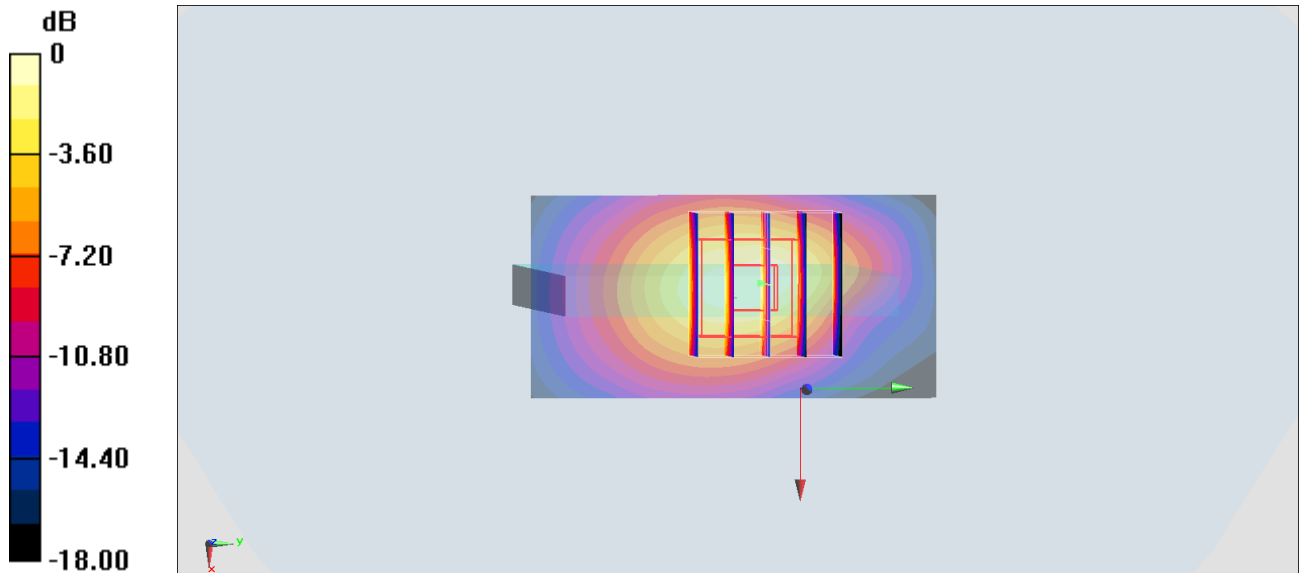

#19_WCDMA V_RMC 12.2Kbps_Back_5mm_Ch4132

Communication System: WCDMA; Frequency: 826.4 MHz; Duty Cycle: 1:1

Medium: HSL_850_200412 Medium parameters used : $f = 826.4$ MHz; $\sigma = 0.877$ S/m; $\epsilon_r = 41.354$; $\rho = 1000$ kg/m³

Ambient Temperature : 23.6 °C; Liquid Temperature : 22.6 °C

DASY5 Configuration:

- Probe: EX3DV4 - SN3728; ConvF(9.51, 9.51, 9.51) @ 826.4 MHz; Calibrated: 2020/2/4
- Sensor-Surface: 1.4mm (Mechanical Surface Detection)
- Electronics: DAE3 Sn495; Calibrated: 2019/5/21
- Phantom: SAM_Left; Type: QD000P40CD; Serial: TP:1801
- Measurement SW: DASY52, Version 52.10 (4); SEMCAD X Version 14.6.14 (7483)

Area Scan (61x51x1): Interpolated grid: dx=1.500 mm, dy=1.500 mm

Maximum value of SAR (interpolated) = 1.546 W/kg

Zoom Scan (5x5x7)/Cube 0: Measurement grid: dx=8mm, dy=8mm, dz=5mm

Reference Value = 31.69 V/m; Power Drift = -0.09 dB

Peak SAR (extrapolated) = 1.787 W/kg

SAR(1 g) = 0.966 W/kg; SAR(10 g) = 0.552 W/kg

Maximum value of SAR (measured) = 1.401 W/kg

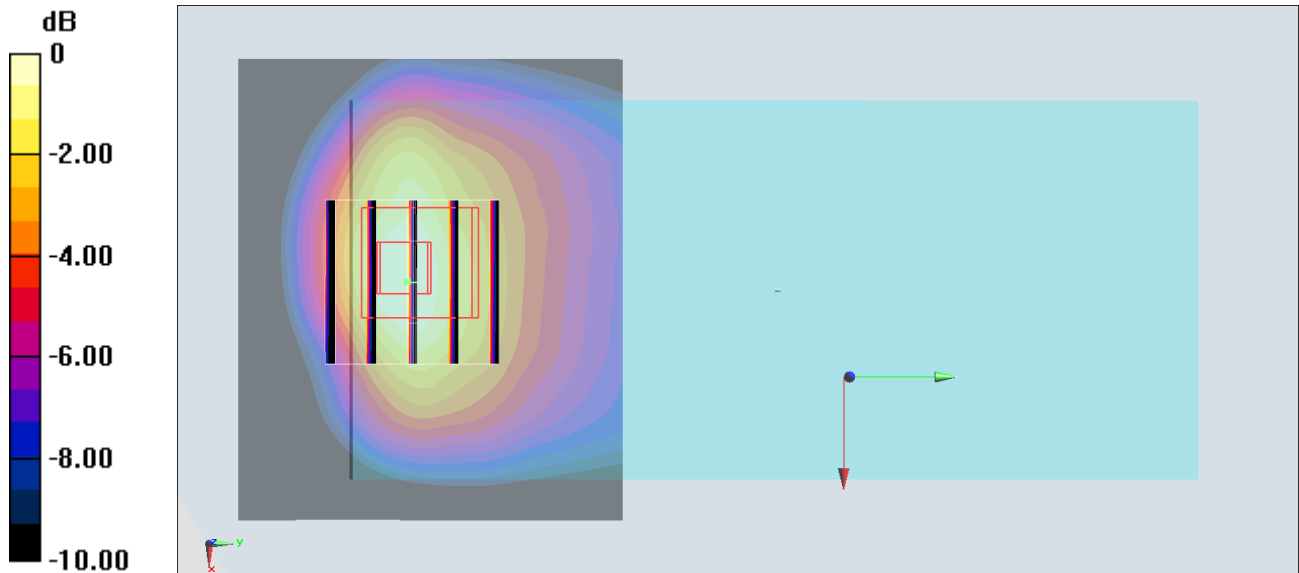

0 dB = 1.401 W/kg = 2.93 dBW/kg

#20_LTE Band 2_20M_QPSK_100_0_Bottom Side_5mm_Ch18900

Communication System: LTE; Frequency: 1880 MHz; Duty Cycle: 1:1

Medium: HSL_1900_200413 Medium parameters used: $f = 1880$ MHz; $\sigma = 1.364$ S/m; $\epsilon_r = 40.455$; $\rho = 1000$ kg/m³

Ambient Temperature : 23.6 °C ; Liquid Temperature : 22.6 °C

DASY5 Configuration:

- Probe: EX3DV4 - SN3728; ConvF(7.82, 7.82, 7.82) @ 1880 MHz; Calibrated: 2020/2/4
- Sensor-Surface: 1.4mm (Mechanical Surface Detection)
- Electronics: DAE3 Sn495; Calibrated: 2019/5/21
- Phantom: SAM_Left; Type: QD000P40CD; Serial: TP:1801
- Measurement SW: DASY52, Version 52.10 (4); SEMCAD X Version 14.6.14 (7483)

Area Scan (31x61x1): Interpolated grid: dx=1.500 mm, dy=1.500 mm

Maximum value of SAR (interpolated) = 1.66 W/kg

Zoom Scan (5x5x7)/Cube 0: Measurement grid: dx=8mm, dy=8mm, dz=5mm

Reference Value = 32.52 V/m; Power Drift = -0.07 dB

Peak SAR (extrapolated) = 1.90 W/kg

SAR(1 g) = 1.03 W/kg; SAR(10 g) = 0.523 W/kg

Maximum value of SAR (measured) = 1.59 W/kg

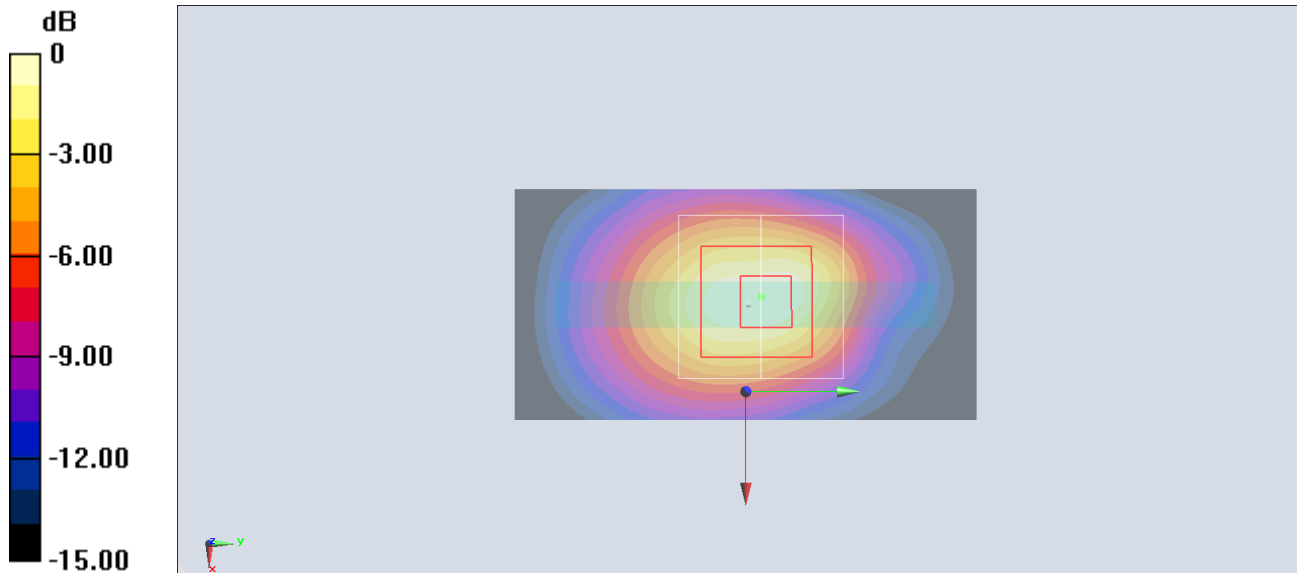

0 dB = 1.59 W/kg = 2.01 dBW/kg

#21_LTE Band 5_10M_QPSK_1_0_Back_5mm_Ch20525

Communication System: LTE; Frequency: 836.5 MHz; Duty Cycle: 1:1

Medium: HSL_850_200412 Medium parameters used : $f = 836.5$ MHz; $\sigma = 0.897$ S/m; $\epsilon_r = 41.151$; $\rho = 1000$ kg/m³

Ambient Temperature : 23.6 °C ; Liquid Temperature : 22.6 °C

DASY5 Configuration:

- Probe: EX3DV4 - SN3728; ConvF(9.51, 9.51, 9.51) @ 836.5 MHz; Calibrated: 2020/2/4
- Sensor-Surface: 1.4mm (Mechanical Surface Detection)
- Electronics: DAE3 Sn495; Calibrated: 2019/5/21
- Phantom: SAM_Left; Type: QD000P40CD; Serial: TP:1801
- Measurement SW: DASY52, Version 52.10 (4); SEMCAD X Version 14.6.14 (7483)

Area Scan (61x51x1): Interpolated grid: dx=1.500 mm, dy=1.500 mm

Maximum value of SAR (interpolated) = 1.31 W/kg

Zoom Scan (5x5x7)/Cube 0: Measurement grid: dx=8mm, dy=8mm, dz=5mm

Reference Value = 31.74 V/m; Power Drift = -0.09 dB

Peak SAR (extrapolated) = 1.52 W/kg

SAR(1 g) = 0.822 W/kg; SAR(10 g) = 0.469 W/kg

Maximum value of SAR (measured) = 1.19 W/kg

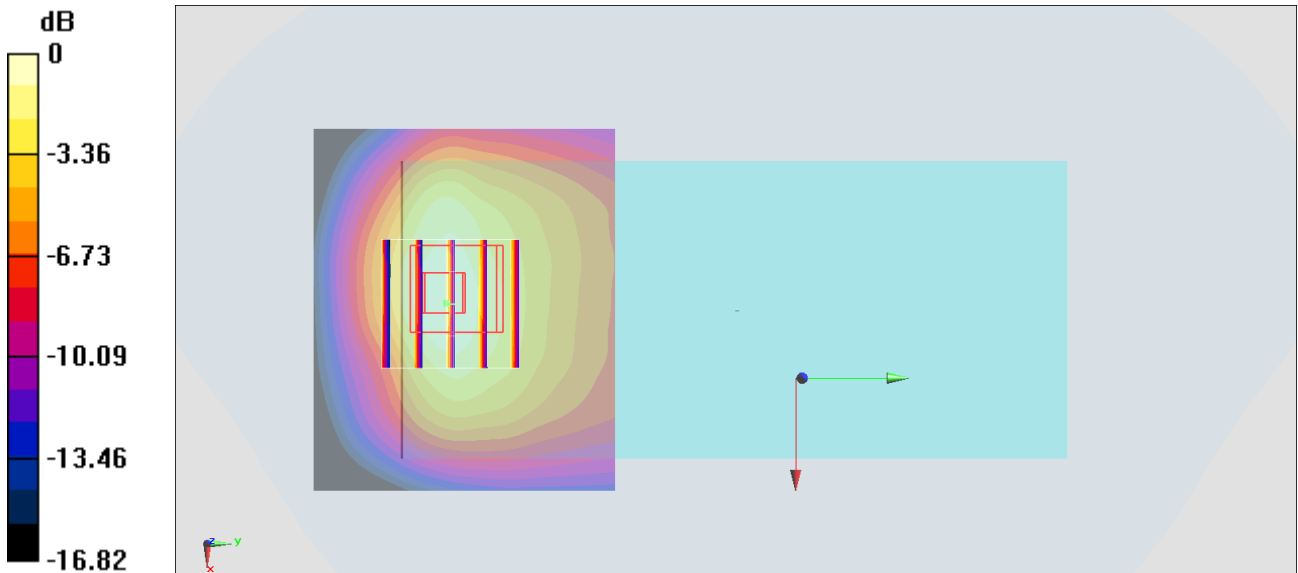

0 dB = 1.19 W/kg = 0.76 dBW/kg

#23_LTE Band 66_20M_QPSK_1_0_Bottom Side_5mm_Ch132572

Communication System: LTE; Frequency: 1770 MHz; Duty Cycle: 1:1

Medium: HSL_1750_200413 Medium parameters used: $f = 1770$ MHz; $\sigma = 1.388$ S/m; $\epsilon_r = 40.544$; $\rho = 1000$ kg/m³

Ambient Temperature : 23.6 °C ; Liquid Temperature : 22.6 °C

DASY5 Configuration:

- Probe: EX3DV4 - SN3728; ConvF(8.06, 8.06, 8.06) @ 1770 MHz; Calibrated: 2020/2/4
- Sensor-Surface: 1.4mm (Mechanical Surface Detection)
- Electronics: DAE3 Sn495; Calibrated: 2019/5/21
- Phantom: SAM_Left; Type: QD000P40CD; Serial: TP:1801
- Measurement SW: DASY52, Version 52.10 (4); SEMCAD X Version 14.6.14 (7483)

Area Scan (31x61x1): Interpolated grid: dx=1.500 mm, dy=1.500 mm

Maximum value of SAR (interpolated) = 1.75 W/kg

Zoom Scan (5x5x7)/Cube 0: Measurement grid: dx=8mm, dy=8mm, dz=5mm

Reference Value = 33.73 V/m; Power Drift = -0.14 dB

Peak SAR (extrapolated) = 2.13 W/kg

SAR(1 g) = 1.12 W/kg; SAR(10 g) = 0.580 W/kg

Maximum value of SAR (measured) = 1.70 W/kg

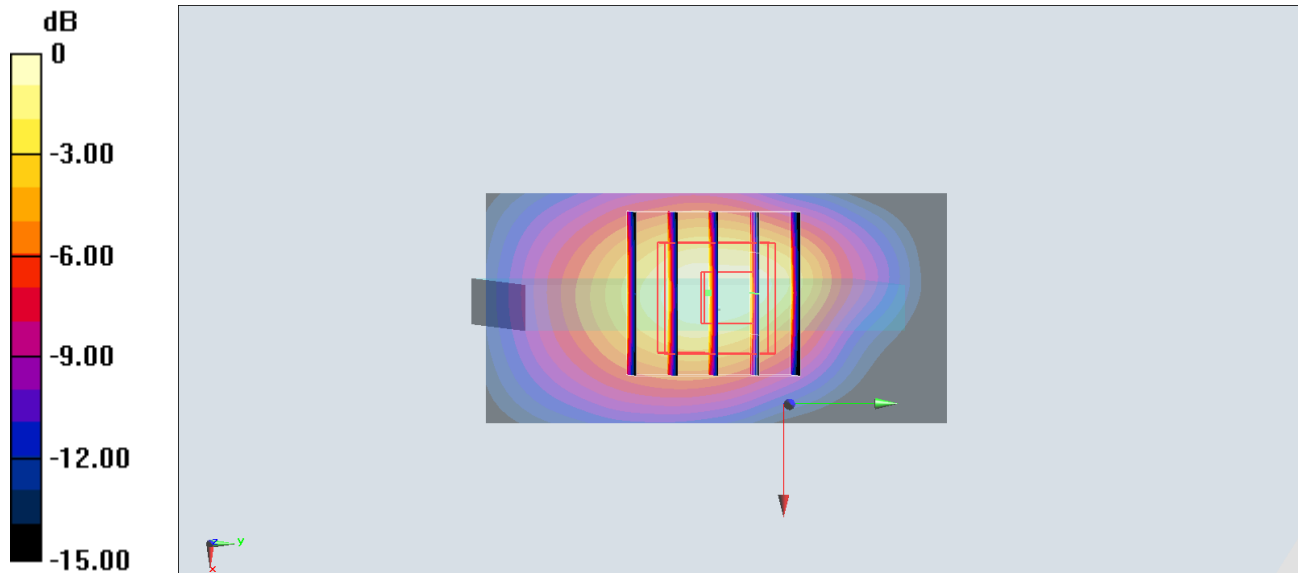

0 dB = 1.70 W/kg = 2.30 dBW/kg

#24_WLAN2.4GHz_802.11b 1Mbps_Back_5mm_Ch11

Communication System: 802.11b ; Frequency: 2462 MHz;Duty Cycle: 1:1

Medium: HSL2450_200416 Medium parameters used: $f = 2462$ MHz; $\sigma = 1.827$ S/m; $\epsilon_r = 39.061$; $\rho = 1000$ kg/m³

Ambient Temperature : 23.6 °C ; Liquid Temperature : 22.6 °C

DASY5 Configuration:

- Probe: EX3DV4 - SN7306;ConvF(7.48, 7.48, 7.48) @ 2462 MHz;Calibrated: 2019/7/22
- Sensor-Surface: 1.4mm (Mechanical Surface Detection)
- Electronics: DAE3 Sn577; Calibrated: 2019/9/17
- Phantom: SAM_Left; Type: QD000P40CD; Serial: TP:1801
- Measurement SW: DASY52, Version 52.10 (4);SEMCAD X Version 14.6.14 (7483)

Area Scan (91x61x1): Interpolated grid: dx=1.200 mm, dy=1.200 mm

Maximum value of SAR (interpolated) = 1.34 W/kg

Zoom Scan (7x7x7)/Cube 0: Measurement grid: dx=5mm, dy=5mm, dz=5mm

Reference Value = 16.73 V/m; Power Drift = 0.03 dB

Peak SAR (extrapolated) = 2.84 W/kg

SAR(1 g) = 1.07 W/kg; SAR(10 g) = 0.438 W/kg

Maximum value of SAR (measured) = 1.54 W/kg

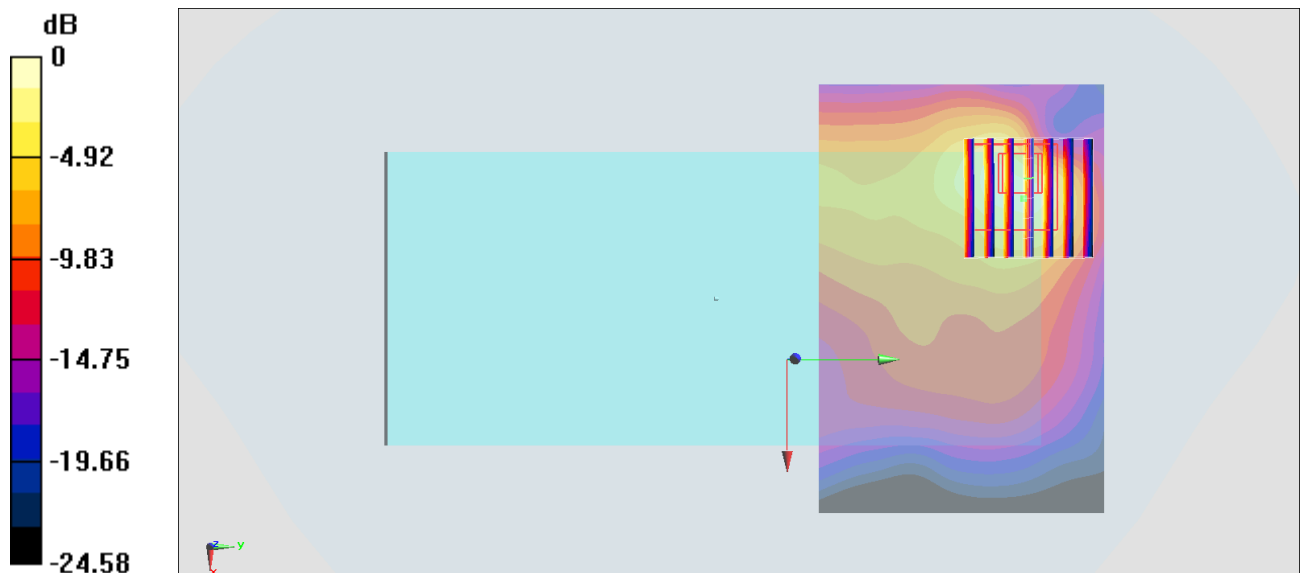

0 dB = 1.54 W/kg = 1.88 dBW/kg

#25_WLAN5GHz_802.11n-HT40 MCS0_Back_5mm_Ch46

Communication System: 802.11n ; Frequency: 5230 MHz;Duty Cycle: 1:1.037

Medium: HSL_5G_200417 Medium parameters used: $f = 5230$ MHz; $\sigma = 4.679$ S/m; $\epsilon_r = 36.605$; $\rho = 1000$ kg/m³

Ambient Temperature : 23.5 °C ; Liquid Temperature : 22.5 °C

DASY5 Configuration:

- Probe: EX3DV4 - SN7306;ConvF(5.34, 5.34, 5.34) @ 5230 MHz;Calibrated: 2019/7/22
- Sensor-Surface: 1.4mm (Mechanical Surface Detection)
- Electronics: DAE3 Sn577; Calibrated: 2019/9/17
- Phantom: SAM_Left; Type: QD000P40CD; Serial: TP:1801
- Measurement SW: DASY52, Version 52.10 (4);SEMCAD X Version 14.6.14 (7483)

Area Scan (121x91x1): Interpolated grid: dx=1.000 mm, dy=1.000 mm

Maximum value of SAR (interpolated) = 2.31 W/kg

Zoom Scan (10x13x7)/Cube 0: Measurement grid: dx=4mm, dy=4mm, dz=1.4mm

Reference Value = 14.00 V/m; Power Drift = -0.16 dB

Peak SAR (extrapolated) = 3.47 W/kg

SAR(1 g) = 0.931 W/kg; SAR(10 g) = 0.342 W/kg

Maximum value of SAR (measured) = 2.10 W/kg

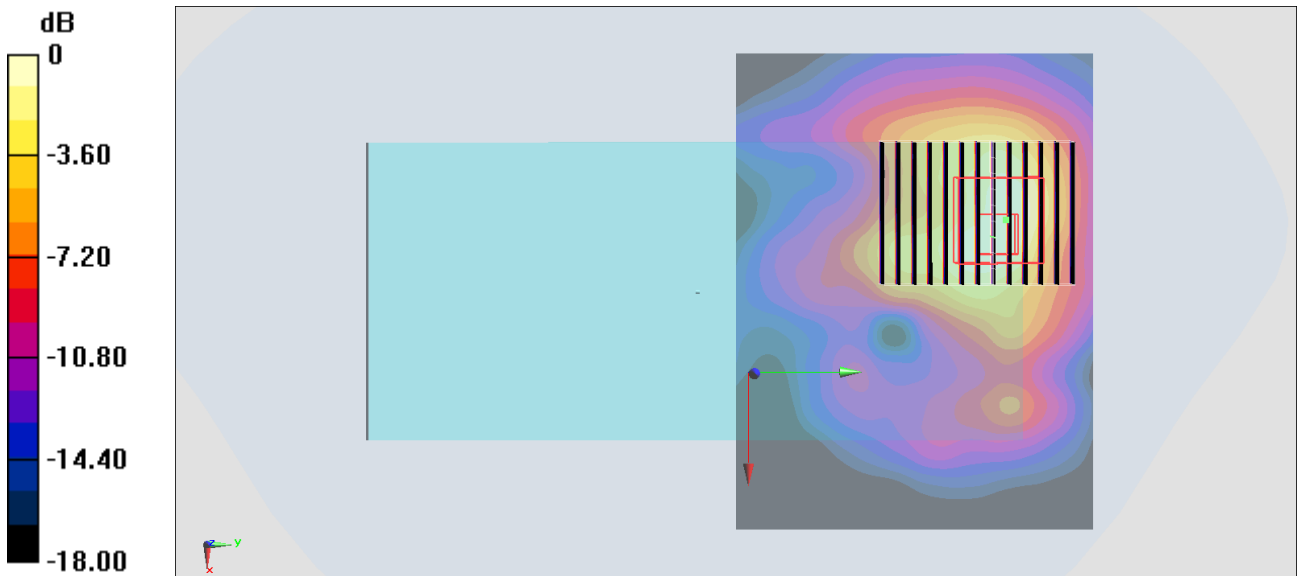

0 dB = 2.10 W/kg = 3.22 dBW/kg

#26_WLAN5GHz_802.11ac-VHT80 MCS0_Back_5mm_Ch155

Communication System: 802.11ac ; Frequency: 5775 MHz;Duty Cycle: 1:1.075

Medium: HSL_5G_200417 Medium parameters used: $f = 5775$ MHz; $\sigma = 5.084$ S/m; $\epsilon_r = 36.072$; $\rho = 1000$ kg/m³

Ambient Temperature : 23.5 °C ; Liquid Temperature : 22.5 °C

DASY5 Configuration:

- Probe: EX3DV4 - SN7306;ConvF(4.93, 4.93, 4.93) @ 5775 MHz;Calibrated: 2019/7/22
- Sensor-Surface: 1.4mm (Mechanical Surface Detection)
- Electronics: DAE3 Sn577; Calibrated: 2019/9/17
- Phantom: SAM_Left; Type: QD000P40CD; Serial: TP:1801
- Measurement SW: DASY52, Version 52.10 (4);SEMCAD X Version 14.6.14 (7483)

Area Scan (101x71x1): Interpolated grid: dx=1.000 mm, dy=1.000 mm

Maximum value of SAR (interpolated) = 2.53 W/kg

Zoom Scan (9x9x7)/Cube 0: Measurement grid: dx=4mm, dy=4mm, dz=1.4mm

Reference Value = 12.24 V/m; Power Drift = -0.13 dB

Peak SAR (extrapolated) = 4.55 W/kg

SAR(1 g) = 1.06 W/kg; SAR(10 g) = 0.355 W/kg

Maximum value of SAR (measured) = 2.62 W/kg

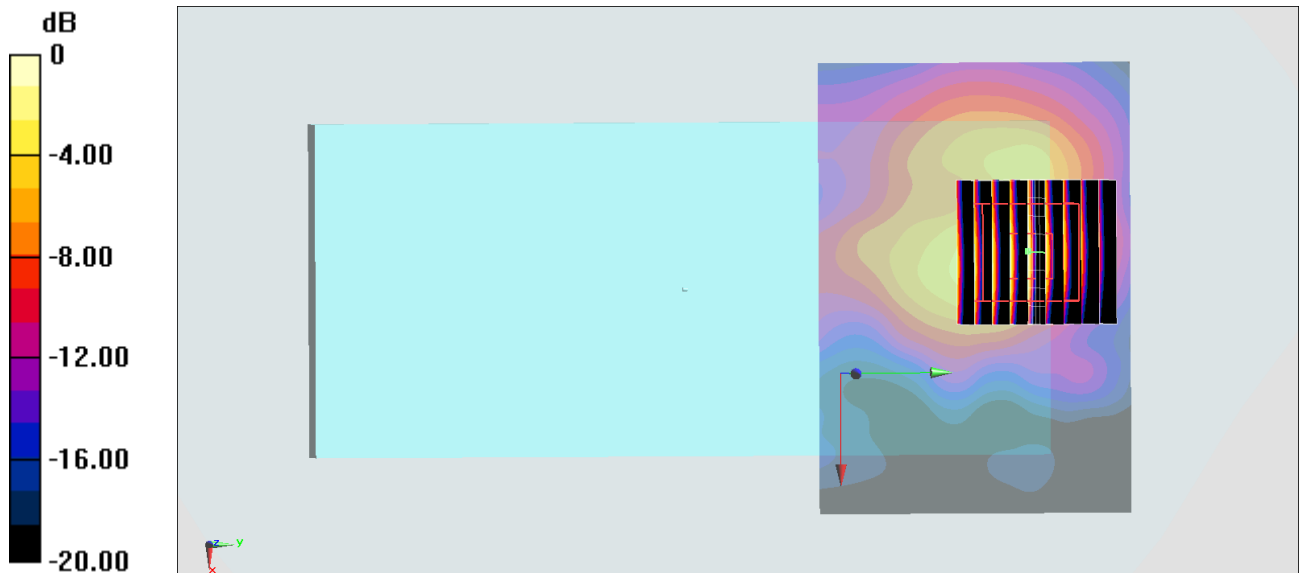

0 dB = 2.62 W/kg = 4.18 dBW/kg

#27_Bluetooth_1Mbps_Back_5mm_Ch78

Communication System: Bluetooth; Frequency: 2480 MHz; Duty Cycle: 1:1.302

Medium: HSL2450_200416 Medium parameters used : $f = 2480$ MHz; $\sigma = 1.809$ S/m; $\epsilon_r = 39.01$; $\rho = 1000$ kg/m³

Ambient Temperature : 23.5 °C ; Liquid Temperature : 22.5 °C

DASY5 Configuration:

- Probe: ES3DV3 - SN3270; ConvF(4.57, 4.57, 4.57) @ 2480 MHz; Calibrated: 2019/9/25
- Sensor-Surface: 3mm (Mechanical Surface Detection)
- Electronics: DAE4 Sn778; Calibrated: 2019/5/21
- Phantom: Twin-SAM V5.0 (30deg probe tilt); Type: QD 000 P40 CD; Serial: 1885
- Measurement SW: DASY52, Version 52.10 (4); SEMCAD X Version 14.6.14 (7483)

Area Scan (91x61x1): Interpolated grid: dx=1.200 mm, dy=1.200 mm

Maximum value of SAR (interpolated) = 0.162 W/kg

Zoom Scan (8x8x7)/Cube 0: Measurement grid: dx=5mm, dy=5mm, dz=5mm

Reference Value = 7.039 V/m; Power Drift = -0.09 dB

Peak SAR (extrapolated) = 0.527 W/kg

SAR(1 g) = 0.141 W/kg; SAR(10 g) = 0.052 W/kg

Maximum value of SAR (measured) = 0.191 W/kg

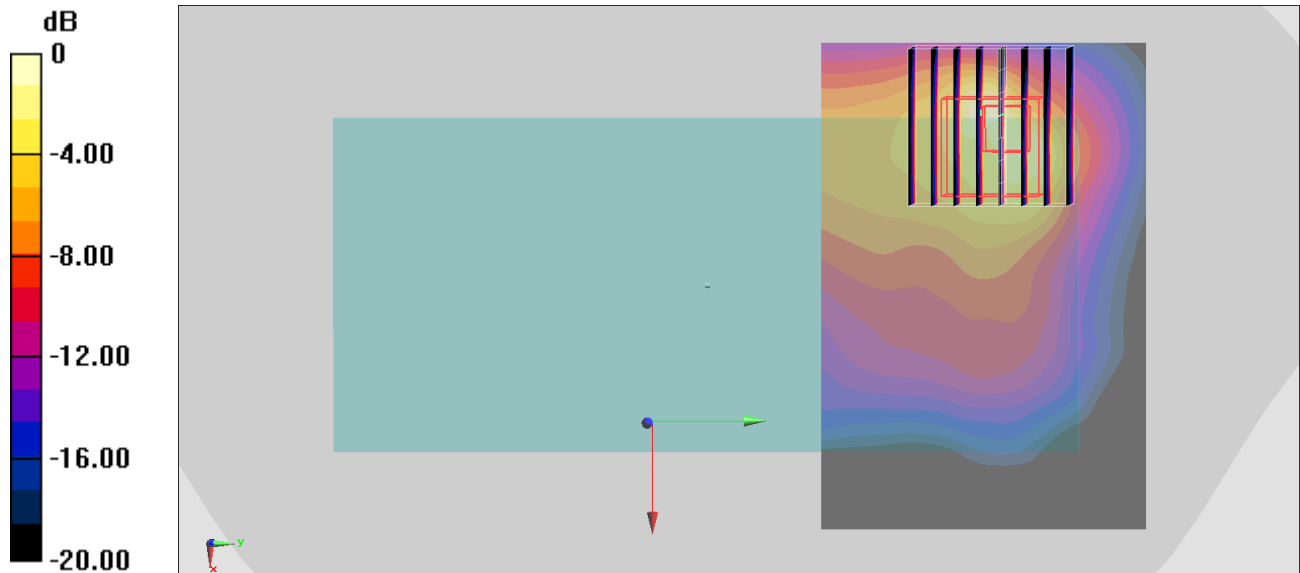

0 dB = 0.191 W/kg = -7.19 dBW/kg

#28_GSM850_GPRS (3 Tx slots)_Back_5mm_Ch251

Communication System: GSM850; Frequency: 848.8 MHz; Duty Cycle: 1:2.77

Medium: HSL_850_200412 Medium parameters used: $f = 849$ MHz; $\sigma = 0.918$ S/m; $\epsilon_r = 41.048$; $\rho = 1000$ kg/m³

Ambient Temperature : 23.6 °C ; Liquid Temperature : 22.6 °C

DASY5 Configuration:

- Probe: EX3DV4 - SN3728; ConvF(9.51, 9.51, 9.51) @ 848.8 MHz; Calibrated: 2020/2/4
- Sensor-Surface: 1.4mm (Mechanical Surface Detection)
- Electronics: DAE3 Sn495; Calibrated: 2019/5/21
- Phantom: SAM_Left; Type: QD000P40CD; Serial: TP:1801
- Measurement SW: DASY52, Version 52.10 (4); SEMCAD X Version 14.6.14 (7483)

Area Scan (71x61x1): Interpolated grid: dx=1.500 mm, dy=1.500 mm

Maximum value of SAR (interpolated) = 1.39 W/kg

Zoom Scan (5x5x7)/Cube 0: Measurement grid: dx=8mm, dy=8mm, dz=5mm

Reference Value = 35.14 V/m; Power Drift = -0.04 dB

Peak SAR (extrapolated) = 1.85 W/kg

SAR(1 g) = 0.944 W/kg; SAR(10 g) = 0.536 W/kg

Maximum value of SAR (measured) = 1.40 W/kg

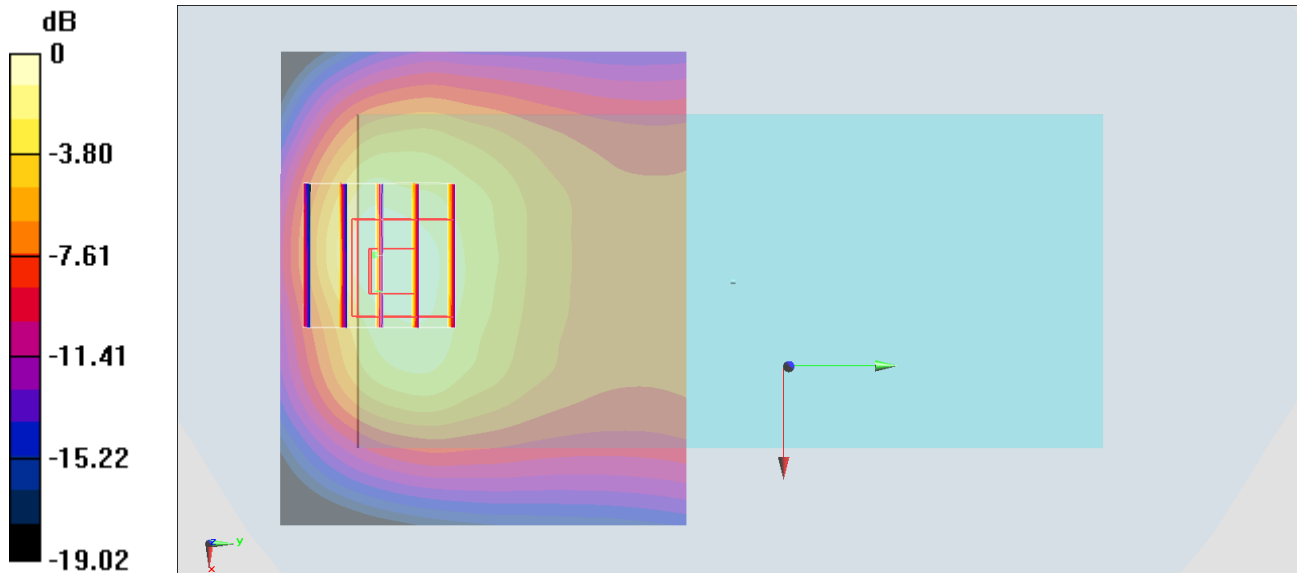

0 dB = 1.40 W/kg = 1.46 dBW/kg

#29_GSM1900_GPRS (3 Tx slots)_Back_5mm_Ch810

Communication System: PCS; Frequency: 1909.8 MHz; Duty Cycle: 1:2.77

Medium: HSL_1900_200411 Medium parameters used: $f = 1910$ MHz; $\sigma = 1.383$ S/m; $\epsilon_r = 40.032$; $\rho = 1000$ kg/m³

Ambient Temperature : 23.6 °C ; Liquid Temperature : 22.6 °C

DASY5 Configuration:

- Probe: EX3DV4 - SN3728; ConvF(7.82, 7.82, 7.82) @ 1909.8 MHz; Calibrated: 2020/2/4
- Sensor-Surface: 1.4mm (Mechanical Surface Detection)
- Electronics: DAE3 Sn495; Calibrated: 2019/5/21
- Phantom: SAM_Left; Type: QD000P40CD; Serial: TP:1801
- Measurement SW: DASY52, Version 52.10 (4); SEMCAD X Version 14.6.14 (7483)

Area Scan (61x51x1): Interpolated grid: dx=1.500 mm, dy=1.500 mm

Maximum value of SAR (interpolated) = 1.79 W/kg

Zoom Scan (5x5x7)/Cube 0: Measurement grid: dx=8mm, dy=8mm, dz=5mm

Reference Value = 26.71 V/m; Power Drift = -0.12 dB

Peak SAR (extrapolated) = 13.3 W/kg

SAR(1 g) = 1.1 W/kg; SAR(10 g) = 0.600 W/kg

Maximum value of SAR (measured) = 4.93 W/kg

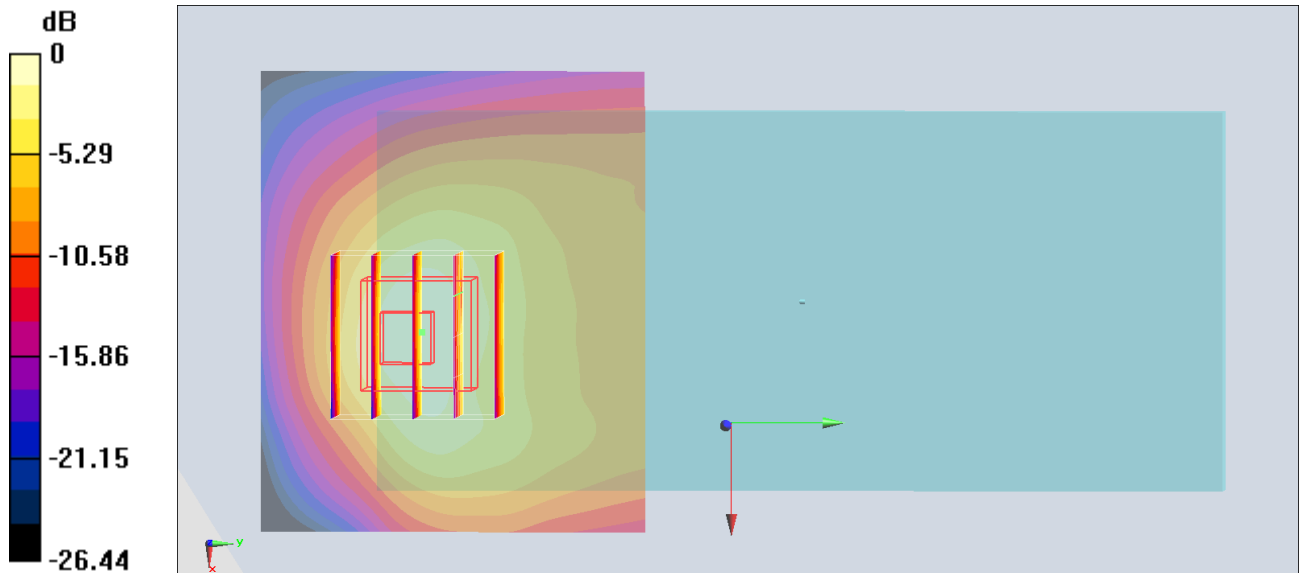

#30_WCDMA II_RMC 12.2Kbps_Back_5mm_Ch9538

Communication System: WCDMA; Frequency: 1907.6 MHz; Duty Cycle: 1:1

Medium: HSL_1900_200411 Medium parameters used: $f = 1908$ MHz; $\sigma = 1.381$ S/m; $\epsilon_r = 40.039$; $\rho = 1000$ kg/m³

Ambient Temperature : 23.6 °C; Liquid Temperature : 22.6 °C

DASY5 Configuration:

- Probe: EX3DV4 - SN3728; ConvF(7.82, 7.82, 7.82) @ 1907.6 MHz; Calibrated: 2020/2/4
- Sensor-Surface: 1.4mm (Mechanical Surface Detection)
- Electronics: DAE3 Sn495; Calibrated: 2019/5/21
- Phantom: SAM_Left; Type: QD000P40CD; Serial: TP:1801
- Measurement SW: DASY52, Version 52.10 (4); SEMCAD X Version 14.6.14 (7483)

Area Scan (61x51x1): Interpolated grid: dx=1.500 mm, dy=1.500 mm

Maximum value of SAR (interpolated) = 1.79 W/kg

Zoom Scan (5x5x7)/Cube 0: Measurement grid: dx=8mm, dy=8mm, dz=5mm

Reference Value = 27.00 V/m; Power Drift = -0.13 dB

Peak SAR (extrapolated) = 2.15 W/kg

SAR(1 g) = 1.17 W/kg; SAR(10 g) = 0.618 W/kg

Maximum value of SAR (measured) = 1.80 W/kg

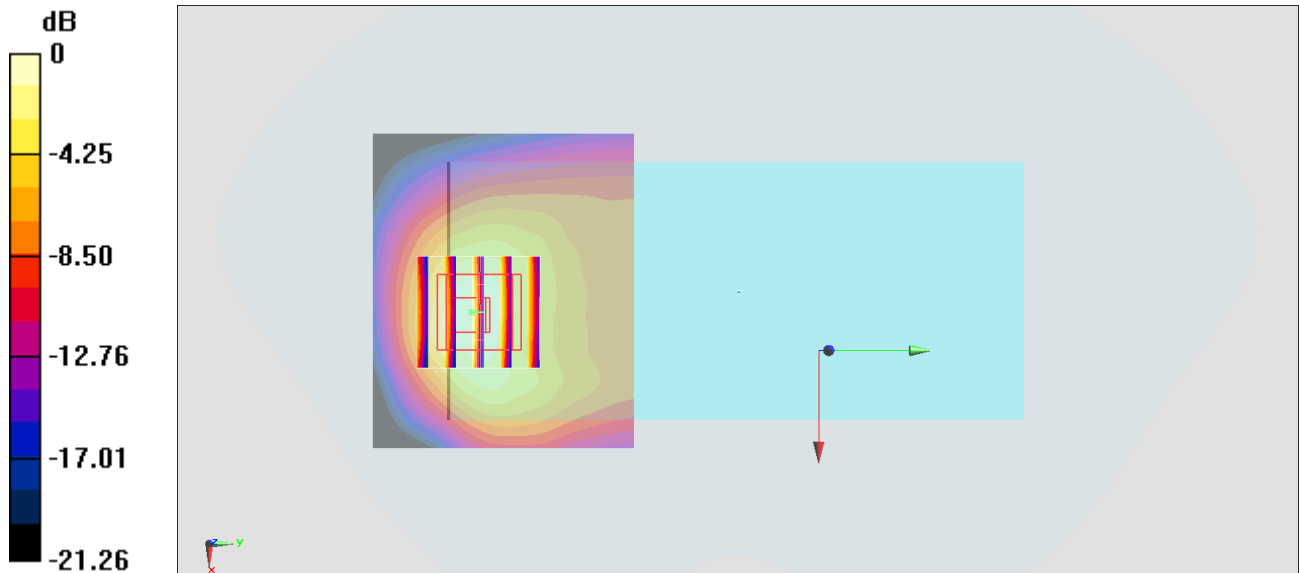

0 dB = 1.80 W/kg = 2.55 dBW/kg

#31_WCDMA IV_RMC 12.2Kbps_Back_5mm_Ch1513

Communication System: WCDMA; Frequency: 1752.6 MHz; Duty Cycle: 1:1

Medium: HSL_1750_200411 Medium parameters used: $f = 1753$ MHz; $\sigma = 1.362$ S/m; $\epsilon_r = 40.316$; $\rho = 1000$ kg/m³

Ambient Temperature : 23.6 °C ; Liquid Temperature : 22.6 °C

DASY5 Configuration:

- Probe: EX3DV4 - SN3728; ConvF(8.06, 8.06, 8.06) @ 1752.6 MHz; Calibrated: 2020/2/4
- Sensor-Surface: 1.4mm (Mechanical Surface Detection)
- Electronics: DAE3 Sn495; Calibrated: 2019/5/21
- Phantom: SAM_Left; Type: QD000P40CD; Serial: TP:1801
- Measurement SW: DASY52, Version 52.10 (4); SEMCAD X Version 14.6.14 (7483)

Area Scan (61x51x1): Interpolated grid: dx=1.500 mm, dy=1.500 mm

Maximum value of SAR (interpolated) = 1.62 W/kg

Zoom Scan (5x5x7)/Cube 0: Measurement grid: dx=8mm, dy=8mm, dz=5mm

Reference Value = 27.69 V/m; Power Drift = -0.10 dB

Peak SAR (extrapolated) = 2.02 W/kg

SAR(1 g) = 1.12 W/kg; SAR(10 g) = 0.603 W/kg

Maximum value of SAR (measured) = 1.67 W/kg

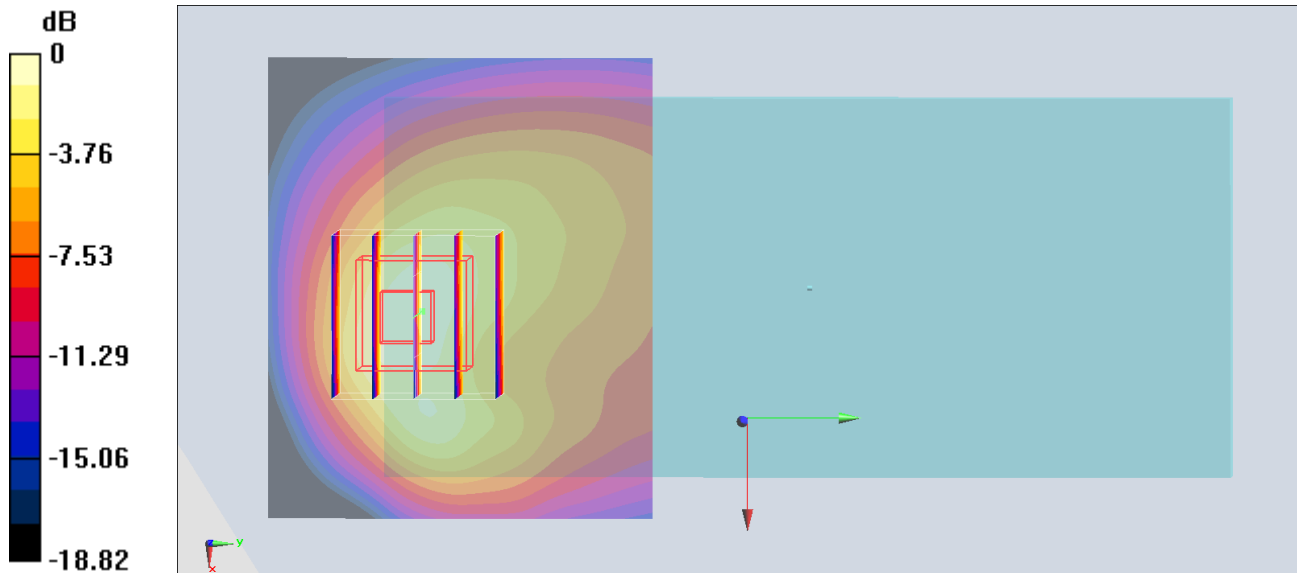

0 dB = 1.67 W/kg = 2.23 dBW/kg

#32_WCDMA V_RMC 12.2Kbps_Back_5mm_Ch4132

Communication System: WCDMA; Frequency: 826.4 MHz; Duty Cycle: 1:1

Medium: HSL_850_200412 Medium parameters used : $f = 826.4$ MHz; $\sigma = 0.877$ S/m; $\epsilon_r = 41.354$; $\rho = 1000$ kg/m³

Ambient Temperature : 23.6 °C ; Liquid Temperature : 22.6 °C

DASY5 Configuration:

- Probe: EX3DV4 - SN3728; ConvF(9.51, 9.51, 9.51) @ 826.4 MHz; Calibrated: 2020/2/4
- Sensor-Surface: 1.4mm (Mechanical Surface Detection)
- Electronics: DAE3 Sn495; Calibrated: 2019/5/21
- Phantom: SAM_Left; Type: QD000P40CD; Serial: TP:1801
- Measurement SW: DASY52, Version 52.10 (4); SEMCAD X Version 14.6.14 (7483)

Area Scan (61x51x1): Interpolated grid: dx=1.500 mm, dy=1.500 mm

Maximum value of SAR (interpolated) = 1.546 W/kg

Zoom Scan (5x5x7)/Cube 0: Measurement grid: dx=8mm, dy=8mm, dz=5mm

Reference Value = 31.69 V/m; Power Drift = -0.09 dB

Peak SAR (extrapolated) = 1.787 W/kg

SAR(1 g) = 0.966 W/kg; SAR(10 g) = 0.552 W/kg

Maximum value of SAR (measured) = 1.401 W/kg

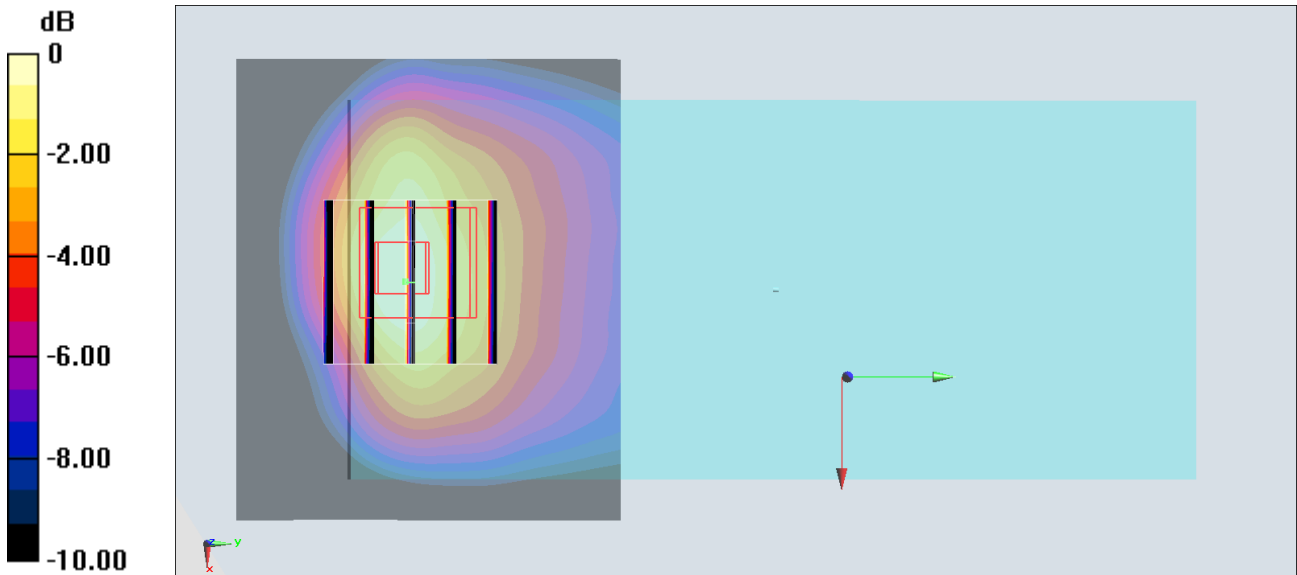

0 dB = 1.401 W/kg = 2.93 dBW/kg

#33_LTE Band 2_20M_QPSK_1_0_Back_5mm_Ch19100

Communication System: LTE; Frequency: 1900 MHz; Duty Cycle: 1:1

Medium: HSL_1900_200411 Medium parameters used: $f = 1900$ MHz; $\sigma = 1.373$ S/m; $\epsilon_r = 40.07$; $\rho = 1000$ kg/m³

Ambient Temperature : 23.6 °C ; Liquid Temperature : 22.6 °C

DASY5 Configuration:

- Probe: EX3DV4 - SN3728; ConvF(7.82, 7.82, 7.82) @ 1900 MHz; Calibrated: 2020/2/4
- Sensor-Surface: 1.4mm (Mechanical Surface Detection)
- Electronics: DAE3 Sn495; Calibrated: 2019/5/21
- Phantom: SAM_Left; Type: QD000P40CD; Serial: TP:1801
- Measurement SW: DASY52, Version 52.10 (4); SEMCAD X Version 14.6.14 (7483)

Area Scan (71x61x1): Interpolated grid: dx=1.500 mm, dy=1.500 mm

Maximum value of SAR (interpolated) = 1.50 W/kg

Zoom Scan (5x5x7)/Cube 0: Measurement grid: dx=8mm, dy=8mm, dz=5mm

Reference Value = 18.29 V/m; Power Drift = -0.12 dB

Peak SAR (extrapolated) = 1.76 W/kg

SAR(1 g) = 0.964 W/kg; SAR(10 g) = 0.511 W/kg

Maximum value of SAR (measured) = 1.40 W/kg

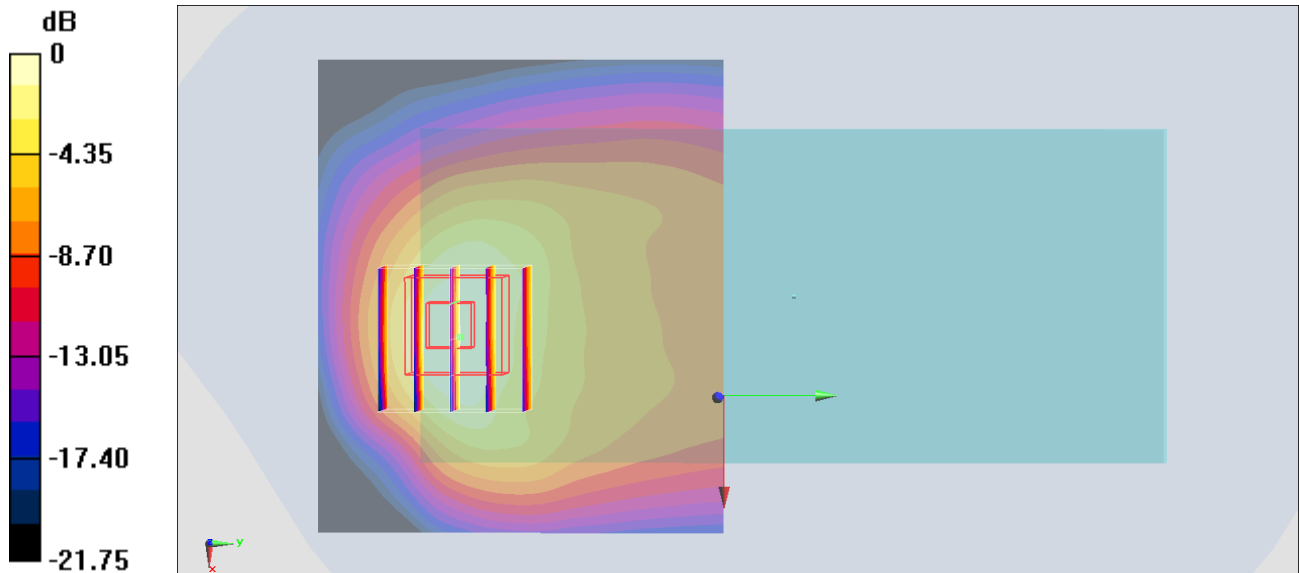

0 dB = 1.40 W/kg = 1.46 dBW/kg

#34_LTE Band 5_10M_QPSK_1_0_Back_5mm_Ch20525

Communication System: LTE; Frequency: 836.5 MHz; Duty Cycle: 1:1

Medium: HSL_850_200412 Medium parameters used : $f = 836.5$ MHz; $\sigma = 0.897$ S/m; $\epsilon_r = 41.151$; $\rho = 1000$ kg/m³

Ambient Temperature : 23.6 °C ; Liquid Temperature : 22.6 °C

DASY5 Configuration:

- Probe: EX3DV4 - SN3728; ConvF(9.51, 9.51, 9.51) @ 836.5 MHz; Calibrated: 2020/2/4
- Sensor-Surface: 1.4mm (Mechanical Surface Detection)
- Electronics: DAE3 Sn495; Calibrated: 2019/5/21
- Phantom: SAM_Left; Type: QD000P40CD; Serial: TP:1801
- Measurement SW: DASY52, Version 52.10 (4); SEMCAD X Version 14.6.14 (7483)

Area Scan (61x51x1): Interpolated grid: dx=1.500 mm, dy=1.500 mm

Maximum value of SAR (interpolated) = 1.31 W/kg

Zoom Scan (5x5x7)/Cube 0: Measurement grid: dx=8mm, dy=8mm, dz=5mm

Reference Value = 31.74 V/m; Power Drift = -0.09 dB

Peak SAR (extrapolated) = 1.52 W/kg

SAR(1 g) = 0.822 W/kg; SAR(10 g) = 0.469 W/kg

Maximum value of SAR (measured) = 1.19 W/kg

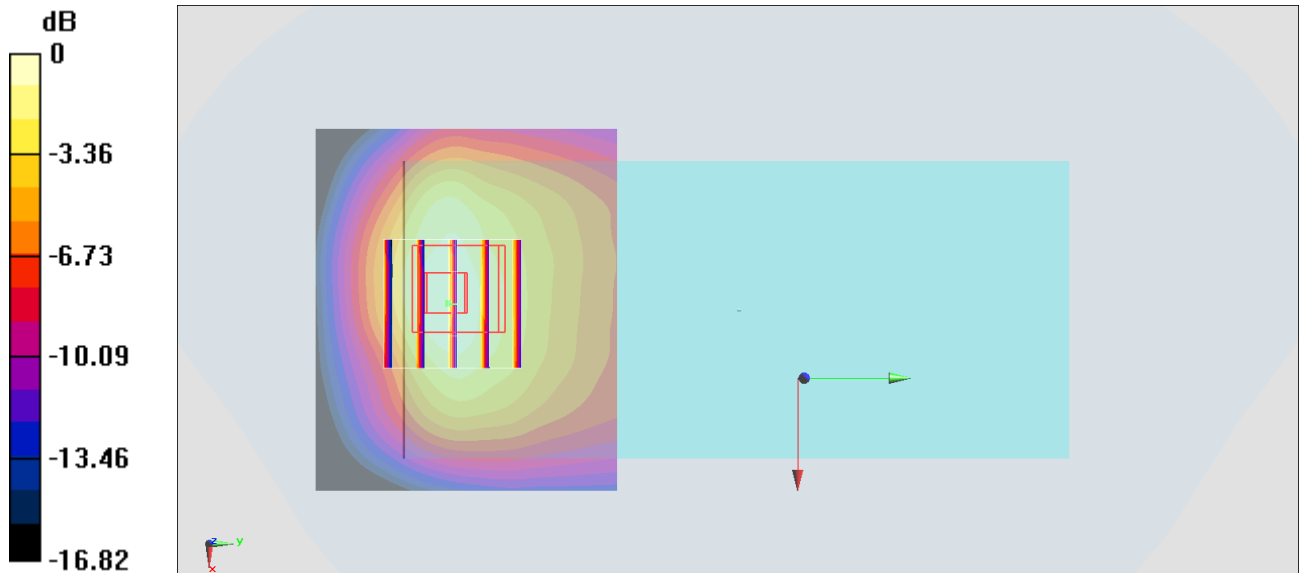

0 dB = 1.19 W/kg = 0.76 dBW/kg

#35_LTE Band 7_20M_QPSK_1_0_Back_5mm_Ch21100

Communication System: LTE; Frequency: 2535 MHz; Duty Cycle: 1:1

Medium: HSL_2600_200410 Medium parameters used : $f = 2535$ MHz; $\sigma = 1.841$ S/m; $\epsilon_r = 37.698$; $\rho = 1000$ kg/m³

Ambient Temperature : 23.6 °C ; Liquid Temperature : 22.6 °C

DASY5 Configuration:

- Probe: EX3DV4 - SN3728; ConvF(7.08, 7.08, 7.08) @ 2535 MHz; Calibrated: 2020/2/4
- Sensor-Surface: 1.4mm (Mechanical Surface Detection)
- Electronics: DAE3 Sn495; Calibrated: 2019/5/21
- Phantom: SAM_Left; Type: QD000P40CD; Serial: TP:1801
- Measurement SW: DASY52, Version 52.10 (4); SEMCAD X Version 14.6.14 (7483)

Area Scan (91x71x1): Interpolated grid: dx=1.200 mm, dy=1.200 mm

Maximum value of SAR (interpolated) = 1.70 W/kg

Zoom Scan (7x7x7)/Cube 0: Measurement grid: dx=5mm, dy=5mm, dz=5mm

Reference Value = 28.63 V/m; Power Drift = -0.19 dB

Peak SAR (extrapolated) = 2.51 W/kg

SAR(1 g) = 1.14 W/kg; SAR(10 g) = 0.469 W/kg

Maximum value of SAR (measured) = 2.00 W/kg

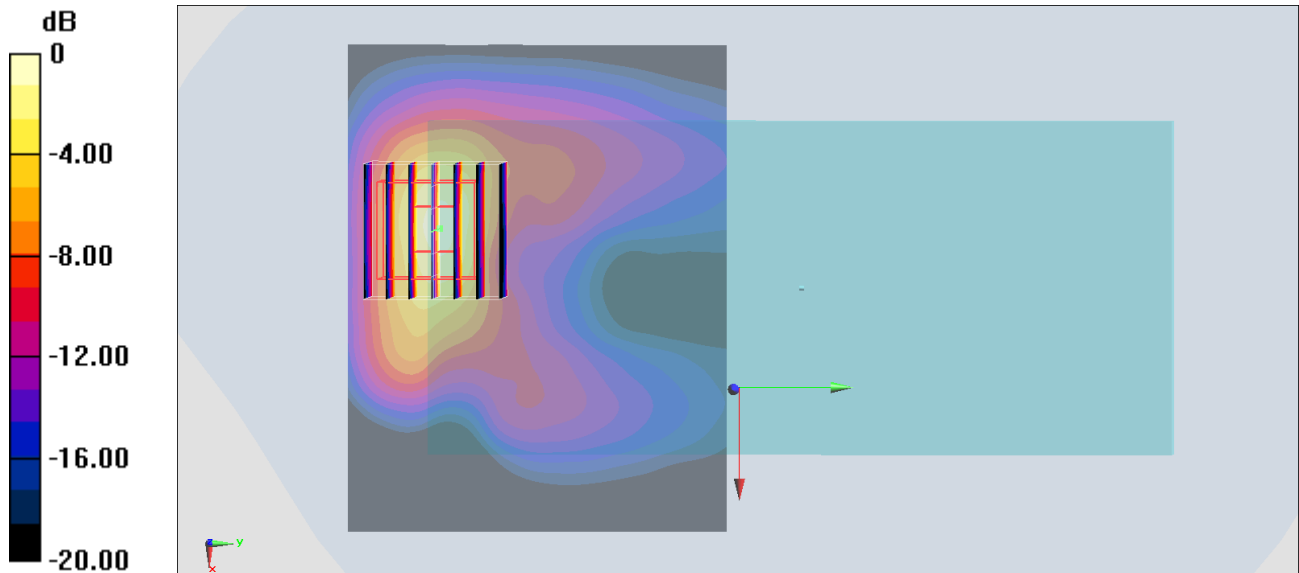

0 dB = 2.00 W/kg = 3.01 dBW/kg

#36_LTE Band 66_20M_QPSK_1_0_Back_5mm_Ch132072

Communication System: LTE; Frequency: 1720 MHz; Duty Cycle: 1:1

Medium: HSL_1750_200413 Medium parameters used: $f = 1720$ MHz; $\sigma = 1.337$ S/m; $\epsilon_r = 40.731$; $\rho = 1000$ kg/m³

Ambient Temperature : 23.6 °C ; Liquid Temperature : 22.6 °C

DASY5 Configuration:

- Probe: EX3DV4 - SN3728; ConvF(8.06, 8.06, 8.06) @ 1720 MHz; Calibrated: 2020/2/4
- Sensor-Surface: 1.4mm (Mechanical Surface Detection)
- Electronics: DAE3 Sn495; Calibrated: 2019/5/21
- Phantom: SAM_Left; Type: QD000P40CD; Serial: TP:1801
- Measurement SW: DASY52, Version 52.10 (4); SEMCAD X Version 14.6.14 (7483)

Area Scan (71x61x1): Interpolated grid: dx=1.500 mm, dy=1.500 mm

Maximum value of SAR (interpolated) = 1.82 W/kg

Zoom Scan (5x5x7)/Cube 0: Measurement grid: dx=8mm, dy=8mm, dz=5mm

Reference Value = 22.10 V/m; Power Drift = -0.15 dB

Peak SAR (extrapolated) = 2.16 W/kg

SAR(1 g) = 1.14 W/kg; SAR(10 g) = 0.610 W/kg

Maximum value of SAR (measured) = 1.73 W/kg

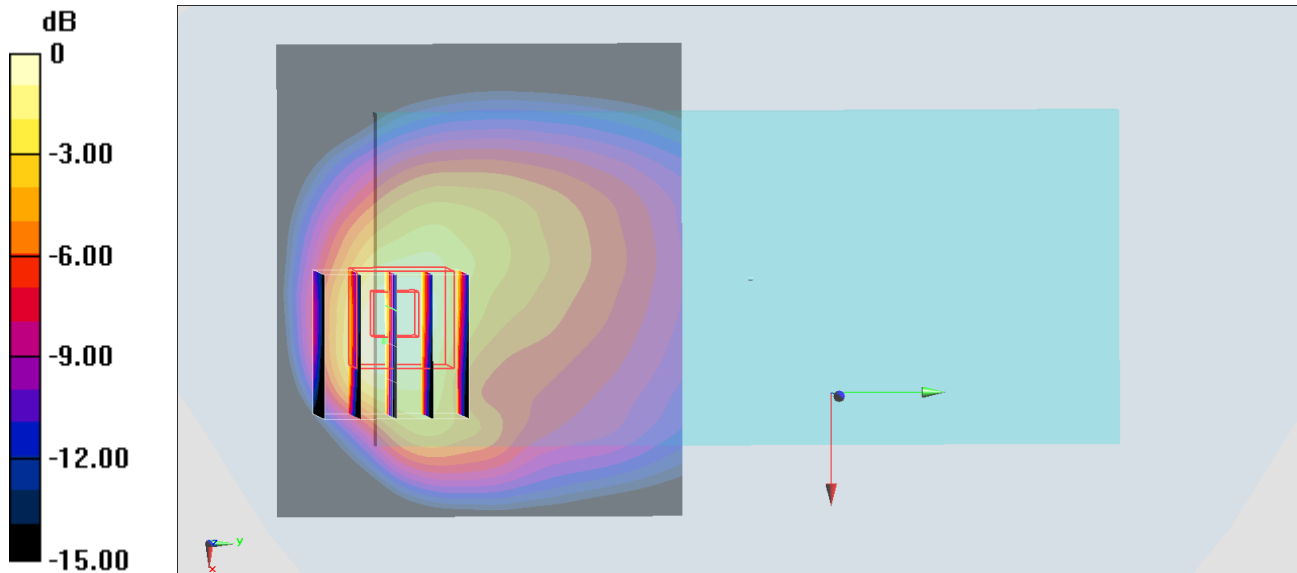

0 dB = 1.73 W/kg = 2.38 dBW/kg

#37_WLAN2.4GHz_802.11b 1Mbps_Back_5mm_Ch11

Communication System: 802.11b ; Frequency: 2462 MHz;Duty Cycle: 1:1

Medium: HSL2450_200416 Medium parameters used: $f = 2462$ MHz; $\sigma = 1.827$ S/m; $\epsilon_r = 39.061$; $\rho = 1000$ kg/m³

Ambient Temperature : 23.6 °C ; Liquid Temperature : 22.6 °C

DASY5 Configuration:

- Probe: EX3DV4 - SN7306;ConvF(7.48, 7.48, 7.48) @ 2462 MHz;Calibrated: 2019/7/22
- Sensor-Surface: 3mm (Mechanical Surface Detection)
- Electronics: DAE3 Sn577; Calibrated: 2019/9/17
- Phantom: SAM_Left; Type: QD000P40CD; Serial: TP:1801
- Measurement SW: DASY52, Version 52.10 (4);SEMCAD X Version 14.6.14 (7483)

Area Scan (91x61x1): Interpolated grid: dx=1.200 mm, dy=1.200 mm

Maximum value of SAR (interpolated) = 1.14 W/kg

Zoom Scan (8x8x7)/Cube 0: Measurement grid: dx=5mm, dy=5mm, dz=5mm

Reference Value = 16.73 V/m; Power Drift = 0.03 dB

Peak SAR (extrapolated) = 2.69 W/kg

SAR(1 g) = 1.07 W/kg; SAR(10 g) = 0.426 W/kg

Maximum value of SAR (measured) = 1.48 W/kg

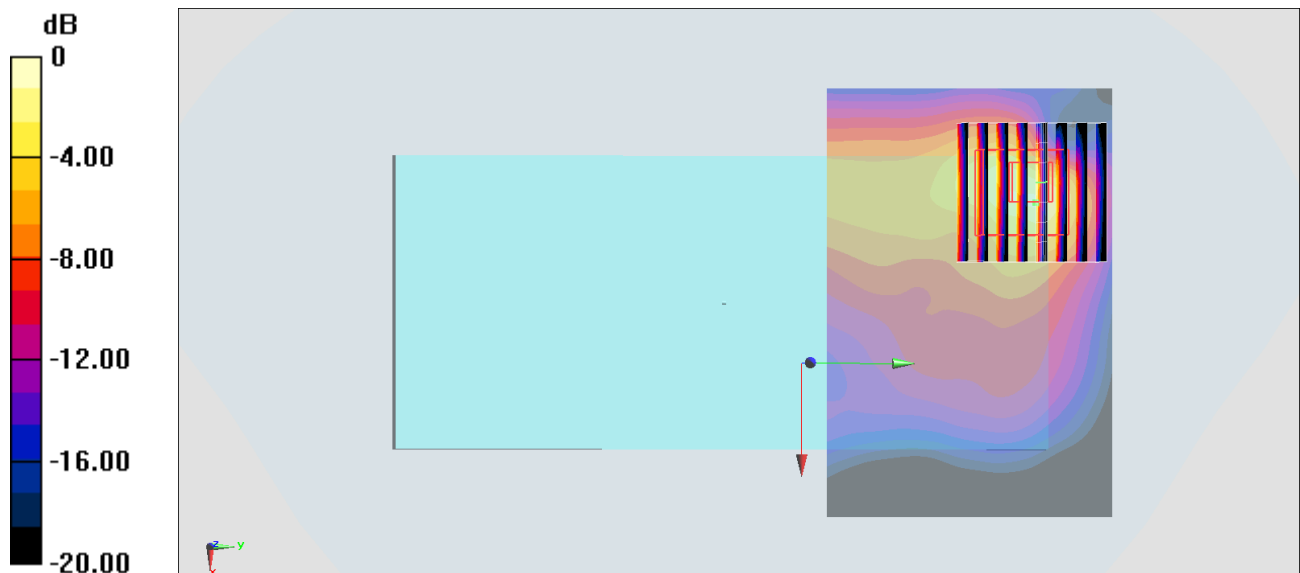

0 dB = 1.48 W/kg = 1.70 dBW/kg

#38_WLAN5GHz_802.11n-HT40 MCS0_Back_5mm_Ch62

Communication System: 802.11n ; Frequency: 5310 MHz;Duty Cycle: 1:1.037

Medium: HSL_5G_200417 Medium parameters used: $f = 5310$ MHz; $\sigma = 4.627$ S/m; $\epsilon_r = 36.576$; $\rho = 1000$ kg/m³

Ambient Temperature : 23.5 °C ; Liquid Temperature : 22.5 °C

DASY5 Configuration:

- Probe: EX3DV4 - SN7306;ConvF(5.34, 5.34, 5.34) @ 5310 MHz;Calibrated: 2019/7/22
- Sensor-Surface: 1.4mm (Mechanical Surface Detection)
- Electronics: DAE3 Sn577; Calibrated: 2019/9/17
- Phantom: SAM_Left; Type: QD000P40CD; Serial: TP:1801
- Measurement SW: DASY52, Version 52.10 (4);SEMCAD X Version 14.6.14 (7483)

Area Scan (101x71x1): Interpolated grid: $dx=1.000$ mm, $dy=1.000$ mm

Maximum value of SAR (interpolated) = 2.37 W/kg

Zoom Scan (9x9x7)/Cube 0: Measurement grid: $dx=4$ mm, $dy=4$ mm, $dz=1.4$ mm

Reference Value = 14.40 V/m; Power Drift = -0.18 dB

Peak SAR (extrapolated) = 4.15 W/kg

SAR(1 g) = 1.04 W/kg; SAR(10 g) = 0.366 W/kg

Maximum value of SAR (measured) = 2.42 W/kg

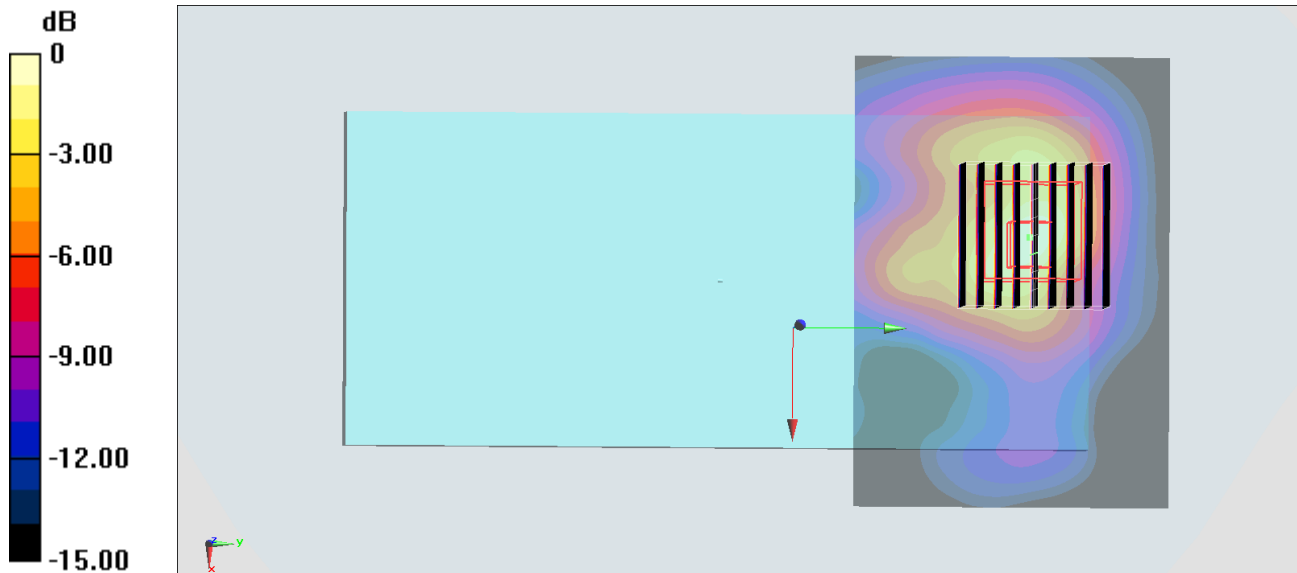

#39_WLAN5GHz_802.11ac-VHT80 MCS0_Back_5mm_Ch122

Communication System: 802.11ac ; Frequency: 5610 MHz;Duty Cycle: 1:1.081

Medium: HSL_5G_200417 Medium parameters used: $f = 5610$ MHz; $\sigma = 5.067$ S/m; $\epsilon_r = 36.314$; $\rho = 1000$ kg/m³

Ambient Temperature : 23.5 °C ; Liquid Temperature : 22.5 °C

DASY5 Configuration:

- Probe: EX3DV4 - SN7306;ConvF(4.79, 4.79, 4.79) @ 5610 MHz;Calibrated: 2019/7/22
- Sensor-Surface: 1.4mm (Mechanical Surface Detection)
- Electronics: DAE3 Sn577; Calibrated: 2019/9/17
- Phantom: SAM_Left; Type: QD000P40CD; Serial: TP:1801
- Measurement SW: DASY52, Version 52.10 (4);SEMCAD X Version 14.6.14 (7483)

Area Scan (101x71x1): Interpolated grid: dx=1.000 mm, dy=1.000 mm

Maximum value of SAR (interpolated) = 2.15 W/kg

Zoom Scan (9x9x7)/Cube 0: Measurement grid: dx=4mm, dy=4mm, dz=1.4mm

Reference Value = 10.86 V/m; Power Drift = -0.06 dB

Peak SAR (extrapolated) = 3.50 W/kg

SAR(1 g) = 0.896 W/kg; SAR(10 g) = 0.326 W/kg

Maximum value of SAR (measured) = 2.09 W/kg

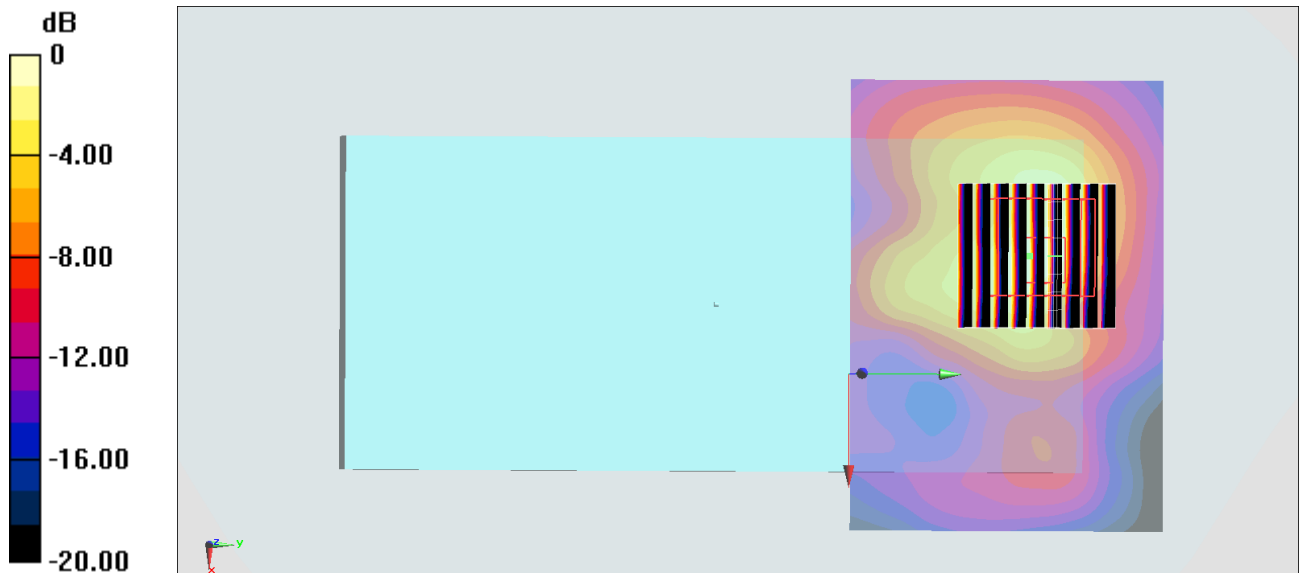

0 dB = 2.09 W/kg = 3.20 dBW/kg

#40_WLAN5GHz_802.11ac-VHT80 MCS0_Back_5mm_Ch155

Communication System: 802.11ac ; Frequency: 5775 MHz;Duty Cycle: 1:1.075

Medium: HSL_5G_200417 Medium parameters used: $f = 5775$ MHz; $\sigma = 5.084$ S/m; $\epsilon_r = 36.072$; $\rho = 1000$ kg/m³

Ambient Temperature : 23.5 °C ; Liquid Temperature : 22.5 °C

DASY5 Configuration:

- Probe: EX3DV4 - SN7306;ConvF(4.93, 4.93, 4.93) @ 5775 MHz;Calibrated: 2019/7/22
- Sensor-Surface: 1.4mm (Mechanical Surface Detection)
- Electronics: DAE3 Sn577; Calibrated: 2019/9/17
- Phantom: SAM_Left; Type: QD000P40CD; Serial: TP:1801
- Measurement SW: DASY52, Version 52.10 (4);SEMCAD X Version 14.6.14 (7483)

Area Scan (101x71x1): Interpolated grid: dx=1.000 mm, dy=1.000 mm

Maximum value of SAR (interpolated) = 2.53 W/kg

Zoom Scan (9x9x7)/Cube 0: Measurement grid: dx=4mm, dy=4mm, dz=1.4mm

Reference Value = 12.24 V/m; Power Drift = -0.13 dB

Peak SAR (extrapolated) = 4.55 W/kg

SAR(1 g) = 1.06 W/kg; SAR(10 g) = 0.355 W/kg

Maximum value of SAR (measured) = 2.62 W/kg

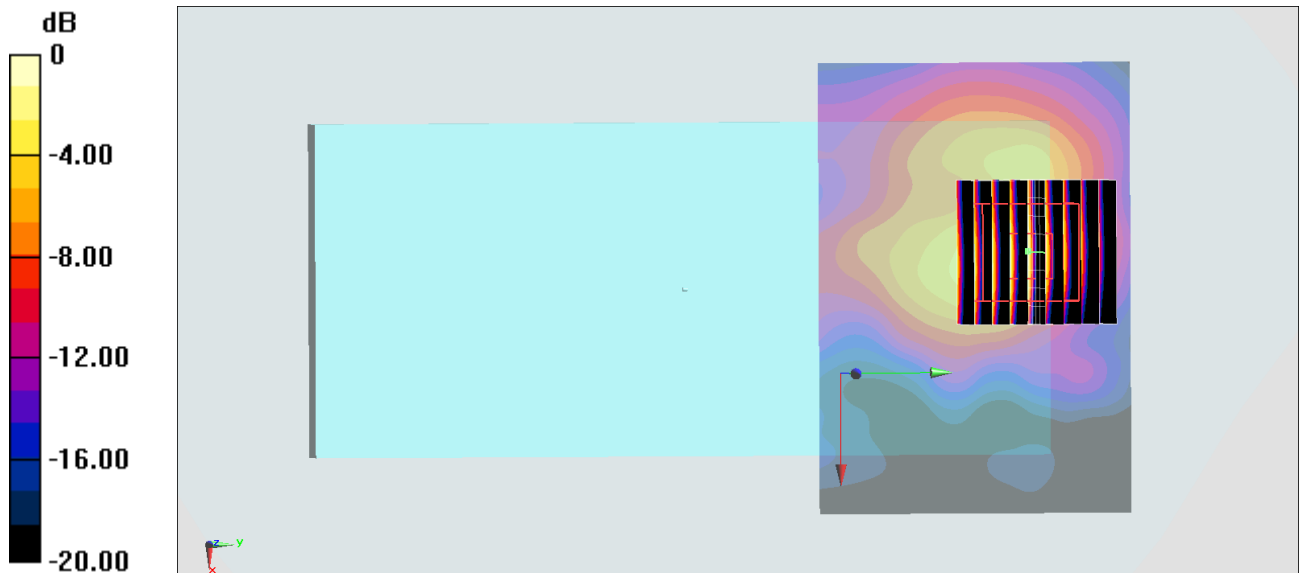

0 dB = 2.62 W/kg = 4.18 dBW/kg

#41_Bluetooth_1Mbps_Back_5mm_Ch78

Communication System: Bluetooth; Frequency: 2480 MHz; Duty Cycle: 1:1.304

Medium: HSL2450_200416 Medium parameters used : $f = 2480$ MHz; $\sigma = 1.809$ S/m; $\epsilon_r = 39.01$; $\rho = 1000$ kg/m³

Ambient Temperature : 23.6 °C ; Liquid Temperature : 22.6 °C

DASY5 Configuration:

- Probe: ES3DV3 - SN3270; ConvF(4.57, 4.57, 4.57) @ 2480 MHz; Calibrated: 2019/9/25
- Sensor-Surface: 3mm (Mechanical Surface Detection)
- Electronics: DAE4 Sn778; Calibrated: 2019/5/21
- Phantom: Twin-SAM V5.0 (30deg probe tilt); Type: QD 000 P40 CD; Serial: 1885
- Measurement SW: DASY52, Version 52.10 (4); SEMCAD X Version 14.6.14 (7483)

Area Scan (91x61x1): Interpolated grid: dx=1.200 mm, dy=1.200 mm

Maximum value of SAR (interpolated) = 0.162 W/kg

Zoom Scan (8x8x7)/Cube 0: Measurement grid: dx=5mm, dy=5mm, dz=5mm

Reference Value = 7.039 V/m; Power Drift = -0.09 dB

Peak SAR (extrapolated) = 0.527 W/kg

SAR(1 g) = 0.141 W/kg; SAR(10 g) = 0.052 W/kg

Maximum value of SAR (measured) = 0.191 W/kg

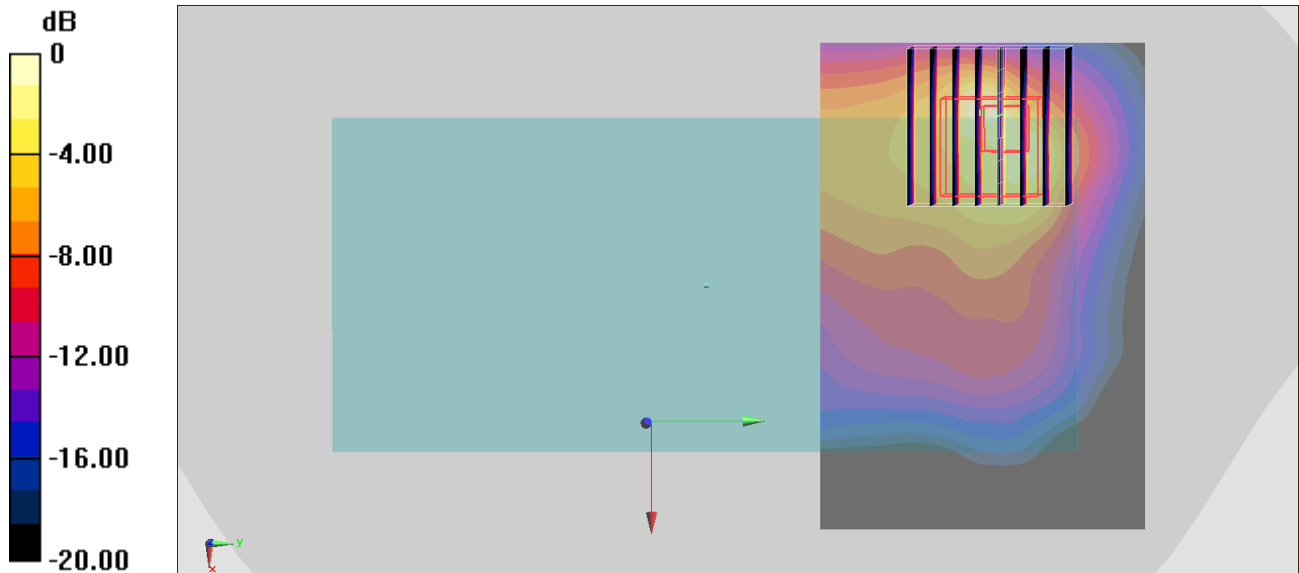

0 dB = 0.191 W/kg = -7.19 dBW/kg

#42_GSM850_GPRS (3 Tx slots)_Back_0mm_Ch251

Communication System: GSM850; Frequency: 848.8 MHz; Duty Cycle: 1:2.77

Medium: HSL_850_200415 Medium parameters used: $f = 849$ MHz; $\sigma = 0.889$ S/m; $\epsilon_r = 41.275$; $\rho = 1000$ kg/m³

Ambient Temperature : 23.5 °C ; Liquid Temperature : 22.5 °C

DASY5 Configuration:

- Probe: ES3DV3 - SN3270; ConvF(6.43, 6.43, 6.43) @ 848.8 MHz; Calibrated: 2019/9/25
- Sensor-Surface: 3mm (Mechanical Surface Detection)
- Electronics: DAE4 Sn778; Calibrated: 2019/5/21
- Phantom: SAM_Left; Type: QD000P40CD; Serial: TP:1801
- Measurement SW: DASY52, Version 52.10 (4); SEMCAD X Version 14.6.14 (7483)

Area Scan (71x51x1): Interpolated grid: dx=1.500 mm, dy=1.500 mm

Maximum value of SAR (interpolated) = 3.41 W/kg

Zoom Scan (5x5x7)/Cube 0: Measurement grid: dx=8mm, dy=8mm, dz=5mm

Reference Value = 47.48 V/m; Power Drift = -0.09 dB

Peak SAR (extrapolated) = 4.95 W/kg

SAR(1 g) = 1.96 W/kg; SAR(10 g) = 1.07 W/kg

Maximum value of SAR (measured) = 3.63 W/kg

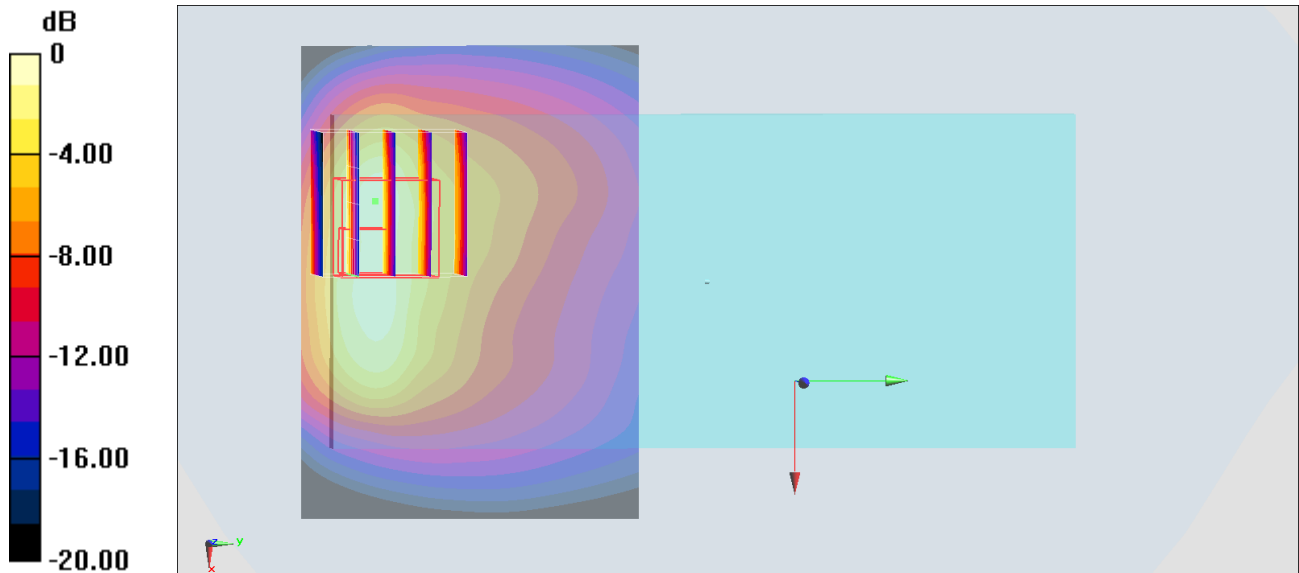

0 dB = 3.63 W/kg = 5.60 dBW/kg

#43_GSM1900_GPRS (3 Tx slots)_Back_0mm_Ch810

Communication System: PCS ; Frequency: 1909.8 MHz; Duty Cycle: 1:2.77

Medium: HSL_1900_200415 Medium parameters used: $f = 1910$ MHz; $\sigma = 1.39$ S/m; $\epsilon_r = 40.653$; $\rho = 1000$ kg/m³

Ambient Temperature : 23.5 °C ; Liquid Temperature : 22.5 °C

DASY5 Configuration:

- Probe: ES3DV3 - SN3270; ConvF(5.2, 5.2, 5.2) @ 1909.8 MHz; Calibrated: 2019/9/25
- Sensor-Surface: 3mm (Mechanical Surface Detection)
- Electronics: DAE4 Sn778; Calibrated: 2019/5/21
- Phantom: SAM_Left; Type: QD000P40CD; Serial: TP:1801
- Measurement SW: DASY52, Version 52.10 (4); SEMCAD X Version 14.6.14 (7483)

Area Scan (71x51x1): Interpolated grid: dx=1.500 mm, dy=1.500 mm

Maximum value of SAR (interpolated) = 3.51 W/kg

Zoom Scan (5x5x7)/Cube 0: Measurement grid: dx=8mm, dy=8mm, dz=5mm

Reference Value = 33.73 V/m; Power Drift = 0.16 dB

Peak SAR (extrapolated) = 8.95 W/kg

SAR(1 g) = 3.07 W/kg; SAR(10 g) = 1.29 W/kg

Maximum value of SAR (measured) = 3.74 W/kg

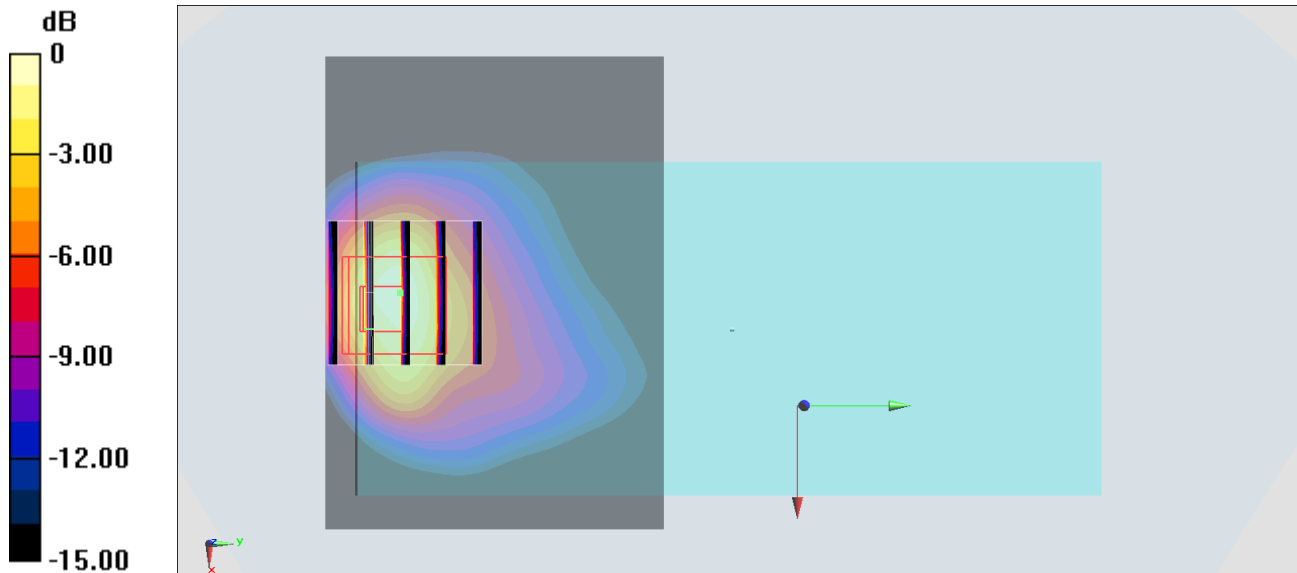

0 dB = 3.74 W/kg = 5.73 dBW/kg

#44_WCDMA II_RMC 12.2Kbps_Back_0mm_Ch9538

Communication System: WCDMA; Frequency: 1907.6 MHz; Duty Cycle: 1:1

Medium: HSL_1900_200415 Medium parameters used: $f = 1908$ MHz; $\sigma = 1.387$ S/m; $\epsilon_r = 40.66$; $\rho = 1000$ kg/m³

Ambient Temperature : 23.5 °C ; Liquid Temperature : 22.5 °C

DASY5 Configuration:

- Probe: ES3DV3 - SN3270; ConvF(5.2, 5.2, 5.2) @ 1907.6 MHz; Calibrated: 2019/9/25
- Sensor-Surface: 3mm (Mechanical Surface Detection)
- Electronics: DAE4 Sn778; Calibrated: 2019/5/21
- Phantom: SAM_Left; Type: QD000P40CD; Serial: TP:1801
- Measurement SW: DASY52, Version 52.10 (4); SEMCAD X Version 14.6.14 (7483)

Area Scan (71x51x1): Interpolated grid: dx=1.500 mm, dy=1.500 mm

Maximum value of SAR (interpolated) = 7.02 W/kg

Zoom Scan (5x5x7)/Cube 0: Measurement grid: dx=8mm, dy=8mm, dz=5mm

Reference Value = 54.87 V/m; Power Drift = -0.08 dB

Peak SAR (extrapolated) = 12.7 W/kg

SAR(1 g) = 5.85 W/kg; SAR(10 g) = 2.72 W/kg

Maximum value of SAR (measured) = 7.27 W/kg

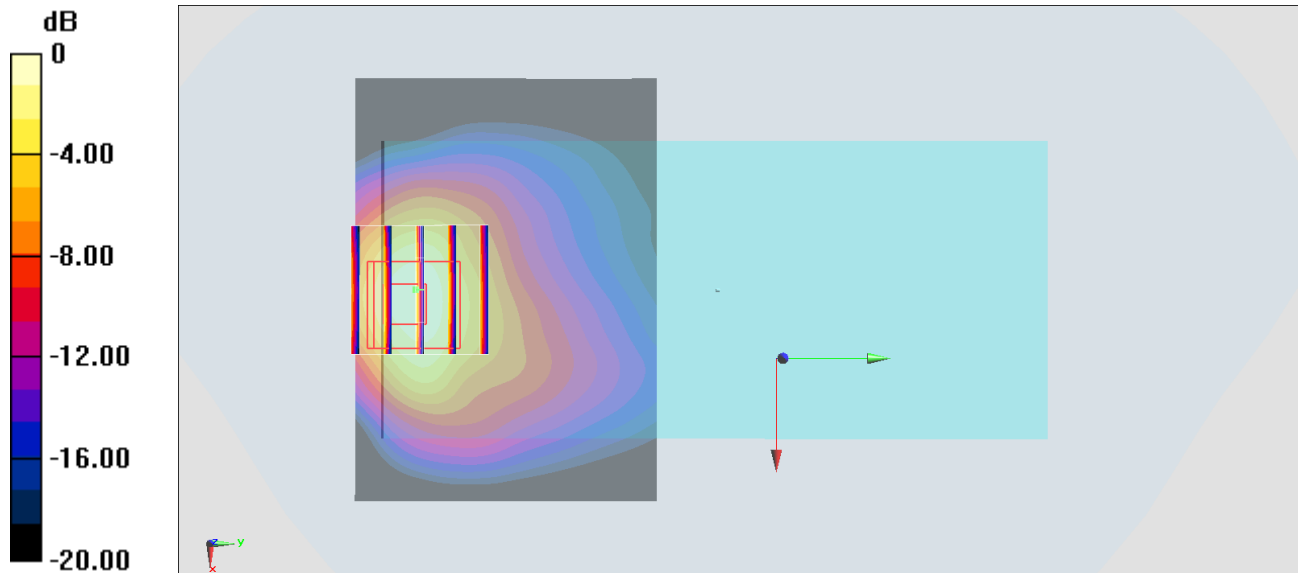

0 dB = 7.27 W/kg = 8.62 dBW/kg

#45_WCDMA IV_RMC 12.2Kbps_Back_0mm_Ch1312

Communication System: WCDMA; Frequency: 1712.4 MHz; Duty Cycle: 1:1

Medium: HSL_1750_200415 Medium parameters used : $f = 1712.4$ MHz; $\sigma = 1.3$ S/m; $\epsilon_r = 39.822$; $\rho = 1000$ kg/m³

Ambient Temperature : 23.5 °C; Liquid Temperature : 22.5 °C

DASY5 Configuration:

- Probe: ES3DV3 - SN3270; ConvF(5.41, 5.41, 5.41) @ 1712.4 MHz; Calibrated: 2019/9/25
- Sensor-Surface: 3mm (Mechanical Surface Detection)
- Electronics: DAE4 Sn778; Calibrated: 2019/5/21
- Phantom: SAM_Left; Type: QD000P40CD; Serial: TP:1801
- Measurement SW: DASY52, Version 52.10 (4); SEMCAD X Version 14.6.14 (7483)

Area Scan (71x51x1): Interpolated grid: dx=1.500 mm, dy=1.500 mm

Maximum value of SAR (interpolated) = 6.65 W/kg

Zoom Scan (5x5x7)/Cube 0: Measurement grid: dx=8mm, dy=8mm, dz=5mm

Reference Value = 57.32 V/m; Power Drift = -0.09 dB

Peak SAR (extrapolated) = 12.0 W/kg

SAR(1 g) = 5.62 W/kg; SAR(10 g) = 2.61 W/kg

Maximum value of SAR (measured) = 7.03 W/kg

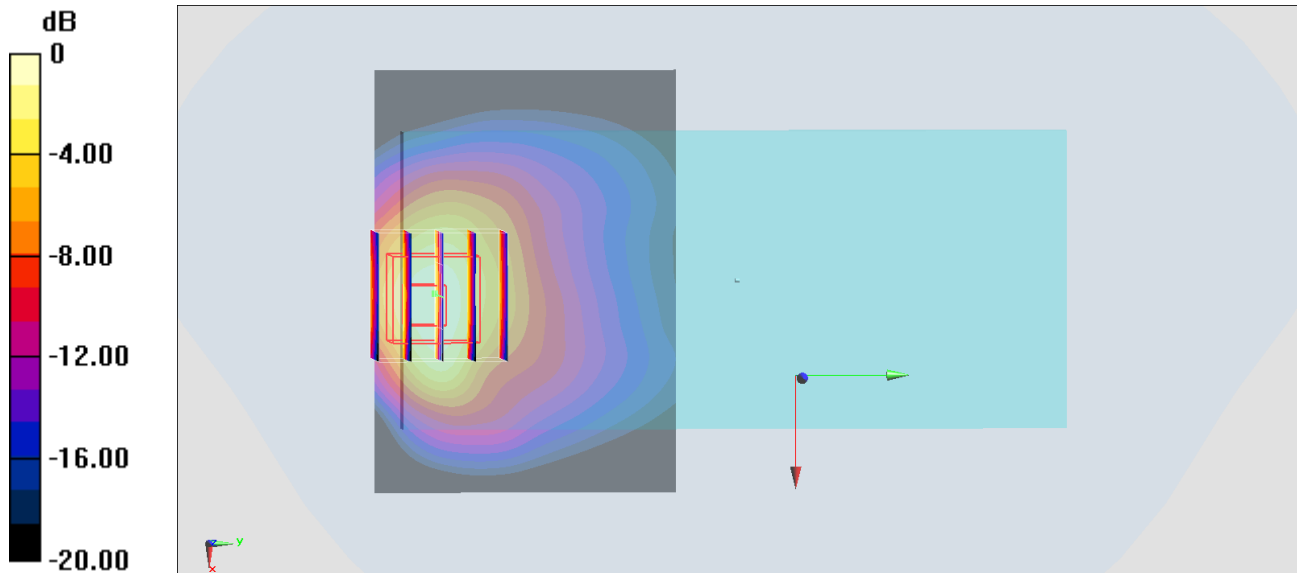

0 dB = 7.03 W/kg = 8.47 dBW/kg

#46_WCDMA V_RMC 12.2Kbps_Back_0mm_Ch4182

Communication System:WCDMA; Frequency: 836.4 MHz;Duty Cycle: 1:1

Medium: HSL_850_200415 Medium parameters used: $f = 836.4$ MHz; $\sigma = 0.877$ S/m; $\epsilon_r = 41.436$; $\rho = 1000$ kg/m³

Ambient Temperature : 23.6°C; Liquid Temperature : 22.6°C

DASY5 Configuration:

- Probe: ES3DV3 - SN3270;ConvF(6.43, 6.43, 6.43) @ 836.4 MHz;Calibrated: 2019/9/25
- Sensor-Surface: 3mm (Mechanical Surface Detection)
- Electronics: DAE4 Sn778; Calibrated: 2019/5/21
- Phantom: SAM_Left; Type: QD000P40CD; Serial: TP:1801
- Measurement SW: DASY52, Version 52.10 (4);SEMCAD X Version 14.6.14 (7483)

Area Scan (71x51x1): Interpolated grid: dx=1.500 mm, dy=1.500 mm

Maximum value of SAR (interpolated) = 4.61 W/kg

Zoom Scan (5x5x7)/Cube 0: Measurement grid: dx=8mm, dy=8mm, dz=5mm

Reference Value = 48.13 V/m; Power Drift = -0.09 dB

Peak SAR (extrapolated) = 6.59 W/kg

SAR(1 g) = 2.63 W/kg; SAR(10 g) = 1.36 W/kg

Maximum value of SAR (measured) = 2.98 W/kg

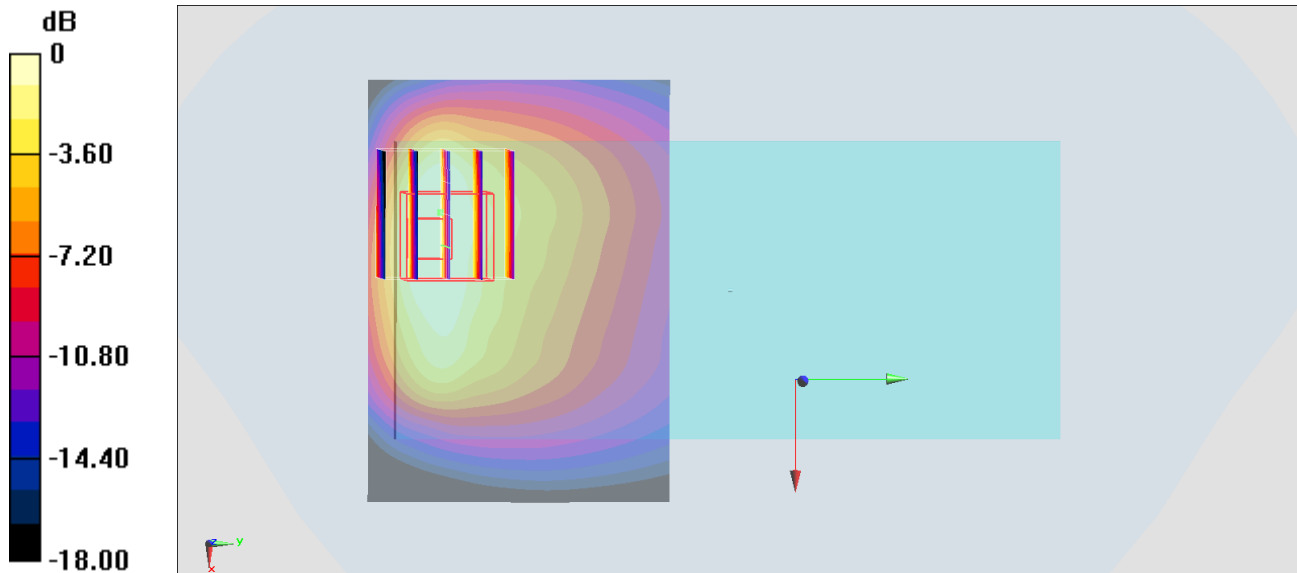

0 dB = 2.98 W/kg = 4.74 dBW/kg

#47_LTE Band 2_20M_QPSK_1_0_Back_0mm_Ch18900

Communication System: LTE; Frequency: 1880 MHz; Duty Cycle: 1:1

Medium: HSL_1900_200414 Medium parameters used: $f = 1880$ MHz; $\sigma = 1.368$ S/m; $\epsilon_r = 40.776$; $\rho = 1000$ kg/m³

Ambient Temperature : 23.5 °C ; Liquid Temperature : 22.5 °C

DASY5 Configuration:

- Probe: EX3DV4 - SN3728; ConvF(7.82, 7.82, 7.82) @ 1880 MHz; Calibrated: 2020/2/4
- Sensor-Surface: 1.4mm (Mechanical Surface Detection)
- Electronics: DAE3 Sn495; Calibrated: 2019/5/21
- Phantom: SAM_Left; Type: QD000P40CD; Serial: TP:1801
- Measurement SW: DASY52, Version 52.10 (4); SEMCAD X Version 14.6.14 (7483)

Area Scan (61x51x1): Interpolated grid: dx=1.500 mm, dy=1.500 mm

Maximum value of SAR (interpolated) = 13.0 W/kg

Zoom Scan (5x5x7)/Cube 0: Measurement grid: dx=8mm, dy=8mm, dz=5mm

Reference Value = 58.49 V/m; Power Drift = -0.15 dB

Peak SAR (extrapolated) = 13.1 W/kg

SAR(1 g) = 6.2 W/kg; SAR(10 g) = 2.92 W/kg

Maximum value of SAR (measured) = 10.1 W/kg

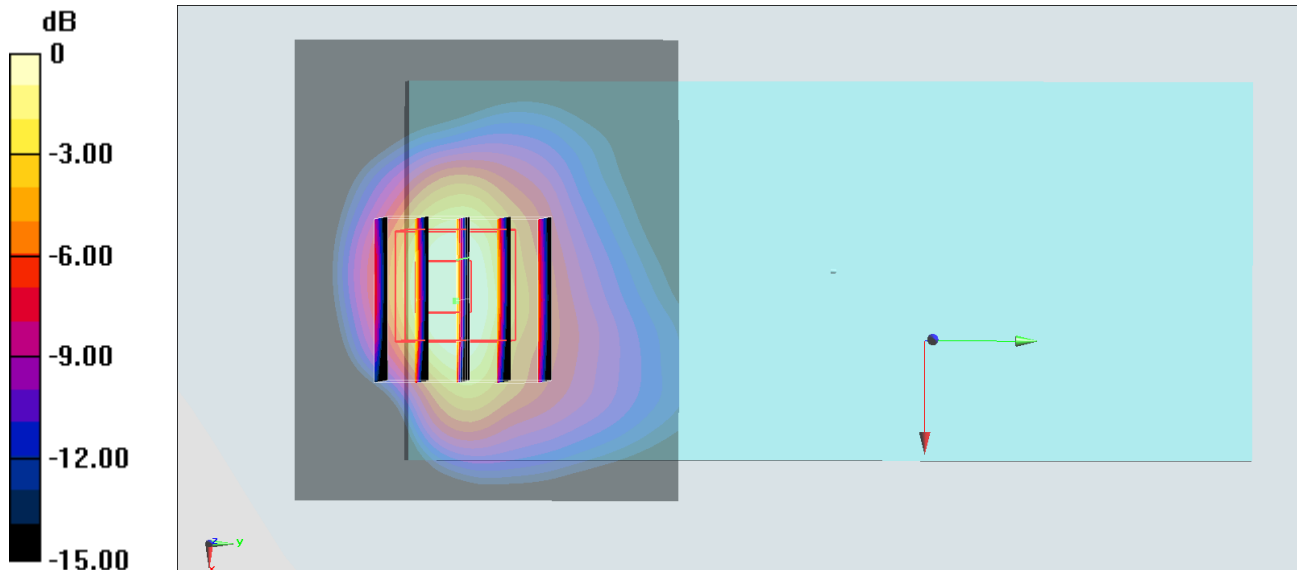

0 dB = 10.1 W/kg = 10.04 dBW/kg

#48_LTE Band 5_10M_QPSK_1_0_Back_0mm_Ch20525

Communication System: LTE; Frequency: 836.5 MHz; Duty Cycle: 1:1

Medium: HSL_850_200415 Medium parameters used : $f = 836.5$ MHz; $\sigma = 0.877$ S/m; $\epsilon_r = 41.435$; $\rho = 1000$ kg/m³

Ambient Temperature : 23.5 °C; Liquid Temperature : 22.5 °C

DASY5 Configuration:

- Probe: ES3DV3 - SN3270; ConvF(6.43, 6.43, 6.43) @ 836.5 MHz; Calibrated: 2019/9/25
- Sensor-Surface: 3mm (Mechanical Surface Detection)
- Electronics: DAE4 Sn778; Calibrated: 2019/5/21
- Phantom: SAM_Left; Type: QD000P40CD; Serial: TP:1801
- Measurement SW: DASY52, Version 52.10 (4); SEMCAD X Version 14.6.14 (7483)

Area Scan (71x51x1): Interpolated grid: dx=1.500 mm, dy=1.500 mm

Maximum value of SAR (interpolated) = 2.40 W/kg

Zoom Scan (5x5x7)/Cube 0: Measurement grid: dx=8mm, dy=8mm, dz=5mm

Reference Value = 39.88 V/m; Power Drift = 0.03 dB

Peak SAR (extrapolated) = 3.73 W/kg

SAR(1 g) = 1.4 W/kg; SAR(10 g) = 0.738 W/kg

Maximum value of SAR (measured) = 2.60 W/kg

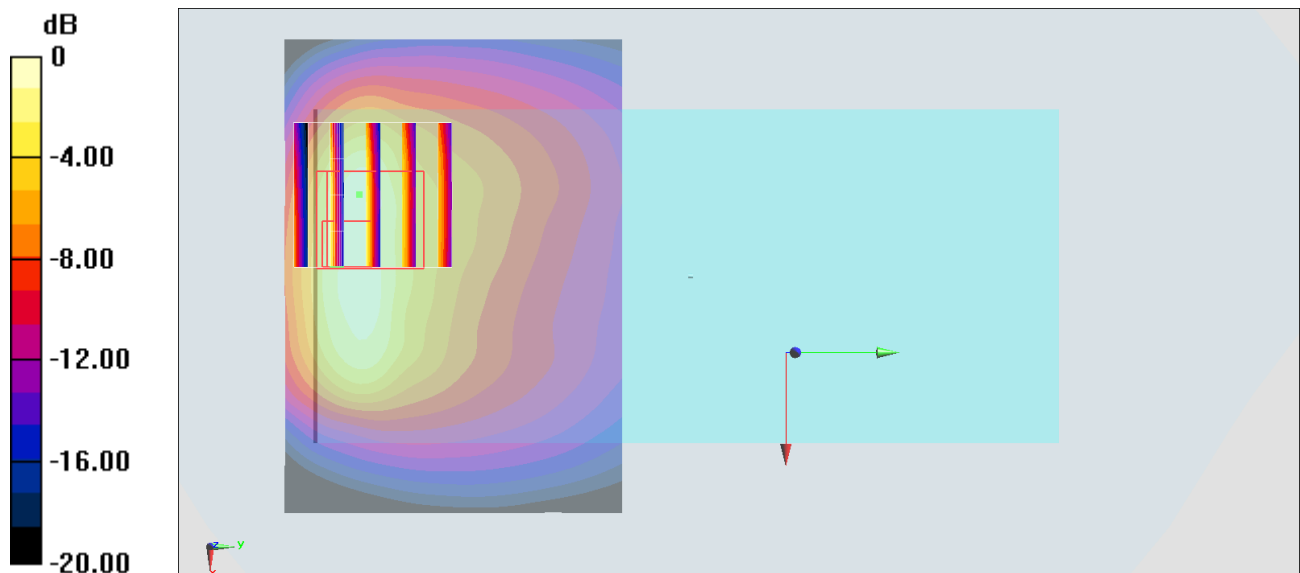

0 dB = 2.60 W/kg = 4.15 dBW/kg

#49_LTE Band 7_20M_QPSK_1_0_Back_0mm_Ch21350

Communication System: LTE; Frequency: 2560 MHz; Duty Cycle: 1:1

Medium: HSL_2600_200415 Medium parameters used: $f = 2560$ MHz; $\sigma = 1.896$ S/m; $\epsilon_r = 38.124$; $\rho = 1000$ kg/m³

Ambient Temperature : 23.5 °C ; Liquid Temperature : 22.5 °C

DASY5 Configuration:

- Probe: ES3DV3 - SN3270; ConvF(4.51, 4.51, 4.51) @ 2560 MHz; Calibrated: 2019/9/25
- Sensor-Surface: 3mm (Mechanical Surface Detection)
- Electronics: DAE4 Sn778; Calibrated: 2019/5/21
- Phantom: SAM_Left; Type: QD000P40CD; Serial: TP:1801
- Measurement SW: DASY52, Version 52.10 (4); SEMCAD X Version 14.6.14 (7483)

Area Scan (91x61x1): Interpolated grid: dx=1.200 mm, dy=1.200 mm

Maximum value of SAR (interpolated) = 8.70 W/kg

Zoom Scan (7x7x7)/Cube 0: Measurement grid: dx=5mm, dy=5mm, dz=5mm

Reference Value = 23.28 V/m; Power Drift = -0.11 dB

Peak SAR (extrapolated) = 21.2 W/kg

SAR(1 g) = 8.01 W/kg; SAR(10 g) = 2.81 W/kg

Maximum value of SAR (measured) = 11.7 W/kg

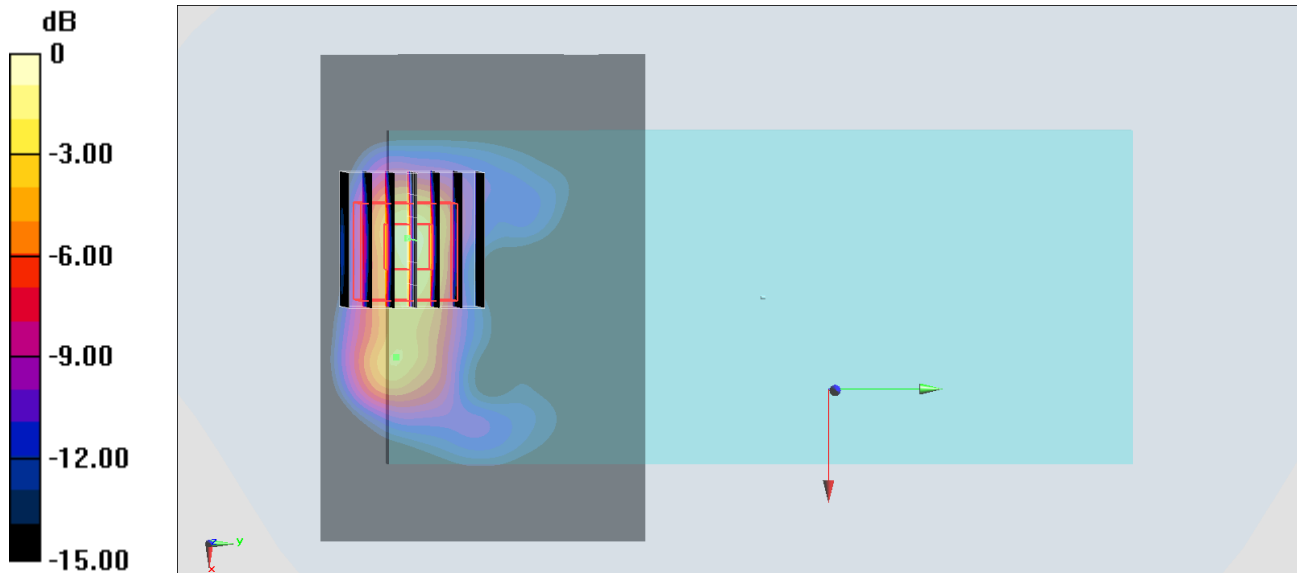

0 dB = 11.7 W/kg = 10.68 dBW/kg

#50_LTE Band 66_20M_QPSK_1_0_Back_0mm_Ch132572

Communication System: LTE; Frequency: 1770 MHz; Duty Cycle: 1:1

Medium: HSL_1750_200415 Medium parameters used: $f = 1770$ MHz; $\sigma = 1.354$ S/m; $\epsilon_r = 39.685$; $\rho = 1000$ kg/m³

Ambient Temperature : 23.5 °C ; Liquid Temperature : 22.5 °C

DASY5 Configuration:

- Probe: ES3DV3 - SN3270; ConvF(5.41, 5.41, 5.41) @ 1770 MHz; Calibrated: 2019/9/25
- Sensor-Surface: 3mm (Mechanical Surface Detection)
- Electronics: DAE4 Sn778; Calibrated: 2019/5/21
- Phantom: SAM_Left; Type: QD000P40CD; Serial: TP:1801
- Measurement SW: DASY52, Version 52.10 (4); SEMCAD X Version 14.6.14 (7483)

Area Scan (91x61x1): Interpolated grid: dx=1.200 mm, dy=1.200 mm

Maximum value of SAR (interpolated) = 7.29 W/kg

Zoom Scan (7x7x7)/Cube 0: Measurement grid: dx=5mm, dy=5mm, dz=5mm

Reference Value = 56.35 V/m; Power Drift = -0.19 dB

Peak SAR (extrapolated) = 13.8 W/kg

SAR(1 g) = 5.05 W/kg; SAR(10 g) = 2.46 W/kg

Maximum value of SAR (measured) = 6.50 W/kg

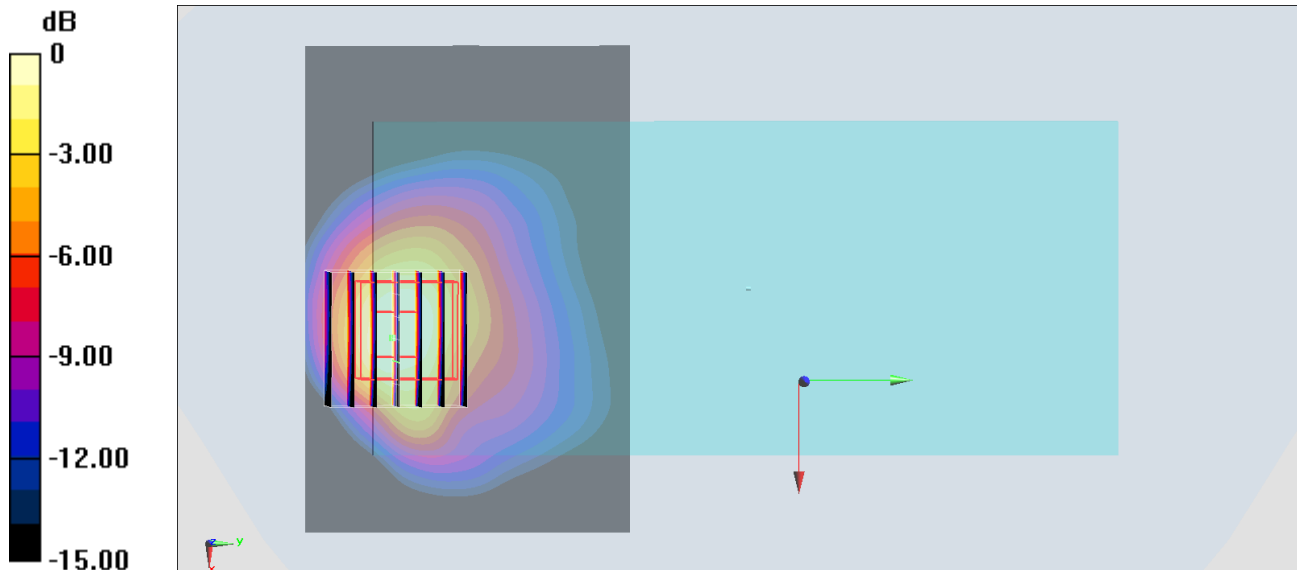

0 dB = 6.50 W/kg = 8.13 dBW/kg

#51_WLAN2.4GHz_802.11b 1Mbps_Back_0mm_Ch11

Communication System: 802.11b ; Frequency: 2462 MHz; Duty Cycle: 1:1

Medium: HSL2450_200416 Medium parameters used: $f = 2462$ MHz; $\sigma = 1.827$ S/m; $\epsilon_r = 39.061$; $\rho = 1000$ kg/m³

Ambient Temperature : 23.6 °C ; Liquid Temperature : 22.6 °C

DASY5 Configuration:

- Probe: EX3DV4 - SN7306; ConvF(7.48, 7.48, 7.48) @ 2462 MHz; Calibrated: 2019/7/22
- Sensor-Surface: 1.4mm (Mechanical Surface Detection)
- Electronics: DAE3 Sn577; Calibrated: 2019/9/17
- Phantom: SAM_Left; Type: QD000P40CD; Serial: TP:1801
- Measurement SW: DASY52, Version 52.10 (4); SEMCAD X Version 14.6.14 (7483)

Area Scan (91x61x1): Interpolated grid: dx=1.200 mm, dy=1.200 mm

Maximum value of SAR (interpolated) = 3.50 W/kg

Zoom Scan (7x7x7)/Cube 0: Measurement grid: dx=5mm, dy=5mm, dz=5mm

Reference Value = 30.71 V/m; Power Drift = 0.07 dB

Peak SAR (extrapolated) = 6.93 W/kg

SAR(1 g) = 2.59 W/kg; SAR(10 g) = 1.07 W/kg

Maximum value of SAR (measured) = 3.41 W/kg

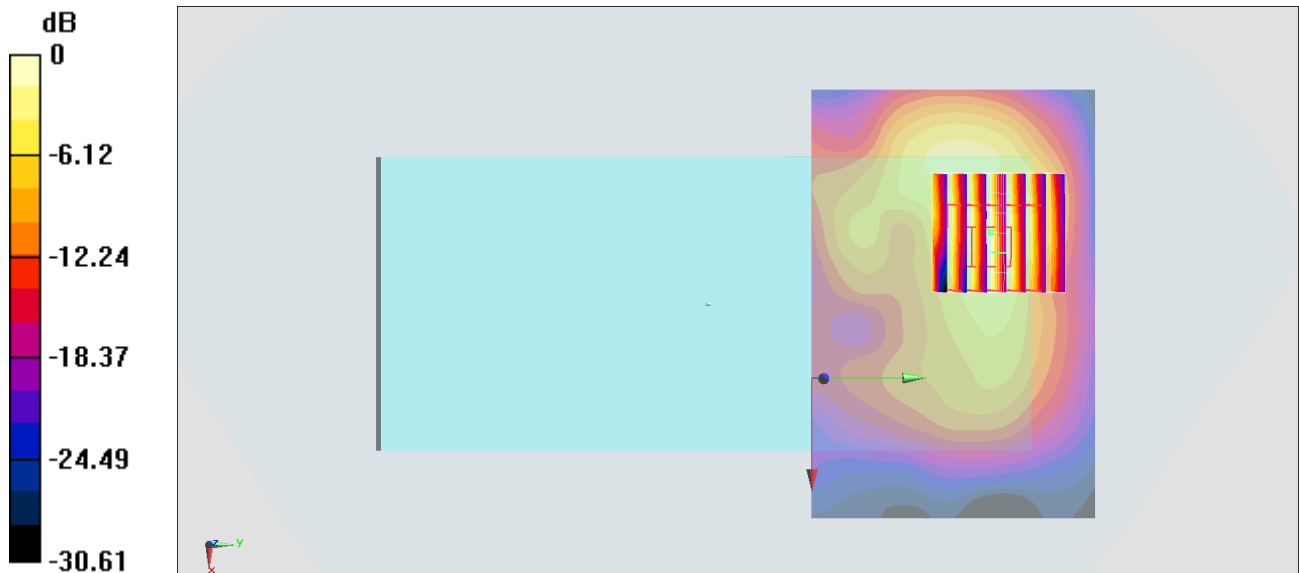

0 dB = 3.41 W/kg = 5.33 dBW/kg

#52_WLAN5GHz_8802.11a 6Mbps_Back_0mm_Ch60

Communication System: 802.11a ; Frequency: 5300 MHz; Duty Cycle: 1:1.017

Medium: HSL_5G_200417 Medium parameters used: $f = 5300$ MHz; $\sigma = 4.636$ S/m; $\epsilon_r = 36.88$; $\rho = 1000$ kg/m³

Ambient Temperature : 23.5 °C ; Liquid Temperature : 22.5 °C

DASY5 Configuration:

- Probe: EX3DV4 - SN7306; ConvF(5.34, 5.34, 5.34) @ 5300 MHz; Calibrated: 2019/7/22
- Sensor-Surface: 1.4mm (Mechanical Surface Detection)
- Electronics: DAE3 Sn577; Calibrated: 2019/9/17
- Phantom: SAM_Left; Type: QD000P40CD; Serial: TP:1801
- Measurement SW: DASY52, Version 52.10 (4); SEMCAD X Version 14.6.14 (7483)

Area Scan (101x71x1): Interpolated grid: dx=1.000 mm, dy=1.000 mm

Maximum value of SAR (interpolated) = 6.74 W/kg

Zoom Scan (9x9x7)/Cube 0: Measurement grid: dx=4mm, dy=4mm, dz=1.4mm

Reference Value = 18.41 V/m; Power Drift = -0.08 dB

Peak SAR (extrapolated) = 14.5 W/kg

SAR(1 g) = 3.11 W/kg; SAR(10 g) = 0.958 W/kg

Maximum value of SAR (measured) = 8.23 W/kg

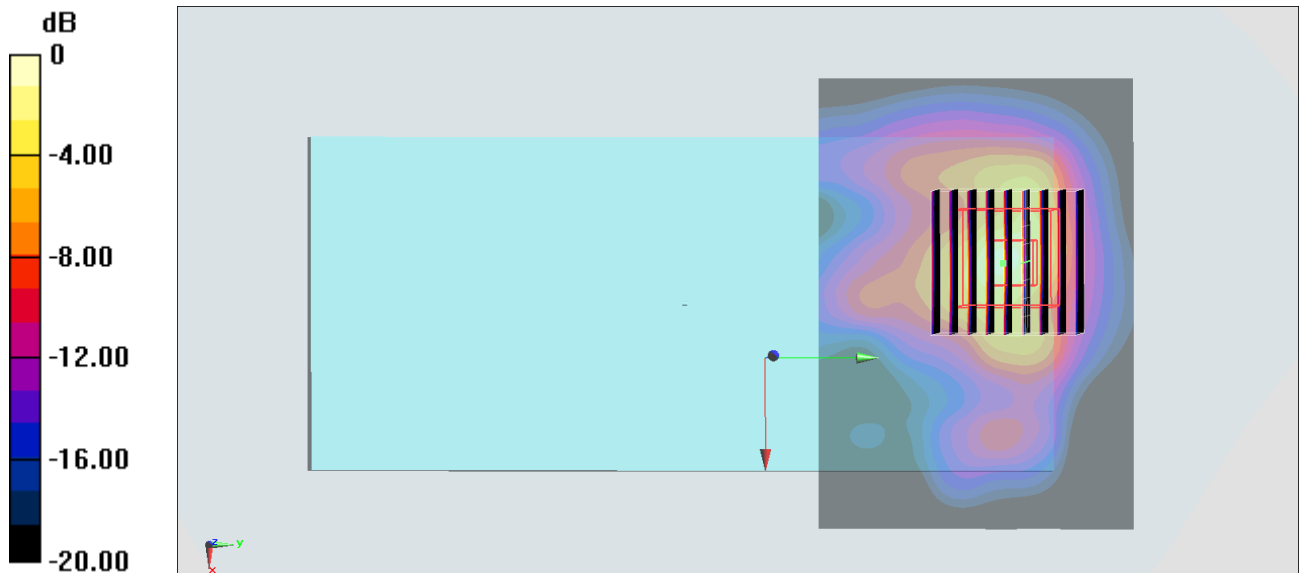

0 dB = 8.23 W/kg = 9.15 dBW/kg

#53_WLAN5GHz_802.11a_6Mbps_Back_0mm_Ch132

Communication System: 802.11a ; Frequency: 5660 MHz;Duty Cycle: 1:1.017

Medium: HSL_5G_200417 Medium parameters used: $f = 5660$ MHz; $\sigma = 5.149$ S/m; $\epsilon_r = 36.184$; $\rho = 1000$ kg/m³

Ambient Temperature : 23.5 °C ; Liquid Temperature : 22.5 °C

DASY5 Configuration:

- Probe: EX3DV4 - SN7306;ConvF(4.79, 4.79, 4.79) @ 5660 MHz;Calibrated: 2019/7/22
- Sensor-Surface: 1.4mm (Mechanical Surface Detection)
- Electronics: DAE3 Sn577; Calibrated: 2019/9/17
- Phantom: SAM_Left; Type: QD000P40CD; Serial: TP:1801
- Measurement SW: DASY52, Version 52.10 (4);SEMCAD X Version 14.6.14 (7483)

Area Scan (101x71x1): Interpolated grid: dx=1.000 mm, dy=1.000 mm

Maximum value of SAR (interpolated) = 7.04 W/kg

Zoom Scan (9x9x7)/Cube 0: Measurement grid: dx=4mm, dy=4mm, dz=1.4mm

Reference Value = 17.21 V/m; Power Drift = -0.11 dB

Peak SAR (extrapolated) = 17.5 W/kg

SAR(1 g) = 3.18 W/kg; SAR(10 g) = 0.945 W/kg

Maximum value of SAR (measured) = 9.36 W/kg

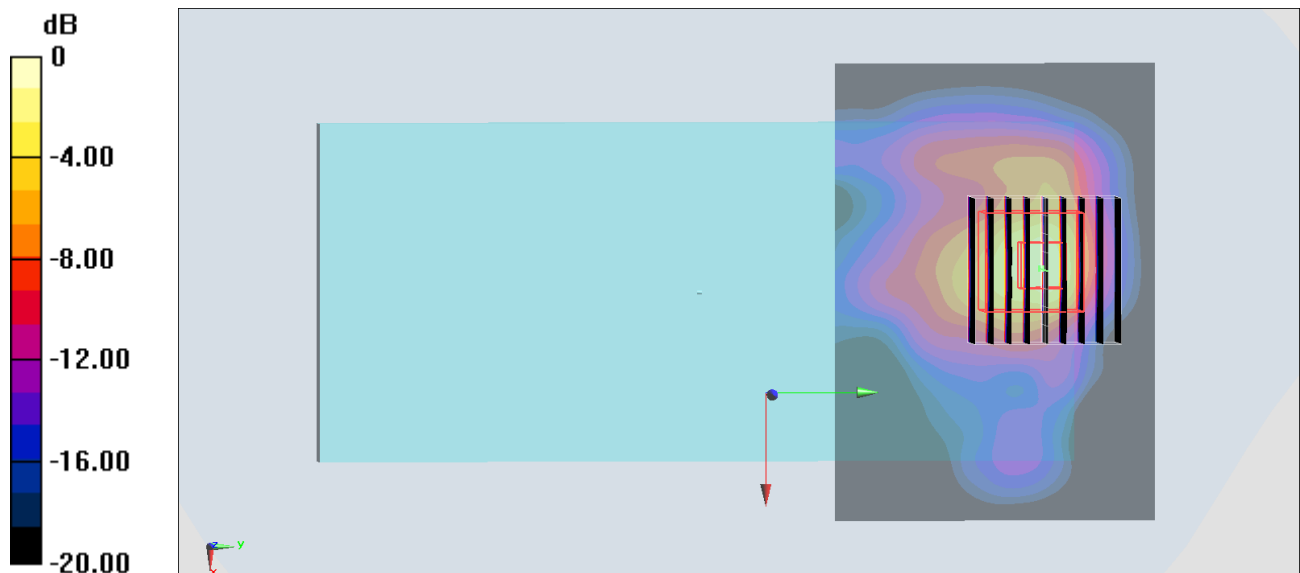

0 dB = 9.36 W/kg = 9.71 dBW/kg

#54_WLAN5GHz_802.11a_6Mbps_Back_0mm_Ch165

Communication System: 802.11a ; Frequency: 5825 MHz; Duty Cycle: 1:1.017

Medium: HSL_5G_200417 Medium parameters used: $f = 5825$ MHz; $\sigma = 5.081$ S/m; $\epsilon_r = 36.074$; $\rho = 1000$ kg/m³

Ambient Temperature : 23.5 °C ; Liquid Temperature : 22.5 °C

DASY5 Configuration:

- Probe: EX3DV4 - SN7306; ConvF(4.93, 4.93, 4.93) @ 5825 MHz; Calibrated: 2019/7/22
- Sensor-Surface: 1.4mm (Mechanical Surface Detection)
- Electronics: DAE3 Sn577; Calibrated: 2019/9/17
- Phantom: SAM_Left; Type: QD000P40CD; Serial: TP:1801
- Measurement SW: DASY52, Version 52.10 (4); SEMCAD X Version 14.6.14 (7483)

Area Scan (101x71x1): Interpolated grid: dx=1.000 mm, dy=1.000 mm

Maximum value of SAR (interpolated) = 7.42 W/kg

Zoom Scan (9x9x7)/Cube 0: Measurement grid: dx=4mm, dy=4mm, dz=1.4mm

Reference Value = 21.46 V/m; Power Drift = -0.04 dB

Peak SAR (extrapolated) = 20.3 W/kg

SAR(1 g) = 3.52 W/kg; SAR(10 g) = 1.1 W/kg

Maximum value of SAR (measured) = 10.7 W/kg

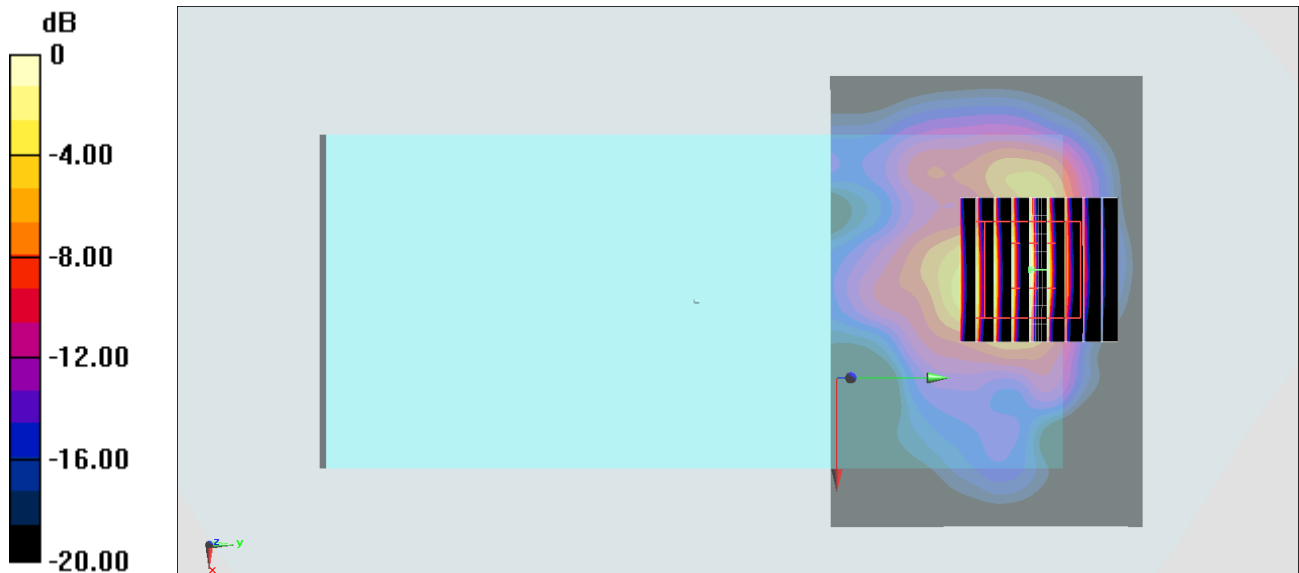

0 dB = 10.7 W/kg = 10.29 dBW/kg