



FCC RF Test Report

APPLICANT : Motorola Mobility LLC
EQUIPMENT : Mobile Cellular Phone
BRAND NAME : Motorola
MODEL NAME : XT2067-2
FCC ID : IHDT56YR2
STANDARD : 47 CFR Part 2, 22(H), 24(E), 27(L), 27(M)
CLASSIFICATION : PCS Licensed Transmitter Held to Ear (PCE)

The product was received on Jan. 18, 2020 and completely tested on Mar. 23, 2020. We, Sporton International (Kunshan) Inc., would like to declare that the tested sample has been evaluated in accordance with the procedures given in ANSI C63.26-2015 and shown compliance with the applicable technical standards.

The test results in this report apply exclusively to the tested model / sample. Without written approval of Sporton International (Kunshan) Inc., the test report shall not be reproduced except in full.

Jason Jia

Reviewed by: Jason Jia / Supervisor

James Huang

Approved by: James Huang / Manager



Sporton International (Kunshan) Inc.

No. 1098, Pengxi North Road, Kunshan Economic Development Zone Jiangsu Province 215300
People's Republic of China



TABLE OF CONTENTS

REVISION HISTORY...3
SUMMARY OF TEST RESULT...4
1 GENERAL DESCRIPTION...5
1.1 Applicant...5
1.2 Manufacturer...5
1.3 Product Feature of Equipment Under Test...5
1.4 Product Specification of Equipment Under Test...6
1.5 Modification of EUT...6
1.6 Re-use of Measured Data...7
1.7 Maximum EIRP, Frequency Tolerance, and Emission Designator...8
1.8 Testing Location...10
1.9 Test Software...10
1.10 Applicable Standards...10
2 TEST CONFIGURATION OF EQUIPMENT UNDER TEST...11
2.1 Test Mode...11
2.2 Connection Diagram of Test System...12
2.3 Support Unit used in test configuration and system...12
2.4 Measurement Results Explanation Example...12
2.5 Frequency List of Low/Middle/High Channels...13
3 CONDUCTED TEST ITEMS...14
3.1 Measuring Instruments...14
3.2 Test Setup...14
3.3 Test Result of Conducted Test...14
3.4 Conducted Output Power and EIRP...15
3.5 Peak-to-Average Ratio...16
3.6 Occupied Bandwidth...17
3.7 Conducted Band Edge...18
3.8 Conducted Spurious Emission...19
3.9 Frequency Stability...20
4 RADIATED TEST ITEMS...21
4.1 Measuring Instruments...21
4.2 Test Setup...21
4.3 Test Result of Radiated Test...21
4.4 Radiated Spurious Emission...22
5 LIST OF MEASURING EQUIPMENT...23
6 UNCERTAINTY OF EVALUATION...24
APPENDIX A. TEST RESULTS OF CONDUCTED TEST
APPENDIX B. TEST RESULTS OF RADIATED TEST
APPENDIX C. TEST SETUP PHOTOGRAPHS
APPENDIX D. REFERENCE REPORT



SUMMARY OF TEST RESULT

Report Section	FCC Rule	Description	Limit	Result	Remark
3.4	§2.1046	Conducted Output Power	Reporting Only	PASS	-
	§27.50(d)(4)	Equivalent Isotropic Radiated Power (Band 4) (Band 66)	EIRP < 1Watt	PASS	-
3.5	N/A	Peak-to-Average Ratio	<13 dB	PASS	-
3.6	§2.1049	Occupied Bandwidth	Reporting Only	PASS	-
3.7	§2.1051 §27.53(h)	Conducted Band Edge Measurement (Band 4) (Band 66)	< 43+10log ₁₀ (P[Watts])	PASS	-
3.8	§2.1051 §27.53(h)	Conducted Spurious Emission (Band 4) (Band 66)	< 43+10log ₁₀ (P[Watts])	PASS	-
3.9	§2.1055 §27.54	Frequency Stability Temperature & Voltage	Within Authorized Band	PASS	-
4.4	§2.1053 §27.53(h)	Radiated Spurious Emission (Band 4) (Band 66)	< 43+10log ₁₀ (P[Watts])	PASS	Under limit 35.95 dB at 6948.000 MHz

Declaration of Conformity:

The test results with all measurement uncertainty excluded are presented in accordance with the regulation limits or requirements declared by manufacturers.

Comments and Explanations:

The declared of product specification for EUT presented in the report are provided by the manufacturer, and the manufacturer takes all the responsibilities for the accuracy of product specification.



1 General Description

1.1 Applicant

Motorola Mobility LLC
222 W,Merchandise Mart Plaza, Chicago IL 60654 USA

1.2 Manufacturer

Motorola Mobility LLC
222 W,Merchandise Mart Plaza, Chicago IL 60654 USA

1.3 Product Feature of Equipment Under Test

Product Feature	
Equipment	Mobile Cellular Phone
Brand Name	Motorola
Model Name	XT2067-2
FCC ID	IHDT56YR2
EUT supports Radios application	GSM/WCDMA/LTE WLAN 2.4GHz 802.11b/g/n HT20 WLAN 5GHz 802.11a/n (HT20/HT40) WLAN 5GHz 802.11ac (VHT20/VHT40/VHT80) Bluetooth BR/EDR/LE FM Receiver and GNSS
IMEI Code	Conducted: N/A Radiation: 351645110012199/351645110012207
HW Version	DVT2
SW Version	QPI30.56
EUT Stage	Identical Prototype

Note:

1. The above EUT's information was declared by manufacturer. Please refer to the specifications or user's manual for more detailed description.
2. There are two types of EUT, the sample 1 is dual SIM slot and the sample 2 is single SIM slot. According to the difference, we evaluate the sample 1 to perform test.



1.4 Product Specification of Equipment Under Test

Standards-related Product Specification	
Tx Frequency	LTE Band 2 : 1850.7 MHz ~ 1909.3 MHz LTE Band 4 : 1710.7 MHz ~ 1754.3 MHz LTE Band 5 : 824.7 MHz ~ 848.3 MHz LTE Band 7 : 2502.5 MHz ~ 2567.5 MHz LTE Band 66 : 1710.7 MHz ~ 1779.3 MHz
Rx Frequency	LTE Band 2 : 1930.7 MHz ~ 1989.3 MHz LTE Band 4 : 2110.7 MHz ~ 2154.3 MHz LTE Band 5 : 869.7 MHz ~ 893.3 MHz LTE Band 7 : 2622.5MHz ~ 2687.5 MHz LTE Band 66 : 2110.7 MHz~ 2179.3 MHz
Bandwidth	LTE Band 2 : 1.4MHz / 3MHz / 5MHz / 10MHz / 15MHz / 20MHz LTE Band 4 : 1.4MHz / 3MHz / 5MHz / 10MHz / 15MHz / 20MHz LTE Band 5 : 1.4MHz / 3MHz / 5MHz / 10MHz LTE Band 7 : 5MHz/ 10MHz / 15MHz / 20MH LTE Band 66 : 1.4MHz / 3MHz / 5MHz / 10MHz / 15MHz / 20MHz
Maximum Output Power to Antenna	LTE Band 4 : 22.76 dBm LTE Band 66 : 22.77 dBm
Antenna Gain	LTE Band 4 : -4.5 dBi LTE Band 66 : -4.5 dBi
Type of Modulation	QPSK / 16QAM / 64QAM

1.5 Modification of EUT

No modifications are made to the EUT during all test items.



1.6 Re-use of Measured Data

1.6.1 Introduction Section

This application re-uses data collected on a similar device. The subject device of this application (Model: XT2067-2, FCC ID: IHDT56YR2) is electrically identical to the reference device (Model: XT2067-1, FCC ID: IHDT56YR1) for the portions of the circuitry corresponding to the data being re-used, as treated by KDB Publication 484596 D01.

1.6.2 Difference Section

For details concerning the similarity with respect to component placement, mechanical/electrical design etc., please refer to the Product Equality Declaration.

The re-used RF data includes the following bands provided in Appendix D (Sporton RF Report No. FG011801B for the reference device Model: XT2067-1, FCC ID: IHDT56YR1).

1.6.3 Reference detail Section:

Equipment Class	Reference FCC ID	Folder Test	Report Title/Section
PCE (LTE)	IHDT56YR1	Part22H.24E.27M (FG011801B)	All sections applicable for LTE Band 2/5/7

1.6.4 Spot Check Verification Data Section

In order to confirm hardware similarity of the subject device with the reference device, spot check measurements were performed on the subject device for the following test items, the test result were consistent with FCC ID: IHDT56YR1.

Assertions concerning the similarity of these devices are based on representations by the applicant. The applicant accepts full responsibility for the validity of the similarity claim, and for the determination that verification test data are sufficient to support it.

Test Item	Mode	IHDT56YR1 Worst Result	IHDT56YR2 Worst Result	Difference (dB)
Radiated Spurious Emission (dBm)	LTE Band 7	-52.34	-53.49	1.15

Note: The verify data for Part 22H/24E could be referred to FG011801A.



1.7 Maximum EIRP, Frequency Tolerance, and Emission Designator

LTE Band 4		QPSK			16QAM		
BW (MHz)	Frequency Range (MHz)	Emission Designator (99%OBW)	Frequency Tolerance (ppm)	Maximum EIRP(W)	Emission Designator (99%OBW)	Frequency Tolerance (ppm)	Maximum EIRP(W)
1.4	1710.7 ~ 1754.3	1M09G7D	-	0.0652	1M10W7D	-	0.0578
3	1711.5 ~ 1753.5	2M72G7D	-	0.0650	2M72W7D	-	0.0577
5	1712.5 ~ 1752.5	4M50G7D	-	0.0649	4M50W7D	-	0.0574
10	1715.0 ~ 1750.0	9M07G7D	0.0059	0.0656	9M03W7D	-	0.0581
15	1717.5 ~ 1747.5	13M5G7D	-	0.0665	13M5W7D	-	0.0607
20	1720.0 ~ 1745.0	18M4G7D	-	0.0671	18M5W7D	-	0.0601
LTE Band 4		64QAM					
BW (MHz)	Frequency Range (MHz)	Emission Designator (99%OBW)	Frequency Tolerance (ppm)		Maximum EIRP(W)		
1.4	1710.7 ~ 1754.3	1M09W7D	-		0.0458		
3	1711.5 ~ 1753.5	2M73W7D	-		0.0454		
5	1712.5 ~ 1752.5	4M50W7D	-		0.0451		
10	1715.0 ~ 1750.0	9M03W7D	-		0.0456		
15	1717.5 ~ 1747.5	13M5W7D	-		0.0465		
20	1720.0 ~ 1745.0	18M4W7D	-		0.0469		



LTE Band 66		QPSK			16QAM		
BW (MHz)	Frequency Range (MHz)	Emission Designator (99%OBW)	Frequency Tolerance (ppm)	Maximum EIRP(W)	Emission Designator (99%OBW)	Frequency Tolerance (ppm)	Maximum EIRP(W)
1.4	1710.7 ~ 1779.3	1M09G7D	-	0.0652	1M10W7D	-	0.0578
3	1711.5 ~ 1778.5	2M72G7D	-	0.0650	2M72W7D	-	0.0577
5	1712.5 ~ 1777.5	4M50G7D	-	0.0649	4M50W7D	-	0.0574
10	1715.0 ~ 1775.0	9M07G7D	0.0059	0.0656	9M03W7D	-	0.0581
15	1717.5 ~ 1772.5	13M5G7D	-	0.0665	13M5W7D	-	0.0607
20	1720.0 ~ 1770.0	18M4G7D	-	0.0671	18M5W7D	-	0.0601
LTE Band 66		64QAM					
BW (MHz)	Frequency Range (MHz)	Emission Designator (99%OBW)	Frequency Tolerance (ppm)		Maximum EIRP(W)		
1.4	1710.7 ~ 1779.3	1M09W7D	-		0.0458		
3	1711.5 ~ 1778.5	2M73W7D	-		0.0454		
5	1712.5 ~ 1777.5	4M50W7D	-		0.0451		
10	1715.0 ~ 1775.0	9M03W7D	-		0.0456		
15	1717.5 ~ 1772.5	13M5W7D	-		0.0465		
20	1720.0 ~ 1770.0	18M4W7D	-		0.0469		

Note: LTE Band 66 overlaps the entire frequency range of LTE Band 4. Therefore, the test results provided in this report covers Band 66 as well as Band 4.



1.8 Testing Location

Sporton International (Kunshan) Inc. is accredited to ISO/IEC 17025:2017 by American Association for Laboratory Accreditation with Certificate Number 5145.02.

Test Firm	Sporton International (Kunshan) Inc.		
Test Site Location	No. 1098, Pengxi North Road, Kunshan Economic Development Zone Jiangsu Province 215300 People's Republic of China TEL : +86-512-57900158 FAX : +86-512-57900958		
Test Site No.	Sporton Site No.	FCC Designation No.	FCC Test Firm Registration No.
	03CH04-KS TH01-KS	CN1257	314309

1.9 Test Software

Item	Site	Manufacture	Name	Version
1.	03CH04-KS	AUDIX	E3	6.2009-8-24a

1.10 Applicable Standards

According to the specifications of the manufacturer, the EUT must comply with the requirements of the following standards:

- ♦ 47 CFR Part 2, 22(H), 24(E), 27(L), 27(M)
- ♦ ANSI C63.26-2015
- ♦ FCC KDB 971168 D01 Power Meas License Digital Systems v03r01
- ♦ FCC KDB 412172 D01 Determining ERP and EIRP v01r01

Remark:

1. All test items were verified and recorded according to the standards and without any deviation during the test.
2. This EUT has also been tested and complied with the requirements of FCC Part 15, Subpart B, recorded in a separate test report.



2 Test Configuration of Equipment Under Test

2.1 Test Mode

Antenna port conducted and radiated test items listed below are performed according to KDB 971168 D01 Power Meas License Digital Systems v03r01 with maximum output power.

Radiated measurements are performed by rotating the EUT in three different orthogonal test planes to find the maximum emission.

Test Items	Band	Bandwidth (MHz)						Modulation			RB #			Test Channel		
		1.4	3	5	10	15	20	QPSK	16QAM	64QAM	1	Half	Full	L	M	H
Max. Output Power	4	v	v	v	v	v	v	v	v	v	v	v	v	v	v	v
	66	v	v	v	v	v	v	v	v	v	v	v	v	v	v	v
Peak-to-Average Ratio	66						v	v	v	v	v		v	v	v	v
26dB and 99% Bandwidth	66	v	v	v	v	v	v	v	v	v			v	v	v	v
Conducted Band Edge	66	v	v	v	v	v	v	v	v	v	v		v	v		v
Conducted Spurious Emission	66	v	v	v	v	v	v	v	v	v	v			v	v	v
Frequency Stability	66				v			v					v		v	
E.I.R.P	66	v	v	v	v	v	v	v	v	v	v			v	v	v
Radiated Spurious Emission	66	Worst Case												v		
Note	<ol style="list-style-type: none"> The mark "v" means that this configuration is chosen for testing The mark "-" means that this bandwidth is not supported. The device is investigated from 30MHz to 10 times of fundamental signal for radiated spurious emission test under different RB size/offset and modulations in exploratory test. Subsequently, only the worst case emissions are reported. LTE Band 66 overlaps the entire frequency range of LTE Band 4. Therefore, the test results provided in this report covers Band 66 as well as Band 4. 															

2.2 Connection Diagram of Test System

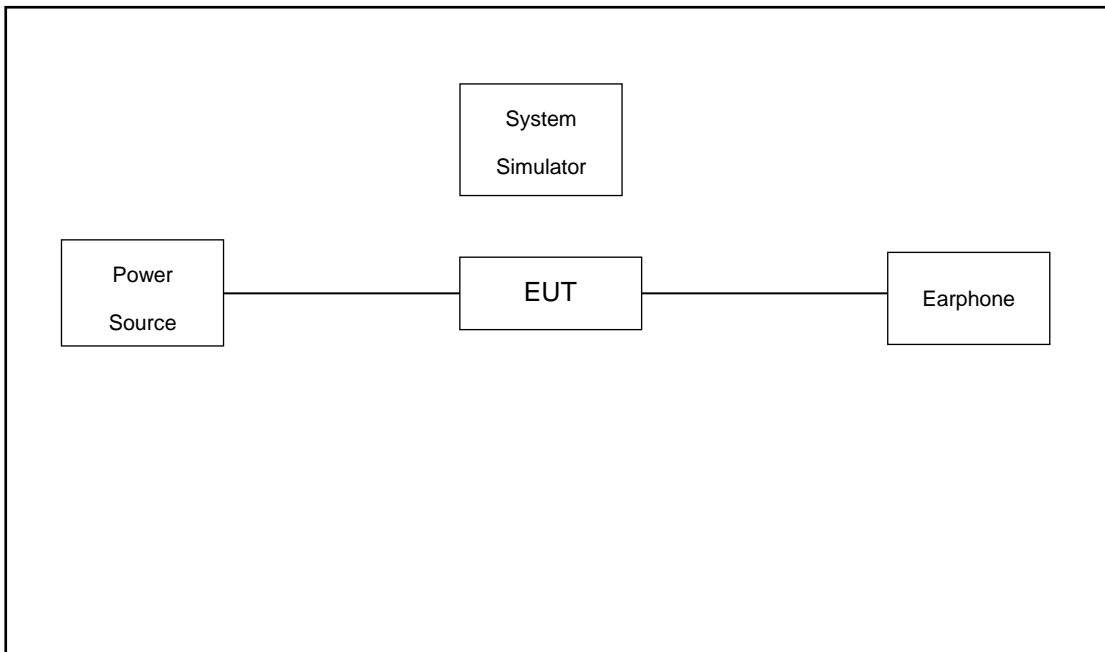

2.3 Support Unit used in test configuration and system

Item	Equipment	Trade Name	Model No.	FCC ID	Data Cable	Power Cord
1.	LTE Base Station	Anritsu	MT8820C	N/A	N/A	Unshielded, 1.8 m
2.	DC Power Supply	GW INSTRON	GPS-3030D	N/A	N/A	Unshielded, 1.8m

2.4 Measurement Results Explanation Example

For all conducted test items:

The offset level is set in the spectrum analyzer to compensate the RF cable loss between EUT conducted output port and spectrum analyzer. With the offset compensation, the spectrum analyzer reading level is exactly the EUT RF output level.

The spectrum analyzer offset is derived from RF cable loss.

Offset = RF cable loss.

Following shows an offset computation example with cable loss 5.4 dB.

Example :

$$\begin{aligned}
 \text{Offset(dB)} &= \text{RF cable loss(dB)}. \\
 &= 5.4 \text{ (dB)}
 \end{aligned}$$



2.5 Frequency List of Low/Middle/High Channels

LTE Band 4 Channel and Frequency List				
BW [MHz]	Channel/Frequency(MHz)	Lowest	Middle	Highest
20	Channel	20050	20175	20300
	Frequency	1720	1732.5	1745
15	Channel	20025	20175	20325
	Frequency	1717.5	1732.5	1747.5
10	Channel	20000	20175	20350
	Frequency	1715	1732.5	1750
5	Channel	19975	20175	20375
	Frequency	1712.5	1732.5	1752.5
3	Channel	19965	20175	20385
	Frequency	1711.5	1732.5	1753.5
1.4	Channel	19957	20175	20393
	Frequency	1710.7	1732.5	1754.3

LTE Band 66 Channel and Frequency List				
BW [MHz]	Channel/Frequency(MHz)	Lowest	Middle	Highest
20	Channel	132072	132322	132572
	Frequency	1720	1745	1770
15	Channel	132047	132322	132597
	Frequency	1717.5	1745	1772.5
10	Channel	132022	132322	132622
	Frequency	1715	1745	1775
5	Channel	131997	132322	132647
	Frequency	1712.5	1745	1777.5
3	Channel	131987	132322	132657
	Frequency	1711.5	1745	1778.5
1.4	Channel	131979	132322	132665
	Frequency	1710.7	1745	1779.3

3 Conducted Test Items

3.1 Measuring Instruments

See list of measuring instruments of this test report.

3.2 Test Setup

3.2.1 Conducted Output Power



3.2.2 Peak-to-Average Ratio, Occupied Bandwidth ,Conducted Band-Edge and Conducted Spurious Emission



3.2.3 Frequency Stability

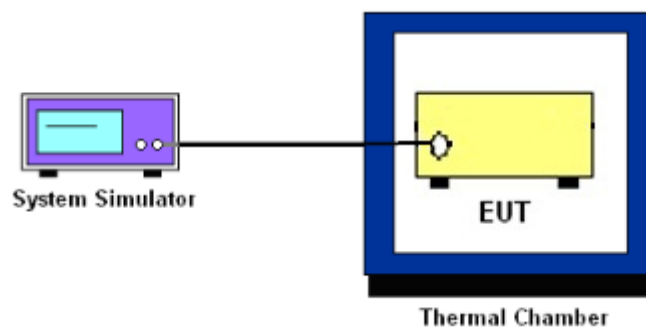

3.3 Test Result of Conducted Test

Please refer to Appendix A.



3.4 Conducted Output Power and EIRP

3.4.1 Description of the Conducted Output Power Measurement and ERP Measurement

A system simulator was used to establish communication with the EUT. Its parameters were set to force the EUT transmitting at maximum output power. The measured power in the radio frequency on the transmitter output terminals shall be reported.

The EIRP of mobile transmitters must not exceed 1 Watts for LTE Band 4 and Band 66.

According to KDB 412172 D01 Power Approach,

$EIRP = P_T + G_T - L_C$, $ERP = EIRP - 2.15$, where

P_T = transmitter output power in dBm

G_T = gain of the transmitting antenna in dBi

L_C = signal attenuation in the connecting cable between the transmitter and antenna in dB

3.4.2 Test Procedures

1. The testing follows ANSI C63.26 Section 5.2
2. The transmitter output port was connected to the system simulator.
3. Set EUT at maximum power through the system simulator.
4. Select lowest, middle, and highest channels for each band and different modulation.
5. Measure and record the power level from the system simulator.



3.5 Peak-to-Average Ratio

3.5.1 Description of the PAR Measurement

Power Complementary Cumulative Distribution Function (CCDF) curves provide a means for characterizing the power peaks of a digitally modulated signal on a statistical basis. A CCDF curve depicts the probability of the peak signal amplitude exceeding the average power level. Most contemporary measurement instrumentation include the capability to produce CCDF curves for an input signal provided that the instrument's resolution bandwidth can be set wide enough to accommodate the entire input signal bandwidth. In measuring transmissions in this band using an average power technique, the peak-to-average ratio (PAR) of the transmission may not exceed 13 dB.

3.5.2 Test Procedures

1. The testing follows ANSI C63.26 Section 5.2.3.4 (CCDF).
2. The EUT was connected to spectrum and system simulator via a power divider.
3. Set the CCDF (Complementary Cumulative Distribution Function) option in spectrum analyzer.
4. The highest RF powers were measured and recorded the maximum PAPR level associated with a probability of 0.1 %.
5. Record the deviation as Peak to Average Ratio.



3.6 Occupied Bandwidth

3.6.1 Description of Occupied Bandwidth Measurement

The occupied bandwidth is the width of a frequency band such that, below the lower and above the upper frequency limits, the mean powers emitted are each equal to a specified percentage 0.5% of the total mean transmitted power.

The 26 dB emission bandwidth is defined as the frequency range between two points, one above and one below the carrier frequency, at which the spectral density of the emission is attenuated 26 dB below the maximum in-band spectral density of the modulated signal. Spectral density (power per unit bandwidth) is to be measured with a detector of resolution bandwidth equal to approximately 1.0% of the emission bandwidth.

3.6.2 Test Procedures

1. The testing follows ANSI C63.26 Section 5.4
2. The EUT was connected to spectrum analyzer and system simulator via a power divider.
3. The spectrum analyzer center frequency is set to the nominal EUT channel center frequency. The span range for the spectrum analyzer shall be between two and five times the anticipated OBW.
4. The nominal resolution bandwidth (RBW) shall be in the range of 1 to 5 % of the anticipated OBW, and the VBW shall be at least 3 times the RBW.
5. Set the detection mode to peak, and the trace mode to max hold.
6. Determine the reference value: Set the EUT to transmit a modulated signal. Allow the trace to stabilize. Set the spectrum analyzer marker to the highest level of the displayed trace.
(this is the reference value)
7. Determine the “-26 dB down amplitude” as equal to (Reference Value – X).
8. Place two markers, one at the lowest and the other at the highest frequency of the envelope of the spectral display such that each marker is at or slightly below the “-X dB down amplitude” determined in step 6. If a marker is below this “-X dB down amplitude” value it shall be placed as close as possible to this value. The OBW is the positive frequency difference between the two markers.
9. Use the 99 % power bandwidth function of the spectrum analyzer and report the measured bandwidth.



3.7 Conducted Band Edge

3.7.1 Description of Conducted Band Edge Measurement

27.53 (h)

For operations in the 1710 – 1755 MHz band, the FCC limit is $43 + 10\log_{10}(P[\text{Watts}])$ dB below the transmitter power $P(\text{Watts})$ in a 1 MHz bandwidth. However, in the 1MHz bands immediately outside and adjacent to the licensee's frequency block, a resolution bandwidth of at least one percent of the emission bandwidth of the fundamental emission of the transmitter may be employed.

3.7.2 Test Procedures

1. The testing follows ANSI C63.26 section 5.7
2. The EUT was connected to spectrum analyzer and system simulator via a power divider.
3. The band edges of low and high channels for the highest RF powers were measured.
4. Set RBW $\geq 1\%$ EBW in the 1MHz band immediately outside and adjacent to the band edge.
5. Beyond the 1 MHz band from the band edge, RBW=1MHz was used or a narrower RBW was used
6. Set spectrum analyzer with RMS detector.
7. The RF fundamental frequency should be excluded against the limit line in the operating frequency band.
8. Checked that all the results comply with the emission limit line.

Example:

$$\begin{aligned} &\text{The limit line is derived from } 43 + 10\log(P)\text{dB below the transmitter power } P(\text{Watts}) \\ &= P(\text{W}) - [43 + 10\log(P)] \text{ (dB)} \\ &= [30 + 10\log(P)] \text{ (dBm)} - [43 + 10\log(P)] \text{ (dB)} = -13\text{dBm}. \end{aligned}$$



3.8 Conducted Spurious Emission

3.8.1 Description of Conducted Spurious Emission Measurement

The power of any emission outside of the authorized operating frequency ranges must be lower than the transmitter power (P) by a factor of at least $43 + 10 \log (P)$ dB.

It is measured by means of a calibrated spectrum analyzer and scanned from 30 MHz up to a frequency including its 10th harmonic.

3.8.2 Test Procedures

1. The testing follows ANSI C63.26 section 5.7
2. The EUT was connected to spectrum analyzer and system simulator via a power divider.
3. The RF output of EUT was connected to the spectrum analyzer by RF cable and attenuator. The path loss was compensated to the results for each measurement.
4. The middle channel for the highest RF power within the transmitting frequency was measured.
5. The conducted spurious emission for the whole frequency range was taken.
6. Make the measurement with the spectrum analyzer's RBW = 1MHz, VBW = 3MHz.
7. Set spectrum analyzer with RMS detector.
8. Taking the record of maximum spurious emission.
9. The RF fundamental frequency should be excluded against the limit line in the operating frequency band.
10. The limit line is derived from $43 + 10\log(P)$ dB below the transmitter power P(Watts)
= P(W)- [43 + 10log(P)] (dB)
= [30 + 10log(P)] (dBm) - [43 + 10log(P)] (dB)
= -13dBm.



3.9 Frequency Stability

3.9.1 Description of Frequency Stability Measurement

The frequency stability shall be measured by variation of ambient temperature and variation of primary supply voltage to ensure that the fundamental emission stays within the authorized frequency block. The frequency stability of the transmitter shall be maintained within $\pm 0.00025\%$ ($\pm 2.5\text{ppm}$) of the center frequency.

3.9.2 Test Procedures for Temperature Variation

1. The testing follows ANSI C63.26 section 5.6.4
2. The EUT was set up in the thermal chamber and connected with the system simulator.
3. With power OFF, the temperature was decreased to -30°C and the EUT was stabilized before testing. Power was applied and the maximum change in frequency was recorded within one minute.
4. With power OFF, the temperature was raised in 10°C step up to 50°C . The EUT was stabilized at each step for at least half an hour. Power was applied and the maximum frequency change was recorded within one minute.

3.9.3 Test Procedures for Voltage Variation

1. The testing follows ANSI C63.26 section 5.6.5
2. The EUT was placed in a temperature chamber at $20\pm 5^{\circ}\text{C}$ and connected with the system simulator.
3. The power supply voltage to the EUT was varied from 85% to 115% of the nominal value for other than hand carried battery equipment.
4. For hand carried, battery powered equipment, reduce the primary ac or dc supply voltage to the battery operating end point, which shall be specified by the manufacturer.
5. The variation in frequency was measured for the worst case.

4 Radiated Test Items

4.1 Measuring Instruments

See list of measuring instruments of this test report.

4.2 Test Setup

4.2.1 For radiated test from 30MHz to 1GHz

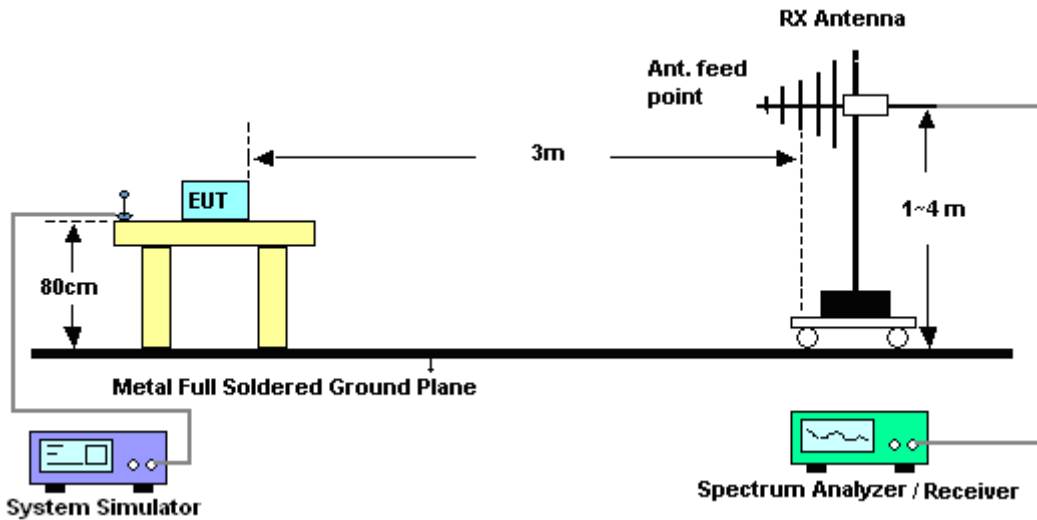

4.2.2 For radiated test above 1GHz

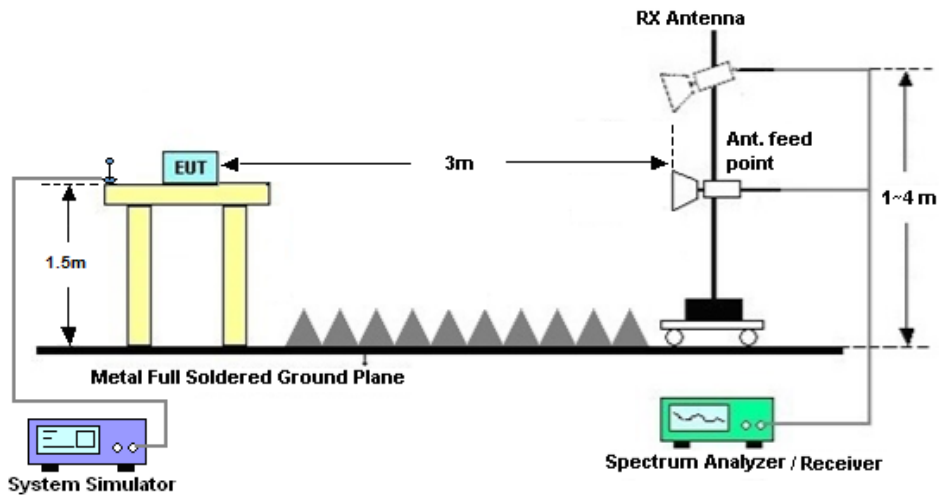

4.3 Test Result of Radiated Test

Please refer to Appendix B.



4.4 Radiated Spurious Emission

4.4.1 Description of Radiated Spurious Emission

The radiated spurious emission was measured by substitution method according to ANSI C63.26. The power of any emission outside of the authorized operating frequency ranges must be attenuated below the transmitter power (P) by a factor of at least $43 + 10 \log(P)$ dB.

The spectrum is scanned from 30 MHz up to a frequency including its 10th harmonic.

4.4.2 Test Procedures

1. The testing follows ANSI C63.26 Section 5.5
2. The EUT was placed on a turntable with 0.8 meter height for frequency below 1GHz and 1.5 meter height for frequency above 1GHz respectively above ground.
3. The EUT was set 3 meters from the receiving antenna mounted on the antenna tower.
4. The table was rotated 360 degrees to determine the position of the highest spurious emission.
5. The height of the receiving antenna is varied between 1m to 4m to search the maximum spurious emission for both horizontal and vertical polarizations.
6. During the measurement, the system simulator parameters were set to force the EUT transmitting at maximum output power.
7. Make the measurement with the spectrum analyzer's RBW = 1MHz, VBW = 3MHz, taking the record of maximum spurious emission.
8. A horn antenna was substituted in place of the EUT and was driven by a signal generator.
9. Tune the output power of signal generator to the same emission level with EUT maximum spurious emission.
10. $EIRP \text{ (dBm)} = S.G. \text{ Power} - Tx \text{ Cable Loss} + Tx \text{ Antenna Gain}$
11. $ERP \text{ (dBm)} = EIRP - 2.15$
12. The RF fundamental frequency should be excluded against the limit line in the operating frequency band.

The limit line is derived from $43 + 10\log(P)$ dB below the transmitter power P(Watts)
= $P(W) - [43 + 10\log(P)] \text{ (dB)}$
= $[30 + 10\log(P)] \text{ (dBm)} - [43 + 10\log(P)] \text{ (dB)}$
= -13dBm.



5 List of Measuring Equipment

Instrument	Manufacturer	Model No.	Serial No.	Characteristics	Calibration Date	Test Date	Due Date	Remark
Spectrum Analyzer	R&S	FSV40	101040	10Hz~40GHz	Aug. 07, 2019	Mar. 13, 2020	Aug. 06, 2020	Conducted (TH01-KS)
Thermal Chamber	Ten Billion	TTC-B3S	TBN-960502	-40~+150°C	Nov. 18, 2019	Mar. 13, 2020	Nov. 17, 2020	Conducted (TH01-KS)
EXA Spectrum Analyzer	Keysight	N9010A	MY55150244	10Hz-44G,MAX 30dB	Apr. 16, 2019	Mar. 23, 2020	Apr. 15, 2020	Radiation (03CH04-KS)
Bilog Antenna	TeseQ	CBL6111D	49922	30MHz-1GHz	May 30, 2019	Mar. 23, 2020	May 29, 2020	Radiation (03CH04-KS)
Horn Antenna	Schwarzbeck	BBHA9120D	1356	1GHz~18GHz	Apr. 21, 2019	Mar. 23, 2020	Apr. 20, 2020	Radiation (03CH04-KS)
SHF-EHF Horn	Com-power	AH-840	101115	18GHz~40GHz	Nov. 10, 2019	Mar. 23, 2020	Nov. 09, 2020	Radiation (03CH04-KS)
Amplifier	SONOMA	310N	187289	9KHz-1GHz	Aug. 06, 2019	Mar. 23, 2020	Aug. 05, 2020	Radiation (03CH04-KS)
Amplifier	MITEQ	EM18G40G GA	060728	18~40GHz	Jan. 08, 2020	Mar. 23, 2020	Jan. 07, 2021	Radiation (03CH04-KS)
high gain Amplifier	MITEQ	AMF-7D-00 101800-30-1 0P	2025788	1Ghz-18Ghz	Aug. 16, 2019	Mar. 23, 2020	Aug. 15, 2020	Radiation (03CH04-KS)
Amplifier	Keysight	83017A	MY57280106	500MHz~26.5GHz	Apr. 15, 2019	Mar. 23, 2020	Apr. 14, 2020	Radiation (03CH04-KS)
AC Power Source	Chroma	61601	F104090004	N/A	NCR	Mar. 23, 2020	NCR	Radiation (03CH04-KS)
Turn Table	ChamPro	EM 1000-T	060762-T	0~360 degree	NCR	Mar. 23, 2020	NCR	Radiation (03CH04-KS)
Antenna Mast	ChamPro	EM 1000-A	060762-A	1 m~4 m	NCR	Mar. 23, 2020	NCR	Radiation (03CH04-KS)

NCR: No Calibration Required



6 Uncertainty of Evaluation

The measurement uncertainties shown below were calculated in accordance with the requirements of ANSI 63.26-2015. All the measurement uncertainty value were shown with a coverage K=2 to indicate 95% level of confidence. The measurement data show herein meets or exceeds the CISPR measurement uncertainty values specified in CISPR 16-4-2 and can be compared directly to specified limit to determine compliance.

Uncertainty of Radiated Emission Measurement (30 MHz ~ 1000 MHz)

Measuring Uncertainty for a Level of Confidence of 95% (U = 2Uc(y))	3.3dB
---	-------

Uncertainty of Radiated Emission Measurement (1 GHz ~ 40 GHz)

Measuring Uncertainty for a Level of Confidence of 95% (U = 2Uc(y))	2.8dB
---	-------



Appendix A. Test Results of Conducted Test

Conducted Output Power(Average power)

LTE Band 4 Maximum Average Power [dBm]						
BW [MHz]	RB Size	RB Offset	Mod	Lowest	Middle	Highest
20	1	0	QPSK	22.54	22.76	22.68
20	1	49		22.61	22.70	22.73
20	1	99		22.60	22.55	22.58
20	50	0		21.64	21.69	21.64
20	50	24		21.62	21.69	21.62
20	50	50		21.63	21.60	21.68
20	100	0		21.58	21.65	21.59
20	1	0	16-QAM	22.01	22.11	22.11
20	1	49		22.09	22.18	22.21
20	1	99		22.05	22.05	22.02
20	50	0		20.73	20.82	20.77
20	50	24		20.77	20.78	20.76
20	50	50		20.80	20.74	20.79
20	100	0		20.76	20.78	20.72
20	1	0	64-QAM	21.00	21.12	21.12
20	1	49		21.05	21.14	21.16
20	1	99		21.05	20.95	20.96
20	50	0		19.84	19.92	19.86
20	50	24		19.84	19.87	19.81
20	50	50		19.86	19.82	19.88
20	100	0		19.80	19.86	19.82
15	1	0	QPSK	22.55	22.74	22.66
15	1	37		22.58	22.66	22.67
15	1	74		22.52	22.52	22.59
15	36	0		21.63	21.70	21.61
15	36	20		21.68	21.70	21.76
15	36	39		21.60	21.62	21.69
15	75	0		21.59	21.66	21.61



15	1	0	16-QAM	21.96	22.24	22.09
15	1	37		22.08	22.14	22.12
15	1	74		22.01	22.03	22.04
15	36	0		20.74	20.81	20.78
15	36	20		20.75	20.84	20.87
15	36	39		20.71	20.77	20.79
15	75	0		20.73	20.80	20.72
15	1	0	64-QAM	21.04	21.16	21.13
15	1	37		21.06	21.11	21.15
15	1	74		20.95	21.03	21.04
15	36	0		19.84	19.92	19.85
15	36	20		19.85	19.91	19.97
15	36	39		19.83	19.87	19.87
15	75	0		19.83	19.92	19.82



LTE Band 4 Maximum Average Power [dBm]						
BW [MHz]	RB Size	RB Offset	Mod	Lowest	Middle	Highest
10	1	0	QPSK	22.55	22.72	22.75
10	1	25		22.51	22.70	22.71
10	1	49		22.56	22.58	22.58
10	25	0		21.52	21.70	21.73
10	25	12		21.66	21.67	21.70
10	25	25		21.57	21.61	21.65
10	50	0		21.63	21.65	21.72
10	1	0	16-QAM	22.01	22.21	22.19
10	1	25		21.95	22.17	22.16
10	1	49		22.04	22.07	22.04
10	25	0		20.67	20.81	20.86
10	25	12		20.78	20.83	20.86
10	25	25		20.75	20.77	20.80
10	50	0		20.77	20.79	20.85
10	1	0	64-QAM	20.90	21.15	21.13
10	1	25		20.98	21.13	21.12
10	1	49		20.99	21.01	21.02
10	25	0		19.77	19.91	19.97
10	25	12		19.88	19.91	19.94
10	25	25		19.84	19.86	19.89
10	50	0		19.83	19.89	19.93
5	1	0	QPSK	22.49	22.66	22.69
5	1	12		22.50	22.65	22.65
5	1	24		22.44	22.63	22.59
5	12	0		21.51	21.71	21.69
5	12	7		21.57	21.69	21.71
5	12	13		21.51	21.69	21.69
5	25	0		21.53	21.63	21.67
5	1	0	16-QAM	21.92	22.11	22.11
5	1	12		21.97	22.19	22.04
5	1	24		21.93	22.13	22.10
5	12	0		20.66	20.82	20.85
5	12	7		20.69	20.87	20.87



5	12	13		20.65	20.79	20.84
5	25	0		20.63	20.80	20.82
5	1	0	64-QAM	20.95	21.11	21.07
5	1	12		20.92	21.07	21.08
5	1	24		20.89	21.04	21.01
5	12	0		19.75	19.89	19.91
5	12	7		19.77	19.96	19.93
5	12	13		19.76	19.89	19.91
5	25	0		19.73	19.86	19.90



LTE Band 4 Maximum Average Power [dBm]						
BW [MHz]	RB Size	RB Offset	Mod	Lowest	Middle	Highest
3	1	0	QPSK	22.50	22.62	22.62
3	1	8		22.47	22.64	22.66
3	1	14		22.44	22.63	22.63
3	8	0		21.50	21.66	21.67
3	8	4		21.58	21.68	21.71
3	8	7		21.52	21.68	21.68
3	15	0		21.51	21.65	21.67
3	1	0	16-QAM	21.92	22.11	22.04
3	1	8		21.98	22.12	22.01
3	1	14		21.93	22.08	22.08
3	8	0		20.73	20.87	20.84
3	8	4		20.72	20.88	20.92
3	8	7		20.70	20.84	20.82
3	15	0		20.65	20.80	20.80
3	1	0	64-QAM	20.89	21.05	21.05
3	1	8		20.92	21.08	21.11
3	1	14		20.85	21.08	21.07
3	8	0		19.76	19.94	19.96
3	8	4		19.77	19.95	19.95
3	8	7		19.75	19.89	19.87
3	15	0		19.72	19.89	19.91
1.4	1	0	QPSK	22.41	22.53	22.56
1.4	1	3		22.41	22.68	22.66
1.4	1	5		22.41	22.52	22.55
1.4	3	0		22.46	22.61	22.62
1.4	3	1		22.48	22.64	22.67
1.4	3	3		22.46	22.61	22.63
1.4	6	0		21.44	21.63	21.62
1.4	1	0	16-QAM	21.82	22.05	22.02
1.4	1	3		21.88	22.07	22.01
1.4	1	5		21.73	22.01	21.98
1.4	3	0		21.62	21.77	21.80
1.4	3	1		21.68	21.86	21.83



1.4	3	3	64-QAM	21.59	21.72	21.81
1.4	6	0		20.65	20.77	20.79
1.4	1	0		20.85	21.05	21.05
1.4	1	3		20.90	21.13	21.12
1.4	1	5		20.78	21.05	21.00
1.4	3	0		20.77	20.96	20.91
1.4	3	1		20.78	20.91	20.87
1.4	3	3		20.77	20.92	20.94
1.4	6	0		19.65	19.79	19.82



LTE Band 66 Maximum Average Power [dBm]						
BW [MHz]	RB Size	RB Offset	Mod	Lowest	Middle	Highest
20	1	0	QPSK	22.64	22.77	22.64
20	1	49		22.58	22.58	22.57
20	1	99		22.51	22.51	22.55
20	50	0		21.41	21.61	21.59
20	50	24		21.41	21.41	21.58
20	50	50		21.41	21.41	21.53
20	100	0		21.46	21.59	21.46
20	1	0	16-QAM	21.88	21.88	22.15
20	1	49		21.93	21.93	22.29
20	1	99		21.93	21.93	22.03
20	50	0		20.47	20.47	20.76
20	50	24		20.60	20.60	20.71
20	50	50		20.57	20.57	20.66
20	100	0		20.57	20.57	20.72
20	1	0	64-QAM	20.90	20.90	21.19
20	1	49		20.95	20.95	21.21
20	1	99		20.93	20.93	20.97
20	50	0		19.57	19.57	19.81
20	50	24		19.67	19.67	19.79
20	50	50		19.64	19.64	19.76
20	100	0		19.65	19.65	19.82
15	1	0	QPSK	22.66	22.73	22.70
15	1	37		22.58	22.71	22.73
15	1	74		22.61	22.58	22.56
15	36	0		21.46	21.57	21.55
15	36	20		21.55	21.65	21.66
15	36	39		21.55	21.50	21.53
15	75	0		21.54	21.56	21.53
15	1	0	16-QAM	21.96	22.24	22.33
15	1	37		22.08	22.12	22.10
15	1	74		22.13	22.04	21.95
15	36	0		20.56	20.64	20.71
15	36	20		20.66	20.77	20.77



15	36	39	64-QAM	20.66	20.60	20.64
15	75	0		20.70	20.66	20.67
15	1	0		21.04	21.15	21.17
15	1	37		21.10	21.13	21.15
15	1	74		21.13	20.98	20.95
15	36	0		19.61	19.79	19.79
15	36	20		19.71	19.88	19.89
15	36	39		19.73	19.75	19.71
15	75	0		19.78	19.74	19.76



LTE Band 66 Maximum Average Power [dBm]						
BW [MHz]	RB Size	RB Offset	Mod	Lowest	Middle	Highest
10	1	0	QPSK	22.56	22.61	22.67
10	1	25		22.60	22.65	22.64
10	1	49		22.41	22.45	22.48
10	25	0		21.48	21.60	21.56
10	25	12		21.48	21.58	21.54
10	25	25		21.44	21.52	21.54
10	50	0		21.49	21.55	21.57
10	1	0	16-QAM	22.01	22.10	22.14
10	1	25		21.98	22.10	22.02
10	1	49		21.99	21.89	22.00
10	25	0		20.57	20.71	20.72
10	25	12		20.58	20.72	20.69
10	25	25		20.56	20.69	20.66
10	50	0		20.59	20.67	20.68
10	1	0	64-QAM	20.96	20.98	21.08
10	1	25		20.97	21.01	21.09
10	1	49		20.87	20.88	20.96
10	25	0		19.71	19.79	19.82
10	25	12		19.72	19.79	19.82
10	25	25		19.63	19.74	19.77
10	50	0		19.69	19.80	19.75
5	1	0	QPSK	22.42	22.48	22.42
5	1	12		22.48	22.62	22.62
5	1	24		22.39	22.42	22.41
5	12	0		21.45	21.58	21.54
5	12	7		21.54	21.66	21.65
5	12	13		21.51	21.56	21.54
5	25	0		21.45	21.56	21.52
5	1	0	16-QAM	21.83	21.93	21.91
5	1	12		21.98	22.05	22.09
5	1	24		21.77	21.78	21.83
5	12	0		20.58	20.71	20.68
5	12	7		20.69	20.75	20.76



5	12	13	64-QAM	20.62	20.73	20.68
5	25	0		20.59	20.69	20.65
5	1	0		20.81	20.86	20.87
5	1	12		20.92	21.01	21.04
5	1	24		20.68	20.79	20.86
5	12	0		19.66	19.77	19.80
5	12	7		19.78	19.88	19.84
5	12	13		19.69	19.79	19.80
5	25	0		19.67	19.76	19.74



LTE Band 66 Maximum Average Power [dBm]						
BW [MHz]	RB Size	RB Offset	Mod	Lowest	Middle	Highest
3	1	0	QPSK	22.40	22.52	22.45
3	1	8		22.52	22.63	22.56
3	1	14		22.39	22.50	22.44
3	8	0		21.52	21.58	21.57
3	8	4		21.59	21.66	21.61
3	8	7		21.47	21.62	21.57
3	15	0		21.47	21.62	21.57
3	1	0	16-QAM	21.82	21.82	21.94
3	1	8		21.92	22.11	22.05
3	1	14		21.84	21.87	21.90
3	8	0		20.68	20.79	20.76
3	8	4		20.70	20.87	20.86
3	8	7		20.66	20.75	20.74
3	15	0		20.62	20.71	20.70
3	1	0	64-QAM	20.84	20.89	20.85
3	1	8		20.97	21.05	21.07
3	1	14		20.83	20.89	20.94
3	8	0		19.71	19.84	19.79
3	8	4		19.82	19.88	19.84
3	8	7		19.74	19.79	19.75
3	15	0		19.71	19.80	19.81
1.4	1	0	QPSK	22.45	22.57	22.46
1.4	1	3		22.55	22.64	22.57
1.4	1	5		22.43	22.53	22.48
1.4	3	0		22.48	22.58	22.59
1.4	3	1		22.56	22.61	22.58
1.4	3	3		22.50	22.59	22.53
1.4	6	0		21.49	21.56	21.57
1.4	1	0	16-QAM	21.94	21.94	21.91
1.4	1	3		21.94	21.96	22.12
1.4	1	5		21.81	21.86	21.92
1.4	3	0		21.66	21.74	21.75
1.4	3	1		21.69	21.78	21.71



1.4	3	3	64-QAM	21.66	21.70	21.69
1.4	6	0		20.67	20.76	20.76
1.4	1	0		20.83	20.97	20.93
1.4	1	3		21.05	20.95	21.11
1.4	1	5		20.77	20.89	20.86
1.4	3	0		20.78	20.84	20.78
1.4	3	1		20.78	20.85	20.88
1.4	3	3		20.81	20.82	20.79
1.4	6	0		19.72	19.80	19.75



EIRP

LTE Band 66 (GT - LC = -4.50 dB) QPSK									
Bandwidth	1.4M			3M			5M		
Channel	131979	132322	132665	131987	132322	132657	131997	132322	132647
	(Low)	(Mid)	(High)	(Low)	(Mid)	(High)	(Low)	(Mid)	(High)
Frequency (MHz)	1710.7	1745	1779.3	1711.5	1745	1778.5	1712.5	1745	1777.5
Conducted Power (dBm)	22.55	22.64	22.57	22.52	22.63	22.56	22.48	22.62	22.62
Conducted Power (Watts)	0.1799	0.1837	0.1807	0.1786	0.1832	0.1803	0.1770	0.1828	0.1828
EIRP(dBm)	18.05	18.14	18.07	18.02	18.13	18.06	17.98	18.12	18.12
EIRP(Watts)	0.0638	0.0652	0.0641	0.0634	0.0650	0.0640	0.0628	0.0649	0.0649

LTE Band 66 (GT - LC = -4.50 dB) QPSK									
Bandwidth	10M			15M			20M		
Channel	132022	132322	132622	132047	132322	132597	132072	132322	132572
	(Low)	(Mid)	(High)	(Low)	(Mid)	(High)	(Low)	(Mid)	(Mid)
Frequency (MHz)	1715	1745	1775	1717.5	1745	1772.5	1720	1745	1770
Conducted Power (dBm)	22.56	22.61	22.67	22.58	22.71	22.73	22.64	22.77	22.64
Conducted Power (Watts)	0.1803	0.1824	0.1849	0.1811	0.1866	0.1875	0.1837	0.1892	0.1837
EIRP(dBm)	18.06	18.11	18.17	18.08	18.21	18.23	18.14	18.27	18.14
EIRP(Watts)	0.0640	0.0647	0.0656	0.0643	0.0662	0.0665	0.0652	0.0671	0.0652



LTE Band 66 (GT - LC = -4.50 dB) 16QAM									
Bandwidth	1.4M			3M			5M		
Channel	131979	132322	132665	131987	132322	132657	131997	132322	132647
	(Low)	(Mid)	(High)	(Low)	(Mid)	(High)	(Low)	(Mid)	(High)
Frequency (MHz)	1710.7	1745	1779.3	1711.5	1745	1778.5	1712.5	1745	1777.5
Conducted Power (dBm)	21.94	21.96	22.12	21.92	22.11	22.05	21.98	22.05	22.09
Conducted Power (Watts)	0.1563	0.1570	0.1629	0.1556	0.1626	0.1603	0.1578	0.1603	0.1618
EIRP(dBm)	17.44	17.46	17.62	17.42	17.61	17.55	17.48	17.55	17.59
EIRP(Watts)	0.0555	0.0557	0.0578	0.0552	0.0577	0.0569	0.0560	0.0569	0.0574

LTE Band 66 (GT - LC = -4.50 dB) 16QAM									
Bandwidth	10M			15M			20M		
Channel	132022	132322	132622	132047	132322	132597	132072	132322	132572
	(Low)	(Mid)	(High)	(Low)	(Mid)	(High)	(Low)	(Mid)	(Mid)
Frequency (MHz)	1715	1745	1775	1717.5	1745	1772.5	1720	1745	1770
Conducted Power (dBm)	22.01	22.10	22.14	21.96	22.24	22.33	21.93	21.93	22.29
Conducted Power (Watts)	0.1589	0.1622	0.1637	0.1570	0.1675	0.1710	0.1560	0.1560	0.1694
EIRP(dBm)	17.51	17.60	17.64	17.46	17.74	17.83	17.43	17.43	17.79
EIRP(Watts)	0.0564	0.0575	0.0581	0.0557	0.0594	0.0607	0.0553	0.0553	0.0601



LTE Band 66 (GT - LC = -4.50 dB) 64QAM									
Bandwidth	1.4M			3M			5M		
Channel	131979	132322	132665	131987	132322	132657	131997	132322	132647
	(Low)	(Mid)	(High)	(Low)	(Mid)	(High)	(Low)	(Mid)	(High)
Frequency (MHz)	1710.7	1745	1779.3	1711.5	1745	1778.5	1712.5	1745	1777.5
Conducted Power (dBm)	21.05	20.95	21.11	20.97	21.05	21.07	20.92	21.01	21.04
Conducted Power (Watts)	0.1274	0.1245	0.1291	0.1250	0.1274	0.1279	0.1236	0.1262	0.1271
EIRP(dBm)	16.55	16.45	16.61	16.47	16.55	16.57	16.42	16.51	16.54
EIRP(Watts)	0.0452	0.0442	0.0458	0.0444	0.0452	0.0454	0.0439	0.0448	0.0451

LTE Band 66 (GT - LC = -4.50 dB) 64QAM									
Bandwidth	10M			15M			20M		
Channel	132022	132322	132622	132047	132322	132597	132072	132322	132572
	(Low)	(Mid)	(High)	(Low)	(Mid)	(High)	(Low)	(Mid)	(Mid)
Frequency (MHz)	1715	1745	1775	1717.5	1745	1772.5	1720	1745	1770
Conducted Power (dBm)	20.97	21.01	21.09	21.04	21.15	21.17	20.95	20.95	21.21
Conducted Power (Watts)	0.1250	0.1262	0.1285	0.1271	0.1303	0.1309	0.1245	0.1245	0.1321
EIRP(dBm)	16.47	16.51	16.59	16.54	16.65	16.67	16.45	16.45	16.71
EIRP(Watts)	0.0444	0.0448	0.0456	0.0451	0.0462	0.0465	0.0442	0.0442	0.0469



LTE Band 66

Peak-to-Average Ratio

Mode	LTE Band 66 / 20MHz				
Mod.	QPSK		16QAM		Limit: 13dB
RB Size	1RB	Full RB	1RB	Full RB	Result
Lowest CH	3.65	4.81	4.96	6.20	PASS
Middle CH	3.77	4.58	5.28	5.97	
Highest CH	3.77	4.61	5.57	6.12	
Mode	LTE Band 66 / 20MHz				
Mod.	64QAM				Limit: 13dB
RB Size	1RB	Full RB			Result
Lowest CH	6.64	6.70	-	-	PASS
Middle CH	6.67	6.49	-	-	
Highest CH	6.64	6.78	-	-	



LTE Band 66 / 20MHz / QPSK

Lowest Channel / 1RB

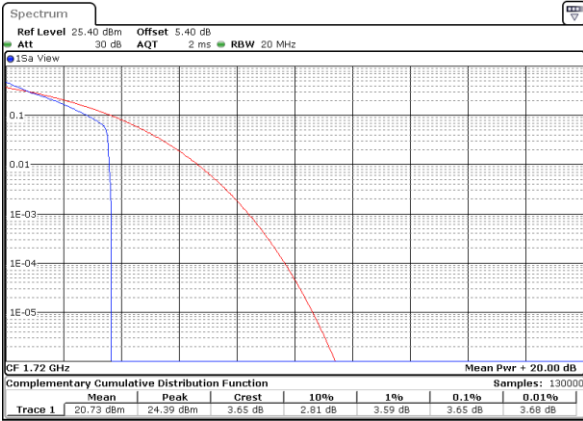

Lowest Channel / Full RB

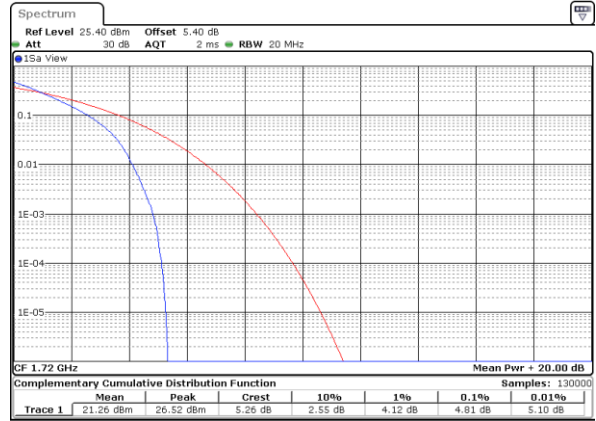

Middle Channel / 1RB

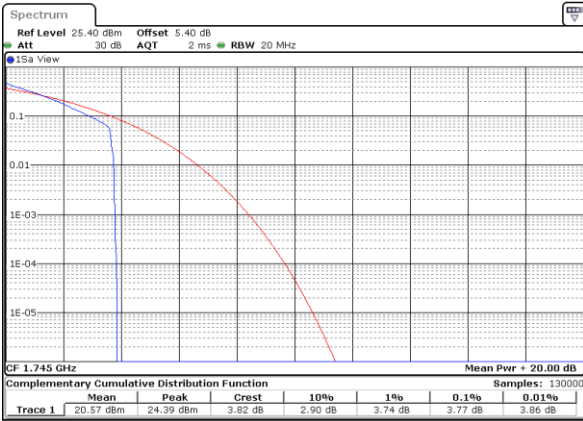

Middle Channel / Full RB

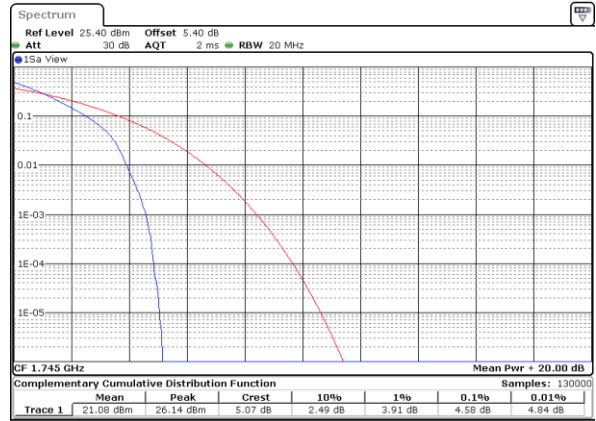

Highest Channel / 1RB

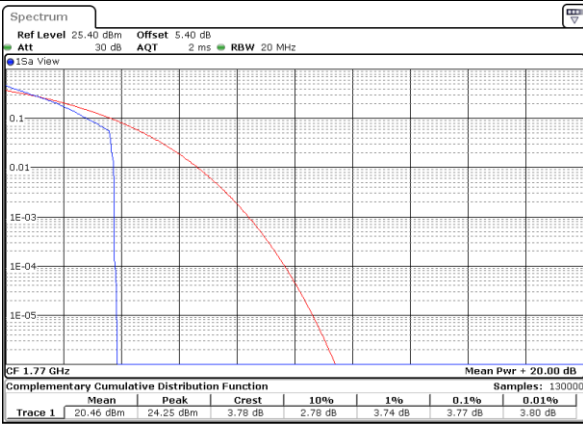

Highest Channel / Full RB

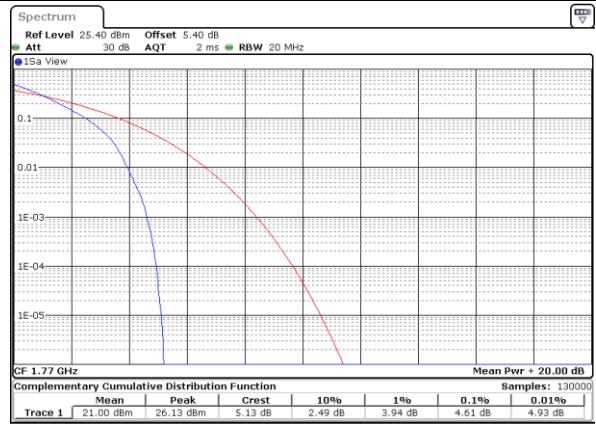



LTE Band 66 / 20MHz / 16QAM

Lowest Channel / 1RB

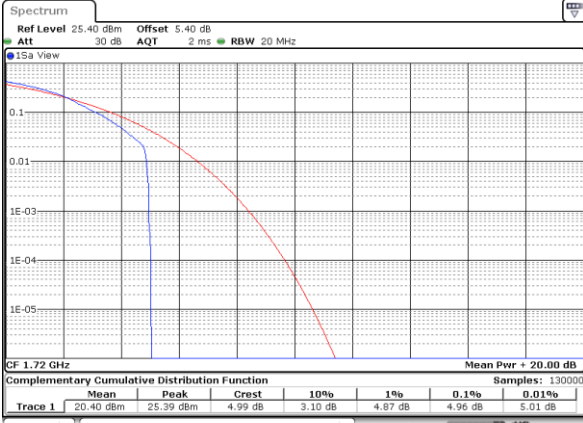

Lowest Channel / Full RB

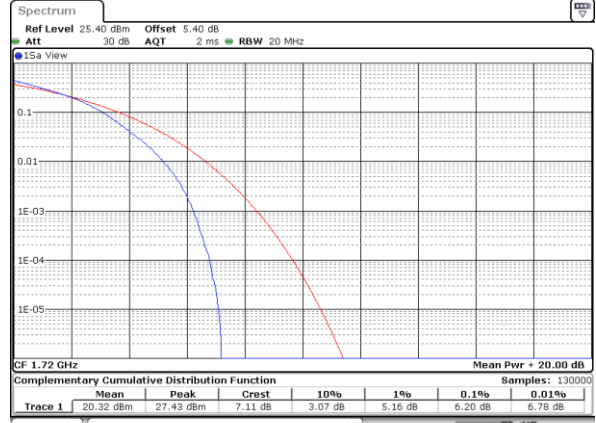

Middle Channel / 1RB

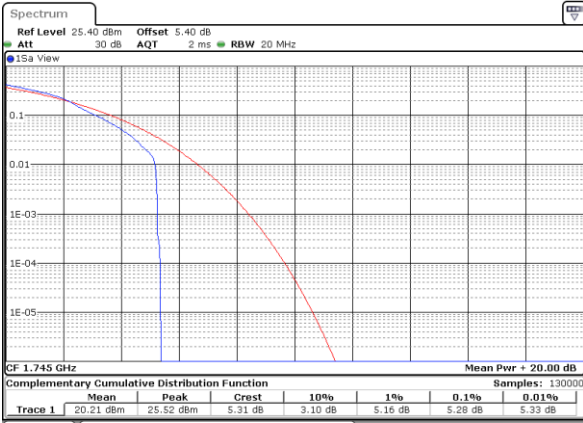

Middle Channel / Full RB

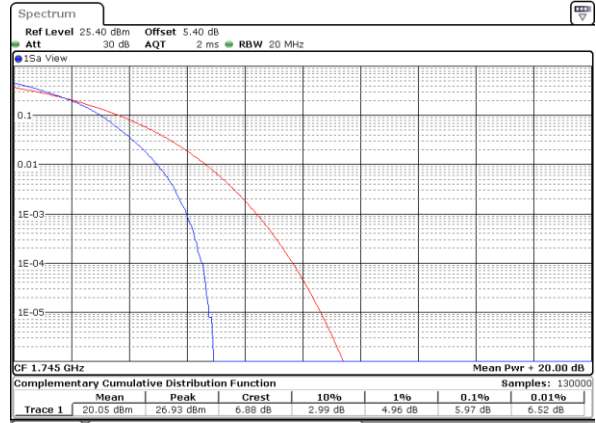

Highest Channel / 1RB

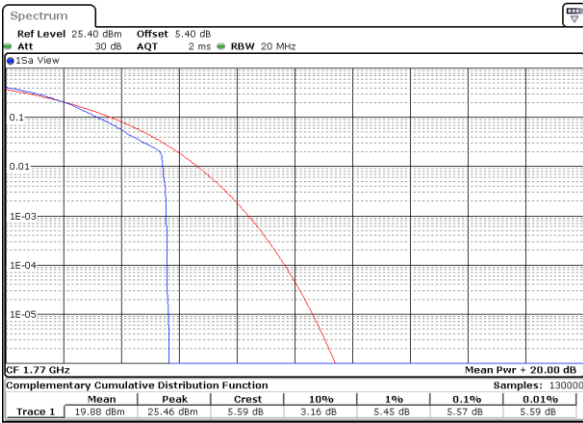

Highest Channel / Full RB

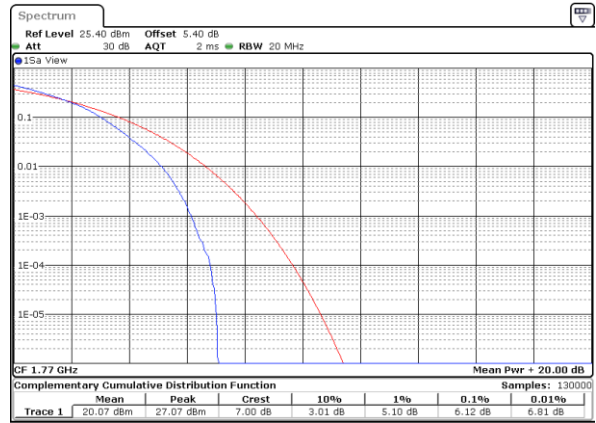



LTE Band 66 / 20MHz / 64QAM

Lowest Channel / 1RB

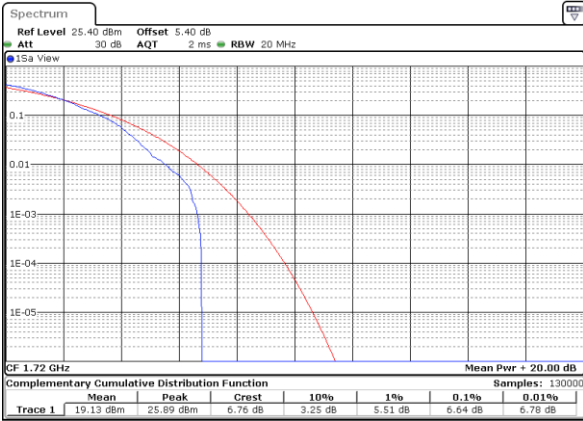

Lowest Channel / Full RB

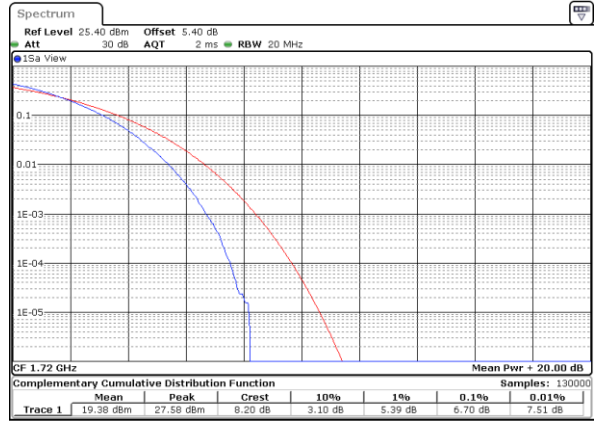

Middle Channel / 1RB

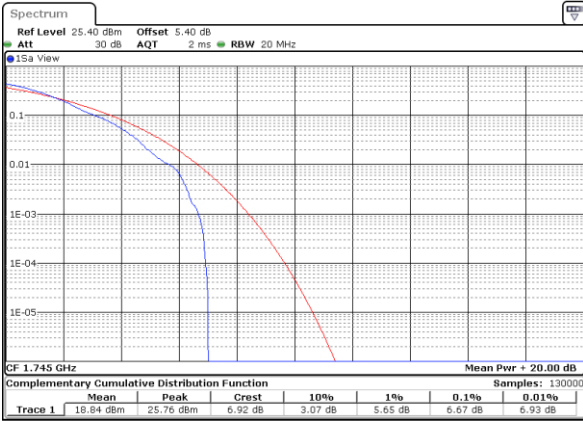

Middle Channel / Full RB

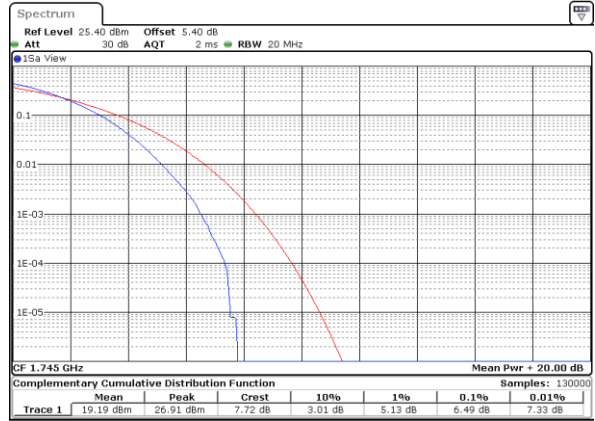

Highest Channel / 1RB

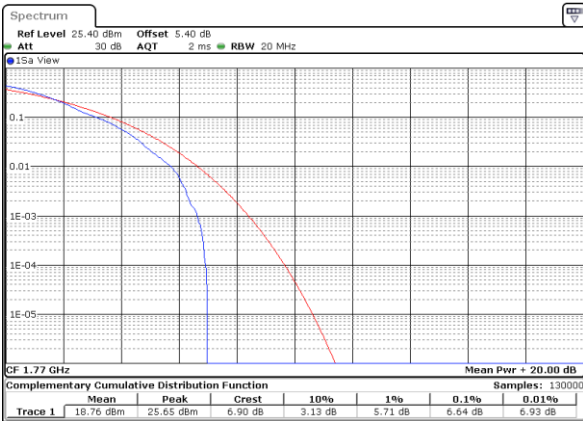

Highest Channel / Full RB





26dB Bandwidth

Mode	LTE Band 66 : 26dB BW(MHz)											
BW	1.4MHz		3MHz		5MHz		10MHz		15MHz		20MHz	
Mod.	QPSK	16QAM	QPSK	16QAM	QPSK	16QAM	QPSK	16QAM	QPSK	16QAM	QPSK	16QAM
Lowest CH	1.22	1.23	3.01	3.04	4.95	4.96	9.75	9.77	14.51	14.27	20.14	20.06
Middle CH	1.21	1.23	3.03	2.97	4.85	4.87	9.79	9.81	14.15	14.63	20.22	20.14
Highest CH	1.23	1.23	3.04	3.02	4.93	4.86	9.71	9.69	14.57	14.33	20.30	20.30
Mode	LTE Band 66 : 26dB BW(MHz)											
BW	1.4MHz		3MHz		5MHz		10MHz		15MHz		20MHz	
Mod.	64QAM		64QAM		64QAM		64QAM		64QAM		64QAM	
Lowest CH	1.21	-	3.02	-	4.89	-	9.89	-	14.42	-	20.30	-
Middle CH	1.23	-	3.05	-	4.91	-	9.73	-	14.54	-	20.14	-
Highest CH	1.23	-	3.05	-	4.86	-	9.97	-	14.39	-	20.18	-



LTE Band 66

Lowest Channel / 1.4MHz / QPSK

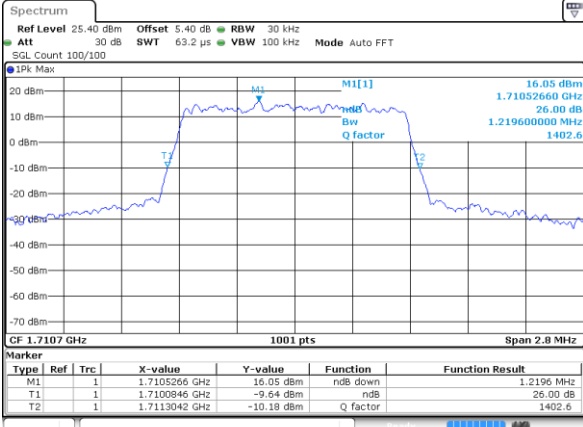

Lowest Channel / 1.4MHz / 16QAM

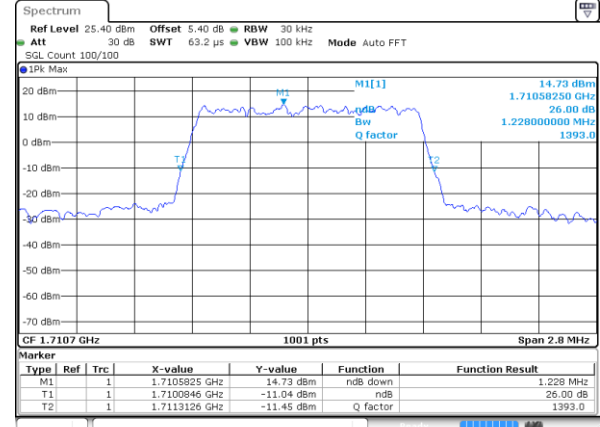

Middle Channel / 1.4MHz / QPSK

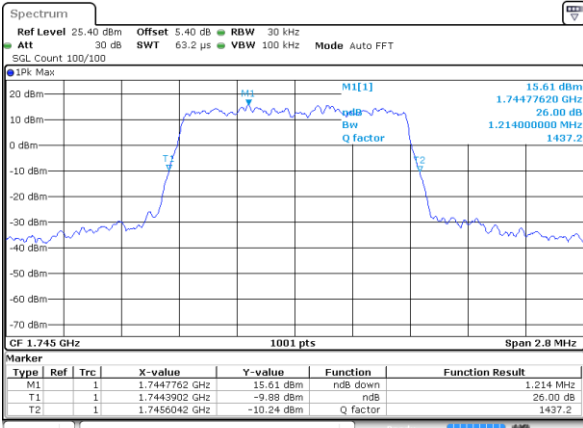

Middle Channel / 1.4MHz / 16QAM

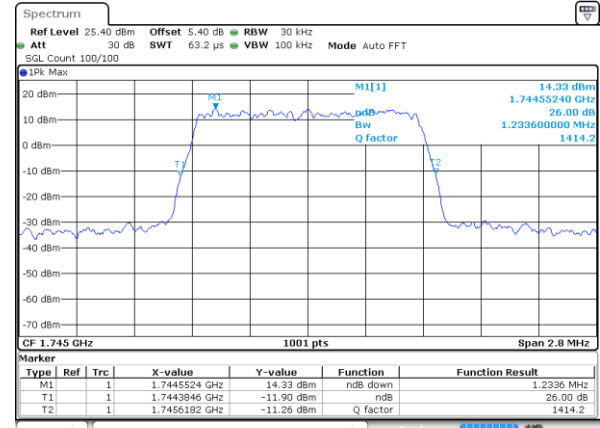

Highest Channel / 1.4MHz / QPSK

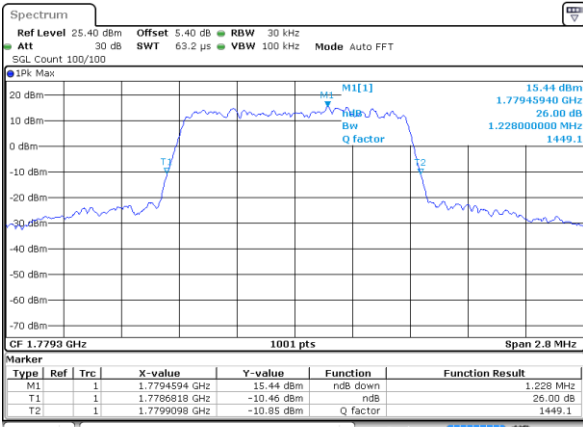

Highest Channel / 1.4MHz / 16QAM

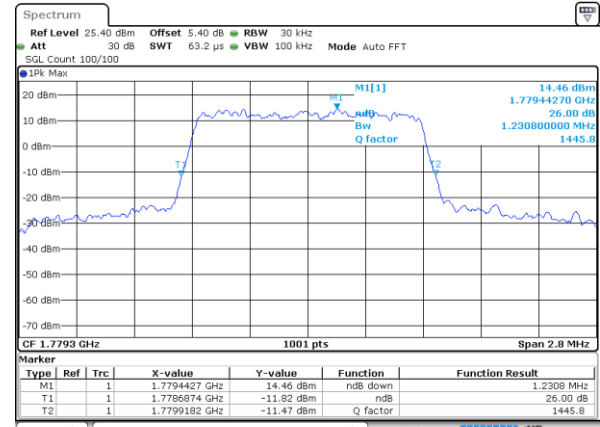



LTE Band 66

Lowest Channel / 3MHz / QPSK

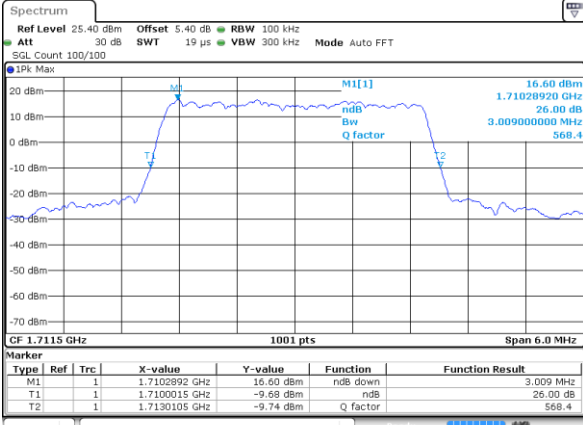

Lowest Channel / 3MHz / 16QAM

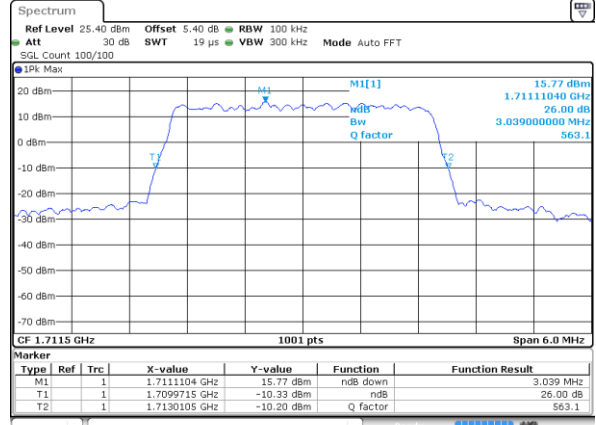

Middle Channel / 3MHz / QPSK

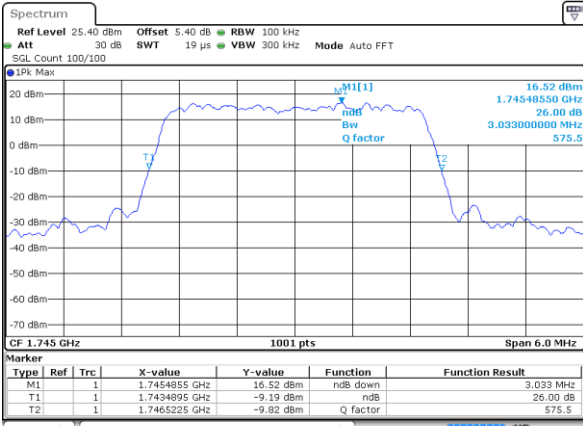

Middle Channel / 3MHz / 16QAM

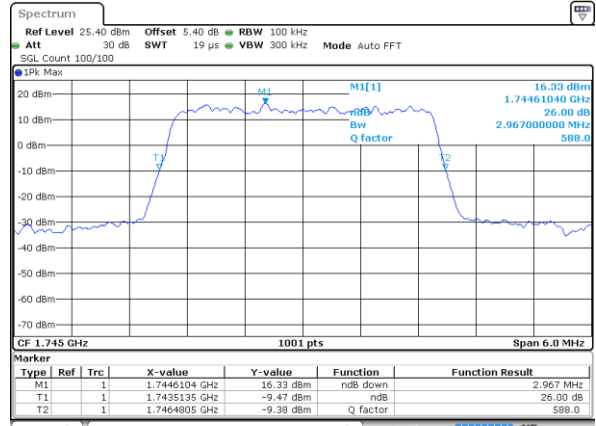

Highest Channel / 3MHz / QPSK

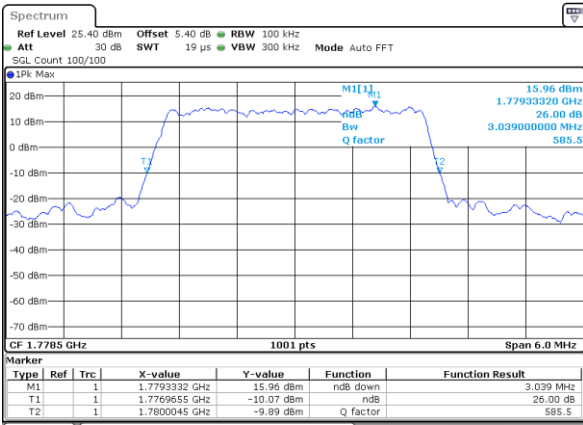

Highest Channel / 3MHz / 16QAM

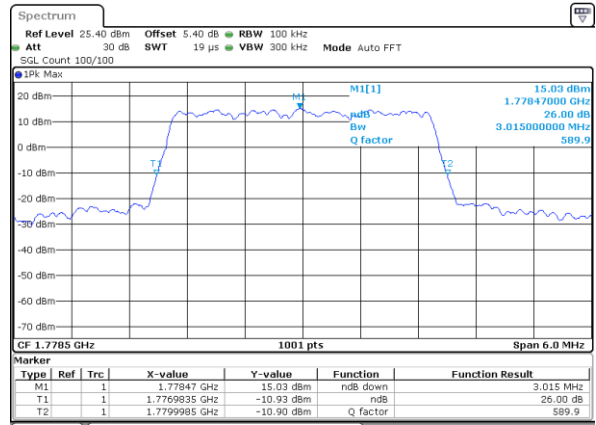



LTE Band 66

Lowest Channel / 5MHz / QPSK

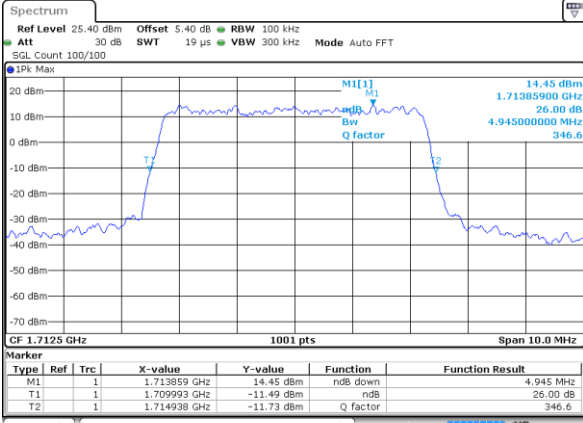

Lowest Channel / 5MHz / 16QAM

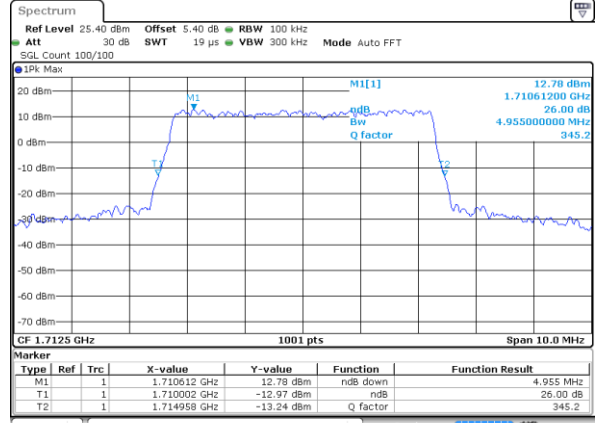

Middle Channel / 5MHz / QPSK

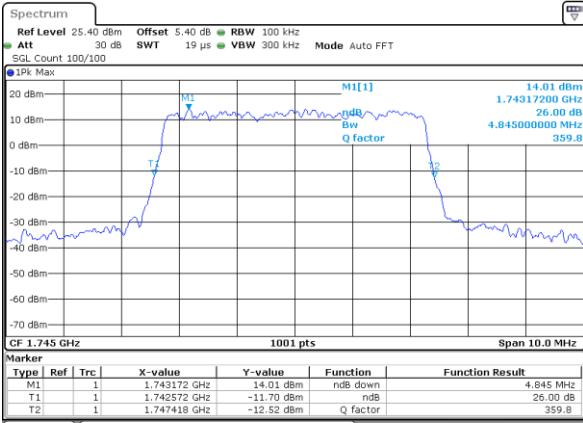

Middle Channel / 5MHz / 16QAM

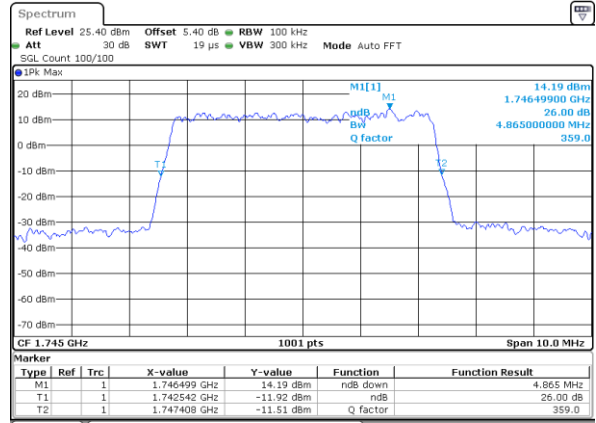

Highest Channel / 5MHz / QPSK

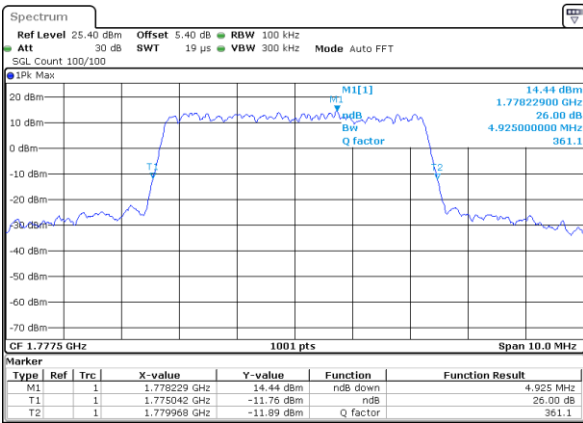

Highest Channel / 5MHz / 16QAM

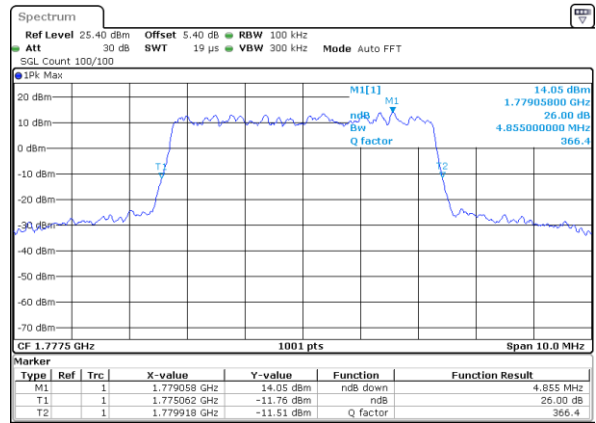



LTE Band 66

Lowest Channel / 10MHz / QPSK

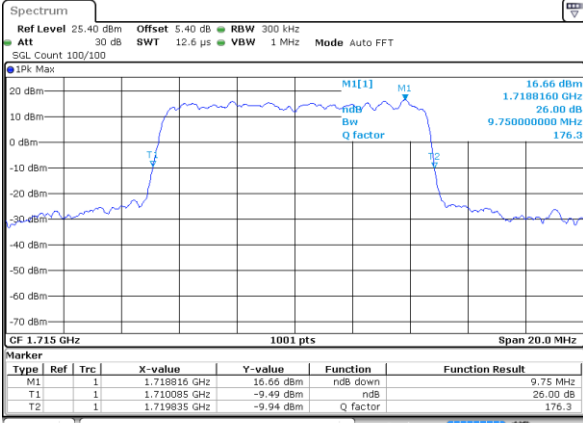

Lowest Channel / 10MHz / 16QAM

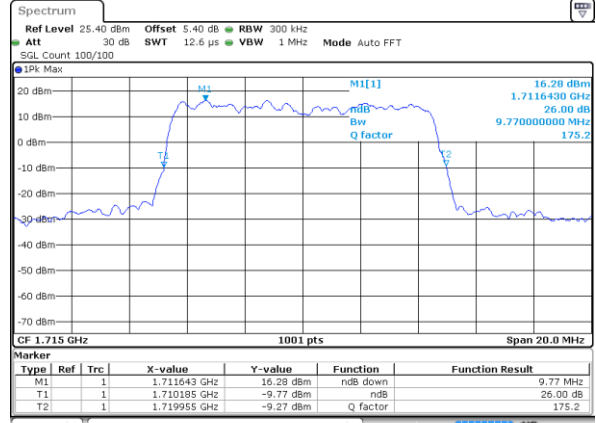

Middle Channel / 10MHz / QPSK

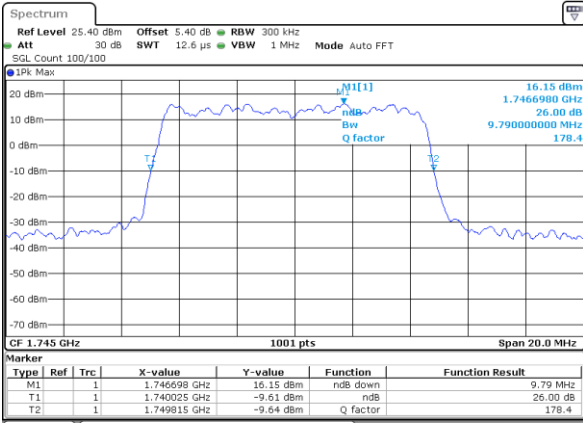

Middle Channel / 10MHz / 16QAM

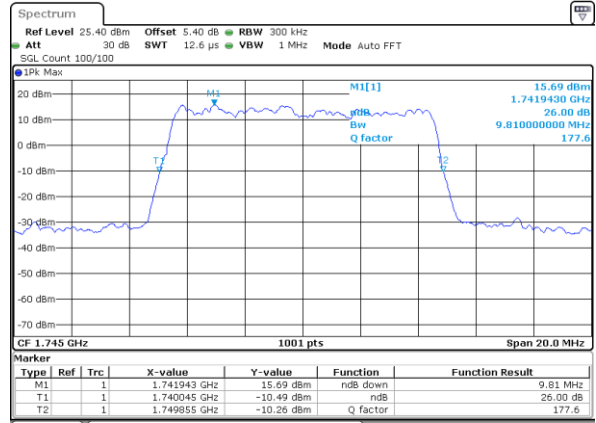

Highest Channel / 10MHz / QPSK

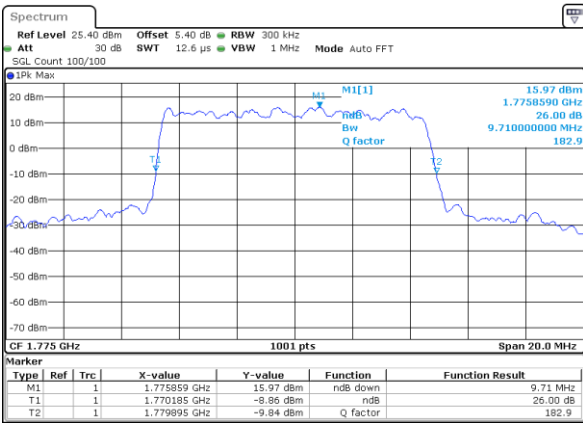

Highest Channel / 10MHz / 16QAM

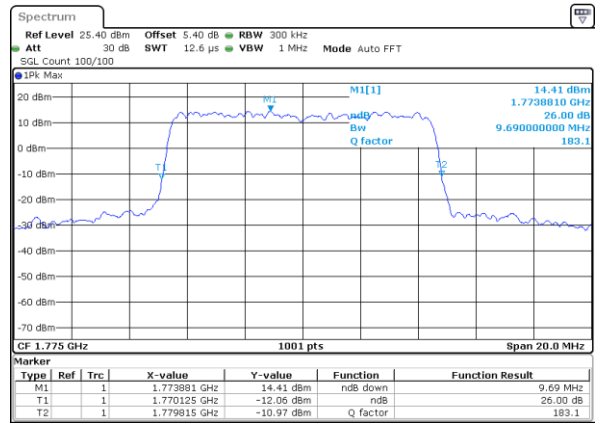



LTE Band 66

Lowest Channel / 15MHz / QPSK

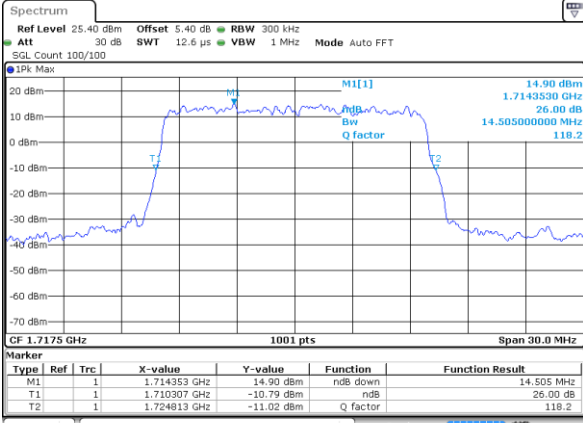

Lowest Channel / 15MHz / 16QAM

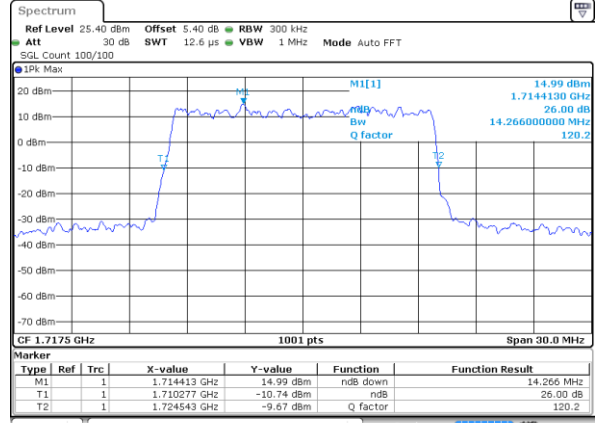

Middle Channel / 15MHz / QPSK

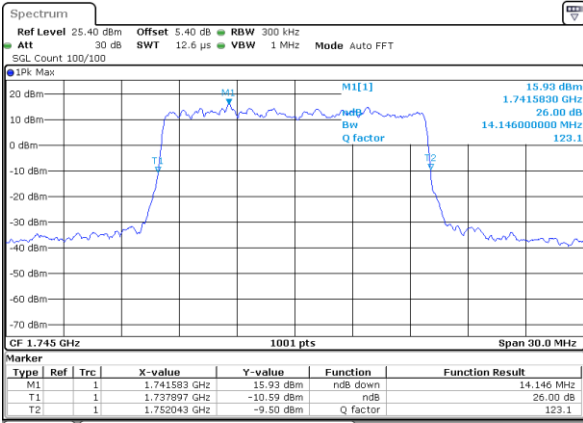

Middle Channel / 15MHz / 16QAM

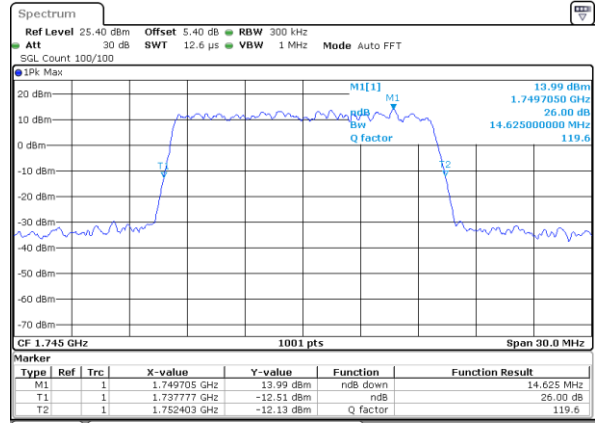

Highest Channel / 15MHz / QPSK

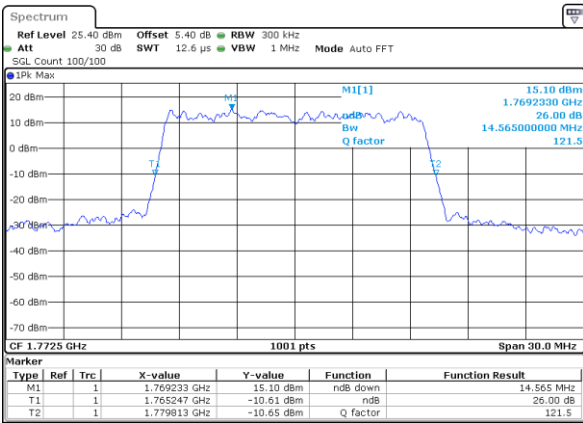

Highest Channel / 15MHz / 16QAM

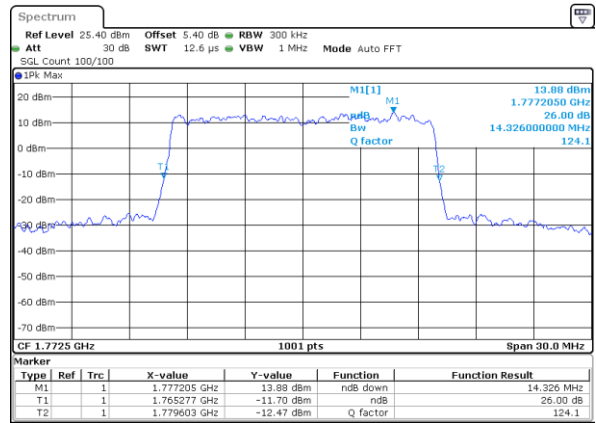



LTE Band 66

Lowest Channel / 20MHz / QPSK

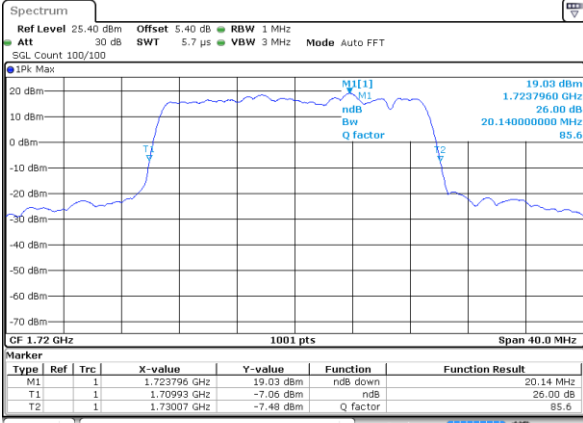

Lowest Channel / 20MHz / 16QAM

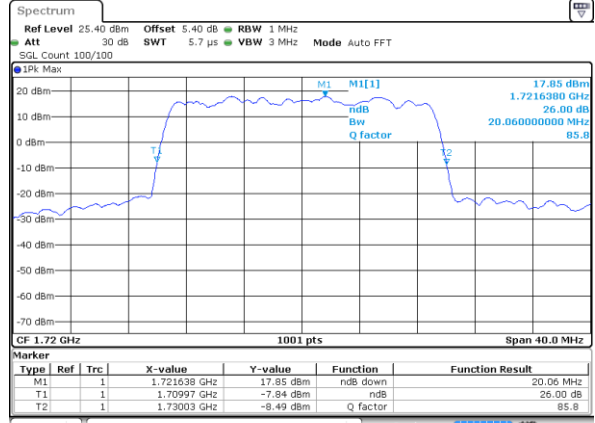

Middle Channel / 20MHz / QPSK

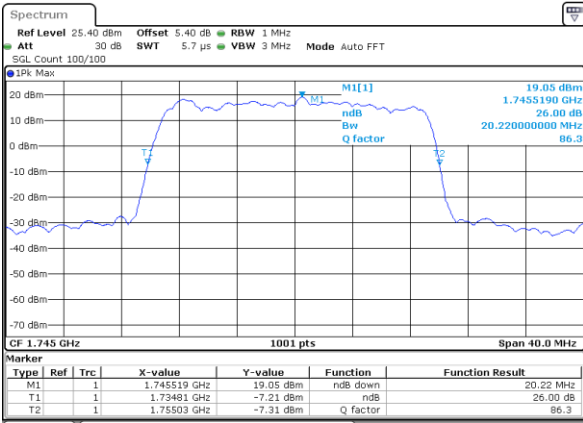

Middle Channel / 20MHz / 16QAM

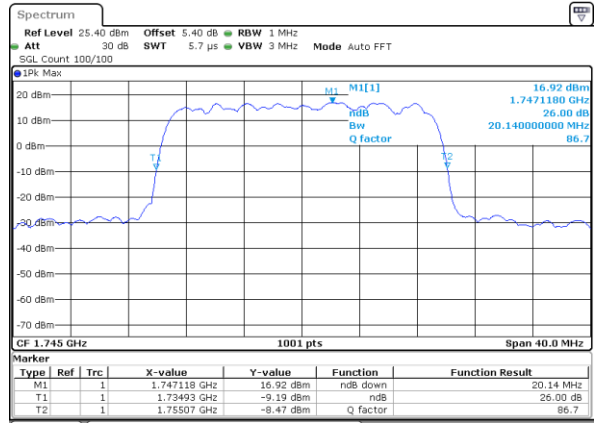

Highest Channel / 20MHz / QPSK

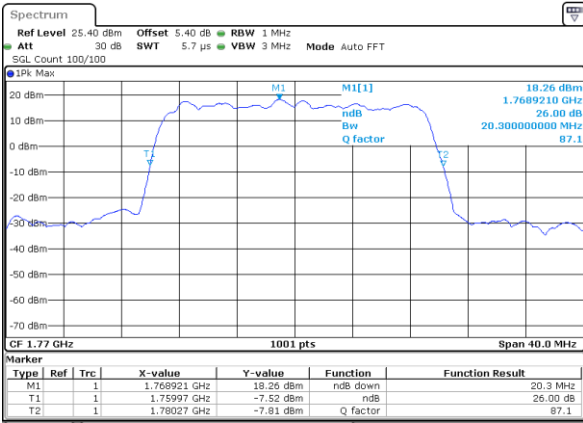

Highest Channel / 20MHz / 16QAM

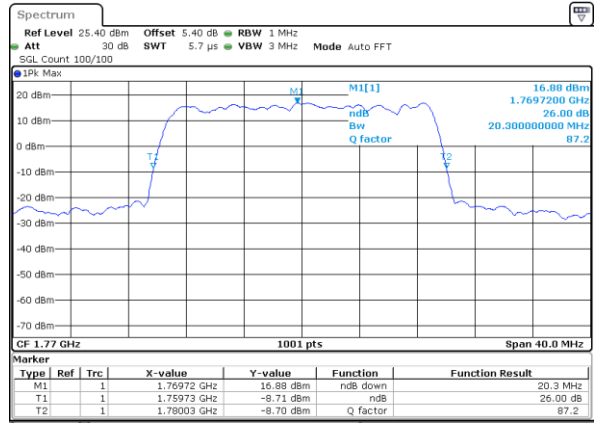



LTE Band 66

Lowest Channel / 1.4MHz / 64QAM

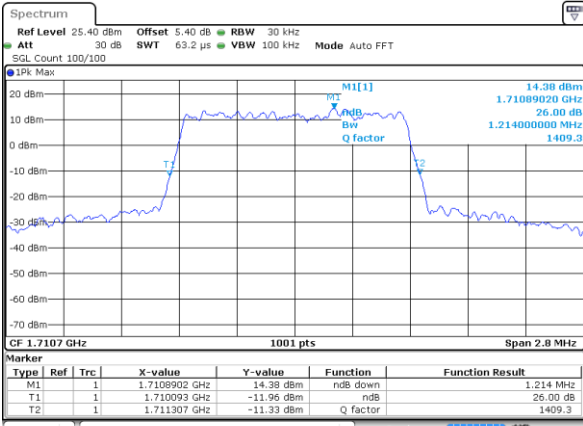

Lowest Channel / 3MHz / 64QAM

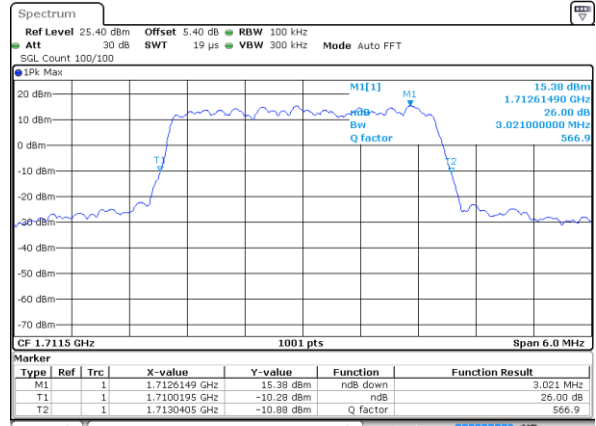

Middle Channel / 20MHz / 64QAM

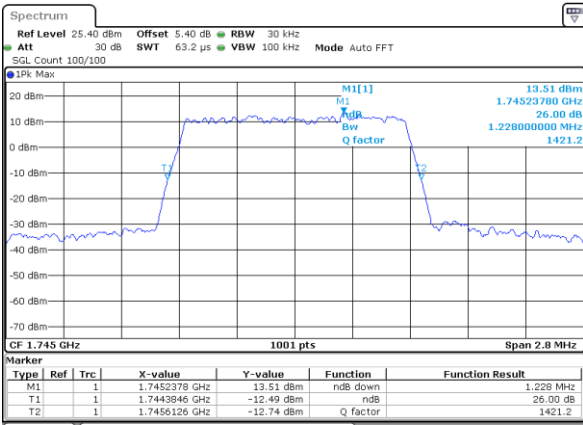

Middle Channel / 3MHz / 64QAM

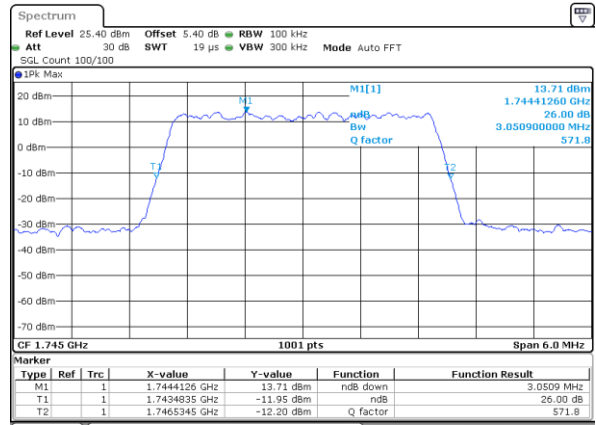

Highest Channel / 20MHz / 64QAM

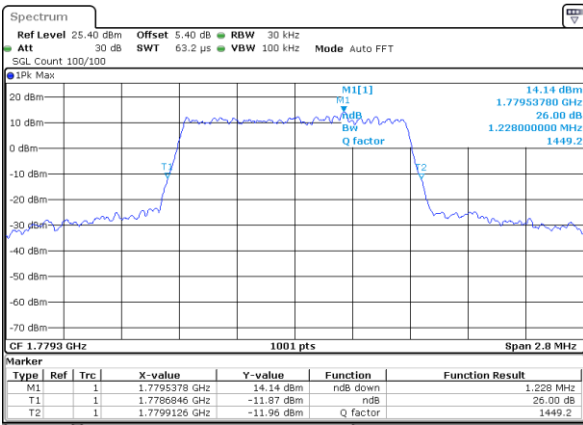

Highest Channel / 3MHz / 64QAM

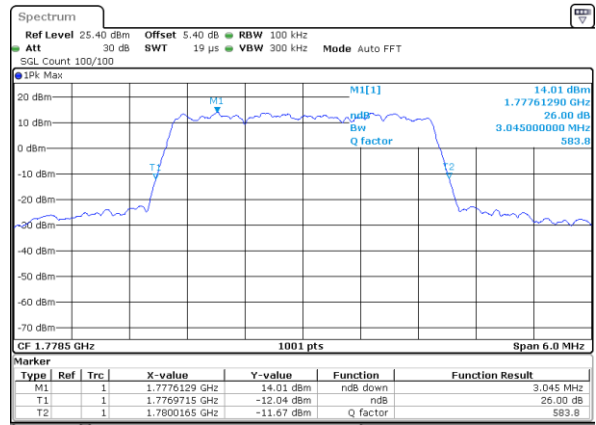



LTE Band 66

Lowest Channel / 5MHz / 64QAM

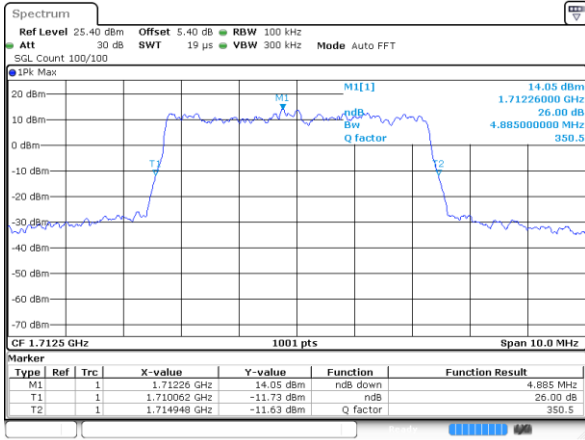

Lowest Channel / 10MHz / 64QAM

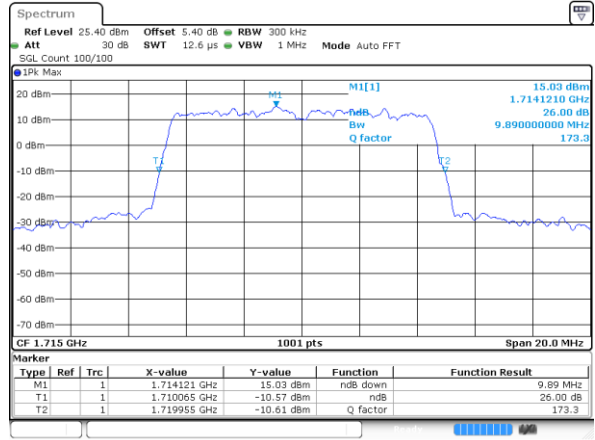

Middle Channel / 5MHz / 64QAM

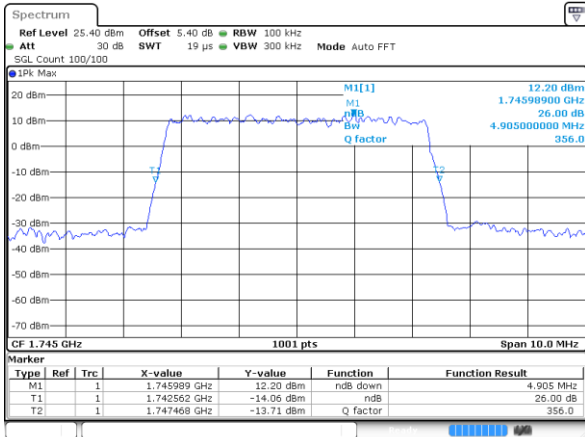

Middle Channel / 10MHz / 64QAM

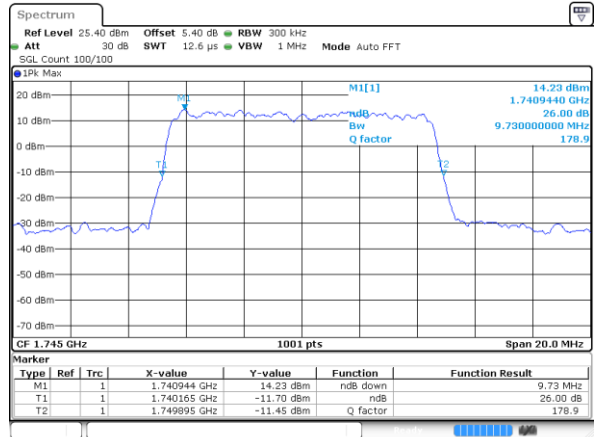

Highest Channel / 5MHz / 64QAM

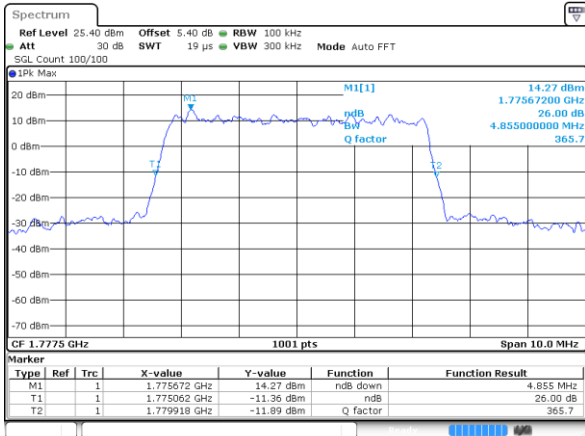

Highest Channel / 10MHz / 64QAM

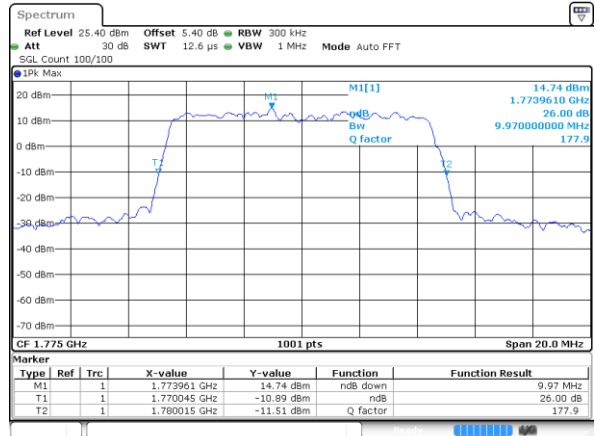



LTE Band 66

Lowest Channel / 15MHz / 64QAM

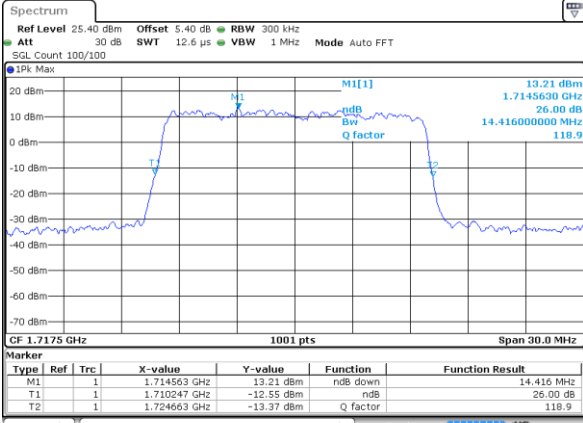

Lowest Channel / 20MHz / 64QAM

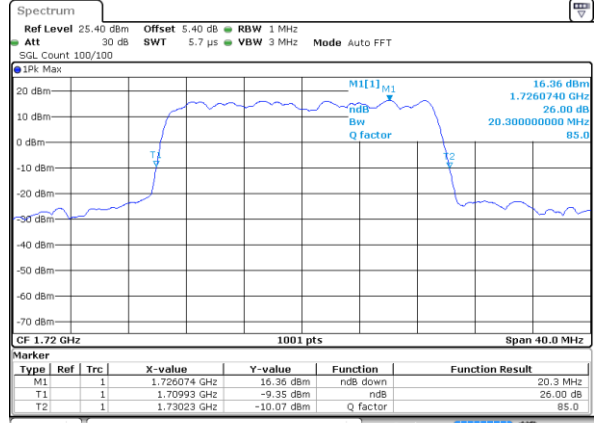

Middle Channel / 15MHz / 64QAM

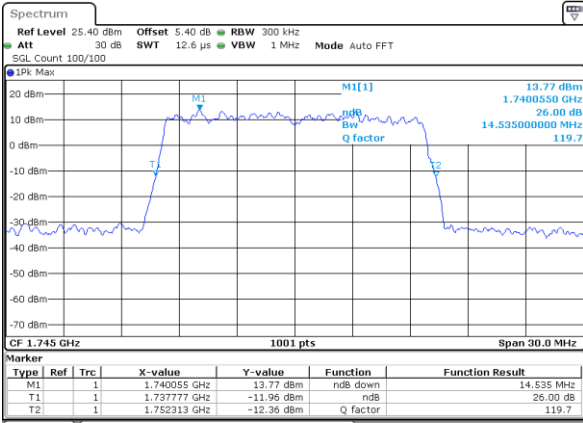

Middle Channel / 20MHz / 64QAM

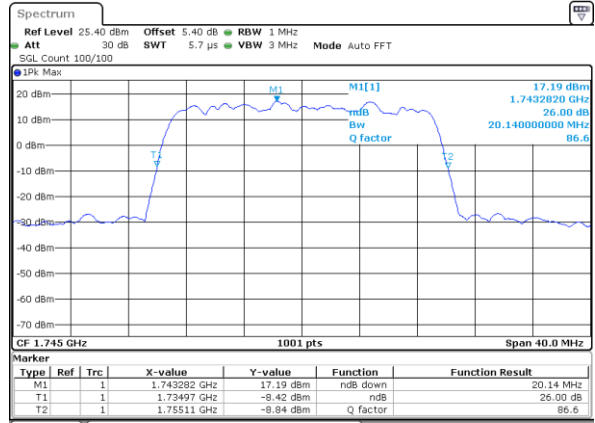

Highest Channel / 15MHz / 64QAM

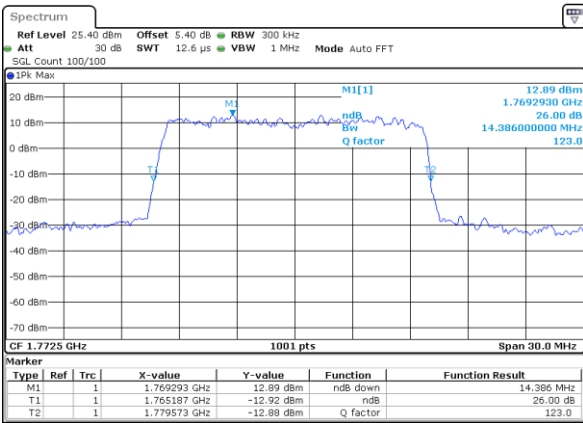

Highest Channel / 20MHz / 64QAM

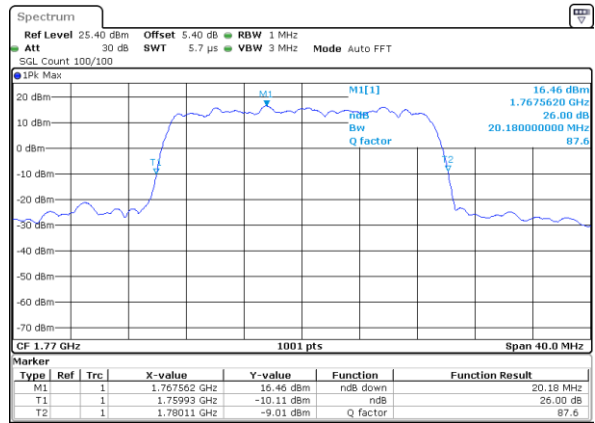



Occupied Bandwidth

Mode	LTE Band 66 : 99%OBW(MHz)											
BW	1.4MHz		3MHz		5MHz		10MHz		15MHz		20MHz	
Mod.	QPSK	16QAM	QPSK	16QAM	QPSK	16QAM	QPSK	16QAM	QPSK	16QAM	QPSK	16QAM
Lowest CH	1.09	1.09	2.71	2.70	4.50	4.50	9.07	8.97	13.49	13.46	18.42	18.26
Middle CH	1.09	1.09	2.72	2.71	4.50	4.50	9.03	9.03	13.43	13.43	18.26	18.54
Highest CH	1.09	1.10	2.72	2.72	4.48	4.49	9.07	9.03	13.40	13.46	18.30	18.34
Mode	LTE Band 66 : 99%OBW(MHz)											
BW	1.4MHz		3MHz		5MHz		10MHz		15MHz		20MHz	
Mod.	64QAM		64QAM		64QAM		64QAM		64QAM		64QAM	
Lowest CH	1.09	-	2.72	-	4.47	-	9.03	-	13.43	-	18.34	-
Middle CH	1.09	-	2.72	-	4.50	-	8.99	-	13.46	-	18.38	-
Highest CH	1.09	-	2.73	-	4.50	-	9.01	-	13.37	-	18.14	-



LTE Band 66

Lowest Channel / 1.4MHz / QPSK

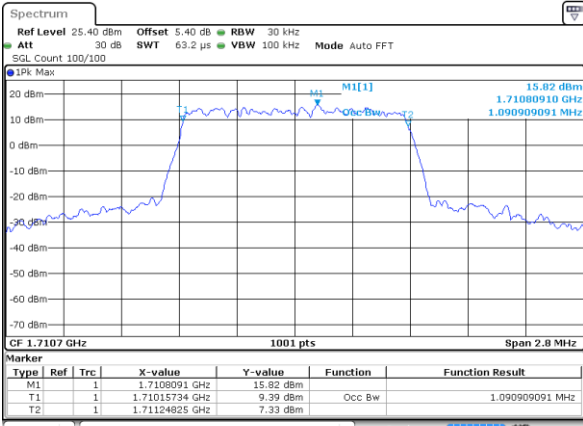

Lowest Channel / 1.4MHz / 16QAM

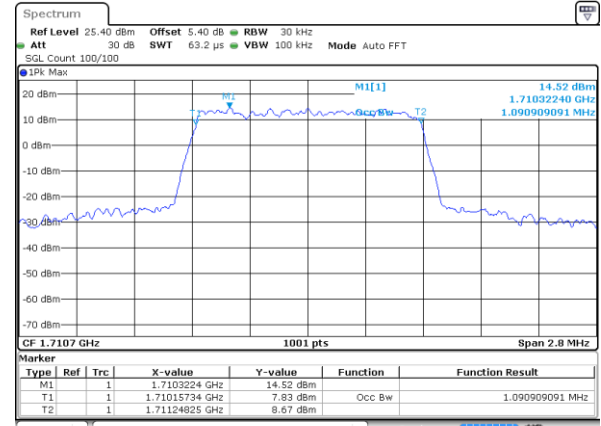

Middle Channel / 1.4MHz / QPSK

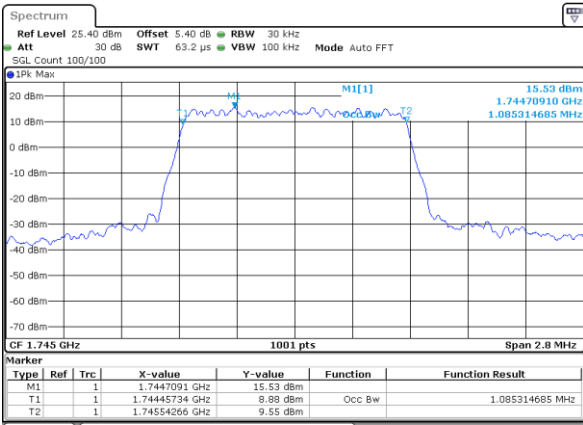

Middle Channel / 1.4MHz / 16QAM

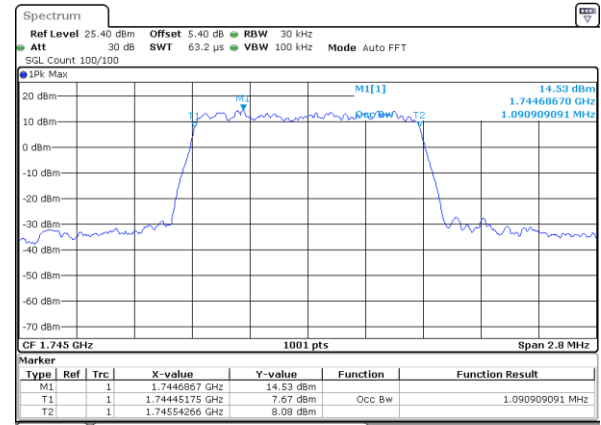

Highest Channel / 1.4MHz / QPSK

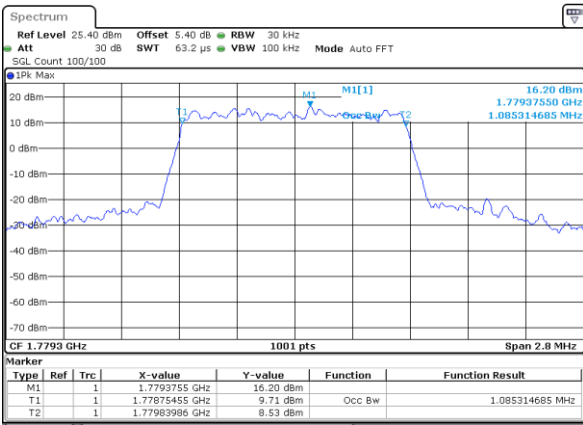

Highest Channel / 1.4MHz / 16QAM

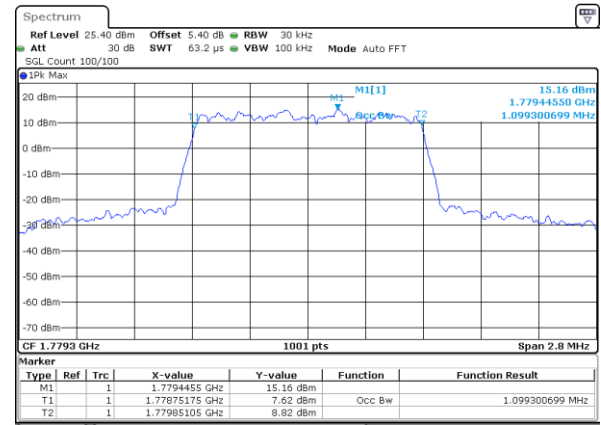



LTE Band 66

Lowest Channel / 3MHz / QPSK

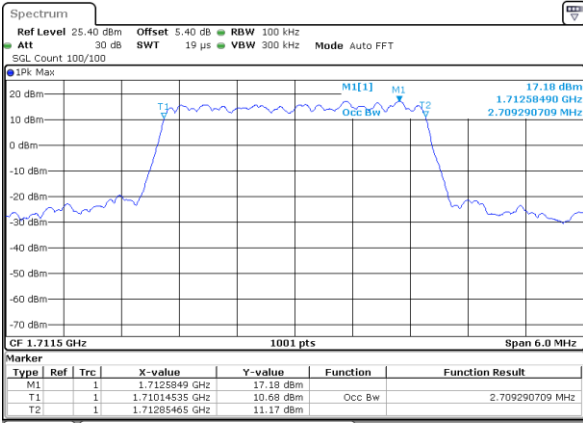

Lowest Channel / 3MHz / 16QAM

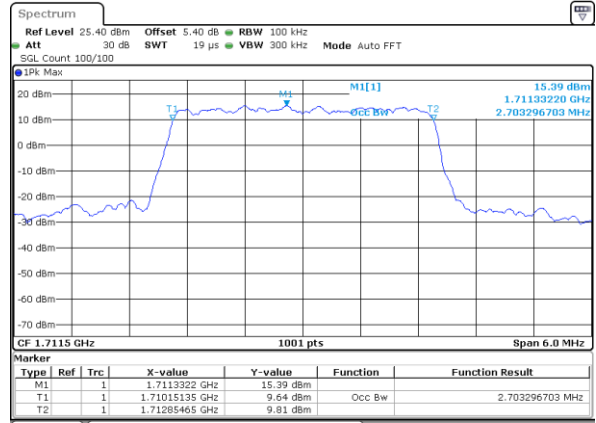

Middle Channel / 3MHz / QPSK

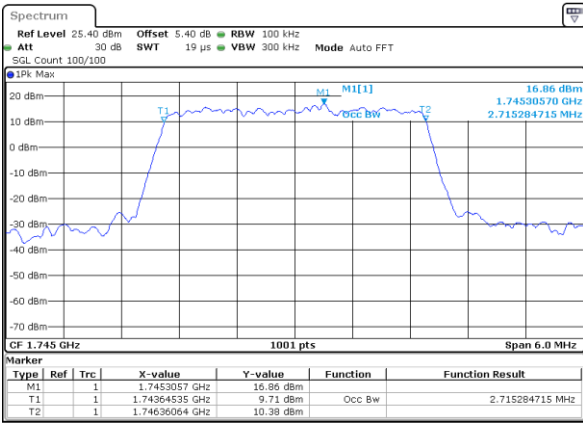

Middle Channel / 3MHz / 16QAM

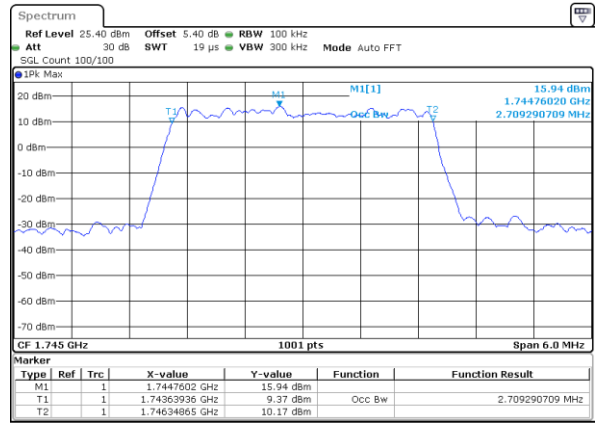

Highest Channel / 3MHz / QPSK

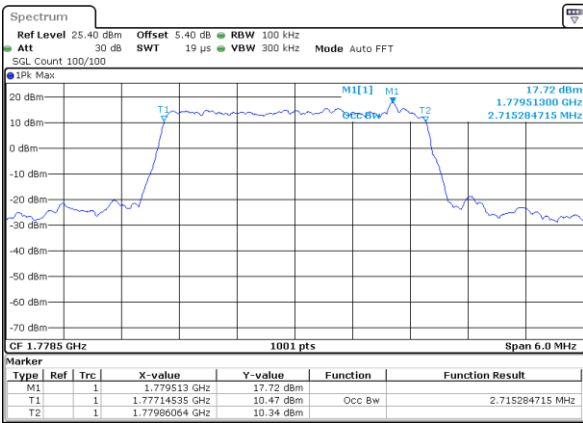

Highest Channel / 3MHz / 16QAM

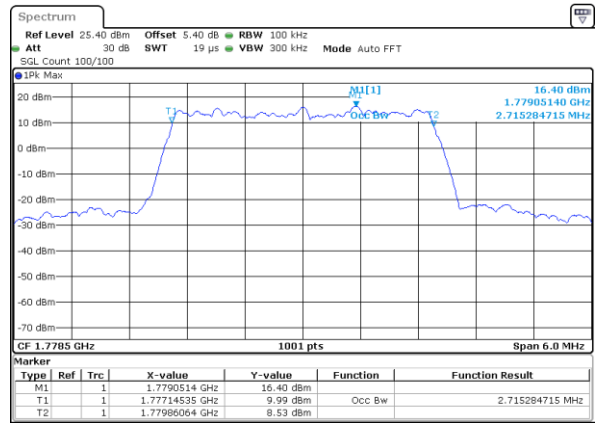



LTE Band 66

Lowest Channel / 5MHz / QPSK

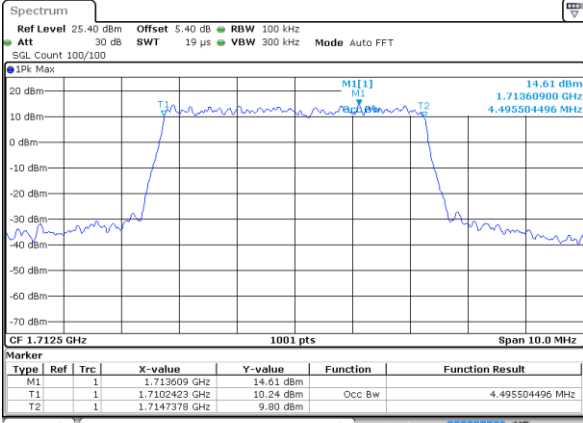

Lowest Channel / 5MHz / 16QAM

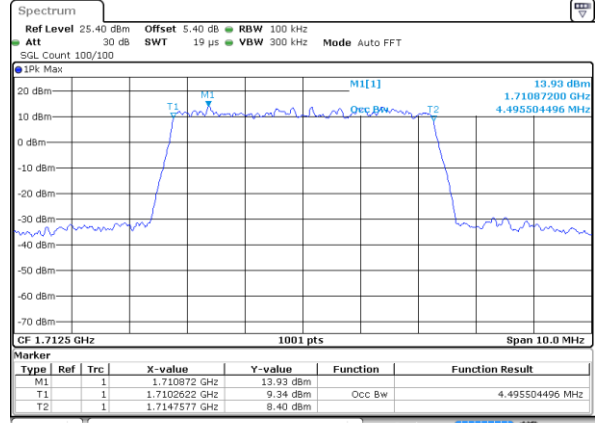

Middle Channel / 5MHz / QPSK

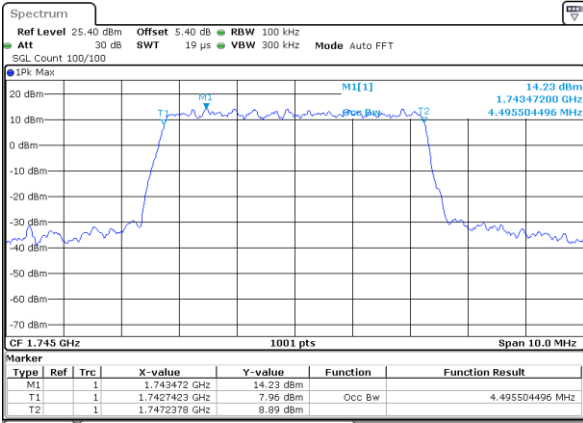

Middle Channel / 5MHz / 16QAM

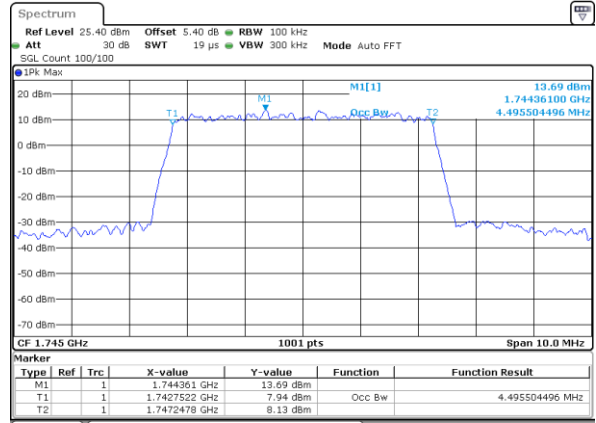

Highest Channel / 5MHz / QPSK

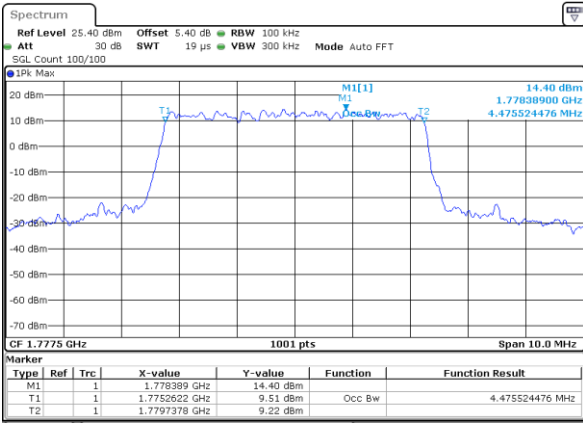

Highest Channel / 5MHz / 16QAM

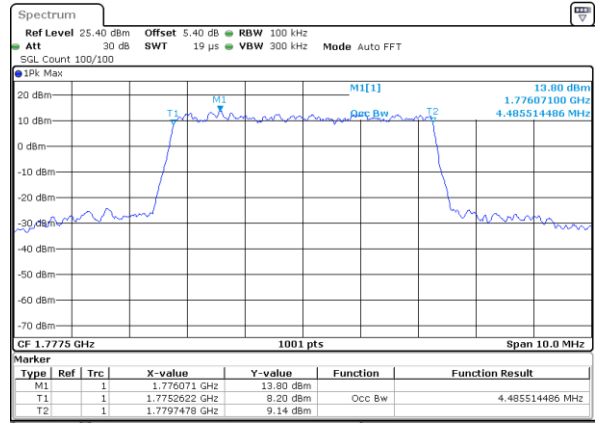



LTE Band 66

Lowest Channel / 10MHz / QPSK

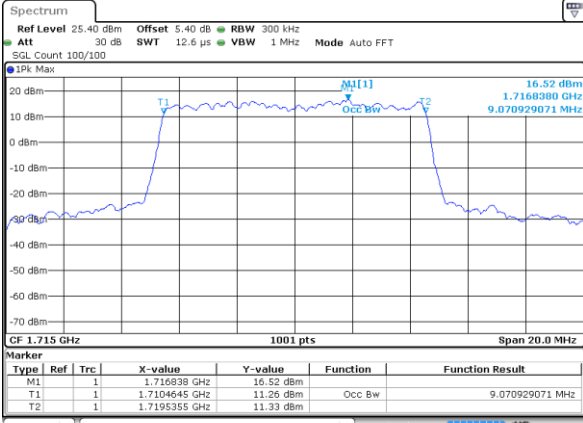

Lowest Channel / 10MHz / 16QAM

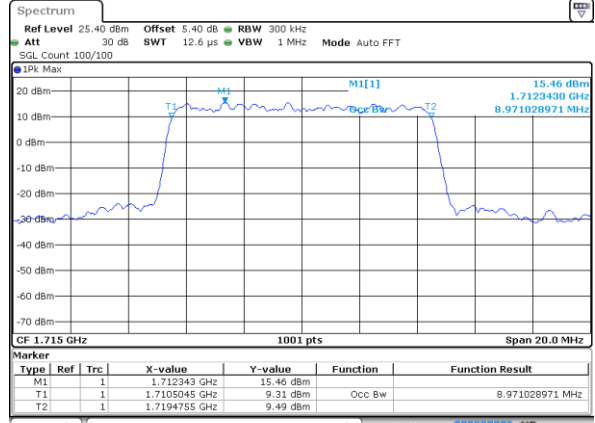

Middle Channel / 10MHz / QPSK

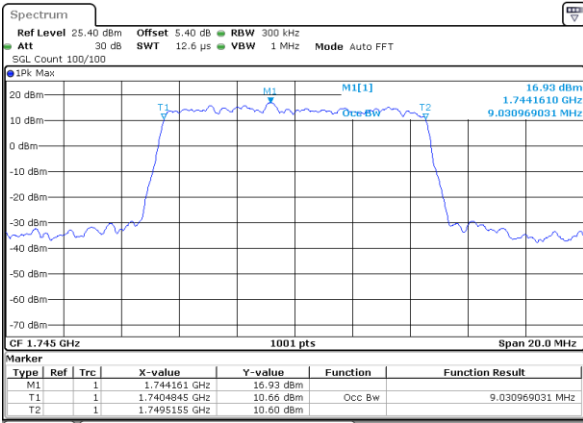

Middle Channel / 10MHz / 16QAM

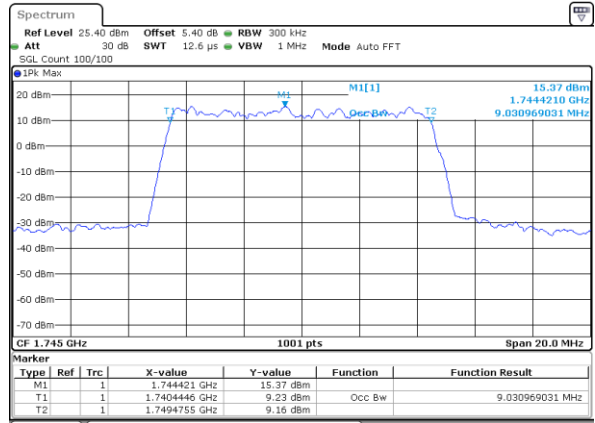

Highest Channel / 10MHz / QPSK

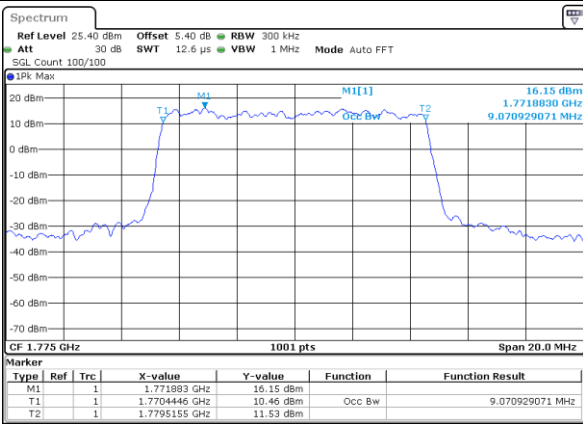

Highest Channel / 10MHz / 16QAM

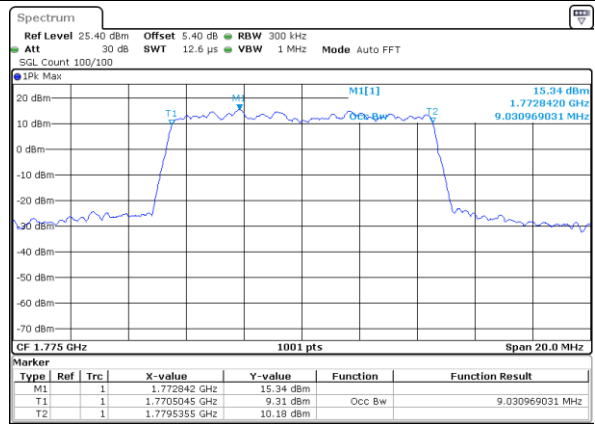



LTE Band 66

Lowest Channel / 15MHz / QPSK

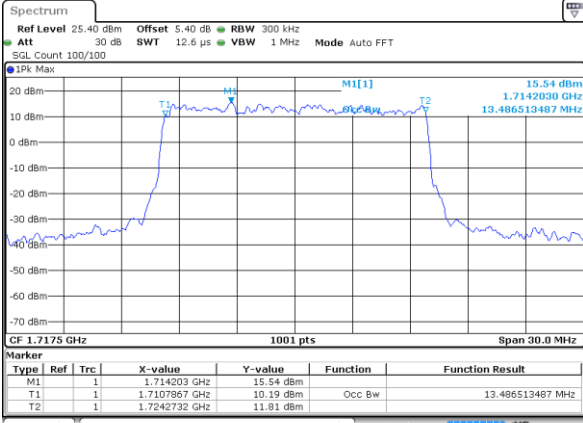

Lowest Channel / 15MHz / 16QAM

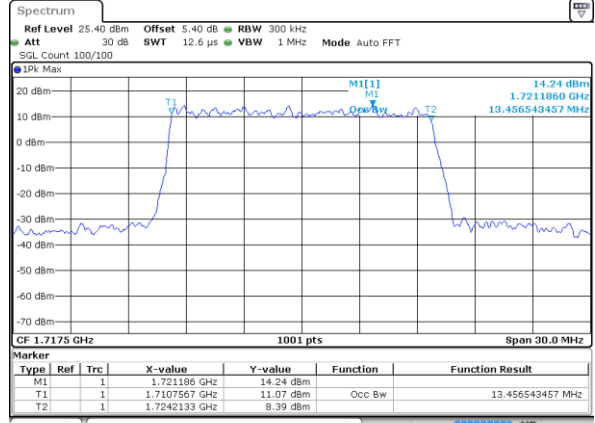

Middle Channel / 15MHz / QPSK

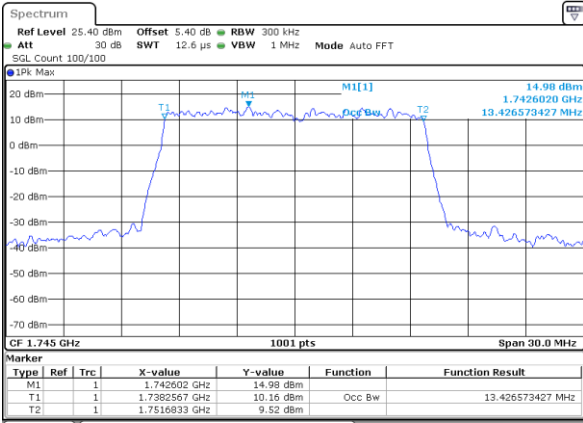

Middle Channel / 15MHz / 16QAM

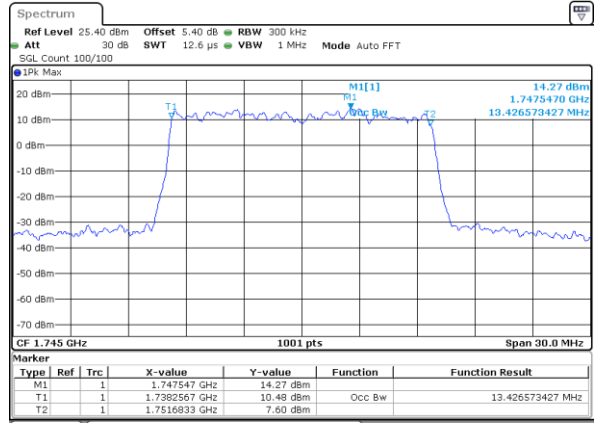

Highest Channel / 15MHz / QPSK

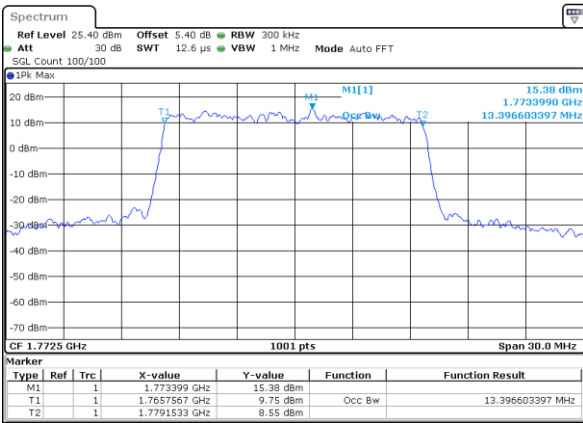

Highest Channel / 15MHz / 16QAM

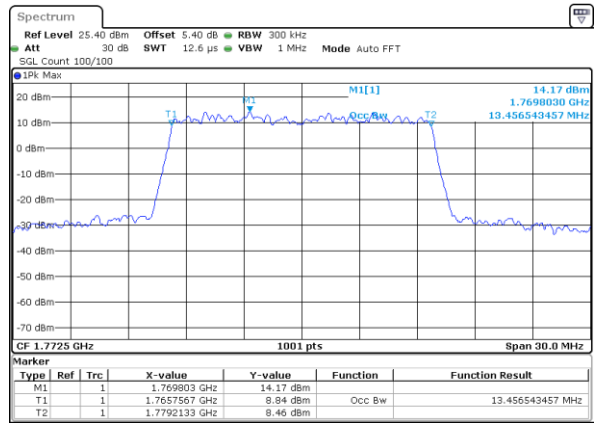



LTE Band 66

Lowest Channel / 20MHz / QPSK

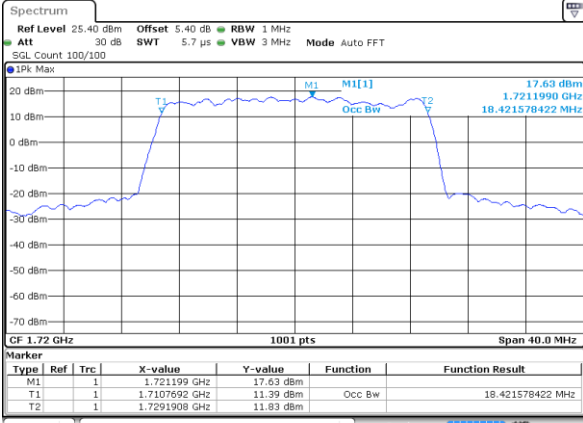

Lowest Channel / 20MHz / 16QAM

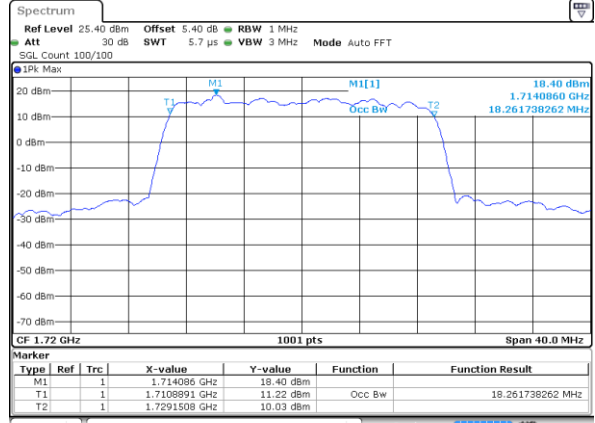

Middle Channel / 20MHz / QPSK

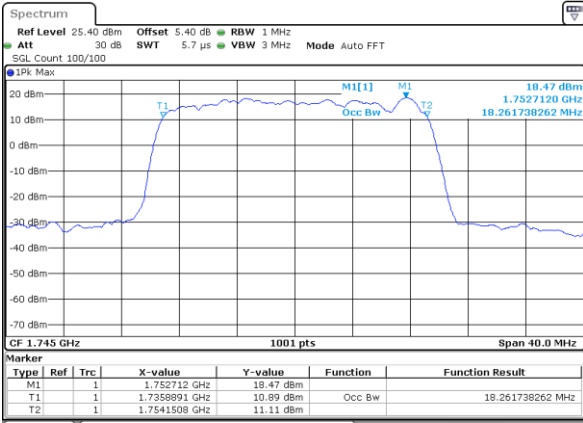

Middle Channel / 20MHz / 16QAM

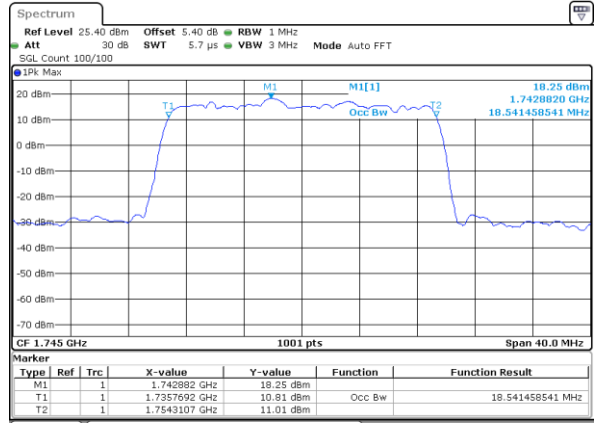

Highest Channel / 20MHz / QPSK

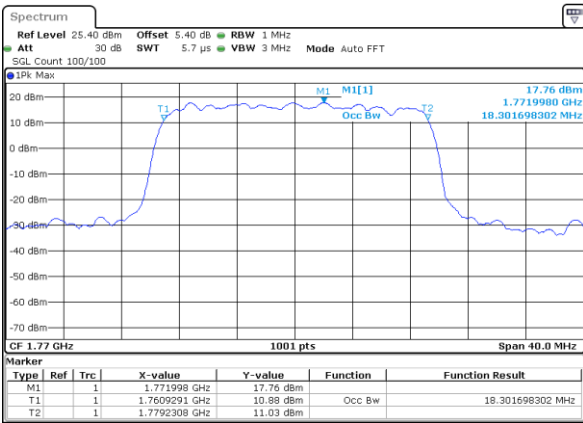

Highest Channel / 20MHz / 16QAM

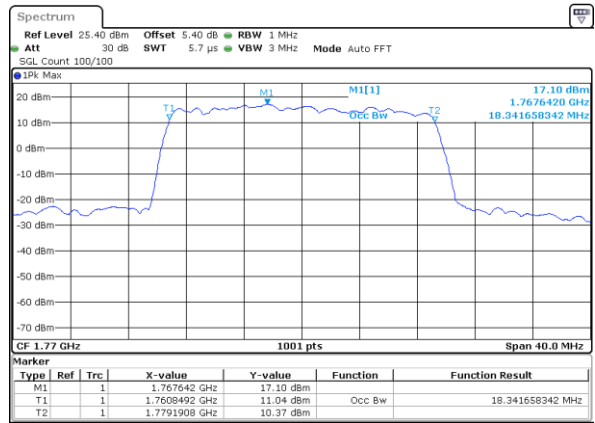



LTE Band 66

Lowest Channel / 1.4MHz / 64QAM

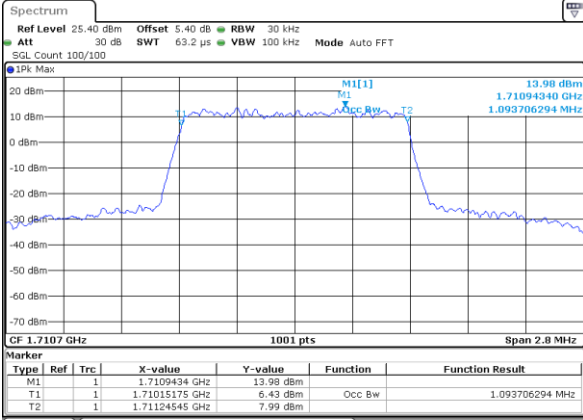

Lowest Channel / 3MHz / 64QAM

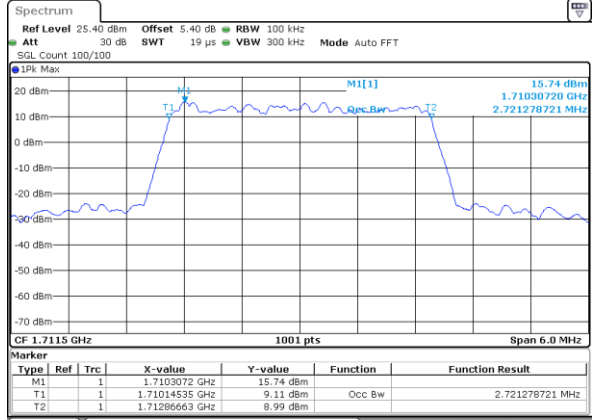

Middle Channel / 20MHz / 64QAM

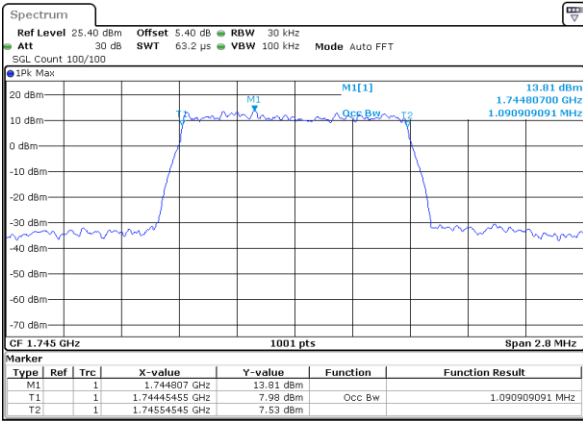

Middle Channel / 3MHz / 64QAM

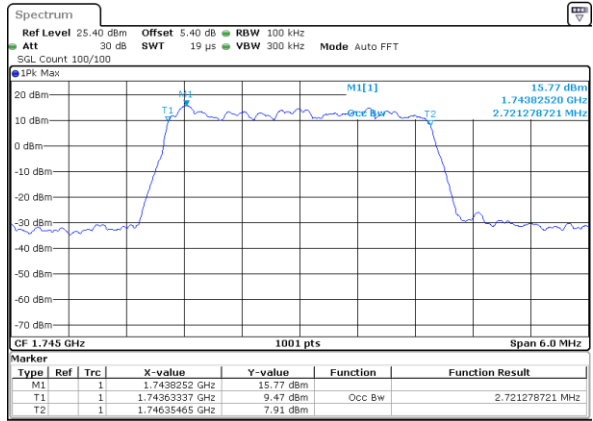

Highest Channel / 20MHz / 64QAM

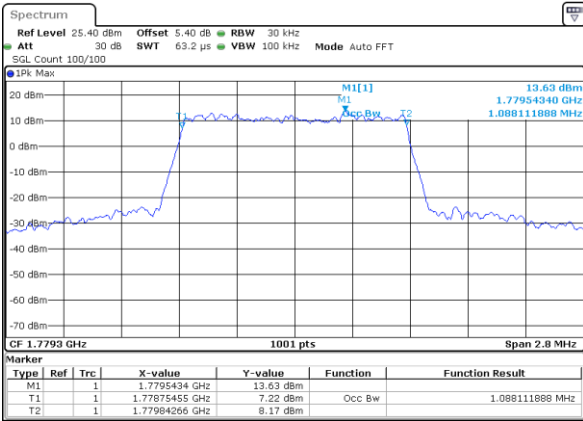

Highest Channel / 3MHz / 64QAM

