



# FCC RF Test Report

**APPLICANT** : Motorola Mobility LLC  
**EQUIPMENT** : Mobile Cellular Phone  
**BRAND NAME** : Motorola  
**MODEL NAME** : XT2067-1  
**FCC ID** : IHDT56YR1  
**STANDARD** : FCC Part 15 Subpart E §15.407  
**CLASSIFICATION** : (NII) Unlicensed National Information Infrastructure

The product was received on Jan. 18, 2020 and testing was completed on Apr. 10, 2020. We, Sporton International (Kunshan) Inc., would like to declare that the tested sample has been evaluated in accordance with the test procedures and has been in compliance with the applicable technical standards.

The test results in this report apply exclusively to the tested model / sample. Without written approval of Sporton International (Kunshan) Inc., the test report shall not be reproduced except in full.

*Jason Jia*

Reviewed by: Jason Jia / Supervisor

*James Huang*

Approved by: James Huang / Manager



**Sporton International (Kunshan) Inc.**

**No. 1098, Pengxi North Road, Kunshan Economic Development Zone Jiangsu Province 215300  
People's Republic of China**



# TABLE OF CONTENTS

**REVISION HISTORY..... 3**

**SUMMARY OF TEST RESULT ..... 4**

**1 GENERAL DESCRIPTION ..... 5**

    1.1 Applicant ..... 5

    1.2 Manufacturer ..... 5

    1.3 Product Feature of Equipment Under Test ..... 5

    1.4 Product Specification of Equipment Under Test ..... 6

    1.5 Modification of EUT ..... 7

    1.6 Specification of Accessory ..... 7

    1.7 Testing Location ..... 9

    1.8 Test Software ..... 9

    1.9 Applicable Standards ..... 9

**2 TEST CONFIGURATION OF EQUIPMENT UNDER TEST ..... 10**

    2.1 Carrier Frequency and Channel ..... 10

    2.2 Test Mode ..... 11

    2.3 Connection Diagram of Test System ..... 13

    2.4 Support Unit used in test configuration and system ..... 14

    2.5 EUT Operation Test Setup ..... 14

    2.6 Measurement Results Explanation Example ..... 14

**3 TEST RESULT ..... 15**

    3.1 26dB & 99% Occupied Bandwidth Measurement ..... 15

    3.2 Maximum Conducted Output Power Measurement ..... 17

    3.3 Power Spectral Density Measurement ..... 19

    3.4 Unwanted Emissions Measurement ..... 21

    3.5 AC Conducted Emission Measurement ..... 27

    3.6 Automatically Discontinue Transmission ..... 29

    3.7 Antenna Requirements ..... 30

**4 LIST OF MEASURING EQUIPMENT ..... 31**

**5 UNCERTAINTY OF EVALUATION ..... 32**

**APPENDIX A. CONDUCTED TEST RESULTS**

**APPENDIX B. AC CONDUCTED EMISSION TEST RESULT**

**APPENDIX C. RADIATED SPURIOUS EMISSION**

**APPENDIX D. DUTY CYCLE PLOTS**

**APPENDIX E. SETUP PHOTOGRAPHS**



### REVISION HISTORY

REPORT NO.	VERSION	DESCRIPTION	ISSUED DATE
FR011801D	Rev. 01	Initial issue of report	Apr. 22, 2020



### SUMMARY OF TEST RESULT

Report Section	FCC Rule	Description	Limit	Result	Remark
3.1	2.1049 & 15.403(i)	26dB & 99% Bandwidth	-	Pass	-
3.2	15.407(a)	Maximum Conducted Output Power	≤ 24 dBm	Pass	-
3.3	15.407(a)	Power Spectral Density	≤ 11 dBm	Pass	-
3.4	15.407(b)	Unwanted Emissions	15.407(b) & 15.209(a)	Pass	Under limit 3.10 dB at 5149.920 MHz
3.5	15.207	AC Conducted Emission	15.207(a)	Pass	Under limit 8.08 dB at 0.201 MHz
3.6	15.407(c)	Automatically Discontinue Transmission	Discontinue Transmission	Pass	-
3.7	15.203 & 15.407(a)	Antenna Requirement	N/A	Pass	-

<b>Declaration of Conformity:</b>
The test results with all measurement uncertainty excluded are presented in accordance with the regulation limits or requirements declared by manufacturers.
<b>Comments and Explanations:</b>
The declared of product specification for EUT presented in the report are provided by the manufacturer, and the manufacturer takes all the responsibilities for the accuracy of product specification.



# 1 General Description

## 1.1 Applicant

Motorola Mobility LLC  
222 W,Merchandise Mart Plaza, Chicago IL 60654 USA

## 1.2 Manufacturer

Motorola Mobility LLC  
222 W,Merchandise Mart Plaza, Chicago IL 60654 USA

## 1.3 Product Feature of Equipment Under Test

Product Feature	
Equipment	Mobile Cellular Phone
Brand Name	Motorola
Model Name	XT2067-1
FCC ID	IHDT56YR1
EUT supports Radios application	GSM/WCDMA/LTE WLAN 2.4GHz 802.11b/g/n HT20 WLAN 5GHz 802.11a/n HT20/HT40 WLAN 5GHz 802.11ac VHT20/VHT40/VHT80 Bluetooth BR/EDR/LE FM Receiver and GNSS
IMEI Code	Conducted: 351643110017052/351643110017060 Conduction: 351643110015619/351643110015627 Radiation: 351643110025071/351643110025089
HW Version	DVT2
SW Version	QPI30.56
EUT Stage	Identical Prototype

**Remark:**

1. The above EUT's information was declared by manufacturer. Please refer to the specifications or user's manual for more detailed description.
2. There are two types of EUT, the sample 1 is dual SIM slot and the sample 2 is single SIM slot. According to the difference, we evaluate the sample 1 to perform test.



### 1.4 Product Specification of Equipment Under Test

Standards-related Product Specification	
<b>Tx/Rx Frequency Range</b>	5180 MHz ~ 5240 MHz 5260 MHz ~ 5320 MHz 5500 MHz ~ 5700 MHz
<b>Maximum Output Power to Antenna</b>	<p><b>&lt;5180 MHz ~ 5240 MHz&gt;</b>  802.11a : 18.08 dBm / 0.0643 W  802.11n HT20 : 18.19 dBm / 0.0659 W  802.11n HT40 : 16.58 dBm / 0.0455 W  802.11ac VHT20 : 15.90 dBm / 0.0389 W  802.11ac VHT40 : 15.44 dBm / 0.0350 W  802.11ac VHT80 : 13.10 dBm / 0.0204 W</p> <p><b>&lt;5260 MHz ~ 5320 MHz&gt;</b>  802.11a : 18.02 dBm / 0.0634 W  802.11n HT20 : 18.01 dBm / 0.0632 W  802.11n HT40 : 16.89 dBm / 0.0489 W  802.11ac VHT20 : 15.96 dBm / 0.0394 W  802.11ac VHT40 : 16.07 dBm / 0.0405 W  802.11ac VHT80 : 15.07 dBm / 0.0321 W</p> <p><b>&lt;5500 MHz ~ 5700 MHz &gt;</b>  802.11a : 18.16 dBm / 0.0655 W  802.11n HT20 : 18.15 dBm / 0.0653 W  802.11n HT40 : 17.11 dBm / 0.0514 W  802.11ac VHT20 : 16.05 dBm / 0.0403 W  802.11ac VHT40 : 16.01 dBm / 0.0399 W  802.11ac VHT80 : 16.04 dBm / 0.0402 W</p>
<b>99% Occupied Bandwidth</b>	<p><b>&lt;5180 MHz ~ 5240 MHz&gt;</b>  802.11a : 18.63 MHz  802.11n HT20 : 20.23 MHz  802.11n HT40 : 36.76 MHz  802.11ac VHT80 : 75.88 MHz</p> <p><b>&lt;5260 MHz ~ 5320 MHz&gt;</b>  802.11a : 18.38 MHz  802.11n HT20 : 20.48 MHz  802.11n HT40 : 36.86 MHz  802.11ac VHT80 : 76.00 MHz</p> <p><b>&lt;5500 MHz ~ 5700 MHz &gt;</b>  802.11a : 19.18 MHz  802.11n HT20 : 21.43 MHz  802.11n HT40 : 37.46 MHz  802.11ac VHT80 : 76.00 MHz</p>
<b>Antenna Type / Gain</b>	<p><b>&lt;5180 MHz ~ 5240 MHz&gt;</b>  PIFA Antenna with gain -6.00 dBi</p> <p><b>&lt;5260 MHz ~ 5320 MHz&gt;</b>  PIFA Antenna with gain -6.00 dBi</p> <p><b>&lt;5500 MHz ~ 5700 MHz&gt;</b>  PIFA Antenna with gain -6.00 dBi</p>
<b>Type of Modulation</b>	802.11a/n : OFDM (BPSK / QPSK / 16QAM / 64QAM) 802.11ac : OFDM (BPSK / QPSK / 16QAM / 64QAM / 256QAM)

**Note:** For 802.11n HT20 / ac VHT20 and 802.11n HT40 / ac VHT40 mode, the whole testing have



assessed only 802.11n HT20/HT40 by referring to their maximum conducted power.

### 1.5 Modification of EUT

No modifications are made to the EUT during all test items.

### 1.6 Specification of Accessory

Specification of Accessory			
AC Adapter 1(US)	Brand Name	Motorola(Chenyang)	Model Name SC-51
	Power Rating	I/P: 100-240 Vac, 600mA , O/P: 5/9/12Vdc, 3000/2000/1500mA	
AC Adapter 1(EU)	Brand Name	Motorola(Chenyang)	Model Name SC-52
	Power Rating	I/P: 100-240 Vac, 600mA , O/P: 5/9/12Vdc, 3000/2000/1500mA	
AC Adapter 1(UK)	Brand Name	Motorola(Chenyang)	Model Name SC-53UK
	Power Rating	I/P: 100-240 Vac, 600mA , O/P: 5/9/12Vdc, 3000/2000/1500mA	
AC Adapter 1(AU)	Brand Name	Motorola(Chenyang)	Model Name SC-55AU
	Power Rating	I/P: 100-240 Vac, 600mA , O/P: 5/9/12Vdc, 3000/2000/1500mA	
AC Adapter 1(AR)	Brand Name	Motorola(Chenyang)	Model Name SC-56
	Power Rating	I/P: 100-240 Vac, 600mA , O/P: 5/9/12Vdc, 3000/2000/1500mA	
AC Adapter 2(US)	Brand Name	Motorola(Acbel)	Model Name SC-51
	Power Rating	I/P: 100-240 Vac, 600mA , O/P: 5/9/12Vdc, 3000/2000/1500mA	
AC Adapter 2(EU)	Brand Name	Motorola(Acbel)	Model Name SC-52
	Power Rating	I/P: 100-240 Vac, 600mA , O/P: 5/9/12Vdc, 3000/2000/1500mA	
AC Adapter 2(AR)	Brand Name	Motorola(Acbel)	Model Name SC-56
	Power Rating	I/P: 100-240 Vac, 600mA , O/P: 5/9/12Vdc, 3000/2000/1500mA	
AC Adapter 3 (Chile)	Brand Name	Motorola(Salom)	Model Name SC-52
	Power Rating	I/P: 100-240 Vac, 600mA , O/P: 5/9/12Vdc, 3000/2000/1500mA	
AC Adapter 3(BR)	Brand Name	Motorola(Salom)	Model Name SC-57
	Power Rating	I/P: 100-240 Vac, 600mA , O/P: 5/9/12Vdc, 3000/2000/1500mA	
AC Adapter 3 (BR Local Build)	Brand Name	Motorola(Flex/Salom)	Model Name SC-57
	Power Rating	I/P: 100-240 Vac, 600mA , O/P: 5/9/12Vdc, 3000/2000/1500mA	
AC Adapter 4(IN)	Brand Name	Motorola(Salom)	Model Name SC-54
	Power Rating	I/P: 100-240 Vac, 600mA , O/P: 5/9/12Vdc, 3000/2000/1500mA	
AC Adapter 4 (IN Local Build)	Brand Name	Motorola(Axiom/Salom)	Model Name SC-54
	Power Rating	I/P: 100-240 Vac, 600mA , O/P: 5/9/12Vdc, 3000/2000/1500mA	
AC Adapter 5 (BR Local Build)	Brand Name	Motorola(Cliptech/Tenpao)	Model Name SC-57
	Power Rating	I/P: 100-240 Vac, 600mA , O/P: 5/9/12Vdc, 3000/2000/1500mA	



<b>Battery</b>	<b>Brand Name</b>	Motorola	<b>Model Name</b>	LG50
	<b>Power Rating</b>	3.8Vdc, 5000mAh	<b>Type</b>	Li-ion
<b>Earphone 1</b>	<b>Brand Name</b>	Motorola(Lianyun)	<b>Model Name</b>	MI181(SH38C37773)
	<b>Signal Line Type</b>	1.1 meter, non-shielded cable, without ferrite core		
<b>Earphone 2</b>	<b>Brand Name</b>	Motorola(Cosonic)	<b>Model Name</b>	MI181(SH38C44959)
	<b>Signal Line Type</b>	1.1 meter, non-shielded cable, without ferrite core		
<b>USB Cable 1</b>	<b>Brand Name</b>	Motorola (Saibao)	<b>Model Name</b>	SC18C24367
	<b>Signal Line Type</b>	1.0 meter, shielded cable, without ferrite core		
<b>USB Cable 2</b>	<b>Brand Name</b>	Motorola (Luxshare)	<b>Model Name</b>	SC18C24368
	<b>Signal Line Type</b>	1.0 meter, shielded cable, without ferrite core		
<b>USB Cable 3</b>	<b>Brand Name</b>	Motorola (I SHENG)	<b>Model Name</b>	SC18C28955
	<b>Signal Line Type</b>	1.0 meter, shielded cable, without ferrite core		





### 1.7 Testing Location

Sporton International (Kunshan) Inc. is accredited to ISO/IEC 17025:2017 by American Association for Laboratory Accreditation with Certificate Number 5145.02.

<b>Test Firm</b>	Sporton International (Kunshan) Inc.		
<b>Test Site Location</b>	No. 1098, Pengxi North Road, Kunshan Economic Development Zone Jiangsu Province 215300 People's Republic of China TEL : +86-512-57900158 FAX : +86-512-57900958		
<b>Test Site No.</b>	<b>Sporton Site No.</b>	<b>FCC Designation No.</b>	<b>FCC Test Firm Registration No.</b>
	CO01-KS 03CH05-KS TH01-KS	CN1257	314309

### 1.8 Test Software

Item	Site	Manufacture	Name	Version
1.	03CH05-KS	AUDIX	E3	6.2009-8-24al
2.	CO01-KS	AUDIX	E3	6.2009-8-24

### 1.9 Applicable Standards

According to the specifications of the manufacturer, the EUT must comply with the requirements of the following standards:

- 47 CFR Part 15 Subpart E
- FCC KDB 789033 D02 General UNII Test Procedures New Rules v02r01.
- ANSI C63.10-2013

**Remark:**

1. All test items were verified and recorded according to the standards and without any deviation during the test.
2. This EUT has also been tested and complied with the requirements of FCC Part 15, Subpart B, recorded in a separate test report.



## 2 Test Configuration of Equipment Under Test

- a. The EUT has been associated with peripherals and configuration operated in a manner tended to maximize its emission characteristics in a typical application. Frequency range investigated: conduction emission (150 kHz to 30 MHz), radiation emission (9 kHz to the 10th harmonic of the highest fundamental frequency or to 40 GHz, whichever is lower). For radiated measurement, pre-scanned in three orthogonal panels, X, Y, Z. The worst cases (X plane) were recorded in this report.
- b. AC power line Conducted Emission was tested under maximum output power.

### 2.1 Carrier Frequency and Channel

Frequency Band	Channel	Freq. (MHz)	Channel	Freq. (MHz)
5180-5240 MHz Band 1 (U-NII-1)	36	5180	44	5220
	38*	5190	46*	5230
	40	5200	48	5240
	42 <sup>#</sup>	5210		

Frequency Band	Channel	Freq. (MHz)	Channel	Freq. (MHz)
5260-5320 MHz Band 2 (U-NII-2A)	52	5260	60	5300
	54*	5270	62*	5310
	56	5280	64	5320
	58 <sup>#</sup>	5290		

Frequency Band	Channel	Freq. (MHz)	Channel	Freq. (MHz)
5500-5700 MHz Band 3 (U-NII-2C)	100	5500	112	5560
	102*	5510	116	5580
	104	5520	132	5660
	106 <sup>#</sup>	5530	134*	5670
	108	5540	136	5680
	110*	5550	140	5700



Frequency Band	Channel	Freq. (MHz)	Channel	Freq. (MHz)
TDWR Channel	118*	5590	124	5620
	120	5600	126*	5630
	122 <sup>#</sup>	5610	128	5640

Note:

1. The above Frequency and Channel in "\*" were 802.11n HT40 and 802.11ac VHT40.
2. The above Frequency and Channel in "<sup>#</sup>" were 802.11ac VHT80.

## 2.2 Test Mode

Final test modes are considering the modulation and worse data rates as below table.

Modulation	Data Rate
802.11a	6 Mbps
802.11n HT20	MCS0
802.11n HT40	MCS0
802.11ac VHT80	MCS0

Test Cases	
AC Conducted Emission	Mode 1 : GSM 850 Idle + Bluetooth Link + WLAN Link(5G) + Earphone 1 + USB Cable 1(Charging from Adapter 1)
<b>Remark:</b> For Radiated Test Cases, The tests were performed with Adapter1, Earphone 1 and USB Cable 1.	



Ch. #		Band I : 5180-5240 MHz	Band II : 5260-5320 MHz	Band III : 5500-5700MHz
		802.11a	802.11a	802.11a
L	Low	36	52	100
M	Middle	44	60	116
H	High	48	64	140

Ch. #		Band I : 5180-5240 MHz	Band II : 5260-5320 MHz	Band III : 5500-5700MHz
		802.11n HT20	802.11n HT20	802.11n HT20
L	Low	36	52	100
M	Middle	44	60	116
H	High	48	64	140

Ch. #		Band I : 5180-5240 MHz	Band II : 5260-5320 MHz	Band III : 5500-5700MHz
		802.11n HT40	802.11n HT40	802.11n HT40
L	Low	38	54	102
M	Middle	-	-	110
H	High	46	62	134

Ch. #		Band I : 5180-5240 MHz	Band II : 5260-5320 MHz	Band III : 5500-5700MHz
		802.11ac VHT80	802.11ac VHT80	802.11ac VHT80
L	Low	-	-	106
M	Middle	42	58	-
H	High	-	-	122

### 2.3 Connection Diagram of Test System

For Radiation

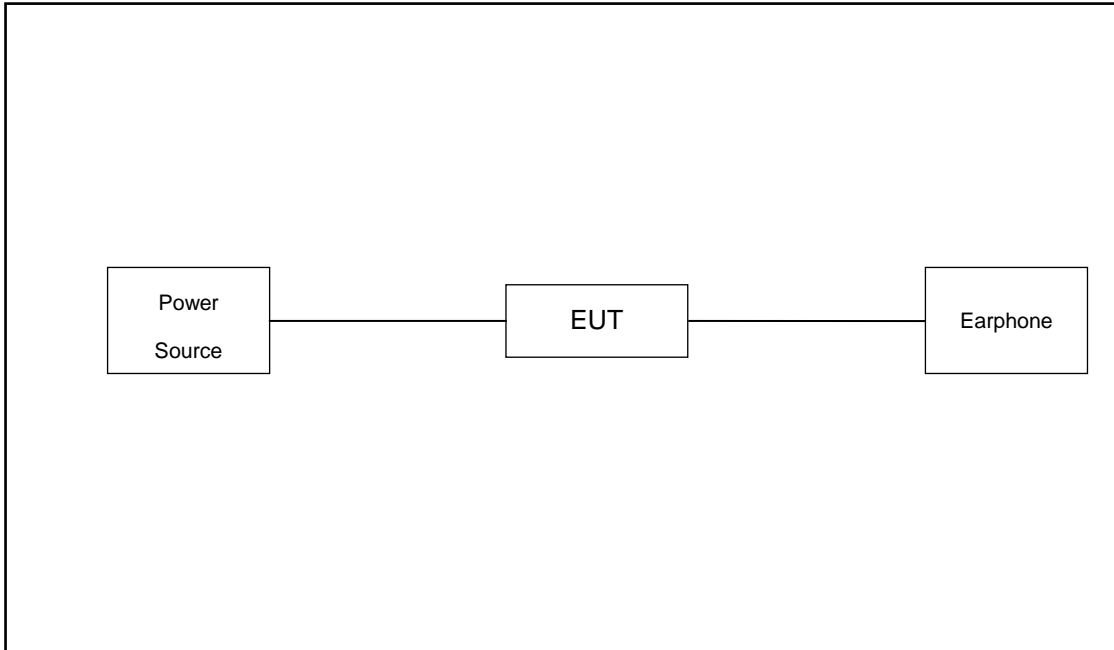

For Conducted Emission

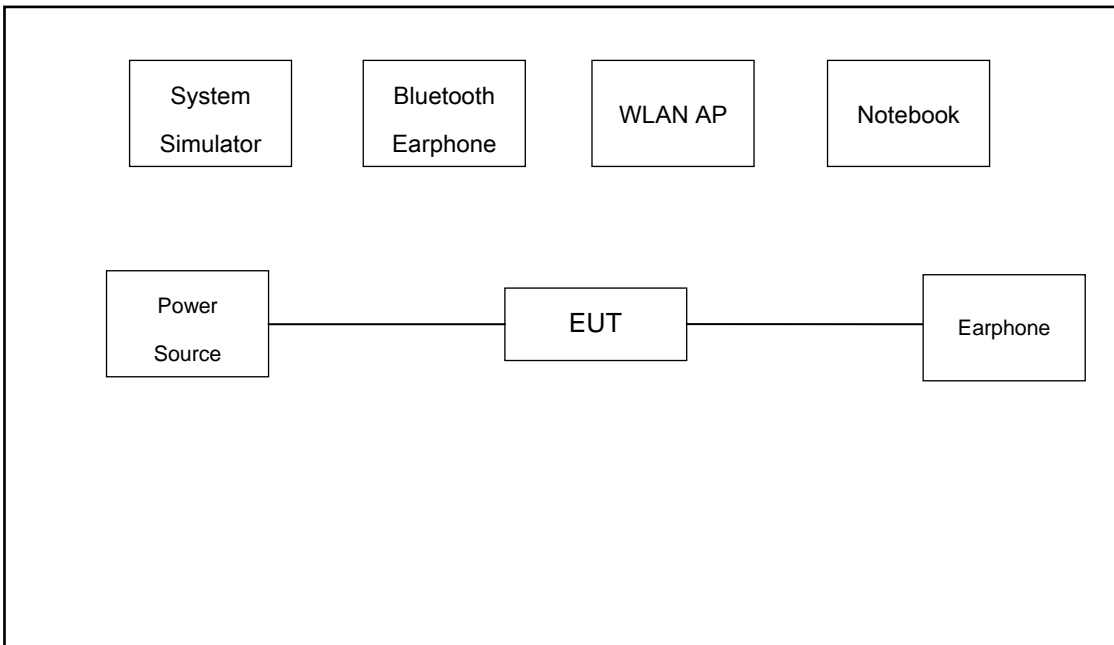

## 2.4 Support Unit used in test configuration and system

Item	Equipment	Trade Name	Model Name	FCC ID	Data Cable	Power Cord
1.	Base Station	Anritsu	MT8820C	N/A	N/A	Unshielded,1.8m
2.	Bluetooth Earphone	Lenovo	LBH308	N/A	N/A	N/A
3.	Notebook	Lenovo	G480	QDS-BRCM1050I	N/A	shielded cable DC O/P 1.8m , Unshielded AC I/P cable 1.8m
4.	WLAN AP	D-link	DIR-655	KA21R655B1	N/A	Unshielded,1.8m

## 2.5 EUT Operation Test Setup

For WLAN RF test items, an engineering test program was provided and enabled to make EUT continuously transmit/receive.

For AC power line conducted emissions, the EUT was set to connect with the WLAN AP under large package sizes transmission.

## 2.6 Measurement Results Explanation Example

**For all conducted test items:**

The offset level is set in the spectrum analyzer to compensate the RF cable loss and attenuator factor between EUT conducted output port and spectrum analyzer. With the offset compensation, the spectrum analyzer reading level is exactly the EUT RF output level.

Example :

The spectrum analyzer offset is derived from RF cable loss.

*Offset = RF cable loss*

Following shows an offset computation example with cable loss 6.3 dB.

$$\begin{aligned} \text{Offset(dB)} &= \text{RF cable loss(dB)}. \\ &= 6.3 \text{ (dB)} \end{aligned}$$

### 3 Test Result

#### 3.1 26dB & 99% Occupied Bandwidth Measurement

##### 3.1.1 Description of 26dB & 99% Occupied Bandwidth

This section is for reporting purpose only.

There is no restriction limits for bandwidth.

##### 3.1.2 Measuring Instruments

The measuring equipment is listed in the section 4 of this test report.

##### 3.1.3 Test Procedures

1. The testing follows FCC KDB 789033 D02 General UNII Test Procedures New Rules v02r01. Section C) Emission bandwidth
2. Set RBW = approximately 1% of the emission bandwidth.
3. Set the VBW > RBW.
4. Detector = Peak.
5. Trace mode = max hold
6. Measure the maximum width of the emission that is 26 dB down from the peak of the emission. Compare this with the RBW setting of the analyzer. Readjust RBW and repeat measurement as needed until the RBW/EBW ratio is approximately 1%.
7. For 99% Bandwidth Measurement, the spectrum analyzer's resolution bandwidth (RBW) is set 1MHz and set the Video bandwidth (VBW)  $\geq 3 * RBW$ .
8. Measure and record the results in the test report.

##### 3.1.4 Test Setup

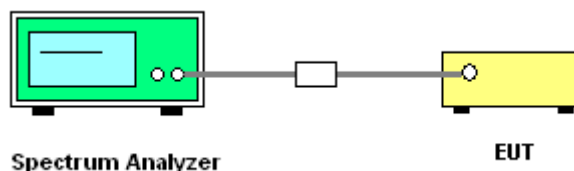



### 3.1.5 Test Result of 26dB & 99% Occupied Bandwidth

Please refer to Appendix A.

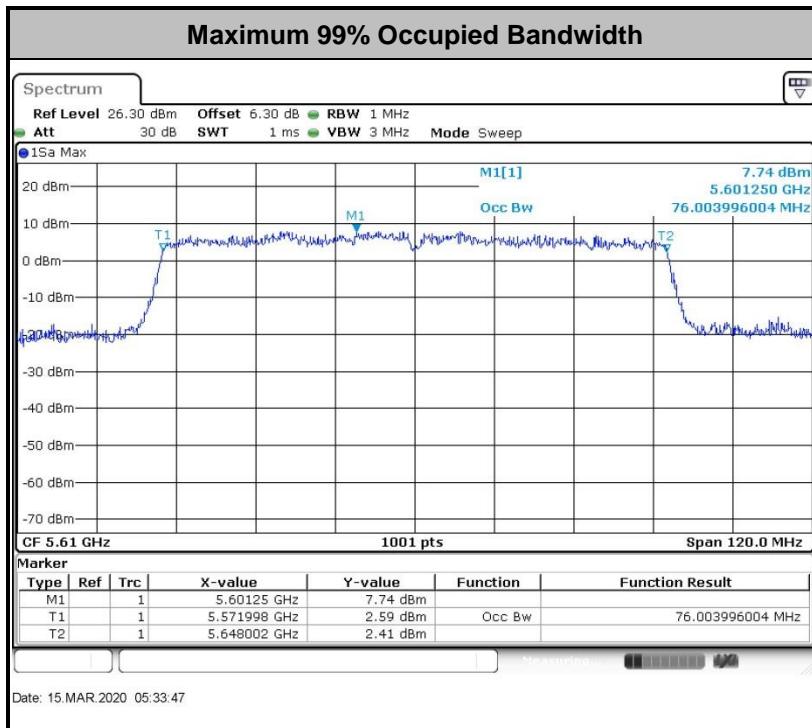
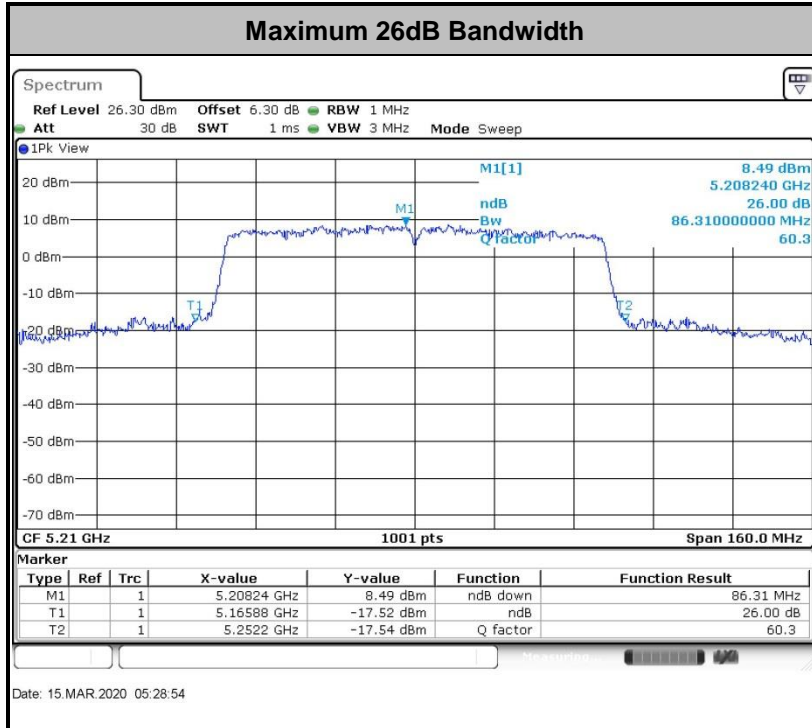

**Note:** The occupied channel bandwidth is maintained within the band of operation for all of the modulations.





## 3.2 Maximum Conducted Output Power Measurement

### 3.2.1 Limit of Maximum Conducted Output Power

<FCC 14-30 CFR 15.407>

For mobile and portable client devices in the 5.15–5.25 GHz band, the maximum conducted output power over the frequency band of operation shall not exceed 250 mW.

For the 5.25–5.725 GHz bands, the maximum conducted output power over the frequency bands of operation shall not exceed the lesser of 250 mW or 11 dBm  $10 \log B$ , where B is the 26 dB emission bandwidth in megahertz.

If transmitting antennas of directional gain greater than 6 dBi are used, the peak output power shall be reduced by the amount in dB that the directional gain of the antenna exceeds 6 dBi.

Note that U-NII-2 band, devices with a maximum e.i.r.p. greater than 500 mW shall implement TPC in order to have the capability to operate at least 6 dB below the maximum permitted e.i.r.p. of 1 W.

### 3.2.2 Measuring Instruments

The measuring equipment is listed in the section 4 of this test report.

### 3.2.3 Test Procedures

The testing follows Method PM of FCC KDB 789033 D02 General UNII Test Procedures New Rules v02r01.

Method PM (Measurement using an RF average power meter):

1. Measurement is performed using a wideband RF power meter.
2. The EUT is configured to transmit continuously with a consistent duty cycle at its maximum power control level.
3. Measure the average power of the transmitter, and the average power is corrected with duty factor,  $10 \log(1/x)$ , where x is the duty cycle.

### 3.2.4 Test Setup

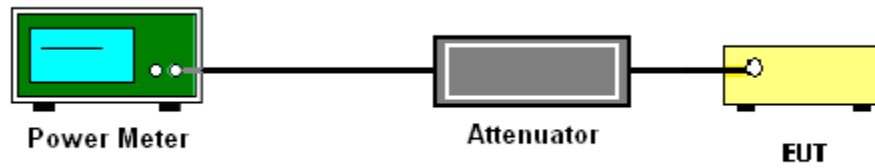

### 3.2.5 Test Result of Maximum Conducted Output Power

Please refer to Appendix A.



### 3.3 Power Spectral Density Measurement

#### 3.3.1 Limit of Power Spectral Density

<FCC 14-30 CFR 15.407>

For mobile and portable client devices in the 5.15–5.25 GHz band, the maximum power spectral density shall not exceed 11dBm in any 1 megahertz band.

For the 5.25–5.725 GHz bands, the maximum power spectral density shall not exceed 11 dBm in any 1 megahertz band.

If transmitting antennas of directional gain greater than 6 dBi are used, the peak output power shall be reduced by the amount in dB that the directional gain of the antenna exceeds 6 dBi.

#### 3.3.2 Measuring Instruments

The measuring equipment is listed in the section 4 of this test report.

#### 3.3.3 Test Procedures

The testing follows FCC KDB 789033 D02 General UNII Test Procedures New Rules v02r01. Section F) Maximum power spectral density.

**# Method SA-2 #**

(trace averaging across on and off times of the EUT transmissions, followed by duty cycle correction).

- Measure the duty cycle.
  - Set span to encompass the entire emission bandwidth (EBW) of the signal.
  - Set RBW = 1 MHz.
  - Set VBW  $\geq$  3 MHz.
  - Number of points in sweep  $\geq$  2 Span / RBW.
  - Sweep time = auto.
  - Detector = RMS
  - Trace average at least 100 traces in power averaging mode.
  - Add  $10 \log(1/x)$ , where x is the duty cycle, to the measured power in order to compute the average power during the actual transmission times. For example, add  $10 \log(1/0.25) = 6$  dB if the duty cycle is 25 percent.
1. The RF output of EUT was connected to the spectrum analyzer by a low loss cable.
  2. Each plot has already offset with cable loss, and attenuator loss. Measure the PPSD and record it.





### 3.4 Unwanted Emissions Measurement

This section is to measure unwanted emissions through radiated measurement for band edge spurious emissions and out of band emissions measurement.

#### 3.4.1 Limit of Unwanted Emissions

- (1) For transmitters operating in the 5150-5250 MHz band: all emissions outside of the 5150-5350 MHz band shall not exceed an EIRP of -27dBm/MHz.

For transmitters operating in the 5250-5350 MHz band: all emissions outside of the 5150-5350 MHz band shall not exceed an EIRP of -27 dBm/MHz. Devices operating in the 5250-5350 MHz band that generate emissions in the 5150-5250 MHz band must meet all applicable technical requirements for operation in the 5150-5250 MHz band (including indoor use) or alternatively meet an out-of-band emission EIRP limit of -27 dBm/MHz in the 5150-5250 MHz band.

For transmitters operating in the 5470-5600 MHz and 5650-5725MHz band: all emissions outside of the 5470-5600 MHz and 5650-5725MHz band shall not exceed an EIRP of -27 dBm/MHz.

- (2) Unwanted spurious emissions fallen in restricted bands shall comply with the general field strength limits as below table,

Frequency (MHz)	Field Strength (microvolts/meter)	Measurement Distance (meters)
0.009 – 0.490	2400/F(kHz)	300
0.490 – 1.705	24000/F(kHz)	30
1.705 – 30.0	30	30
30 – 88	100	3
88 – 216	150	3
216 - 960	200	3
Above 960	500	3



EIRP (dBm)	Field Strength at 3m (dBµV/m)
- 27	68.3

**Note:** The following formula is used to convert the EIRP to field strength.

$$EIRP = E_{Meas} + 20\log (d_{Meas}) - 104.7$$

where

EIRP is the equivalent isotropically radiated power, in dBm

$E_{Meas}$  is the field strength of the emission at the measurement distance, in dBµV/m

$d_{Meas}$  is the measurement distance, in m

### 3.4.2 Measuring Instruments

The measuring equipment is listed in the section 4 of this test report.



### 3.4.3 Test Procedures

1. The testing follows FCC KDB 789033 D02 General UNII Test Procedures New Rules v02r01. Section G) Unwanted emissions measurement.
  - (1) Procedure for Unwanted Emissions Measurements Below 1000MHz
    - RBW = 120 kHz
    - VBW = 300 kHz
    - Detector = Peak
    - Trace mode = max hold
  - (2) Procedure for Peak Unwanted Emissions Measurements Above 1000 MHz
    - RBW = 1 MHz
    - VBW  $\geq$  3 MHz
    - Detector = Peak
    - Sweep time = auto
    - Trace mode = max hold
  - (3) Procedures for Average Unwanted Emissions Measurements Above 1000MHz
    - RBW = 1 MHz
    - VBW = 10 Hz, when duty cycle is no less than 98 percent.
    - VBW  $\geq$  1/T, when duty cycle is less than 98 percent where T is the minimum transmission duration over which the transmitter is on and is transmitting at its maximum power control level for the tested mode of operation.
2. The EUT was placed on a turntable with 0.8 meter for frequency below 1GHz and 1.5 meter for frequency above 1GHz respectively above ground.
3. The EUT was set 3 meters from the interference receiving antenna which was mounted on the top of a variable height antenna tower.
4. The antenna is a broadband antenna and its height is adjusted between one meter and four meters above ground to find the maximum value of the field strength for both horizontal polarization and vertical polarization of the antenna.
5. For each suspected emission, the EUT was arranged to its worst case and then adjust the antenna tower (from 1 m to 4 m) and turntable (from 0 degree to 360 degrees) to find the maximum reading.
6. For testing below 1GHz, if the emission level of the EUT in peak mode was 3 dB lower than the limit specified, then peak values of EUT will be reported, otherwise, the emissions will be repeated one by one using the CISPR quasi-peak method and reported.
7. For testing above 1GHz, the emission level of the EUT in peak mode was 20dB lower than average limit (that means the emission level in average mode also complies with the limit in average mode), then peak values of EUT will be reported, otherwise, the emissions will be measured in average mode again and reported.





### 3.4.4 Test Setup

For radiated emissions below 30MHz

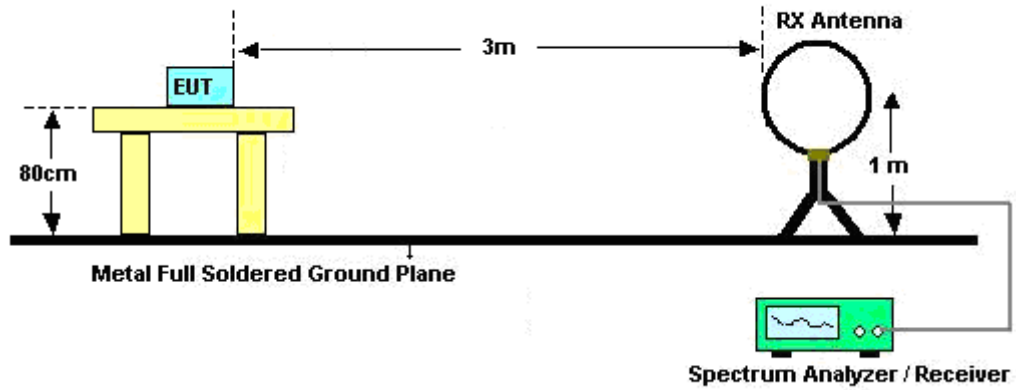

For radiated emissions from 30MHz to 1GHz

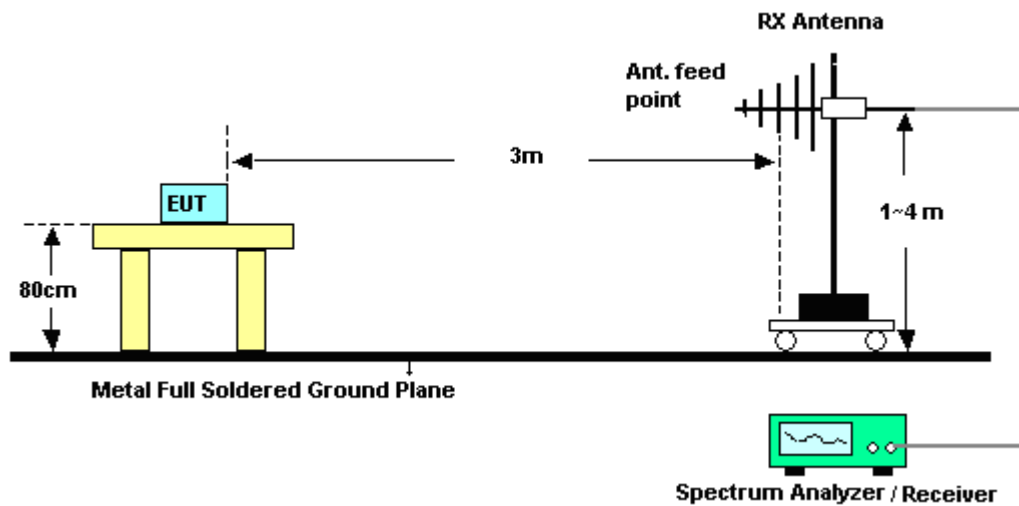

For radiated emissions above 1GHz

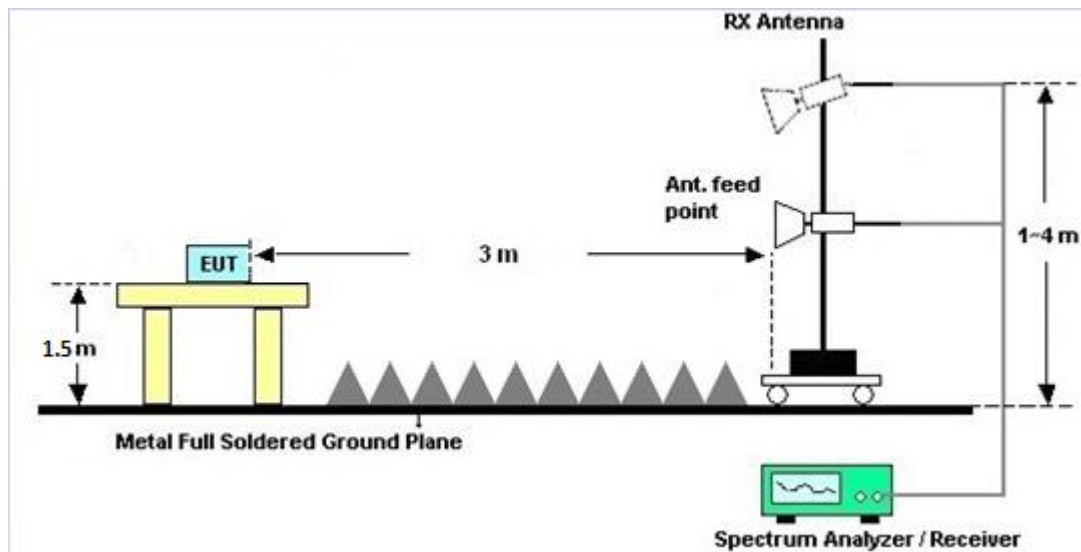

### 3.4.5 Test Results of Radiated Spurious Emissions (9 kHz ~ 30 MHz)

The low frequency, which started from 9 kHz to 30MHz, was pre-scanned and the result which was 20dB lower than the limit line was not reported.

There is a comparison data of both open-field test site and semi-Anechoic chamber, and the result came out very similar.

### 3.4.6 Test Result of Radiated Spurious at Band Edges

Please refer to Appendix C.

### 3.4.7 Duty Cycle

Please refer to Appendix D.

### 3.4.8 Test Result of Radiated Spurious Emissions (30MHz ~ 10th Harmonic)

Please refer to Appendix C.



### 3.5 AC Conducted Emission Measurement

#### 3.5.1 Limit of AC Conducted Emission

For equipment that is designed to be connected to the public utility (AC) power line, the radio frequency voltage that is conducted back onto the AC power line on any frequency or frequencies within the band 150 kHz to 30 MHz shall not exceed the limits in the following table.

Frequency of emission (MHz)	Conducted limit (dBµV)	
	Quasi-peak	Average
0.15-0.5	66 to 56*	56 to 46*
0.5-5	56	46
5-30	60	50

\*Decreases with the logarithm of the frequency.

#### 3.5.2 Measuring Instruments

The measuring equipment is listed in the section 4 of this test report.

#### 3.5.3 Test Procedures

1. The EUT was placed 0.4 meter from the conducting wall of the shielding room was kept at least 80 centimeters from any other grounded conducting surface.
2. Connect EUT to the power mains through a line impedance stabilization network (LISN).
3. All the support units are connecting to the other LISN.
4. The LISN provides 50 ohm coupling impedance for the measuring instrument.
5. The FCC states that a 50 ohm, 50 microhenry LISN should be used.
6. Both sides of AC line were checked for maximum conducted interference.
7. The frequency range from 150 kHz to 30 MHz was searched.
8. Set the test-receiver system to Peak Detect Function and specified bandwidth with Maximum Hold Mode.

### 3.5.4 Test Setup

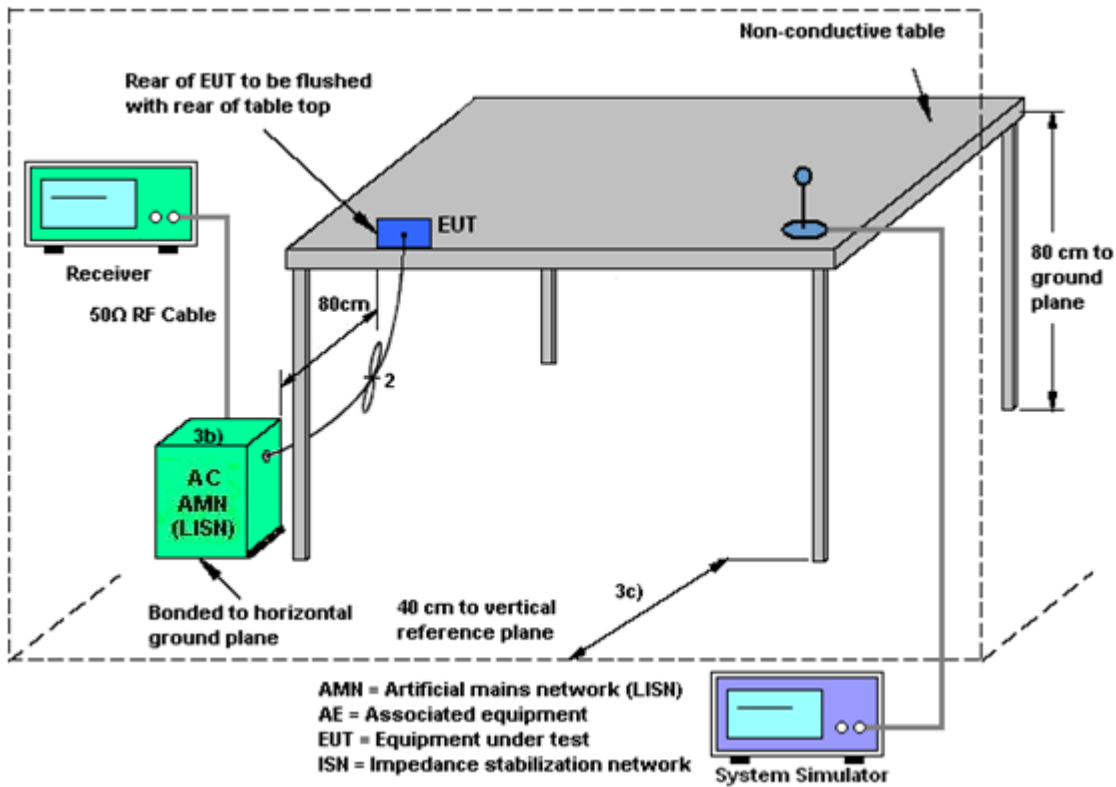

### 3.5.5 Test Result of AC Conducted Emission

Please refer to Appendix B.



## **3.6 Automatically Discontinue Transmission**

### **3.6.1 Limit of Automatically Discontinue Transmission**

The device shall automatically discontinue transmission in case of either absence of information to transmit or operational failure. These provisions are not intended to preclude the transmission of control or signaling information or the use of repetitive codes used by certain digital technologies to complete frame or burst intervals. Applicants shall include in their application for equipment authorization to describe how this requirement is met.

### **3.6.2 Measuring Instruments**

The measuring equipment is listed in the section 4 of this test report.

### **3.6.3 Test Result of Automatically Discontinue Transmission**

While the EUT is not transmitting any information, the EUT can automatically discontinue transmission and become standby mode for power saving. The EUT can detect the controlling signal of ACK message transmitting from remote device and verify whether it shall resend or discontinue transmission.



## **3.7 Antenna Requirements**

### **3.7.1 Standard Applicable**

If transmitting antenna directional gain is greater than 6 dBi, both the peak transmit power and the peak power spectral density shall be reduced by the amount in dB that the directional gain of the antenna exceeds 6 dBi.

### **3.7.2 Antenna Anti-Replacement Construction**

An embedded-in antenna design is used.

### **3.7.3 Antenna Gain**

The antenna peak gain of EUT is less than 6 dBi. Therefore, it is not necessary to reduce maximum peak output power limit.



## 4 List of Measuring Equipment

Instrument	Manufacturer	Model No.	Serial No.	Characteristics	Calibration Date	Test Date	Due Date	Remark
Spectrum Analyzer	R&S	FSV40	101040	10Hz~40GHz	Nov. 02, 2019	Mar. 15, 2020	Nov. 01, 2020	Conducted (TH01-KS)
Pulse Power Sensor	Anritsu	MA2411B	0917070	300MHz~40GHz	Jan. 08, 2020	Mar. 15, 2020	Jan. 07, 2021	Conducted (TH01-KS)
Power Meter	Anritsu	ML2495A	1005002	50MHz Bandwidth	Jan. 08, 2020	Mar. 15, 2020	Jan. 07, 2021	Conducted (TH01-KS)
EMI Test Receiver	Keysight	N9038A	MY57290151	3Hz~8.5GHz;Max 30dBm	Jul. 18, 2019	Apr. 10, 2020	Jul. 17, 2020	Radiation (03CH05-KS)
EXA Spectrum Analyzer	Keysight	N9010A	MY55150244	10Hz~44G,MAX 30dB	Apr. 16, 2019	Apr. 10, 2020	Apr. 15, 2020	Radiation (03CH05-KS)
Loop Antenna	R&S	HFH2-Z2	100321	9kHz~30MHz	Nov. 10, 2019	Apr. 10, 2020	Nov. 09, 2020	Radiation (03CH05-KS)
Bilog Antenna	TeseQ	CBL6111D	49922	30MHz~1GHz	May 30, 2019	Apr. 10, 2020	May 29, 2020	Radiation (03CH05-KS)
Double Ridge Horn Antenna	ETS-Lindgren	3117	00218652	1GHz~18GHz	Apr. 27, 2019	Apr. 10, 2020	Apr. 26, 2020	Radiation (03CH05-KS)
SHF-EHF Horn	Com-power	AH-840	101115	18GHz~40GHz	Nov. 10, 2019	Apr. 10, 2020	Nov. 09, 2020	Radiation (03CH05-KS)
Amplifier	SONOMA	310N	187289	9KHz~1GHz	Aug. 06, 2019	Apr. 10, 2020	Aug. 05, 2020	Radiation (03CH05-KS)
Amplifier	MITEQ	EM18G40GGA	060728	18~40GHz	Jan. 08, 2020	Apr. 10, 2020	Jan. 07, 2021	Radiation (03CH05-KS)
high gain Amplifier	MITEQ	AMF-7D-0010 1800-30-10P	2025788	1GHz~18Ghz	Aug. 17, 2019	Apr. 10, 2020	Aug. 16, 2020	Radiation (03CH05-KS)
Amplifier	Keysight	83017A	MY53270316	500MHz~26.5GHz	Oct. 18, 2019	Apr. 10, 2020	Oct. 17, 2020	Radiation (03CH05-KS)
AC Power Source	Chroma	61601	F104090004	N/A	NCR	Apr. 10, 2020	NCR	Radiation (03CH05-KS)
Turn Table	ChamPro	EM 1000-T	060762-T	0~360 degree	NCR	Apr. 10, 2020	NCR	Radiation (03CH05-KS)
Antenna Mast	ChamPro	EM 1000-A	060762-A	1 m~4 m	NCR	Apr. 10, 2020	NCR	Radiation (03CH05-KS)
EMI Receiver	R&S	ESCI7	100768	9kHz~7GHz;	Apr. 16, 2019	Mar. 18, 2020	Apr. 15, 2020	Conduction (CO01-KS)
AC LISN (for auxiliary equipment)	MessTec	AN3016	060103	9kHz~30MHz	Oct. 18, 2019	Mar. 18, 2020	Oct. 17, 2020	Conduction (CO01-KS)
AC LISN	MessTec	AN3016	060105	9kHz~30MHz	Oct. 28, 2019	Mar. 18, 2020	Oct. 27, 2020	Conduction (CO01-KS)
AC Power Source	Chroma	61602	ABP00000811	AC 0V~300V, 45Hz~1000Hz	Oct. 18, 2019	Mar. 18, 2020	Oct. 17, 2020	Conduction (CO01-KS)

NCR: No Calibration Required



## 5 Uncertainty of Evaluation

The measurement uncertainties shown below were calculated in accordance with the requirements of ANSI 63.10-2013. All the measurement uncertainty value were shown with a coverage K=2 to indicate 95% level of confidence. The measurement data show herein meets or exceeds the CISPR measurement uncertainty values specified in CISPR 16-4-2 and can be compared directly to specified limit to determine compliance.

### Uncertainty of Conducted Emission Measurement (150kHz ~ 30MHz)

Measuring Uncertainty for a Level of Confidence of 95% (U = 2Uc(y))	2.9dB
---	-------

### Uncertainty of Radiated Emission Measurement (30 MHz ~ 1000 MHz)

Measuring Uncertainty for a Level of Confidence of 95% (U = 2Uc(y))	5.0dB
---	-------

### Uncertainty of Radiated Emission Measurement (1000 MHz ~ 18000 MHz)

Measuring Uncertainty for a Level of Confidence of 95% (U = 2Uc(y))	5.0dB
---	-------

### Uncertainty of Radiated Emission Measurement (18000 MHz ~ 40000 MHz)

Measuring Uncertainty for a Level of Confidence of 95% (U = 2Uc(y))	5.0dB
---	-------





## Appendix A. Conducted Test Results

Report Number : FR011801D

Test Engineer:	Aaron Shen	Temperature:	21~25	°C
Test Date:	2020/3/15	Relative Humidity:	51~54	%

**TEST RESULTS DATA**  
**26dB and 99% OBW**

Band I										
Mod.	Data Rate	N <sub>Tx</sub>	CH.	Freq. (MHz)	99% Bandwidth (MHz)	26 dB Bandwidth (MHz)	IC 99% Bandwidth Power Limit (dBm)	IC 99% Bandwidth EIRP Limit (dBm)		
11a	6Mbps	1	36	5180	18.63	29.82	-	22.70		
11a	6Mbps	1	44	5220	18.33	30.67	-	22.63		
11a	6Mbps	1	48	5240	18.13	27.57	-	22.58		
HT20	MCS0	1	36	5180	20.03	33.47	-	23.01		
HT20	MCS0	1	44	5220	20.23	33.97	-	23.01		
HT20	MCS0	1	48	5240	19.58	31.82	-	22.92		
HT40	MCS0	1	38	5190	36.76	42.53	-	23.01		
HT40	MCS0	1	46	5230	36.66	41.90	-	23.01		
VHT80	MCS0	1	42	5210	75.88	86.31	-	23.01		

**TEST RESULTS DATA**  
**Average Power Table**

FCC Band I										
Mod.	Data Rate	N <sub>TX</sub>	CH.	Freq. (MHz)	Duty Factor (dB)	Average Conducted Power (dBm)	FCC Conducted Power Limit (dBm)	DG (dBi)		Pass/Fail
11a	6Mbps	1	36	5180	0.07	18.08	24.00	-6.00		Pass
11a	6Mbps	1	44	5220	0.07	17.82	24.00	-6.00		Pass
11a	6Mbps	1	48	5240	0.07	17.40	24.00	-6.00		Pass
HT20	MCS0	1	36	5180	0.08	18.19	24.00	-6.00		Pass
HT20	MCS0	1	44	5220	0.08	17.90	24.00	-6.00		Pass
HT20	MCS0	1	48	5240	0.08	17.57	24.00	-6.00		Pass
HT40	MCS0	1	38	5190	0.16	15.13	24.00	-6.00		Pass
HT40	MCS0	1	46	5230	0.16	16.58	24.00	-6.00		Pass
VHT20	MCS0	1	36	5180	0.08	15.90	24.00	-6.00		Pass
VHT20	MCS0	1	44	5220	0.08	15.70	24.00	-6.00		Pass
VHT20	MCS0	1	48	5240	0.08	15.17	24.00	-6.00		Pass
VHT40	MCS0	1	38	5190	0.16	14.94	24.00	-6.00		Pass
VHT40	MCS0	1	46	5230	0.16	15.44	24.00	-6.00		Pass
VHT80	MCS0	1	42	5210	0.31	13.10	24.00	-6.00		Pass

***TEST RESULTS DATA***  
***Power Spectral Density***

FCC Band I										
Mod.	Data Rate	N <sub>Tx</sub>	CH.	Freq. (MHz)	Duty Factor (dB)	Average Power Density (dBm/MHz)	Average PSD Limit (dBm/MHz)	DG (dBi)	-	Pass/Fail
11a	6Mbps	1	36	5180	0.07	7.90	11.00	-6.00		Pass
11a	6Mbps	1	44	5220	0.07	7.32	11.00	-6.00		Pass
11a	6Mbps	1	48	5240	0.07	7.44	11.00	-6.00		Pass
HT20	MCS0	1	36	5180	0.08	7.88	11.00	-6.00		Pass
HT20	MCS0	1	44	5220	0.08	7.61	11.00	-6.00		Pass
HT20	MCS0	1	48	5240	0.08	7.09	11.00	-6.00		Pass
HT40	MCS0	1	38	5190	0.16	3.60	11.00	-6.00		Pass
HT40	MCS0	1	46	5230	0.16	3.28	11.00	-6.00		Pass
VHT80	MCS0	1	42	5210	0.31	0.07	11.00	-6.00		Pass

**TEST RESULTS DATA**  
**26dB and 99% OBW**

Band II										
Mod.	Data Rate	N <sub>Tx</sub>	CH.	Freq. (MHz)	99% Bandwidth (MHz)	26 dB Bandwidth (MHz)	IC 99% Bandwidth Power Limit (dBm)	IC 99% Bandwidth EIRP Limit (dBm)	FCC 26dB Bandwidth Power Limit (dBm)	Note
11a	6M bps	1	52	5260	18.13	30.27	23.58	29.58	23.98	
11a	6M bps	1	60	5300	18.38	29.12	23.64	29.64	23.98	
11a	6M bps	1	64	5320	18.38	31.27	23.64	29.64	23.98	
HT20	MCS 0	1	52	5260	20.23	32.17	23.98	30.00	23.98	
HT20	MCS 0	1	60	5300	20.43	34.22	23.98	30.00	23.98	
HT20	MCS 0	1	64	5320	20.48	34.67	23.98	30.00	23.98	
HT40	MCS 0	1	54	5270	36.86	42.62	23.98	30.00	23.98	
HT40	MCS 0	1	62	5310	36.76	42.44	23.98	30.00	23.98	
VHT80	MCS 0	1	58	5290	76.00	85.67	23.98	30.00	23.98	

**TEST RESULTS DATA**  
**Average Power Table**

FCC Band II										
Mod.	Data Rate	N <sub>Tx</sub>	CH.	Freq. (MHz)	Duty Factor (dB)	Average Conducted Power (dBm)	FCC Conducted Power Limit (dBm)	DG (dBi)	EIRP Power Limit (dBm)	Pass/Fail
11a	6M bps	1	52	5260	0.07	17.68	23.98	-6.00	26.99	Pass
11a	6M bps	1	60	5300	0.07	18.02	23.98	-6.00	26.99	Pass
11a	6M bps	1	64	5320	0.07	17.78	23.98	-6.00	26.99	Pass
HT20	MCS 0	1	52	5260	0.08	18.01	23.98	-6.00	26.99	Pass
HT20	MCS 0	1	60	5300	0.08	17.99	23.98	-6.00	26.99	Pass
HT20	MCS 0	1	64	5320	0.08	17.87	23.98	-6.00	26.99	Pass
HT40	MCS 0	1	54	5270	0.16	16.77	23.98	-6.00	26.99	Pass
HT40	MCS 0	1	62	5310	0.16	16.89	23.98	-6.00	26.99	Pass
VHT20	MCS 0	1	52	5260	0.08	15.40	23.98	-6.00	26.99	Pass
VHT20	MCS 0	1	60	5300	0.08	15.96	23.98	-6.00	26.99	Pass
VHT20	MCS 0	1	64	5320	0.08	15.56	23.98	-6.00	26.99	Pass
VHT40	MCS 0	1	54	5270	0.16	15.92	23.98	-6.00	26.99	Pass
VHT40	MCS 0	1	62	5310	0.16	16.07	23.98	-6.00	26.99	Pass
VHT80	MCS 0	1	58	5290	0.31	15.07	23.98	-6.00	26.99	Pass

***TEST RESULTS DATA***  
***Power Spectral Density***

Band II										
Mod.	Data Rate	N <sub>TX</sub>	CH.	Freq. (MHz)	Duty Factor (dB)	Average Power Density (dBm/MHz)	Average PSD Limit (dBm/MHz)	DG (dBi)		Pass/Fail
11a	6M bps	1	52	5260	0.07	7.13	11.00	-6.00		Pass
11a	6M bps	1	60	5300	0.07	7.54	11.00	-6.00		Pass
11a	6M bps	1	64	5320	0.07	7.38	11.00	-6.00		Pass
HT20	MCS 0	1	52	5260	0.08	7.64	11.00	-6.00		Pass
HT20	MCS 0	1	60	5300	0.08	7.53	11.00	-6.00		Pass
HT20	MCS 0	1	64	5320	0.08	7.75	11.00	-6.00		Pass
HT40	MCS 0	1	54	5270	0.16	3.63	11.00	-6.00		Pass
HT40	MCS 0	1	62	5310	0.16	3.66	11.00	-6.00		Pass
VHT80	MCS 0	1	58	5290	0.31	-0.36	11.00	-6.00		Pass



**TEST RESULTS DATA**  
**26dB and 99% OBW**

Band III										
Mod.	Data Rate	N <sub>Tx</sub>	CH.	Freq. (MHz)	99% Bandwidth (MHz)	26 dB Bandwidth (MHz)	IC 99% Bandwidth Power Limit (dBm)	IC 99% Bandwidth EIRP Limit (dBm)	FCC 26dB Bandwidth Power Limit (dBm)	Note
11a	6M bps	1	100	5500	19.03	33.52	23.79	29.79	23.98	
11a	6M bps	1	116	5580	18.83	32.82	23.75	29.75	23.98	
11a	6M bps	1	140	5700	19.18	34.07	23.83	29.83	23.98	
HT20	MCS 0	1	100	5500	20.68	32.27	23.98	30.00	23.98	
HT20	MCS 0	1	116	5580	21.43	36.16	23.98	30.00	23.98	
HT20	MCS 0	1	140	5700	20.73	36.31	23.98	30.00	23.98	
HT40	MCS 0	1	102	5510	37.06	42.98	23.98	30.00	23.98	
HT40	MCS 0	1	110	5550	37.06	43.34	23.98	30.00	23.98	
HT40	MCS 0	1	134	5670	37.46	42.89	23.98	30.00	23.98	
VHT80	MCS 0	1	106	5530	75.88	84.88	23.98	30.00	23.98	
VHT80	MCS 0	1	122	5610	76.00	85.99	23.98	30.00	23.98	

**TEST RESULTS DATA**  
**Average Power Table**

FCC Band III										
Mod.	Data Rate	N <sub>Tx</sub>	CH.	Freq. (MHz)	Duty Factor (dB)	Average Conducted Power (dBm)	FCC Conducted Power Limit (dBm)	DG (dBi)	EIRP Power Limit (dBm)	Pass/Fail
11a	6M bps	1	100	5500	0.07	18.10	23.98	-6.00	26.99	Pass
11a	6M bps	1	116	5580	0.07	18.16	23.98	-6.00	26.99	Pass
11a	6M bps	1	140	5700	0.07	18.15	23.98	-6.00	26.99	Pass
HT20	MCS 0	1	100	5500	0.08	17.83	23.98	-6.00	26.99	Pass
HT20	MCS 0	1	116	5580	0.08	18.09	23.98	-6.00	26.99	Pass
HT20	MCS 0	1	140	5700	0.08	18.15	23.98	-6.00	26.99	Pass
HT40	MCS 0	1	102	5510	0.16	16.87	23.98	-6.00	26.99	Pass
HT40	MCS 0	1	110	5550	0.16	16.99	23.98	-6.00	26.99	Pass
HT40	MCS 0	1	134	5670	0.16	17.11	23.98	-6.00	26.99	Pass
VHT20	MCS 0	1	100	5500	0.08	15.40	23.98	-6.00	26.99	Pass
VHT20	MCS 0	1	116	5580	0.08	15.99	23.98	-6.00	26.99	Pass
VHT20	MCS 0	1	140	5700	0.08	16.05	23.98	-6.00	26.99	Pass
VHT40	MCS 0	1	102	5510	0.16	15.49	23.98	-6.00	26.99	Pass
VHT40	MCS 0	1	110	5550	0.16	15.67	23.98	-6.00	26.99	Pass
VHT40	MCS 0	1	134	5670	0.16	16.01	23.98	-6.00	26.99	Pass
VHT80	MCS 0	1	106	5530	0.31	13.83	23.98	-6.00	26.99	Pass
VHT80	MCS 0	1	122	5610	0.31	16.04	23.98	-6.00	26.99	Pass

***TEST RESULTS DATA***  
***Power Spectral Density***

Band III										
Mod.	Data Rate	N <sub>TX</sub>	CH.	Freq. (MHz)	Duty Factor (dB)	Average Power Density (dBm/MHz)	Average PSD Limit (dBm/MHz)	DG (dBi)		Pass/Fail
11a	6M bps	1	100	5500	0.07	7.71	11.00	-6.00		Pass
11a	6M bps	1	116	5580	0.07	7.63	11.00	-6.00		Pass
11a	6M bps	1	140	5700	0.07	7.70	11.00	-6.00		Pass
HT20	MCS 0	1	100	5500	0.08	7.51	11.00	-6.00		Pass
HT20	MCS 0	1	116	5580	0.08	7.89	11.00	-6.00		Pass
HT20	MCS 0	1	140	5700	0.08	7.78	11.00	-6.00		Pass
HT40	MCS 0	1	102	5510	0.16	3.42	11.00	-6.00		Pass
HT40	MCS 0	1	110	5550	0.16	3.66	11.00	-6.00		Pass
HT40	MCS 0	1	134	5670	0.16	3.80	11.00	-6.00		Pass
VHT80	MCS 0	1	106	5530	0.31	0.17	11.00	-6.00		Pass
VHT80	MCS 0	1	122	5610	0.31	-0.05	11.00	-6.00		Pass



## Appendix B. AC Conducted Emission Test Results

Test Engineer :	Amos Zhang	Temperature :	25.3~26.2°C
		Relative Humidity :	38~40%
Test Voltage :	120Vac / 60Hz	Phase :	Line
Remark :	All emissions not reported here are more than 10 dB below the prescribed limit.		

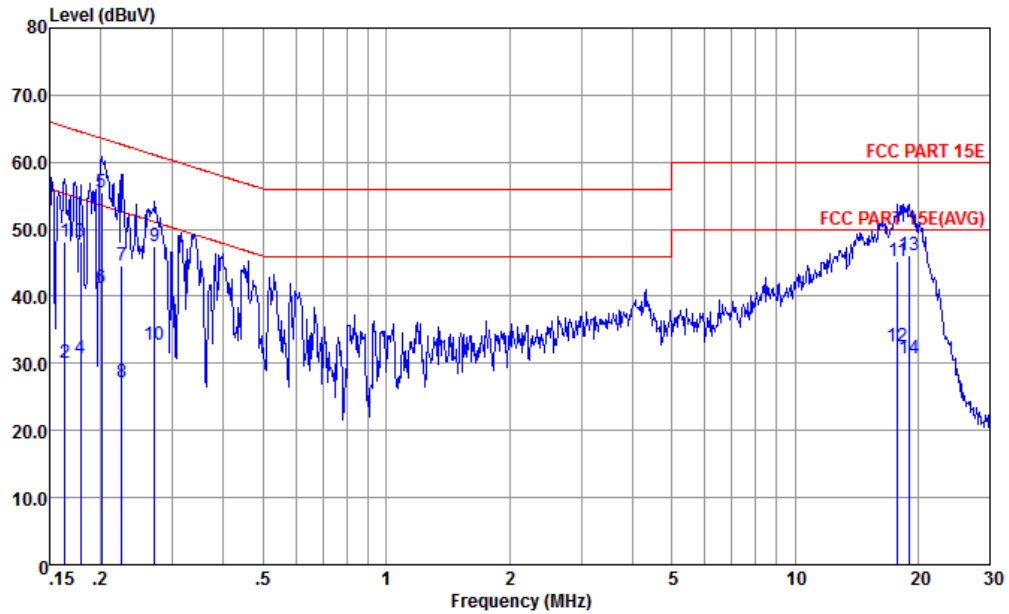

Site : CO01-KS  
 Condition : FCC PART 15E LISN-L-191028-060105 LINE

	Freq	Level	Over Limit	Limit Line	Read Level	LISN Factor	Cable Loss	Remark
	MHz	dBuV	dB	dBuV	dBuV	dB	dB	
1	0.163	48.08	-17.22	65.30	37.60	0.03	10.45	QP
2	0.163	30.08	-25.22	55.30	19.60	0.03	10.45	Average
3	0.179	48.05	-16.50	64.55	37.60	0.04	10.41	QP
4	0.179	30.65	-23.90	54.55	20.20	0.04	10.41	Average
5 *	0.201	55.50	-8.08	63.58	45.10	0.04	10.36	QP
6	0.201	41.30	-12.28	53.58	30.90	0.04	10.36	Average
7	0.226	44.59	-18.02	62.61	34.20	0.04	10.35	QP
8	0.226	27.29	-25.32	52.61	16.90	0.04	10.35	Average
9	0.272	47.57	-13.50	61.07	37.20	0.05	10.32	QP
10	0.272	32.67	-18.40	51.07	22.30	0.05	10.32	Average
11	17.849	45.19	-14.81	60.00	34.20	0.54	10.45	QP
12	17.849	32.49	-17.51	50.00	21.50	0.54	10.45	Average
13	19.021	46.17	-13.83	60.00	35.09	0.60	10.48	QP
14	19.021	30.67	-19.33	50.00	19.59	0.60	10.48	Average



Test Engineer :	Amos Zhang	Temperature :	25.3~26.2°C
		Relative Humidity :	38~40%
Test Voltage :	120Vac / 60Hz	Phase :	Neutral
Remark :	All emissions not reported here are more than 10 dB below the prescribed limit.		

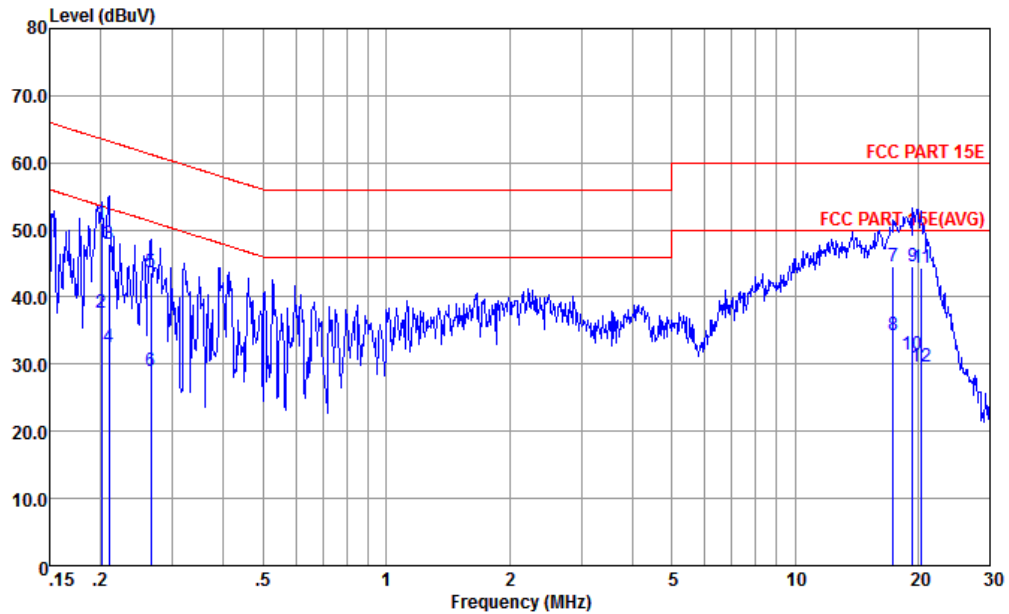

Site : CO01-KS  
 Condition : FCC PART 15E LISN-N-191028-060105 NEUTRAL

	Freq	Level	Over	Limit	Read	LISN	Cable	Remark
	MHz	dBuV	Limit	Line	Level	Factor	Loss	
			dB	dBuV	dBuV	dB	dB	
1 *	0.201	50.94	-12.64	63.58	40.50	0.08	10.36	QP
2	0.201	37.64	-15.94	53.58	27.20	0.08	10.36	Average
3	0.209	47.94	-15.29	63.23	37.50	0.08	10.36	QP
4	0.209	32.64	-20.59	53.23	22.20	0.08	10.36	Average
5	0.266	43.61	-17.64	61.25	33.20	0.09	10.32	QP
6	0.266	28.91	-22.34	51.25	18.50	0.09	10.32	Average
7	17.383	44.55	-15.45	60.00	33.59	0.51	10.45	QP
8	17.383	34.25	-15.75	50.00	23.29	0.51	10.45	Average
9	19.428	44.58	-15.42	60.00	33.50	0.60	10.48	QP
10	19.428	31.38	-18.62	50.00	20.30	0.60	10.48	Average
11	20.377	44.33	-15.67	60.00	33.20	0.63	10.50	QP
12	20.377	29.73	-20.27	50.00	18.60	0.63	10.50	Average

Note:

- Level(dBμV) = Read Level(dBμV) + LISN Factor(dB) + Cable Loss(dB)
- Over Limit(dB) = Level(dBμV) – Limit Line(dBμV)



### Appendix C. Radiated Spurious Emission

Band 1 - 5150~5250MHz  
WIFI 802.11a (Band Edge @ 3m)

WIFI Ant.	Note	Frequency	Level	Over Limit	Limit Line	Read Level	Antenna Factor	Cable Loss	Preamp Factor	Ant Pos	Table Pos	Peak Avg.	Pol.
1		( MHz )	( dBμV/m )	( dB )	( dBμV/m )	( dBμV )	( dB/m )	( dB )	( dB )	( cm )	( deg )	( P/A )	( H/V )
802.11a CH 36 5180MHz		5149.6	57.88	-16.12	74	44.63	34.07	10.43	31.25	111	116	P	H
		5149.98	47.7	-6.3	54	34.45	34.07	10.43	31.25	111	116	A	H
	*	5176	106.47	-	-	93.13	34.12	10.48	31.26	111	116	P	H
		5176	99.06	-	-	85.72	34.12	10.48	31.26	111	116	A	H
		5148.96	61.75	-12.25	74	48.5	34.07	10.43	31.25	100	142	P	V
		5149.98	48.32	-5.68	54	35.07	34.07	10.43	31.25	100	142	A	V
	*	5182	107.78	-	-	94.44	34.12	10.48	31.26	100	142	P	V
		5182	101.1	-	-	87.76	34.12	10.48	31.26	100	142	A	V
Remark	1. No other spurious found. 2. All results are PASS against Peak and Average limit line.												



Band 1 5150~5250MHz

WIFI 802.11a (Harmonic @ 3m)

WIFI Ant. 1	Note	Frequency ( MHz )	Level ( dBμV/m )	Over Limit ( dB )	Limit Line ( dBμV/m )	Read Level (dBμV)	Antenna Factor ( dB/m )	Cable Loss ( dB )	Preamp Factor ( dB )	Ant Pos ( cm )	Table Pos ( deg )	Peak Avg. (P/A)	Pol. (H/V)
802.11a CH 36		10360	49.1	-19.2	68.3	57.49	37.02	15.27	60.68	100	360	P	H
5180MHz		10360	50.46	-17.84	68.3	58.85	37.02	15.27	60.68	100	360	P	V
802.11a CH 44		10440	49.57	-18.73	68.3	57.85	37.06	15.32	60.66	100	360	P	H
5220MHz		10440	52.21	-16.09	68.3	60.49	37.06	15.32	60.66	100	360	P	V
802.11a CH 48		10480	49.56	-18.74	68.3	57.76	37.09	15.36	60.65	100	360	P	H
5240MHz		10480	52.48	-15.82	68.3	60.68	37.09	15.36	60.65	100	360	P	V
<b>Remark</b>	1. No other spurious found. 2. All results are PASS against Peak and Average limit line.												



**Band 1 5150~5250MHz**  
**WIFI 802.11n HT20 (Band Edge @ 3m)**

WIFI Ant. 1	Note	Frequency ( MHz )	Level ( dBμV/m )	Over Limit ( dB )	Limit Line ( dBμV/m )	Read Level (dBμV)	Antenna Factor ( dB/m )	Cable Loss ( dB )	Preamp Factor ( dB )	Ant Pos ( cm )	Table Pos ( deg )	Peak Avg. (P/A)	Pol. (H/V)
802.11n HT20 CH 36 5180MHz		5132.96	57.81	-16.19	74	44.61	34.05	10.4	31.25	100	115	P	H
		5149.98	48.31	-5.69	54	35.06	34.07	10.43	31.25	100	115	A	H
	*	5176	106	-	-	92.66	34.12	10.48	31.26	100	115	P	H
		5176	98.56	-	-	85.22	34.12	10.48	31.26	100	115	A	H
		5145.92	59.85	-14.15	74	46.6	34.07	10.43	31.25	100	148	P	V
		5149.98	48.8	-5.2	54	35.55	34.07	10.43	31.25	100	148	A	V
	*	5182	107.29	-	-	93.95	34.12	10.48	31.26	100	148	P	V
		5182	99.95	-	-	86.61	34.12	10.48	31.26	100	148	A	V
<b>Remark</b>	1. No other spurious found. 2. All results are PASS against Peak and Average limit line.												





**Band 1 5150~5250MHz**  
**WIFI 802.11n HT20 (Harmonic @ 3m)**

WIFI Ant. 1	Note	Frequency ( MHz )	Level ( dBμV/m )	Over Limit ( dB )	Limit Line ( dBμV/m )	Read Level (dBμV)	Antenna Factor ( dB/m )	Cable Loss ( dB )	Preamp Factor ( dB )	Ant Pos ( cm )	Table Pos ( deg )	Peak Avg. (P/A)	Pol. (H/V)
802.11n HT20 CH 36		10360	48.58	-19.72	68.3	56.97	37.02	15.27	60.68	100	360	P	H
5180MHz		10360	50.55	-17.75	68.3	58.94	37.02	15.27	60.68	100	360	P	V
802.11n HT20 CH 44		10440	49.04	-19.26	68.3	57.32	37.06	15.32	60.66	100	360	P	H
5220MHz		10440	54.58	-13.72	68.3	62.86	37.06	15.32	60.66	100	360	P	V
802.11n HT20 CH 48		10480	51.53	-16.77	68.3	59.73	37.09	15.36	60.65	100	360	P	H
5240MHz		10480	51.89	-16.41	68.3	60.09	37.09	15.36	60.65	100	360	P	V
<b>Remark</b>	1. No other spurious found. 2. All results are PASS against Peak and Average limit line.												



**Band 1 5150~5250MHz**  
**WIFI 802.11n HT40 (Band Edge @ 3m)**

WIFI Ant. 1	Note	Frequency ( MHz )	Level ( dBμV/m )	Over Limit ( dB )	Limit Line ( dBμV/m )	Read Level (dBμV)	Antenna Factor ( dB/m )	Cable Loss ( dB )	Preamp Factor ( dB )	Ant Pos ( cm )	Table Pos ( deg )	Peak Avg. (P/A)	Pol. (H/V)
802.11n HT40 CH 38 5190MHz		5149.76	58.77	-15.23	74	45.52	34.07	10.43	31.25	106	116	P	H
		5149.76	49.46	-4.54	54	36.21	34.07	10.43	31.25	106	116	A	H
	*	5188	99.23	-	-	85.89	34.12	10.48	31.26	106	116	P	H
		5188	91.7	-	-	78.36	34.12	10.48	31.26	106	116	A	H
		5352.3	53.71	-20.29	74	39.95	34.33	10.71	31.28	106	116	P	H
		5372.82	44.33	-9.67	54	30.53	34.35	10.73	31.28	106	116	A	H
		5146.72	59.95	-14.05	74	46.7	34.07	10.43	31.25	100	131	P	V
		5149.92	50.9	-3.1	54	37.65	34.07	10.43	31.25	100	131	A	V
	*	5194	102.13	-	-	88.74	34.14	10.51	31.26	100	131	P	V
		5194	94.65	-	-	81.26	34.14	10.51	31.26	100	131	A	V
		5383.26	53.16	-20.84	74	39.31	34.38	10.75	31.28	100	131	P	V
		5385.42	44.08	-9.92	54	30.23	34.38	10.75	31.28	100	131	A	V
<b>Remark</b>	1. No other spurious found. 2. All results are PASS against Peak and Average limit line.												



**Band 1 5150~5250MHz**  
**WIFI 802.11n HT40 (Harmonic @ 3m)**

WIFI Ant. 1	Note	Frequency ( MHz )	Level ( dBμV/m )	Over Limit ( dB )	Limit Line ( dBμV/m )	Read Level (dBμV)	Antenna Factor ( dB/m )	Cable Loss ( dB )	Preamp Factor ( dB )	Ant Pos ( cm )	Table Pos ( deg )	Peak Avg. (P/A)	Pol. (H/V)
802.11n HT40		10380	43.8	-24.5	68.3	52.16	37.03	15.28	60.67	100	360	P	H
CH 38 5190MHz		10380	45.42	-22.88	68.3	53.78	37.03	15.28	60.67	100	360	P	V
802.11n HT40		10460	45.82	-22.48	68.3	54.08	37.07	15.33	60.66	100	360	P	H
CH 46 5230MHz		10460	47.3	-21	68.3	55.56	37.07	15.33	60.66	100	360	P	V
<b>Remark</b>	1. No other spurious found. 2. All results are PASS against Peak and Average limit line.												



**Band 1 5150~5250MHz**  
**WIFI 802.11ac VHT80 (Band Edge @ 3m)**

WIFI Ant. 1	Note	Frequency ( MHz )	Level ( dBμV/m )	Over Limit ( dB )	Limit Line ( dBμV/m )	Read Level ( dBμV )	Antenna Factor ( dB/m )	Cable Loss ( dB )	Preamp Factor ( dB )	Ant Pos ( cm )	Table Pos ( deg )	Peak Avg. ( P/A )	Pol. ( H/V )
802.11ac VHT80 CH 42 5210MHz		5145.12	58.44	-15.56	74	45.19	34.07	10.43	31.25	109	242	P	H
		5135.36	48.52	-5.48	54	35.32	34.05	10.4	31.25	109	242	A	H
	*	5200	94.06	-	-	80.67	34.14	10.51	31.26	109	242	P	H
		5200	86.85	-	-	73.46	34.14	10.51	31.26	109	242	A	H
		5353.56	53.32	-20.68	74	39.56	34.33	10.71	31.28	109	242	P	H
		5353.2	44.44	-9.56	54	30.68	34.33	10.71	31.28	109	242	A	H
		5145.28	59.45	-14.55	74	46.2	34.07	10.43	31.25	100	136	P	V
		5145.44	50.63	-3.37	54	37.38	34.07	10.43	31.25	100	136	A	V
	*	5218	97.54	-	-	84.11	34.16	10.53	31.26	100	136	P	V
		5218	90.19	-	-	76.76	34.16	10.53	31.26	100	136	A	V
	5365.62	53.22	-20.78	74	39.42	34.35	10.73	31.28	100	136	P	V	
	5357.34	44.47	-9.53	54	30.71	34.33	10.71	31.28	100	136	A	V	
Remark	1. No other spurious found. 2. All results are PASS against Peak and Average limit line.												



Band 1 5150~5250MHz
WIFI 802.11ac VHT80 (Harmonic @ 3m)

Table with 14 columns: WIFI Ant., Note, Frequency (MHz), Level (dBµV/m), Over Limit (dB), Limit Line (dBµV/m), Read Level (dBµV), Antenna Factor (dB/m), Cable Loss (dB), Preamp Factor (dB), Ant Pos (cm), Table Pos (deg), Peak Avg. (P/A), Pol. (H/V). Rows include 802.11ac VHT80 and CH 42 5210MHz.

Remark

- 1. No other spurious found.
2. All results are PASS against Peak and Average limit line.



Band 2 - 5250~5350MHz
WIFI 802.11a (Band Edge @ 3m)

Table with 14 columns: WIFI, Note, Frequency, Level, Over, Limit, Read, Antenna, Cable, Preamp, Ant, Table, Peak, Pol. It contains test data for 802.11a CH 64 at 5320MHz and a Remark section.



Band 2 5250~5350MHz

WIFI 802.11a (Harmonic @ 3m)

WIFI Ant. 1	Note	Frequency ( MHz )	Level ( dBμV/m )	Over Limit ( dB )	Limit Line ( dBμV/m )	Read Level (dBμV)	Antenna Factor ( dB/m )	Cable Loss ( dB )	Preamp Factor ( dB )	Ant Pos ( cm )	Table Pos ( deg )	Peak Avg. (P/A)	Pol. (H/V)
802.11a CH 52 5260MHz		10520	49.9	-18.4	68.3	58.05	37.11	15.39	60.65	100	360	P	H
		10520	53.16	-15.14	68.3	61.31	37.11	15.39	60.65	100	360	P	V
802.11a CH 60 5300MHz		10600	52.75	-21.25	74	60.77	37.16	15.45	60.63	100	347	P	H
		10600	42.14	-11.86	54	50.16	37.16	15.45	60.63	100	347	A	H
		10600	56.42	-17.58	74	64.44	37.16	15.45	60.63	126	90	P	V
		10600	46.73	-7.27	54	54.75	37.16	15.45	60.63	126	90	A	V
802.11a CH 64 5320MHz		10640	56.18	-17.82	74	64.14	37.18	15.48	60.62	107	341	P	H
		10640	44.69	-9.31	54	52.65	37.18	15.48	60.62	107	341	A	H
		10640	58.38	-15.62	74	66.34	37.18	15.48	60.62	113	82	P	V
		10640	47.37	-6.63	54	55.33	37.18	15.48	60.62	113	82	A	V
Remark	1. No other spurious found. 2. All results are PASS against Peak and Average limit line.												



Band 2 5250~5350MHz
WIFI 802.11n HT20 (Band Edge @ 3m)

Table with 14 columns: WIFI Ant. 1, Note, Frequency (MHz), Level (dBµV/m), Over Limit (dB), Limit Line (dBµV/m), Read Level (dBµV), Antenna Factor (dB/m), Cable Loss (dB), Preamp Factor (dB), Ant Pos (cm), Table Pos (deg), Peak Avg. (P/A), Pol. (H/V). Rows include test data for 802.11n HT20 CH 64 5320MHz and a Remark section.





Band 2 5250~5350MHz
WIFI 802.11n HT20 (Harmonic @ 3m)

Table with 14 columns: WIFI Ant. 1, Note, Frequency (MHz), Level (dBµV/m), Over Limit (dB), Limit Line (dBµV/m), Read Level (dBµV), Antenna Factor (dB/m), Cable Loss (dB), Preamp Factor (dB), Ant Pos (cm), Table Pos (deg), Peak Avg. (P/A), Pol. (H/V). Rows include data for 802.11n HT20 CH 52 (5260MHz), 802.11n HT20 CH 60 (5300MHz), and 802.11n HT20 CH 64 (5320MHz). A Remark section at the bottom states: 1. No other spurious found. 2. All results are PASS against Peak and Average limit line.



**Band 2 5250~5350MHz**  
**WIFI 802.11n HT40 (Band Edge @ 3m)**

WIFI Ant. 1	Note	Frequency ( MHz )	Level ( dBμV/m )	Over Limit ( dB )	Limit Line ( dBμV/m )	Read Level (dBμV)	Antenna Factor ( dB/m )	Cable Loss ( dB )	Preamp Factor ( dB )	Ant Pos ( cm )	Table Pos ( deg )	Peak Avg. (P/A)	Pol. (H/V)
802.11n HT40 CH 62 5310MHz		5105.92	55.18	-18.82	74	42.02	34.03	10.38	31.25	100	114	P	H
		5134.56	45.64	-8.36	54	32.44	34.05	10.4	31.25	100	114	A	H
	*	5314	99.68	-	-	86	34.29	10.66	31.27	100	114	P	H
		5314	92.26	-	-	78.58	34.29	10.66	31.27	100	114	A	H
		5350.3	57.09	-16.91	74	43.33	34.33	10.71	31.28	100	114	P	H
		5350	46.94	-7.06	54	33.18	34.33	10.71	31.28	100	114	A	H
		5133.6	54.94	-19.06	74	41.74	34.05	10.4	31.25	100	129	P	V
		5102.56	45.59	-8.41	54	32.48	34.01	10.35	31.25	100	129	A	V
	*	5308	102.88	-	-	89.24	34.27	10.64	31.27	100	129	P	V
		5308	95.37	-	-	81.73	34.27	10.64	31.27	100	129	A	V
		5353.4	59.11	-14.89	74	45.35	34.33	10.71	31.28	100	129	P	V
		5350	49.81	-4.19	54	36.05	34.33	10.71	31.28	100	129	A	V
<b>Remark</b>	1. No other spurious found. 2. All results are PASS against Peak and Average limit line.												



Band 2 5250~5350MHz
WIFI 802.11n HT40 (Harmonic @ 3m)

Table with 14 columns: WIFI Ant. 1, Note, Frequency (MHz), Level (dBµV/m), Over Limit (dB), Limit Line (dBµV/m), Read Level (dBµV), Antenna Factor (dB/m), Cable Loss (dB), Preamp Factor (dB), Ant Pos (cm), Table Pos (deg), Peak Avg. (P/A), Pol. (H/V). Rows include data for 802.11n HT40 CH 54 at 10540MHz and CH 62 at 10620MHz.



Band 2 5250~5350MHz
WIFI 802.11ac VHT80 (Band Edge @ 3m)

Table with 14 columns: WIFI Ant. 1, Note, Frequency (MHz), Level (dBµV/m), Over Limit (dB), Limit Line (dBµV/m), Read Level (dBµV), Antenna Factor (dB/m), Cable Loss (dB), Preamp Factor (dB), Ant Pos (cm), Table Pos (deg), Peak Avg. (P/A), Pol. (H/V). Rows include test results for frequencies like 5137.12, 5118.08, 5278, 5350.6, 5362.6, 5116.16, 5119.36, 5254, 5254, 5356.2, 5354.9.

Remark

- 1. No other spurious found.
2. All results are PASS against Peak and Average limit line.



Band 2 5250~5350MHz

WIFI 802.11ac VHT80 (Harmonic @ 3m)

WIFI Ant. 1	Note	Frequency ( MHz )	Level ( dBμV/m )	Over Limit ( dB )	Limit Line ( dBμV/m )	Read Level (dBμV)	Antenna Factor ( dB/m )	Cable Loss ( dB )	Preamp Factor ( dB )	Ant Pos ( cm )	Table Pos ( deg )	Peak Avg. (P/A)	Pol. (H/V)
802.11ac VHT80		10580	42.88	-25.42	68.3	50.92	37.15	15.44	60.63	100	360	P	H
CH 58 5290MHz		10580	44.92	-23.38	68.3	52.96	37.15	15.44	60.63	100	360	P	V
<b>Remark</b>	1. No other spurious found. 2. All results are PASS against Peak and Average limit line.												



**Band 3 - 5470~5725MHz**  
**WIFI 802.11a (Band Edge @ 3m)**

WIFI	Note	Frequency	Level	Over	Limit	Read	Antenna	Cable	Preamp	Ant	Table	Peak	Pol.
Ant.				Limit	Line	Level	Factor	Loss	Factor	Pos	Pos	Avg.	
1		( MHz )	( dBμV/m )	( dB )	( dBμV/m )	( dBμV )	( dB/m )	( dB )	( dB )	( cm )	( deg )	( P/A )	( H/V )
802.11a CH 100 5500MHz		5459.44	54.17	-19.83	74	40.23	34.46	10.77	31.29	100	158	P	H
		5468.08	56.44	-11.86	68.3	42.48	34.48	10.77	31.29	100	158	P	H
		5459.98	45.2	-8.8	54	31.26	34.46	10.77	31.29	100	158	A	H
	*	5500	104.95	-	-	90.94	34.53	10.77	31.29	100	158	P	H
		5500	97.25	-	-	83.24	34.53	10.77	31.29	100	158	A	H
		5454.96	55.12	-18.88	74	41.18	34.46	10.77	31.29	100	127	P	V
		5466.64	57.48	-10.82	68.3	43.52	34.48	10.77	31.29	100	127	P	V
		5459.98	46.46	-7.54	54	32.52	34.46	10.77	31.29	100	127	A	V
	*	5500	107.23	-	-	93.22	34.53	10.77	31.29	100	127	P	V
		5500	99.81	-	-	85.8	34.53	10.77	31.29	100	127	A	V
802.11a CH 140 5700MHz	*	5698	105.76	-	-	91.99	34.75	10.79	31.77	100	214	P	H
		5698	99.38	-	-	85.61	34.75	10.79	31.77	100	214	A	H
		5725.96	60.97	-7.33	68.3	47.31	34.78	10.8	31.92	100	214	P	H
	*	5698	108.3	-	-	94.53	34.75	10.79	31.77	102	125	P	V
		5698	100.82	-	-	87.05	34.75	10.79	31.77	102	125	A	V
		5725.72	62.25	-6.05	68.3	48.59	34.78	10.8	31.92	102	125	P	V
<b>Remark</b>	1. No other spurious found. 2. All results are PASS against Peak and Average limit line.												



**Band 3 - 5470~5725MHz**  
**WIFI 802.11a (Harmonic @ 3m)**

WIFI Ant. 1	Note	Frequency ( MHz )	Level ( dBμV/m )	Over Limit ( dB )	Limit Line ( dBμV/m )	Read Level (dBμV)	Antenna Factor ( dB/m )	Cable Loss ( dB )	Preamp Factor ( dB )	Ant Pos ( cm )	Table Pos ( deg )	Peak Avg. (P/A)	Pol. (H/V)
802.11a CH 100 5500MHz		11000	56.78	-17.22	74	64.16	37.4	15.76	60.54	100	223	P	H
		11000	46.49	-7.51	54	53.87	37.4	15.76	60.54	100	223	A	H
		11000	60.52	-13.48	74	67.9	37.4	15.76	60.54	118	112	P	V
		11000	50.67	-3.33	54	58.05	37.4	15.76	60.54	118	112	A	V
802.11a CH 116 5580MHz		11160	55.42	-18.58	74	62.54	37.5	15.88	60.5	100	229	P	H
		11160	46.25	-7.75	54	53.37	37.5	15.88	60.5	100	229	A	H
		11160	54.83	-19.17	74	61.95	37.5	15.88	60.5	111	102	P	V
		11160	49.22	-4.78	54	56.34	37.5	15.88	60.5	111	102	A	V
802.11a CH 140 5700MHz		11400	54.34	-19.66	74	61.1	37.64	16.05	60.45	100	233	P	H
		11400	44.44	-9.56	54	51.2	37.64	16.05	60.45	100	233	A	H
		11400	55.26	-18.74	74	62.02	37.64	16.05	60.45	100	230	P	V
		11400	44.81	-9.19	54	51.57	37.64	16.05	60.45	100	230	A	V
<b>Remark</b>	1. No other spurious found. 2. All results are PASS against Peak and Average limit line.												



**Band 3 - 5470~5725MHz**  
**WIFI 802.11n HT20 (Band Edge @ 3m)**

WIFI Ant. 1	Note	Frequency ( MHz )	Level ( dBμV/m )	Over Limit ( dB )	Limit Line ( dBμV/m )	Read Level ( dBμV )	Antenna Factor ( dB/m )	Cable Loss ( dB )	Preamp Factor ( dB )	Ant Pos ( cm )	Table Pos ( deg )	Peak Avg. ( P/A )	Pol. ( H/V )
802.11n HT20 CH 100 5500MHz		5457.52	55.03	-18.97	74	41.09	34.46	10.77	31.29	100	158	P	H
		5468.4	57.87	-10.43	68.3	43.91	34.48	10.77	31.29	100	158	P	H
		5459.92	44.93	-9.07	54	30.99	34.46	10.77	31.29	100	158	A	H
	*	5500	103.62	-	-	89.61	34.53	10.77	31.29	100	158	P	H
		5500	97.52	-	-	83.51	34.53	10.77	31.29	100	158	A	H
		5459.76	55.91	-18.09	74	41.97	34.46	10.77	31.29	100	128	P	V
		5469.84	58.16	-10.14	68.3	44.2	34.48	10.77	31.29	100	128	P	V
		5459.98	46.29	-7.71	54	32.35	34.46	10.77	31.29	100	128	A	V
	*	5500	107.54	-	-	93.53	34.53	10.77	31.29	100	128	P	V
	5500	100.24	-	-	86.23	34.53	10.77	31.29	100	128	A	V	
802.11n HT20 CH 140 5700MHz	*	5698	105.65	-	-	91.88	34.75	10.79	31.77	108	117	P	H
		5698	98.28	-	-	84.51	34.75	10.79	31.77	108	117	A	H
		5725.32	60.74	-7.56	68.3	47.08	34.78	10.8	31.92	108	117	P	H
	*	5698	106.95	-	-	93.18	34.75	10.79	31.77	104	130	P	V
		5698	100.49	-	-	86.72	34.75	10.79	31.77	104	130	A	V
	5725.08	61.62	-6.68	68.3	47.96	34.78	10.8	31.92	104	130	P	V	
<b>Remark</b>	1. No other spurious found. 2. All results are PASS against Peak and Average limit line.												





**Band 3 - 5470~5725MHz**  
**WIFI 802.11n HT20 (Harmonic @ 3m)**

WIFI Ant. 1	Note	Frequency ( MHz )	Level ( dBμV/m )	Over Limit ( dB )	Limit Line ( dBμV/m )	Read Level (dBμV)	Antenna Factor ( dB/m )	Cable Loss ( dB )	Preamp Factor ( dB )	Ant Pos ( cm )	Table Pos ( deg )	Peak Avg. (P/A)	Pol. (H/V)
802.11n		11000	56.97	-17.03	74	64.35	37.4	15.76	60.54	100	221	P	H
HT20		11000	45.15	-8.85	54	52.53	37.4	15.76	60.54	100	221	A	H
CH 100		11000	63.34	-10.66	74	70.72	37.4	15.76	60.54	116	114	P	V
5500MHz		11000	50.43	-3.57	54	57.81	37.4	15.76	60.54	116	114	A	V
802.11n		11160	57.44	-16.56	74	64.56	37.5	15.88	60.5	101	233	P	H
HT20		11160	45.52	-8.48	54	52.64	37.5	15.88	60.5	101	233	A	H
CH 116		11160	61.35	-12.65	74	68.47	37.5	15.88	60.5	111	105	P	V
5580MHz		11160	48.72	-5.28	54	55.84	37.5	15.88	60.5	111	105	A	V
802.11n		11400	53.44	-20.56	74	60.2	37.64	16.05	60.45	114	230	P	H
HT20		11400	43.25	-10.75	54	50.01	37.64	16.05	60.45	114	230	A	H
CH 140		11400	55.11	-18.89	74	61.87	37.64	16.05	60.45	106	228	P	V
5700MHz		11400	44.07	-9.93	54	50.83	37.64	16.05	60.45	106	228	A	V
<b>Remark</b>	1. No other spurious found. 2. All results are PASS against Peak and Average limit line.												



**Band 3 - 5470~5725MHz**  
**WIFI 802.11n HT40 (Band Edge @ 3m)**

WIFI Ant. 1	Note	Frequency ( MHz )	Level ( dBμV/m )	Over Limit ( dB )	Limit Line ( dBμV/m )	Read Level ( dBμV )	Antenna Factor ( dB/m )	Cable Loss ( dB )	Preamp Factor ( dB )	Ant Pos ( cm )	Table Pos ( deg )	Peak Avg. ( P/A )	Pol. ( H/V )
802.11n HT40 CH 102 5510MHz		5459.76	54.18	-19.82	74	40.24	34.46	10.77	31.29	100	169	P	H
		5469.36	58.62	-9.68	68.3	44.66	34.48	10.77	31.29	100	169	P	H
		5459.92	46.79	-7.21	54	32.85	34.46	10.77	31.29	100	169	A	H
	*	5512	99.3	-	-	85.29	34.53	10.77	31.29	100	169	P	H
		5512	91.67	-	-	77.66	34.53	10.77	31.29	100	169	A	H
		5738.68	55.25	-13.05	68.3	41.72	34.79	10.81	32.07	100	169	P	H
		5459.76	58.99	-15.01	74	45.05	34.46	10.77	31.29	100	117	P	V
		5469.68	63.13	-5.17	68.3	49.17	34.48	10.77	31.29	100	117	P	V
		5459.92	49.53	-4.47	54	35.59	34.46	10.77	31.29	100	117	A	V
	*	5512	103.6	-	-	89.59	34.53	10.77	31.29	100	117	P	V
		5512	95.34	-	-	81.33	34.53	10.77	31.29	100	117	A	V
		5758.2	55.35	-12.95	68.3	41.96	34.81	10.81	32.23	100	117	P	V
802.11n HT40 CH 134 5670MHz		5392.08	53.66	-20.34	74	39.81	34.38	10.75	31.28	100	118	P	H
		5467.92	54.55	-13.75	68.3	40.59	34.48	10.77	31.29	100	118	P	H
		5419.28	44.31	-9.69	54	30.4	34.42	10.77	31.28	100	118	A	H
	*	5674	101.41	-	-	87.35	34.73	10.79	31.46	100	118	P	H
		5674	93.34	-	-	79.28	34.73	10.79	31.46	100	118	A	H
		5730.84	56.83	-11.47	68.3	43.17	34.78	10.8	31.92	100	118	P	H
		5451.6	53.75	-20.25	74	39.81	34.46	10.77	31.29	100	131	P	V
		5460.4	53.43	-14.87	68.3	39.49	34.46	10.77	31.29	100	131	P	V
		5454.16	44.54	-9.46	54	30.6	34.46	10.77	31.29	100	131	A	V
	*	5680	103.15	-	-	89.25	34.73	10.79	31.62	100	131	P	V
	5680	95.35	-	-	81.45	34.73	10.79	31.62	100	131	A	V	
	5725.32	58.15	-10.15	68.3	44.49	34.78	10.8	31.92	100	131	P	V	
<b>Remark</b>	1. No other spurious found. 2. All results are PASS against Peak and Average limit line.												



Band 3 - 5470~5725MHz
WIFI 802.11n HT40 (Harmonic @ 3m)

Table with 14 columns: WIFI Ant. 1, Note, Frequency (MHz), Level (dBµV/m), Over Limit (dB), Limit Line (dBµV/m), Read Level (dBµV), Antenna Factor (dB/m), Cable Loss (dB), Preamp Factor (dB), Ant Pos (cm), Table Pos (deg), Peak Avg. (P/A), Pol. (H/V). Rows include data for channels 102, 110, and 134 at various frequencies (11020, 11100, 11340 MHz).

Remark
1. No other spurious found.
2. All results are PASS against Peak and Average limit line.



**Band 3 - 5470~5725MHz**  
**WIFI 802.11ac VHT80 (Band Edge @ 3m)**

WIFI Ant. 1	Note	Frequency ( MHz )	Level ( dBμV/m )	Over Limit ( dB )	Limit Line ( dBμV/m )	Read Level ( dBμV )	Antenna Factor ( dB/m )	Cable Loss ( dB )	Preamp Factor ( dB )	Ant Pos ( cm )	Table Pos ( deg )	Peak Avg. ( P/A )	Pol. ( H/V )
802.11ac VHT80 CH 106 5530MHz		5455.28	55.49	-18.51	74	41.55	34.46	10.77	31.29	100	115	P	H
		5468.72	55.36	-12.94	68.3	41.4	34.48	10.77	31.29	100	115	P	H
		5454.8	47.79	-6.21	54	33.85	34.46	10.77	31.29	100	115	A	H
	*	5530	94.53	-	-	80.51	34.55	10.77	31.3	100	115	P	H
		5530	86.7	-	-	72.68	34.55	10.77	31.3	100	115	A	H
		5755.56	54.67	-13.63	68.3	41.28	34.81	10.81	32.23	100	115	P	H
		5456.4	57.97	-16.03	74	44.03	34.46	10.77	31.29	100	119	P	V
		5460.88	57.79	-10.51	68.3	43.85	34.46	10.77	31.29	100	119	P	V
		5459.98	50.12	-3.88	54	36.18	34.46	10.77	31.29	100	119	A	V
	*	5524	96.71	-	-	82.69	34.55	10.77	31.3	100	119	P	V
		5524	89.23	-	-	75.21	34.55	10.77	31.3	100	119	A	V
		5744.2	54.64	-13.66	68.3	41.11	34.79	10.81	32.07	100	119	P	V
802.11ac VHT80 CH 122 5610MHz		5357.68	54.52	-19.48	74	40.76	34.33	10.71	31.28	100	115	P	H
		5465.52	52.53	-15.77	68.3	38.57	34.48	10.77	31.29	100	115	P	H
		5458.64	44.84	-9.16	54	30.9	34.46	10.77	31.29	100	115	A	H
	*	5602	96.91	-	-	82.79	34.66	10.77	31.31	100	115	P	H
		5602	89.57	-	-	75.45	34.66	10.77	31.31	100	115	A	H
		5731.16	54.19	-14.11	68.3	40.53	34.78	10.8	31.92	100	115	P	H
		5355.92	53.92	-20.08	74	40.16	34.33	10.71	31.28	100	128	P	V
		5466	54.18	-14.12	68.3	40.22	34.48	10.77	31.29	100	128	P	V
		5452.4	45.13	-8.87	54	31.19	34.46	10.77	31.29	100	128	A	V
	*	5602	99.76	-	-	85.64	34.66	10.77	31.31	100	128	P	V
	5602	92.26	-	-	78.14	34.66	10.77	31.31	100	128	A	V	
	5762.36	54.77	-13.53	68.3	41.38	34.81	10.81	32.23	100	128	P	V	
<b>Remark</b>	1. No other spurious found. 2. All results are PASS against Peak and Average limit line.												



Band 3 5470~5725MHz
WIFI 802.11ac VHT80 (Harmonic @ 3m)

Table with 14 columns: WIFI Ant. 1, Note, Frequency (MHz), Level (dBµV/m), Over Limit (dB), Limit Line (dBµV/m), Read Level (dBµV), Antenna Factor (dB/m), Cable Loss (dB), Preamp Factor (dB), Ant Pos (cm), Table Pos (deg), Peak Avg. (P/A), Pol. (H/V). Rows include 802.11ac VHT80 CH 106 5530MHz and 802.11ac VHT80 CH 122 5610MHz. A Remark section at the bottom states: 1. No other spurious found. 2. All results are PASS against Peak and Average limit line.



Emission below 1GHz  
WIFI 802.11n HT40 (LF @ 3m)

WIFI	Note	Frequency	Level	Over	Limit	Read	Antenna	Cable	Preamp	Ant	Table	Peak	Pol.
Ant.				Limit	Line	Level	Factor	Loss	Factor	Pos	Pos	Avg.	
1		( MHz )	( dBμV/m )	( dB )	( dBμV/m )	( dBμV )	( dB/m )	( dB )	( dB )	( cm )	( deg )	( P/A )	( H/V )
802.11n HT40 LF		34.85	16.03	-23.97	40	26.25	22.1	0.68	33	-	-	P	H
		183.26	33.47	-10.03	43.5	49.89	15.01	1.5	32.93	100	0	P	H
		309.36	32.29	-13.71	46	43.53	19.55	1.93	32.72	-	-	P	H
		816.67	26.08	-19.92	46	26.53	28.57	3.15	32.17	-	-	P	H
		870.02	26.69	-19.31	46	26.44	29.26	3.25	32.26	-	-	P	H
		989.33	28.1	-25.9	54	26.28	30.36	3.48	32.02	-	-	P	H
		46.49	23.61	-16.39	40	39.65	16.27	0.79	33.1	-	-	P	V
		188.11	29.25	-14.25	43.5	45.79	14.86	1.52	32.92	100	0	P	V
		307.42	28.3	-17.7	46	39.59	19.5	1.93	32.72	-	-	P	V
		914.64	27.51	-18.49	46	26.96	29.39	3.33	32.17	-	-	P	V
		955.38	28.82	-17.18	46	27.58	29.92	3.41	32.09	-	-	P	V
	989.33	27.92	-26.08	54	26.1	30.36	3.48	32.02	-	-	P	V	
Remark	1. No other spurious found. 2. All results are PASS against limit line.												



Note symbol

*	<b>Fundamental Frequency</b> which can be ignored. However, the level of any unwanted emissions shall not exceed the level of the fundamental frequency.
!	Test result is <b>over limit</b> line.
P/A	<b>Peak</b> or <b>Average</b>
H/V	<b>Horizontal</b> or <b>Vertical</b>



A calculation example for radiated spurious emission is shown as below:

WIFI	Note	Frequency	Level	Over	Limit	Read	Antenna	Cable	Preamp	Ant	Table	Peak	Pol.
Ant.				Limit	Line	Level	Factor	Loss	Factor	Pos	Pos	Avg.	
1		( MHz )	( dBμV/m )	( dB )	( dBμV/m )	( dBμV )	( dB/m )	( dB )	( dB )	( cm )	( deg )	( P/A )	( H/V )
802.11b		2390	55.45	-18.55	74	54.51	32.22	4.58	35.86	103	308	P	H
CH 01													
2412MHz		2390	43.54	-10.46	54	42.6	32.22	4.58	35.86	103	308	A	H

- Level(dBμV/m) =  
Antenna Factor(dB/m) + Cable Loss(dB) + Read Level(dBμV) - Preamp Factor(dB)
- Over Limit(dB) = Level(dBμV/m) – Limit Line(dBμV/m)

**For Peak Limit @ 2390MHz:**

- Level(dBμV/m)  
= Antenna Factor(dB/m) + Cable Loss(dB) + Read Level(dBμV) - Preamp Factor(dB)  
= 32.22(dB/m) + 4.58(dB) + 54.51(dBμV) – 35.86 (dB)  
= 55.45 (dBμV/m)
- Over Limit(dB)  
= Level(dBμV/m) – Limit Line(dBμV/m)  
= 55.45(dBμV/m) – 74(dBμV/m)  
= -18.55(dB)

**For Average Limit @ 2390MHz:**

- Level(dBμV/m)  
= Antenna Factor(dB/m) + Cable Loss(dB) + Read Level(dBμV) - Preamp Factor(dB)  
= 32.22(dB/m) + 4.58(dB) + 42.6(dBμV) – 35.86 (dB)  
= 43.54 (dBμV/m)
- Over Limit(dB)  
= Level(dBμV/m) – Limit Line(dBμV/m)  
= 43.54(dBμV/m) – 54(dBμV/m)  
= -10.46(dB)

Both peak and average measured complies with the limit line, so test result is “PASS”.



## Appendix D. Duty Cycle Plots

Band	Duty Cycle(%)	T(ms)	1/T(kHz)	VBW Setting
802.11a	98.34	-	-	10Hz
802.11n HT20	98.23	-	-	10Hz
802.11n HT40	96.47	0.951	1.052	1.1kHz
802.11ac VHT80	93.06	0.467	2.143	2.2kHz

### 802.11a

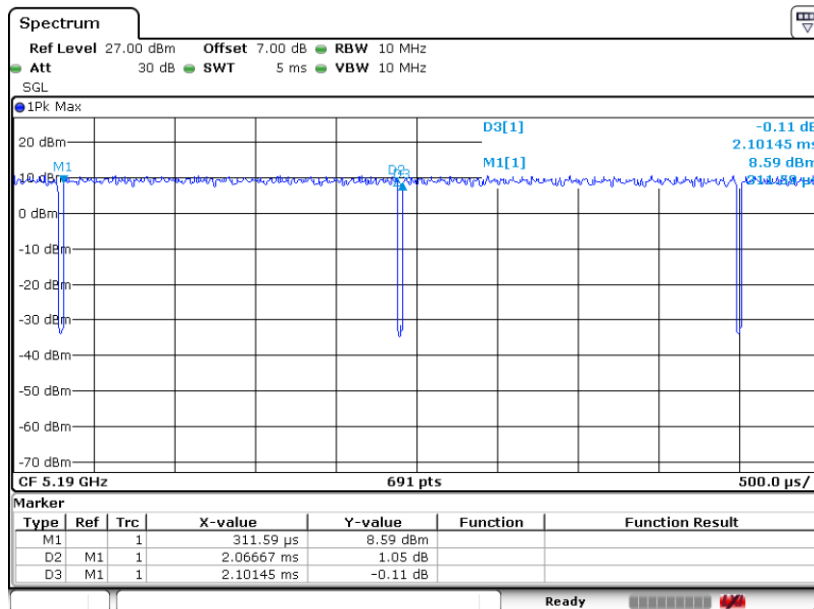



802.11n HT20

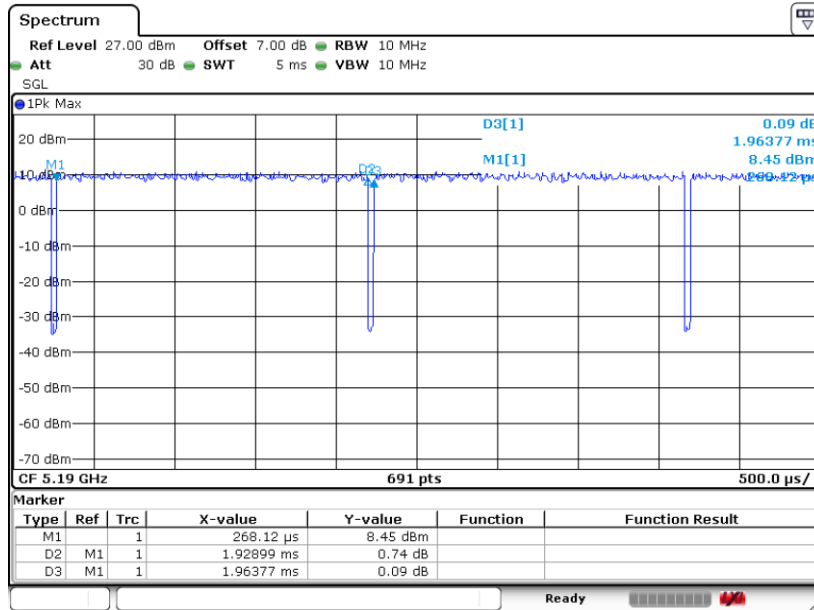

802.11n HT40

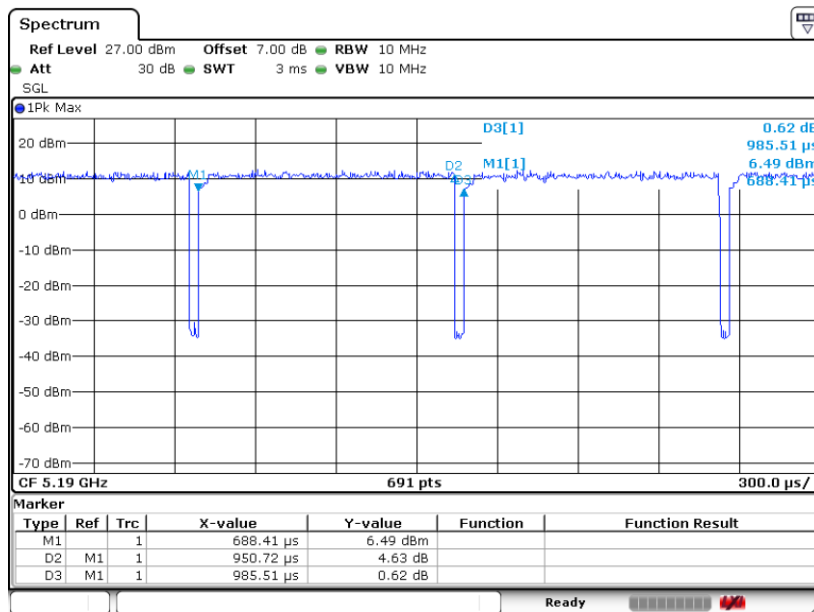



802.11ac VHT80

