



FCC RF Test Report

APPLICANT : Motorola Mobility LLC
EQUIPMENT : Mobile Cellular Phone
BRAND NAME : Motorola
MODEL NAME : XT2043-4, XT2043-5, XT2043-6
FCC ID : IHDT56YN1
STANDARD : FCC Part 15 Subpart C §15.247
CLASSIFICATION : (DSS) Spread Spectrum Transmitter

The product was received on Oct. 09, 2019 and testing was completed on Nov. 20, 2019. We, Sporton International (Kunshan) Inc., would like to declare that the tested sample has been evaluated in accordance with the test procedures and has been in compliance with the applicable technical standards.

The test results in this report apply exclusively to the tested model / sample. Without written approval of Sporton International (Kunshan) Inc., the test report shall not be reproduced except in full.

Jason Jia

Reviewed by: Jason Jia / Supervisor

James Huang

Approved by: James Huang / Manager



Sporton International (Kunshan) Inc.

No. 1098, Pengxi North Road, Kunshan Economic Development Zone Jiangsu Province 215300
People's Republic of China



TABLE OF CONTENTS

REVISION HISTORY.....3

SUMMARY OF TEST RESULT4

1 GENERAL DESCRIPTION.....5

 1.1 Applicant5

 1.2 Manufacturer.....5

 1.3 Product Feature of Equipment Under Test.....5

 1.4 Product Specification of Equipment Under Test.....6

 1.5 Specification of Accessory.....6

 1.6 Modification of EUT6

 1.7 Testing Location7

 1.8 Test Software.....7

 1.9 Applicable Standards.....7

2 TEST CONFIGURATION OF EQUIPMENT UNDER TEST.....8

 2.1 Carrier Frequency Channel8

 2.2 Test Mode.....9

 2.3 Connection Diagram of Test System.....10

 2.4 Support Unit used in test configuration and system11

 2.5 EUT Operation Test Setup11

 2.6 Measurement Results Explanation Example.....11

3 TEST RESULT12

 3.1 Number of Channel Measurement12

 3.2 Hopping Channel Separation Measurement14

 3.3 Dwell Time Measurement.....20

 3.4 20dB and 99% Bandwidth Measurement22

 3.5 Output Power Measurement.....33

 3.6 Conducted Band Edges Measurement.....34

 3.7 Conducted Spurious Emission Measurement41

 3.8 Radiated Band Edges and Spurious Emission Measurement51

 3.9 AC Conducted Emission Measurement.....55

 3.10 Antenna Requirements.....57

4 LIST OF MEASURING EQUIPMENT.....58

5 UNCERTAINTY OF EVALUATION.....59

APPENDIX A. CONDUCTED TEST RESULTS

APPENDIX B. AC CONDUCTED EMISSION TEST RESULT

APPENDIX C. RADIATED SPURIOUS EMISSION

APPENDIX D. DUTY CYCLE PLOTS

APPENDIX E. SETUP PHOTOGRAPHS



SUMMARY OF TEST RESULT

| Report Section | FCC Rule | Description | Limit | Result | Remark |
|----------------|--------------------|----------------------------------------------------|----------------------------|--------|------------------------------------------|
| 3.1 | 15.247(a)(1) | Number of Channels | ≥ 15Chs | Pass | - |
| 3.2 | 15.247(a)(1) | Hopping Channel Separation | ≥ 2/3 of 20dB BW | Pass | - |
| 3.3 | 15.247(a)(1) | Dwell Time of Each Channel | ≤ 0.4sec in 31.6sec period | Pass | - |
| 3.4 | 15.247(a)(1) | 20dB Bandwidth | NA | Pass | - |
| 3.4 | - | 99% Bandwidth | - | Pass | - |
| 3.5 | 15.247(b)(1) | Peak Output Power | ≤ 125 mW | Pass | - |
| 3.6 | 15.247(d) | Conducted Band Edges | ≤ 20dBc | Pass | - |
| 3.7 | 15.247(d) | Conducted Spurious Emission | ≤ 20dBc | Pass | - |
| 3.8 | 15.247(d) | Radiated Band Edges and Radiated Spurious Emission | 15.209(a) & 15.247(d) | Pass | Under limit 13.22 dB at 118.27 MHz |
| 3.9 | 15.207 | AC Conducted Emission | 15.207(a) | Pass | Under limit 10.23 dB at 0.162 MHz |
| 3.10 | 15.203 & 15.247(b) | Antenna Requirement | N/A | Pass | - |

Declaration of Conformity:

The test results with all measurement uncertainty excluded are presented in accordance with the regulation limits or requirements declared by manufacturers.

Comments and Explanations:

The declared of product specification for EUT presented in the report are provided by the manufacturer, and the manufacturer takes all the responsibilities for the accuracy of product specification.



1 General Description

1.1 Applicant

Motorola Mobility LLC
222 W, Merchandise Mart Plaza, Chicago IL 60654 USA

1.2 Manufacturer

Motorola Mobility LLC
222 W, Merchandise Mart Plaza, Chicago IL 60654 USA

1.3 Product Feature of Equipment Under Test

| Product Feature | |
|---------------------------------|------------------------------------------------------------------------------------------------------------------------------------------------------------------------------------------------------------------------------------------------|
| Equipment | Mobile Cellular Phone |
| Brand Name | Motorola |
| Model Name | XT2043-4, XT2043-5, XT2043-6 |
| FCC ID | IHDT56YN1 |
| EUT supports Radios application | CDMA/EV-DO/GSM/GPRS/EGPRS/WCDMA/HSPA/ DC-HSDPA/HSPA+(16QAM uplink is not supported)/LTE WLAN 2.4GHz 802.11b/g/n HT20 WLAN 5GHz 802.11a/n HT20/HT40 WLAN 5GHz 802.11ac VHT20/VHT40/VHT80 Bluetooth BR/EDR/LE GNSS/FM Receiver |
| IMEI Code | Conducted: 359084100014845 Conduction: 359084100021188 Radiation: 359084100022632 |
| HW Version | DVT2 |
| SW Version | QPR30.56 |
| EUT Stage | Identical Prototype |

Remark:

1. The above EUT's information was declared by manufacturer. Please refer to the specifications or user's manual for more detailed description.
2. The different model names are for different market requirement.



1.4 Product Specification of Equipment Under Test

| Standards-related Product Specification | |
|-----------------------------------------|-----------------------------------------------------------------------------------------------------------------------------------------|
| Tx/Rx Frequency Range | 2402 MHz ~ 2480 MHz |
| Number of Channels | 79 |
| Carrier Frequency of Each Channel | 2402+n*1 MHz; n=0~78 |
| Maximum Output Power to Antenna | Bluetooth BR(1Mbps) : 7.83 dBm (0.0061 W) Bluetooth EDR (2Mbps) : 7.22 dBm (0.0053 W) Bluetooth EDR (3Mbps) : 7.56 dBm (0.0057 W) |
| 99% Occupied Bandwidth | Bluetooth BR(1Mbps) : 0.854MHz Bluetooth EDR (2Mbps) : 1.164MHz Bluetooth EDR (3Mbps) : 1.149MHz |
| Antenna Type / Gain | Loop Antenna with gain -5.0 dBi |
| Type of Modulation | Bluetooth BR (1Mbps) : GFSK Bluetooth EDR (2Mbps) : $\pi/4$ -DQPSK Bluetooth EDR (3Mbps) : 8-DPSK |

1.5 Specification of Accessory

| Specification of Accessory | | | | |
|----------------------------|------------------|-------------------------------------------------|------------|------------|
| AC Adapter 1 | Brand Name | Motorola (Acbel) | Model Name | SC-41 |
| | Power Rating | I/P: 100-240 Vac, 300mA ; O/P: 5Vdc, 2000mA | | |
| AC Adapter 2 | Brand Name | Motorola (Chenyang) | Model Name | SC-41 |
| | Power Rating | I/P: 100-240 Vac, 300mA ; O/P: 5Vdc, 2000mA | | |
| Battery | Brand Name | Motorola (Amperex) | Model Name | KX50 |
| | Power Rating | 3.8Vdc, 4000mAh | Type | Li-ion |
| USB Cable 1 | Brand Name | Motorola (Luxshare) | Model Name | SC18C24368 |
| | Signal Line Type | 1.0 meter, shielded cable, without ferrite core | | |
| USB Cable 2 | Brand Name | Motorola (Saibao) | Model Name | SC18C24367 |
| | Signal Line Type | 1.0 meter, shielded cable, without ferrite core | | |

1.6 Modification of EUT

No modifications are made to the EUT during all test items.



1.7 Testing Location

Sporton International (Kunshan) Inc. is accredited to ISO/IEC 17025:2017 by American Association for Laboratory Accreditation with Certificate Number 5145.02.

| | | | |
|---------------------------|--------------------------------------------------------------------------------------------------------------------------------------------------------------------------|----------------------------|---------------------------------------|
| Test Firm | Sporton International (Kunshan) Inc. | | |
| Test Site Location | No. 1098, Pengxi North Road, Kunshan Economic Development Zone Jiangsu Province 215300 People's Republic of China TEL : +86-512-57900158 FAX : +86-512-57900958 | | |
| Test Site No. | Sporton Site No. | FCC Designation No. | FCC Test Firm Registration No. |
| | CO01-KS 03CH06-KS TH01-KS | CN1257 | 314309 |

1.8 Test Software

| Item | Site | Manufacture | Name | Version |
|------|-----------|-------------|------|---------------|
| 1. | 03CH06-KS | AUDIX | E3 | 6.2009-8-24al |
| 2. | CO01-KS | AUDIX | E3 | 6.2009-8-24 |

1.9 Applicable Standards

According to the specifications of the manufacturer, the EUT must comply with the requirements of the following standards:

- 47 CFR Part 15 Subpart C §15.247
- FCC KDB 558074 D01 15.247 Meas Guidance v05r02
- ANSI C63.10-2013

Remark:

1. All test items were verified and recorded according to the standards and without any deviation during the test.
2. This EUT has also been tested and complied with the requirements of FCC Part 15, Subpart B, recorded in a separate test report.



2 Test Configuration of Equipment Under Test

2.1 Carrier Frequency Channel

| Frequency Band | Channel | Freq. (MHz) | Channel | Freq. (MHz) | Channel | Freq. (MHz) |
|-----------------|---------|-------------|---------|-------------|---------|-------------|
| 2400-2483.5 MHz | 0 | 2402 | 27 | 2429 | 54 | 2456 |
| | 1 | 2403 | 28 | 2430 | 55 | 2457 |
| | 2 | 2404 | 29 | 2431 | 56 | 2458 |
| | 3 | 2405 | 30 | 2432 | 57 | 2459 |
| | 4 | 2406 | 31 | 2433 | 58 | 2460 |
| | 5 | 2407 | 32 | 2434 | 59 | 2461 |
| | 6 | 2408 | 33 | 2435 | 60 | 2462 |
| | 7 | 2409 | 34 | 2436 | 61 | 2463 |
| | 8 | 2410 | 35 | 2437 | 62 | 2464 |
| | 9 | 2411 | 36 | 2438 | 63 | 2465 |
| | 10 | 2412 | 37 | 2439 | 64 | 2466 |
| | 11 | 2413 | 38 | 2440 | 65 | 2467 |
| | 12 | 2414 | 39 | 2441 | 66 | 2468 |
| | 13 | 2415 | 40 | 2442 | 67 | 2469 |
| | 14 | 2416 | 41 | 2443 | 68 | 2470 |
| | 15 | 2417 | 42 | 2444 | 69 | 2471 |
| | 16 | 2418 | 43 | 2445 | 70 | 2472 |
| | 17 | 2419 | 44 | 2446 | 71 | 2473 |
| | 18 | 2420 | 45 | 2447 | 72 | 2474 |
| | 19 | 2421 | 46 | 2448 | 73 | 2475 |
| | 20 | 2422 | 47 | 2449 | 74 | 2476 |
| | 21 | 2423 | 48 | 2450 | 75 | 2477 |
| | 22 | 2424 | 49 | 2451 | 76 | 2478 |
| | 23 | 2425 | 50 | 2452 | 77 | 2479 |
| | 24 | 2426 | 51 | 2453 | 78 | 2480 |
| | 25 | 2427 | 52 | 2454 | - | - |
| | 26 | 2428 | 53 | 2455 | - | - |

2.2 Test Mode

- a. The EUT has been associated with peripherals and configuration operated in a manner tended to maximize its emission characteristics in a typical application. Frequency range investigated: conduction emission (150 kHz to 30 MHz), radiation emission (9 kHz to the 10th harmonic of the highest fundamental frequency or to 40 GHz, whichever is lower). For radiated measurement, pre-scanned in three orthogonal panels, X, Y, Z. The worst cases (X plane) were recorded in this report, and the worst mode of radiated spurious emissions is Bluetooth 1Mbps mode, and recorded in this report.
- b. AC power line Conducted Emission was tested under maximum output power.

The following summary table is showing all test modes to demonstrate in compliance with the standard.

| Summary table of Test Cases | | | |
|------------------------------------------------------------------------------------------------------------------------------------------------------------------------------------------------------------------------------------------------------------------------------------------------------------------------------------------------------------------------------------------------------------|-------------------------------------------------------------------------------------------------------------|---------------------------------------|-------------------------------|
| Test Item | Data Rate / Modulation | | |
| | Bluetooth BR 1Mbps GFSK | Bluetooth EDR 2Mbps $\pi/4$ -DQPSK | Bluetooth EDR 3Mbps 8-DPSK |
| Conducted Test Cases | Mode 1: CH00_2402 MHz | Mode 4: CH00_2402 MHz | Mode 7: CH00_2402 MHz |
| | Mode 2: CH39_2441 MHz | Mode 5: CH39_2441 MHz | Mode 8: CH39_2441 MHz |
| | Mode 3: CH78_2480 MHz | Mode 6: CH78_2480 MHz | Mode 9: CH78_2480 MHz |
| Radiated Test Cases | Bluetooth BR 1Mbps GFSK | | |
| | Mode 1: CH00_2402 MHz | | |
| | Mode 2: CH39_2441 MHz | | |
| Mode 3: CH78_2480 MHz | | | |
| AC Conducted Emission | Mode 1 : GSM 850 Idle + Bluetooth Link + WLAN Link (2.4G) + USB Cable 1(Charging from Adapter 1) + Earphone | | |
| Remark: <ol style="list-style-type: none"> For radiated test cases, the worst mode data rate 1Mbps was reported only, because this data rate has the highest RF output power at preliminary tests, and no other significantly frequencies found in conducted spurious emission. For Radiated Test Cases, The tests were performed with Adapter 1, Earphone and USB Cable 1. | | | |

2.3 Connection Diagram of Test System

For Radiation

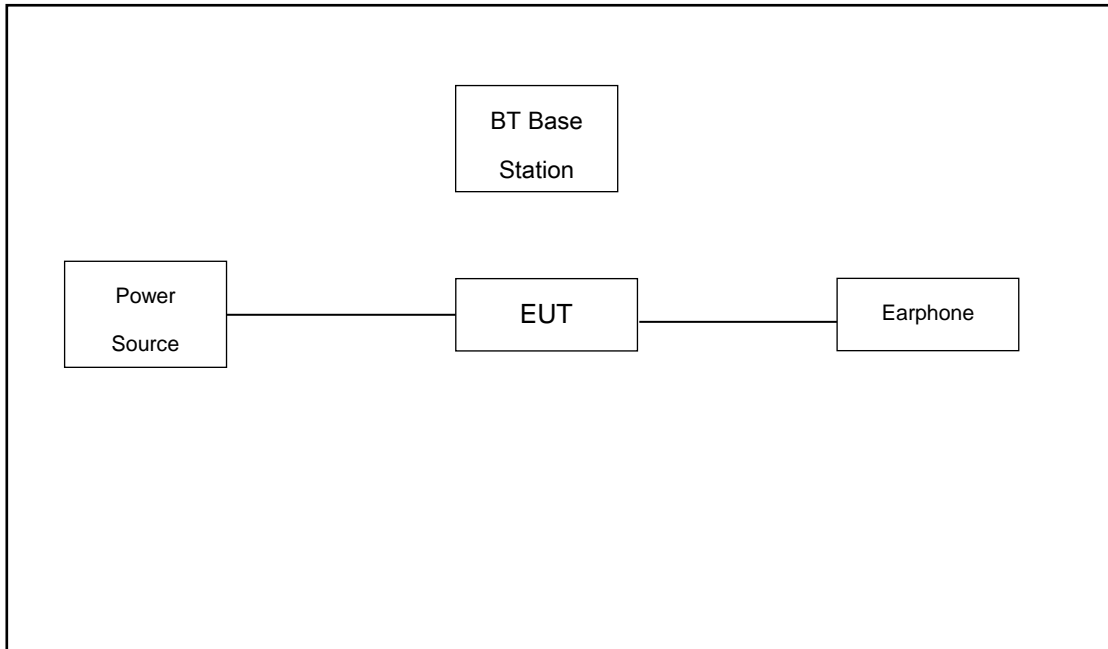

For Conducted Emission

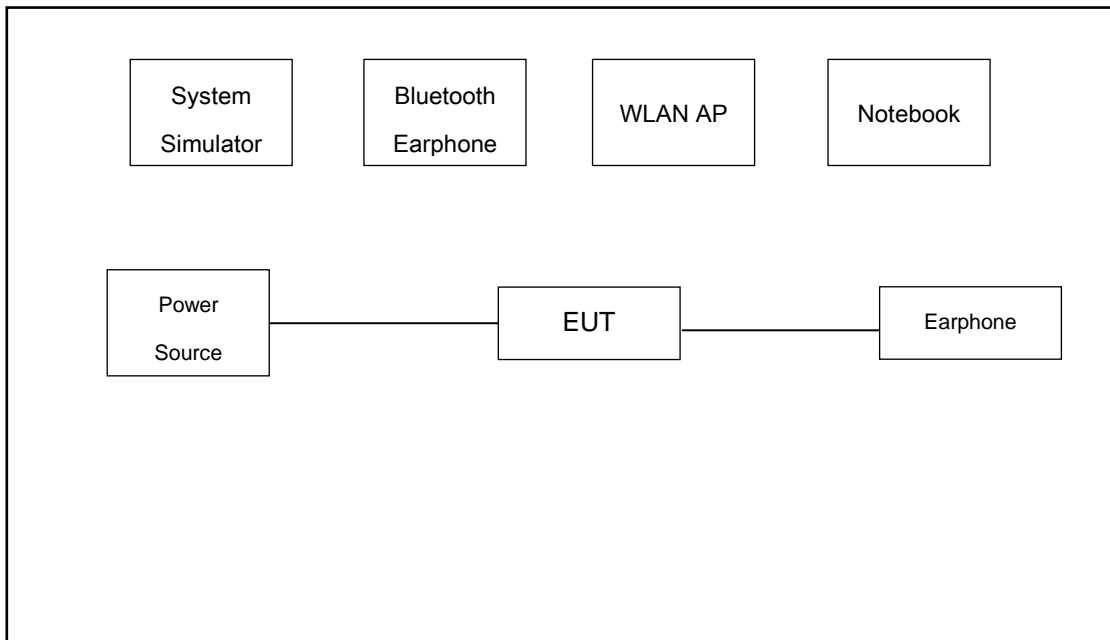



2.4 Support Unit used in test configuration and system

| Item | Equipment | Trade Name | Model Name | FCC ID | Data Cable | Power Cord |
|------|--------------------|------------|------------|---------------|-----------------|------------------------------------------------------------|
| 1. | System Simulator | Anritsu | MT8820C | N/A | N/A | Unshielded, 1.8m |
| 2. | BT Base Station | R&S | CBT | N/A | N/A | Unshielded, 1.8 m |
| 3. | WLAN AP | D-link | DIR-655 | KA21R655B1 | N/A | Unshielded, 1.8m |
| 4. | Bluetooth Earphone | Lenovo | LBH308 | N/A | N/A | N/A |
| 5. | Notebook | Lenovo | G480 | QDS-BRCM1050I | N/A | AC I/P: Unshielded, 1.8 m DC O/P: Shielded, 1.8 m |
| 6. | Earphone | Lenovo | N/A | N/A | Unshielded,1.2m | N/A |

2.5 EUT Operation Test Setup

For Bluetooth function, the engineering test program was provided and enabled to make EUT connect with Bluetooth base station to continuous transmit/receive.

For AC power line conducted emissions, the EUT was set to connect with the WLAN AP under large package sizes transmission.

2.6 Measurement Results Explanation Example

For all conducted test items:

The offset level is set in the spectrum analyzer to compensate the RF cable loss and attenuator factor between EUT conducted output port and spectrum analyzer. With the offset compensation, the spectrum analyzer reading level is exactly the EUT RF output level.

Example:

The spectrum analyzer offset is derived from RF cable loss.

$$\text{Offset} = \text{RF cable loss}$$

Following shows an offset computation example with cable loss 6.2 dB.

$$\begin{aligned} \text{Offset(dB)} &= \text{RF cable loss(dB)} . \\ &= 6.2 \text{ (dB)} \end{aligned}$$

3 Test Result

3.1 Number of Channel Measurement

3.1.1 Limits of Number of Hopping Frequency

Frequency hopping systems in the 2400-2483.5 MHz band shall use at least 15 channels.

3.1.2 Measuring Instruments

The measuring equipment is listed in the section 4 of this test report.

3.1.3 Test Procedure

1. The testing follows ANSI C63.10-2013 clause 7.8.3.
2. The RF output of EUT was connected to the spectrum analyzer by RF cable and attenuator. The path loss was compensated to the results for each measurement.
3. Set to the maximum power setting and enable the EUT transmit continuously.
4. Enable the EUT hopping function.
5. Use the following spectrum analyzer settings: Span = the frequency band of operation; RBW = 300kHz; VBW \geq RBW; Sweep = auto; Detector function = peak; Trace = max hold.
6. The number of hopping frequency used is defined as the number of total channel.
7. Record the measurement data derived from spectrum analyzer.

3.1.4 Test Setup



3.1.5 Test Result of Number of Hopping Frequency

Please refer to Appendix A.



Number of Hopping Channel Plot on Channel 00 - 78

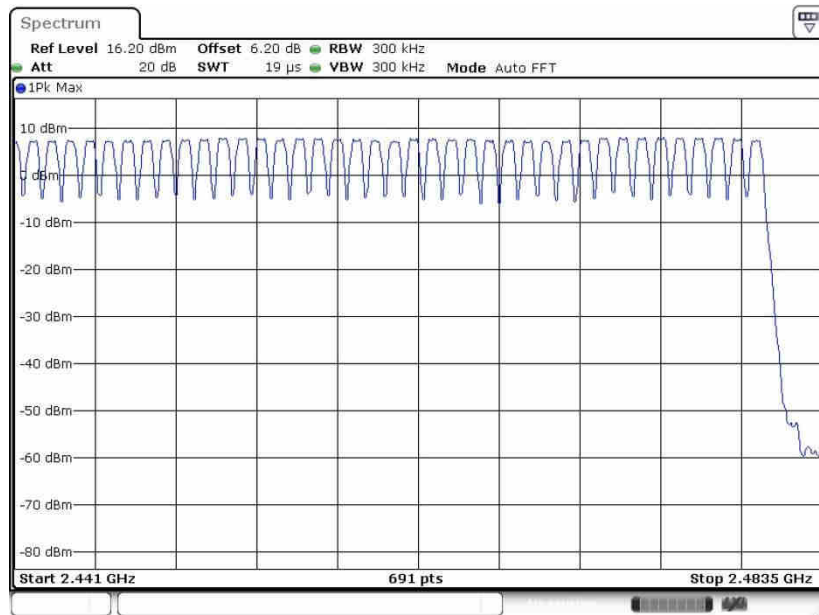
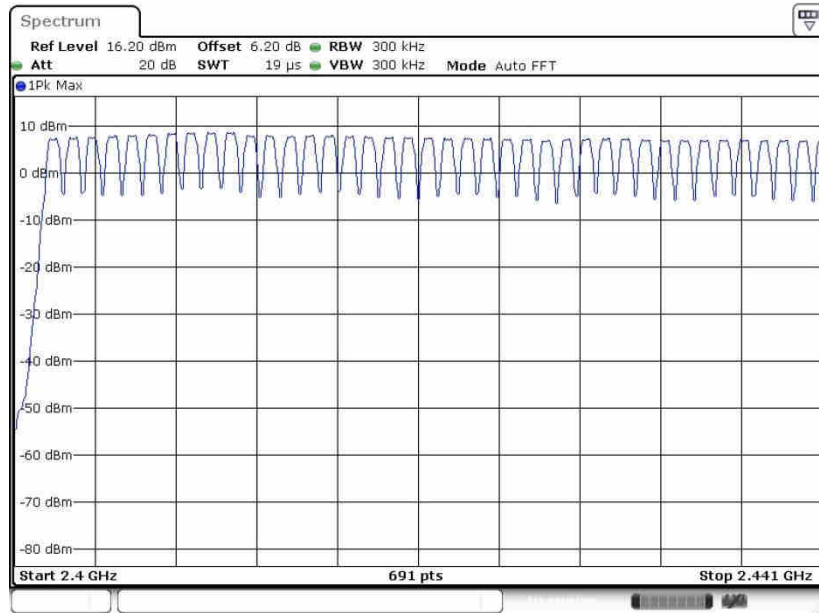

3.2 Hopping Channel Separation Measurement

3.2.1 Limit of Hopping Channel Separation

Frequency hopping systems operating in the 2400-2483.5 MHz band may have hopping channel carrier frequencies that are separated by 25 kHz or two-thirds of the 20 dB bandwidth of the hopping channel, whichever is greater.

3.2.2 Measuring Instruments

The measuring equipment is listed in the section 4 of this test report.

3.2.3 Test Procedures

1. The testing follows ANSI C63.10-2013 clause 7.8.2.
2. The RF output of EUT was connected to the spectrum analyzer by RF cable and attenuator. The path loss was compensated to the results for each measurement.
3. Set to the maximum power setting and enable the EUT transmit continuously.
4. Enable the EUT hopping function.
5. Use the following spectrum analyzer settings:
Span = wide enough to capture the peaks of two adjacent channels;
RBW = 300kHz; VBW \geq RBW; Sweep = auto; Detector function = peak; Trace = max hold.
6. Measure and record the results in the test report.

3.2.4 Test Setup

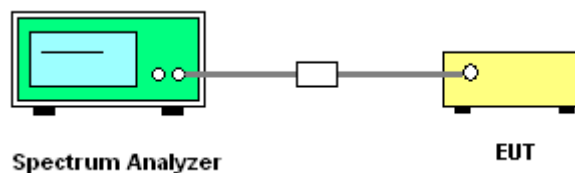

3.2.5 Test Result of Hopping Channel Separation

Please refer to Appendix A.



<1Mbps>

Channel Separation Plot on Channel 00 - 01

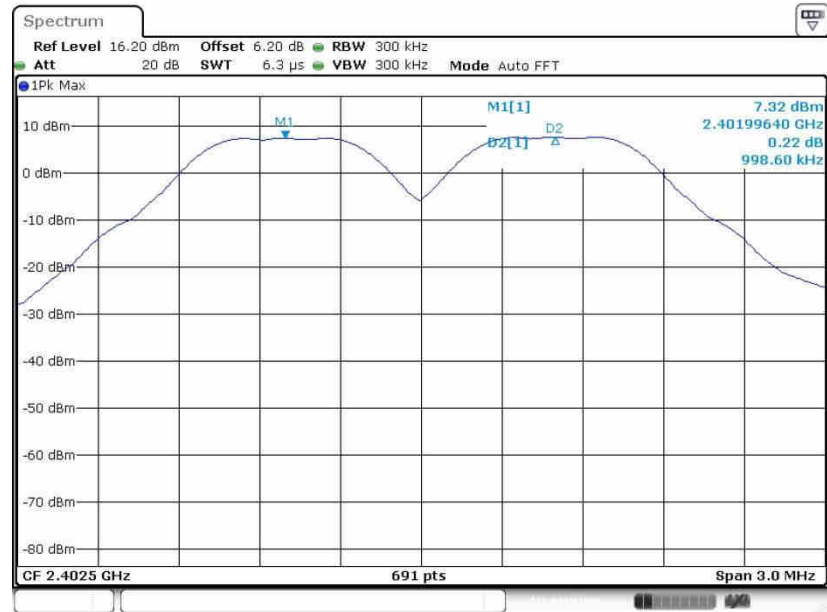

Channel Separation Plot on Channel 39 - 40

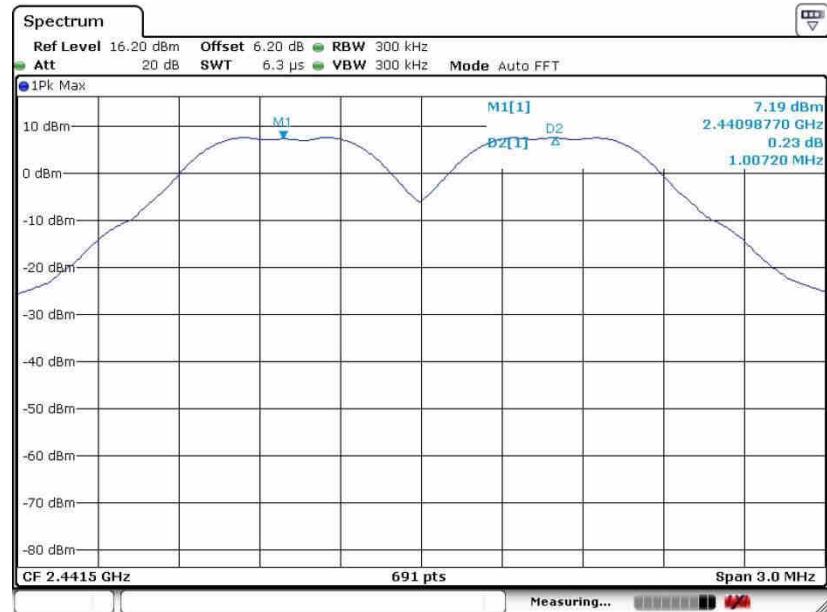



Channel Separation Plot on Channel 77 - 78

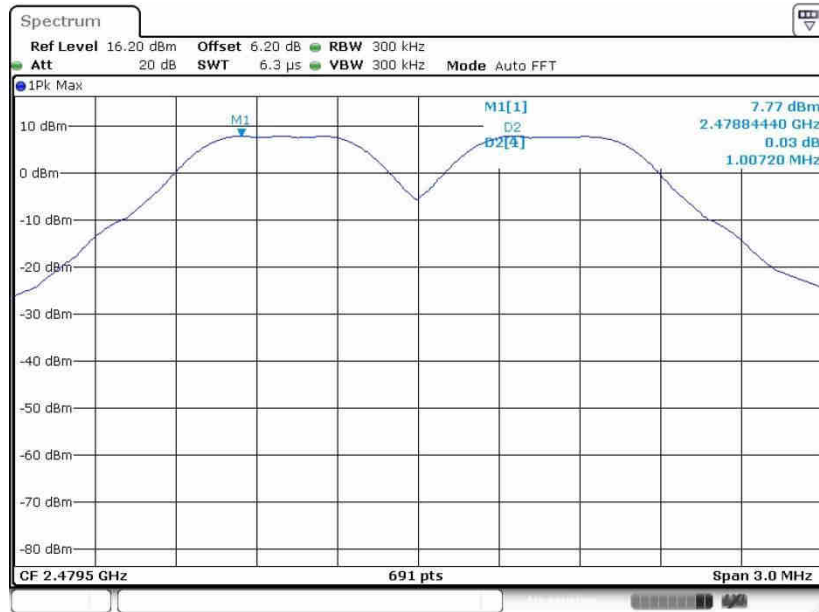

<2Mbps>

Channel Separation Plot on Channel 00 - 01

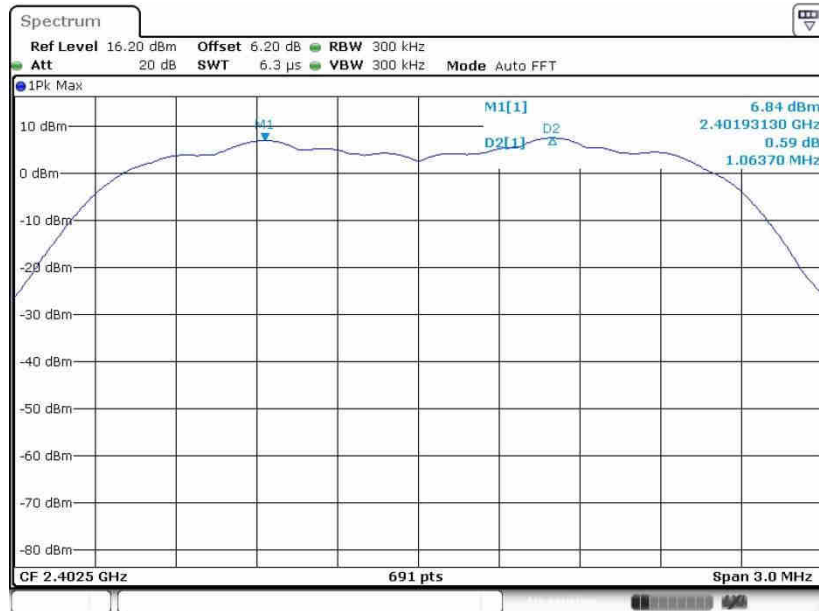



Channel Separation Plot on Channel 39 - 40

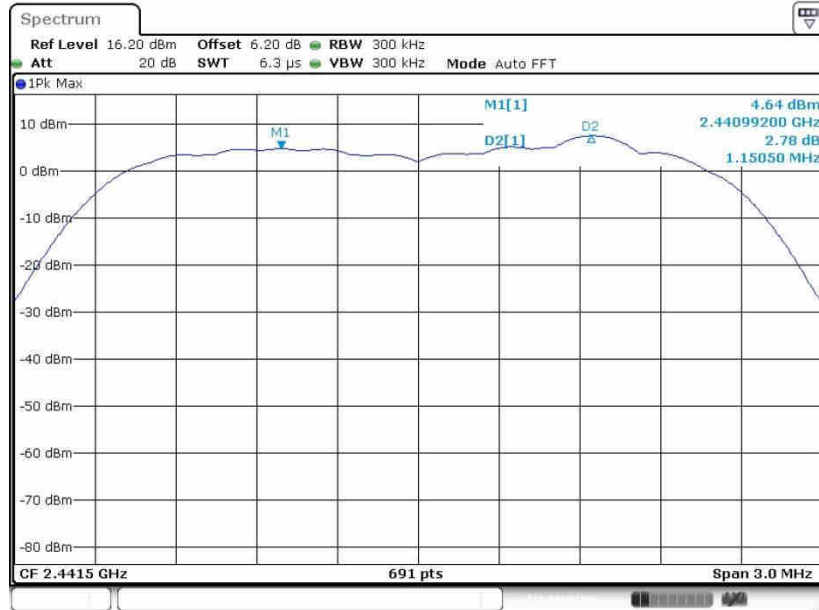

Channel Separation Plot on Channel 77 - 78

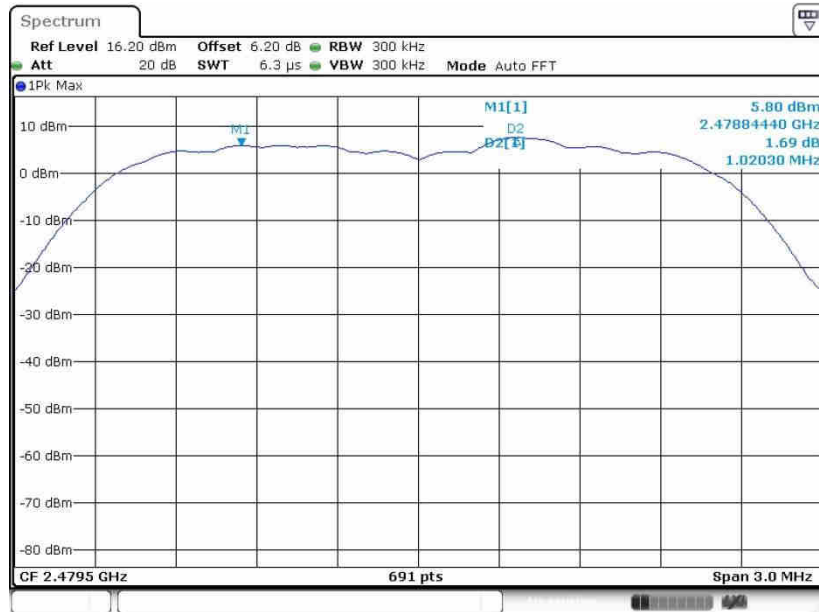



<3Mbps>

Channel Separation Plot on Channel 00 - 01

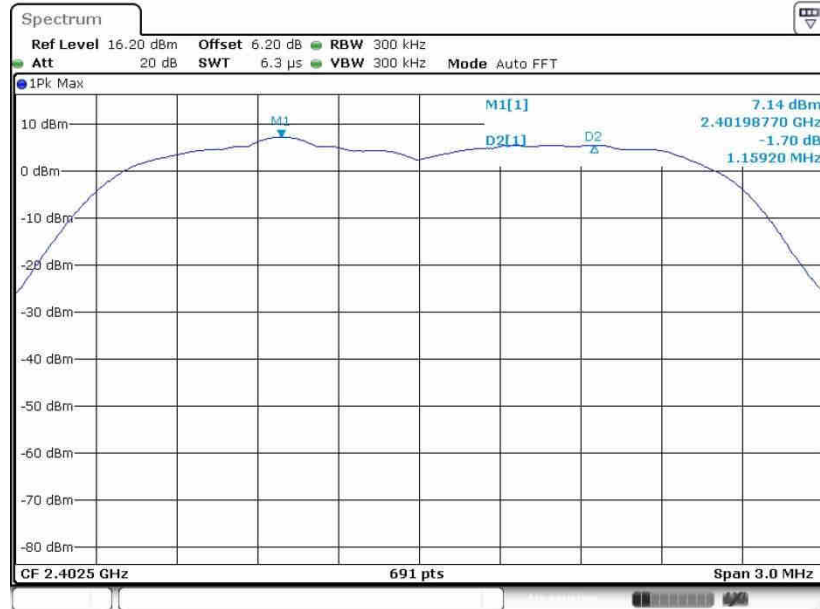

Channel Separation Plot on Channel 39 - 40

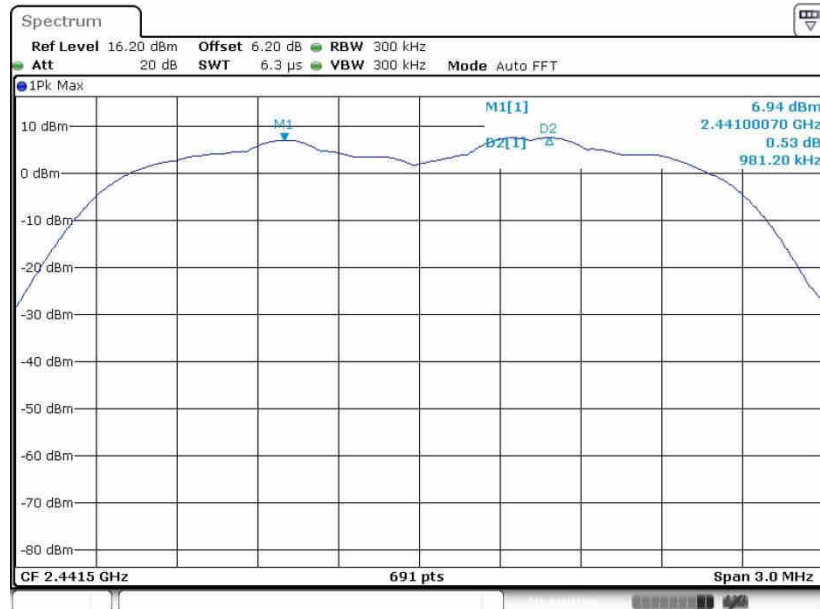



Channel Separation Plot on Channel 77 - 78

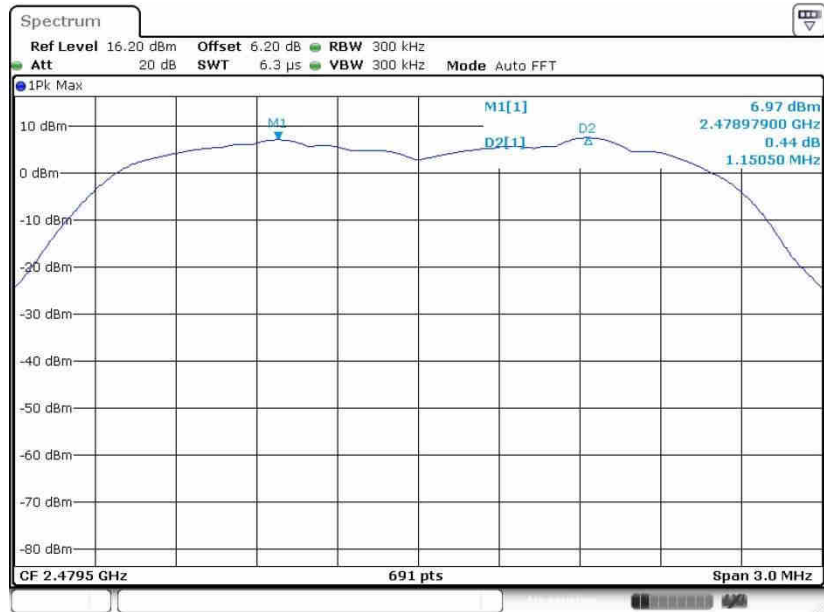

3.3 Dwell Time Measurement

3.3.1 Limit of Dwell Time

The average time of occupancy on any channel shall not be greater than 0.4 seconds within a period of 0.4 seconds multiplied by the number of hopping channels employed.

3.3.2 Measuring Instruments

The measuring equipment is listed in the section 4 of this test report.

3.3.3 Test Procedures

1. The testing follows ANSI C63.10-2013 clause 7.8.4.
2. The RF output of EUT was connected to the spectrum analyzer by RF cable and attenuator. The path loss was compensated to the results for each measurement.
3. Set to the maximum power setting and enable the EUT transmit continuously.
4. Enable the EUT hopping function.
5. Use the following spectrum analyzer settings: Span = zero span, centered on a hopping channel; RBW = 1 MHz; VBW \geq RBW; Sweep = as necessary to capture the entire dwell time per hopping channel; Detector function = peak; Trace = max hold.
6. Measure and record the results in the test report.

3.3.4 Test Setup

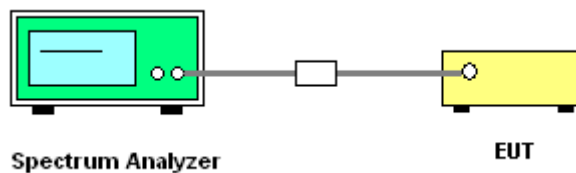

3.3.5 Test Result of Dwell Time

Please refer to Appendix A.

Package Transfer Time Plot

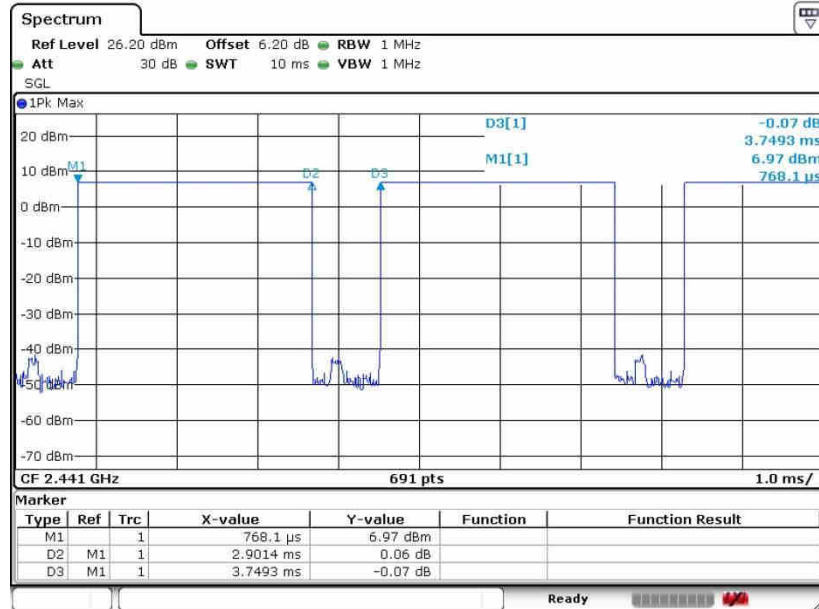

Remark:

- In normal mode, hopping rate is 1600 hops/s with 6 slots (5 Transmit and 1 Receive slot) in 79 hopping channels.
With channel hopping rate (1600 / 6 / 79) in Occupancy Time Limit (0.4 x 79) (s), Hops Over Occupancy Time comes to (1600 / 6 / 79) x (0.4 x 79) = 106.67 hops.
- In AFH mode, hopping rate is 800 hops/s with 6 slots in 20 hopping channels.
With channel hopping rate (800 / 6 / 20) in Occupancy Time Limit (0.4 x 20) (s), Hops Over Occupancy Time comes to (800 / 6 / 20) x (0.4 x 20) = 53.33 hops.
- Dwell Time(s) = Hops Over Occupancy Time (hops) x Package Transfer Time

3.4 20dB and 99% Bandwidth Measurement

3.4.1 Limit of 20dB and 99% Bandwidth

Reporting only

3.4.2 Measuring Instruments

The measuring equipment is listed in the section 4 of this test report.

3.4.3 Test Procedures

1. The testing follows ANSI C63.10-2013 clause 6.9.2 and 6.9.3.
2. The RF output of EUT was connected to the spectrum analyzer by RF cable and attenuator. The path loss was compensated to the results for each measurement.
3. Set to the maximum power setting and enable the EUT transmit continuously.
4. Use the following spectrum analyzer settings for 20dB Bandwidth measurement.
Span = approximately 2 to 5 times the 20 dB bandwidth, centered on a hopping channel;
RBW \geq 1% of the 20 dB bandwidth; VBW \geq RBW; Sweep = auto; Detector function = peak;
Trace = max hold.
5. Use the following spectrum analyzer settings for 99 % Bandwidth measurement.
Span = approximately 1.5 to 5 times the 99% bandwidth, centered on a hopping channel;
RBW \geq 1% of the 99% bandwidth; VBW \geq RBW; Sweep = auto; Detector function =sample;
Trace = max hold.
6. Measure and record the results in the test report.

3.4.4 Test Setup

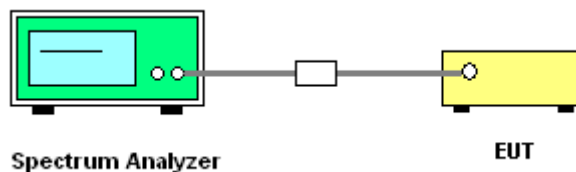

3.4.5 Test Result of 20dB Bandwidth

Please refer to Appendix A.



<1Mbps>

20 dB Bandwidth Plot on Channel 00

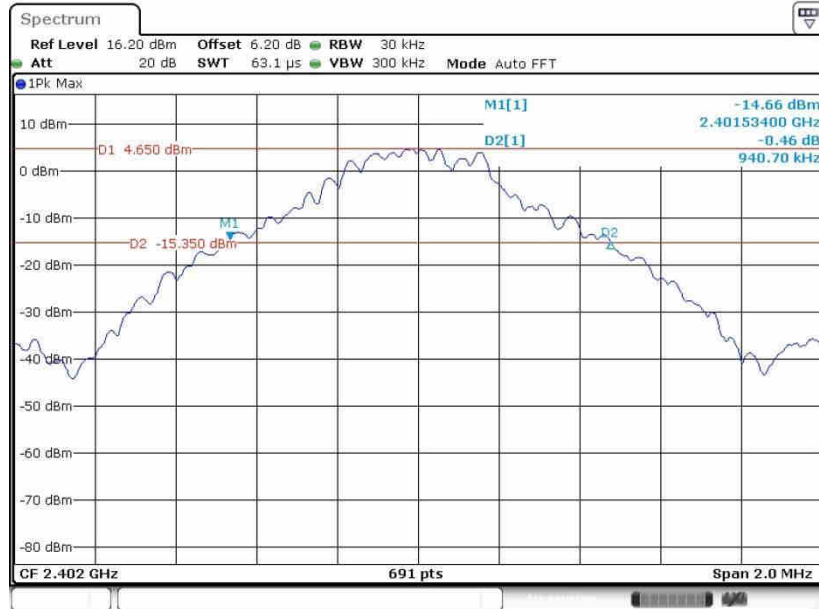

20 dB Bandwidth Plot on Channel 39

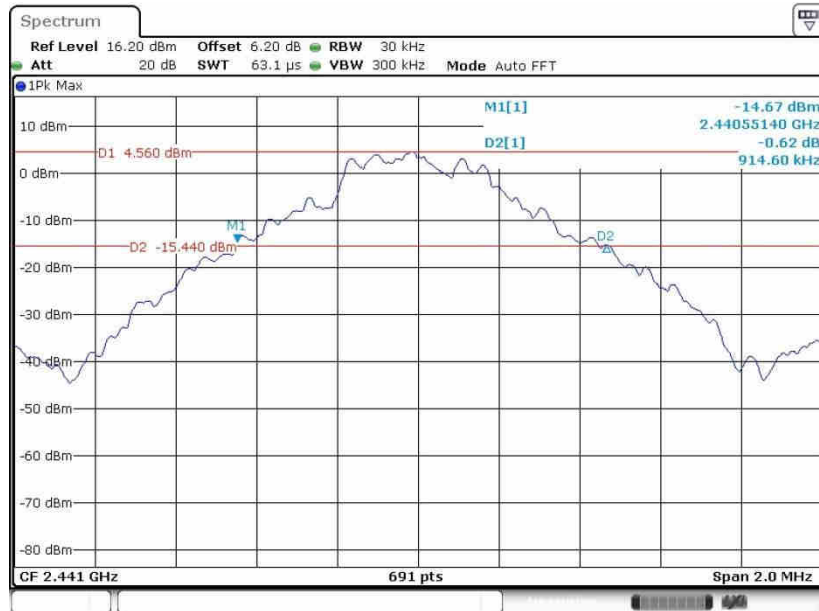



20 dB Bandwidth Plot on Channel 78

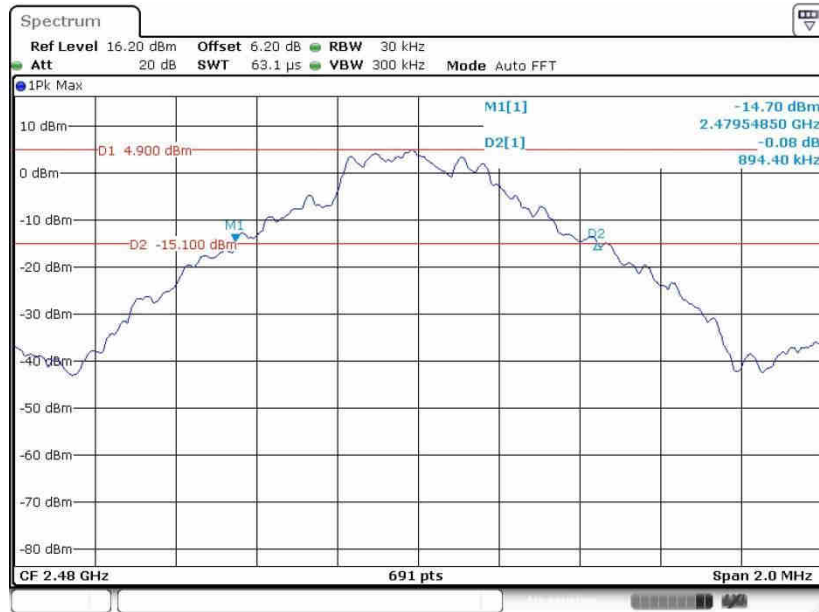

<2Mbps>

20 dB Bandwidth Plot on Channel 00

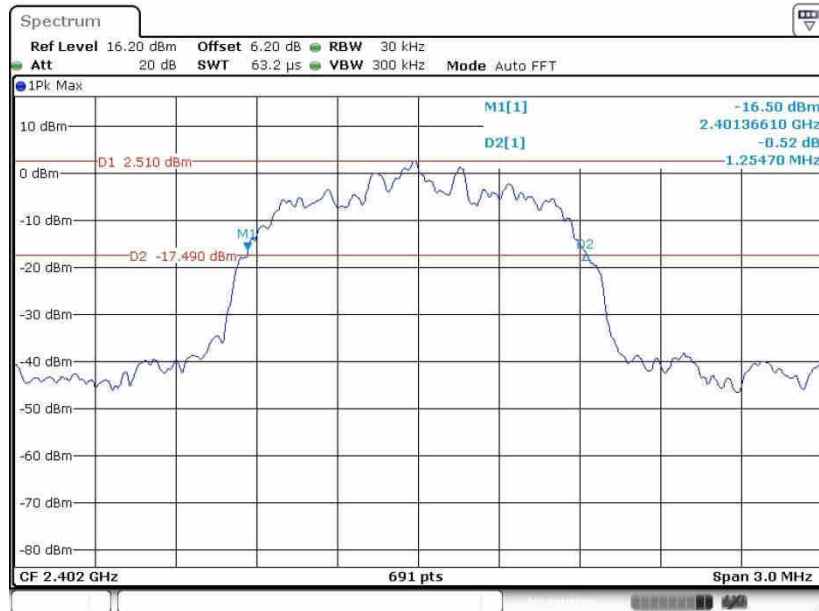



20 dB Bandwidth Plot on Channel 39

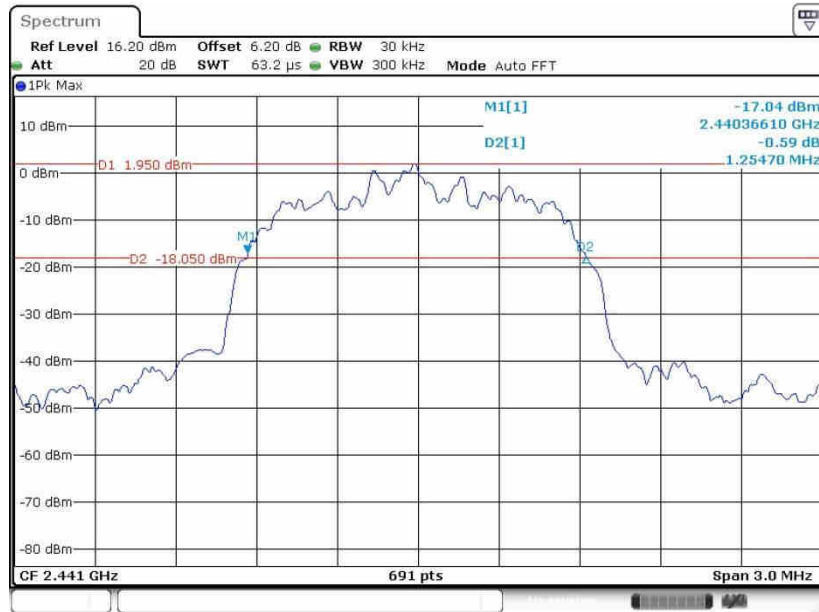

20 dB Bandwidth Plot on Channel 78

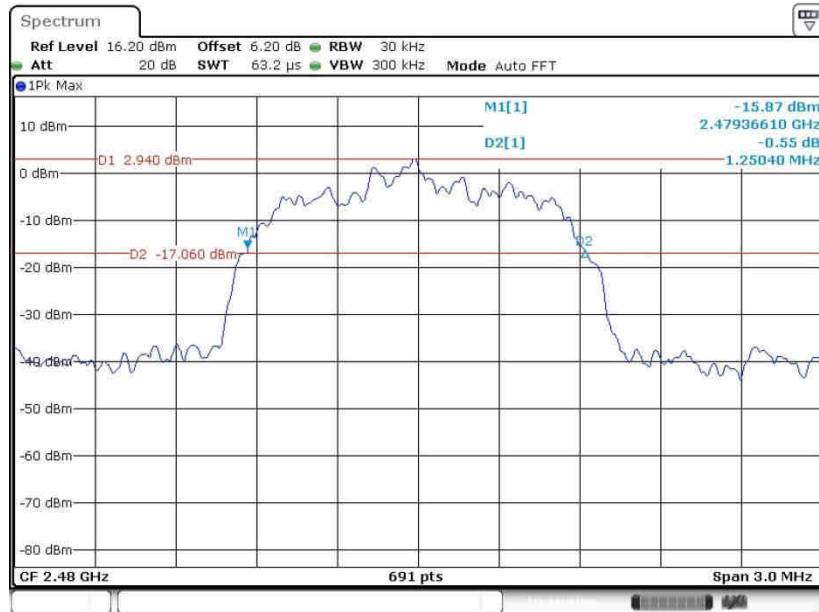



<3Mbps>

20 dB Bandwidth Plot on Channel 00

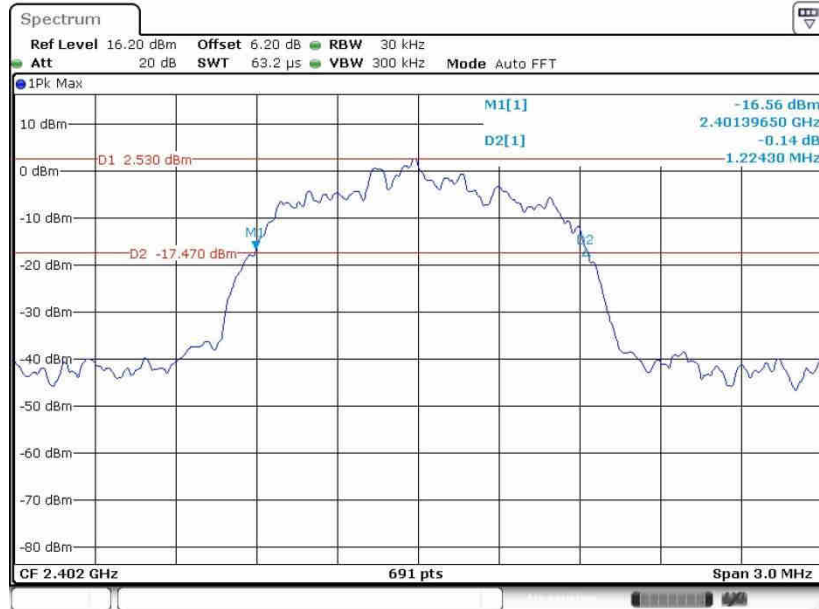

20 dB Bandwidth Plot on Channel 39

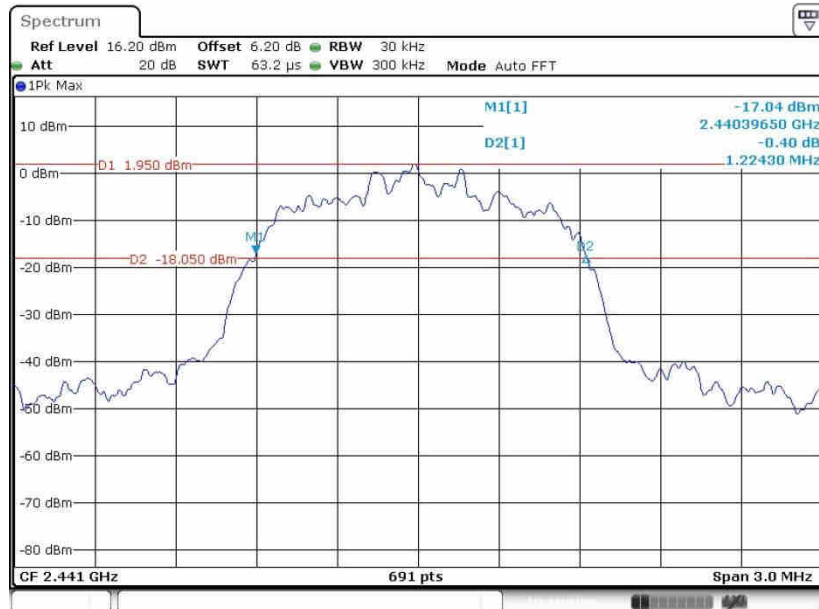



20 dB Bandwidth Plot on Channel 78

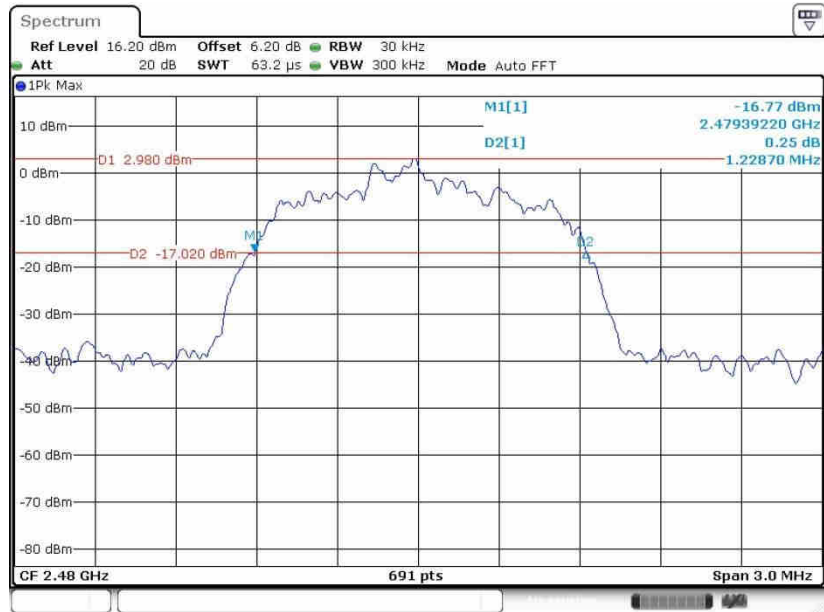



3.4.6 Test Result of 99% Occupied Bandwidth

Please refer to Appendix A.

<1Mbps>

99% Occupied Bandwidth Plot on Channel 00



99% Occupied Bandwidth Plot on Channel 39





99% Occupied Bandwidth Plot on Channel 78



<2Mbps>

99% Occupied Bandwidth Plot on Channel 00

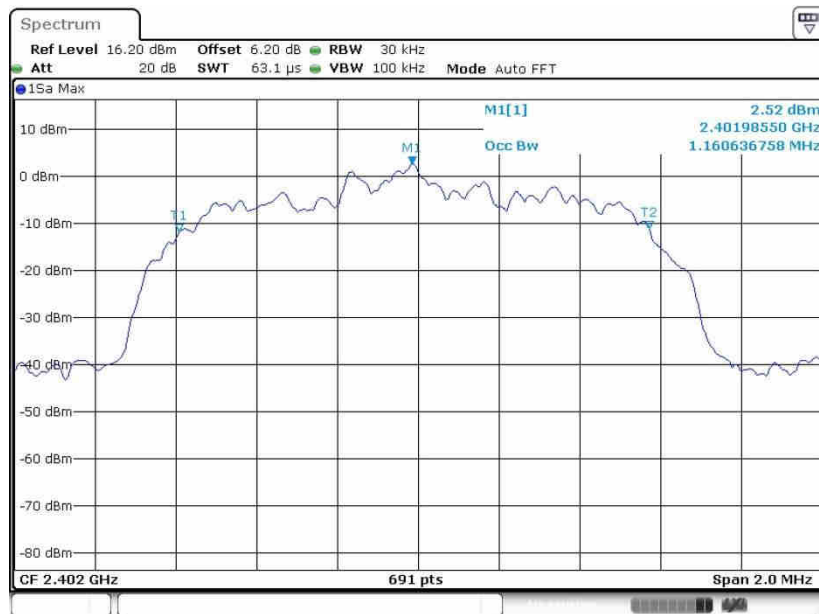



99% Occupied Bandwidth Plot on Channel 39

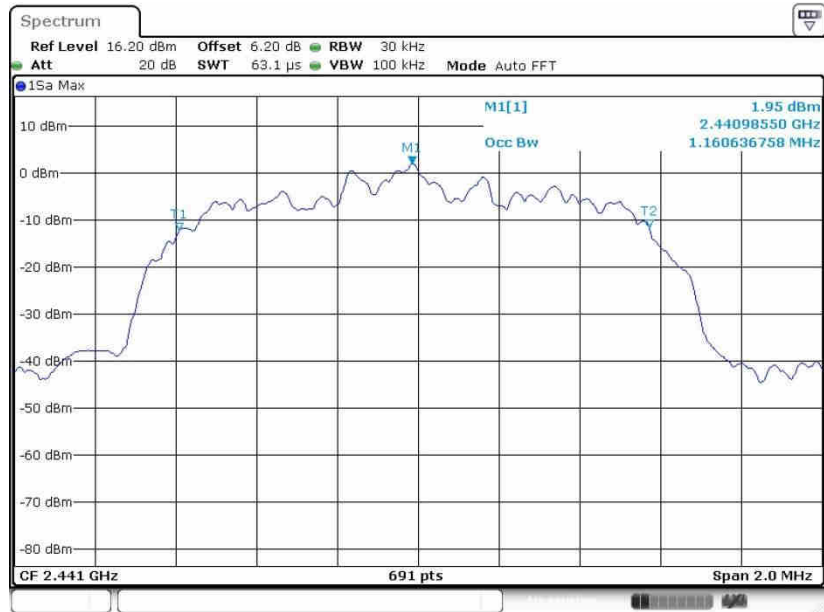

99% Occupied Bandwidth Plot on Channel 78

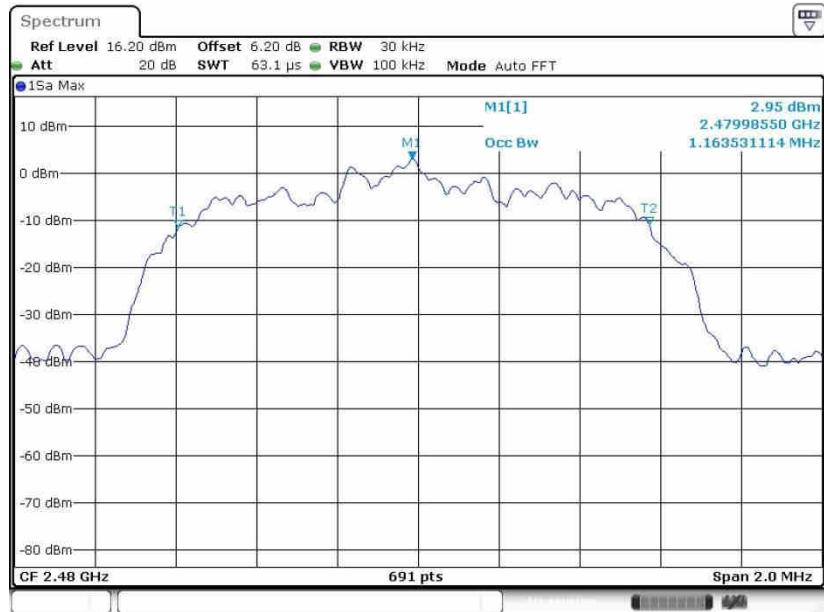



<3Mbps>

99% Occupied Bandwidth Plot on Channel 00

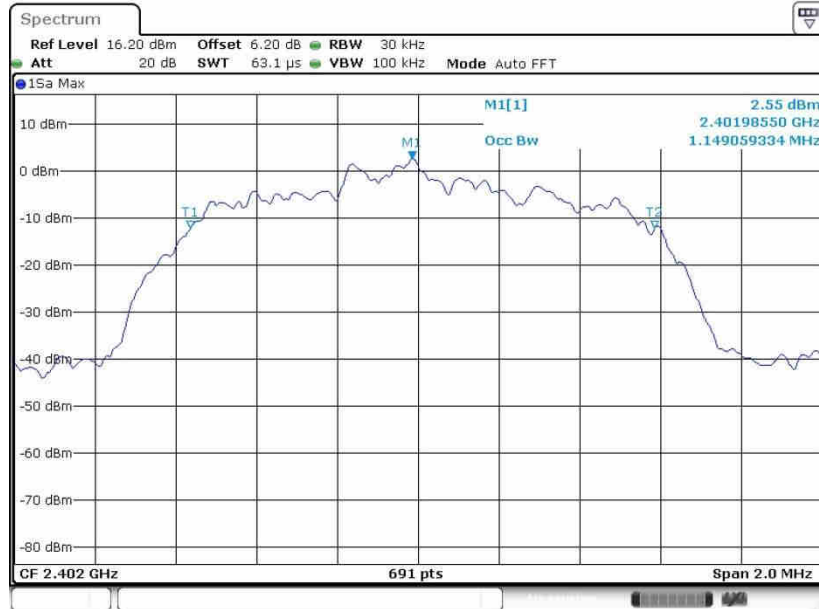

99% Occupied Bandwidth Plot on Channel 39

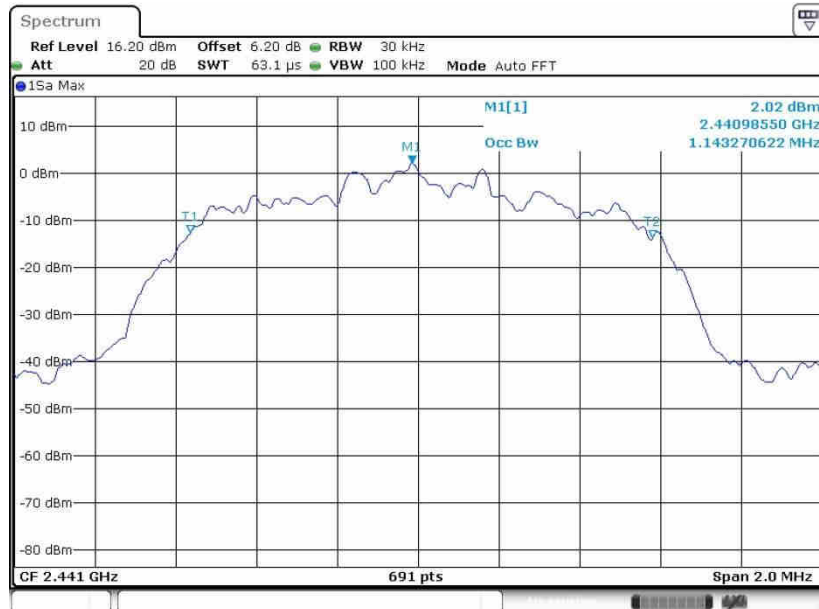



99% Occupied Bandwidth Plot on Channel 78

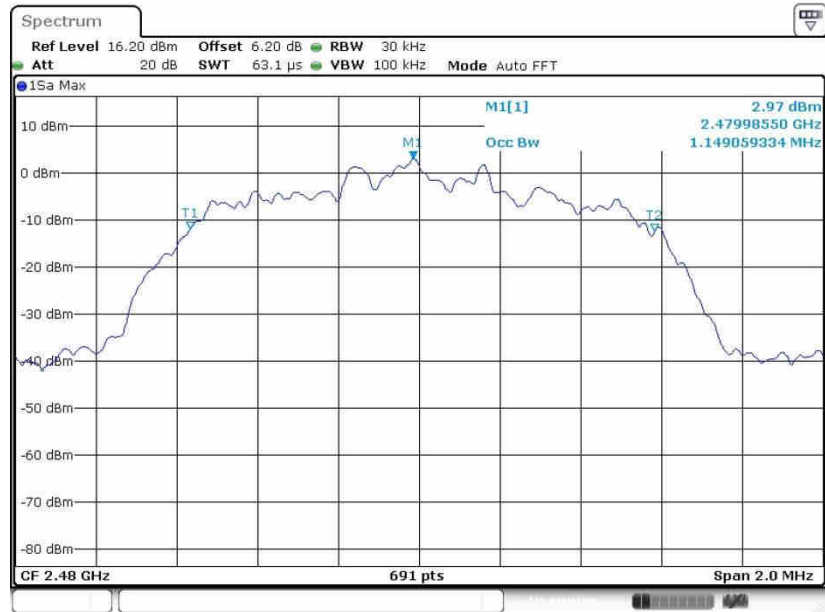

Note : The occupied channel bandwidth is maintained within the band of operation for all of the modulations.

3.5 Output Power Measurement

3.5.1 Limit of Output Power

The maximum peak conducted output power of the intentional radiator shall not exceed the following:

- (1) For frequency hopping systems operating in the 2400-2483.5 MHz band employing at least 75 non-overlapping hopping channels, and all frequency hopping systems in the 5725-5850 MHz band: 1 watt. For all other frequency hopping systems in the 2400-2483.5 MHz band 0.125 watts.

3.5.2 Measuring Instruments

The measuring equipment is listed in the section 4 of this test report.

3.5.3 Test Procedures

1. The testing follows ANSI C63.10-2013 clause 7.8.5.
2. The RF output of EUT was connected to the power meter by RF cable and attenuator. The path loss was compensated to the results for each measurement.
3. Set to the maximum power setting and enable the EUT transmit continuously.
4. Measure the conducted output power with cable loss and record the results in the test report.
5. Measure and record the results in the test report.

3.5.4 Test Setup

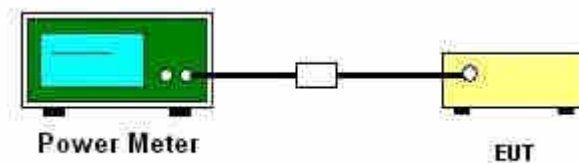

3.5.5 Test Result of Peak Output Power

Please refer to Appendix A.

3.5.6 Test Result of Average Output Power (Reporting Only)

Please refer to Appendix A.

3.6 Conducted Band Edges Measurement

3.6.1 Limit of Band Edges

In any 100 kHz bandwidth outside the intentional radiation frequency band, the radio frequency power shall be at least 20 dB below the highest level of the radiated power. In addition, radiated emissions which fall in the restricted bands must also comply with the radiated emission limits.

3.6.2 Measuring Instruments

The measuring equipment is listed in the section 4 of this test report.

3.6.3 Test Procedures

1. The testing follows ANSI C63.10-2013 clause 7.8.6.
2. Set to the maximum power setting and enable the EUT transmit continuously.
3. Set RBW = 100kHz, VBW = 300kHz. Band edge emissions must be at least 20 dB down from the highest emission level within the authorized band as measured with a 100kHz RBW. The attenuation shall be 30 dB instead of 20 dB when RMS conducted output power procedure is used.
4. Enable hopping function of the EUT and then repeat step 2. and 3.
5. Measure and record the results in the test report.

3.6.4 Test Setup





3.6.5 Test Result of Conducted Band Edges

<1Mbps>

Low Band Edge Plot on Channel 00

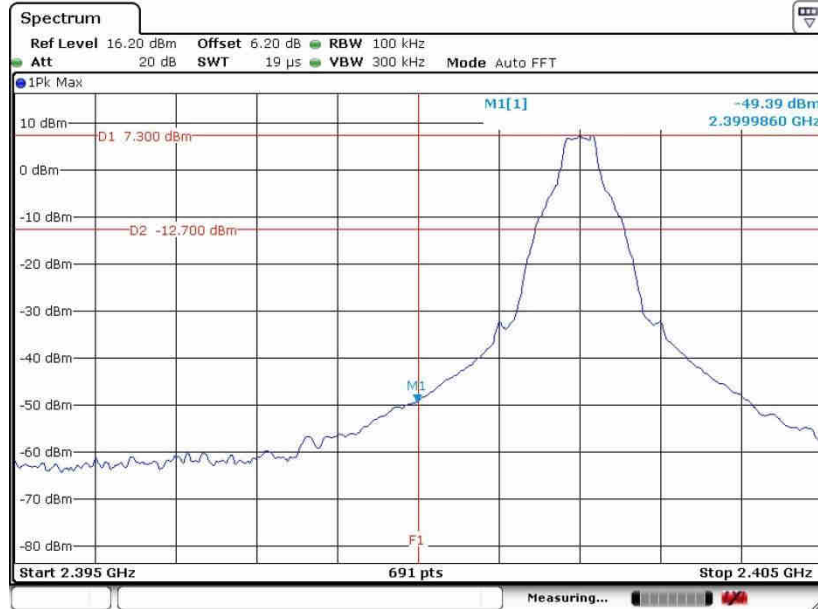

High Band Edge Plot on Channel 78

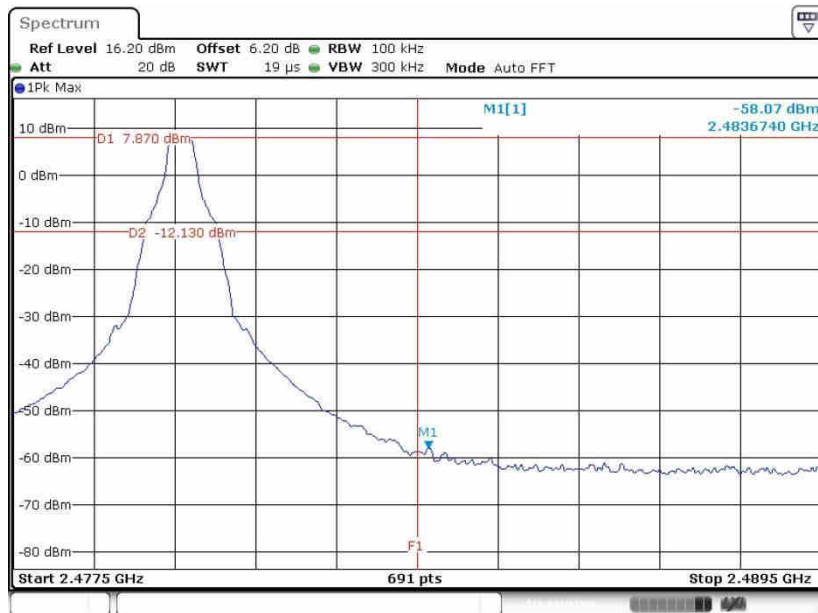



<2Mbps>

Low Band Edge Plot on Channel 00

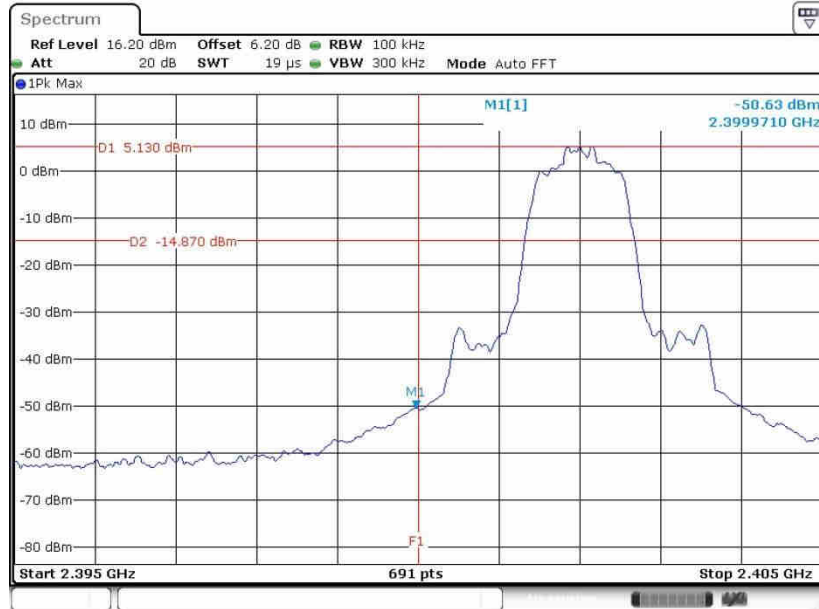

High Band Edge Plot on Channel 78

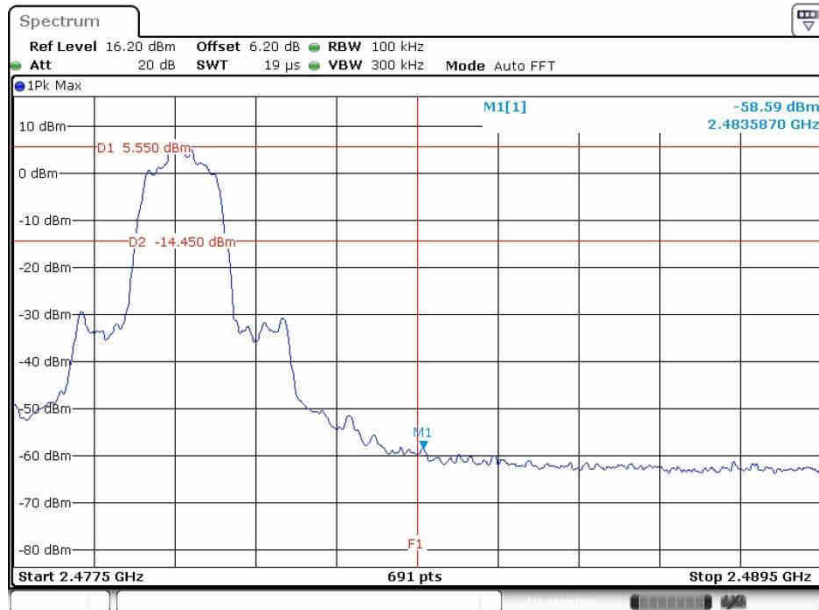



<3Mbps>

Low Band Edge Plot on Channel 00

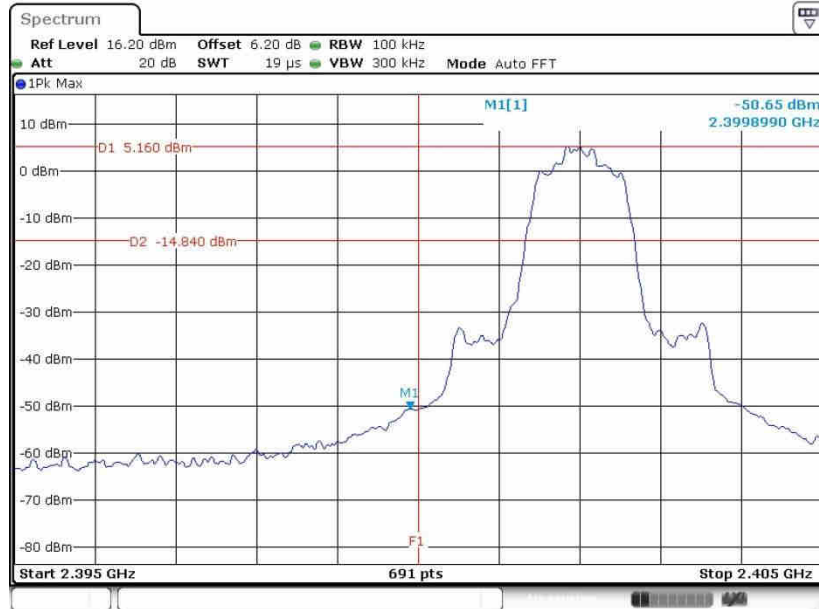

High Band Edge Plot on Channel 78

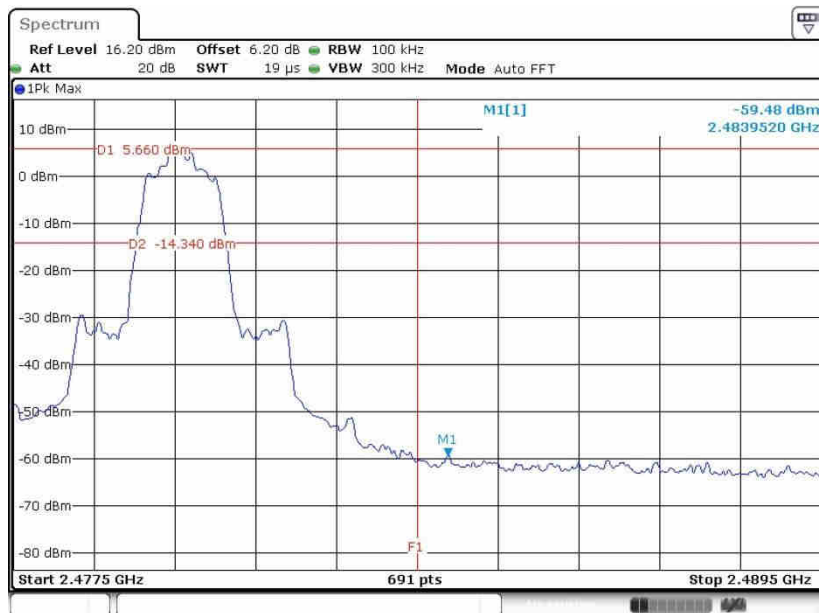



3.6.6 Test Result of Conducted Hopping Mode Band Edges

<1Mbps>

Hopping Mode Low Band Edge Plot

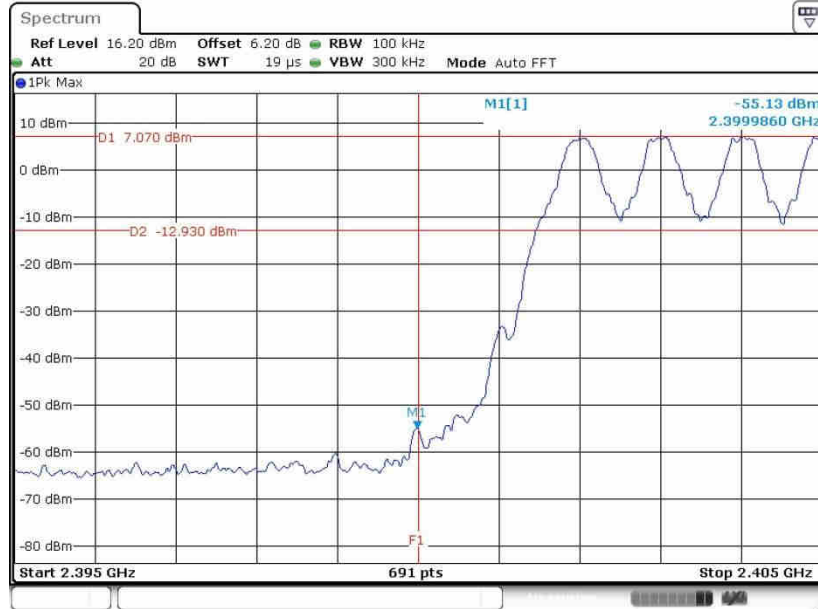

Hopping Mode High Band Edge Plot

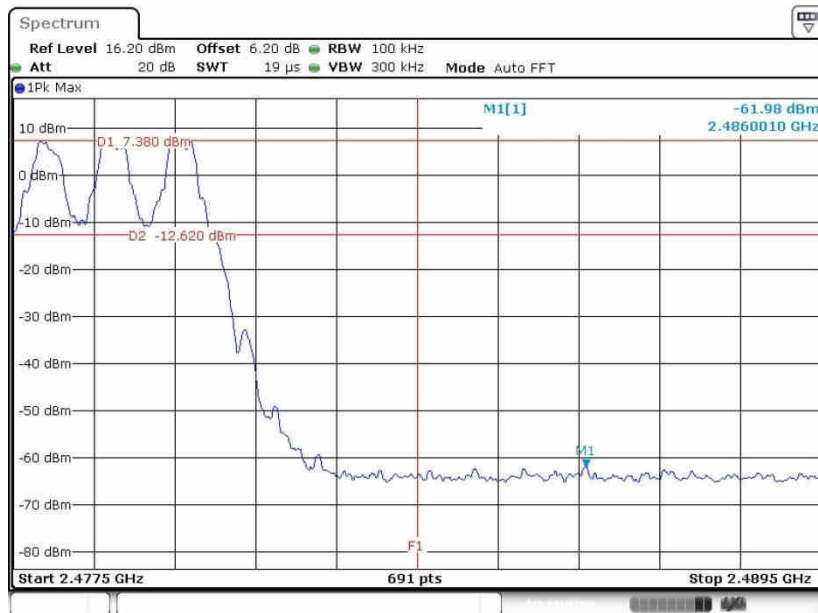



<2Mbps>

Hopping Mode Low Band Edge Plot

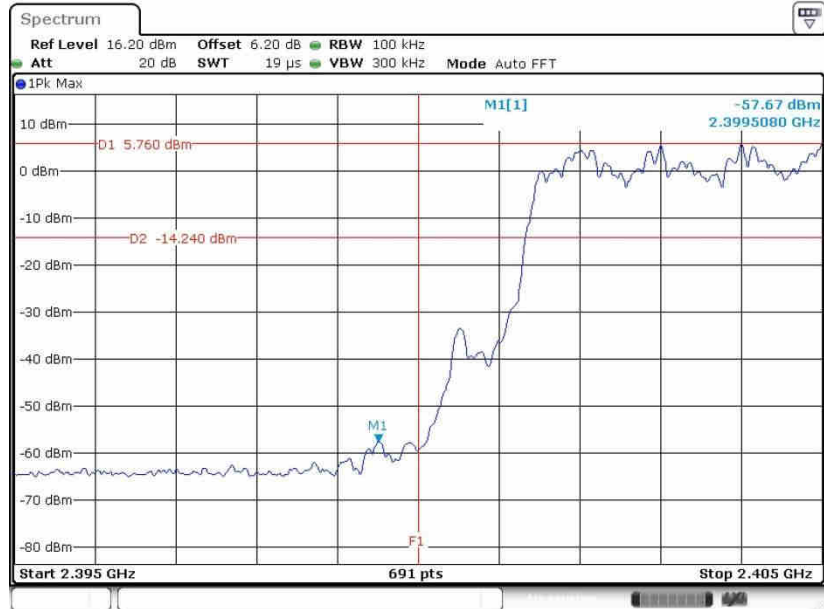

Hopping Mode High Band Edge Plot

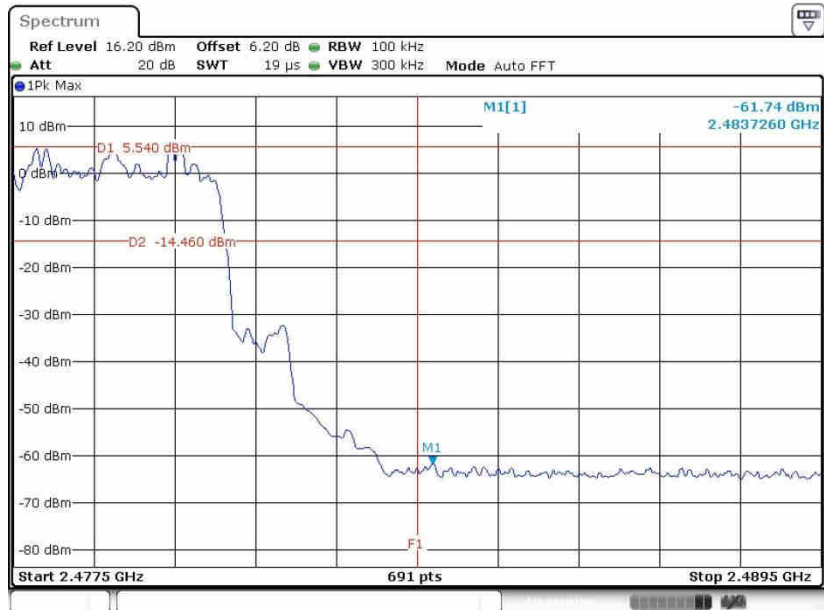



<3Mbps>

Hopping Mode Low Band Edge Plot

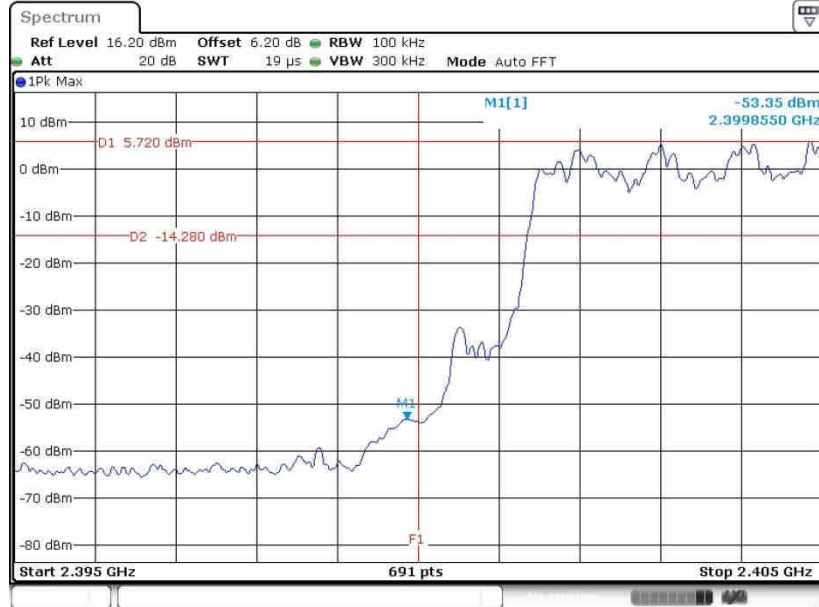

Hopping Mode High Band Edge Plot



3.7 Conducted Spurious Emission Measurement

3.7.1 Limit of Spurious Emission Measurement

In any 100 kHz bandwidth outside the intentional radiation frequency band, the radio frequency power shall be at least 20 dB below the highest level of the radiated power. In addition, radiated emissions which fall in the restricted bands must also comply with the radiated emission limits.

3.7.2 Measuring Instruments

The measuring equipment is listed in the section 4 of this test report.

3.7.3 Test Procedure

1. The testing follows ANSI C63.10-2013 clause 7.8.8.
2. The RF output of EUT was connected to the spectrum analyzer by RF cable and attenuator. The path loss was compensated to the results for each measurement.
3. Set to the maximum power setting and enable the EUT transmit continuously.
4. Set RBW = 100 kHz, VBW = 300kHz, scan up through 10th harmonic. All harmonics / spurs must be at least 20 dB down from the highest emission level within the authorized band as measured with a 100 kHz RBW.
5. Measure and record the results in the test report.
6. The RF fundamental frequency should be excluded against the limit line in the operating frequency band.

3.7.4 Test Setup

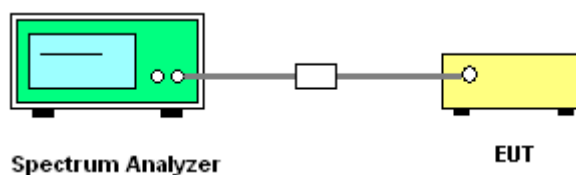



3.7.5 Test Result of Conducted Spurious Emission

<1Mbps>

CSE Plot on Ch 00 between 30MHz ~ 3 GHz

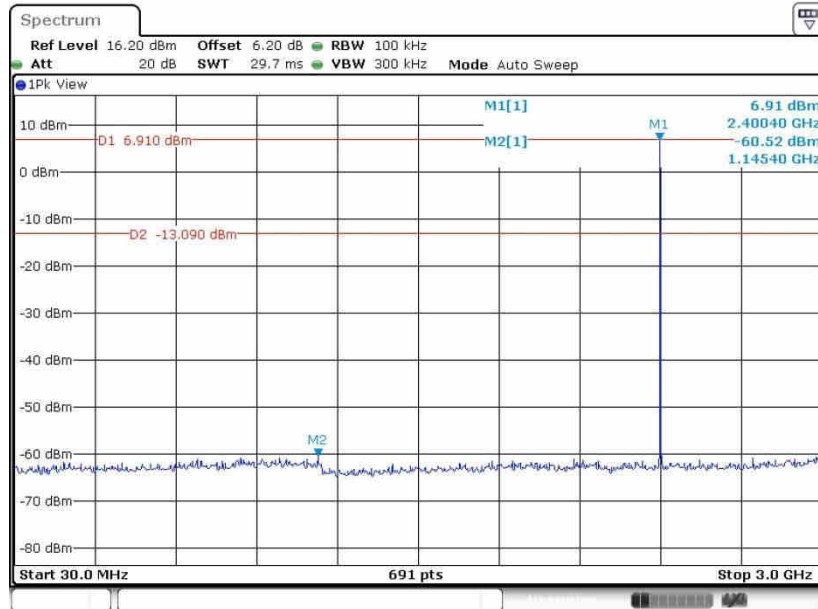

1Mbps CSE Plot on Ch 00 between 2 GHz ~ 25 GHz

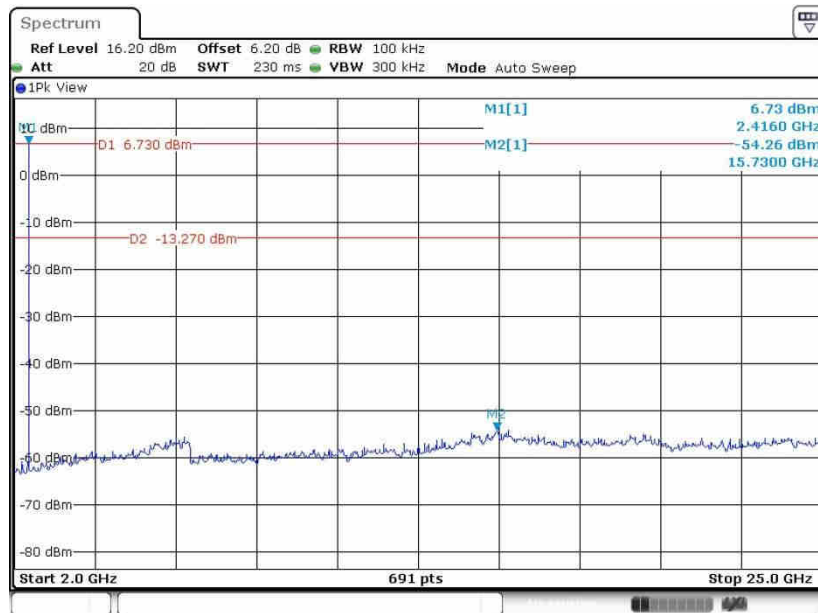



CSE Plot on Ch 39 between 30MHz ~ 3 GHz

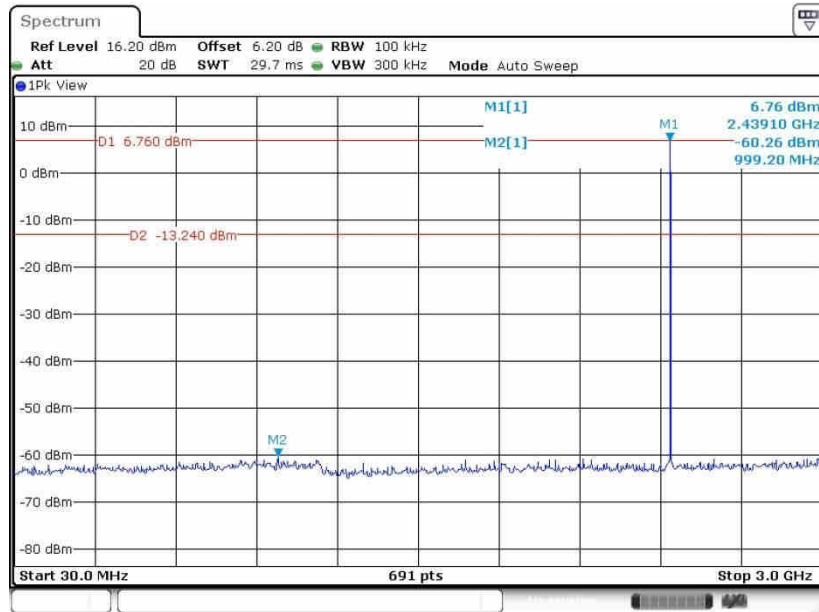

CSE Plot on Ch 39 between 2 GHz ~ 25 GHz

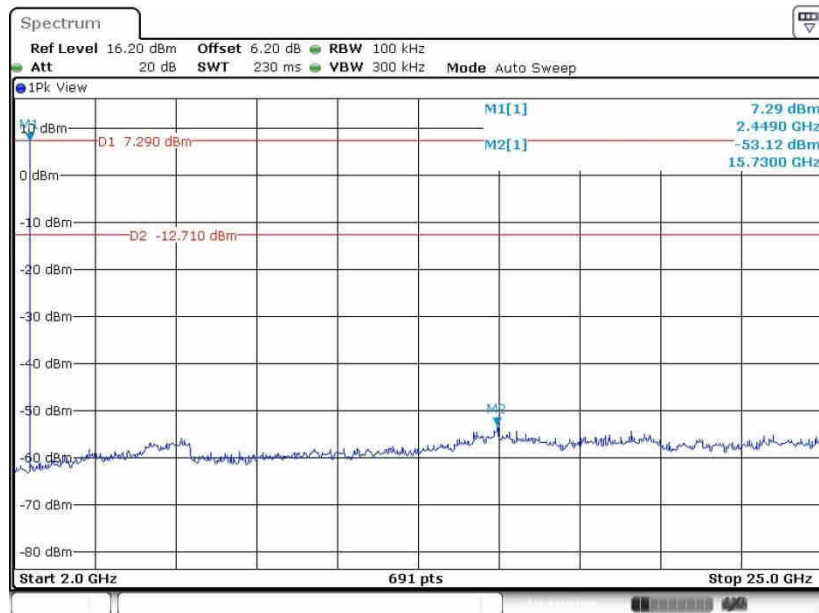



CSE Plot on Ch 78 between 30MHz ~ 3 GHz

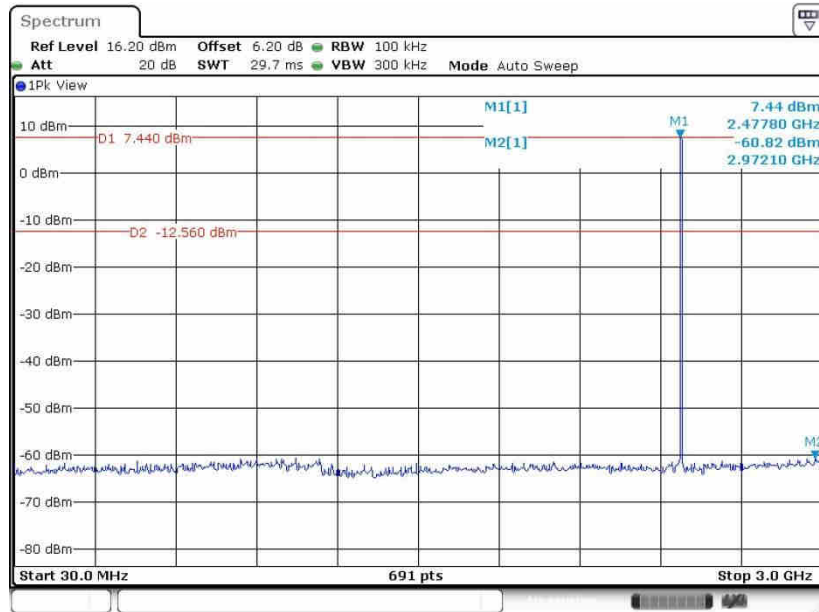

CSE Plot on Ch 78 between 2 GHz ~ 25 GHz

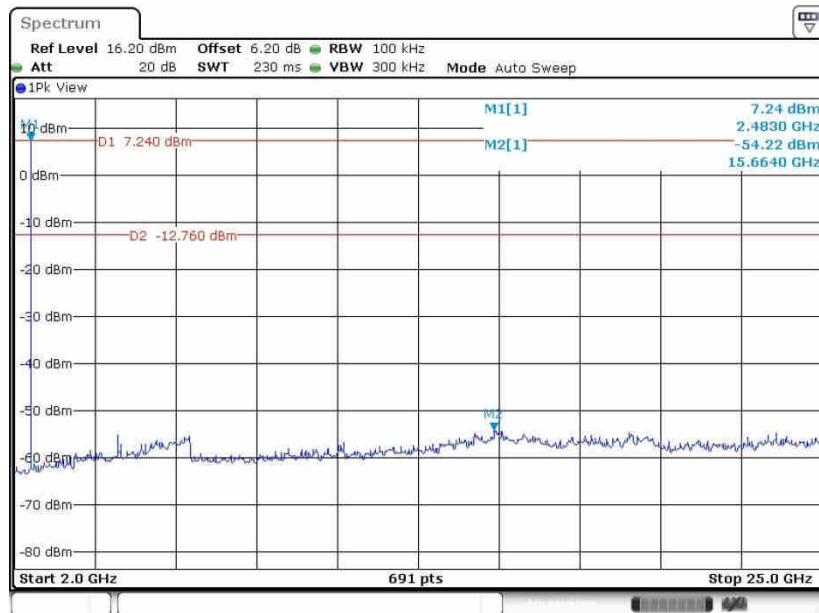



<2Mbps>

CSE Plot on Ch 00 between 30MHz ~ 3 GHz

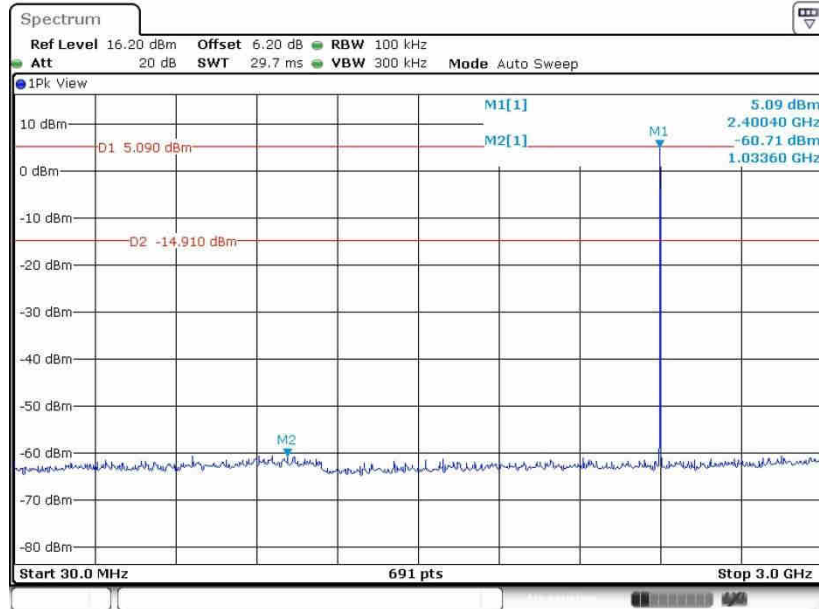

CSE Plot on Ch 00 between 2 GHz ~ 25 GHz

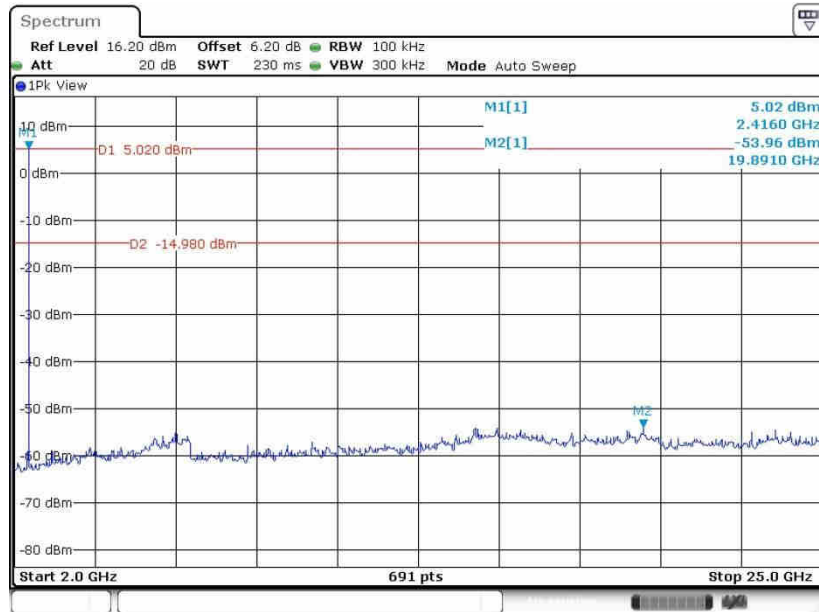



CSE Plot on Ch 39 between 30MHz ~ 3 GHz

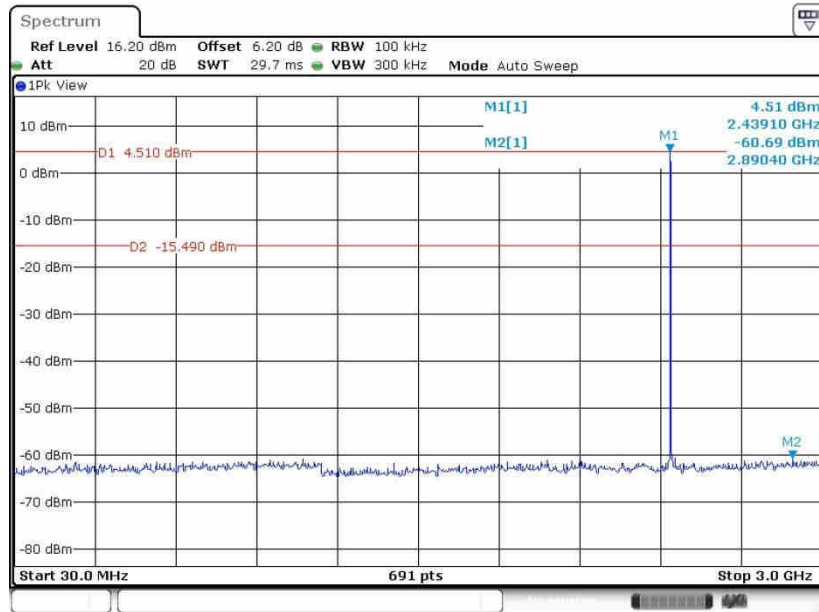

CSE Plot on Ch 39 between 2 GHz ~ 25 GHz

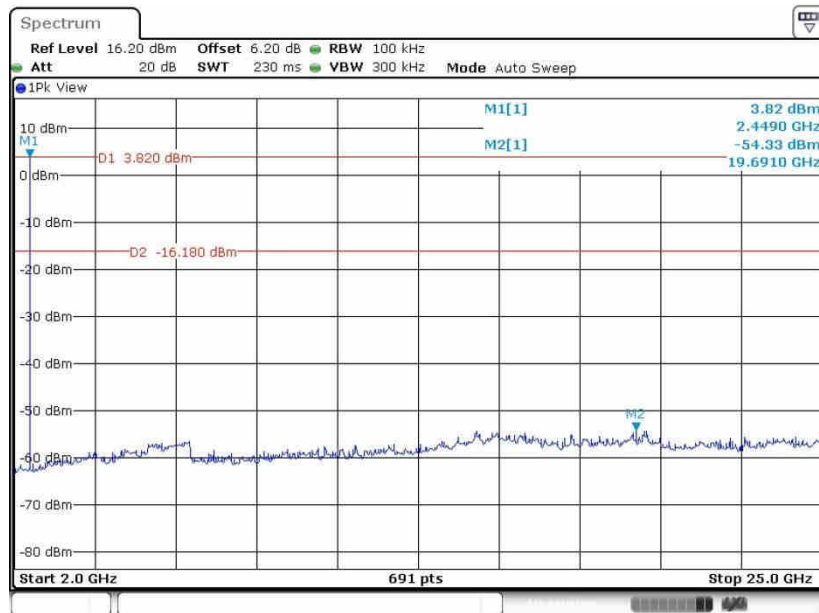



CSE Plot on Ch 78 between 30MHz ~ 3 GHz

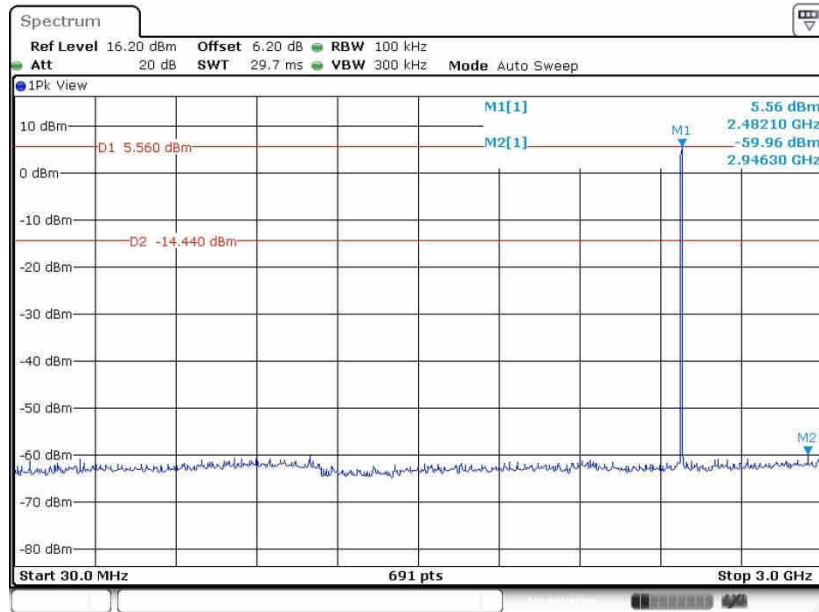

CSE Plot on Ch 78 between 2 GHz ~ 25 GHz

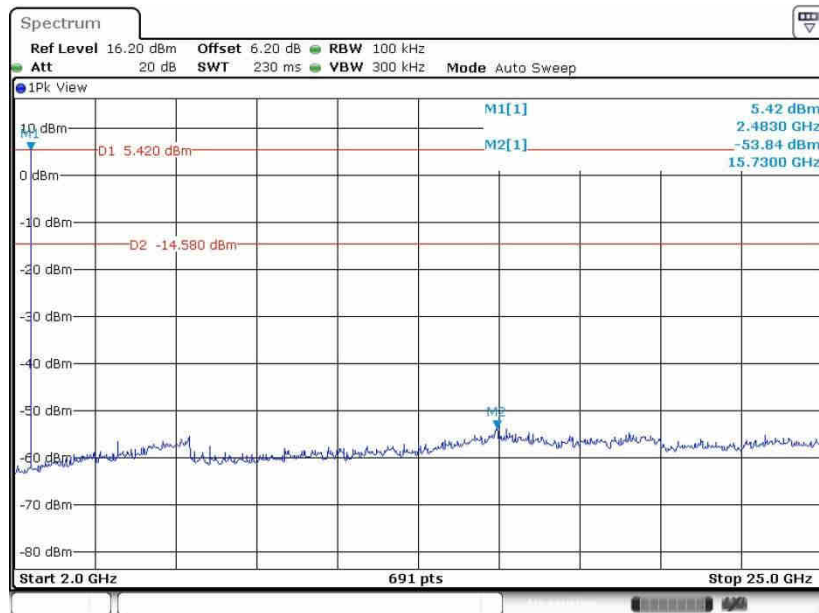



<3Mbps>

CSE Plot on Ch 00 between 30MHz ~ 3 GHz

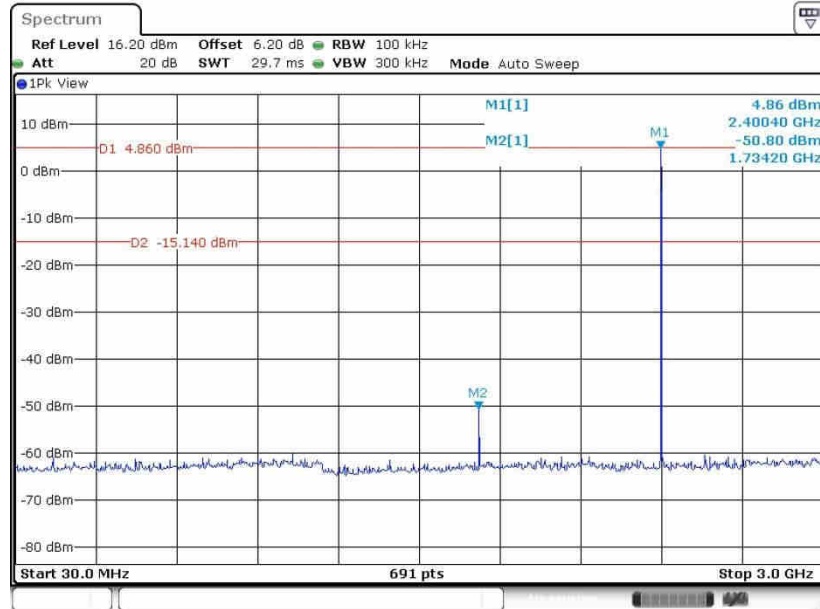

CSE Plot on Ch 00 between 2 GHz ~ 25 GHz

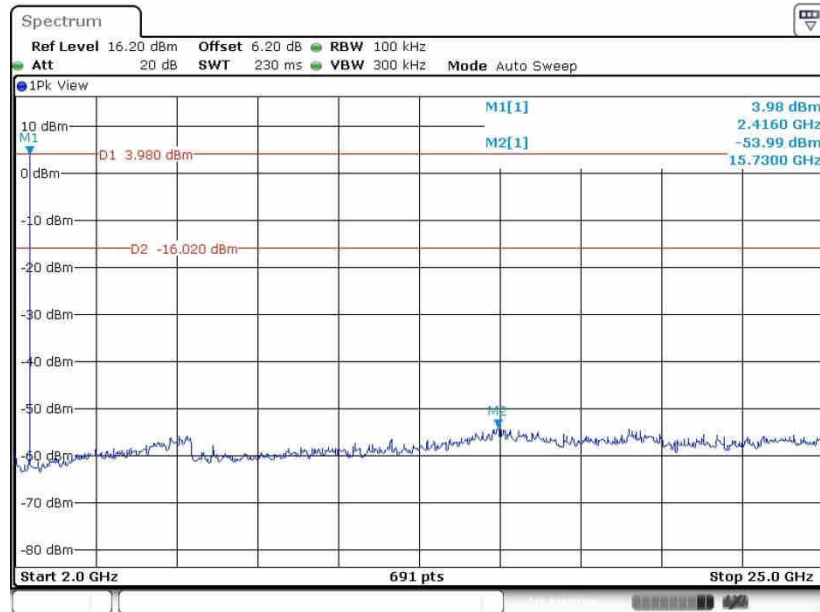



CSE Plot on Ch 39 between 30MHz ~ 3 GHz

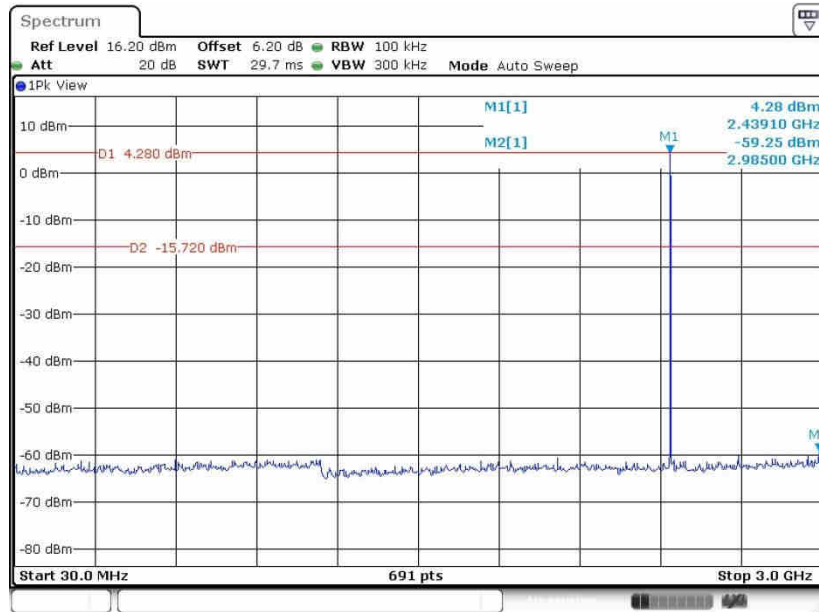

CSE Plot on Ch 39 between 2 GHz ~ 25 GHz

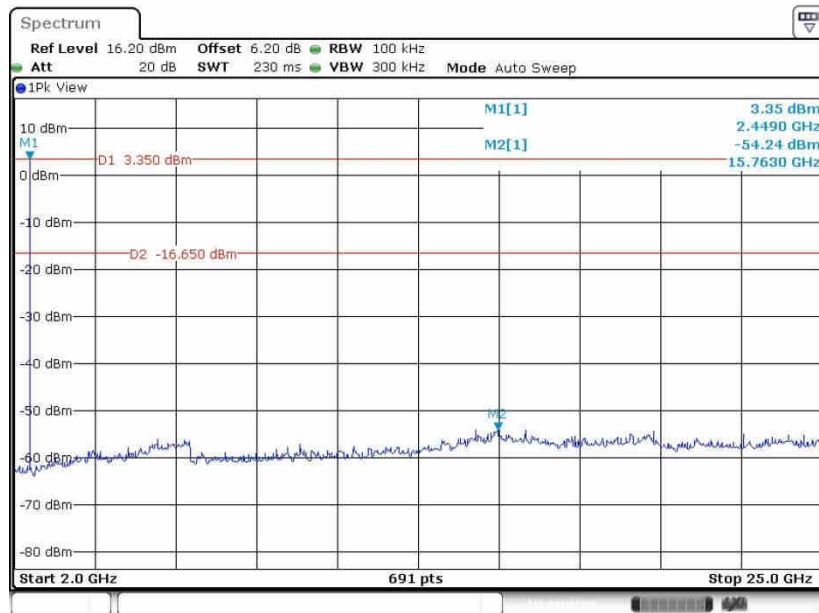



CSE Plot on Ch 78 between 30MHz ~ 3 GHz

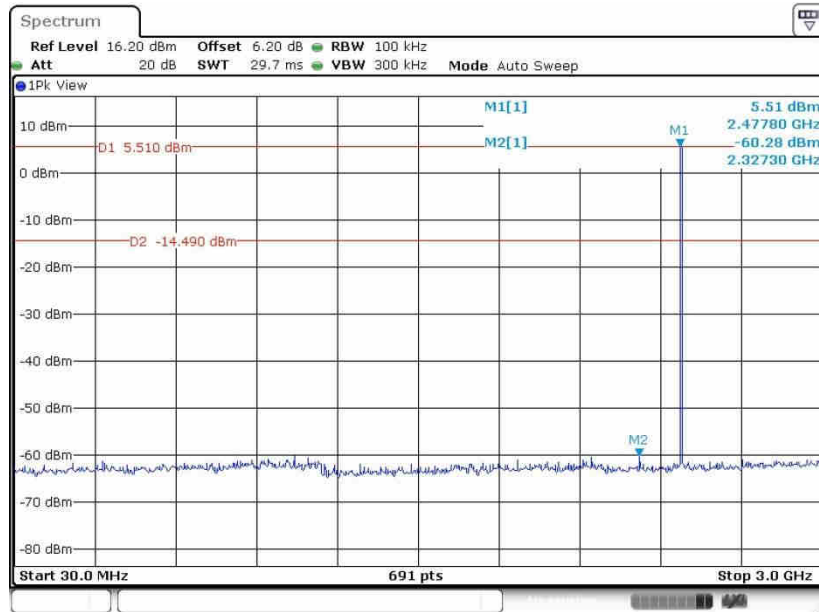

CSE Plot on Ch 78 between 2 GHz ~ 25 GHz

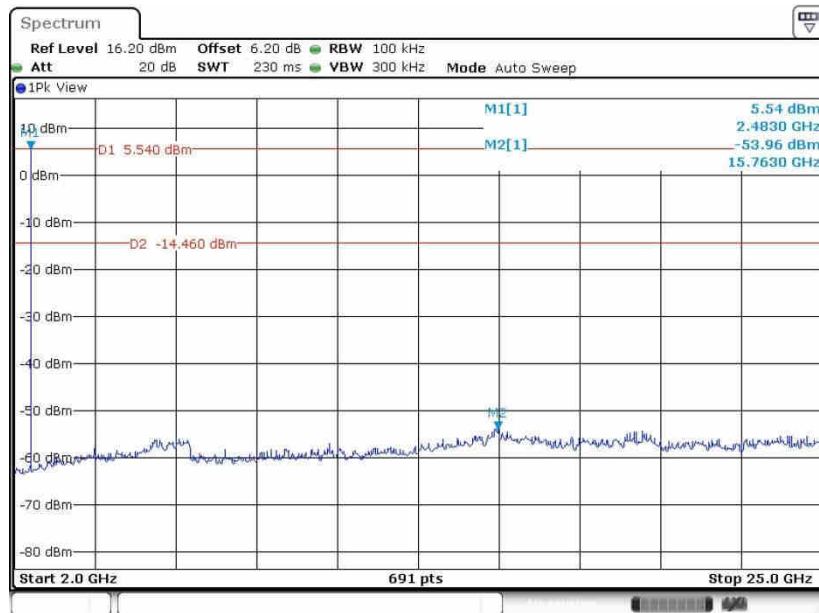



3.8 Radiated Band Edges and Spurious Emission Measurement

3.8.1 Limit of Radiated Band Edges and Spurious Emission

In any 100 kHz bandwidth outside the intentional radiator frequency band, all harmonics/spurious must be at least 20 dB below the highest emission level within the authorized band. In addition, radiated emissions which fall in the restricted bands must also comply with the limits as below.

| Frequency (MHz) | Field Strength (microvolts/meter) | Measurement Distance (meters) |
|-----------------|-----------------------------------|-------------------------------|
| 0.009 – 0.490 | 2400/F(kHz) | 300 |
| 0.490 – 1.705 | 24000/F(kHz) | 30 |
| 1.705 – 30.0 | 30 | 30 |
| 30 – 88 | 100 | 3 |
| 88 – 216 | 150 | 3 |
| 216 - 960 | 200 | 3 |
| Above 960 | 500 | 3 |

3.8.2 Measuring Instruments

The measuring equipment is listed in the section 4 of this test report.



3.8.3 Test Procedures

1. The EUT was placed on a turntable with 0.8 meter for frequency below 1GHz and 1.5 meter for frequency above 1GHz respectively above ground.
2. The EUT was set 3 meters from the interference receiving antenna, which was mounted on the top of a variable height antenna tower.
3. For each suspected emission, the EUT was arranged to its worst case and then tune the Antenna tower (from 1 m to 4 m) and turntable (from 0 degree to 360 degrees) to find the maximum reading. A pre-amp and a high pass filter are used for the test in order to get better signal level to comply with the guidelines.
4. Set to the maximum power setting and enable the EUT transmit continuously.
5. Use the following spectrum analyzer settings:
 - (1) Span shall wide enough to fully capture the emission being measured;
 - (2) Set RBW=100 kHz for $f < 1 \text{ GHz}$, RBW=1MHz for $f > 1\text{GHz}$; VBW \geq RBW; Sweep = auto; Detector function = peak; Trace = max hold for peak
 - (3) For average measurement: use duty cycle correction factor method per 15.35(c).
Duty cycle = On time/100 milliseconds
On time = $N_1 * L_1 + N_2 * L_2 + \dots + N_{n-1} * L_{n-1} + N_n * L_n$
Where N_1 is number of type 1 pulses, L_1 is length of type 1 pulses, etc.
Average Emission Level = Peak Emission Level + $20 * \log(\text{Duty cycle})$
6. Corrected Reading: Antenna Factor + Cable Loss + Read Level - Preamp Factor = Level
7. For testing below 1GHz, if the emission level of the EUT in peak mode was 3 dB lower than the limit specified, then peak values of EUT will be reported, otherwise, the emissions will be repeated one by one using the CISPR quasi-peak method and reported.
8. For testing above 1GHz, the emission level of the EUT in peak mode was 20dB lower than average limit (that means the emission level in average mode also complies with the limit in average mode), then peak values of EUT will be reported, otherwise, the emissions will be measured in average mode again and reported.

Note: The average levels were calculated from the peak level corrected with duty cycle correction factor (-24.79dB) derived from $20 \log(\text{dwell time}/100\text{ms})$. This correction is only for signals that hop with the fundamental signal, such as band-edge and harmonic. Other spurious signals that are independent of the hopping signal would not use this correction.

3.8.4 Test Setup

For radiated emissions below 30MHz

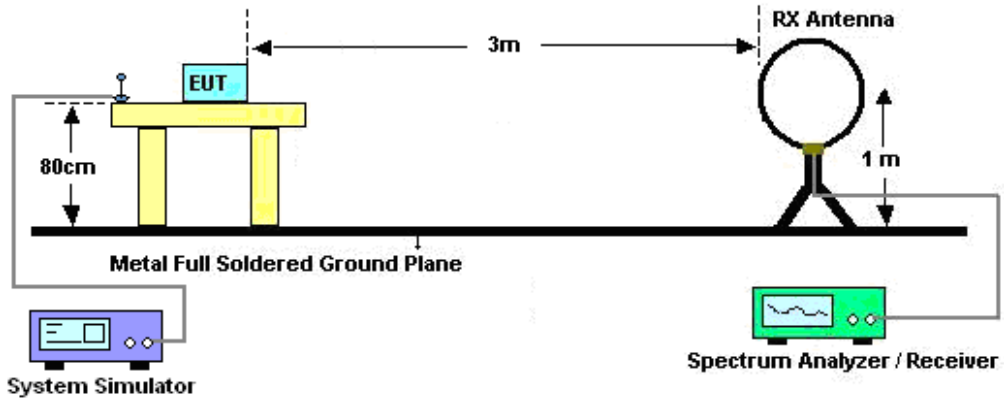

For radiated emissions from 30MHz to 1GHz

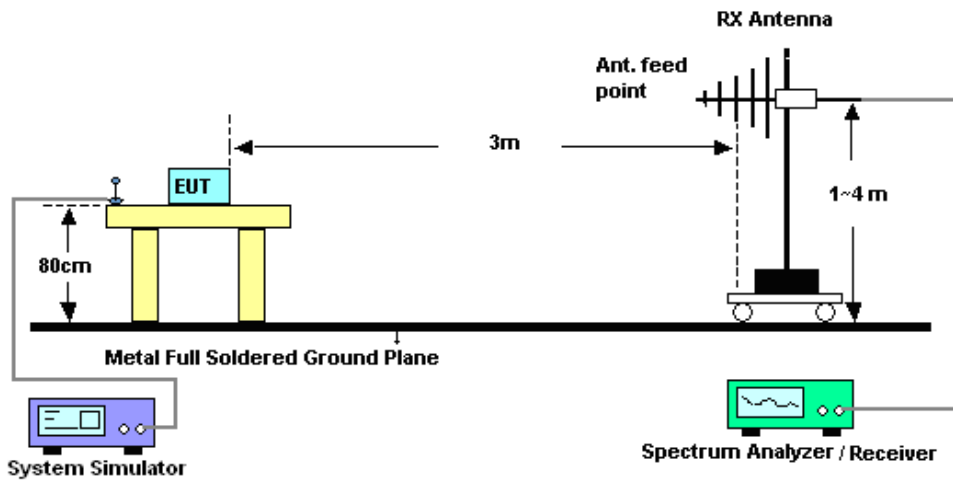

For radiated emissions above 1GHz

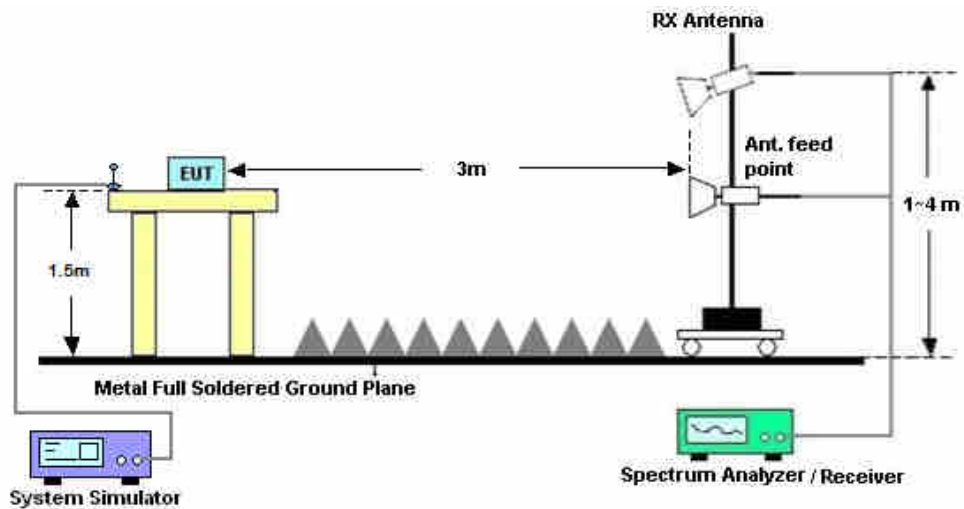



3.8.5 Test Results of Radiated Spurious Emissions (9 kHz ~ 30 MHz)

The low frequency, which started from 9 kHz to 30MHz, was pre-scanned and the result which was 20dB lower than the limit line was not reported.

There is a comparison data of both open-field test site and semi-Anechoic chamber, and the result came out very similar.

3.8.6 Test Result of Radiated Spurious at Band Edges

Please refer to Appendix C.

3.8.7 Test Result of Radiated Spurious Emission (30MHz ~ 10th Harmonic)

Please refer to Appendix C.

3.8.8 Duty cycle correction factor for average measurement

Please refer to Appendix D.

3.9 AC Conducted Emission Measurement

3.9.1 Limit of AC Conducted Emission

For equipment that is designed to be connected to the public utility (AC) power line, the radio frequency voltage that is conducted back onto the AC power line on any frequency or frequencies within the band 150 kHz to 30 MHz shall not exceed the limits in the following table.

| Frequency of emission (MHz) | Conducted limit (dB μ V) | |
|-----------------------------|------------------------------|-----------|
| | Quasi-peak | Average |
| 0.15-0.5 | 66 to 56* | 56 to 46* |
| 0.5-5 | 56 | 46 |
| 5-30 | 60 | 50 |

*Decreases with the logarithm of the frequency.

3.9.2 Measuring Instruments

The measuring equipment is listed in the section 4 of this test report.

3.9.3 Test Procedures

1. The EUT was placed 0.4 meter from the conducting wall of the shielding room was kept at least 80 centimeters from any other grounded conducting surface.
2. Connect EUT to the power mains through a line impedance stabilization network (LISN).
3. All the support units are connecting to the other LISN.
4. The LISN provides 50 ohm coupling impedance for the measuring instrument.
5. The FCC states that a 50 ohm, 50 microhenry LISN should be used.
6. Both sides of AC line were checked for maximum conducted interference.
7. The frequency range from 150 kHz to 30 MHz was searched.
8. Set the test-receiver system to Peak Detect Function and specified bandwidth (IF Bandwidth = 9kHz) with Maximum Hold Mode. Then measurement is also conducted by Average Detector and Quasi-Peak Detector Function respectively.

3.9.4 Test Setup

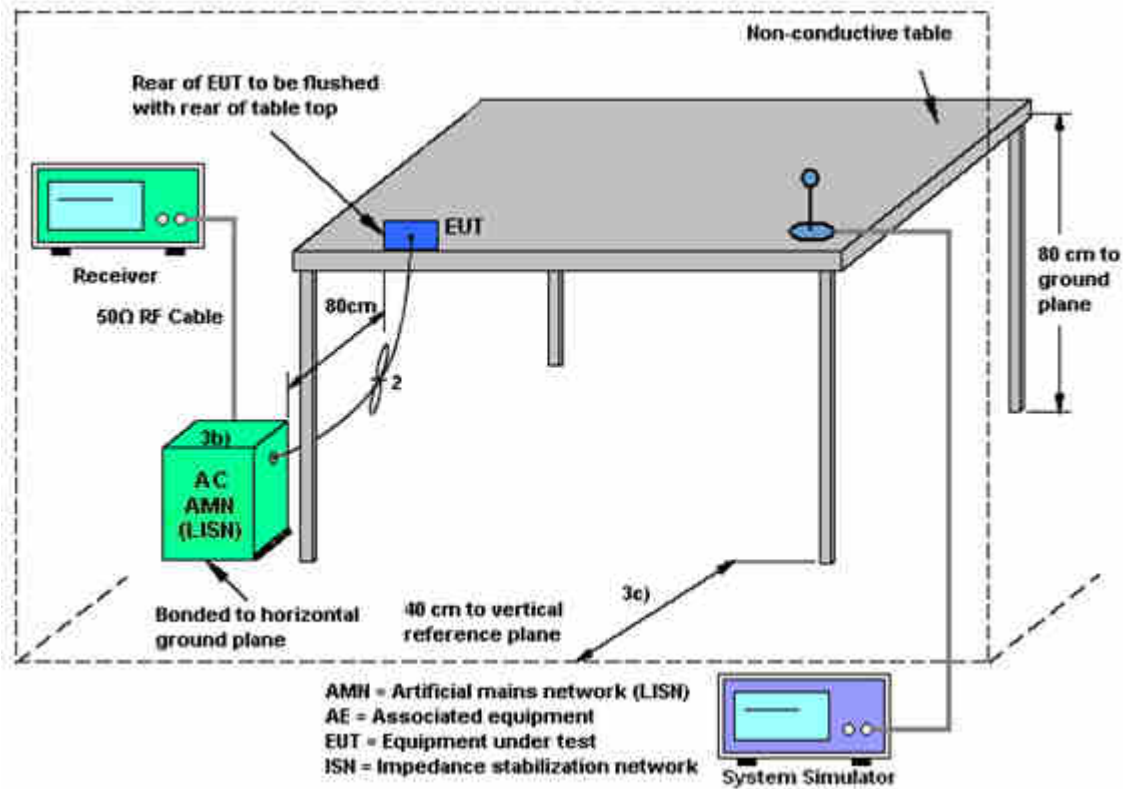

3.9.5 Test Result of AC Conducted Emission

Please refer to Appendix B.



3.10 Antenna Requirements

3.10.1 Standard Applicable

If directional gain of transmitting antennas is greater than 6dBi, the power shall be reduced by the same level in dB comparing to gain minus 6dBi. The use of a permanently attached antenna or of an antenna that uses a unique coupling to the intentional radiator shall be considered sufficient to comply with the rule.

3.10.2 Antenna Anti-Replacement Construction

An embedded-in antenna design is used.

3.10.3 Antenna Gain

The antenna peak gain of EUT is less than 6 dBi. Therefore, it is not necessary to reduce maximum peak output power limit.



4 List of Measuring Equipment

| Instrument | Manufacturer | Model No. | Serial No. | Characteristics | Calibration Date | Test Date | Due Date | Remark |
|-----------------------------------|--------------|-------------------------|-------------|-------------------------|------------------|---------------|---------------|-----------------------|
| Spectrum Analyzer | R&S | FSV30 | 101338 | 10Hz~30GHz | Apr. 16, 2019 | Nov. 19, 2019 | Apr. 15, 2020 | Conducted (TH01-KS) |
| Pulse Power Sensor | Anritsu | MA2411B | 0917070 | 300MHz~40GHz | Jan. 14, 2019 | Nov. 19, 2019 | Jan. 13, 2020 | Conducted (TH01-KS) |
| Power Meter | Anritsu | ML2495A | 1005002 | 50MHz Bandwidth | Jan. 14, 2019 | Nov. 19, 2019 | Jan. 13, 2020 | Conducted (TH01-KS) |
| EMI Receiver | R&S | ESCI7 | 100768 | 9kHz~7GHz; | Apr. 16, 2019 | Oct. 30, 2019 | Apr. 15, 2020 | Conduction (CO01-KS) |
| AC LISN | MessTec | AN3016 | 060103 | 9kHz~30MHz | Oct. 11, 2019 | Oct. 30, 2019 | Oct. 10, 2020 | Conduction (CO01-KS) |
| AC LISN (for auxiliary equipment) | MessTec | AN3016 | 060105 | 9kHz~30MHz | Nov. 19, 2018 | Oct. 30, 2019 | Nov. 18, 2019 | Conduction (CO01-KS) |
| AC Power Source | Chroma | 61602 | ABP00000811 | AC 0V~300V, 45Hz~1000Hz | Oct. 11, 2019 | Oct. 30, 2019 | Oct. 10, 2020 | Conduction (CO01-KS) |
| EMI Test Receiver | Keysight | N9038A | MY57290157 | 3Hz~8.5GHz; Max 30dBm | Jul. 18, 2019 | Nov. 20, 2019 | Jul. 17, 2020 | Radiation (03CH06-KS) |
| EXA Spectrum Analyzer | Keysight | N9010A | MY55150208 | 10Hz~44GHz | Apr. 16, 2019 | Nov. 20, 2019 | Apr. 18, 2020 | Radiation (03CH06-KS) |
| Loop Antenna | R&S | HFH2-Z2 | 100321 | 9kHz~30MHz | Oct. 18, 2019 | Nov. 20, 2019 | Oct. 17, 2020 | Radiation (03CH06-KS) |
| Bilog Antenna | TeseQ | CBL6111D | 44483 | 30MHz~1GHz | Dec. 28, 2018 | Nov. 20, 2019 | Dec. 27, 2019 | Radiation (03CH06-KS) |
| Double Ridge Horn Antenna | ETS-Lindgren | 3117 | 75959 | 1GHz~18GHz | Jan. 27, 2019 | Nov. 20, 2019 | Jan. 26, 2020 | Radiation (03CH06-KS) |
| SHF-EHF Horn | Com-power | AH-840 | 101070 | 18GHz~40GHz | Jan. 05, 2019 | Nov. 20, 2019 | Jan. 04, 2020 | Radiation (03CH06-KS) |
| Amplifier | SONOMA | 310N | 187289 | 9KHz ~1GHZ | Aug. 06, 2019 | Nov. 20, 2019 | Aug. 05, 2020 | Radiation (03CH06-KS) |
| high gain Amplifier | MITEQ | AMF-7D-0010 1800-30-10P | 2025788 | 1Ghz-18Ghz | Aug. 16, 2019 | Nov. 20, 2019 | Aug. 15, 2020 | Radiation (03CH06-KS) |
| Amplifier | Keysight | 83017A | MY53270203 | 500MHz~26.5GHz | Apr. 15, 2019 | Nov. 20, 2019 | Apr. 14, 2020 | Radiation (03CH06-KS) |
| Amplifier | MITEQ | TTA1840-35-HG | 2014749 | 18~40GHz | Jan. 14, 2019 | Nov. 20, 2019 | Jan. 13, 2020 | Radiation (03CH06-KS) |
| AC Power Source | Chroma | 61601 | F104090004 | N/A | NCR | Nov. 20, 2019 | NCR | Radiation (03CH06-KS) |
| Turn Table | ChamPro | EM 1000-T | 060762-T | 0~360 degree | NCR | Nov. 20, 2019 | NCR | Radiation (03CH06-KS) |
| Antenna Mast | ChamPro | EM 1000-A | 060762-A | 1 m~4 m | NCR | Nov. 20, 2019 | NCR | Radiation (03CH06-KS) |

NCR: No Calibration Required



5 Uncertainty of Evaluation

The measurement uncertainties shown below were calculated in accordance with the requirements of ANSI 63.10-2013. All the measurement uncertainty value were shown with a coverage K=2 to indicate 95% level of confidence. The measurement data show herein meets or exceeds the CISPR measurement uncertainty values specified in CISPR 16-4-2 and can be compared directly to specified limit to determine compliance.

Uncertainty of Conducted Emission Measurement (150 kHz ~ 30 MHz)

| | |
|---------------------------------------------------------------------|-------|
| Measuring Uncertainty for a Level of Confidence of 95% (U = 2Uc(y)) | 2.9dB |
|---------------------------------------------------------------------|-------|

Uncertainty of Radiated Emission Measurement (30 MHz ~ 1000 MHz)

| | |
|---------------------------------------------------------------------|-------|
| Measuring Uncertainty for a Level of Confidence of 95% (U = 2Uc(y)) | 5.0dB |
|---------------------------------------------------------------------|-------|

Uncertainty of Radiated Emission Measurement (1000 MHz ~ 18000 MHz)

| | |
|---------------------------------------------------------------------|-------|
| Measuring Uncertainty for a Level of Confidence of 95% (U = 2Uc(y)) | 5.0dB |
|---------------------------------------------------------------------|-------|

Uncertainty of Radiated Emission Measurement (18000 MHz ~ 40000 MHz)

| | |
|---------------------------------------------------------------------|-------|
| Measuring Uncertainty for a Level of Confidence of 95% (U = 2Uc(y)) | 5.0dB |
|---------------------------------------------------------------------|-------|



Appendix A. Conducted Test Results

Bluetooth

| | | | | |
|----------------|------------|--------------------|-------|----|
| Test Engineer: | Aly Cao | Temperature: | 20~26 | °C |
| Test Date: | 2019/11/19 | Relative Humidity: | 40~51 | % |

TEST RESULTS DATA**20dB and 99% Occupied Bandwidth and Hopping Channel Separation**

| Mod. | Data Rate | NTX | CH. | Freq. (MHz) | 20db BW (MHz) | 99% Bandwidth (MHz) | Hopping Channel Separation Measurement (kHz) | Hopping Channel Separation Measurement Limit (MHz) | Pass/Fail |
|------|-----------|-----|-----|-------------|---------------|---------------------|----------------------------------------------|----------------------------------------------------|-----------|
| DH | 1Mbps | 1 | 0 | 2402 | 0.941 | 0.854 | 998.600 | 0.6271 | Pass |
| DH | 1Mbps | 1 | 39 | 2441 | 0.915 | 0.842 | 1007.200 | 0.6097 | Pass |
| DH | 1Mbps | 1 | 78 | 2480 | 0.894 | 0.842 | 1007.200 | 0.5963 | Pass |
| 2DH | 2Mbps | 1 | 0 | 2402 | 1.255 | 1.161 | 1063.700 | 0.8365 | Pass |
| 2DH | 2Mbps | 1 | 39 | 2441 | 1.255 | 1.161 | 1150.500 | 0.8365 | Pass |
| 2DH | 2Mbps | 1 | 78 | 2480 | 1.250 | 1.164 | 1020.300 | 0.8336 | Pass |
| 3DH | 3Mbps | 1 | 0 | 2402 | 1.224 | 1.149 | 1159.200 | 0.8162 | Pass |
| 3DH | 3Mbps | 1 | 39 | 2441 | 1.224 | 1.143 | 981.200 | 0.8162 | Pass |
| 3DH | 3Mbps | 1 | 78 | 2480 | 1.229 | 1.149 | 1150.500 | 0.8191 | Pass |

TEST RESULTS DATA**Dwell Time**

| Mod. | Hopping Channel Number Rate | Hops Over Occupancy Time(hops) | Package Transfer Time (msec) (MHz) | Dwell Time (sec) | Limits (sec) | Pass/Fail |
|-------|-----------------------------|--------------------------------|------------------------------------|------------------|--------------|-----------|
| Nomal | 79 | 106.67 | 2.9014 | 0.31 | 0.4 | Pass |
| AFH | 20 | 53.33 | 2.9014 | 0.15 | 0.4 | Pass |

TEST RESULTS DATA**Peak Power Table**

| DH | CH. | NTX | Peak Power (dBm) | Power Limit (dBm) | Test Result |
|------|-----|-----|------------------|-------------------|-------------|
| DH1 | 0 | 1 | 7.80 | 20.97 | Pass |
| | 39 | 1 | 7.22 | 20.97 | Pass |
| | 78 | 1 | 7.83 | 20.97 | Pass |
| 2DH | CH. | NTX | Peak Power (dBm) | Power Limit (dBm) | Test Result |
| 2DH1 | 0 | 1 | 7.13 | 20.97 | Pass |
| | 39 | 1 | 6.43 | 20.97 | Pass |
| | 78 | 1 | 7.22 | 20.97 | Pass |
| 3DH | CH. | NTX | Peak Power (dBm) | Power Limit (dBm) | Test Result |
| 3DH1 | 0 | 1 | 7.49 | 20.97 | Pass |
| | 39 | 1 | 6.89 | 20.97 | Pass |
| | 78 | 1 | 7.56 | 20.97 | Pass |

TEST RESULTS DATA**Number of Hopping Frequency**

| Number of Hopping (Channel) | Adaptive Frequency Hopping (Channel) | Limits (Channel) | Pass/Fail |
|-----------------------------|--------------------------------------|------------------|-----------|
| 79 | 79 | > 15 | Pass |



Appendix B. AC Conducted Emission Test Results

| | | | |
|-----------------|---------------|---------------------|-------------|
| Test Engineer : | Amos Zhang | Temperature : | 25.3~26.2°C |
| | | Relative Humidity : | 38~40% |
| Test Voltage : | 120Vac / 60Hz | Phase : | Line |

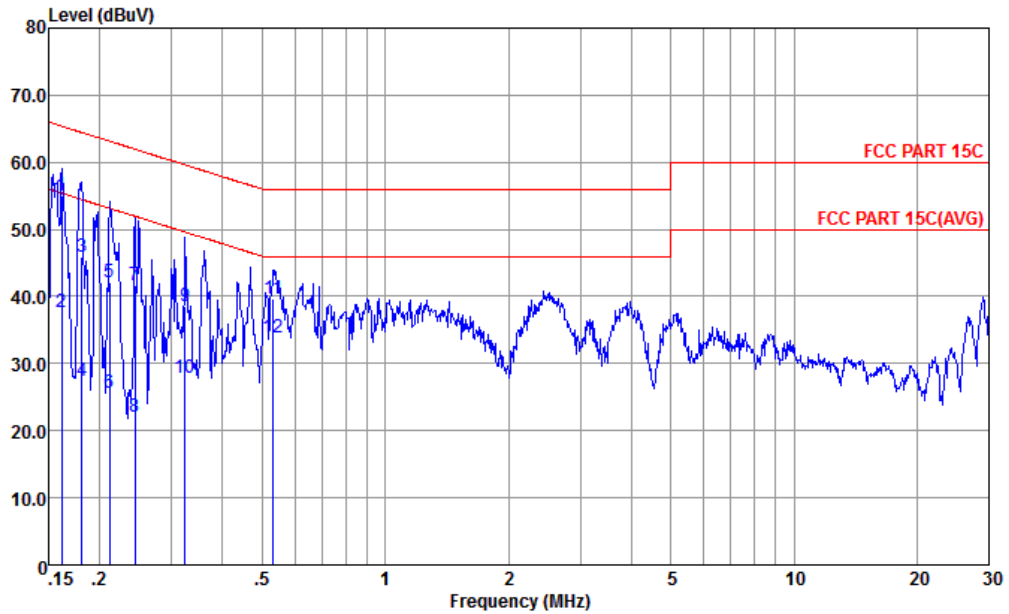

Site : CO01-KS
 Condition : FCC PART 15C LISN-L-181119-060105 LINE

| | Freq | Level | Over | Limit | Read | LISN | Cable | Remark |
|-----|-------|-------|--------|-------|-------|--------|-------|---------|
| | MHz | dBuV | Limit | Line | Level | Factor | Loss | |
| | | | dB | dBuV | dBuV | dB | dB | |
| 1 * | 0.162 | 55.15 | -10.23 | 65.38 | 44.60 | 0.10 | 10.45 | QP |
| 2 | 0.162 | 37.75 | -17.63 | 55.38 | 27.20 | 0.10 | 10.45 | Average |
| 3 | 0.181 | 46.01 | -18.45 | 64.46 | 35.50 | 0.11 | 10.40 | QP |
| 4 | 0.181 | 27.41 | -27.05 | 54.46 | 16.90 | 0.11 | 10.40 | Average |
| 5 | 0.212 | 42.08 | -21.06 | 63.14 | 31.60 | 0.12 | 10.36 | QP |
| 6 | 0.212 | 25.58 | -27.56 | 53.14 | 15.10 | 0.12 | 10.36 | Average |
| 7 | 0.244 | 41.67 | -20.28 | 61.95 | 31.20 | 0.13 | 10.34 | QP |
| 8 | 0.244 | 22.07 | -29.88 | 51.95 | 11.60 | 0.13 | 10.34 | Average |
| 9 | 0.323 | 38.64 | -20.98 | 59.62 | 28.19 | 0.15 | 10.30 | QP |
| 10 | 0.323 | 27.94 | -21.68 | 49.62 | 17.49 | 0.15 | 10.30 | Average |
| 11 | 0.532 | 39.61 | -16.39 | 56.00 | 29.20 | 0.17 | 10.24 | QP |
| 12 | 0.532 | 33.91 | -12.09 | 46.00 | 23.50 | 0.17 | 10.24 | Average |



| | | | |
|-----------------|---------------|---------------------|-------------|
| Test Engineer : | Amos Zhang | Temperature : | 25.3~26.2°C |
| | | Relative Humidity : | 38~40% |
| Test Voltage : | 120Vac / 60Hz | Phase : | Neutral |

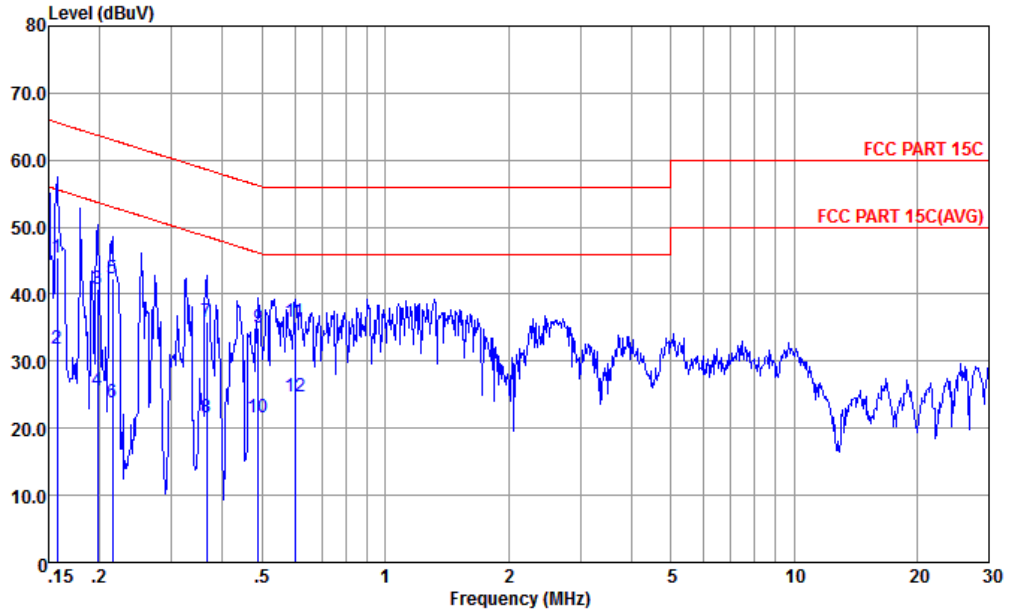

Site : CO01-KS
 Condition : FCC PART 15C LISN-N-181119-060105 NEUTRAL

| | Freq | Level | Over | Limit | Read | LISN | Cable | |
|-----|-------|-------|--------|-------|-------|--------|-------|---------|
| | MHz | dBuV | Limit | Line | Level | Factor | Loss | Remark |
| | | | dB | dBuV | dBuV | dB | dB | |
| 1 * | 0.157 | 45.54 | -20.06 | 65.60 | 34.90 | 0.18 | 10.46 | QP |
| 2 | 0.157 | 31.84 | -23.76 | 55.60 | 21.20 | 0.18 | 10.46 | Average |
| 3 | 0.198 | 40.74 | -22.97 | 63.71 | 30.20 | 0.17 | 10.37 | QP |
| 4 | 0.198 | 25.64 | -28.07 | 53.71 | 15.10 | 0.17 | 10.37 | Average |
| 5 | 0.215 | 42.43 | -20.58 | 63.01 | 31.91 | 0.17 | 10.35 | QP |
| 6 | 0.215 | 23.83 | -29.18 | 53.01 | 13.31 | 0.17 | 10.35 | Average |
| 7 | 0.365 | 35.94 | -22.67 | 58.61 | 25.50 | 0.16 | 10.28 | QP |
| 8 | 0.365 | 21.64 | -26.97 | 48.61 | 11.20 | 0.16 | 10.28 | Average |
| 9 | 0.489 | 34.89 | -21.30 | 56.19 | 24.50 | 0.15 | 10.24 | QP |
| 10 | 0.489 | 21.69 | -24.50 | 46.19 | 11.30 | 0.15 | 10.24 | Average |
| 11 | 0.601 | 35.88 | -20.12 | 56.00 | 25.50 | 0.14 | 10.24 | QP |
| 12 | 0.601 | 24.68 | -21.32 | 46.00 | 14.30 | 0.14 | 10.24 | Average |

Note:

- Level(dBμV) = Read Level(dBμV) + LISN Factor(dB) + Cable Loss(dB)
- Over Limit(dB) = Level(dBμV) – Limit Line(dBμV)



Appendix C. Radiated Spurious Emission

2.4GHz 2400~2483.5MHz

BT (Band Edge @ 3m)

| BT | Note | Frequency | Level | Over Limit | Limit Line | Read Level | Antenna Factor | Cable Loss | Preamp Factor | Ant Pos | Table Pos | Peak Avg. | Pol. |
|------------------------|---------------------------------------------------------------------------------------------|-----------|------------|------------|------------|------------|----------------|------------|---------------|---------|-----------|-----------|---------|
| | | (MHz) | (dBμV/m) | (dB) | (dBμV/m) | (dBμV) | (dB/m) | (dB) | (dB) | (cm) | (deg) | (P/A) | (H/V) |
| BT CH00 2402MHz | | 2355.63 | 55.78 | -18.22 | 74 | 47.89 | 32.07 | 7.25 | 31.43 | 208 | 336 | P | H |
| | | 2355.63 | 30.99 | -23.01 | 54 | - | - | - | - | - | - | A | H |
| | * | 2402 | 103.24 | - | - | 95.35 | 32 | 7.3 | 31.41 | 208 | 336 | P | H |
| | * | 2402 | 78.45 | - | - | - | - | - | - | - | - | A | H |
| | | 2389.17 | 55.4 | -18.6 | 74 | 47.52 | 32 | 7.3 | 31.42 | 400 | 51 | P | V |
| | | 2389.17 | 30.61 | -23.39 | 54 | - | - | - | - | - | - | A | V |
| | * | 2402 | 99.49 | - | - | 91.6 | 32 | 7.3 | 31.41 | 400 | 51 | P | V |
| | * | 2402 | 74.7 | - | - | - | - | - | - | - | - | A | V |
| BT CH 78 2480MHz | | 2483.62 | 58.28 | -15.72 | 74 | 49.92 | 32.27 | 7.48 | 31.39 | 161 | 314 | P | H |
| | | 2483.62 | 33.49 | -20.51 | 54 | - | - | - | - | - | - | A | H |
| | * | 2480 | 104.22 | - | - | 95.86 | 32.27 | 7.48 | 31.39 | 161 | 314 | P | H |
| | * | 2480 | 79.43 | - | - | - | - | - | - | - | - | A | H |
| | | 2483.68 | 56.41 | -17.59 | 74 | 48.05 | 32.27 | 7.48 | 31.39 | 373 | 56 | P | V |
| | | 2483.68 | 31.62 | -22.38 | 54 | - | - | - | - | - | - | A | V |
| | * | 2480 | 100.26 | - | - | 91.9 | 32.27 | 7.48 | 31.39 | 373 | 56 | P | V |
| | * | 2480 | 75.47 | - | - | - | - | - | - | - | - | A | V |
| Remark | 1. No other spurious found. 2. All results are PASS against Peak and Average limit line. | | | | | | | | | | | | |



2.4GHz 2400~2483.5MHz

BT (Harmonic @ 3m)

| BT | Note | Frequency (MHz) | Level (dBμV/m) | Over Limit (dB) | Limit Line (dBμV/m) | Read Level (dBμV) | Antenna Factor (dB/m) | Cable Loss (dB) | Preamp Factor (dB) | Ant Pos (cm) | Table Pos (deg) | Peak Avg. (P/A) | Pol. (H/V) |
|------------------------|---------------------------------------------------------------------------------------------|----------------------|---------------------|-------------------------|-----------------------------|---------------------------|-------------------------------|-------------------------|----------------------------|----------------------|-------------------------|-------------------------|-----------------|
| BT CH 00 2402MHz | | 4806 | 39.19 | -34.81 | 74 | 58.26 | 34.2 | 10.49 | 63.76 | 100 | 360 | P | H |
| | | 4806 | 39.29 | -34.71 | 74 | 58.36 | 34.2 | 10.49 | 63.76 | 100 | 360 | P | V |
| BT CH 39 2441MHz | | 4884 | 41.32 | -32.68 | 74 | 60.34 | 34.13 | 10.58 | 63.73 | 100 | 360 | P | H |
| | | 7320 | 43.29 | -30.71 | 74 | 57.44 | 36.6 | 13.62 | 64.37 | 100 | 360 | P | H |
| | | 4884 | 40.78 | -33.22 | 74 | 59.8 | 34.13 | 10.58 | 63.73 | 100 | 360 | P | V |
| | | 7320 | 42.4 | -31.6 | 74 | 56.55 | 36.6 | 13.62 | 64.37 | 100 | 360 | P | V |
| BT CH 78 2480MHz | | 4962 | 40.78 | -33.22 | 74 | 59.69 | 34.1 | 10.68 | 63.69 | 100 | 360 | P | H |
| | | 7440 | 41.52 | -32.48 | 74 | 55.92 | 36.4 | 13.58 | 64.38 | 100 | 360 | P | H |
| | | 4962 | 40.85 | -33.15 | 74 | 59.76 | 34.1 | 10.68 | 63.69 | 100 | 360 | P | V |
| | | 7440 | 41.85 | -32.15 | 74 | 56.25 | 36.4 | 13.58 | 64.38 | 100 | 360 | P | V |
| Remark | 1. No other spurious found. 2. All results are PASS against Peak and Average limit line. | | | | | | | | | | | | |



Emission below 1GHz

2.4GHz BT (LF)

| BT | Note | Frequency | Level | Over | Limit | Read | Antenna | Cable | Preamp | Ant | Table | Peak | Pol. |
|--------------------|------------------------------------------------------------------------------------------------------------------------------|-----------|------------|--------|------------|----------|----------|--------|--------|--------|---------|---------|---------|
| | | (MHz) | (dBμV/m) | (dB) | (dBμV/m) | (dBμV) | (dB/m) | (dB) | (dB) | (cm) | (deg) | (P/A) | (H/V) |
| 2.4GHz BT LF | | 51.34 | 21.15 | -18.85 | 40 | 39.16 | 13.76 | 0.73 | 32.5 | - | - | P | H |
| | | 118.27 | 30.28 | -13.22 | 43.5 | 43.25 | 18.08 | 1.11 | 32.16 | 100 | 0 | P | H |
| | | 218.18 | 21.77 | -24.23 | 46 | 36.76 | 15.33 | 1.61 | 31.93 | - | - | P | H |
| | | 306.45 | 18.03 | -27.97 | 46 | 28.68 | 19.37 | 1.85 | 31.87 | - | - | P | H |
| | | 504.33 | 23.27 | -22.73 | 46 | 28.95 | 23.54 | 2.39 | 31.61 | - | - | P | H |
| | | 872.93 | 26.62 | -19.38 | 46 | 28.71 | 26.39 | 3.17 | 31.65 | - | - | P | H |
| | | 47.46 | 23.99 | -16.01 | 40 | 40.67 | 15.1 | 0.67 | 32.45 | - | - | P | V |
| | | 115.36 | 27.24 | -16.26 | 43.5 | 40.43 | 17.89 | 1.09 | 32.17 | - | - | P | V |
| | | 196.84 | 26.92 | -16.58 | 43.5 | 41.85 | 15.56 | 1.52 | 32.01 | - | - | P | V |
| | | 221.09 | 30.11 | -15.89 | 46 | 45.01 | 15.4 | 1.62 | 31.92 | 100 | 360 | P | V |
| | | 257.95 | 28.53 | -17.47 | 46 | 39.03 | 19.57 | 1.75 | 31.82 | - | - | P | V |
| | 430.61 | 21.73 | -24.27 | 46 | 29.03 | 22.25 | 2.19 | 31.74 | - | - | P | V | |
| Remark | <ol style="list-style-type: none"> No other spurious found. All results are PASS against limit line. | | | | | | | | | | | | |



Note symbol

| | |
|-----|----------------------------------------------------------------------------------------------------------------------------------------------------------|
| * | Fundamental Frequency which can be ignored. However, the level of any unwanted emissions shall not exceed the level of the fundamental frequency. |
| ! | Test result is over limit line. |
| P/A | Peak or Average |
| H/V | Horizontal or Vertical |



A calculation example for radiated spurious emission is shown as below:

| WIFI | Note | Frequency | Level | Over | Limit | Read | Antenna | Cable | Preamp | Ant | Table | Peak | Pol. |
|---------|------|-----------|------------|--------|------------|----------|----------|--------|--------|--------|---------|---------|---------|
| Ant. | | | | Limit | Line | Level | Factor | Loss | Factor | Pos | Pos | Avg. | |
| 1+2 | | (MHz) | (dBμV/m) | (dB) | (dBμV/m) | (dBμV) | (dB/m) | (dB) | (dB) | (cm) | (deg) | (P/A) | (H/V) |
| 802.11b | | 2390 | 55.45 | -18.55 | 74 | 54.51 | 32.22 | 4.58 | 35.86 | 103 | 308 | P | H |
| CH 01 | | | | | | | | | | | | | |
| 2412MHz | | 2390 | 43.54 | -10.46 | 54 | 42.6 | 32.22 | 4.58 | 35.86 | 103 | 308 | A | H |

- Level(dBμV/m) =
Antenna Factor(dB/m) + Cable Loss(dB) + Read Level(dBμV) - Preamp Factor(dB)
- Over Limit(dB) = Level(dBμV/m) – Limit Line(dBμV/m)

For Peak Limit @ 2390MHz:

- Level(dBμV/m)
= Antenna Factor(dB/m) + Cable Loss(dB) + Read Level(dBμV) - Preamp Factor(dB)
= 32.22(dB/m) + 4.58(dB) + 54.51(dBμV) – 35.86 (dB)
= 55.45 (dBμV/m)
- Over Limit(dB)
= Level(dBμV/m) – Limit Line(dBμV/m)
= 55.45(dBμV/m) – 74(dBμV/m)
= -18.55(dB)

For Average Limit @ 2390MHz:

- Level(dBμV/m)
= Antenna Factor(dB/m) + Cable Loss(dB) + Read Level(dBμV) - Preamp Factor(dB)
= 32.22(dB/m) + 4.58(dB) + 42.6(dBμV) – 35.86 (dB)
= 43.54 (dBμV/m)
- Over Limit(dB)
= Level(dBμV/m) – Limit Line(dBμV/m)
= 43.54(dBμV/m) – 54(dBμV/m)
= -10.46(dB)

Both peak and average measured complies with the limit line, so test result is “PASS”.



Appendix D. Duty Cycle Plots

DH5 on time (One Pulse) Plot on Channel 00

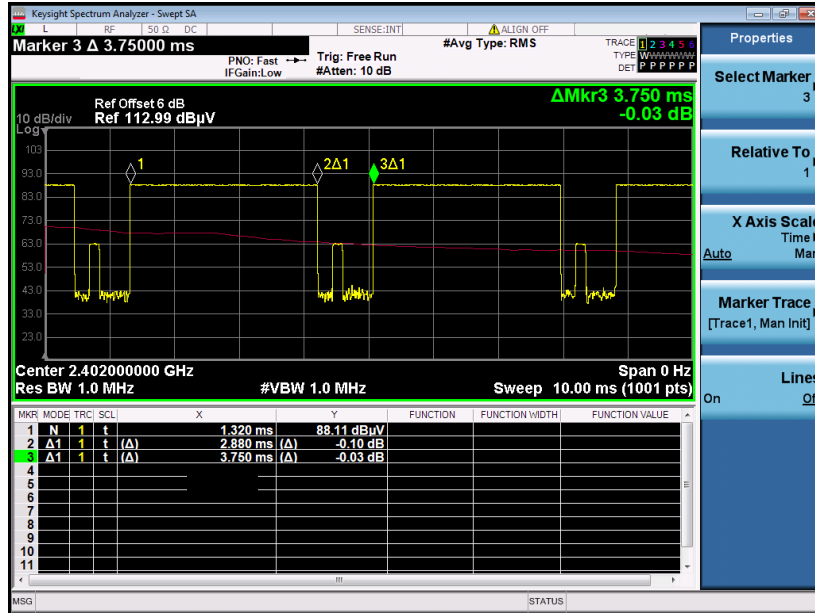

DH5 on time (Count Pulses) Plot on Channel 00

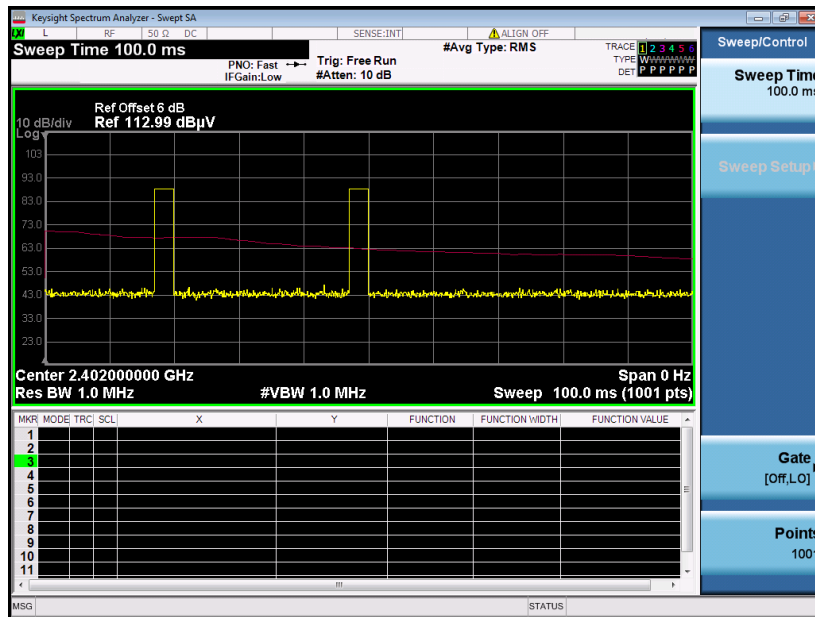

Note:

1. Worst case Duty cycle = on time/100 milliseconds = 2 * 2.88 / 100 = 5.76 %
2. Worst case Duty cycle correction factor = 20*log(Duty cycle) = -24.79 dB
3. DH5 has the highest duty cycle worst case and is reported.