



# FCC RF Test Report

**APPLICANT** : Motorola Mobility LLC  
**EQUIPMENT** : Mobile Cellular Phone  
**BRAND NAME** : Motorola  
**MODEL NAME** : XT2043-4, XT2043-5, XT2043-6  
**FCC ID** : IHDT56YN1  
**STANDARD** : FCC Part 15 Subpart C §15.247  
**CLASSIFICATION** : (DTS) Digital Transmission System

The product was received on Oct. 09, 2019 and testing was completed on Nov. 20, 2019. We, Sporton International (Kunshan) Inc., would like to declare that the tested sample has been evaluated in accordance with the test procedures and has been in compliance with the applicable technical standards.

The test results in this report apply exclusively to the tested model / sample. Without written approval of Sporton International (Kunshan) Inc., the test report shall not be reproduced except in full.

*Jason Jia*

Reviewed by: Jason Jia / Supervisor

*James Huang*

Approved by: James Huang / Manager



**Sporton International (Kunshan) Inc.**

**No. 1098, Pengxi North Road, Kunshan Economic Development Zone Jiangsu Province 215300  
People's Republic of China**



# TABLE OF CONTENTS

**REVISION HISTORY..... 3**

**SUMMARY OF TEST RESULT ..... 4**

**1 GENERAL DESCRIPTION..... 5**

    1.1 Applicant ..... 5

    1.2 Manufacturer ..... 5

    1.3 Product Feature of Equipment Under Test..... 5

    1.4 Product Specification of Equipment Under Test..... 6

    1.5 Specification of Accessory ..... 6

    1.6 Modification of EUT ..... 6

    1.7 Testing Location ..... 7

    1.8 Test Software..... 7

    1.9 Applicable Standards..... 7

**2 TEST CONFIGURATION OF EQUIPMENT UNDER TEST..... 8**

    2.1 Carrier Frequency Channel ..... 8

    2.2 Test Mode..... 9

    2.3 Connection Diagram of Test System..... 10

    2.4 Support Unit used in test configuration and system ..... 11

    2.5 EUT Operation Test Setup ..... 11

    2.6 Measurement Results Explanation Example..... 11

**3 TEST RESULT ..... 12**

    3.1 6dB and 99% Bandwidth Measurement ..... 12

    3.2 Output Power Measurement..... 19

    3.3 Power Spectral Density Measurement ..... 20

    3.4 Conducted Band Edges and Spurious Emission Measurement ..... 27

    3.5 Radiated Band Edges and Spurious Emission Measurement ..... 36

    3.6 AC Conducted Emission Measurement..... 40

    3.7 Antenna Requirements ..... 42

**4 LIST OF MEASURING EQUIPMENT..... 43**

**5 UNCERTAINTY OF EVALUATION..... 44**

**APPENDIX A. CONDUCTED TEST RESULTS**

**APPENDIX B. AC CONDUCTED EMISSION TEST RESULT**

**APPENDIX C. RADIATED SPURIOUS EMISSION**

**APPENDIX D. DUTY CYCLE PLOTS**

**APPENDIX E. SETUP PHOTOGRAPHS**





### SUMMARY OF TEST RESULT

Report Section	FCC Rule	Description	Limit	Result	Remark
3.1	15.247(a)(2)	6dB Bandwidth	≥ 0.5MHz	Pass	-
3.1	-	99% Bandwidth	-	Pass	-
3.2	15.247(b)(3)	Peak Output Power	≤ 30dBm	Pass	-
3.3	15.247(e)	Power Spectral Density	≤ 8dBm/3kHz	Pass	-
3.4	15.247(d)	Conducted Band Edges and Spurious Emission	≤ 20dBc	Pass	-
3.5	15.247(d)	Radiated Band Edges and Spurious Emission	15.209(a) & 15.247(d)	Pass	Under limit 6.51 dB at 2483.500 MHz
3.6	15.207	AC Conducted Emission	15.207(a)	Pass	Under limit 10.23 dB at 0.162 MHz
3.7	15.203 & 15.247(b)	Antenna Requirement	N/A	Pass	-

<b>Declaration of Conformity:</b>
The test results with all measurement uncertainty excluded are presented in accordance with the regulation limits or requirements declared by manufacturers.
<b>Comments and Explanations:</b>
The declared of product specification for EUT presented in the report are provided by the manufacturer, and the manufacturer takes all the responsibilities for the accuracy of product specification.



# 1 General Description

## 1.1 Applicant

Motorola Mobility LLC  
222 W, Merchandise Mart Plaza, Chicago IL 60654 USA

## 1.2 Manufacturer

Motorola Mobility LLC  
222 W, Merchandise Mart Plaza, Chicago IL 60654 USA

## 1.3 Product Feature of Equipment Under Test

Product Feature	
Equipment	Mobile Cellular Phone
Brand Name	Motorola
Model Name	XT2043-4, XT2043-5, XT2043-6
FCC ID	IHDT56YN1
EUT supports Radios application	CDMA/EV-DO/GSM/GPRS/EGPRS/WCDMA/HSPA/ DC-HSDPA/HSPA+(16QAM uplink is not supported)/LTE WLAN 2.4GHz 802.11b/g/n HT20 WLAN 5GHz 802.11a/n HT20/HT40 WLAN 5GHz 802.11ac VHT20/VHT40/VHT80 Bluetooth BR/EDR/LE GNSS/FM Receiver
IMEI Code	Conducted: 359084100014845 Conduction: 359084100021188 Radiation: 359084100022632
HW Version	DVT2
SW Version	QPR30.56
EUT Stage	Identical Prototype

**Remark:**

1. The above EUT's information was declared by manufacturer. Please refer to the specifications or user's manual for more detailed description.
2. The different model names are for different market requirement.



### 1.4 Product Specification of Equipment Under Test

Standards-related Product Specification	
<b>Tx/Rx Frequency Range</b>	2402 MHz ~ 2480 MHz
<b>Number of Channels</b>	40
<b>Carrier Frequency of Each Channel</b>	40 Channel(37 hopping + 3 advertising channel)
<b>Maximum Output Power to Antenna</b>	Bluetooth v4.2 LE: 7.74 dBm (0.0059 W) Bluetooth v5.0 LE: 7.90 dBm (0.0062 W)
<b>99% Occupied Bandwidth</b>	Bluetooth v4.2 LE: 1.025MHz Bluetooth v5.0 LE: 2.033MHz
<b>Antenna Type / Gain</b>	Loop Antenna with gain -5.0 dBi
<b>Type of Modulation</b>	Bluetooth LE : GFSK

### 1.5 Specification of Accessory

Specification of Accessory				
AC Adapter 1	<b>Brand Name</b>	Motorola (Acbel)	<b>Model Name</b>	SC-41
	<b>Power Rating</b>	I/P: 100-240 Vac, 300mA ; O/P: 5Vdc, 2000mA		
AC Adapter 2	<b>Brand Name</b>	Motorola (Chenyang)	<b>Model Name</b>	SC-41
	<b>Power Rating</b>	I/P: 100-240 Vac, 300mA ; O/P: 5Vdc, 2000mA		
Battery	<b>Brand Name</b>	Motorola (Amperex)	<b>Model Name</b>	KX50
	<b>Power Rating</b>	3.8Vdc, 4000mAh	<b>Type</b>	Li-ion
USB Cable 1	<b>Brand Name</b>	Motorola (Luxshare)	<b>Model Name</b>	SC18C24368
	<b>Signal Line Type</b>	1.0 meter, shielded cable, without ferrite core		
USB Cable 2	<b>Brand Name</b>	Motorola (Saibao)	<b>Model Name</b>	SC18C24367
	<b>Signal Line Type</b>	1.0 meter, shielded cable, without ferrite core		

### 1.6 Modification of EUT

No modifications are made to the EUT during all test items.



### 1.7 Testing Location

Sporton International (Kunshan) Inc. is accredited to ISO/IEC 17025:2017 by American Association for Laboratory Accreditation with Certificate Number 5145.02.

<b>Test Firm</b>	Sporton International (Kunshan) Inc.		
<b>Test Site Location</b>	No. 1098, Pengxi North Road, Kunshan Economic Development Zone Jiangsu Province 215300 People's Republic of China TEL : +86-512-57900158 FAX : +86-512-57900958		
<b>Test Site No.</b>	<b>Sporton Site No.</b>	<b>FCC Designation No.</b>	<b>FCC Test Firm Registration No.</b>
	CO01-KS 03CH06-KS TH01-KS	CN1257	314309

### 1.8 Test Software

Item	Site	Manufacture	Name	Version
1.	03CH06-KS	AUDIX	E3	6.2009-8-24al
2.	CO01-KS	AUDIX	E3	6.2009-8-24

### 1.9 Applicable Standards

According to the specifications of the manufacturer, the EUT must comply with the requirements of the following standards:

- 47 CFR Part 15 Subpart C §15.247
- FCC KDB 558074 D01 15.247 Meas Guidance v05r02
- ANSI C63.10-2013

**Remark:**

1. All test items were verified and recorded according to the standards and without any deviation during the test.
2. This EUT has also been tested and complied with the requirements of FCC Part 15, Subpart B, recorded in a separate test report.



## 2 Test Configuration of Equipment Under Test

### 2.1 Carrier Frequency Channel

Frequency Band	Channel	Freq. (MHz)	Channel	Freq. (MHz)
2400-2483.5 MHz	0	2402	21	2444
	1	2404	22	2446
	2	2406	23	2448
	3	2408	24	2450
	4	2410	25	2452
	5	2412	26	2454
	6	2414	27	2456
	7	2416	28	2458
	8	2418	29	2460
	9	2420	30	2462
	10	2422	31	2464
	11	2424	32	2466
	12	2426	33	2468
	13	2428	34	2470
	14	2430	35	2472
	15	2432	36	2474
	16	2434	37	2476
	17	2436	38	2478
	18	2438	39	2480
	19	2440	-	-
20	2442	-	-	





## 2.2 Test Mode

- a. The EUT has been associated with peripherals and configuration operated in a manner tended to maximize its emission characteristics in a typical application. Frequency range investigated: conduction emission (150 kHz to 30 MHz), radiation emission (9 kHz to the 10th harmonic of the highest fundamental frequency or to 40 GHz, whichever is lower). For radiated measurement, pre-scanned in three orthogonal panels, X, Y, Z. The worst cases (Y plane) were recorded in this report.
- b. AC power line Conducted Emission was tested under maximum output power.

The following summary table is showing all test modes to demonstrate in compliance with the standard.

Summary table of Test Cases	
Test Item	Data Rate / Modulation
	Bluetooth – LE / GFSK
Conducted TCs	Mode 1: Bluetooth Tx CH00_2402 MHz_1Mbps Mode 2: Bluetooth Tx CH19_2440 MHz_1Mbps Mode 3: Bluetooth Tx CH39_2480 MHz_1Mbps
Radiated TCs	Mode 1: Bluetooth Tx CH00_2402 MHz_1Mbps Mode 2: Bluetooth Tx CH19_2440 MHz_1Mbps Mode 3: Bluetooth Tx CH39_2480 MHz_1Mbps
AC Conducted Emission	Mode 1: GSM 850 Idle + Bluetooth Link + WLAN Link (2.4G) + USB Cable 1(Charging from Adapter 1) + Earphone
<b>Remark:</b> For Radiated Test Cases, The tests were performed with Adapter 1, Earphone and USB Cable 1.	

### 2.3 Connection Diagram of Test System

For Radiation

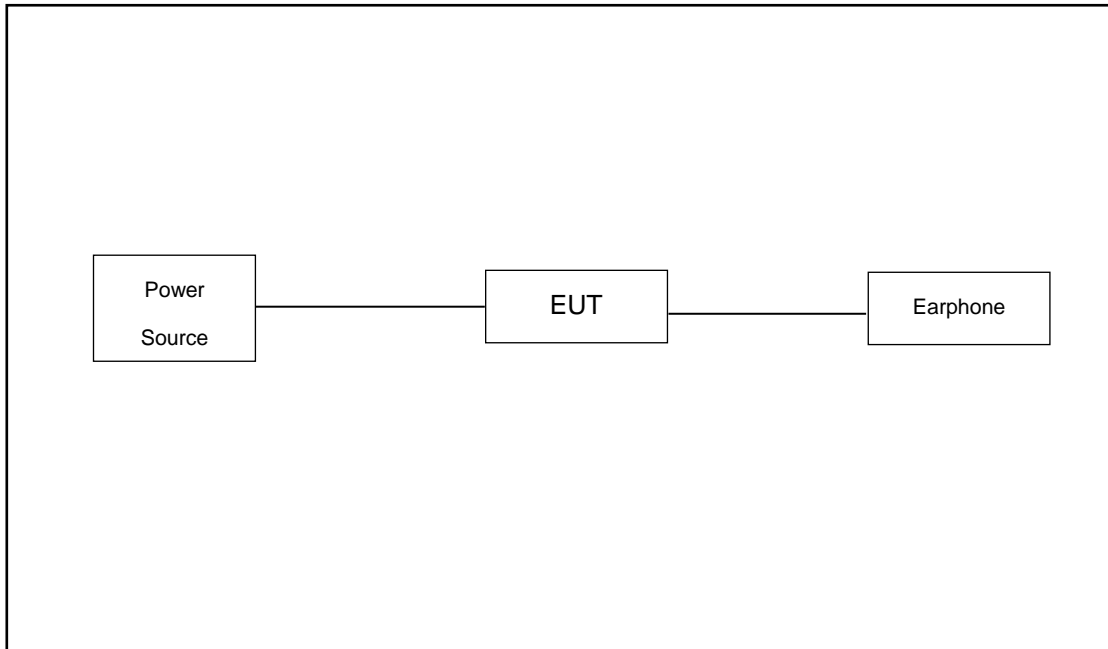

For Conducted Emission

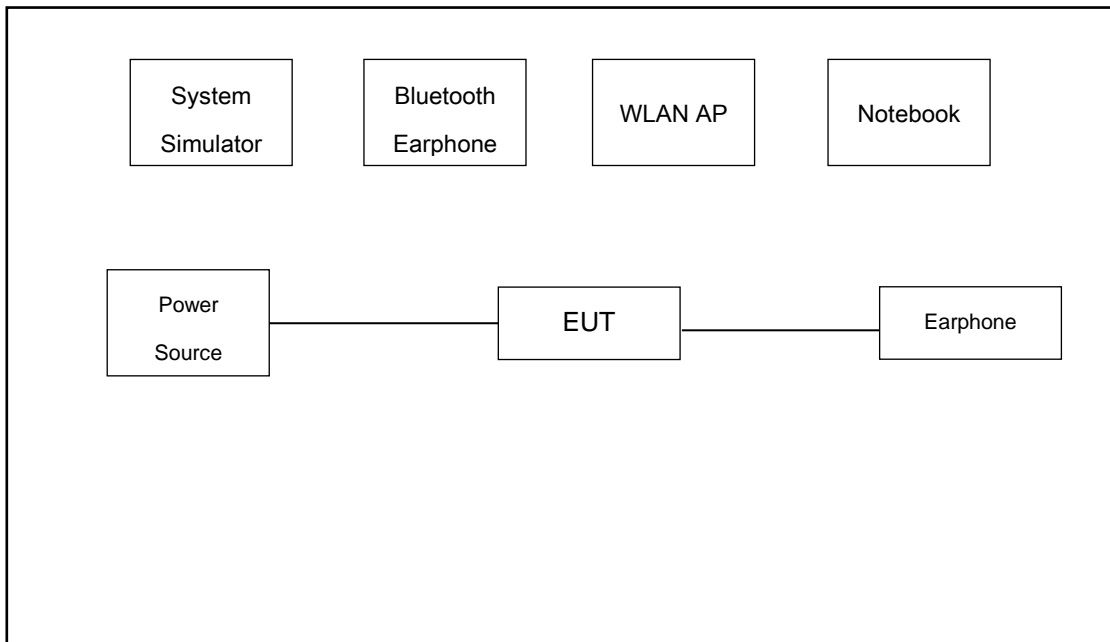

## 2.4 Support Unit used in test configuration and system

Item	Equipment	Trade Name	Model Name	FCC ID	Data Cable	Power Cord
1.	System Simulator	Anritsu	MT8820C	N/A	N/A	Unshielded, 1.8m
2.	WLAN AP	D-link	DIR-655	KA21R655B1	N/A	Unshielded, 1.8m
3.	Bluetooth Earphone	Lenovo	LBH308	N/A	N/A	N/A
4.	Notebook	Lenovo	G480	QDS-BRCM1050I	N/A	AC I/P: Unshielded, 1.8 m DC O/P: Shielded, 1.8 m
5.	Earphone	Lenovo	N/A	N/A	Unshielded,1.2m	N/A

## 2.5 EUT Operation Test Setup

For BLE function, the engineering test program was provided and enabled to make EUT continuous transmit/receive.

For AC power line conducted emissions, the EUT was set to connect with the WLAN AP under large package sizes transmission.

## 2.6 Measurement Results Explanation Example

For all conducted test items:

The offset level is set in the spectrum analyzer to compensate the RF cable loss and attenuator factor between EUT conducted output port and spectrum analyzer. With the offset compensation, the spectrum analyzer reading level is exactly the EUT RF output level.

Example :

The spectrum analyzer offset is derived from RF cable loss

$$\text{Offset} = \text{RF cable loss}$$

Following shows an offset computation example with cable loss 6.2dB.

$$\begin{aligned} \text{Offset(dB)} &= \text{RF cable loss(dB)}. \\ &= 6.2 \text{ (dB)} \end{aligned}$$

### 3 Test Result

#### 3.1 6dB and 99% Bandwidth Measurement

##### 3.1.1 Limit of 6dB and 99% Bandwidth

The minimum 6 dB bandwidth shall be at least 500 kHz.

##### 3.1.2 Measuring Instruments

The section 4.0 of List of Measuring Equipment of this test report is used for test.

##### 3.1.3 Test Procedures

1. The testing follows ANSI C63.10-2013 clause 11.8
2. The RF output of EUT was connected to the spectrum analyzer by RF cable and attenuator. The path loss was compensated to the results for each measurement.
3. Set to the maximum power setting and enable the EUT transmit continuously.
4. Make the measurement with the spectrum analyzer's resolution bandwidth (RBW) = 100 kHz. Set the Video bandwidth (VBW) = 300 kHz. In order to make an accurate measurement. The 6 dB bandwidth must be greater than 500 kHz.
5. For 99% Bandwidth Measurement, the spectrum analyzer's resolution bandwidth (RBW) is set 30kHz and set the Video bandwidth (VBW) = 100kHz.
6. Measure and record the results in the test report.

##### 3.1.4 Test Setup

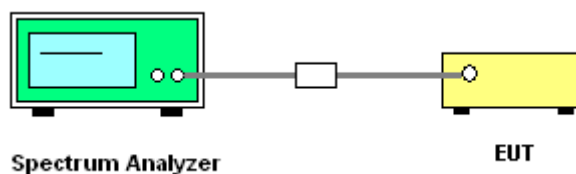



### 3.1.5 Test Result of 6dB Bandwidth

Please refer to Appendix A.

#### Bluetooth v4.2 LE:

#### 6 dB Bandwidth Plot on Channel 00

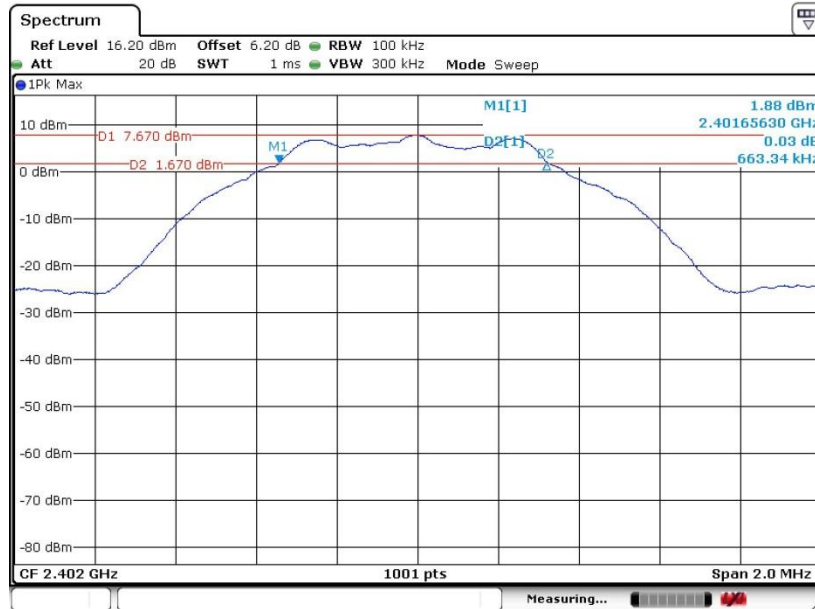

#### 6 dB Bandwidth Plot on Channel 19

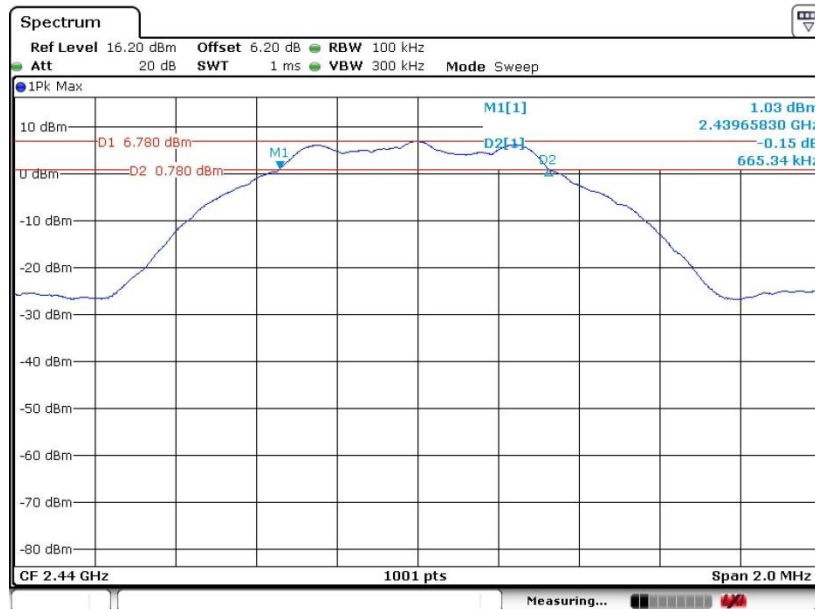



6 dB Bandwidth Plot on Channel 39

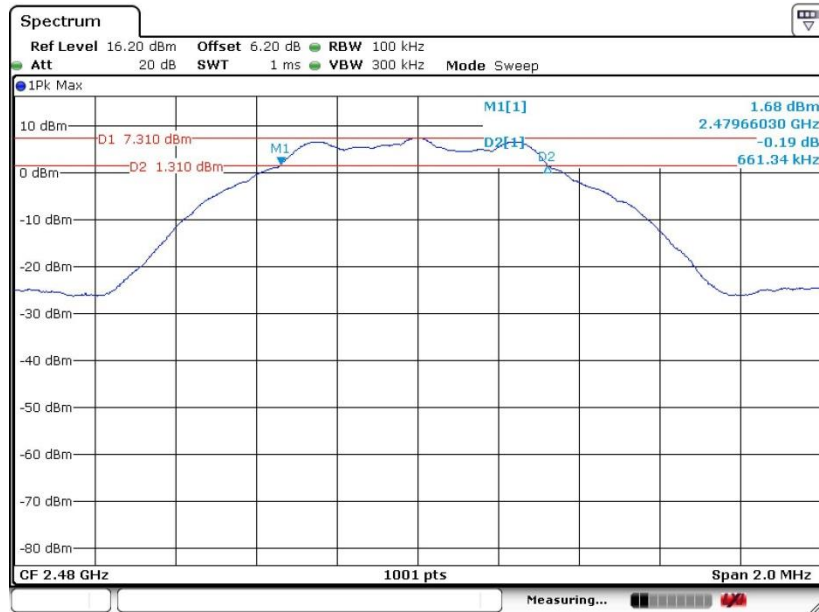

Bluetooth v5.0 LE:

6 dB Bandwidth Plot on Channel 00





6 dB Bandwidth Plot on Channel 19

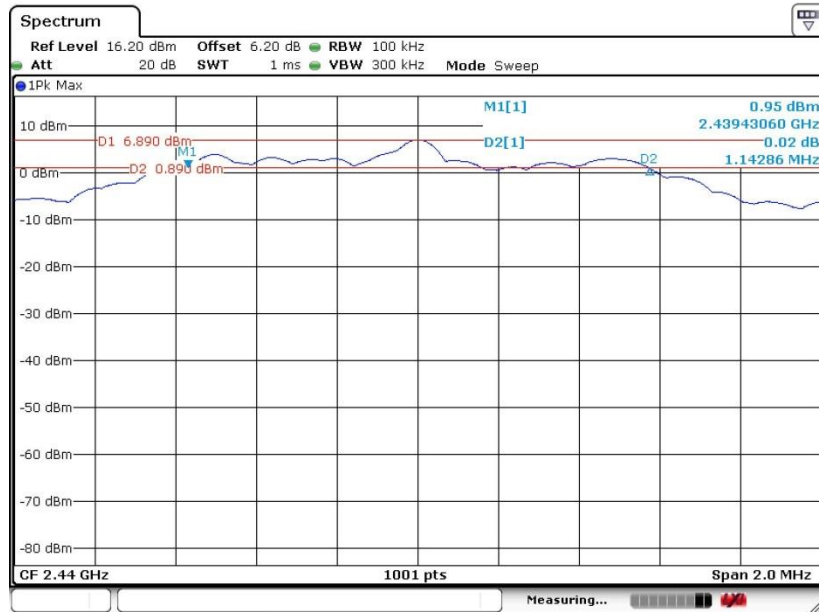

6 dB Bandwidth Plot on Channel 39

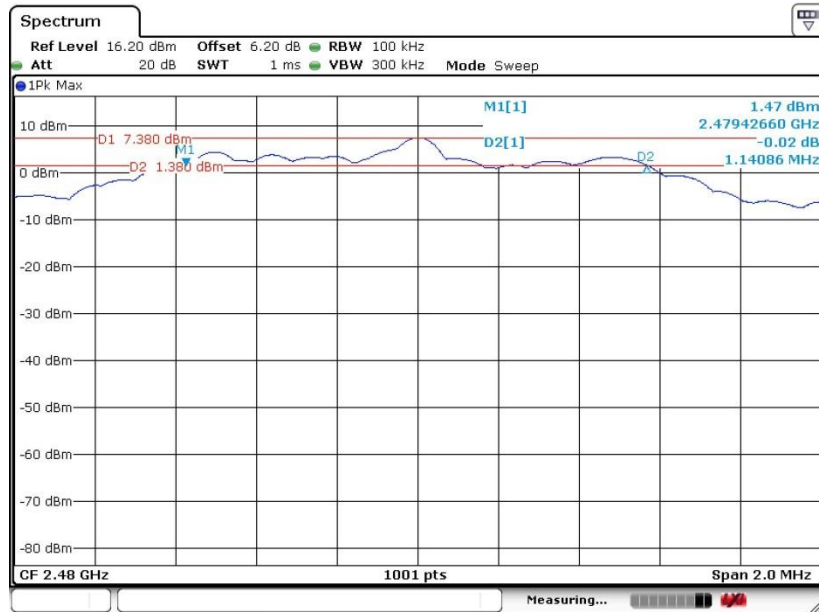



### 3.1.6 Test Result of 99% Occupied Bandwidth

Please refer to Appendix A.

Bluetooth v4.2 LE:

#### 99% Bandwidth Plot on Channel 00

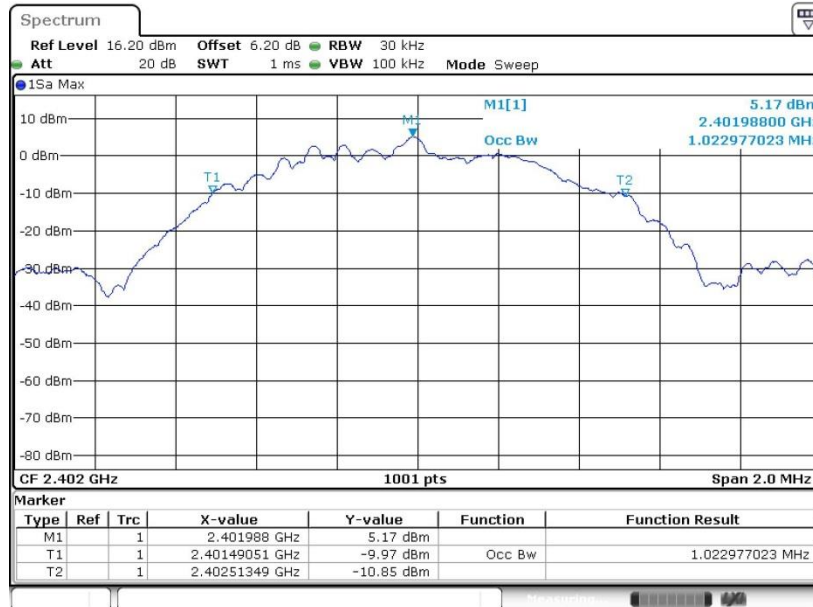

#### 99% Occupied Bandwidth Plot on Channel 19

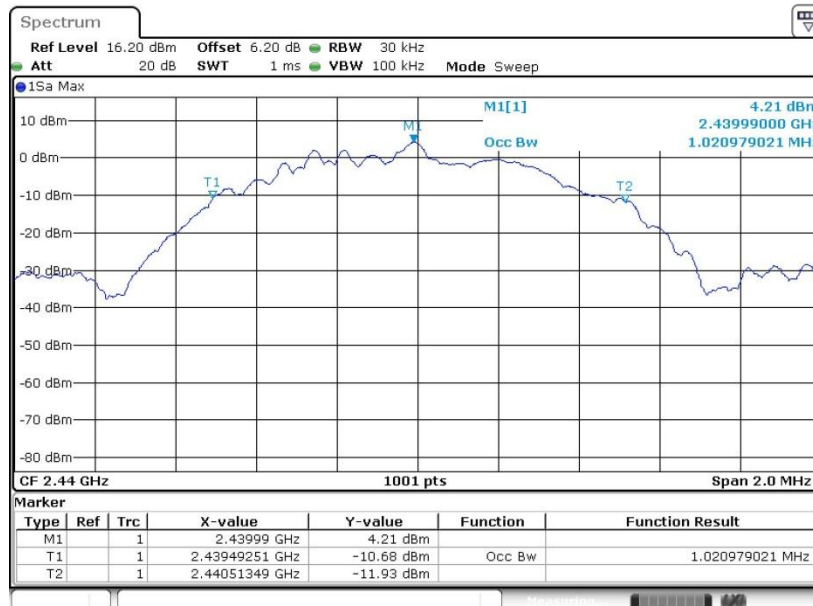





99% Occupied Bandwidth Plot on Channel 39

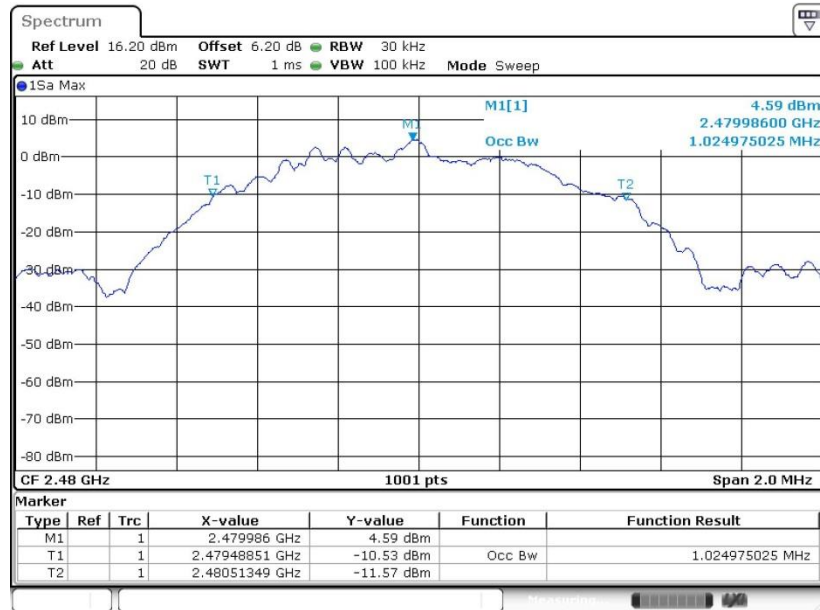

Bluetooth v5.0 LE:

99% Bandwidth Plot on Channel 00

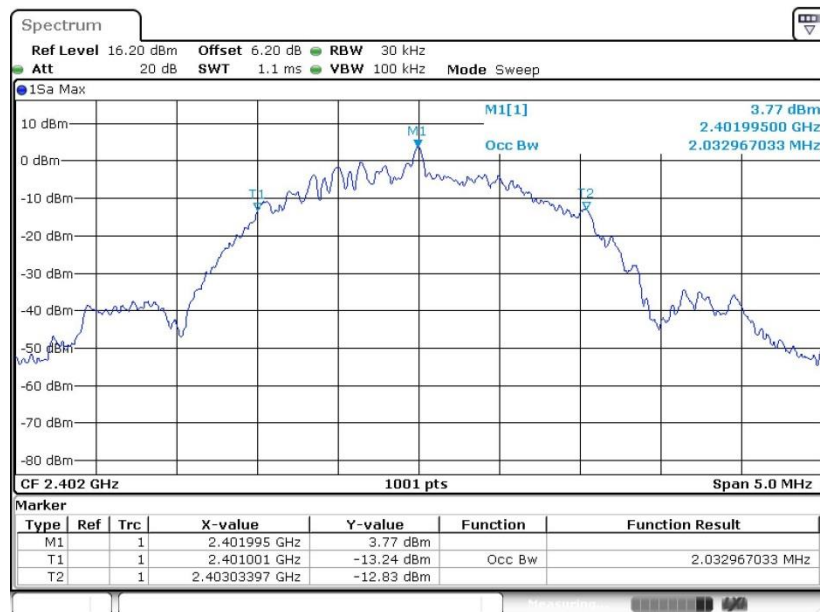



99% Occupied Bandwidth Plot on Channel 19

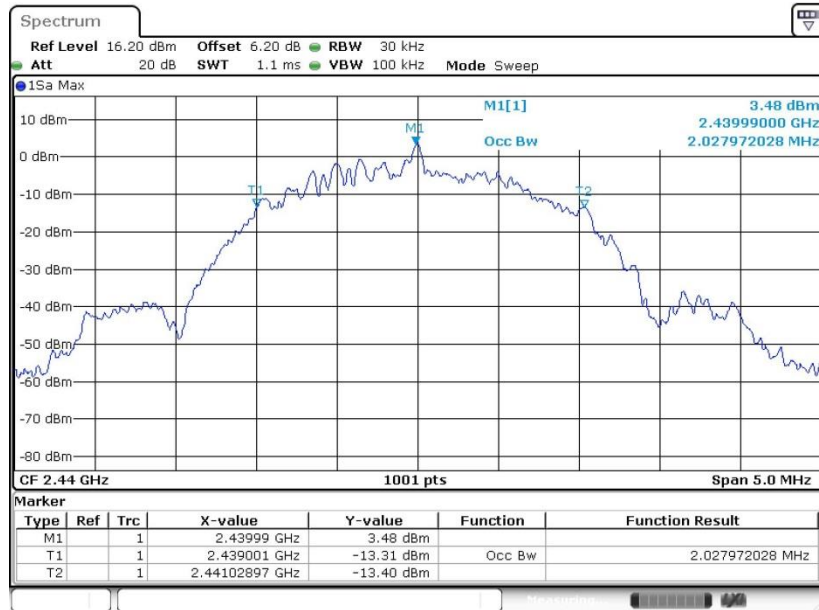

99% Occupied Bandwidth Plot on Channel 39

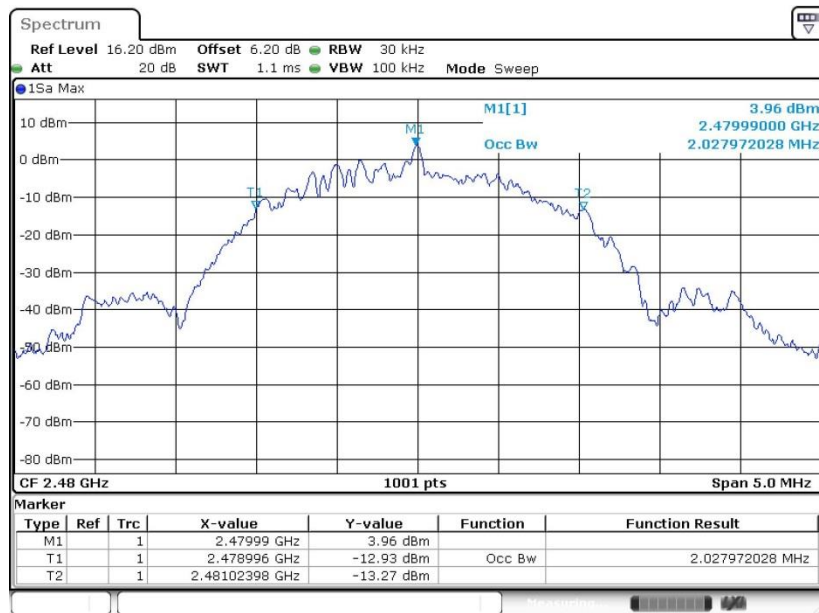

Note : The occupied channel bandwidth is maintained within the band of operation for all of the modulations.

## 3.2 Output Power Measurement

### 3.2.1 Limit of Output Power

For systems using digital modulation in the 2400-2483.5MHz, the limit for peak output power is 30dBm. If transmitting antenna of directional gain greater than 6dBi is used, the peak output power from the intentional radiator shall be reduced below the above stated value by the amount in dB that the directional gain of the antenna exceeds 6 dBi. In case of point-to-point operation, the limit has to be reduced by 1dB for every 3dB that the directional gain of the antenna exceeds 6dBi.

### 3.2.2 Measuring Instruments

The section 4.0 of List of Measuring Equipment of this test report is used for test.

### 3.2.3 Test Procedures

1. The testing follows the Measurement Procedure of ANSI C63.10-2013 clause 11.9.1.3 PKPM1 Peak power meter or ANSI C63.10-2013 clause 11.9.2.3.2 Method AVGPM-G method.
2. The RF output of EUT was connected to the power meter by RF cable and attenuator. The path loss was compensated to the results for each measurement.
3. Set to the maximum power setting and enable the EUT transmit continuously.
4. Measure the conducted output power and record the results in the test report.

### 3.2.4 Test Setup

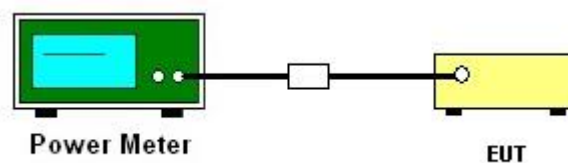

### 3.2.5 Test Result of Peak Output Power

Please refer to Appendix A.

### 3.2.6 Test Result of Average Output Power (Reporting Only)

Please refer to Appendix A.

### 3.3 Power Spectral Density Measurement

#### 3.3.1 Limit of Power Spectral Density

The peak power spectral density shall not be greater than 8dBm in any 3kHz band at any time interval of continuous transmission.

#### 3.3.2 Measuring Instruments

The section 4.0 of List of Measuring Equipment of this test report is used for test.

#### 3.3.3 Test Procedures

1. The testing follows Measurement Procedure of ANSI C63.10-2013 clause 11.10.2 Method PKPSD.
2. The RF output of EUT was connected to the spectrum analyzer by RF cable and attenuator. The path loss was compensated to the results for each measurement.
3. Set to the maximum power setting and enable the EUT transmit continuously.
4. Make the measurement with the spectrum analyzer's resolution bandwidth (RBW) = 3 kHz. Video bandwidth VBW = 10 kHz In order to make an accurate measurement, set the span to 1.5 times DTS Channel Bandwidth. (6dB BW)
5. Detector = peak, Sweep time = auto couple, Trace mode = max hold, Allow trace to fully stabilize. Use the peak marker function to determine the maximum power level.
6. Measure and record the results in the test report.
7. The Measured power density (dBm)/ 100kHz is a reference level and used as 20dBc down limit line for Conducted Band Edges and Conducted Spurious Emission.

#### 3.3.4 Test Setup

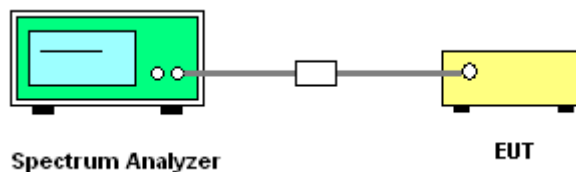

#### 3.3.5 Test Result of Power Spectral Density

Please refer to Appendix A.



### 3.3.6 Test Result of Power Spectral Density Plots (100kHz)

Bluetooth v4.2 LE:

PSD 100kHz Plot on Channel 00

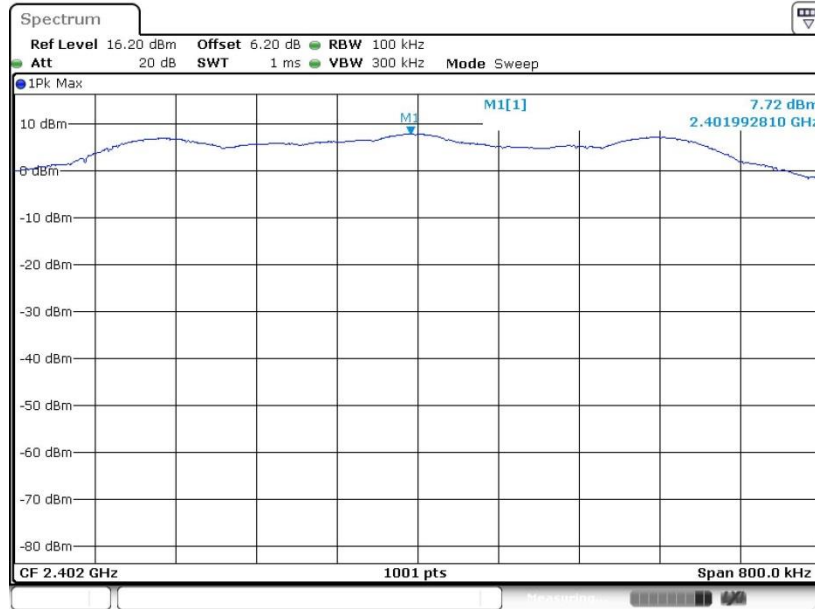

PSD 100kHz Plot on Channel 19

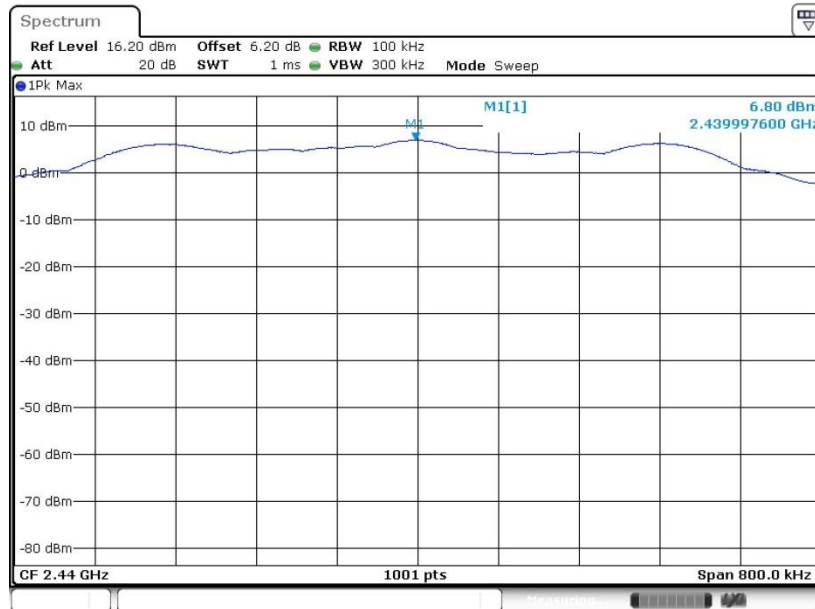



PSD 100kHz Plot on Channel 39

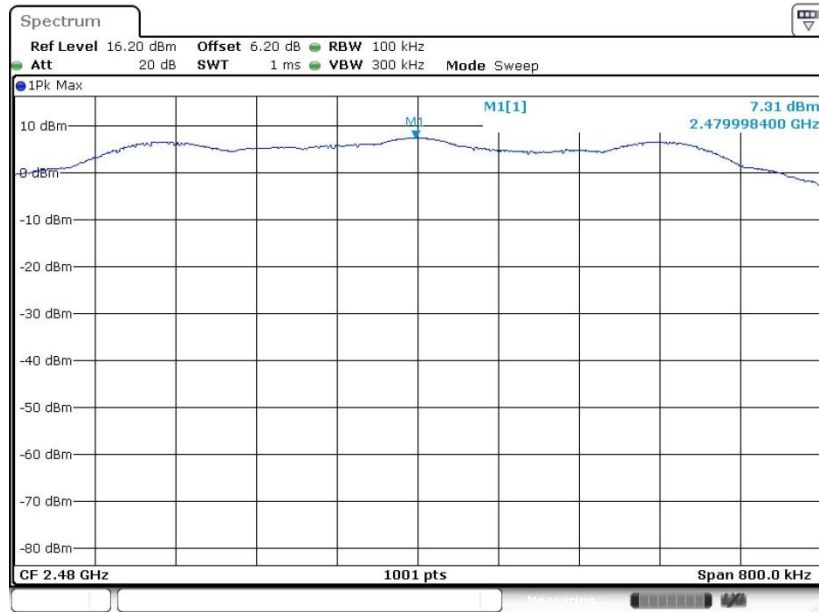

Bluetooth v5.0 LE:

PSD 100kHz Plot on Channel 00

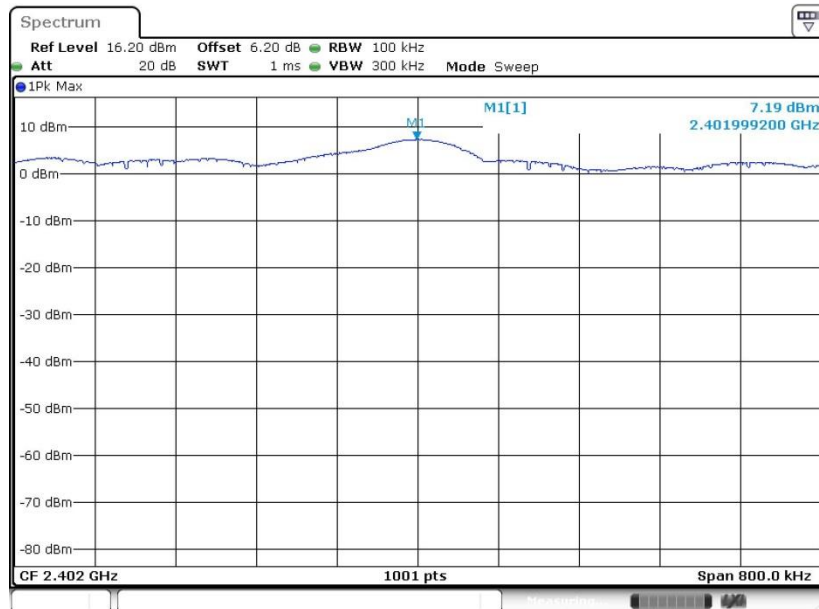



PSD 100kHz Plot on Channel 19

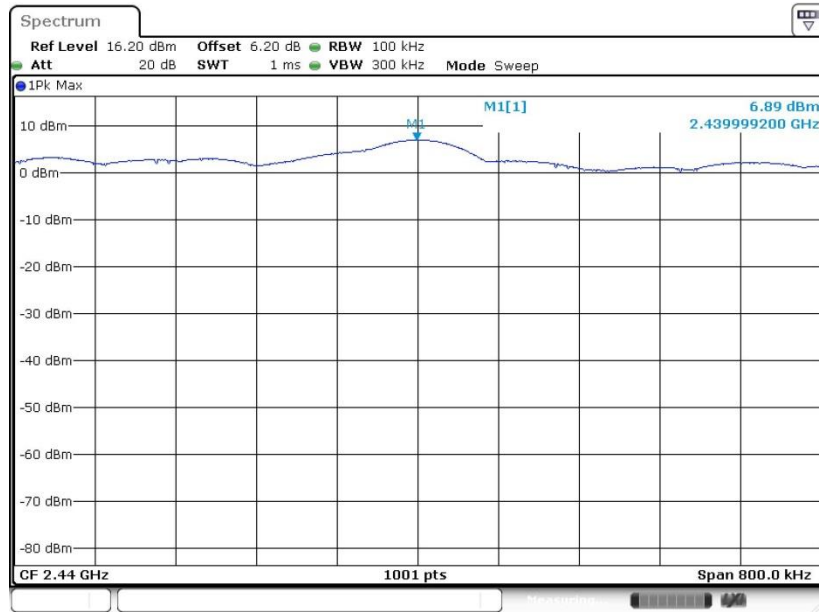

PSD 100kHz Plot on Channel 39

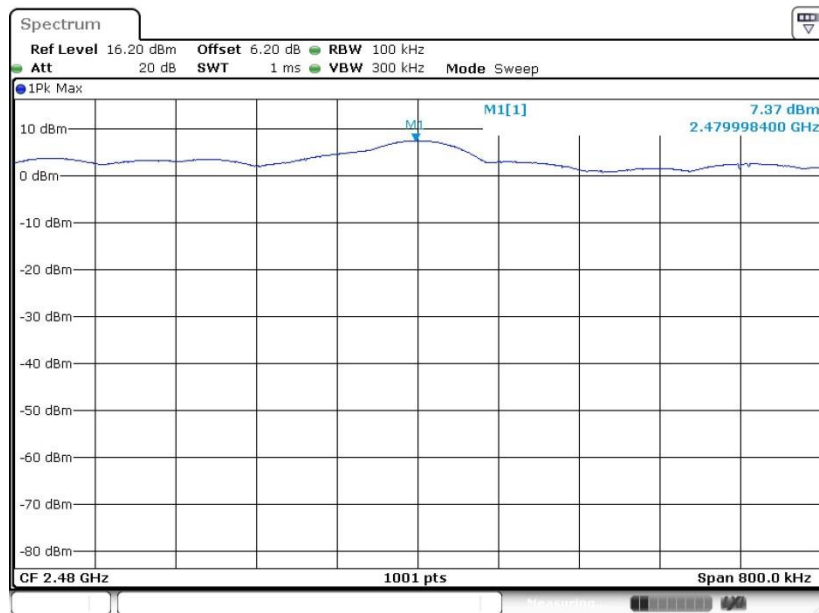



### 3.3.7 Test Result of Power Spectral Density Plots (3kHz)

Bluetooth v4.2 LE:

PSD 3kHz Plot on Channel 00

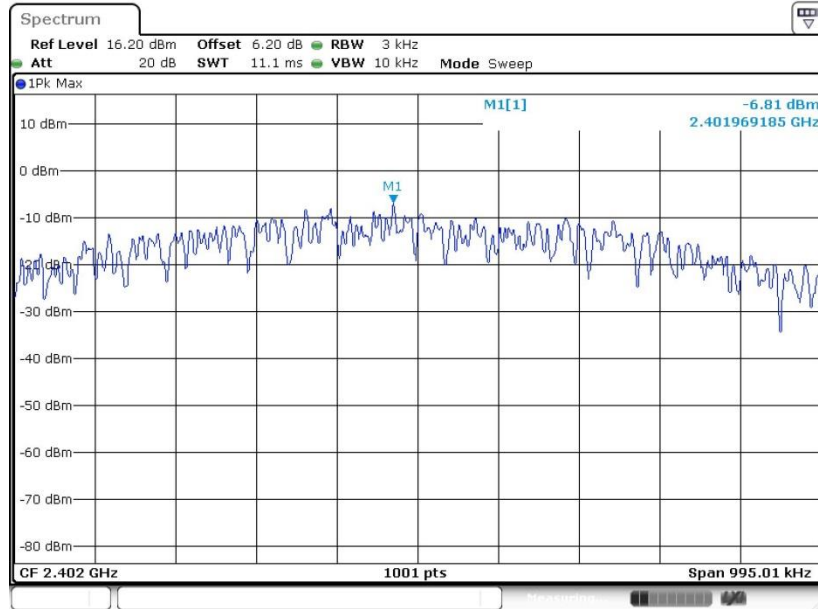

PSD 3kHz Plot on Channel 19

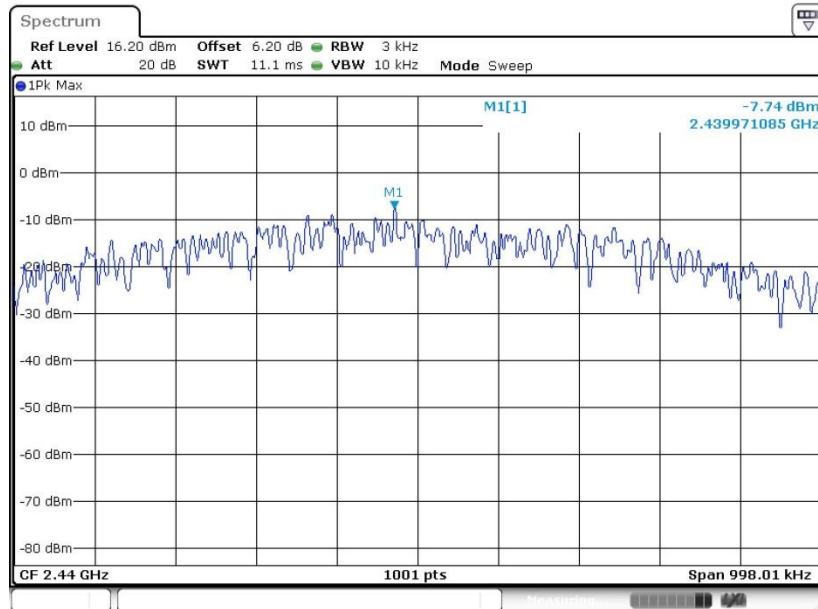





PSD 3kHz Plot on Channel 39

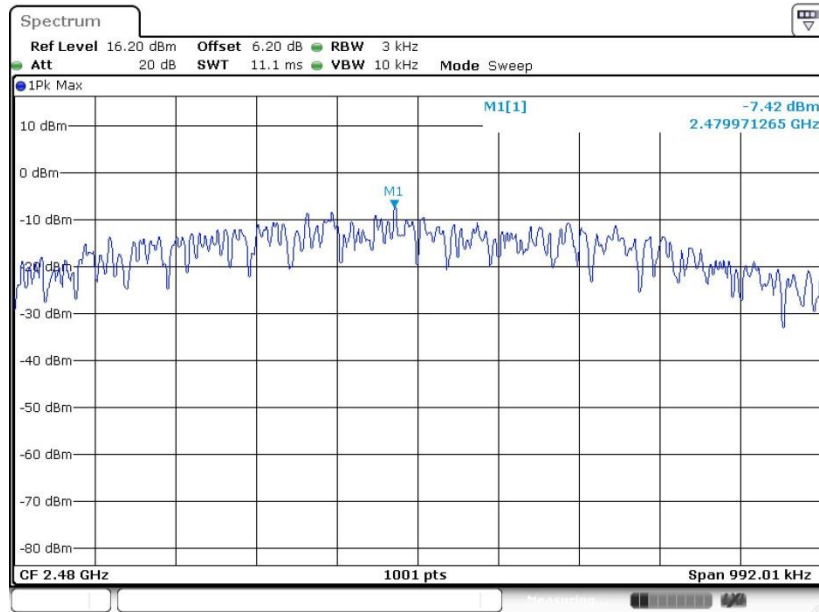

Bluetooth v5.0 LE:

PSD 3kHz Plot on Channel 00

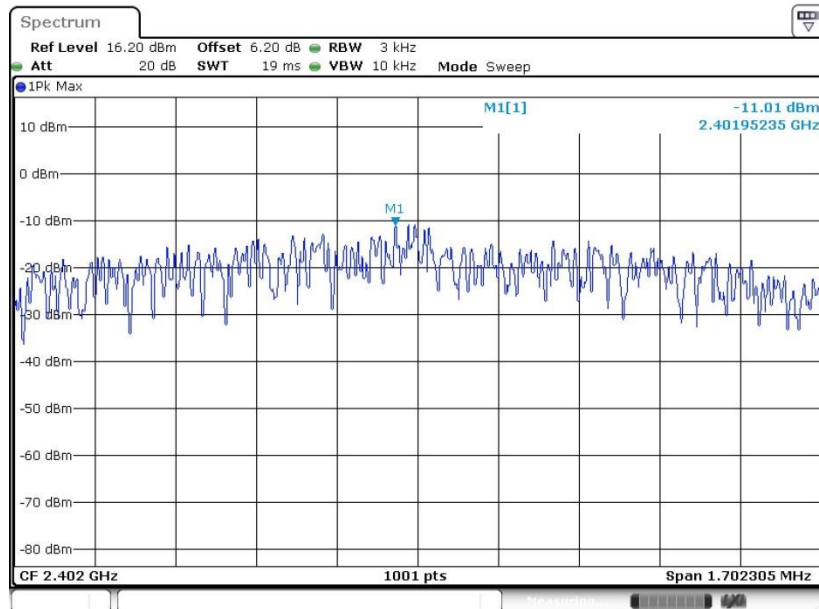



PSD 3kHz Plot on Channel 19

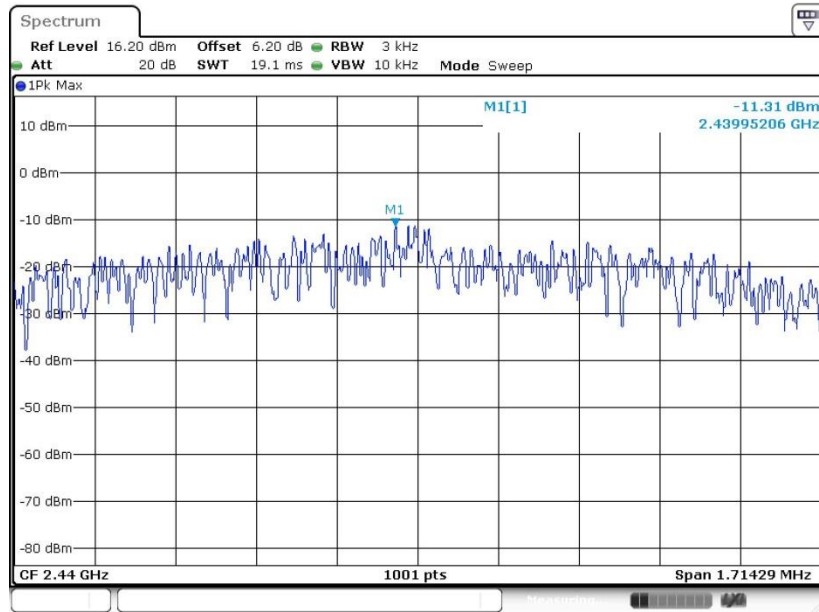

PSD 3kHz Plot on Channel 39

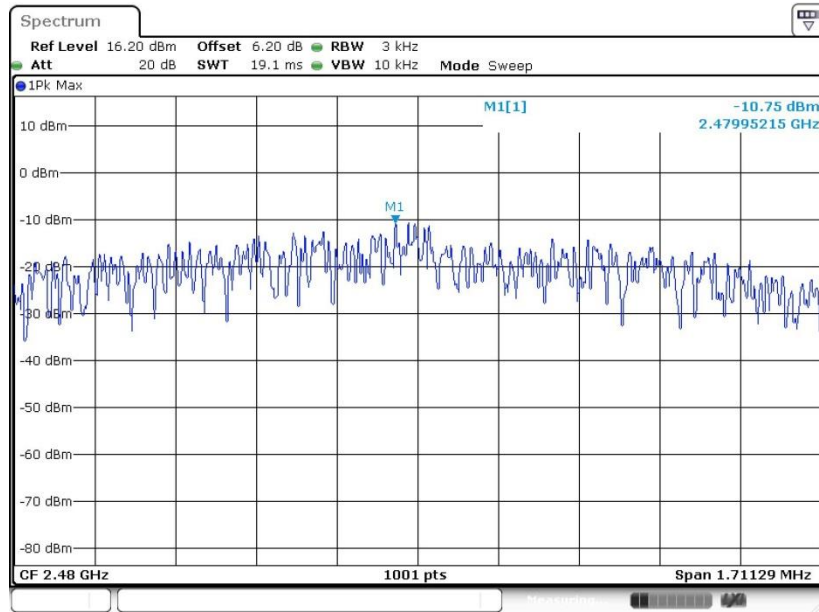

## 3.4 Conducted Band Edges and Spurious Emission Measurement

### 3.4.1 Limit of Conducted Band Edges and Spurious Emission

All harmonics/spurious must be at least 20 dB down from the highest emission level within the authorized band.

### 3.4.2 Measuring Instruments

The section 4.0 of List of Measuring Equipment of this test report is used for test.

### 3.4.3 Test Procedure

1. The testing follows ANSI C63.10-2013 clause 11.13
2. The RF output of EUT was connected to the spectrum analyzer by RF cable and attenuator. The path loss was compensated to the results for each measurement.
3. Set to the maximum power setting and enable the EUT transmit continuously.
4. Set RBW = 100 kHz, VBW=300 kHz, Peak Detector. Unwanted Emissions measured in any 100 kHz bandwidth outside of the authorized frequency band shall be attenuated by at least 20 dB relative to the maximum in-band peak PSD level in 100 kHz when maximum peak conducted output power procedure is used. If the transmitter complies with the conducted power limits based on the use of RMS averaging over a time interval, the attenuation required under this paragraph shall be 30 dB instead of 20 dB.
5. Measure and record the results in the test report.
6. The RF fundamental frequency should be excluded against the limit line in the operating frequency band.

### 3.4.4 Test Setup





### 3.4.5 Test Result of Conducted Band Edges Plots

Bluetooth v4.2 LE:

Low Band Edge Plot on Channel 00

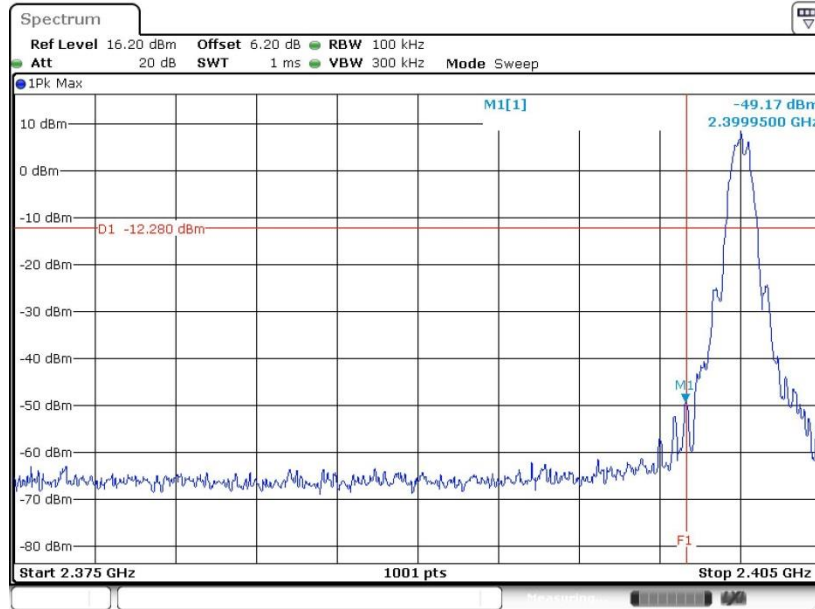

High Band Edge Plot on Channel 39

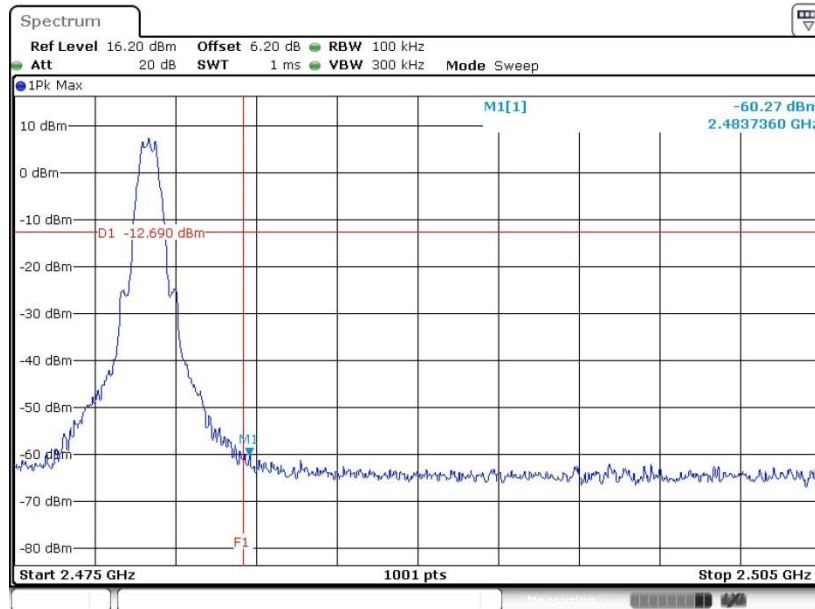



Bluetooth v5.0 LE:

Low Band Edge Plot on Channel 00

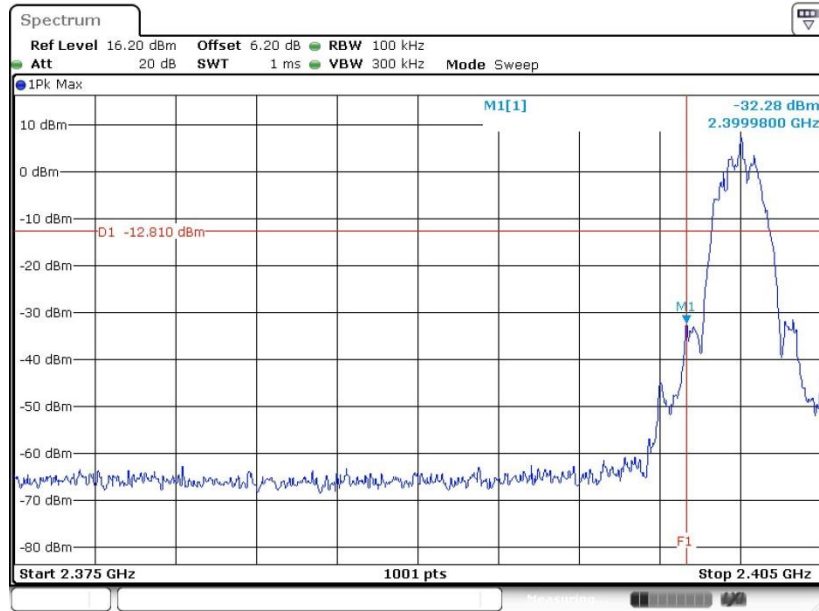

High Band Edge Plot on Channel 39

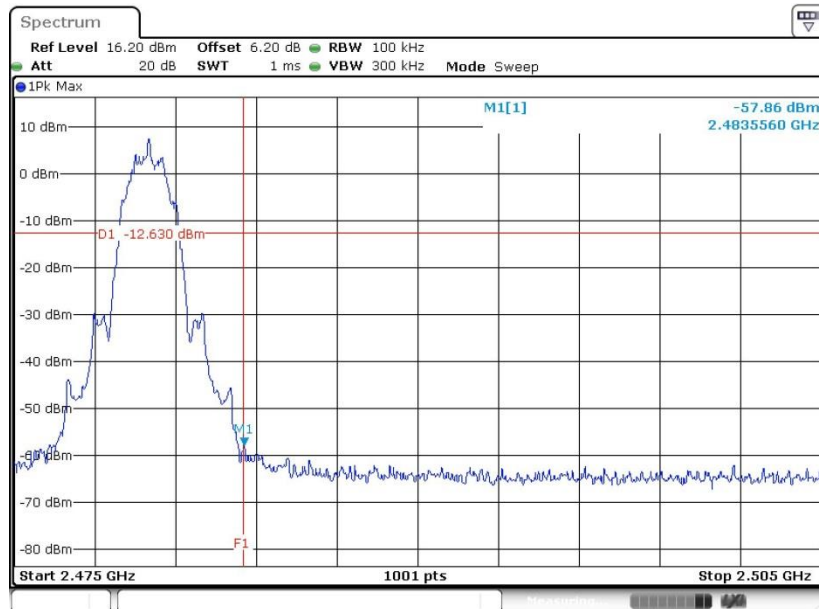



### 3.4.6 Test Result of Conducted Spurious Emission Plots

Bluetooth v4.2 LE:

#### Conducted Spurious Emission Plot on Bluetooth LE 1Mbps GFSK Channel 00

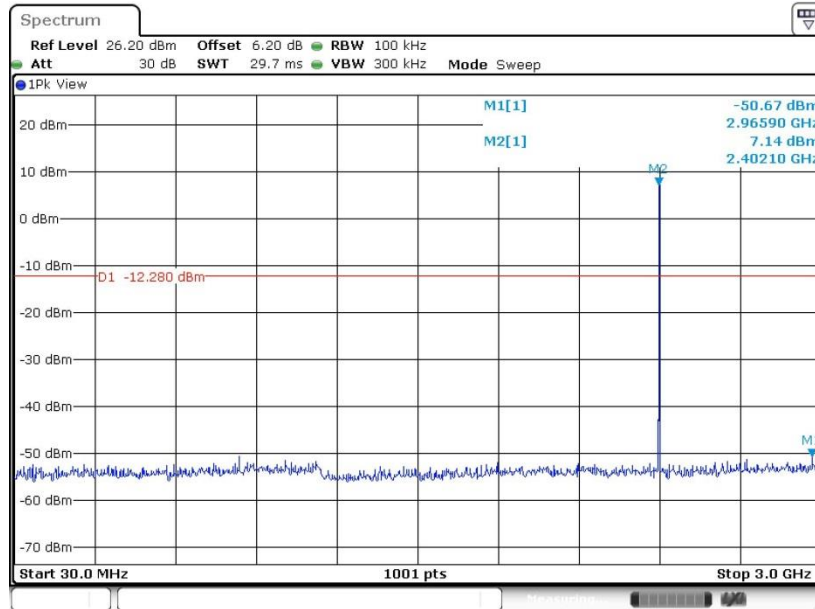

#### Conducted Spurious Emission Plot on Bluetooth LE 1Mbps GFSK Channel 00

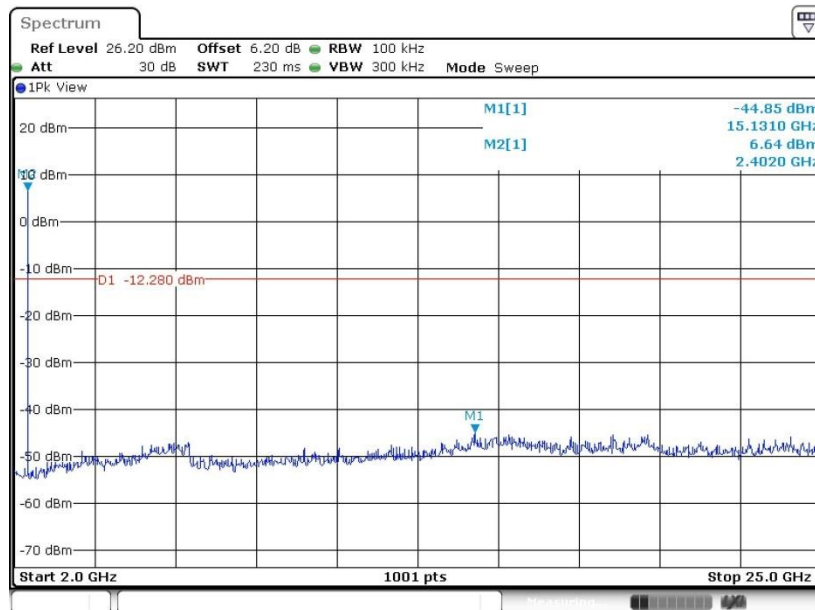



Conducted Spurious Emission Plot on Bluetooth LE 1Mbps GFSK Channel 19

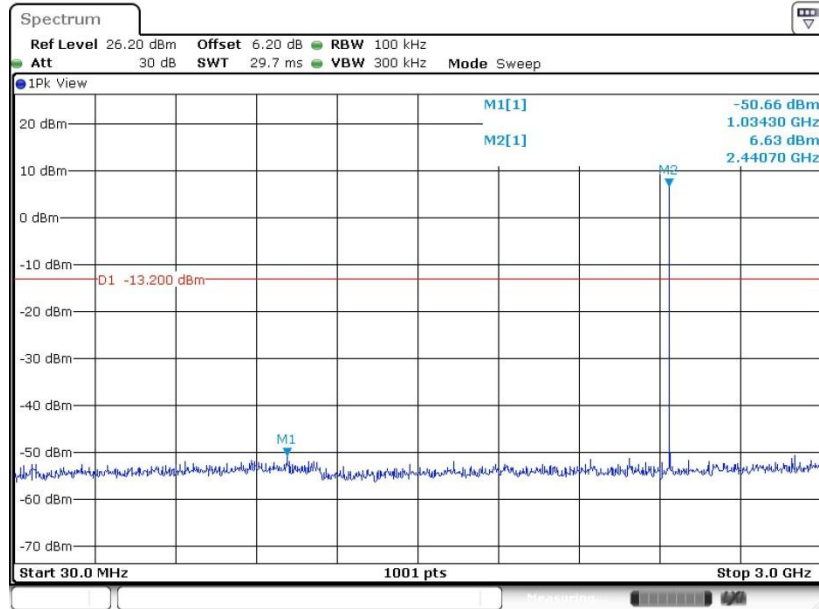

Conducted Spurious Emission Plot on Bluetooth LE 1Mbps GFSK Channel 19

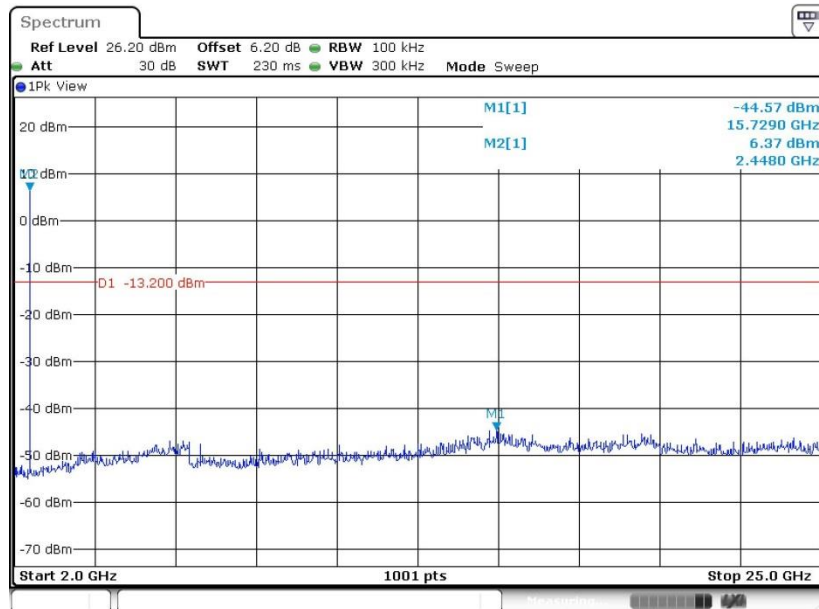



Conducted Spurious Emission Plot on Bluetooth LE 1Mbps GFSK Channel 39

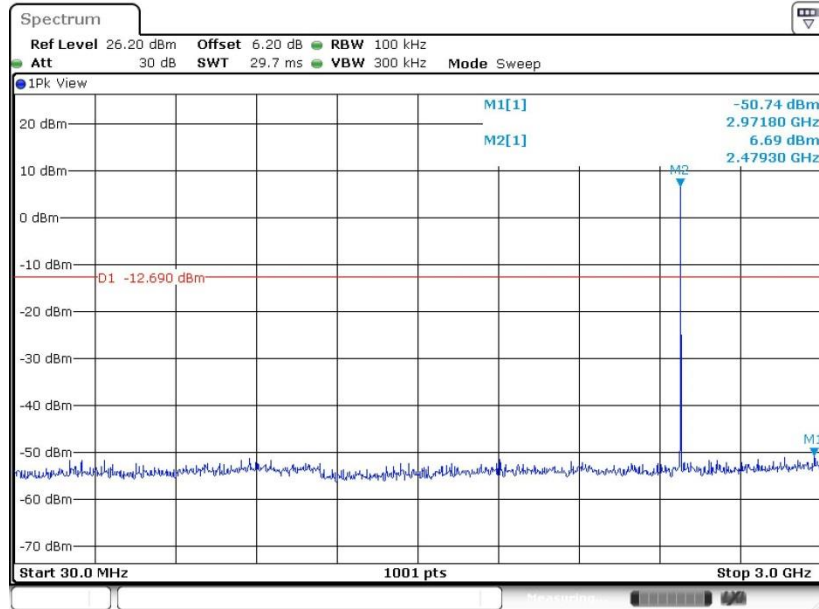

Conducted Spurious Emission Plot on Bluetooth LE 1Mbps GFSK Channel 39

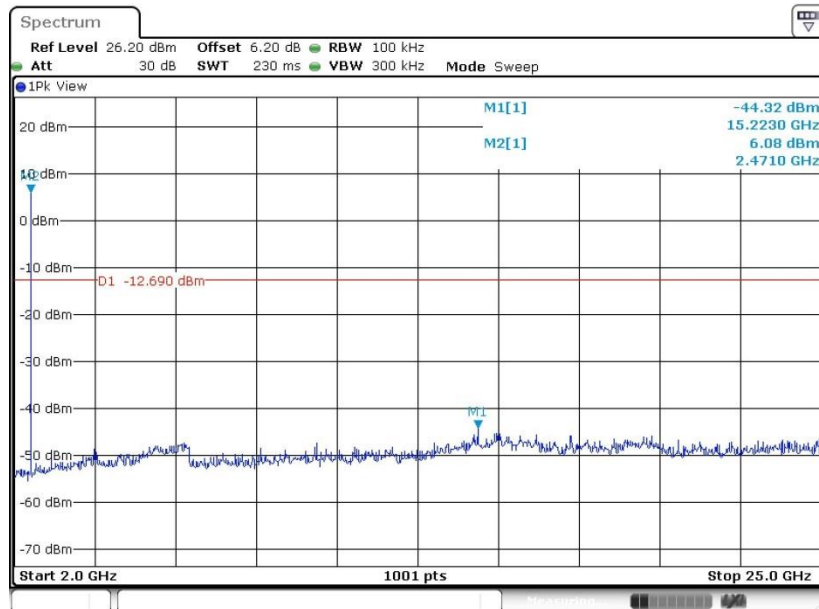





Bluetooth v5.0 LE:

Conducted Spurious Emission Plot on Bluetooth LE 2Mbps GFSK Channel 00

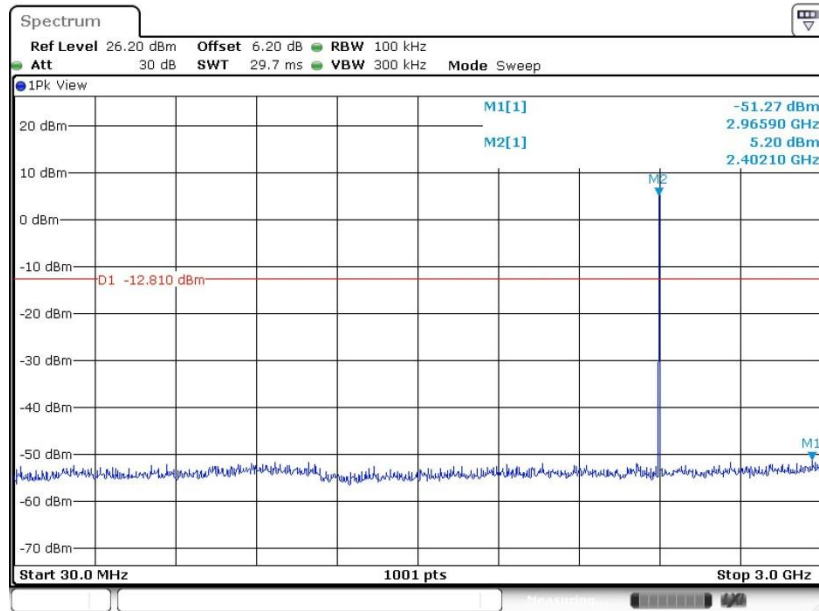

Conducted Spurious Emission Plot on Bluetooth LE 2Mbps GFSK Channel 00

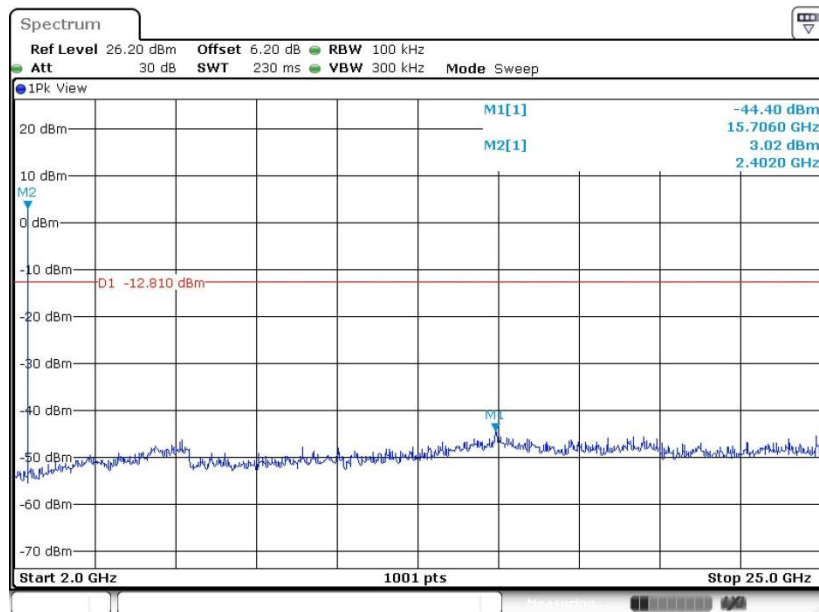



### Conducted Spurious Emission Plot on Bluetooth LE 2Mbps GFSK Channel 19

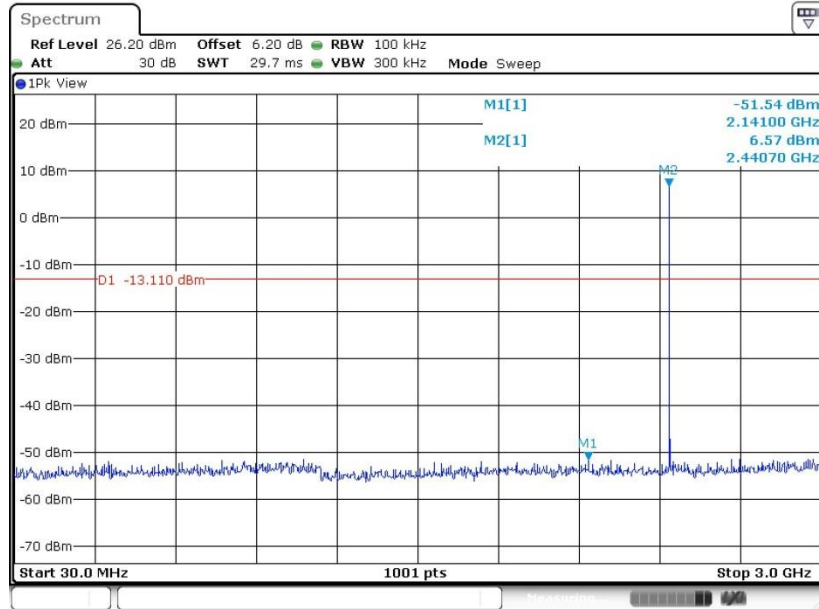

### Conducted Spurious Emission Plot on Bluetooth LE 2Mbps GFSK Channel 19

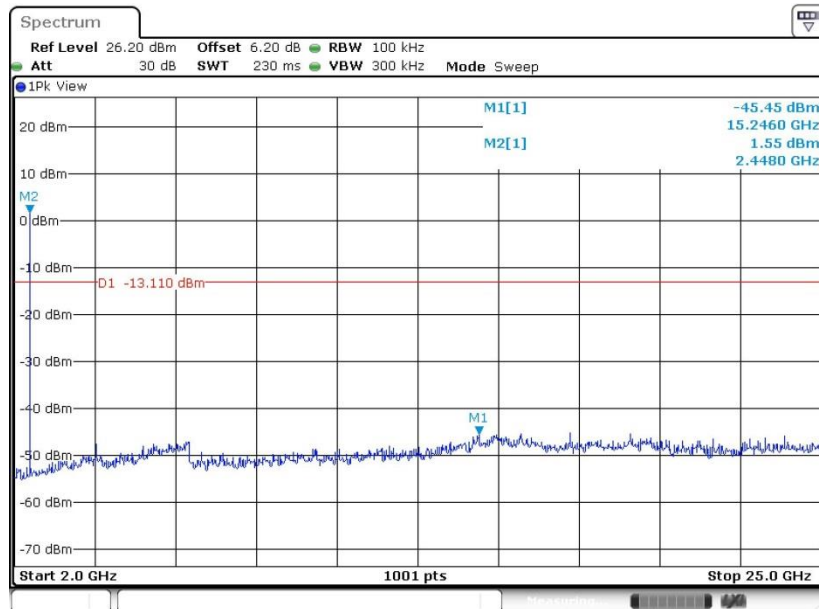



Conducted Spurious Emission Plot on Bluetooth LE 2Mbps GFSK Channel 39

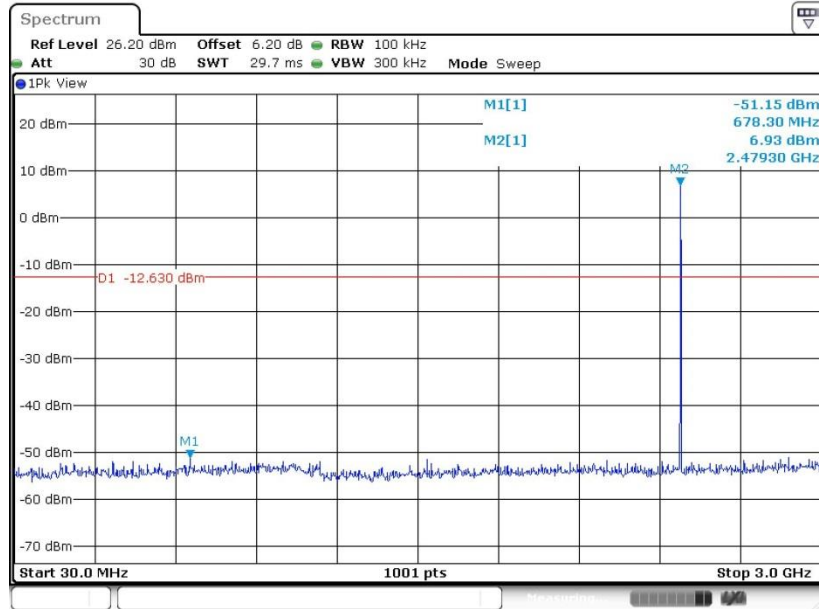

Conducted Spurious Emission Plot on Bluetooth LE 2Mbps GFSK Channel 39

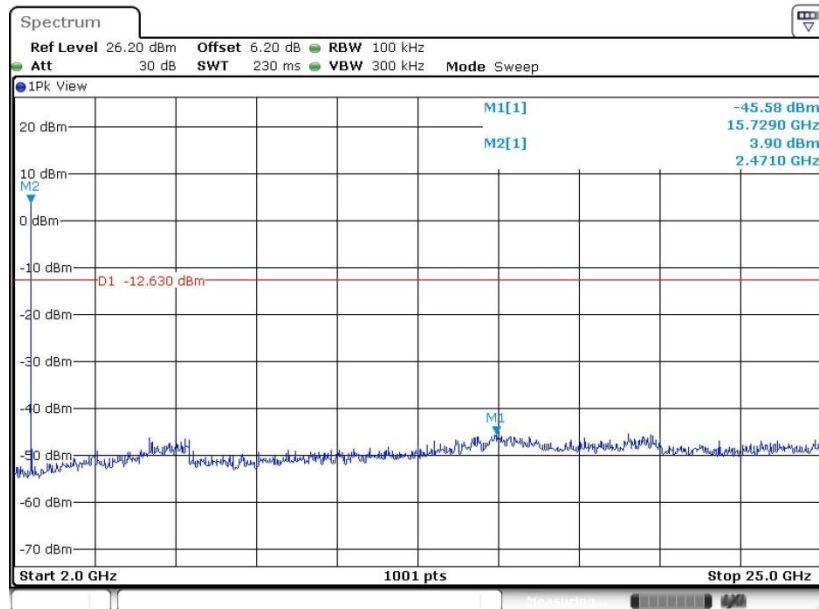



### 3.5 Radiated Band Edges and Spurious Emission Measurement

#### 3.5.1 Limit of Radiated Band Edges and Spurious Emission

In any 100 kHz bandwidth outside the intentional radiator frequency band, all harmonics/spurious must be at least 20 dB below the highest emission level within the authorized band. If the output power of this device was measured by spectrum analyzer, the attenuation under this paragraph shall be 30 dB instead of 20 dB. In addition, radiated emissions which fall in the restricted bands must also comply with the limits as below.

Frequency (MHz)	Field Strength (microvolts/meter)	Measurement Distance (meters)
0.009 – 0.490	2400/F(kHz)	300
0.490 – 1.705	24000/F(kHz)	30
1.705 – 30.0	30	30
30 – 88	100	3
88 – 216	150	3
216 - 960	200	3
Above 960	500	3

#### 3.5.2 Measuring Instruments

The section 4.0 of List of Measuring Equipment of this test report is used for test.



### 3.5.3 Test Procedures

1. The testing follows ANSI C63.10-2013 clause 11.11 & 11.12
2. The EUT was arranged to its worst case and then tune the antenna tower (from 1 m to 4 m) and turntable (from 0 degree to 360 degrees) to find the maximum reading. A pre-amp and a high pass filter are used for the test in order to get better signal level.
3. The EUT was placed on a turntable with 0.8 meter for frequency below 1GHz and 1.5 meter for frequency above 1GHz respectively above ground.
4. The EUT was set 3 meters from the interference receiving antenna, which was mounted on the top of a variable height antenna tower.
5. Corrected Reading: Antenna Factor + Cable Loss + Read Level - Preamp Factor = Level
6. For testing below 1GHz, if the emission level of the EUT in peak mode was 3 dB lower than the limit specified, then peak values of EUT will be reported, otherwise, the emissions will be repeated one by one using the CISPR quasi-peak method and reported.
7. For testing above 1GHz, the emission level of the EUT in peak mode was 20dB lower than average limit (that means the emission level in average mode also complies with the limit in average mode), then peak values of EUT will be reported, otherwise, the emissions will be measured in average mode again and reported.
8. Use the following spectrum analyzer settings:
  - (1) Span shall wide enough to fully capture the emission being measured;
  - (2) Set RBW=100 kHz for  $f < 1$  GHz;  $VBW \geq RBW$ ; Sweep = auto; Detector function = peak; Trace = max hold;
  - (3) Set RBW = 1 MHz, VBW= 3MHz for  $f \geq 1$  GHz for peak measurement.  
For average measurement:
    - $VBW = 10$  Hz, when duty cycle is no less than 98 percent.
    - $VBW \geq 1/T$ , when duty cycle is less than 98 percent where T is the minimum transmission duration over which the transmitter is on and is transmitting at its maximum power control level for the tested mode of operation.

### 3.5.4 Test Setup

For radiated emissions below 30MHz

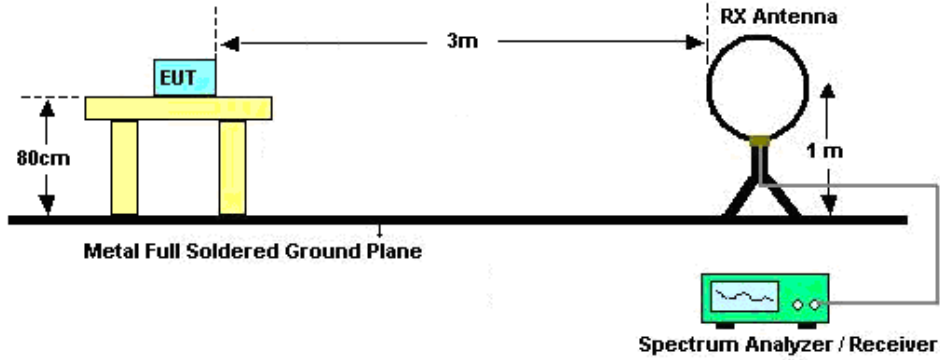

For radiated emissions from 30MHz to 1GHz

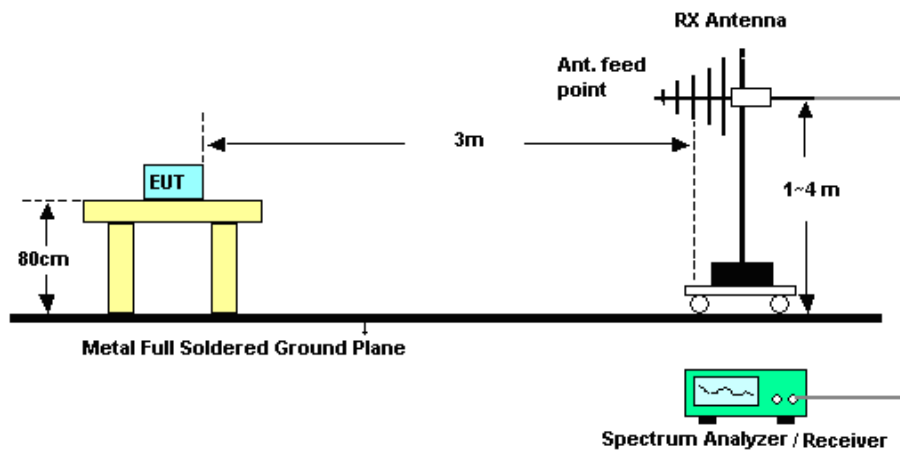

For radiated emissions above 1GHz

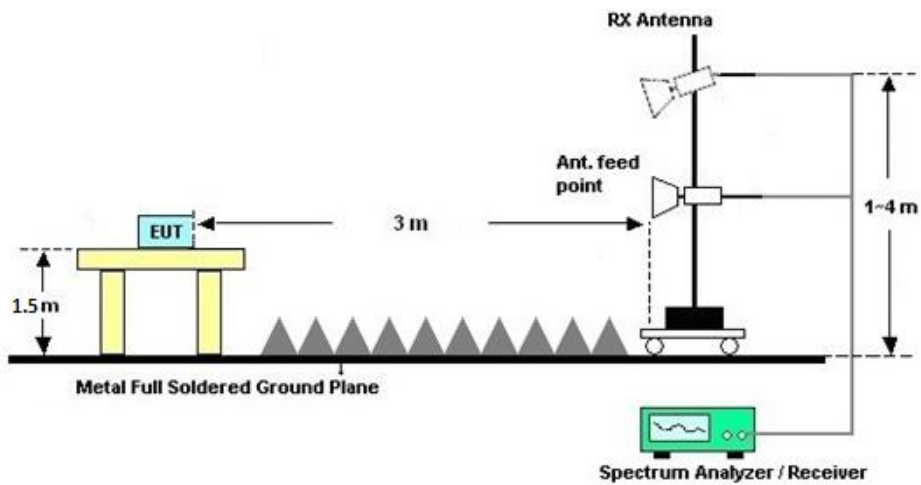



### **3.5.5 Test Results of Radiated Spurious Emissions (9 kHz ~ 30 MHz)**

The low frequency, which started from 9 kHz to 30MHz, was pre-scanned and the result which was 20dB lower than the limit line was not reported.

There is a comparison data of both open-field test site and semi-Anechoic chamber, and the result came out very similar.

### **3.5.6 Test Result of Radiated Spurious at Band Edges**

Please refer to Appendix C.

### **3.5.7 Duty Cycle**

Please refer to Appendix D.

### **3.5.8 Test Result of Radiated Spurious Emission (30MHz ~ 10th Harmonic)**

Please refer to Appendix C.



### 3.6 AC Conducted Emission Measurement

#### 3.6.1 Limit of AC Conducted Emission

For equipment that is designed to be connected to the public utility (AC) power line, the radio frequency voltage that is conducted back onto the AC power line on any frequency or frequencies within the band 150 kHz to 30 MHz shall not exceed the limits in the following table.

Frequency of emission (MHz)	Conducted limit (dBµV)	
	Quasi-peak	Average
0.15-0.5	66 to 56*	56 to 46*
0.5-5	56	46
5-30	60	50

\*Decreases with the logarithm of the frequency.

#### 3.6.2 Measuring Instruments

The section 4.0 of List of Measuring Equipment of this test report is used for test.

#### 3.6.3 Test Procedures

1. The EUT was placed 0.4 meter from the conducting wall of the shielding room was kept at least 80 centimeters from any other grounded conducting surface.
2. Connect EUT to the power mains through a line impedance stabilization network (LISN).
3. All the support units are connecting to the other LISN.
4. The LISN provides 50 ohm coupling impedance for the measuring instrument.
5. The FCC states that a 50 ohm, 50 microhenry LISN should be used.
6. Both sides of AC line were checked for maximum conducted interference.
7. The frequency range from 150 kHz to 30 MHz was searched.
8. Set the test-receiver system to Peak Detect Function and specified bandwidth (IF Bandwidth = 9kHz) with Maximum Hold Mode. Then measurement is also conducted by Average Detector and Quasi-Peak Detector Function respectively.



### 3.6.4 Test Setup

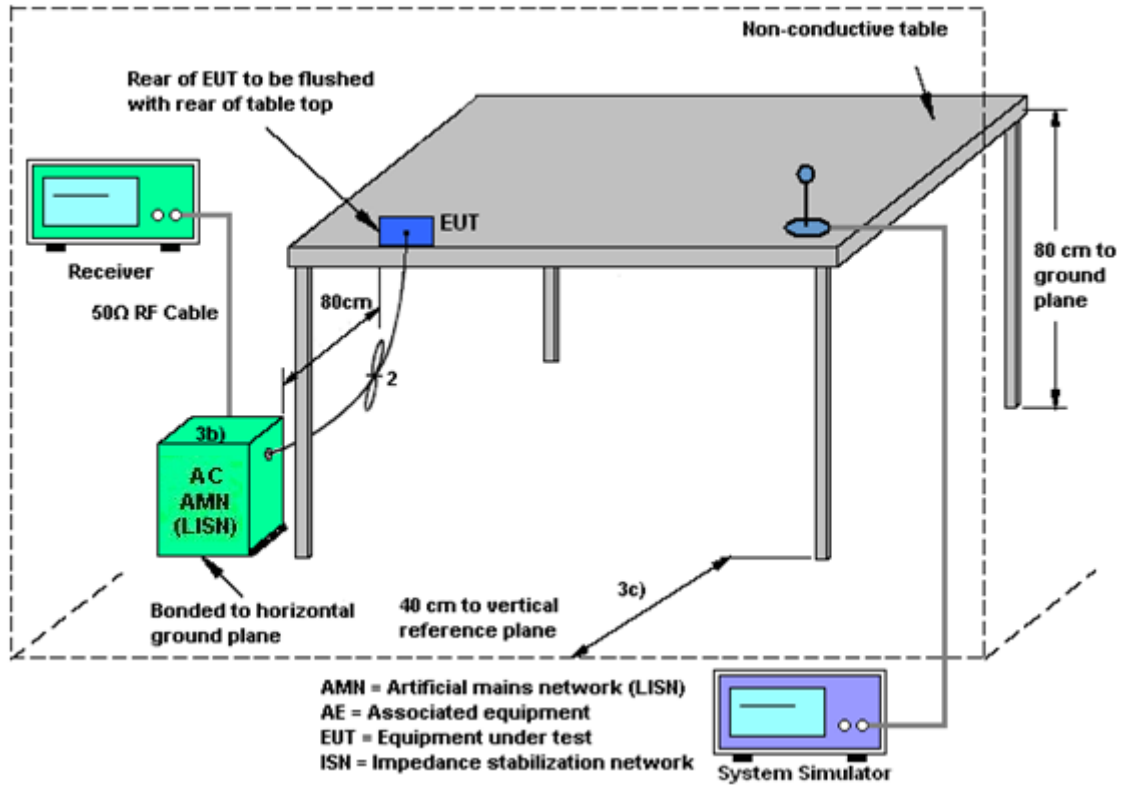

### 3.6.5 Test Result of AC Conducted Emission

Please refer to Appendix B.



## **3.7 Antenna Requirements**

### **3.7.1 Standard Applicable**

If directional gain of transmitting antennas is greater than 6dBi, the power shall be reduced by the same level in dB comparing to gain minus 6dBi. The use of a permanently attached antenna or of an antenna that uses a unique coupling to the intentional radiator shall be considered sufficient to comply with the rule.

### **3.7.2 Antenna Anti-Replacement Construction**

An embedded-in antenna design is used.

### **3.7.3 Antenna Gain**

The antenna peak gain of EUT is less than 6 dBi. Therefore, it is not necessary to reduce maximum peak output power limit.



## 4 List of Measuring Equipment

Instrument	Manufacturer	Model No.	Serial No.	Characteristics	Calibration Date	Test Date	Due Date	Remark
Spectrum Analyzer	R&S	FSV30	101338	10Hz~30GHz	Apr. 16, 2019	Nov. 19, 2019	Apr. 15, 2020	Conducted (TH01-KS)
Pulse Power Sensor	Anritsu	MA2411B	0917070	300MHz~40GHz	Jan. 14, 2019	Nov. 19, 2019	Jan. 13, 2020	Conducted (TH01-KS)
Power Meter	Anritsu	ML2495A	1005002	50MHz Bandwidth	Jan. 14, 2019	Nov. 19, 2019	Jan. 13, 2020	Conducted (TH01-KS)
EMI Receiver	R&S	ESCI7	100768	9kHz~7GHz;	Apr. 16, 2019	Oct. 30, 2019	Apr. 15, 2020	Conduction (CO01-KS)
AC LISN	MessTec	AN3016	060103	9kHz~30MHz	Oct. 11, 2019	Oct. 30, 2019	Oct. 10, 2020	Conduction (CO01-KS)
AC LISN (for auxiliary equipment)	MessTec	AN3016	060105	9kHz~30MHz	Nov. 19, 2018	Oct. 30, 2019	Nov. 18, 2019	Conduction (CO01-KS)
AC Power Source	Chroma	61602	ABP00000811	AC 0V~300V, 45Hz~1000Hz	Oct. 11, 2019	Oct. 30, 2019	Oct. 10, 2020	Conduction (CO01-KS)
EMI Test Receiver	Keysight	N9038A	MY57290157	3Hz~8.5GHz; Max 30dBm	Jul. 18, 2019	Nov. 20, 2019	Jul. 17, 2020	Radiation (03CH06-KS)
EXA Spectrum Analyzer	Keysight	N9010A	MY55150208	10Hz-44GHz	Apr. 16, 2019	Nov. 20, 2019	Apr. 18, 2020	Radiation (03CH06-KS)
Loop Antenna	R&S	HFH2-Z2	100321	9kHz~30MHz	Oct. 18, 2019	Nov. 20, 2019	Oct. 17, 2020	Radiation (03CH06-KS)
Bilog Antenna	TeseQ	CBL6111D	44483	30MHz-1GHz	Dec. 28, 2018	Nov. 20, 2019	Dec. 27, 2019	Radiation (03CH06-KS)
Double Ridge Horn Antenna	ETS-Lindgren	3117	75959	1GHz~18GHz	Jan. 27, 2019	Nov. 20, 2019	Jan. 26, 2020	Radiation (03CH06-KS)
SHF-EHF Horn	Com-power	AH-840	101070	18GHz~40GHz	Jan. 05, 2019	Nov. 20, 2019	Jan. 04, 2020	Radiation (03CH06-KS)
Amplifier	SONOMA	310N	187289	9KHz ~1GHZ	Aug. 06, 2019	Nov. 20, 2019	Aug. 05, 2020	Radiation (03CH06-KS)
high gain Amplifier	MITEQ	AMF-7D-0010	2025788	1Ghz-18Ghz	Aug. 16, 2019	Nov. 20, 2019	Aug. 15, 2020	Radiation (03CH06-KS)
Amplifier	Keysight	83017A	MY53270203	500MHz~26.5GHz	Apr. 15, 2019	Nov. 20, 2019	Apr. 14, 2020	Radiation (03CH06-KS)
Amplifier	MITEQ	TTA1840-35-HG	2014749	18~40GHz	Jan. 14, 2019	Nov. 20, 2019	Jan. 13, 2020	Radiation (03CH06-KS)
AC Power Source	Chroma	61601	F104090004	N/A	NCR	Nov. 20, 2019	NCR	Radiation (03CH06-KS)
Turn Table	ChamPro	EM 1000-T	060762-T	0~360 degree	NCR	Nov. 20, 2019	NCR	Radiation (03CH06-KS)
Antenna Mast	ChamPro	EM 1000-A	060762-A	1 m~4 m	NCR	Nov. 20, 2019	NCR	Radiation (03CH06-KS)

NCR: No Calibration Required



## 5 Uncertainty of Evaluation

The measurement uncertainties shown below were calculated in accordance with the requirements of ANSI 63.10-2013. All the measurement uncertainty value were shown with a coverage K=2 to indicate 95% level of confidence. The measurement data show herein meets or exceeds the CISPR measurement uncertainty values specified in CISPR 16-4-2 and can be compared directly to specified limit to determine compliance.

### Uncertainty of Conducted Emission Measurement (150 kHz ~ 30 MHz)

Measuring Uncertainty for a Level of Confidence of 95% (U = 2Uc(y))	2.9dB
---	-------

### Uncertainty of Radiated Emission Measurement (30 MHz ~ 1000 MHz)

Measuring Uncertainty for a Level of Confidence of 95% (U = 2Uc(y))	5.0dB
---	-------

### Uncertainty of Radiated Emission Measurement (1000 MHz ~ 18000 MHz)

Measuring Uncertainty for a Level of Confidence of 95% (U = 2Uc(y))	5.0dB
---	-------

### Uncertainty of Radiated Emission Measurement (18000 MHz ~ 40000 MHz)

Measuring Uncertainty for a Level of Confidence of 95% (U = 2Uc(y))	5.0dB
---	-------



## **Appendix A. Conducted Test Results**

**Bluetooth v4.2 Low Energy**

Test Engineer:	Aly Cao	Temperature:	20~26	°C
Test Date:	2019/11/19	Relative Humidity:	40~51	%

**TEST RESULTS DATA**  
**6dB and 99% Occupied Bandwidth**

Mod.	Data Rate	NTX	CH.	Freq. (MHz)	99% Occupied BW (MHz)	6dB BW (MHz)	6dB BW Limit (MHz)	Pass/Fail
BLE	1Mbps	1	0	2402	1.023	0.66	0.50	Pass
BLE	1Mbps	1	19	2440	1.021	0.67	0.50	Pass
BLE	1Mbps	1	39	2480	1.025	0.66	0.50	Pass

**TEST RESULTS DATA**  
**Peak Power Table**

Mod.	Data Rate	NTX	CH.	Freq. (MHz)	Peak Conducted Power (dBm)	Conducted Power Limit (dBm)	DG (dBi)	EIRP Power (dBm)	EIRP Power Limit (dBm)	Pass /Fail
BLE	1Mbps	1	0	2402	7.66	30.00	-5.00	2.66	36.00	Pass
BLE	1Mbps	1	19	2440	7.26	30.00	-5.00	2.26	36.00	Pass
BLE	1Mbps	1	39	2480	7.74	30.00	-5.00	2.74	36.00	Pass

**TEST RESULTS DATA**  
**Average Power Table**  
**(Reporting Only)**

Mod.	Data Rate	NTX	CH.	Freq. (MHz)	Duty Factor (dB)	Average Conducted Power (dBm)
BLE	1Mbps	1	0	2402	2.04	7.51
BLE	1Mbps	1	19	2440	2.04	7.13
BLE	1Mbps	1	39	2480	2.04	7.58

**TEST RESULTS DATA**  
**Peak Power Density**

Mod.	Data Rate	NTX	CH.	Freq. (MHz)	Peak PSD (dBm /100kHz)	Peak PSD (dBm /3kHz)	DG (dBi)	Peak PSD Limit (dBm /3kHz)	Pass/Fail
BLE	1Mbps	1	0	2402	7.72	-6.81	-5.00	8.00	Pass
BLE	1Mbps	1	19	2440	6.80	-7.74	-5.00	8.00	Pass
BLE	1Mbps	1	39	2480	7.31	-7.42	-5.00	8.00	Pass

Note: PSD (dBm/ 100kHz) is a reference level used for Conducted Band Edges and Conducted Spurious Emission 20dBc limit.

**Bluetooth v5.0 Low Energy**

Test Engineer:	Aly Cao	Temperature:	20~26	°C
Test Date:	2019/11/19	Relative Humidity:	40~51	%

**TEST RESULTS DATA**  
**6dB and 99% Occupied Bandwidth**

Mod.	Data Rate	NTX	CH.	Freq. (MHz)	99% Occupied BW (MHz)	6dB BW (MHz)	6dB BW Limit (MHz)	Pass/Fail
BLE	2Mbps	1	0	1000	2.033	1.13	0.50	Pass
BLE	2Mbps	1	19	2440	2.028	1.14	0.50	Pass
BLE	2Mbps	1	39	2480	2.028	1.14	0.50	Pass

**TEST RESULTS DATA**  
**Peak Power Table**

Mod.	Data Rate	NTX	CH.	Freq. (MHz)	Peak Conducted Power (dBm)	Conducted Power Limit (dBm)	DG (dBi)	EIRP Power (dBm)	EIRP Power Limit (dBm)	Pass /Fail
BLE	2Mbps	1	0	2402	7.84	30.00	-5.00	2.84	36.00	Pass
BLE	2Mbps	1	19	2440	7.54	30.00	-5.00	2.54	36.00	Pass
BLE	2Mbps	1	39	2480	7.90	30.00	-5.00	2.90	36.00	Pass

**TEST RESULTS DATA**  
**Average Power Table**  
**(Reporting Only)**

Mod.	Data Rate	NTX	CH.	Freq. (MHz)	Duty Factor (dB)	Average Conducted Power (dBm)
BLE	2Mbps	1	0	2402	4.83	7.59
BLE	2Mbps	1	19	2440	4.83	7.11
BLE	2Mbps	1	39	2480	4.83	7.66

**TEST RESULTS DATA**  
**Peak Power Density**

Mod.	Data Rate	NTX	CH.	Freq. (MHz)	Peak PSD (dBm /100kHz)	Peak PSD (dBm /3kHz)	DG (dBi)	Peak PSD Limit (dBm /3kHz)	Pass/Fail
BLE	2Mbps	1	0	2402	7.19	-11.01	-5.00	8.00	Pass
BLE	2Mbps	1	19	2440	6.89	-11.31	-5.00	8.00	Pass
BLE	2Mbps	1	39	2480	7.37	-10.75	-5.00	8.00	Pass

Note: PSD (dBm/ 100kHz) is a reference level used for Conducted Band Edges and Conducted Spurious Emission 20dBc limit.



## Appendix B. AC Conducted Emission Test Results

Test Engineer :	Amos Zhang	Temperature :	25.3~26.2°C
		Relative Humidity :	38~40%
Test Voltage :	120Vac / 60Hz	Phase :	Line

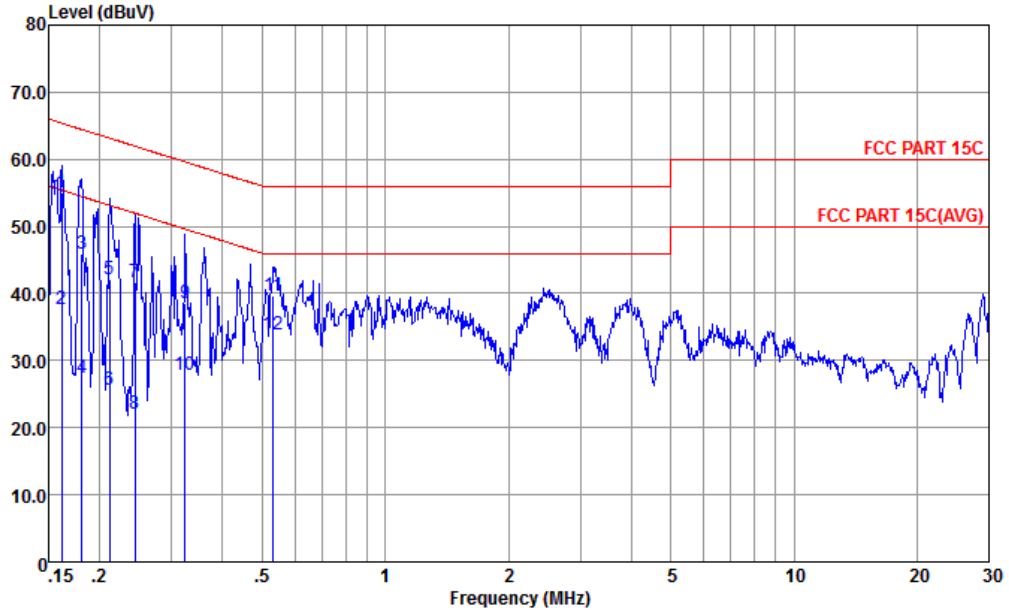

Site : CO01-KS  
 Condition : FCC PART 15C LISN-L-181119-060105 LINE

	Freq	Level	Over	Limit	Read	LISN	Cable	Remark
	MHz	dBuV	dB	dBuV	dBuV	dB	dB	
1 *	0.162	55.15	-10.23	65.38	44.60	0.10	10.45	QP
2	0.162	37.75	-17.63	55.38	27.20	0.10	10.45	Average
3	0.181	46.01	-18.45	64.46	35.50	0.11	10.40	QP
4	0.181	27.41	-27.05	54.46	16.90	0.11	10.40	Average
5	0.212	42.08	-21.06	63.14	31.60	0.12	10.36	QP
6	0.212	25.58	-27.56	53.14	15.10	0.12	10.36	Average
7	0.244	41.67	-20.28	61.95	31.20	0.13	10.34	QP
8	0.244	22.07	-29.88	51.95	11.60	0.13	10.34	Average
9	0.323	38.64	-20.98	59.62	28.19	0.15	10.30	QP
10	0.323	27.94	-21.68	49.62	17.49	0.15	10.30	Average
11	0.532	39.61	-16.39	56.00	29.20	0.17	10.24	QP
12	0.532	33.91	-12.09	46.00	23.50	0.17	10.24	Average





Test Engineer :	Amos Zhang	Temperature :	25.3~26.2°C
		Relative Humidity :	38~40%
Test Voltage :	120Vac / 60Hz	Phase :	Neutral

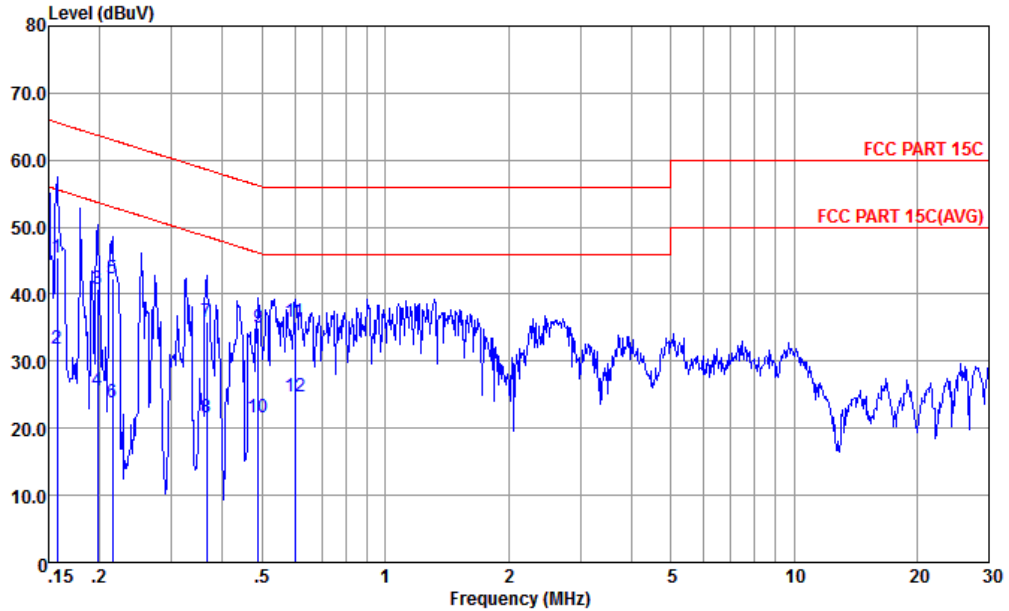

Site : CO01-KS  
 Condition : FCC PART 15C LISN-N-181119-060105 NEUTRAL

	Freq	Level	Over	Limit	Read	LISN	Cable	
	MHz	dBuV	Limit	Line	Level	Factor	Loss	Remark
			dB	dBuV	dBuV	dB	dB	
1 *	0.157	45.54	-20.06	65.60	34.90	0.18	10.46	QP
2	0.157	31.84	-23.76	55.60	21.20	0.18	10.46	Average
3	0.198	40.74	-22.97	63.71	30.20	0.17	10.37	QP
4	0.198	25.64	-28.07	53.71	15.10	0.17	10.37	Average
5	0.215	42.43	-20.58	63.01	31.91	0.17	10.35	QP
6	0.215	23.83	-29.18	53.01	13.31	0.17	10.35	Average
7	0.365	35.94	-22.67	58.61	25.50	0.16	10.28	QP
8	0.365	21.64	-26.97	48.61	11.20	0.16	10.28	Average
9	0.489	34.89	-21.30	56.19	24.50	0.15	10.24	QP
10	0.489	21.69	-24.50	46.19	11.30	0.15	10.24	Average
11	0.601	35.88	-20.12	56.00	25.50	0.14	10.24	QP
12	0.601	24.68	-21.32	46.00	14.30	0.14	10.24	Average

Note:

- Level(dBμV) = Read Level(dBμV) + LISN Factor(dB) + Cable Loss(dB)
- Over Limit(dB) = Level(dBμV) – Limit Line(dBμV)



## Appendix C. Radiated Spurious Emission

Bluetooth v4.2 LE:

2.4GHz 2400~2483.5MHz

BLE (Band Edge @ 3m)

BLE	Note	Frequency	Level	Over Limit	Limit Line	Read Level	Antenna Factor	Cable Loss	Preamp Factor	Ant Pos	Table Pos	Peak Avg.	Pol.
		( MHz )	( dBμV/m )	( dB )	( dBμV/m )	( dBμV )	( dB/m )	( dB )	( dB )	( cm )	( deg )	( P/A )	( H/V )
BLE CH 00 2402MHz		2370.45	55.14	-18.86	74	47.98	32.03	6.55	31.42	102	158	P	H
		2375	45.03	-8.97	54	37.87	32.03	6.55	31.42	102	158	A	H
	*	2402	97.13	-	-	89.95	32	6.59	31.41	102	158	P	H
	*	2402	96.67	-	-	89.49	32	6.59	31.41	102	158	A	H
		2362.91	54.7	-19.3	74	47.51	32.07	6.55	31.43	376	88	P	V
		2360.31	44.77	-9.23	54	37.58	32.07	6.55	31.43	376	88	A	V
	*	2402	94.61	-	-	87.43	32	6.59	31.41	376	88	P	V
	*	2402	94.14	-	-	86.96	32	6.59	31.41	376	88	A	V
BLE CH 39 2480MHz		2495.02	55.6	-18.4	74	47.97	32.2	6.81	31.38	101	151	P	H
		2483.5	45.75	-8.25	54	38.06	32.27	6.81	31.39	101	151	A	H
	*	2480	97.51	-	-	89.82	32.27	6.81	31.39	101	151	P	H
	*	2480	97.08	-	-	89.39	32.27	6.81	31.39	101	151	A	H
		2490.16	54.79	-19.21	74	47.17	32.2	6.81	31.39	297	91	P	V
		2483.5	45.65	-8.35	54	37.96	32.27	6.81	31.39	297	91	A	V
	*	2480	96.9	-	-	89.21	32.27	6.81	31.39	297	91	P	V
	*	2480	96.46	-	-	88.77	32.27	6.81	31.39	297	91	A	V
Remark	<ol style="list-style-type: none"> <li>No other spurious found.</li> <li>All results are PASS against Peak and Average limit line.</li> </ol>												



2.4GHz 2400~2483.5MHz

BLE (Harmonic @ 3m)

BLE	Note	Frequency ( MHz )	Level ( dBμV/m )	Over Limit ( dB )	Limit Line ( dBμV/m )	Read Level ( dBμV )	Antenna Factor ( dB/m )	Cable Loss ( dB )	Preamp Factor ( dB )	Ant Pos ( cm )	Table Pos ( deg )	Peak Avg. ( P/A )	Pol. ( H/V )
BLE CH 00 2402MHz		4806	41.43	-32.57	74	58.33	34.2	10.49	61.59	100	360	P	H
		4806	41.69	-32.31	74	58.59	34.2	10.49	61.59	100	360	P	V
BLE CH 19 2440MHz		4878	42.32	-31.68	74	59.22	34.13	10.58	61.61	100	360	P	H
		7320	42.74	-31.26	74	54.86	36.6	13.62	62.34	100	360	P	H
		4878	41.99	-32.01	74	58.89	34.13	10.58	61.61	100	360	P	V
		7320	42.42	-31.58	74	54.54	36.6	13.62	62.34	100	360	P	V
BLE CH 39 2480MHz		4962	41.08	-32.92	74	57.94	34.1	10.68	61.64	100	360	P	H
		7440	41.77	-32.23	74	54.19	36.4	13.58	62.4	100	360	P	H
		4962	41.77	-32.23	74	58.63	34.1	10.68	61.64	100	360	P	V
		7440	41.68	-32.32	74	54.1	36.4	13.58	62.4	100	360	P	V
Remark	1. No other spurious found. 2. All results are PASS against Peak and Average limit line.												



Emission below 1GHz

2.4GHz BLE (LF)

BLE	Note	Frequency	Level	Over	Limit	Read	Antenna	Cable	Preamp	Ant	Table	Peak	Pol.
				Limit	Line	Level	Factor	Loss	Factor	Pos	Pos	Avg.	
		( MHz )	( dBμV/m )	( dB )	( dBμV/m )	( dBμV )	( dB/m )	( dB )	( dB )	( cm )	( deg )	( P/A )	( H/V )
2.4GHz BLE LF		75.59	19.17	-20.83	40	37.92	12.7	0.87	32.32	-	-	P	H
		117.3	31.2	-12.3	43.5	44.26	18.01	1.1	32.17	100	360	P	H
		195.87	24.77	-18.73	43.5	39.73	15.54	1.51	32.01	-	-	P	H
		255.04	24.77	-21.23	46	35.61	19.23	1.74	31.81	-	-	P	H
		714.82	23.66	-22.34	46	27.54	25.07	2.85	31.8	-	-	P	H
		924.34	27.86	-18.14	46	29.37	26.74	3.3	31.55	-	-	P	H
		31.94	31.03	-8.97	40	40.1	22.94	0.59	32.6	100	360	P	V
		108.57	19.58	-23.92	43.5	33.24	17.46	1.06	32.18	-	-	P	V
		195.87	28.48	-15.02	43.5	43.44	15.54	1.51	32.01	-	-	P	V
		259.89	28.71	-17.29	46	38.98	19.8	1.75	31.82	-	-	P	V
		521.79	24.07	-21.93	46	29.54	23.73	2.44	31.64	-	-	P	V
	935.98	28.38	-17.62	46	29.73	26.86	3.32	31.53	-	-	P	V	
Remark	1. No other spurious found. 2. All results are PASS against limit line.												



Bluetooth v5.0 LE:

2.4GHz 2400~2483.5MHz

BLE (Band Edge @ 3m)

BLE	Note	Frequency	Level	Over Limit	Limit Line	Read Level	Antenna Factor	Cable Loss	Preamp Factor	Ant Pos	Table Pos	Peak Avg.	Pol.
		( MHz )	( dBμV/m )	( dB )	( dBμV/m )	( dBμV )	( dB/m )	( dB )	( dB )	( cm )	( deg )	( P/A )	( H/V )
BLE CH 00 2402MHz		2378.77	54.95	-19.05	74	47.79	32.03	6.55	31.42	100	158	P	H
		2385.66	45.6	-8.4	54	38.43	32	6.59	31.42	100	158	A	H
	*	2402	97.6	-	-	90.42	32	6.59	31.41	100	158	P	H
	*	2402	96.28	-	-	89.1	32	6.59	31.41	100	158	A	H
		2318.84	55.44	-18.56	74	48.41	31.97	6.5	31.44	225	99	P	V
		2389.3	45.52	-8.48	54	38.35	32	6.59	31.42	225	99	A	V
	*	2402	95.65	-	-	88.47	32	6.59	31.41	225	99	P	V
	*	2402	94.36	-	-	87.18	32	6.59	31.41	225	99	A	V
BLE CH 39 2480MHz		2483.5	56.13	-17.87	74	48.44	32.27	6.81	31.39	100	32	P	H
		2483.5	47.49	-6.51	54	39.8	32.27	6.81	31.39	100	32	A	H
	*	2480	98.49	-	-	90.8	32.27	6.81	31.39	100	32	P	H
	*	2480	97.16	-	-	89.47	32.27	6.81	31.39	100	32	A	H
		2491.24	56.28	-17.72	74	48.66	32.2	6.81	31.39	257	102	P	V
		2483.5	47.29	-6.71	54	39.6	32.27	6.81	31.39	257	102	A	V
	*	2480	97.67	-	-	89.98	32.27	6.81	31.39	257	102	P	V
	*	2480	96.32	-	-	88.63	32.27	6.81	31.39	257	102	A	V
Remark	1. No other spurious found. 2. All results are PASS against Peak and Average limit line.												



2.4GHz 2400~2483.5MHz
BLE (Harmonic @ 3m)

Table with 14 columns: BLE, Note, Frequency (MHz), Level (dBµV/m), Over Limit (dB), Limit Line (dBµV/m), Read Level (dBµV), Antenna Factor (dB/m), Cable Loss (dB), Preamp Factor (dB), Ant Pos (cm), Table Pos (deg), Peak Avg. (P/A), Pol. (H/V). Rows include BLE CH 00 2402MHz, BLE CH 19 2440MHz, and BLE CH 39 2480MHz.



Emission below 1GHz

2.4GHz BLE (LF)

BLE	Note	Frequency	Level	Over	Limit	Read	Antenna	Cable	Preamp	Ant	Table	Peak	Pol.
		( MHz )	( dBμV/m )	( dB )	( dBμV/m )	( dBμV )	( dB/m )	( dB )	( dB )	( cm )	( deg )	( P/A )	( H/V )
2.4GHz BLE LF		30	22.41	-17.59	40	30.34	24.1	0.57	32.6	-	-	P	H
		49.4	18.65	-21.35	40	36.13	14.3	0.7	32.48	-	-	P	H
		75.59	19.17	-20.83	40	37.92	12.7	0.87	32.32	-	-	P	H
		117.3	31.2	-12.3	43.5	44.26	18.01	1.1	32.17	100	0	P	H
		221.09	22.55	-23.45	46	37.45	15.4	1.62	31.92	-	-	P	H
		258.92	24.45	-21.55	46	34.83	19.69	1.75	31.82	-	-	P	H
		31.94	31.03	-8.97	40	40.1	22.94	0.59	32.6	100	360	P	V
		72.68	21.02	-18.98	40	39.74	12.7	0.84	32.26	-	-	P	V
		143.49	24.4	-19.1	43.5	38.27	17.01	1.23	32.11	-	-	P	V
		195.87	28.48	-15.02	43.5	43.44	15.54	1.51	32.01	-	-	P	V
		221.09	30.45	-15.55	46	45.35	15.4	1.62	31.92	-	-	P	V
	259.89	28.71	-17.29	46	38.98	19.8	1.75	31.82	-	-	P	V	
Remark	<ol style="list-style-type: none"> <li>No other spurious found.</li> <li>All results are PASS against limit line.</li> </ol>												



Note symbol

*	<b>Fundamental Frequency</b> which can be ignored. However, the level of any unwanted emissions shall not exceed the level of the fundamental frequency.
!	Test result is <b>over limit</b> line.
P/A	<b>Peak</b> or <b>Average</b>
H/V	<b>Horizontal</b> or <b>Vertical</b>





A calculation example for radiated spurious emission is shown as below:

WIFI	Note	Frequency	Level	Over	Limit	Read	Antenna	Cable	Preamp	Ant	Table	Peak	Pol.
Ant.				Limit	Line	Level	Factor	Loss	Factor	Pos	Pos	Avg.	
1+2		( MHz )	( dBμV/m )	( dB )	( dBμV/m )	( dBμV )	( dB/m )	( dB )	( dB )	( cm )	( deg )	( P/A )	( H/V )
802.11b		2390	55.45	-18.55	74	54.51	32.22	4.58	35.86	103	308	P	H
CH 01													
2412MHz		2390	43.54	-10.46	54	42.6	32.22	4.58	35.86	103	308	A	H

- Level(dBμV/m) =  
Antenna Factor(dB/m) + Cable Loss(dB) + Read Level(dBμV) - Preamp Factor(dB)
- Over Limit(dB) = Level(dBμV/m) – Limit Line(dBμV/m)

**For Peak Limit @ 2390MHz:**

- Level(dBμV/m)  
= Antenna Factor(dB/m) + Cable Loss(dB) + Read Level(dBμV) - Preamp Factor(dB)  
= 32.22(dB/m) + 4.58(dB) + 54.51(dBμV) – 35.86 (dB)  
= 55.45 (dBμV/m)
- Over Limit(dB)  
= Level(dBμV/m) – Limit Line(dBμV/m)  
= 55.45(dBμV/m) – 74(dBμV/m)  
= -18.55(dB)

**For Average Limit @ 2390MHz:**

- Level(dBμV/m)  
= Antenna Factor(dB/m) + Cable Loss(dB) + Read Level(dBμV) - Preamp Factor(dB)  
= 32.22(dB/m) + 4.58(dB) + 42.6(dBμV) – 35.86 (dB)  
= 43.54 (dBμV/m)
- Over Limit(dB)  
= Level(dBμV/m) – Limit Line(dBμV/m)  
= 43.54(dBμV/m) – 54(dBμV/m)  
= -10.46(dB)

Both peak and average measured complies with the limit line, so test result is “PASS”.



## Appendix D. Duty Cycle Plots

Band	Duty Cycle(%)	T(ms)	1/T(KHz)	VBW Setting
Bluetooth v4.2 LE	62.50	0.3913	2.5556	2.7kHz
Bluetooth v5.0 LE	32.87	0.2058	4.8591	5.1kHz

### Bluetooth v4.2 LE

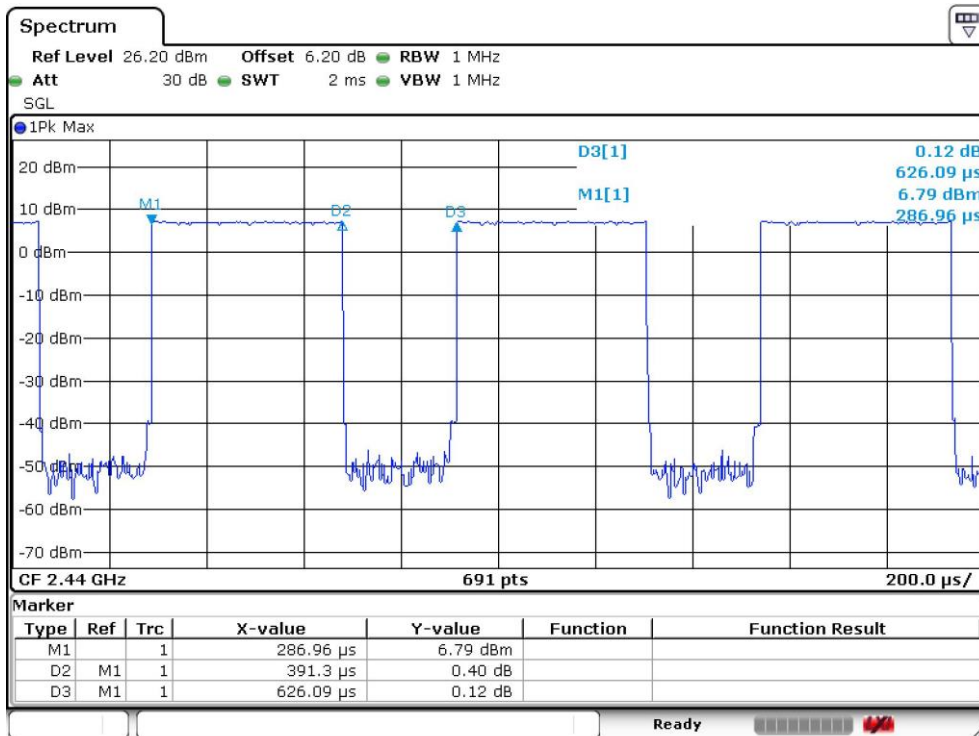



Bluetooth v5.0 LE

