



FCC RF Test Report

APPLICANT : Motorola Mobility LLC
EQUIPMENT : Mobile Cellular Phone
BRAND NAME : Motorola
MODEL NAME : XT2043-7
FCC ID : IHDT56YN2
STANDARD : FCC Part 15 Subpart C §15.225
CLASSIFICATION : (DX) Low Power Communication Device Transmitter

The product was received on Jan. 16, 2020 and testing was completed on Mar. 14, 2020. We, Sporton International (Kunshan) Inc., would like to declare that the tested sample has been evaluated in accordance with the test procedures and has been in compliance with the applicable technical standards.

The test results in this report apply exclusively to the tested model / sample. Without written approval of Sporton International (Kunshan) Inc., the test report shall not be reproduced except in full.

Jason Jia

Reviewed by: Jason Jia / Supervisor

James Huang

Approved by: James Huang / Manager



Sporton International (Kunshan) Inc.

**No. 1098, Pengxi North Road, Kunshan Economic Development Zone Jiangsu Province 215300
People's Republic of China**



TABLE OF CONTENTS

TABLE OF CONTENTS2
REVISION HISTORY3
SUMMARY OF THE TEST RESULT4
1. GENERAL DESCRIPTION5
 1.1 Applicant..... 5
 1.2 Manufacturer 5
 1.3 Product Feature of Equipment Under Test 5
 1.4 Product Specification of Equipment Under Test 6
 1.5 Modification of EUT 6
 1.6 Specification of Accessory..... 6
 1.7 Testing Location 7
 1.8 Test Software 7
 1.9 Applicable Standards..... 8
2. TEST CONFIGURATION OF EQUIPMENT UNDER TEST9
 2.1 Descriptions of Test Mode 9
 2.2 Connection Diagram of Test System 9
 2.3 Table for Supporting Units 11
 2.4 EUT Operation Test Setup 11
3. TEST RESULTS.....12
 3.1 AC Power Line Conducted Emissions Measurement 12
 3.2 20dB and 99% OBW Spectrum Bandwidth Measurement..... 14
 3.3 Frequency Stability Measurement 15
 3.4 Field Strength of Fundamental Emissions and Mask Measurement..... 16
 3.5 Radiated Emissions Measurement 18
 3.6 Antenna Requirements..... 21
4. LIST OF MEASURING EQUIPMENT22
5. UNCERTAINTY OF EVALUATION23
APPENDIX A. TEST RESULTS OF CONDUCTED EMISSION TEST
APPENDIX B. TEST RESULTS OF CONDUCTED TEST ITEMS
 B1. Test Result of 20dB Spectrum Bandwidth
 B2. Test Result of Frequency Stability
APPENDIX C. TEST RESULTS OF RADIATED TEST ITEMS
 C1. Test Result of Field Strength of Fundamental Emissions
 C2. Results of Radiated Emissions (9 kHz~30MHz)
 C3. Results of Radiated Emissions (30MHz~1GHz)
APPENDIX D. SETUP PHOTOGRAPHS



SUMMARY OF THE TEST RESULT

Report Section	FCC Rule	Description of Test	Result	Remark
3.1	15.207	AC Power Line Conducted Emissions	Complies	Under limit 5.06 dB at 0.199MHz
3.2	15.215(c)	20dB Spectrum Bandwidth	Complies	-
	-	99% OBW Spectrum Bandwidth	Complies	-
3.3	15.225(e)	Frequency Stability	Complies	-
3.4	15.225(a)(b)(c)	Field Strength of Fundamental Emissions	Complies	Max level 54.86 dBμV/m at 13.560 MHz
3.5	15.225(d) & 15.209	Radiated Spurious Emissions	Complies	Under limit 13.98 dB at 40.670MHz
3.6	15.203	Antenna Requirements	Complies	-

Declaration of Conformity:
The test results with all measurement uncertainty excluded are presented in accordance with the regulation limits or requirements declared by manufacturers.
Comments and Explanations:
The declared of product specification for EUT presented in the report are provided by the manufacturer, and the manufacturer takes all the responsibilities for the accuracy of product specification.



1. General Description

1.1 Applicant

Motorola Mobility LLC

222 W,Merchandise Mart Plaza, Chicago IL 60654 USA

1.2 Manufacturer

Motorola Mobility LLC

222 W,Merchandise Mart Plaza, Chicago IL 60654 USA

1.3 Product Feature of Equipment Under Test

Product Feature	
Equipment	Mobile Cellular Phone
Brand Name	Motorola
Model Name	XT2043-7
FCC ID	IHDT56YN2
EUT supports Radios application	GSM/WCDMA/LTE/NFC WLAN 2.4GHz 802.11b/g/n HT20 WLAN 5GHz 802.11a/n HT20/HT40 WLAN 5GHz 802.11ac VHT20/VHT40/VHT80 Bluetooth BR/EDR/LE FM Receiver and GNSS
HW Version	DVT2
SW Version	QPR30.104
EUT Stage	Identical Prototype

Remark:

1. The above EUT's information was declared by manufacturer. Please refer to the specifications or user's manual for more detailed description.
2. There are four types of EUT, the sample 1/2 with dual SIM slot and the sample 3/4 with single SIM slot, the sample 1/3 are the 1st source, the sample 2/4 are the 2nd source, please refer to the product equality declaration exhibit separately. The difference between 1st source and 2nd source is different suppliers for the battery, we only choose sample 1 to perform full tests



1.4 Product Specification of Equipment Under Test

Standards-related Product Specification	
Tx/Rx Frequency Range	13.553 ~ 13.567MHz
Channel Number	1
20dBW	2.504KHz
99%OBW	2.113KHz
Antenna Type	Loop Antenna
Type of Modulation	ASK

Remark: The above EUT's information was declared by manufacturer. Please refer to the specifications or user's manual for more detailed description.

1.5 Modification of EUT

No modifications are made to the EUT during all test items.

1.6 Specification of Accessory

Specification of Accessory			
AC Adapter 1(US)	Brand Name	Motorola(Chenyang)	Model Name SC-51
	Power Rating	I/P: 100-240 Vac, 600mA , O/P: 5/9/12Vdc, 3000/2000/1500mA	
AC Adapter 1(EU)	Brand Name	Motorola(Chenyang)	Model Name SC-52
	Power Rating	I/P: 100-240 Vac, 600mA , O/P: 5/9/12Vdc, 3000/2000/1500mA	
AC Adapter 1(UK)	Brand Name	Motorola(Chenyang)	Model Name SC-53
	Power Rating	I/P: 100-240 Vac, 600mA , O/P: 5/9/12Vdc, 3000/2000/1500mA	
AC Adapter 1(AU)	Brand Name	Motorola(Chenyang)	Model Name SC-55
	Power Rating	I/P: 100-240 Vac, 600mA , O/P: 5/9/12Vdc, 3000/2000/1500mA	
AC Adapter 1(AR)	Brand Name	Motorola(Chenyang)	Model Name SC-56
	Power Rating	I/P: 100-240 Vac, 600mA , O/P: 5/9/12Vdc, 3000/2000/1500mA	
AC Adapter 2(US)	Brand Name	Motorola(Acbel)	Model Name SC-51
	Power Rating	I/P: 100-240 Vac, 600mA , O/P: 5/9/12Vdc, 3000/2000/1500mA	
AC Adapter 2(EU)	Brand Name	Motorola(Acbel)	Model Name SC-52
	Power Rating	I/P: 100-240 Vac, 600mA , O/P: 5/9/12Vdc, 3000/2000/1500mA	
AC Adapter 2(AR)	Brand Name	Motorola(Acbel)	Model Name SC-56
	Power Rating	I/P: 100-240 Vac, 600mA , O/P: 5/9/12Vdc, 3000/2000/1500mA	
AC Adapter 3 (Chile)	Brand Name	Motorola(Salom)	Model Name SC-52
	Power Rating	I/P: 100-240 Vac, 600mA , O/P: 5/9/12Vdc, 3000/2000/1500mA	
AC Adapter 3(BR)	Brand Name	Motorola(Salom)	Model Name SC-57
	Power Rating	I/P: 100-240 Vac, 600mA , O/P: 5/9/12Vdc, 3000/2000/1500mA	



Battery 1	Brand Name	Motorola (Amperex)	Model Name	KX50
	Power Rating	3.8Vdc, 4000mAh	Type	Li-ion
Battery 2	Brand Name	Motorola (SUNWODA)	Model Name	KX50
	Power Rating	3.8Vdc, 4000mAh	Type	Li-ion
USB Cable 1	Brand Name	Motorola (Luxshare)	Model Name	SC18C24368
	Signal Line Type	1.0 meter, shielded cable, without ferrite core		
USB Cable 2	Brand Name	Motorola (Saibao)	Model Name	SC18C24367
	Signal Line Type	1.0 meter, shielded cable, without ferrite core		

1.7 Testing Location

Sporton International (Kunshan) Inc. is accredited to ISO/IEC 17025:2017 by American Association for Laboratory Accreditation with Certificate Number 5145.02.

Test Site	Sporton International (Kunshan) Inc.				
Test Site Location	No. 1098, Pengxi North Road, Kunshan Economic Development Zone Jiangsu Province 215300 People's Republic of China TEL : +86-512-57900158 FAX : +86-512-57900958				
Test Site No.	Sporton Site No.			FCC Designation No.	FCC Test Firm Registration No.
	TH01-KS	03CH02-KS	CO01-KS	CN1257	314309
Test Engineer	LayLI	Jack Guo	Amos Zhang		
Temperature	22-24°C	21~22°C	25.3~26.2°C		
Relative Humidity	53-55%	41~42%	38~40%		

1.8 Test Software

Item	Site	Manufacture	Name	Version
1.	03CH02-KS	AUDIX	E3	6.2009-8-24a
2.	CO01-KS	AUDIX	E3	6.2009-8-24



1.9 Applicable Standards

According to the specifications of the manufacturer, the EUT must comply with the requirements of the following standards:

- ♦ 47 CFR Part 15 Subpart C §15.225
- ♦ ANSI C63.10-2013

2. Test Configuration of Equipment Under Test

2.1 Descriptions of Test Mode

Investigation has been done on all the possible configurations.

The following table is a list of the test modes shown in this test report.

Test Items	
AC Power Line Conducted Emissions	Field Strength of Fundamental Emissions
20dB Spectrum Bandwidth	Frequency Stability
Radiated Emissions 9kHz~30MHz	Radiated Emissions 30MHz~1GHz

The EUT pre-scanned in four NFC type, A, B, F, V. The worst type (type A) was recorded in this report. Pre-scanned tests, X, Y, Z in three orthogonal panels to determine the final configuration (Z plane as worst plane) from all possible combinations.

Test Cases	
AC Conducted Emission	Mode 1: GSM 850 Idle + Bluetooth Link + WLAN Link (2.4G) + NFC Tx + USB Cable (Charging from Adapter 2) + Earphone

2.2 Connection Diagram of Test System

For Radiation

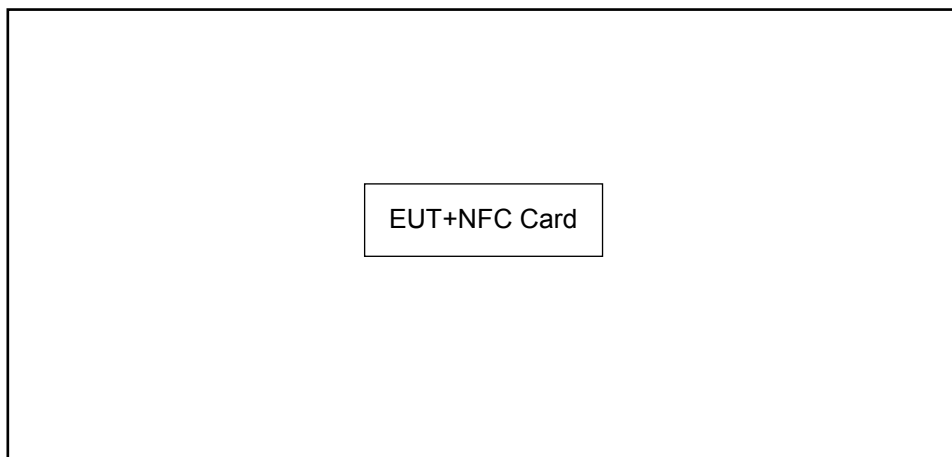

For Conducted Emission

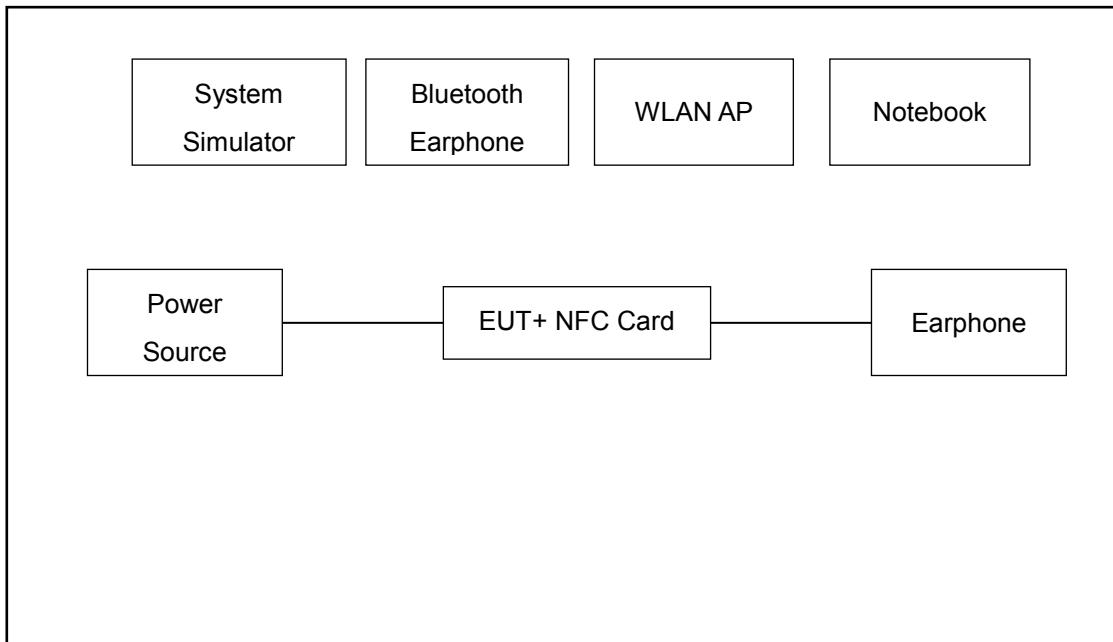

2.3 Table for Supporting Units

Item	Equipment	Trade Name	Model Name	FCC ID	Data Cable	Power Cord
1.	System Simulator	Anritsu	MT8820C	N/A	N/A	Unshielded, 1.8m
2.	Bluetooth Earphone	Lenovo	LBH308	N/A	N/A	N/A
3.	WLAN AP	D-link	DIR-655	KA21R655B1	N/A	Unshielded, 1.8m
4.	NFC Card	N/A	N/A	N/A	N/A	N/A
5.	Notebook	Lenovo	G480	QDS-BRCM1050I	N/A	AC I/P: Unshielded, 1.8 m DC O/P: Shielded, 1.8 m

2.4 EUT Operation Test Setup

The EUT was programmed to be in continuously transmitting mode.

The ancillary equipment, NFC card, is used to make the EUT (NFC) continuously transmit at 13.56MHz and is placed around 3 cm gap to the EUT.

3. Test Results

3.1 AC Power Line Conducted Emissions Measurement

3.1.1 Limit of AC Conducted Emission

For equipment that is designed to be connected to the public utility (AC) power line, the radio frequency voltage that is conducted back onto the AC power line on any frequency or frequencies within the band 150 kHz to 30 MHz shall not exceed the limits in the following table.

Frequency of Emission (MHz)	Conducted Limit (dB μ V)	
	Quasi-Peak	Average
0.15-0.5	66 to 56*	56 to 46*
0.5-5	56	46
5-30	60	50

*Decreases with the logarithm of the frequency.

3.1.2 Measuring Instruments

See list of measuring instruments of this test report.

3.1.3 Test Procedures

1. The EUT was placed 0.4 meter from the conducting wall of the shielding room, and it was kept at least 80 centimeters from any other grounded conducting surface.
2. Connect EUT to the power mains through a line impedance stabilization network (LISN).
3. All the support units are connecting to the other LISN.
4. The LISN provides 50 ohm coupling impedance for the measuring instrument.
5. The FCC states that a 50 ohm, 50 microhenry LISN should be used.
6. Both sides of AC line were checked for maximum conducted interference.
7. The frequency range from 150 kHz to 30 MHz was searched.
8. Set the test-receiver system to Peak Detect Function and specified bandwidth (IF Bandwidth = 9kHz) with Maximum Hold Mode. Then measurement is also conducted by Average Detector and Quasi-Peak Detector Function respectively.

3.1.4 Test setup

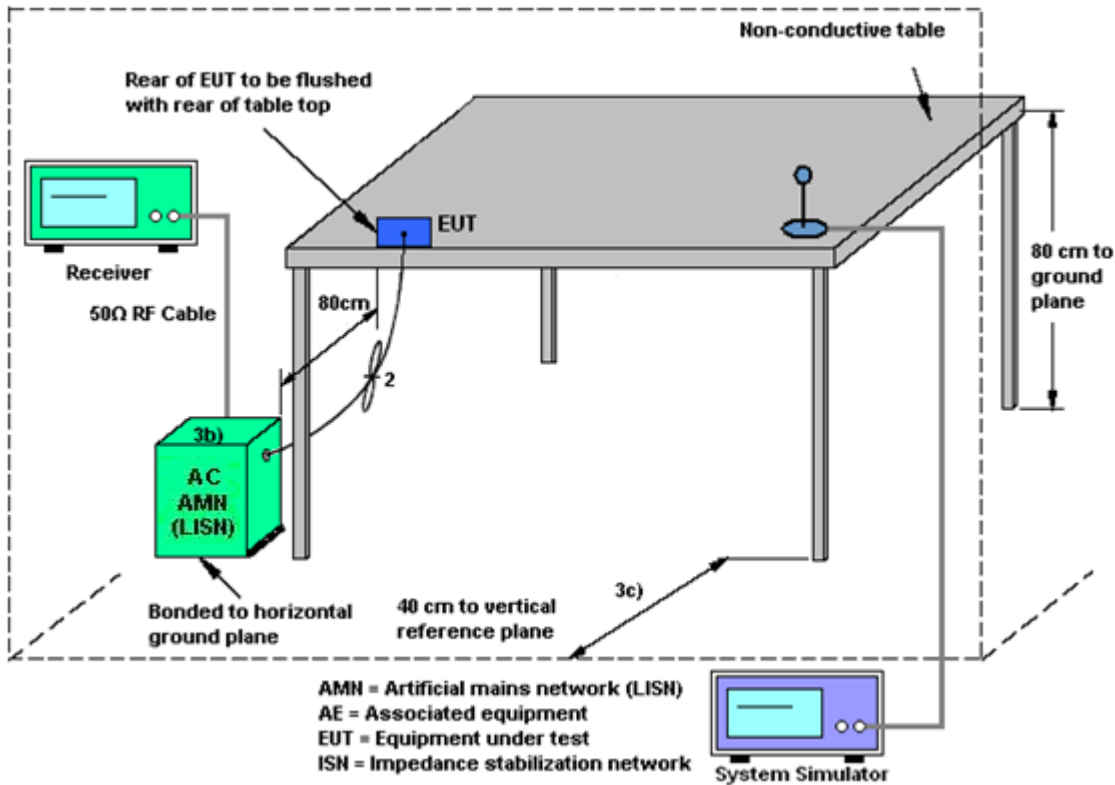

3.1.5 Test Result of AC Conducted Emission

Please refer to Appendix A.

3.2 20dB and 99% OBW Spectrum Bandwidth Measurement

3.2.1 Limit

Intentional radiators must be designed to ensure that the 20dB and 99% emission bandwidth in the specific band 13.553~13.567MHz.

3.2.2 Measuring Instruments

See list of measuring instruments of this test report.

3.2.3 Test Procedures

1. The spectrum analyzer connected via a receive antenna placed near the EUT in peak Max hold mode.
2. The resolution bandwidth of 1 kHz and the video bandwidth of 3 kHz were used.
3. Measured the spectrum width with power higher than 20dB below carrier.
4. Measured the 99% OBW.

3.2.4 Test Setup

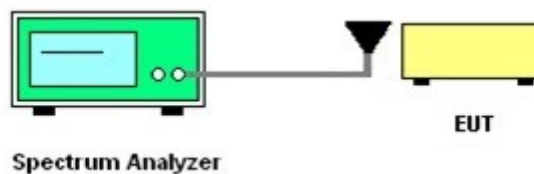

3.2.5 Test Result of Conducted Test Items

Please refer to Appendix B.

3.3 Frequency Stability Measurement

3.3.1 Limit

The frequency tolerance of the carrier signal shall be maintained within +/- 0.01% (100ppm) of the operating frequency over a temperature variation of -20 degrees to +50 degrees C at normal supply voltage, and for a variation in the primary supply voltage from 85% to 115% of the rated supply voltage at a temperature of 20 degrees C. For battery operated equipment, the equipment tests shall be performed using a new battery.

3.3.2 Measuring Instruments

See list of measuring instruments of this test report.

3.3.3 Test Procedures

1. The spectrum analyzer connected via a receive antenna placed near the EUT.
2. EUT have transmitted signal and fixed channelize.
3. Set the spectrum analyzer span to view the entire emissions bandwidth.
4. Set RBW = 1 kHz, VBW = 3 kHz with peak detector and maxhold settings.
5. The f_c is declaring of channel frequency. Then the frequency error formula is $(f_c - f) / f_c \times 10^6$ ppm and the limit is less than ± 100 ppm.
6. Extreme temperature rule is -20°C~50°C.

3.3.4 Test Setup

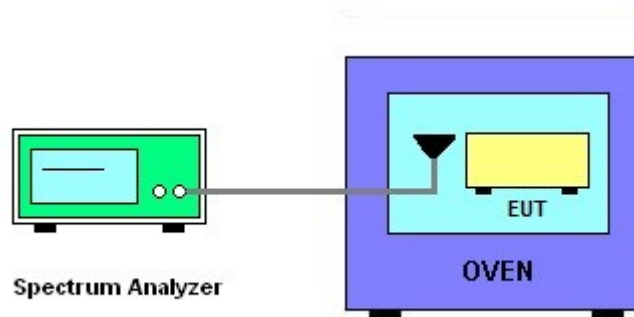

3.3.5 Test Result of Conducted Test Items

Please refer to Appendix B.



3.4 Field Strength of Fundamental Emissions and Mask Measurement

3.4.1 Limit

Rules and specifications	FCC CFR 47 Part 15 section 15.225			
Description	Compliance with the spectrum mask is tested with RBW set to 9kHz.			
Freq. of Emission (MHz)	Field Strength (μV/m) at 30m	Field Strength (dBμV/m) at 30m	Field Strength (dBμV/m) at 10m	Field Strength (dBμV/m) at 3m
1.705~13.110	30	29.5	48.58	69.5
13.110~13.410	106	40.5	59.58	80.5
13.410~13.553	334	50.5	69.58	90.5
13.553~13.567	15848	84.0	103.08	124.0
13.567~13.710	334	50.5	69.58	90.5
13.710~14.010	106	40.5	59.58	80.5
14.010~30.000	30	29.5	48.58	69.5

3.4.2 Measuring Instruments

See list of measuring instruments of this test report.

3.4.3 Test Procedures

1. Configure the EUT according to ANSI C63.10. The EUT was placed on the top of the turntable 0.8 meter above ground. The phase center of the loop receiving antenna mounted antenna tower was placed 3 meters far away from the turntable.
2. Power on the EUT and all the supporting units. The turntable was rotated by 360 degrees to determine the position of the highest radiation.
3. The height of the receiving antenna was fixed at one meter above ground to find the maximum emissions field strength.
4. For Fundamental emissions, use the receiver to measure QP reading.
5. When the radiated emissions limits are expressed in terms of the average value of the emissions, and pulsed operation is employed, the measurement field strength shall be determined by averaging over one complete pulse train, including blanking intervals, as long as the pulse train does not exceed 0.1 seconds. As an alternative (provided the transmitter operates for longer than 0.1 seconds) or in cases where the pulse train exceeds 0.1 seconds, the measured field strength shall be determined from the average absolute voltage during a 0.1 second interval during which the field strength is at its maximum value.
6. Compliance with the spectrum mask is tested with RBW set to 9kHz.

Note: Emission level (dB μ V/m) = 20 log Emission level (μ V/m).

3.4.4 Test Setup

For radiated emissions below 30MHz

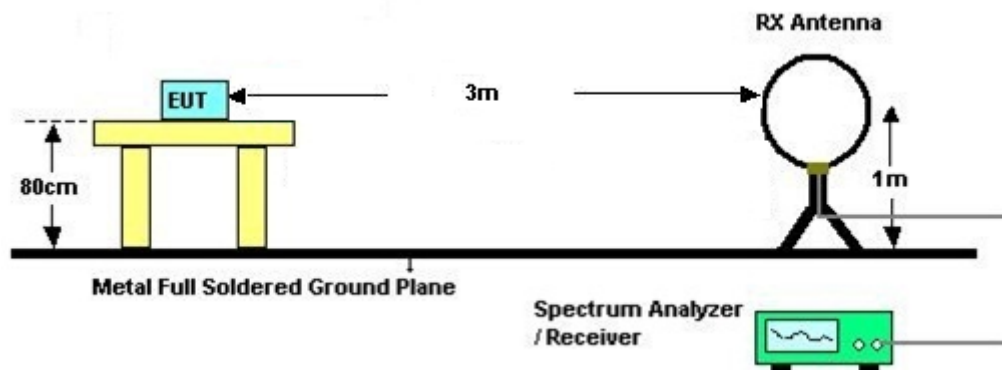

3.4.5 Test Result of Field Strength of Fundamental Emissions and Mask

Please refer to Appendix C.

3.5 Radiated Emissions Measurement

3.5.1 Limit

The field strength of any emissions which appear outside of 13.110 ~14.010MHz band shall not exceed the general radiated emissions limits.

Frequencies (MHz)	Field Strength ($\mu\text{V/m}$)	Measurement Distance (meters)
0.009~0.490	2400/F(kHz)	300
0.490~1.705	24000/F(kHz)	30
1.705~30.0	30	30
30~88	100	3
88~216	150	3
216~960	200	3
Above 960	500	3

3.5.2 Measuring Instruments

See list of measuring instruments of this test report.

3.5.3 Measuring Instrument Setting

The following table is the setting of receiver.

Receiver Parameter	Setting
Attenuation	Auto
Frequency Range: 9kHz~150kHz	RBW 200Hz for QP
Frequency Range: 150kHz~30MHz	RBW 9kHz for QP
Frequency Range: 30MHz~1000MHz	RBW 120kHz for Peak

Note: The emission limits shown in the above table are based on measurements employing a CISPR quasi-peak detector except for the frequency bands 9-90 kHz, 110-490 kHz. Radiated emission limits in these two bands are based on measurements employing an average detector.



3.5.4 Test Procedures

1. Configure the EUT according to ANSI C63.10. The EUT was placed on the top of the turntable 0.8 meter above ground. The phase center of the receiving antenna mounted on the top of a height-variable antenna tower was placed 3 meters far away from the turntable.
2. Power on the EUT and all the supporting units. The turntable was rotated by 360 degrees to determine the position of the highest radiation.
3. The height of the broadband receiving antenna was varied between one meter and four meters above ground to find the maximum emissions field strength of both horizontal and vertical polarization.
4. For each suspected emissions, the antenna tower was scan (from 1 M to 4 M) and then the turntable was rotated (from 0 degree to 360 degrees) to find the maximum reading.
5. Set the test-receiver system to Peak or CISPR quasi-peak Detect Function with specified bandwidth under Maximum Hold Mode.
6. When the radiated emissions limits are expressed in terms of the average value of the emissions, and pulsed operation is employed, the measurement field strength shall be determined by averaging over one complete pulse train, including blanking intervals, as long as the pulse train does not exceed 0.1 seconds. As an alternative (provided the transmitter operates for longer than 0.1 seconds) or in cases where the pulse train exceeds 0.1 seconds, the measured field strength shall be determined from the average absolute voltage during a 0.1 second interval during which the field strength is at its maximum value.
7. In case the emission is lower than 30MHz, loop antenna has to be used for measurement and the recorded data should be QP measured by receiver. Antenna Requirements

3.5.5 Test Setup

For radiated emissions below 30MHz

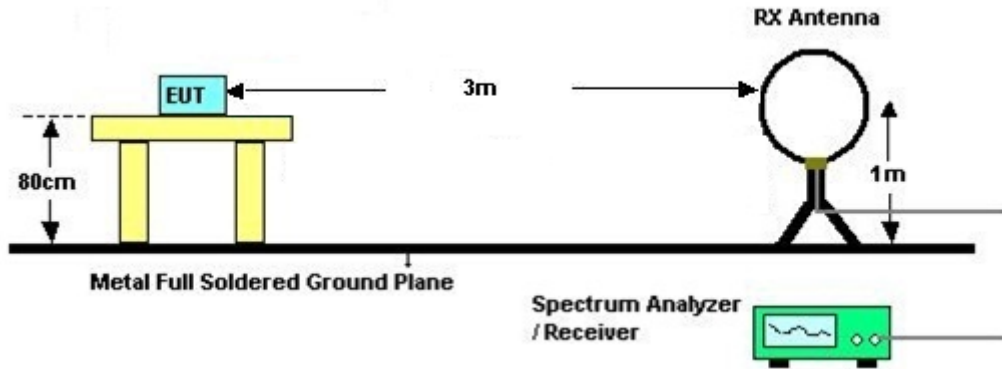

For radiated emissions above 30MHz

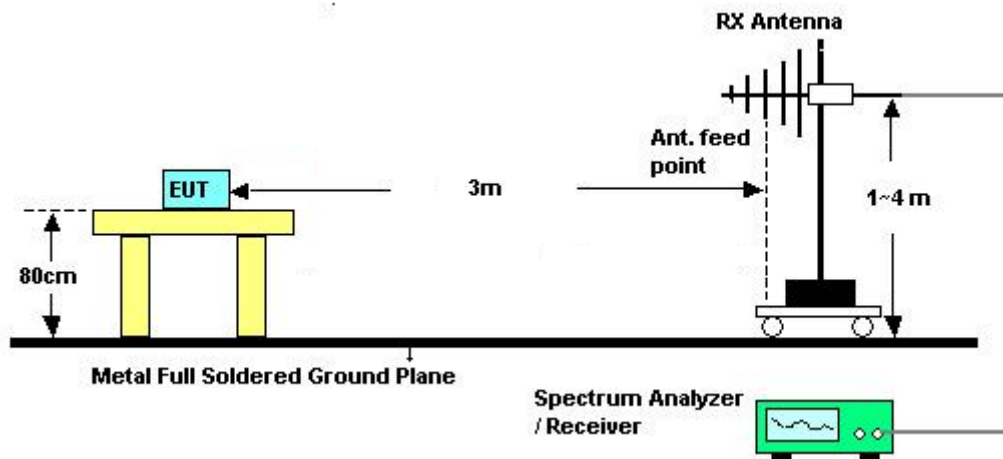

3.5.6 Test Result of Radiated Emissions Measurement

Please refer to Appendix C.

Remark: There is a comparison data of both open-field test site and semi-Anechoic chamber, and the result came out very similar.



3.6 Antenna Requirements

3.6.1 Standard Applicable

Except for special regulations, the Low-power Radio-frequency Devices must not be equipped with any jacket for installing an antenna with extension cable. An intentional radiator shall be designed to ensure that no antenna other than that furnished by the responsible party shall be used with the device. The use of a permanently attached antenna or of an antenna that uses a unique coupling to the intentional radiator shall be considered sufficient to comply with the provisions of this Section. The manufacturer may design the unit so that the user can replace a broken antenna, but the use of a standard antenna jack or electrical connector is prohibited.

The use of a permanently attached antenna or of an antenna that uses a unique coupling to the intentional radiator shall be considered sufficient to comply with the rule.

3.6.2 Antenna Anti-Replacement Construction

An embedded-in antenna design is used.



4. List of Measuring Equipment

Instrument	Manufacturer	Model No.	Serial No.	Characteristics	Calibration Date	Test Date	Due Date	Remark
Spectrum Analyzer	R&S	FSV40	101040	10Hz~40GHz	Nov. 02, 2019	Mar. 14, 2020	Nov. 01, 2020	Conducted (TH01-KS)
Thermal Chamber	Ten Billion	TTC-B3S	TBN-960502	-40~+150°C	Nov. 19, 2019	Mar. 14, 2020	Nov. 18, 2020	Conducted (TH01-KS)
EMI Test Receiver	R&S	ESR7	101403	9kHz~7GHz;Ma x 30dBm	Oct. 18, 2019	Mar. 18, 2020	Oct. 17, 2020	Radiation (03CH02-KS)
Loop Antenna	R&S	HFH2-Z2	100321	9kHz~30MHz	Nov. 10, 2019	Mar. 18, 2020	Nov. 09, 2020	Radiation (03CH02-KS)
Bilog Antenna	TeseQ	CBL6111D	49922	30MHz-1GHz	May 30, 2019	Mar. 18, 2020	May 29, 2020	Radiation (03CH02-KS)
Amplifier	SONOMA	310N	187289	9KHz-1GHz	Aug. 06, 2019	Mar. 18, 2020	Aug. 05, 2020	Radiation (03CH02-KS)
AC Power Source	Chroma	61601	616010002473	N/A	NCR	Mar. 18, 2020	NCR	Radiation (03CH02-KS)
Turn Table	MF	MF7802	N/A	0~360 degree	NCR	Mar. 18, 2020	NCR	Radiation (03CH02-KS)
Antenna Mast	MF	MF7802	N/A	1 m~4 m	NCR	Mar. 18, 2020	NCR	Radiation (03CH02-KS)
EMI Receiver	R&S	ESCI7	100768	9kHz~7GHz;	Apr. 16, 2019	Feb. 25, 2020	Apr. 15, 2020	Conduction (CO01-KS)
AC LISN (for auxiliary equipment)	MessTec	AN3016	060103	9kHz~30MHz	Oct. 18, 2019	Feb. 25, 2020	Oct. 17, 2020	Conduction (CO01-KS)
AC LISN	MessTec	AN3016	060105	9kHz~30MHz	Oct. 28, 2019	Feb. 25, 2020	Oct. 27, 2020	Conduction (CO01-KS)
AC Power Source	Chroma	61602	ABP000000811	AC 0V~300V, 45Hz~1000Hz	Oct. 18, 2019	Feb. 25, 2020	Oct. 17, 2020	Conduction (CO01-KS)

NCR: No Calibration Required



5. Uncertainty of Evaluation

The measurement uncertainties shown below were calculated in accordance with the requirements of ANSI 63.10-2013. All the measurement uncertainty value were shown with a coverage K=2 to indicate 95% level of confidence. The measurement data show herein meets or exceeds the CISPR measurement uncertainty values specified in CISPR 16-4-2 and can be compared directly to specified limit to determine compliance.

Uncertainty of Conducted Emission Measurement (150 kHz ~ 30 MHz)

Measuring Uncertainty for a Level of Confidence of 95% (U = 2Uc(y))	2.9dB
---	-------

Uncertainty of Radiated Emission Measurement (9 kHz ~ 30 MHz)

Measuring Uncertainty for a Level of Confidence of 95% (U = 2Uc(y))	4.9dB
---	-------

Uncertainty of Radiated Emission Measurement (30 MHz ~ 1000 MHz)

Measuring Uncertainty for a Level of Confidence of 95% (U = 2Uc(y))	4.9dB
---	-------



Appendix A. Test Results of Conducted Emission Test

Test Engineer :	Amos Zhang	Temperature :	25.3~26.2°C
Test Voltage :	120Vac / 60Hz	Relative Humidity :	38~40%
		Phase :	Line

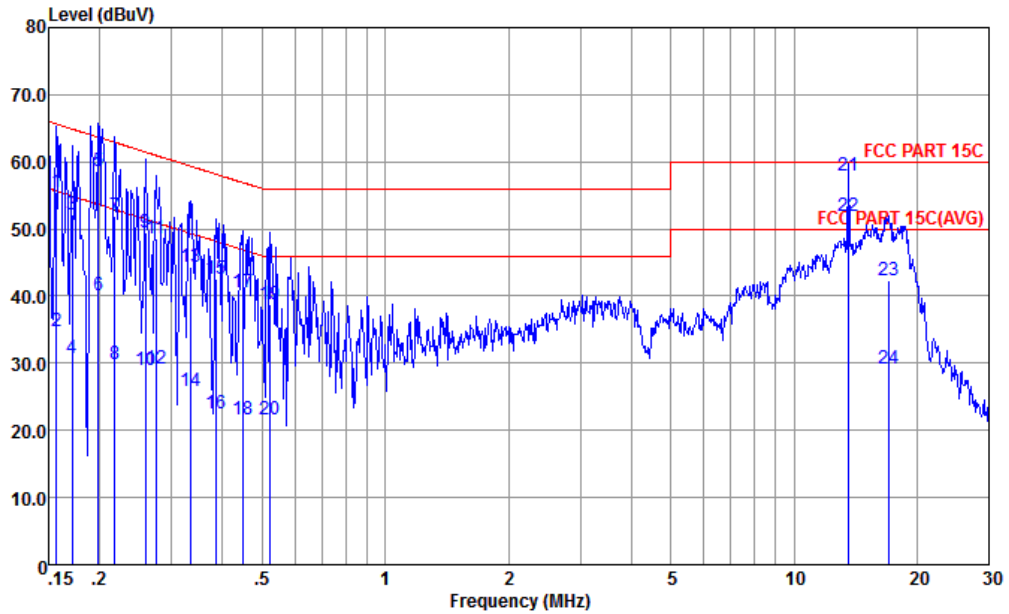

Site : CO01-KS
 Condition : FCC PART 15C LISN-L-191028-060105 LINE

mode : Mode 1
 : 353580110012212/353580110012220 #14

	Freq	Level	Over	Limit	Read	LISN	Cable	Remark
	MHz	dBuV	Limit	Line	Level	Factor	Loss	
			dB	dBuV	dBuV	dB	dB	
1	0.156	55.59	-10.06	65.65	45.10	0.03	10.46	QP
2	0.156	34.69	-20.96	55.65	24.20	0.03	10.46	Average
3	0.171	52.06	-12.84	64.90	41.60	0.03	10.43	QP
4	0.171	30.76	-24.14	54.90	20.30	0.03	10.43	Average
5	0.199	58.61	-5.06	63.67	48.20	0.04	10.37	QP
6	0.199	40.01	-13.66	53.67	29.60	0.04	10.37	Average
7	0.217	51.89	-11.03	62.92	41.50	0.04	10.35	QP
8	0.217	29.89	-23.03	52.92	19.50	0.04	10.35	Average
9	0.259	49.47	-12.00	61.47	39.09	0.05	10.33	QP
10	0.259	28.87	-22.60	51.47	18.49	0.05	10.33	Average
11	0.274	48.57	-12.41	60.98	38.20	0.05	10.32	QP
12	0.274	29.27	-21.71	50.98	18.90	0.05	10.32	Average
13	0.334	44.24	-15.11	59.35	33.90	0.05	10.29	QP
14	0.334	25.84	-23.51	49.35	15.50	0.05	10.29	Average
15	0.385	42.53	-15.64	58.17	32.21	0.05	10.27	QP
16	0.385	22.53	-25.64	48.17	12.21	0.05	10.27	Average
17	0.447	40.51	-16.42	56.93	30.20	0.06	10.25	QP
18	0.447	21.61	-25.32	46.93	11.30	0.06	10.25	Average
19	0.524	38.80	-17.20	56.00	28.50	0.06	10.24	QP
20	0.524	21.60	-24.40	46.00	11.30	0.06	10.24	Average
21	13.560	58.03	-1.97	60.00	47.31	0.34	10.38	QP
22 *	13.560	52.03	2.03	50.00	41.31	0.34	10.38	Average
23	17.018	42.43	-17.57	60.00	31.50	0.49	10.44	QP
24	17.018	29.13	-20.87	50.00	18.20	0.49	10.44	Average

(1) with antenna

Remark: 13.560MHz is the NFC RF fundamental signal.



Test Engineer :	Amos Zhang	Temperature :	25.3~26.2°C
		Relative Humidity :	38~40%
Test Voltage :	120Vac / 60Hz	Phase :	Neutral

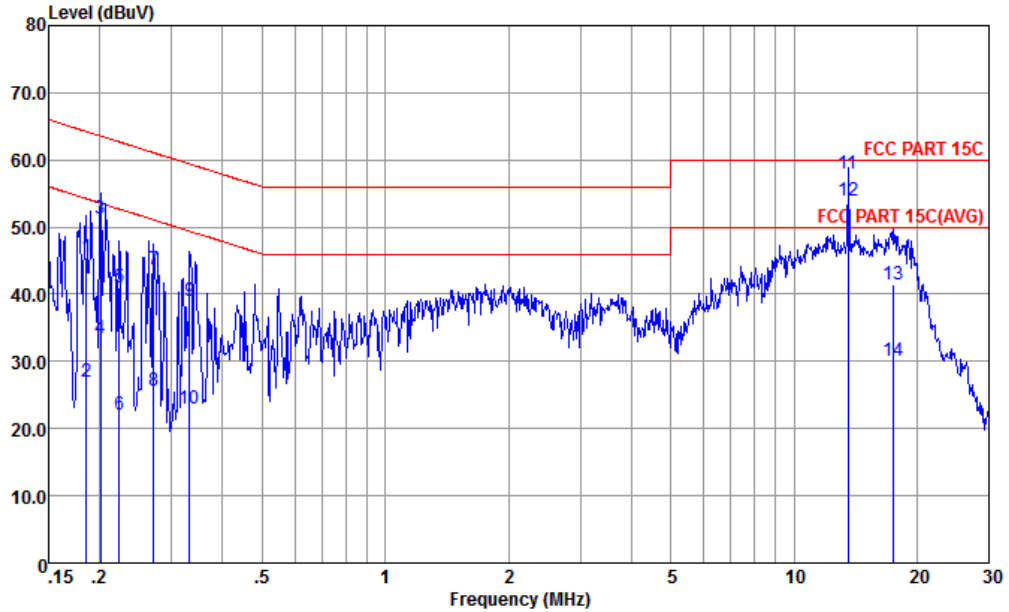

Site : CO01-KS
 Condition : FCC PART 15C LISN-N-191028-060105 NEUTRAL

mode : Mode 1
 : 353580110012212/353580110012220 #14

	Freq	Level	Over	Limit	Read	LISN	Cable	Remark
	MHz	dBuV	dB	dBuV	dBuV	dB	dB	
1	0.185	45.37	-18.87	64.24	34.90	0.08	10.39	QP
2	0.185	27.07	-27.17	54.24	16.60	0.08	10.39	Average
3	0.201	51.34	-12.24	63.58	40.90	0.08	10.36	QP
4	0.201	33.34	-20.24	53.58	22.90	0.08	10.36	Average
5	0.223	40.93	-21.77	62.70	30.50	0.08	10.35	QP
6	0.223	22.03	-30.67	52.70	11.60	0.08	10.35	Average
7	0.272	43.71	-17.36	61.07	33.30	0.09	10.32	QP
8	0.272	25.61	-25.46	51.07	15.20	0.09	10.32	Average
9	0.332	38.98	-20.42	59.40	28.60	0.09	10.29	QP
10	0.332	22.98	-26.42	49.40	12.60	0.09	10.29	Average
11	13.560	58.03	-1.97	60.00	47.30	0.35	10.38	QP
12 *	13.560	54.03	4.03	50.00	43.30	0.35	10.38	Average
13	17.475	41.55	-18.45	60.00	30.59	0.51	10.45	QP
14	17.475	30.15	-19.85	50.00	19.19	0.51	10.45	Average

(1) with antenna

Remark: 13.560MHz is the NFC RF fundamental signal.



Test Engineer :	Amos Zhang	Temperature :	25.3~26.2°C
		Relative Humidity :	38~40%
Test Voltage :	120Vac / 60Hz	Phase :	Line

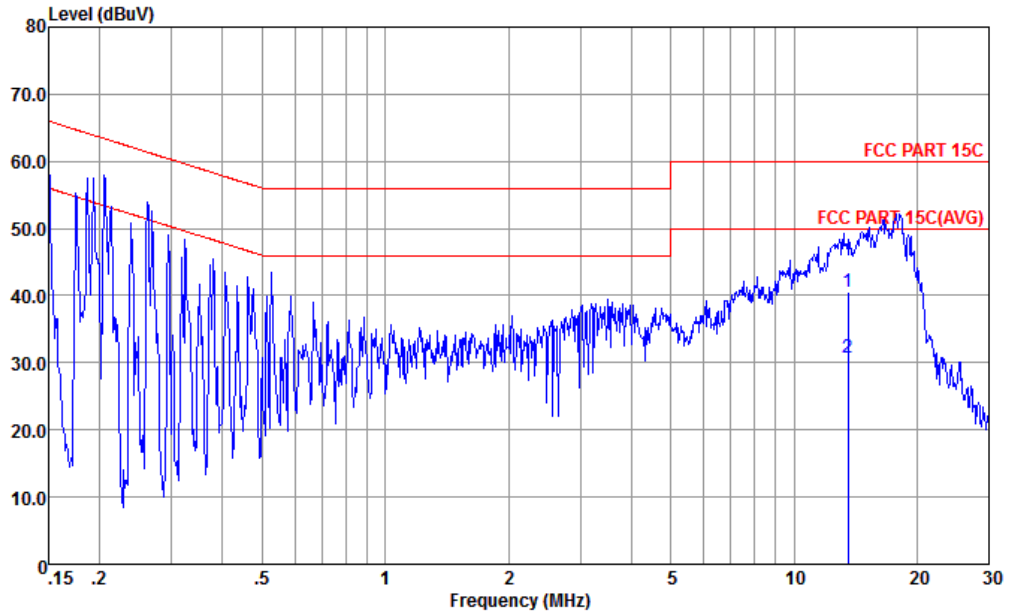

Site : CO01-KS
 Condition : FCC PART 15C LISN-L-191028-060105 LINE

mode : Mode 1
 : 353580110012212/353580110012220 #14

Freq	Level	Over Limit	Limit Line	Read Level	LISN Factor	Cable Loss	Remark
MHz	dBuV	dB	dBuV	dBuV	dB	dB	
1	13.560	40.63	-19.37	60.00	29.91	0.34	10.38 QP
2 *	13.560	30.83	-19.17	50.00	20.11	0.34	10.38 Average

(2) With dummy load

Remark: Only the fundamental NFC signal needs to be retested per KDB 174176.



Test Engineer :	Amos Zhang	Temperature :	25.3~26.2°C
		Relative Humidity :	38~40%
Test Voltage :	120Vac / 60Hz	Phase :	Neutral

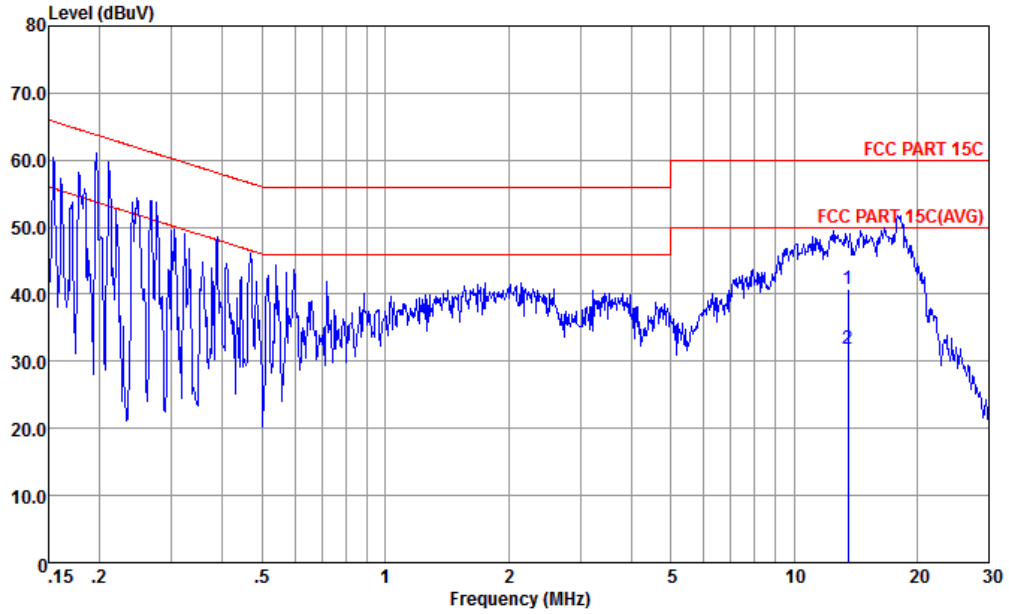

Site : CO01-KS
 Condition : FCC PART 15C LISN-N-191028-060105 NEUTRAL

mode : Mode 1
 : 353580110012212/353580110012220 #14

Freq	Level	Over	Limit	Read	LISN	Cable	Remark
MHz	dBuV	Limit	Line	Level	Factor	Loss	
		dB	dBuV	dBuV	dB	dB	
1	13.560	40.83	-19.17	60.00	30.10	0.35	10.38 QP
2 *	13.560	31.93	-18.07	50.00	21.20	0.35	10.38 Average

(2) With dummy load

Remark: Only the fundamental NFC signal needs to be retested per KDB 174176.

Note:

- Level(dBμV) = Read Level(dBμV) + LISN Factor(dB) + Cable Loss(dB)
- Over Limit(dB) = Level(dBμV) – Limit Line(dBμV)



Appendix B. Test Results of Conducted Test Items

B1. Test Result of 20dB Spectrum Bandwidth

Test mode	NFC Tx	Test Frequency (MHz)	13.56																																																																
<table border="1"> <thead> <tr> <th>Marker</th> <th>Type</th> <th>Ref</th> <th>Trc</th> <th>X-value</th> <th>Y-value</th> <th>Function</th> <th>Function Result</th> </tr> </thead> <tbody> <tr> <td>M1</td> <td>1</td> <td></td> <td></td> <td>13.559986 MHz</td> <td>-17.02 dBm</td> <td>ndB down</td> <td>2.504 kHz</td> </tr> <tr> <td>T1</td> <td>1</td> <td></td> <td></td> <td>13.559741 MHz</td> <td>-37.11 dBm</td> <td>ndB</td> <td>20.00 dB</td> </tr> <tr> <td>T2</td> <td>1</td> <td></td> <td></td> <td>13.561245 MHz</td> <td>-37.12 dBm</td> <td>Q factor</td> <td>5416.2</td> </tr> </tbody> </table>		Marker	Type	Ref	Trc	X-value	Y-value	Function	Function Result	M1	1			13.559986 MHz	-17.02 dBm	ndB down	2.504 kHz	T1	1			13.559741 MHz	-37.11 dBm	ndB	20.00 dB	T2	1			13.561245 MHz	-37.12 dBm	Q factor	5416.2	<table border="1"> <thead> <tr> <th>Marker</th> <th>Type</th> <th>Ref</th> <th>Trc</th> <th>X-value</th> <th>Y-value</th> <th>Function</th> <th>Function Result</th> </tr> </thead> <tbody> <tr> <td>M1</td> <td>1</td> <td></td> <td></td> <td>13.56 MHz</td> <td>-17.11 dBm</td> <td></td> <td></td> </tr> <tr> <td>T1</td> <td>1</td> <td></td> <td></td> <td>13.559436 MHz</td> <td>-30.89 dBm</td> <td>Occ Bw</td> <td>2.112879884 kHz</td> </tr> <tr> <td>T2</td> <td>1</td> <td></td> <td></td> <td>13.5610564 MHz</td> <td>-31.14 dBm</td> <td></td> <td></td> </tr> </tbody> </table>		Marker	Type	Ref	Trc	X-value	Y-value	Function	Function Result	M1	1			13.56 MHz	-17.11 dBm			T1	1			13.559436 MHz	-30.89 dBm	Occ Bw	2.112879884 kHz	T2	1			13.5610564 MHz	-31.14 dBm		
Marker	Type	Ref	Trc	X-value	Y-value	Function	Function Result																																																												
M1	1			13.559986 MHz	-17.02 dBm	ndB down	2.504 kHz																																																												
T1	1			13.559741 MHz	-37.11 dBm	ndB	20.00 dB																																																												
T2	1			13.561245 MHz	-37.12 dBm	Q factor	5416.2																																																												
Marker	Type	Ref	Trc	X-value	Y-value	Function	Function Result																																																												
M1	1			13.56 MHz	-17.11 dBm																																																														
T1	1			13.559436 MHz	-30.89 dBm	Occ Bw	2.112879884 kHz																																																												
T2	1			13.5610564 MHz	-31.14 dBm																																																														
20dB Bandwidth (kHz)	2.504	99% Occupied BW(kHz)	2.113																																																																
Frequency range (MHz)	$f_L > 13.553$	13.558741	Test Result																																																																
	$f_H < 13.567$	13.561245	Complies																																																																

Remark: Because the measured signal is CW adjusting the RBW per C63.10 would not be practical since measured bandwidth will always follow the RBW and the result will be approximately twice the RBW.



B2. Test Result of Frequency Stability

Voltage vs. Frequency Stability		Temperature vs. Frequency Stability	
Voltage (Vac)	Measurement Frequency (MHz)	Temperature (°C)	Measurement Frequency (MHz)
120	13.559993	-20	13.559993
102	13.559993	-10	13.559993
138	13.559993	0	13.559993
-	-	10	13.559993
-	-	20	13.559993
-	-	30	13.559993
-	-	40	13.559993
-	-	50	13.559993
Max.Deviation (MHz)	-0.000007	Max.Deviation (MHz)	-0.000007
Max.Deviation (ppm)	-0.5162	Max.Deviation (ppm)	-0.5162
Limit	FS < ±100 ppm	Limit	FS < ±100 ppm
Test Result	PASS	Test Result	PASS



Appendix C. Test Results of Radiated Test Items

C1. Test Result of Field Strength of Fundamental Emissions

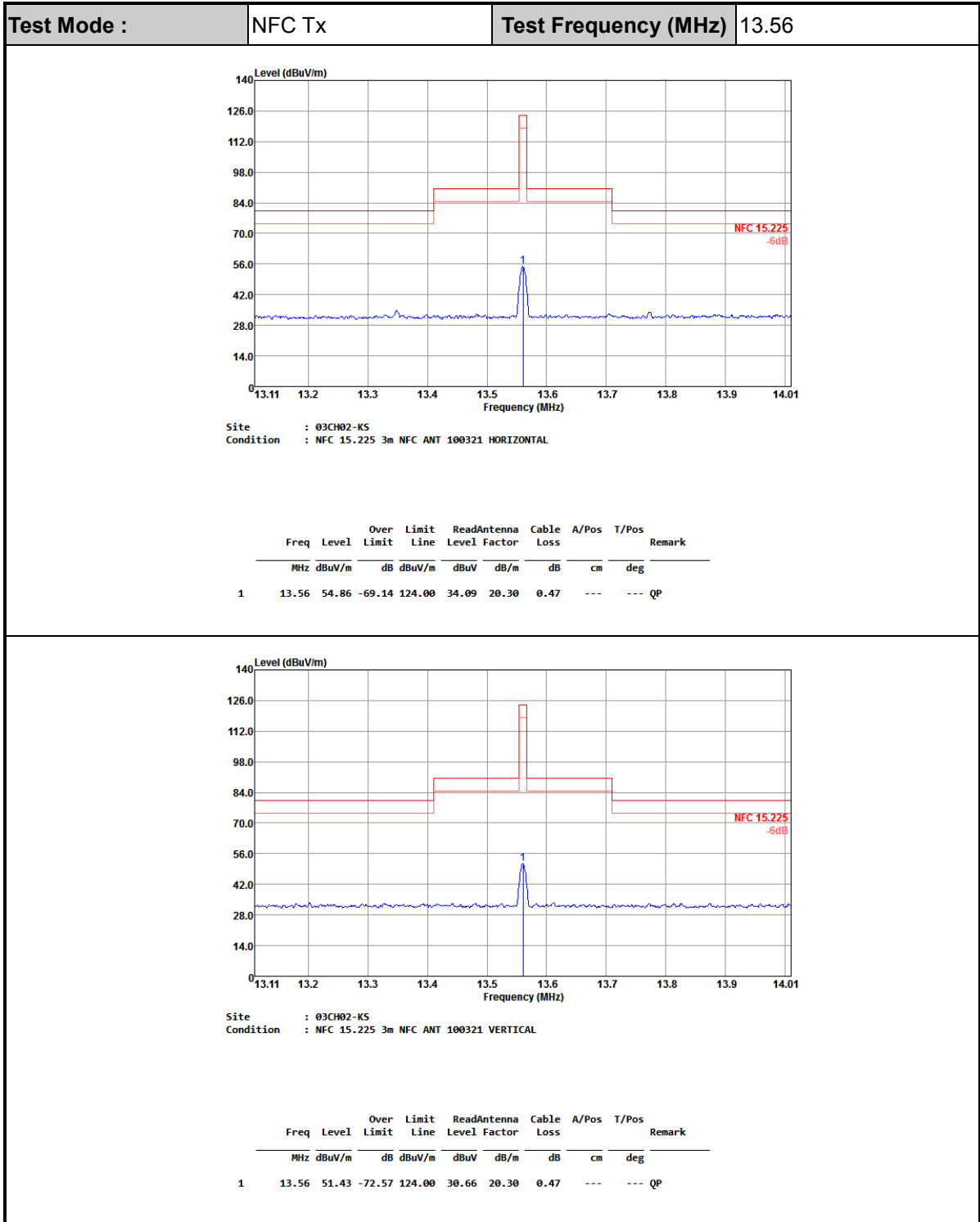

Note:

1. Level(dBμV/m) = Read Level(dBμV) + Antenna Factor(dB/m) + Cable Loss(dB)
2. Over Limit(dB) = Level(dBμV/m) – Limit Line(dBμV/m)



C2. Results of Radiated Spurious Emissions (9 kHz~30MHz)

Test Mode :		NFC Tx			Polarization :		Horizontal		
Frequency (MHz)	Level (dBμV/m)	Over Limit (dB)	Limit Line (dBμV/m)	Read Level (dBμV)	Antenna Factor (dB)	Cable Loss (dB)	Ant Pos (cm)	Table Pos (deg)	Remark
0.01915	52.73	-69.23	121.96	32.12	20.6	0.01	-	-	Average
0.0678	32.48	-78.49	110.97	13.07	19.4	0.01	-	-	Average
0.4904	49.84	-23.93	73.77	29.8	20.02	0.02	-	-	QP
2.93	39.58	-29.96	69.54	18.54	21	0.04	-	-	QP
21.94	33.79	-35.75	69.54	13.09	20.45	0.25	-	-	QP
25.535	32.5	-37.04	69.54	12.09	20.12	0.29	-	-	QP

Test Mode :		NFC Tx			Polarization :		Vertical		
Frequency (MHz)	Level (dBμV/m)	Over Limit (dB)	Limit Line (dBμV/m)	Read Level (dBμV)	Antenna Factor (dB)	Cable Loss (dB)	Ant Pos (cm)	Table Pos (deg)	Remark
0.01915	49.4	-72.56	121.96	28.79	20.6	0.01			Average
0.05003	34.32	-79.29	113.61	14.51	19.8	0.01			Average
0.4904	46.08	-27.69	73.77	26.04	20.02	0.02	-	-	QP
6.716	33.75	-35.79	69.54	12.74	20.93	0.08	-	-	QP
10.244	35.32	-34.22	69.54	14.99	20.21	0.12	-	-	QP
27.405	31.53	-38.01	69.54	11.36	19.86	0.31	-	-	QP

Note:

1. The amplitude of spurious emissions which are attenuated by more than 20dB below the permissible value has no need to be reported.
2. Distance extrapolation factor = 40 log (specific distance / test distance) (dB);
3. Limit line = specific limits (dBμV) + distance extrapolation factor.



C3. Results of Radiated Spurious Emissions (30MHz~1GHz)

Test Mode :		NFC Tx				Polarization :		Horizontal		
Frequency (MHz)	Level (dBμV/m)	Over Limit (dB)	Limit Line (dBμV/m)	Read Level (dBμV)	Antenna Factor (dB)	Cable Loss (dB)	Preamp Factor (dB)	Ant Pos (cm)	Table Pos (deg)	Remark
33.88	18.04	-21.96	40	27.29	22	0.71	31.96	-	-	Peak
128.94	17	-26.5	43.5	30.88	16.78	1.28	31.94	-	-	Peak
333.61	18.5	-27.5	46	28.32	20.17	2.06	32.05	-	-	Peak
509.18	22.56	-23.44	46	27.94	24.33	2.57	32.28	-	-	Peak
742.95	26.45	-19.55	46	27.34	28.25	3.12	32.26	-	-	Peak
931.13	29.38	-16.62	46	26.77	30.27	3.51	31.17	-	-	Peak

Test Mode :		NFC Tx				Polarization :		Vertical		
Frequency (MHz)	Level (dBμV/m)	Over Limit (dB)	Limit Line (dBμV/m)	Read Level (dBμV)	Antenna Factor (dB)	Cable Loss (dB)	Preamp Factor (dB)	Ant Pos (cm)	Table Pos (deg)	Remark
40.67	26.02	-13.98	40	38.11	19.16	0.71	31.96	-	-	Peak
67.83	17.43	-22.57	40	35.94	12.44	0.98	31.93	-	-	Peak
85.29	16.8	-23.2	40	33.25	14.4	1.08	31.93	-	-	Peak
261.83	16.28	-29.72	46	27.54	18.84	1.89	31.99	-	-	Peak
531.49	23.18	-22.82	46	27.97	24.92	2.6	32.31	-	-	Peak
843.83	28.68	-17.32	46	28	29.17	3.34	31.83	-	-	Peak

Note:

1. The amplitude of spurious emissions which are attenuated by more than 20dB below the permissible value has no need to be reported.
2. Emission level (dBμV/m) = 20 log Emission level (μV/m).
3. Corrected Reading: Antenna Factor + Cable Loss + Read Level - Preamp Factor= Level.