

FCC SAR Test Report

APPLICANT : Motorola Mobility LLC
EQUIPMENT : Mobile Cellular Phone
BRAND NAME : Motorola
MODEL NAME : XT2043-7
FCC ID : IHDT56YN2
STANDARD : FCC 47 CFR Part 2 (2.1093)
ANSI/IEEE C95.1-1992
IEEE 1528-2013

The product was received on Jan. 16, 2020 and testing was started from Mar. 26, 2020 and completed on Apr. 11, 2020. We, Sporton International (Kunshan) Inc, would like to declare that the tested sample has been evaluated in accordance with the procedures and had been in compliance with the applicable technical standards.

The test results in this report apply exclusively to the tested model / sample. Without written approval of Sporton International (Kunshan) Inc., the test report shall not be reproduced except in full.

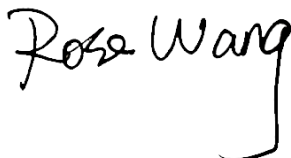

Reviewed by: Rose Wang / Supervisor



Approved by: Kat Yin / Manager



Sporton International (Kunshan) Inc.

No. 1098, Pengxi North Road, Kunshan Economic Development Zone Jiangsu Province 215300
People's Republic of China



Table of Contents

1. Statement of Compliance 4
2. Administration Data 5
3. Guidance Applied 5
4. Equipment Under Test (EUT) Information 6
4.1 General Information 6
4.2 General LTE SAR Test and Reporting Considerations 8
5. Proximity Sensor Triggering Test 11
5.1 Proximity sensor triggering distances(Per KDB616217§6.2) 11
6. RF Exposure Limits 24
6.1 Uncontrolled Environment 24
6.2 Controlled Environment 24
7. Specific Absorption Rate (SAR) 25
7.1 Introduction 25
7.2 SAR Definition 25
8. System Description and Setup 26
8.1 E-Field Probe 27
8.2 Data Acquisition Electronics (DAE) 27
8.3 Phantom 28
8.4 Device Holder 29
9. Measurement Procedures 30
9.1 Spatial Peak SAR Evaluation 30
9.2 Power Reference Measurement 31
9.3 Area Scan 31
9.4 Zoom Scan 32
9.5 Volume Scan Procedures 32
9.6 Power Drift Monitoring 32
10. Test Equipment List 33
11. System Verification 34
11.1 Tissue Simulating Liquids 34
11.2 Tissue Verification 35
11.3 System Performance Check Results 36
12. RF Exposure Positions 37
12.1 Ear and handset reference point 37
12.2 Definition of the cheek position 38
12.3 Definition of the tilt position 39
12.4 Body Worn Accessory 40
12.5 Product Specific 10g SAR Exposure 41
12.6 Wireless Router 41
13. Conducted RF Output Power (Unit: dBm) 42
14. SAR Test Results 53
14.1 Head SAR 56
14.2 Hotspot SAR 60
14.3 Body Worn Accessory SAR 66
14.4 Product specific 10g SAR 70
14.5 Repeated SAR Measurement 74
15. Simultaneous Transmission Analysis 75
15.1 Head Exposure Conditions 76
15.2 Hotspot Exposure Conditions 77
15.3 Body-Worn Accessory Exposure Conditions 79
15.4 Product specific 10g SAR Exposure Conditions 81
15.5 SPLSR Evaluation and Analysis 83
16. Supplemental Tuner Tests Results 99
16.1 Supplemental Tuner Head & Body SAR Results 99
17. Uncertainty Assessment 100
18. References 101
Appendix A. Plots of System Performance Check
Appendix B. Plots of High SAR Measurement
Appendix C. DASY Calibration Certificate
Appendix D. Test Setup Photos
Appendix E. Conducted RF Output Power Table
Appendix F. Supplemental Tuner SAR Results

Revision History

REPORT NO.	VERSION	DESCRIPTION	ISSUED DATE
FA011607	Rev. 01	Initial issue of report	Apr. 22, 2020



1. Statement of Compliance

The maximum results of Specific Absorption Rate (SAR) found during testing for **Motorola Mobility LLC, Mobile Cellular Phone, XT2043-7**, are as follows.

Highest 1g SAR Summary						
Equipment Class	Frequency Band		Head (Separation 0mm)	Hotspot (Separation 5mm)	Body-worn (Separation 5mm)	Highest Simultaneous Transmission 1g SAR (W/kg)
			1g SAR (W/kg)			
Licensed	GSM	GSM850	0.12	1.32	1.36	1.59
		GSM1900	0.05	1.38	1.31	
	WCDMA	Band II	0.12	1.39	1.39	
		Band IV	0.20	1.38	1.38	
		Band V	0.33	1.30	1.30	
	LTE	Band 2	0.17	1.33	1.22	
		Band 26/Band 5	0.34	1.14	1.14	
		Band 12/Band 17	0.27	1.00	1.00	
		Band 66/Band 4	0.17	1.38	1.38	
		Band 7	0.15	1.30	1.35	
		Band 41/Band 38	0.12	1.39	1.32	
DTS	WLAN	2.4GHz WLAN	1.10	1.17	1.17	1.57
NII		5GHz WLAN	1.19	1.18	1.18	1.59
DSS	Bluetooth	2.4GHz Bluetooth	<0.10	<0.10	<0.10	1.44
Highest 10g SAR Summary						
Equipment Class	Frequency Band		Product Specific 10g SAR (W/kg) (Separation 0mm)		Highest Simultaneous Transmission 10g SAR (W/kg)	
Licensed	GSM	GSM850	0.76		3.98	
		GSM1900	3.00			
	WCDMA	Band II	3.25			
		Band IV	3.50			
		Band V	2.46			
	LTE	Band 2	3.24			
		Band 66/Band 4	3.23			
		Band 7	3.30			
Band 41/Band 38		2.20				
DTS	WLAN	2.4GHz WLAN	3.09		3.98	
NII		5GHz WLAN	3.29		3.60	
Date of Testing:			2020/3/26~2020/4/11			
Remark: This device supports LTE B4 / B5 / B17 / B38 and B66 / B26 / B12 / B41. Since the supported frequency span for LTE B4 / B5 / B17 / B38 falls completely within the supports frequency span for LTE B66 / B26 / B12 / B41, both LTE bands have the same target power, and both LTE bands share the same transmission path; therefore, SAR was only assessed for LTE B66 / B26 / B12 / B41.						

Declaration of Conformity:
 The test results with all measurement uncertainty excluded are presented in accordance with the regulation limits or requirements declared by manufacturers.

Comments and Explanations:
 The declared of product specification for EUT presented in the report are provided by the manufacturer, and the manufacturer takes all the responsibilities for the accuracy of product specification.

This device is in compliance with Specific Absorption Rate (SAR) for general population/uncontrolled exposure limits (1.6 W/kg for Partial-Body 1g SAR, 4.0 W/kg for Product Specific 10g SAR) specified in FCC 47 CFR part 2 (2.1093) and ANSI/IEEE C95.1-1992, and had been tested in accordance with the measurement methods and procedures specified in IEEE 1528-2013 and FCC KDB publications.



2. Administration Data

Sporton International (Kunshan) Inc. is accredited to ISO/IEC 17025:2017 by American Association for Laboratory Accreditation with Certificate Number 5145.02.

Testing Laboratory		
Test Firm	Sporton International (Kunshan) Inc.	
Test Site Location	No. 1098, Pengxi North Road, Kunshan Economic Development Zone Jiangsu Province 215300 People's Republic of China TEL : +86-512-57900158 FAX : +86-512-57900958	
Test Site No.	FCC Designation No.	FCC Test Firm Registration No.
	CN1257	314309

Applicant	
Company Name	Motorola Mobility LLC
Address	222 W, Merchandise Mart Plaza, Chicago IL 60654 USA

Manufacturer	
Company Name	Motorola Mobility LLC
Address	222 W, Merchandise Mart Plaza, Chicago IL 60654 USA

3. Guidance Applied

The Specific Absorption Rate (SAR) testing specification, method, and procedure for this device is in accordance with the following standards:

- FCC 47 CFR Part 2 (2.1093)
- ANSI/IEEE C95.1-1992
- IEEE 1528-2013
- FCC KDB 865664 D01 SAR Measurement 100 MHz to 6 GHz v01r04
- FCC KDB 865664 D02 SAR Reporting v01r02
- FCC KDB 447498 D01 General RF Exposure Guidance v06
- FCC KDB 648474 D04 SAR Evaluation Considerations for Wireless Handsets v01r03
- FCC KDB 248227 D01 802.11 Wi-Fi SAR v02r02
- FCC KDB 616217 D04 SAR for laptop and tablets v01r02
- FCC KDB 941225 D01 3G SAR Procedures v03r01
- FCC KDB 941225 D05 SAR for LTE Devices v02r05
- FCC KDB 941225 D05A Rel.10 LTE SAR Test Guidance v01r02
- FCC KDB 941225 D06 Hotspot Mode SAR v02r01

4. Equipment Under Test (EUT) Information

4.1 General Information

Product Feature & Specification	
Equipment Name	Mobile Cellular Phone
Brand Name	Motorola
Model Name	XT2043-7
FCC ID	IHDT56YN2
IMEI Code	IMEI 1: 353585110016899 IMEI 2: 353585110016907
Wireless Technology and Frequency Range	GSM850: 824.2 MHz ~ 848.8 MHz GSM1900: 1850.2 MHz ~ 1909.8 MHz WCDMA Band II: 1852.4 MHz ~ 1907.6 MHz WCDMA Band IV: 1712.4 MHz ~ 1752.6 MHz WCDMA Band V: 826.4 MHz ~ 846.6 MHz LTE Band 2: 1850.7 MHz ~ 1909.3 MHz LTE Band 4: 1710.7 MHz ~ 1754.3 MHz LTE Band 5: 824.7 MHz ~ 848.3 MHz LTE Band 7: 2502.5 MHz ~ 2567.5 MHz LTE Band 12: 699.7 MHz ~ 715.3 MHz LTE Band 17: 706.5 MHz ~ 713.5 MHz LTE Band 26: 814.7 MHz ~ 848.3 MHz LTE Band 38: 2572.5 MHz ~ 2617.5 MHz LTE Band 41: 2537.5 MHz ~ 2652.5 MHz LTE Band 66: 1710.7 MHz ~ 1779.3 MHz WLAN 2.4GHz Band: 2412 MHz ~ 2462 MHz WLAN 5.2GHz Band: 5180 MHz ~ 5240 MHz WLAN 5.3GHz Band: 5260 MHz ~ 5320 MHz WLAN 5.5GHz Band: 5500 MHz ~ 5700 MHz WLAN 5.8GHz Band: 5745 MHz ~ 5825 MHz Bluetooth: 2402 MHz ~ 2480 MHz NFC: 13.56 MHz
Mode	GSM/GPRS/EGPRS RMC/AMR 12.2Kbps HSDPA HSUPA DC-HSDPA HSPA+(16QAM uplink is not supported) LTE: QPSK, 16QAM, 64QAM WLAN 2.4GHz 802.11b/g/n HT20 WLAN 5GHz 802.11a/n HT20/HT40 WLAN 5GHz 802.11ac VHT20/VHT40/VHT80 Bluetooth BR/EDR/LE NFC:ASK
HW Version	DVT2
SW Version	QPR30.104
GSM / (E)GPRS Transfer mode	Class B – EUT cannot support Packet Switched and Circuit Switched Network simultaneously but can automatically switch between Packet and Circuit Switched Network.
EUT Stage	Identical Prototype
Remark:	<ol style="list-style-type: none"> WLAN operation in 5600 MHz ~ 5650 MHz is notched. 802.11n-HT40 is not supported in 2.4GHz WLAN. This device supports VoIP in GPRS, EGPRS, CDMA, WCDMA and LTE (e.g. for 3rd-party VoIP), LTE supports VoLTE operation. This device 2.4GHz WLAN support hotspot operation and Bluetooth support tethering applications. This device 2.4GHz /WLAN/5.2GHz/ WLAN/5.3GHz / WLAN/5.5GHz / WLAN/5.8GHz support hotspot operation, and 5.2GHz WLAN/5.8GHz WLAN supports WiFi Direct (GC/GO), and 5.3GHz / 5.5GHz supports WiFi Direct (GC only). This device does not support DTM operation and supports GRPS/EGRPS mode up to multi-slot class 12.

7. For dual SIM card mobile has two SIM slots and supports dual SIM dual standby. The WWAN radio transmission will be enabled by either one SIM at a time (single active). After pre-scan two SIM cards power, we found test result of the SIM1 was the worse, so we chose SIM1 slot to perform all tests.
8. When the phone is in talking mode and receiver worked, then power reduction will be implemented immediately at WLAN2.4GHz/WLAN5.2GHz/5.3GHz.
9. The device employs proximity sensors that detect the presence of the user's body at the front or back faces of the device. When front or back body worn condition is detected, GSM850/1900, WCDMA band II/IV, LTE band 2/4/7/66/38/41 and WLAN2.4GHz/WLAN5.2GHz/5.3GHz/5.5GHz/5.8GHz reduced power will be active. (P-sensor can't work at detecting presence of the user's body at the four edges of the device.)
10. P-sensor can detect handheld state, GSM1900, WCDMA band II/IV and LTE B2/4/66 for front/back/bottom sides of product specific 10g SAR condition reduced powers will be active.
11. When handheld state, when WWAN transmit simultaneous with WLAN/Bluetooth, for WLAN2.4G / 5.2GHz / 5.3GHz / 5.5GHz / 5.8GHz, product specific 10g SAR condition reduced powers will be active for front or back side. Other faces full power can be tested pass, so reduced power no need to be evaluated.
12. When hotspot mode is enabled, power reduction will be activated to limit the maximum power of GSM850/1900, WCDMA band II/IV, LTE band 2/4/7/66/38/41 and 2.4GHz/WLAN/5.2GHz/WLAN/5.8GHz.
13. For P-sensor reduced power level is higher than hotspot reduced power for GSM1900, WCDMA band IV and LTE band 2/4/66/38/41, so for front/back P-sensor SAR can represent conservatively for front/back hotspot SAR.
14. This device has two WWAN transmitter antennas. WWAN antenna 1 is located at the right of bottom edge of the device and WWAN antenna 2 is located at the left side of bottom edge of the device which can refer to antenna location chapter. WWAN antenna 1 frequency bands include GSM850/1900, WCDMA Band II/IV/V, and LTE Band 2/4/5/12/17/26/66, WWAN antenna 2 frequency band include LTE Band 7/38/41.
15. This device implements antenna tuning techniques for several WWAN (cellular) operating modes and frequencies for the purpose of improving antenna efficiency over a broad range of frequencies. Specifically, these techniques are employed in the GSM, WCDMA and LTE modes of WWAN antenna 1. In this report SAR was measured according to the normally required SAR configurations with the tuner active and worst tune state (auto tune) was used for SAR testing. The detail descriptions of the antenna tuner and supplemental data for additional information on section16.
16. There are four types of EUT, the difference between them is different capacity for memory, they have no effect on SAR distribution, so only choose sample 1 to perform full testing.
17. There are four types of EUT, the sample 1/2 with dual SIM slot and the sample 3/4 with single SIM slot, the sample 1/3 are the 1st source, the sample 2/4 are the 2nd source, please refer to the product equality declaration exhibit separately. They have no effect on SAR distribution, so only choose sample 1 to perform full testing.
18. There are two type batteries, with the same battery capacity, only manufacturer different. So we only chose battery 1 to perform full SAR testing.



4.2 General LTE SAR Test and Reporting Considerations

Summarized necessary items addressed in KDB 941225 D05 v02r05																																																																	
FCC ID	IHDT56YN2																																																																
Equipment Name	Mobile Cellular Phone																																																																
Operating Frequency Range of each LTE transmission band	LTE Band 2: 1850.7 MHz ~ 1909.3 MHz LTE Band 4: 1710.7 MHz ~ 1754.3 MHz LTE Band 5: 824.7 MHz ~ 848.3 MHz LTE Band 7: 2502.5 MHz ~ 2567.5 MHz LTE Band 12: 699.7 MHz ~ 715.3 MHz LTE Band 17: 706.5 MHz ~ 713.5 MHz LTE Band 26: 814.7 MHz ~ 848.3 MHz LTE Band 38: 2572.5 MHz ~ 2617.5 MHz LTE Band 41: 2537.5 MHz ~ 2652.5 MHz LTE Band 66: 1710.7 MHz ~ 1779.3 MHz																																																																
Channel Bandwidth	LTE Band 2: 1.4MHz, 3MHz, 5MHz, 10MHz, 15MHz, 20MHz LTE Band 4: 1.4MHz, 3MHz, 5MHz, 10MHz, 15MHz, 20MHz LTE Band 5: 1.4MHz, 3MHz, 5MHz, 10MHz LTE Band 7: 5MHz, 10MHz, 15MHz, 20MHz LTE Band 12: 1.4MHz, 3MHz, 5MHz, 10MHz LTE Band 17: 5MHz, 10MHz LTE Band 26: 1.4MHz, 3MHz, 5MHz, 10MHz, 15MHz LTE Band 38: 5MHz, 10MHz, 15MHz, 20MHz LTE Band 41: 5MHz, 10MHz, 15MHz, 20MHz LTE Band 66: 1.4MHz, 3MHz, 5MHz, 10MHz, 15MHz, 20MHz																																																																
uplink modulations used	QPSK / 16QAM / 64QAM																																																																
LTE Voice / Data requirements	Voice and Data																																																																
LTE Release Version	R12, Cat13																																																																
CA Support	Supported, Downlink Only																																																																
LTE MPR permanently built-in by design	<p align="center">Table 6.2.3-1: Maximum Power Reduction (MPR) for Power Class 1, 2 and 3</p> <table border="1"> <thead> <tr> <th rowspan="2">Modulation</th> <th colspan="6">Channel bandwidth / Transmission bandwidth (N_{RB})</th> <th rowspan="2">MPR (dB)</th> </tr> <tr> <th>1.4 MHz</th> <th>3.0 MHz</th> <th>5 MHz</th> <th>10 MHz</th> <th>15 MHz</th> <th>20 MHz</th> </tr> </thead> <tbody> <tr> <td>QPSK</td> <td>> 5</td> <td>> 4</td> <td>> 8</td> <td>> 12</td> <td>> 16</td> <td>> 18</td> <td>≤ 1</td> </tr> <tr> <td>16 QAM</td> <td>≤ 5</td> <td>≤ 4</td> <td>≤ 8</td> <td>≤ 12</td> <td>≤ 16</td> <td>≤ 18</td> <td>≤ 1</td> </tr> <tr> <td>16 QAM</td> <td>> 5</td> <td>> 4</td> <td>> 8</td> <td>> 12</td> <td>> 16</td> <td>> 18</td> <td>≤ 2</td> </tr> <tr> <td>64 QAM</td> <td>≤ 5</td> <td>≤ 4</td> <td>≤ 8</td> <td>≤ 12</td> <td>≤ 16</td> <td>≤ 18</td> <td>≤ 2</td> </tr> <tr> <td>64 QAM</td> <td>> 5</td> <td>> 4</td> <td>> 8</td> <td>> 12</td> <td>> 16</td> <td>> 18</td> <td>≤ 3</td> </tr> <tr> <td>256 QAM</td> <td colspan="6">≥ 1</td> <td>≤ 5</td> </tr> </tbody> </table>			Modulation	Channel bandwidth / Transmission bandwidth (N _{RB})						MPR (dB)	1.4 MHz	3.0 MHz	5 MHz	10 MHz	15 MHz	20 MHz	QPSK	> 5	> 4	> 8	> 12	> 16	> 18	≤ 1	16 QAM	≤ 5	≤ 4	≤ 8	≤ 12	≤ 16	≤ 18	≤ 1	16 QAM	> 5	> 4	> 8	> 12	> 16	> 18	≤ 2	64 QAM	≤ 5	≤ 4	≤ 8	≤ 12	≤ 16	≤ 18	≤ 2	64 QAM	> 5	> 4	> 8	> 12	> 16	> 18	≤ 3	256 QAM	≥ 1						≤ 5
Modulation	Channel bandwidth / Transmission bandwidth (N _{RB})						MPR (dB)																																																										
	1.4 MHz	3.0 MHz	5 MHz	10 MHz	15 MHz	20 MHz																																																											
QPSK	> 5	> 4	> 8	> 12	> 16	> 18	≤ 1																																																										
16 QAM	≤ 5	≤ 4	≤ 8	≤ 12	≤ 16	≤ 18	≤ 1																																																										
16 QAM	> 5	> 4	> 8	> 12	> 16	> 18	≤ 2																																																										
64 QAM	≤ 5	≤ 4	≤ 8	≤ 12	≤ 16	≤ 18	≤ 2																																																										
64 QAM	> 5	> 4	> 8	> 12	> 16	> 18	≤ 3																																																										
256 QAM	≥ 1						≤ 5																																																										
LTE A-MPR	In the base station simulator configuration, Network Setting value is set to NS_01 to disable A-MPR during SAR testing and the LTE SAR tests was transmitting on all TTI frames (Maximum TTI)																																																																
Spectrum plots for RB configuration	A properly configured base station simulator was used for the SAR and power measurement; therefore, spectrum plots for each RB allocation and offset configuration are not included in the SAR report.																																																																
Power reduction applied to satisfy SAR compliance	Yes 1. The device employs proximity sensors that detect the presence of the user's body at the front or back faces of the device. When front or back body worn condition is detected, LTE band 2/4/7/66/38/41 reduced power will be active. (P-sensor can't work at detecting presence of the user's body at the four edges of the device.) 2. P-sensor can detect handheld state LTE B2/4/66 for front/back/bottom sides of product specific 10g SAR condition reduced powers will be active. 3. When hotspot mode is enabled, power reduction will be activated to limit the maximum power of LTE band 2/4/7/66/38/41.																																																																
LTE Carrier Aggregation Combinations	Inter-Band and Intra-Band possible combinations and the detail power verification please referred to section 13.																																																																
LTE Carrier Aggregation Additional Information	This device supports maximum of 2 carriers in the downlink. Additional following LTE Release features are not supported: Relay, HetNet, Enhanced MIMO, eICI, WiFi Offloading, MDH, eMBMA, Cross-Carrier Scheduling, Enhanced SC-FDMA.																																																																



Transmission (H, M, L) channel numbers and frequencies in each LTE band																
LTE Band 2																
	Bandwidth 1.4 MHz		Bandwidth 3 MHz		Bandwidth 5 MHz		Bandwidth 10 MHz		Bandwidth 15 MHz		Bandwidth 20 MHz					
	Ch. #	Freq. (MHz)	Ch. #	Freq. (MHz)	Ch. #	Freq. (MHz)	Ch. #	Freq. (MHz)	Ch. #	Freq. (MHz)	Ch. #	Freq. (MHz)				
L	18607	1850.7	18615	1851.5	18625	1852.5	18650	1855	18675	1857.5	18700	1860				
M	18900	1880	18900	1880	18900	1880	18900	1880	18900	1880	18900	1880				
H	19193	1909.3	19185	1908.5	19175	1907.5	19150	1905	19125	1902.5	19100	1900				
LTE Band 4																
	Bandwidth 1.4 MHz		Bandwidth 3 MHz		Bandwidth 5 MHz		Bandwidth 10 MHz		Bandwidth 15 MHz		Bandwidth 20 MHz					
	Ch. #	Freq. (MHz)	Ch. #	Freq. (MHz)	Ch. #	Freq. (MHz)	Ch. #	Freq. (MHz)	Ch. #	Freq. (MHz)	Ch. #	Freq. (MHz)				
L	19957	1710.7	19965	1711.5	19975	1712.5	20000	1715	20025	1717.5	20050	1720				
M	20175	1732.5	20175	1732.5	20175	1732.5	20175	1732.5	20175	1732.5	20175	1732.5				
H	20393	1754.3	20385	1753.5	20375	1752.5	20350	1750	20325	1747.5	20300	1745				
LTE Band 5																
	Bandwidth 1.4 MHz		Bandwidth 3 MHz		Bandwidth 5 MHz		Bandwidth 10 MHz		Bandwidth 15 MHz		Bandwidth 20 MHz					
	Ch. #	Freq. (MHz)	Ch. #	Freq. (MHz)	Ch. #	Freq. (MHz)	Ch. #	Freq. (MHz)	Ch. #	Freq. (MHz)	Ch. #	Freq. (MHz)				
L	20407	824.7	20415	825.5	20425	826.5	20450	829	20450	829	20450	829				
M	20525	836.5	20525	836.5	20525	836.5	20525	836.5	20525	836.5	20525	836.5				
H	20643	848.3	20635	847.5	20625	846.5	20600	844	20600	844	20600	844				
LTE Band 7																
	Bandwidth 5 MHz		Bandwidth 10 MHz		Bandwidth 15 MHz		Bandwidth 20 MHz		Bandwidth 15 MHz		Bandwidth 20 MHz					
	Ch. #	Freq. (MHz)	Ch. #	Freq. (MHz)	Ch. #	Freq. (MHz)	Ch. #	Freq. (MHz)	Ch. #	Freq. (MHz)	Ch. #	Freq. (MHz)				
L	20775	2502.5	20800	2505	20825	2507.5	20850	2510	20850	2510	20850	2510				
M	21100	2535	21100	2535	21100	2535	21100	2535	21100	2535	21100	2535				
H	21425	2567.5	21400	2565	21375	2562.5	21350	2560	21350	2560	21350	2560				
LTE Band 12																
	Bandwidth 1.4 MHz		Bandwidth 3 MHz		Bandwidth 5 MHz		Bandwidth 10 MHz		Bandwidth 15 MHz		Bandwidth 20 MHz					
	Ch. #	Freq. (MHz)	Ch. #	Freq. (MHz)	Ch. #	Freq. (MHz)	Ch. #	Freq. (MHz)	Ch. #	Freq. (MHz)	Ch. #	Freq. (MHz)				
L	23017	699.7	23025	700.5	23035	701.5	23060	704	23060	704	23060	704				
M	23095	707.5	23095	707.5	23095	707.5	23095	707.5	23095	707.5	23095	707.5				
H	23173	715.3	23165	714.5	23155	713.5	23130	711	23130	711	23130	711				
LTE Band 17																
	Bandwidth 5 MHz				Bandwidth 10 MHz				Bandwidth 15 MHz				Bandwidth 20 MHz			
	Channel #		Freq. (MHz)		Channel #		Freq. (MHz)		Channel #		Freq. (MHz)		Channel #		Freq. (MHz)	
L	23755		706.5		23780		709		23780		709		23780		709	
M	23790		710		23790		710		23790		710		23790		710	
H	23825		713.5		23800		711		23800		711		23800		711	
LTE Band 26																
	Bandwidth 1.4 MHz		Bandwidth 3 MHz		Bandwidth 5 MHz		Bandwidth 10 MHz		Bandwidth 15 MHz		Bandwidth 20 MHz					
	Ch. #	Freq. (MHz)	Ch. #	Freq. (MHz)	Ch. #	Freq. (MHz)	Ch. #	Freq. (MHz)	Ch. #	Freq. (MHz)	Ch. #	Freq. (MHz)				
L	26697	814.7	26705	815.5	26715	816.5	26740	819	26740	819	26765	821.5				
M	26865	831.5	26865	831.5	26865	831.5	26865	831.5	26865	831.5	26865	831.5				
H	27033	848.3	27025	847.5	27015	846.5	26990	844	26990	844	26965	841.5				
LTE Band 38																
	Bandwidth 5 MHz		Bandwidth 10 MHz		Bandwidth 15 MHz		Bandwidth 20 MHz		Bandwidth 15 MHz		Bandwidth 20 MHz					
	Ch. #	Freq. (MHz)	Ch. #	Freq. (MHz)	Ch. #	Freq. (MHz)	Ch. #	Freq. (MHz)	Ch. #	Freq. (MHz)	Ch. #	Freq. (MHz)				
L	37775	2572.5	37800	2575	37825	2577.5	37850	2580	37850	2580	37850	2580				
M	38000	2595	38000	2595	38000	2595	38000	2595	38000	2595	38000	2595				
H	38225	2617.5	38200	2615	38175	2612.5	38150	2610	38150	2610	38150	2610				



LTE Band 41												
	Bandwidth 5 MHz		Bandwidth 10 MHz		Bandwidth 15 MHz		Bandwidth 20 MHz					
	Ch. #	Freq. (MHz)	Ch. #	Freq. (MHz)	Ch. #	Freq. (MHz)	Ch. #	Freq. (MHz)	Ch. #	Freq. (MHz)	Ch. #	Freq. (MHz)
L	40065	2537.5	40090	2540	40115	2542.5	40140	2545				
LM	40385	2569.5	40390	2570	40395	2570.5	40400	2571				
HM	40705	2601.5	40690	2600	40685	2599.5	40670	2598				
H	41215	2652.5	41190	2650	41165	2647.5	41140	2645				
LTE Band 66												
	Bandwidth 1.4 MHz		Bandwidth 3 MHz		Bandwidth 5 MHz		Bandwidth 10 MHz		Bandwidth 15 MHz		Bandwidth 20 MHz	
	Ch. #	Freq. (MHz)	Ch. #	Freq. (MHz)	Ch. #	Freq. (MHz)	Ch. #	Freq. (MHz)	Ch. #	Freq. (MHz)	Ch. #	Freq. (MHz)
L	131979	1710.7	131987	1711.5	131997	1712.5	132022	1715	132047	1717.5	132072	1720
M	132322	1745	132322	1745	132322	1745	132322	1745	132322	1745	132322	1745
H	132665	1779.3	132657	1778.5	132647	1777.5	132622	1775	132597	1772.5	132572	1770

5. Proximity Sensor Triggering Test

5.1 Proximity sensor triggering distances(Per KDB616217§6.2)

1. Proximity sensor triggering distance testing was performed according to the procedures outlined in KDB 616217 D04 section 6.2, and EUT moving further away from the flat phantom and EUT moving toward the flat phantom were both assessed and the tissue-equivalent medium for highest frequency (5825MHz) and lowest (835MHz) frequency was used for proximity sensor triggering testing.
2. Capacitive proximity sensor placed coincident with antenna elements at the bottom end of the phone are utilized to determine when the device comes in proximity of the user's body at the front or back or bottom side surface of the device. There is no need to do sensor coverage testing for the proximity sensor is designed to support sufficient detection range and sensitivity to cover regions of the sensors in all applicable directions since the proximity sensor entirely covers the antenna.
3. When the proximity sensor is active, GSM/850/1900, WCDMA band II/IV/V, LTE band 2/4/7/66/38/41 and WLAN2.4GHz/WLAN5.2GHz/5.3GHz/5.5GHz /5.8GHz reduced power will be active for front/ back body worn SAR.
4. P-sensor can detect handheld state, GSM1900, WCDMA band II/IV and LTE band 2/4/66 for front/back/bottom sides of product specific 10g SAR condition reduced powers will be active for handheld SAR.
5. The proximity sensors used to detect the proximity of the user's body at the front or back or bottom side surface of the device use a detection threshold distance. The data shown in the sections below shows the distance(s).
6. For verification of compliance of power reduction scheme, additional SAR testing with EUT transmitting at full RF power at a conservative trigger distance was performed for body worn:
Front: [12 mm](#)
Back: [18 mm](#)
7. For verification of compliance of power reduction scheme, additional SAR testing with EUT transmitting at full RF power at a conservative trigger distance was performed for handheld:
Front: [6 mm](#)
Back: [11 mm](#)
Bottom side: [11 mm](#)

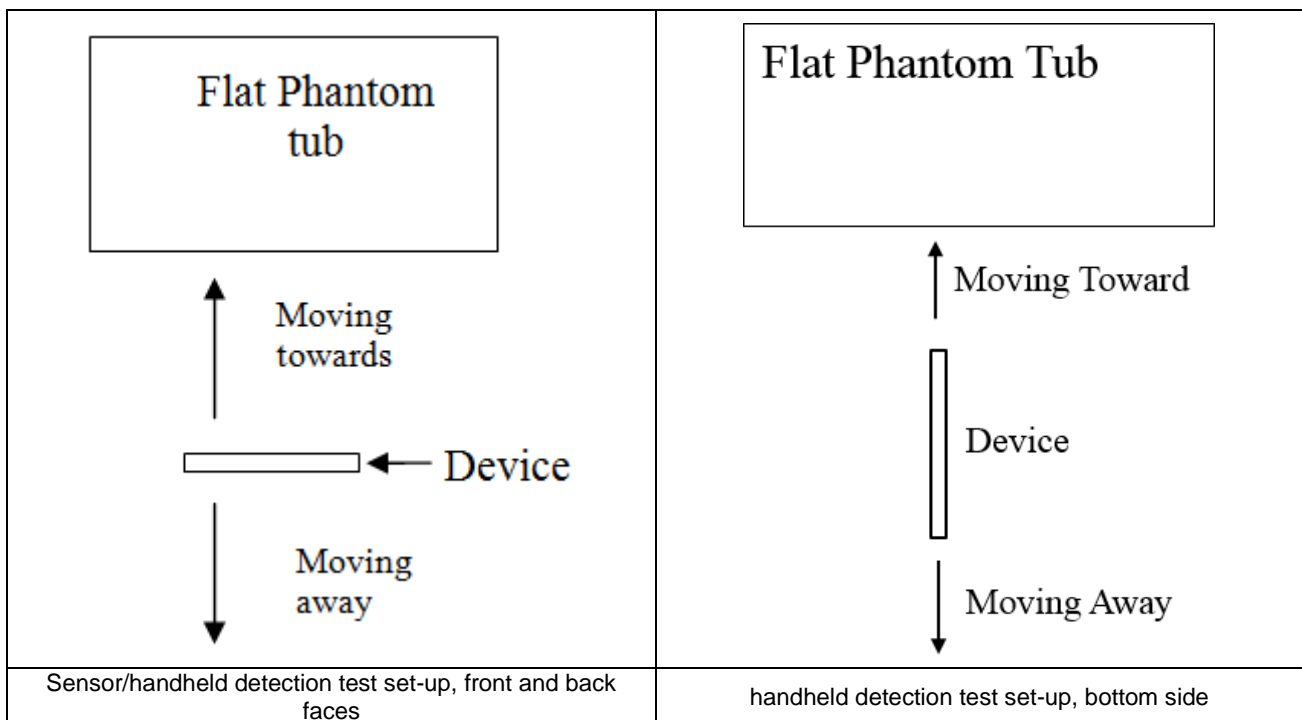



<P-Sensor>

Proximity Sensor Triggering Distance (mm)				
Position	Front		Back	
	Moving towards	Moving away	Moving towards	Moving away
Minimum	13	16	19	21

TX. Band	Proximity Sensor Triggering Power (dBm)		
	Full	Reduced	power reduction (dB)
	max. tune up limit (dBm)	max. tune up limit(dBm)	
GPRS850 3Tx slots	31.5	30.5	1.0
GPRS1900 3Tx slots	28.5	24.0	4.5
WCDMA Band II	24.0	17.0	7.0
WCDMA Band IV	24.0	18.0	6.0
LTE Band 2	24.0	17.0	7.0
LTE Band 4	24.0	19.0	5.0
LTE Band 7	24.0	21.0	3.0
LTE Band 66	24.0	19.0	5.0
LTE Band 38	24.0	23.0	1.0
LTE Band 41	24.0	23.0	1.0
WLAN2.4GHz	22.5	21.0	1.5
WLAN5.2GHz	19.0	15.0	4.0
WLAN5.3GHz	19.0	14.5	4.5
WLAN5.5GHz	19.0	15.0	4.0
WLAN5.8GHz	19.0	14.5	4.5



Proximity Sensor Triggering Distance (mm) and Triggering Power (dBm)																											
Front																											
Distance	50	47	44	41	38	35	32	29	26	23	21	20	19	18	17	16	15	14	13	12	11	10	9	6	3	0	
GPRS850 3Tx slots	31.5	31.5	31.5	31.5	31.5	31.5	31.5	31.5	31.5	31.5	31.5	31.5	31.5	31.5	31.5	31.5	31.5	31.5	30.5	30.5	30.5	30.5	30.5	30.5	30.5	30.5	
GPRS1900 3Tx slots	28.5	28.5	28.5	28.5	28.5	28.5	28.5	28.5	28.5	28.5	28.5	28.5	28.5	28.5	28.5	28.5	28.5	28.5	24.0	24.0	24.0	24.0	24.0	24.0	24.0	24.0	
WCDMA Band II	24.0	24.0	24.0	24.0	24.0	24.0	24.0	24.0	24.0	24.0	24.0	24.0	24.0	24.0	24.0	24.0	24.0	24.0	17.0	17.0	17.0	17.0	17.0	17.0	17.0	17.0	
WCDMA Band IV	24.0	24.0	24.0	24.0	24.0	24.0	24.0	24.0	24.0	24.0	24.0	24.0	24.0	24.0	24.0	24.0	24.0	24.0	18.0	18.0	18.0	18.0	18.0	18.0	18.0	18.0	
LTE Band 2	24.0	24.0	24.0	24.0	24.0	24.0	24.0	24.0	24.0	24.0	24.0	24.0	24.0	24.0	24.0	24.0	24.0	24.0	17.0	17.0	17.0	17.0	17.0	17.0	17.0	17.0	
LTE Band 4	24.0	24.0	24.0	24.0	24.0	24.0	24.0	24.0	24.0	24.0	24.0	24.0	24.0	24.0	24.0	24.0	24.0	24.0	19.0	19.0	19.0	19.0	19.0	19.0	19.0	19.0	
LTE Band 7	24.0	24.0	24.0	24.0	24.0	24.0	24.0	24.0	24.0	24.0	24.0	24.0	24.0	24.0	24.0	24.0	24.0	24.0	21.0	21.0	21.0	21.0	21.0	21.0	21.0	21.0	
LTE Band 66	24.0	24.0	24.0	24.0	24.0	24.0	24.0	24.0	24.0	24.0	24.0	24.0	24.0	24.0	24.0	24.0	24.0	24.0	19.0	19.0	19.0	19.0	19.0	19.0	19.0	19.0	
LTE Band 38	24.0	24.0	24.0	24.0	24.0	24.0	24.0	24.0	24.0	24.0	24.0	24.0	24.0	24.0	24.0	24.0	24.0	24.0	23.0	23.0	23.0	23.0	23.0	23.0	23.0	23.0	
LTE Band 41	24.0	24.0	24.0	24.0	24.0	24.0	24.0	24.0	24.0	24.0	24.0	24.0	24.0	24.0	24.0	24.0	24.0	24.0	23.0	23.0	23.0	23.0	23.0	23.0	23.0	23.0	
WLAN2.4GHz	22.5	22.5	22.5	22.5	22.5	22.5	22.5	22.5	22.5	22.5	22.5	22.5	22.5	22.5	22.5	22.5	22.5	22.5	21.0	21.0	21.0	21.0	21.0	21.0	21.0	21.0	
WLAN5.2GHz	19.0	19.0	19.0	19.0	19.0	19.0	19.0	19.0	19.0	19.0	19.0	19.0	19.0	19.0	19.0	19.0	19.0	19.0	15.0	15.0	15.0	15.0	15.0	15.0	15.0	15.0	
WLAN5.3GHz	19.0	19.0	19.0	19.0	19.0	19.0	19.0	19.0	19.0	19.0	19.0	19.0	19.0	19.0	19.0	19.0	19.0	19.0	14.5	14.5	14.5	14.5	14.5	14.5	14.5	14.5	
WLAN5.5GHz	19.0	19.0	19.0	19.0	19.0	19.0	19.0	19.0	19.0	19.0	19.0	19.0	19.0	19.0	19.0	19.0	19.0	19.0	15.0	15.0	15.0	15.0	15.0	15.0	15.0	15.0	
WLAN5.8GHz	19.0	19.0	19.0	19.0	19.0	19.0	19.0	19.0	19.0	19.0	19.0	19.0	19.0	19.0	19.0	19.0	19.0	19.0	14.5	14.5	14.5	14.5	14.5	14.5	14.5	14.5	

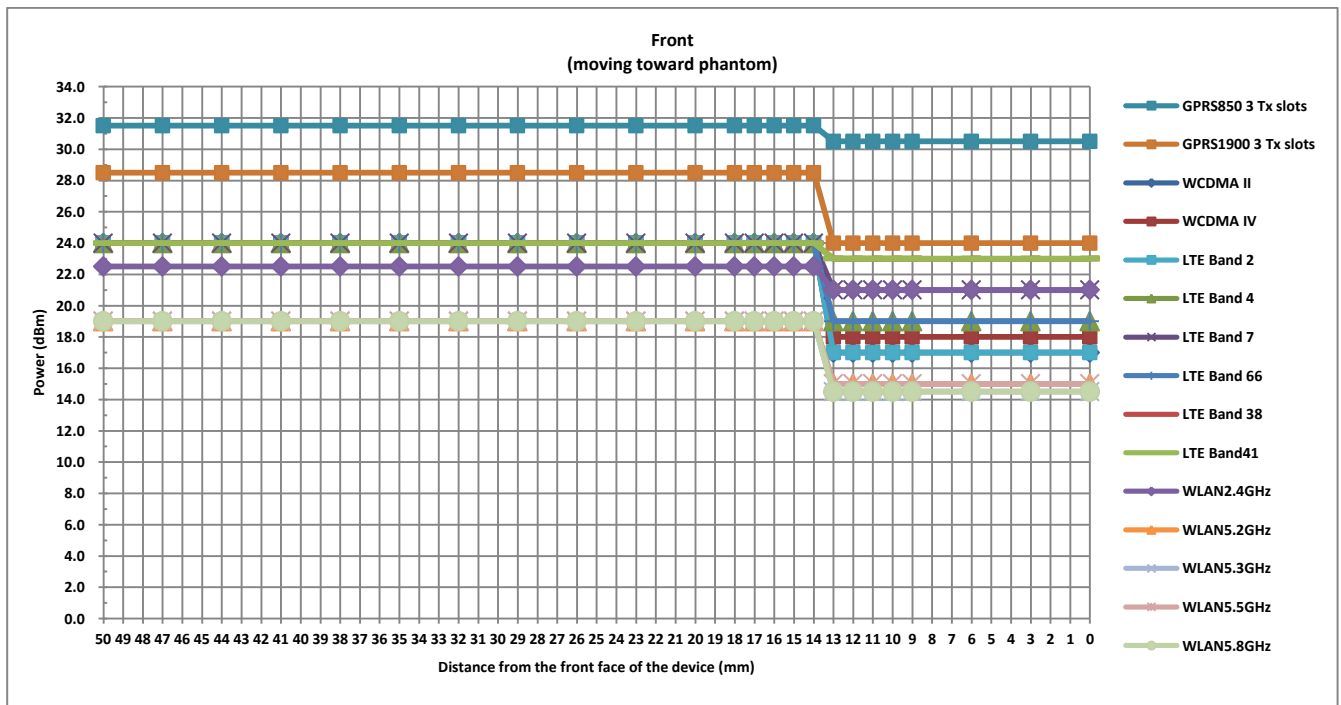



Proximity Sensor Triggering Distance (mm) and Triggering Power (dBm)																										
Front																										
Distance	50	49	46	43	40	37	34	31	28	25	22	21	20	19	18	17	16	15	14	13	12	9	6	3	0	
GPRS850 3Tx slots	31.5	31.5	31.5	31.5	31.5	31.5	31.5	31.5	31.5	31.5	31.5	31.5	31.5	31.5	31.5	31.5	30.5	30.5	30.5	30.5	30.5	30.5	30.5	30.5	30.5	
GPRS1900 3Tx slots	28.5	28.5	28.5	28.5	28.5	28.5	28.5	28.5	28.5	28.5	28.5	28.5	28.5	28.5	28.5	28.5	24.0	24.0	24.0	24.0	24.0	24.0	24.0	24.0	24.0	
WCDMA Band II	24.0	24.0	24.0	24.0	24.0	24.0	24.0	24.0	24.0	24.0	24.0	24.0	24.0	24.0	24.0	24.0	17.0	17.0	17.0	17.0	17.0	17.0	17.0	17.0	17.0	
WCDMA Band IV	24.0	24.0	24.0	24.0	24.0	24.0	24.0	24.0	24.0	24.0	24.0	24.0	24.0	24.0	24.0	24.0	18.0	18.0	18.0	18.0	18.0	18.0	18.0	18.0	18.0	
LTE Band 2	24.0	24.0	24.0	24.0	24.0	24.0	24.0	24.0	24.0	24.0	24.0	24.0	24.0	24.0	24.0	24.0	17.0	17.0	17.0	17.0	17.0	17.0	17.0	17.0	17.0	
LTE Band 4	24.0	24.0	24.0	24.0	24.0	24.0	24.0	24.0	24.0	24.0	24.0	24.0	24.0	24.0	24.0	24.0	19.0	19.0	19.0	19.0	19.0	19.0	19.0	19.0	19.0	
LTE Band 7	24.0	24.0	24.0	24.0	24.0	24.0	24.0	24.0	24.0	24.0	24.0	24.0	24.0	24.0	24.0	24.0	21.0	21.0	21.0	21.0	21.0	21.0	21.0	21.0	21.0	
LTE Band 66	24.0	24.0	24.0	24.0	24.0	24.0	24.0	24.0	24.0	24.0	24.0	24.0	24.0	24.0	24.0	24.0	19.0	19.0	19.0	19.0	19.0	19.0	19.0	19.0	19.0	
LTE Band 38	24.0	24.0	24.0	24.0	24.0	24.0	24.0	24.0	24.0	24.0	24.0	24.0	24.0	24.0	24.0	24.0	23.0	23.0	23.0	23.0	23.0	23.0	23.0	23.0	23.0	
LTE Band 41	24.0	24.0	24.0	24.0	24.0	24.0	24.0	24.0	24.0	24.0	24.0	24.0	24.0	24.0	24.0	24.0	23.0	23.0	23.0	23.0	23.0	23.0	23.0	23.0	23.0	
WLAN2.4GHz	22.5	22.5	22.5	22.5	22.5	22.5	22.5	22.5	22.5	22.5	22.5	22.5	22.5	22.5	22.5	22.5	21.0	21.0	21.0	21.0	21.0	21.0	21.0	21.0	21.0	
WLAN5.2GHz	19.0	19.0	19.0	19.0	19.0	19.0	19.0	19.0	19.0	19.0	19.0	19.0	19.0	19.0	19.0	19.0	15.0	15.0	15.0	15.0	15.0	15.0	15.0	15.0	15.0	
WLAN5.3GHz	19.0	19.0	19.0	19.0	19.0	19.0	19.0	19.0	19.0	19.0	19.0	19.0	19.0	19.0	19.0	19.0	14.5	14.5	14.5	14.5	14.5	14.5	14.5	14.5	14.5	
WLAN5.5GHz	19.0	19.0	19.0	19.0	19.0	19.0	19.0	19.0	19.0	19.0	19.0	19.0	19.0	19.0	19.0	19.0	15.0	15.0	15.0	15.0	15.0	15.0	15.0	15.0	15.0	
WLAN5.8GHz	19.0	19.0	19.0	19.0	19.0	19.0	19.0	19.0	19.0	19.0	19.0	19.0	19.0	19.0	19.0	19.0	14.5	14.5	14.5	14.5	14.5	14.5	14.5	14.5	14.5	

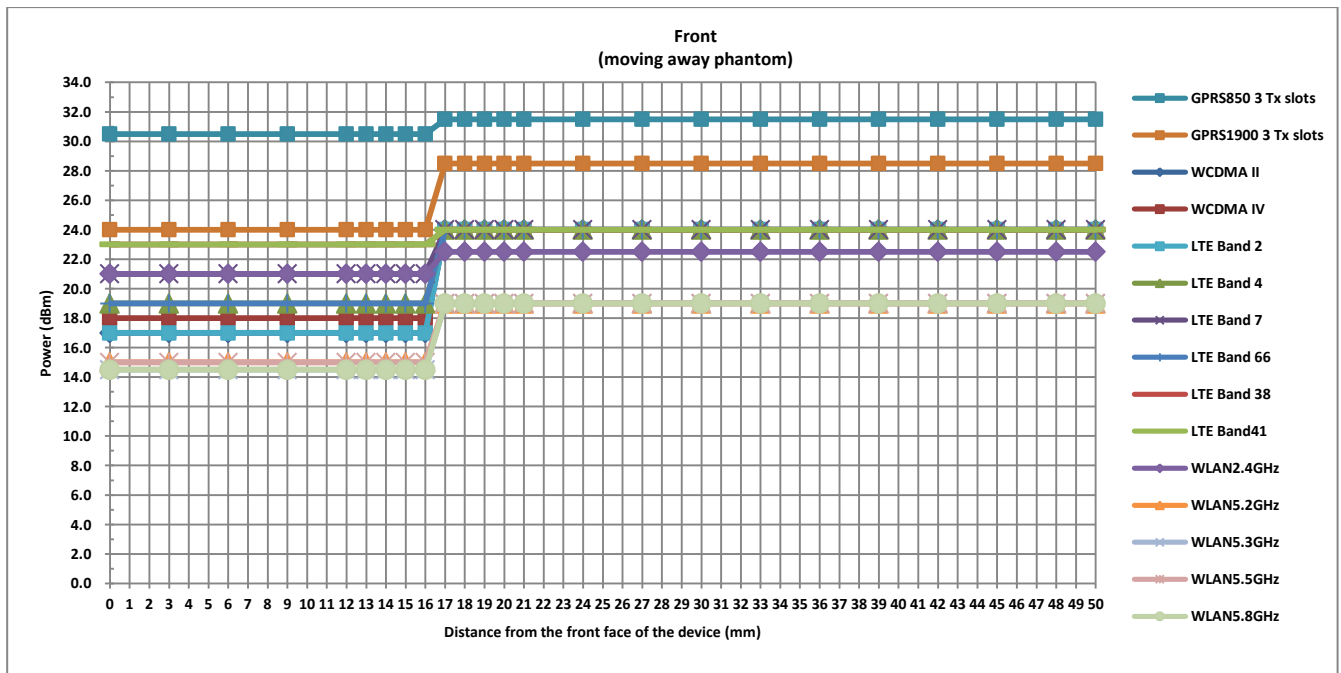



Proximity Sensor Triggering Distance (mm) and Triggering Power (dBm)

Back																										
Distance	50	47	44	41	38	35	32	29	26	25	24	23	22	21	20	19	18	17	16	15	12	9	6	3	0	
GPRS850 3Tx slots	31.5	31.5	31.5	31.5	31.5	31.5	31.5	31.5	31.5	31.5	31.5	31.5	31.5	31.5	31.5	30.5	30.5	30.5	30.5	30.5	30.5	30.5	30.5	30.5	30.5	
GPRS1900 3Tx slots	28.5	28.5	28.5	28.5	28.5	28.5	28.5	28.5	28.5	28.5	28.5	28.5	28.5	28.5	28.5	24.0	24.0	24.0	24.0	24.0	24.0	24.0	24.0	24.0	24.0	
WCDMA Band II	24.0	24.0	24.0	24.0	24.0	24.0	24.0	24.0	24.0	24.0	24.0	24.0	24.0	24.0	24.0	17.0	17.0	17.0	17.0	17.0	17.0	17.0	17.0	17.0	17.0	
WCDMA Band IV	24.0	24.0	24.0	24.0	24.0	24.0	24.0	24.0	24.0	24.0	24.0	24.0	24.0	24.0	24.0	18.0	18.0	18.0	18.0	18.0	18.0	18.0	18.0	18.0	18.0	
LTE Band 2	24.0	24.0	24.0	24.0	24.0	24.0	24.0	24.0	24.0	24.0	24.0	24.0	24.0	24.0	24.0	17.0	17.0	17.0	17.0	17.0	17.0	17.0	17.0	17.0	17.0	
LTE Band 4	24.0	24.0	24.0	24.0	24.0	24.0	24.0	24.0	24.0	24.0	24.0	24.0	24.0	24.0	24.0	19.0	19.0	19.0	19.0	19.0	19.0	19.0	19.0	19.0	19.0	
LTE Band 7	24.0	24.0	24.0	24.0	24.0	24.0	24.0	24.0	24.0	24.0	24.0	24.0	24.0	24.0	24.0	21.0	21.0	21.0	21.0	21.0	21.0	21.0	21.0	21.0	21.0	
LTE Band 66	24.0	24.0	24.0	24.0	24.0	24.0	24.0	24.0	24.0	24.0	24.0	24.0	24.0	24.0	24.0	19.0	19.0	19.0	19.0	19.0	19.0	19.0	19.0	19.0	19.0	
LTE Band 38	24.0	24.0	24.0	24.0	24.0	24.0	24.0	24.0	24.0	24.0	24.0	24.0	24.0	24.0	24.0	23.0	23.0	23.0	23.0	23.0	23.0	23.0	23.0	23.0	23.0	
LTE Band 41	24.0	24.0	24.0	24.0	24.0	24.0	24.0	24.0	24.0	24.0	24.0	24.0	24.0	24.0	24.0	23.0	23.0	23.0	23.0	23.0	23.0	23.0	23.0	23.0	23.0	
WLAN2.4GHz	22.5	22.5	22.5	22.5	22.5	22.5	22.5	22.5	22.5	22.5	22.5	22.5	22.5	22.5	22.5	21.0	21.0	21.0	21.0	21.0	21.0	21.0	21.0	21.0	21.0	
WLAN5.2GHz	19.0	19.0	19.0	19.0	19.0	19.0	19.0	19.0	19.0	19.0	19.0	19.0	19.0	19.0	19.0	15.0	15.0	15.0	15.0	15.0	15.0	15.0	15.0	15.0	15.0	
WLAN5.3GHz	19.0	19.0	19.0	19.0	19.0	19.0	19.0	19.0	19.0	19.0	19.0	19.0	19.0	19.0	19.0	14.5	14.5	14.5	14.5	14.5	14.5	14.5	14.5	14.5	14.5	
WLAN5.5GHz	19.0	19.0	19.0	19.0	19.0	19.0	19.0	19.0	19.0	19.0	19.0	19.0	19.0	19.0	19.0	15.0	15.0	15.0	15.0	15.0	15.0	15.0	15.0	15.0	15.0	
WLAN5.8GHz	19.0	19.0	19.0	19.0	19.0	19.0	19.0	19.0	19.0	19.0	19.0	19.0	19.0	19.0	19.0	14.5	14.5	14.5	14.5	14.5	14.5	14.5	14.5	14.5	14.5	

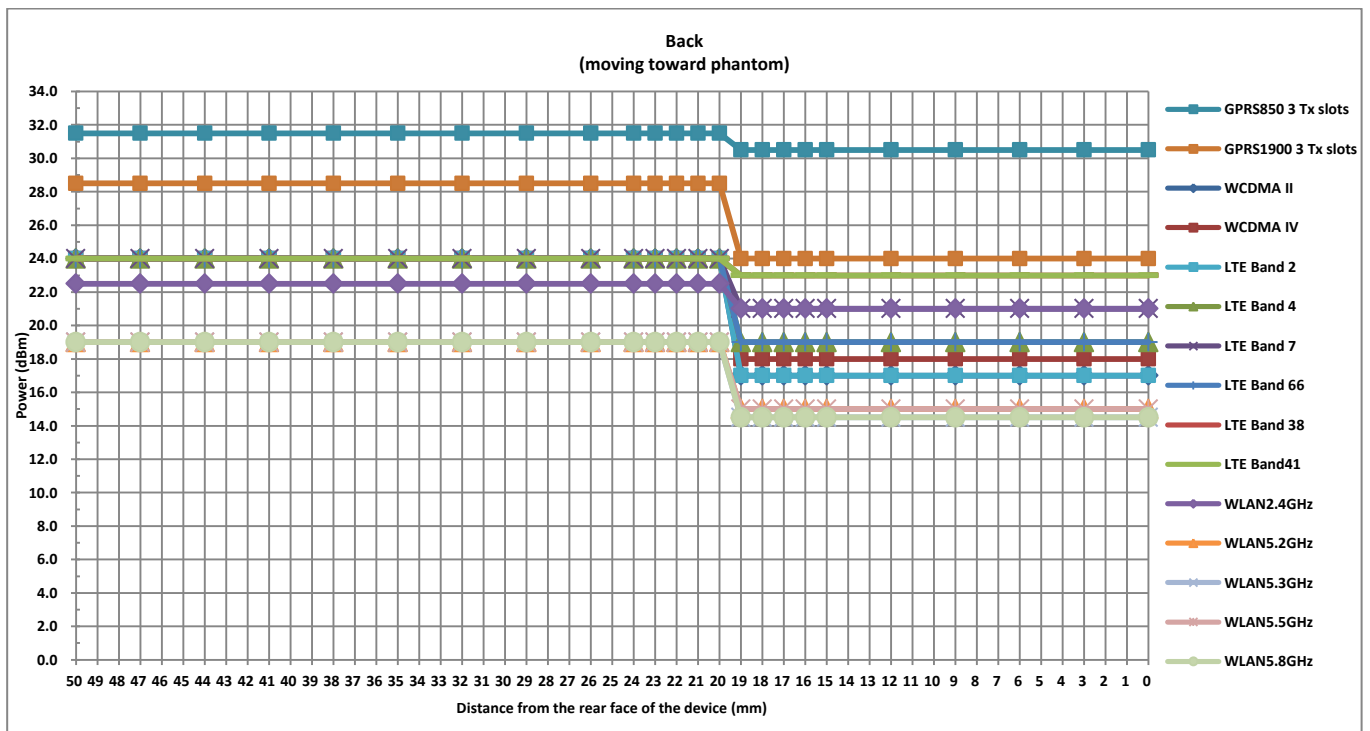



Proximity Sensor Triggering Distance (mm) and Triggering Power (dBm)

Distance	Back																													
	50	49	46	43	40	37	34	31	30	29	28	27	26	25	24	23	22	21	20	19	18	17	15	12	9	6	3	0		
GPRS850 3Tx slots	31.5	31.5	31.5	31.5	31.5	31.5	31.5	31.5	31.5	31.5	31.5	31.5	31.5	31.5	31.5	31.5	31.5	30.5	30.5	30.5	30.5	30.5	30.5	30.5	30.5	30.5	30.5	30.5	30.5	
GPRS1900 3Tx slots	28.5	28.5	28.5	28.5	28.5	28.5	28.5	28.5	28.5	28.5	28.5	28.5	28.5	28.5	28.5	28.5	28.5	24.0	24.0	24.0	24.0	24.0	24.0	24.0	24.0	24.0	24.0	24.0	24.0	
WCDMA Band II	24.0	24.0	24.0	24.0	24.0	24.0	24.0	24.0	24.0	24.0	24.0	24.0	24.0	24.0	24.0	24.0	24.0	17.0	17.0	17.0	17.0	17.0	17.0	17.0	17.0	17.0	17.0	17.0	17.0	
WCDMA Band IV	24.0	24.0	24.0	24.0	24.0	24.0	24.0	24.0	24.0	24.0	24.0	24.0	24.0	24.0	24.0	24.0	24.0	18.0	18.0	18.0	18.0	18.0	18.0	18.0	18.0	18.0	18.0	18.0	18.0	
LTE Band 2	24.0	24.0	24.0	24.0	24.0	24.0	24.0	24.0	24.0	24.0	24.0	24.0	24.0	24.0	24.0	24.0	24.0	17.0	17.0	17.0	17.0	17.0	17.0	17.0	17.0	17.0	17.0	17.0	17.0	
LTE Band 4	24.0	24.0	24.0	24.0	24.0	24.0	24.0	24.0	24.0	24.0	24.0	24.0	24.0	24.0	24.0	24.0	24.0	19.0	19.0	19.0	19.0	19.0	19.0	19.0	19.0	19.0	19.0	19.0	19.0	
LTE Band 7	24.0	24.0	24.0	24.0	24.0	24.0	24.0	24.0	24.0	24.0	24.0	24.0	24.0	24.0	24.0	24.0	24.0	21.0	21.0	21.0	21.0	21.0	21.0	21.0	21.0	21.0	21.0	21.0	21.0	
LTE Band 66	24.0	24.0	24.0	24.0	24.0	24.0	24.0	24.0	24.0	24.0	24.0	24.0	24.0	24.0	24.0	24.0	24.0	19.0	19.0	19.0	19.0	19.0	19.0	19.0	19.0	19.0	19.0	19.0	19.0	
LTE Band 38	24.0	24.0	24.0	24.0	24.0	24.0	24.0	24.0	24.0	24.0	24.0	24.0	24.0	24.0	24.0	24.0	24.0	23.0	23.0	23.0	23.0	23.0	23.0	23.0	23.0	23.0	23.0	23.0	23.0	
LTE Band 41	24.0	24.0	24.0	24.0	24.0	24.0	24.0	24.0	24.0	24.0	24.0	24.0	24.0	24.0	24.0	24.0	24.0	23.0	23.0	23.0	23.0	23.0	23.0	23.0	23.0	23.0	23.0	23.0	23.0	
WLAN2.4GHz	22.5	22.5	22.5	22.5	22.5	22.5	22.5	22.5	22.5	22.5	22.5	22.5	22.5	22.5	22.5	22.5	22.5	21.0	21.0	21.0	21.0	21.0	21.0	21.0	21.0	21.0	21.0	21.0	21.0	
WLAN5.2GHz	19.0	19.0	19.0	19.0	19.0	19.0	19.0	19.0	19.0	19.0	19.0	19.0	19.0	19.0	19.0	19.0	19.0	15.0	15.0	15.0	15.0	15.0	15.0	15.0	15.0	15.0	15.0	15.0	15.0	
WLAN5.3GHz	19.0	19.0	19.0	19.0	19.0	19.0	19.0	19.0	19.0	19.0	19.0	19.0	19.0	19.0	19.0	19.0	19.0	14.5	14.5	14.5	14.5	14.5	14.5	14.5	14.5	14.5	14.5	14.5	14.5	
WLAN5.5GHz	19.0	19.0	19.0	19.0	19.0	19.0	19.0	19.0	19.0	19.0	19.0	19.0	19.0	19.0	19.0	19.0	19.0	15.0	15.0	15.0	15.0	15.0	15.0	15.0	15.0	15.0	15.0	15.0	15.0	
WLAN5.8GHz	19.0	19.0	19.0	19.0	19.0	19.0	19.0	19.0	19.0	19.0	19.0	19.0	19.0	19.0	19.0	19.0	19.0	14.5	14.5	14.5	14.5	14.5	14.5	14.5	14.5	14.5	14.5	14.5	14.5	

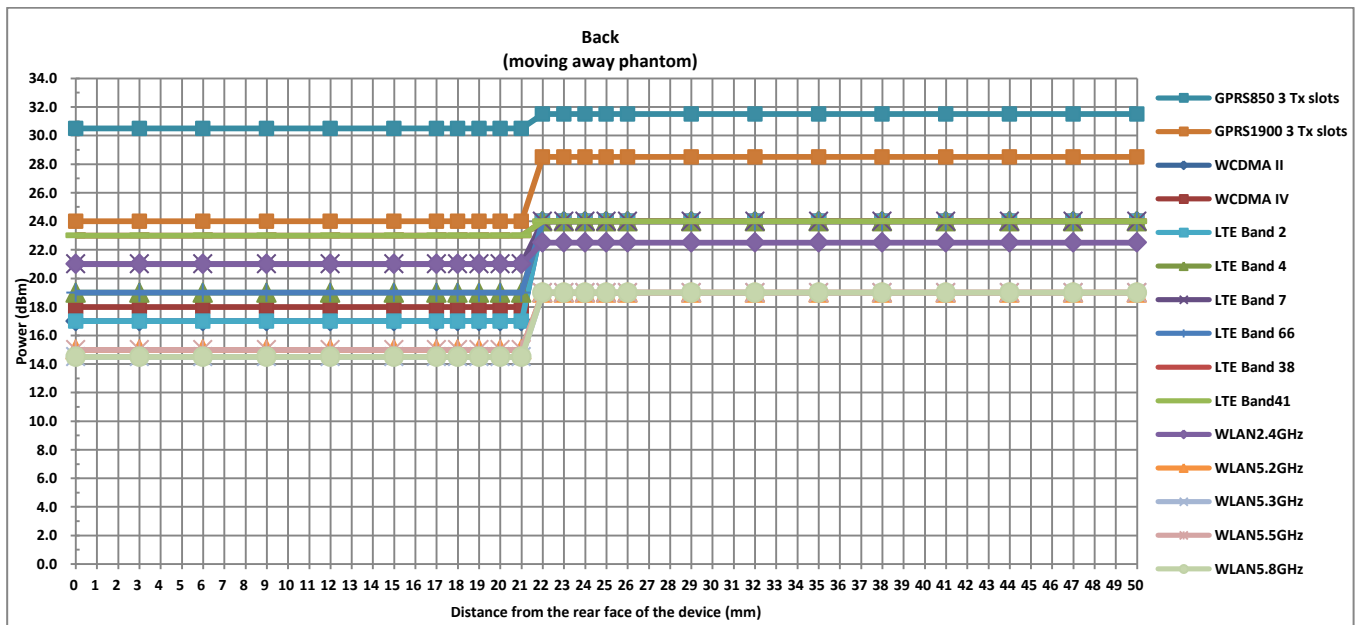



<Handheld>

Position	Front		Back		Bottom Side	
	Moving towards	Moving away	Moving towards	Moving away	Moving towards	Moving away
Minimum	7	9	12	14	12	16

TX. Band	Handheld Triggering Power (dBm)		
	Full	Reduced	power reduction (dB)
	max. tune up limit (dBm)	max. tune up limit(dBm)	
GPRS1900 4 Tx slots	28.5	25.5	3.0
WCDMA II	24.0	20.5	3.5
WCDMA IV	24.0	20.5	3.5
LTE Band2	24.0	19.5	4.5
LTE Band4	24.0	21.5	2.5
LTE Band66	24.0	21.5	2.5



Handheld Triggering Distance (mm) and Triggering Power (dBm)																								
Front																								
Distance	50	47	44	41	38	35	32	29	26	23	20	17	14	12	11	10	9	8	7	6	5	4	3	0
GPRS1900 4 Tx slots	28.5	28.5	28.5	28.5	28.5	28.5	28.5	28.5	28.5	28.5	28.5	28.5	28.5	28.5	28.5	28.5	28.5	28.5	25.5	25.5	25.5	25.5	25.5	25.5
WCDMA II	24.0	24.0	24.0	24.0	24.0	24.0	24.0	24.0	24.0	24.0	24.0	24.0	24.0	24.0	24.0	24.0	24.0	24.0	20.5	20.5	20.5	20.5	20.5	20.5
WCDMA IV	24.0	24.0	24.0	24.0	24.0	24.0	24.0	24.0	24.0	24.0	24.0	24.0	24.0	24.0	24.0	24.0	24.0	24.0	20.5	20.5	20.5	20.5	20.5	20.5
LTE Band2	24.0	24.0	24.0	24.0	24.0	24.0	24.0	24.0	24.0	24.0	24.0	24.0	24.0	24.0	24.0	24.0	24.0	24.0	21.5	21.5	21.5	21.5	21.5	21.5
LTE Band4	24.0	24.0	24.0	24.0	24.0	24.0	24.0	24.0	24.0	24.0	24.0	24.0	24.0	24.0	24.0	24.0	24.0	24.0	21.5	21.5	21.5	21.5	21.5	21.5
LTE Band66	24.0	24.0	24.0	24.0	24.0	24.0	24.0	24.0	24.0	24.0	24.0	24.0	24.0	24.0	24.0	24.0	24.0	24.0	21.5	21.5	21.5	21.5	21.5	21.5

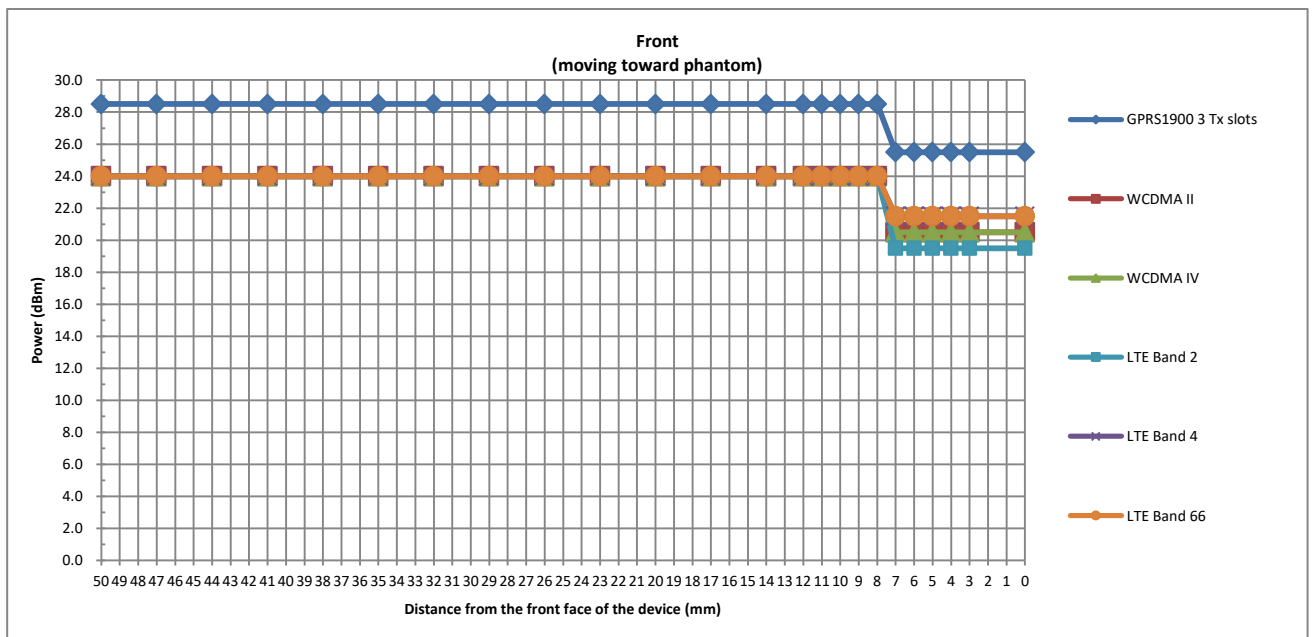



Handheld Triggering Distance (mm) and Triggering Power (dBm)																									
Front																									
Distance	50	48	45	42	39	36	33	30	27	24	21	18	15	14	13	12	11	10	9	8	7	6	5	3	0
GPRS1900 4 Tx slots	28.5	28.5	28.5	28.5	28.5	28.5	28.5	28.5	28.5	28.5	28.5	28.5	28.5	28.5	28.5	28.5	28.5	28.5	25.5	25.5	25.5	25.5	25.5	25.5	25.5
WCDMA II	24.0	24.0	24.0	24.0	24.0	24.0	24.0	24.0	24.0	24.0	24.0	24.0	24.0	24.0	24.0	24.0	24.0	24.0	20.5	20.5	20.5	20.5	20.5	20.5	20.5
WCDMA IV	24.0	24.0	24.0	24.0	24.0	24.0	24.0	24.0	24.0	24.0	24.0	24.0	24.0	24.0	24.0	24.0	24.0	24.0	20.5	20.5	20.5	20.5	20.5	20.5	20.5
LTE Band2	24.0	24.0	24.0	24.0	24.0	24.0	24.0	24.0	24.0	24.0	24.0	24.0	24.0	24.0	24.0	24.0	24.0	24.0	19.5	19.5	19.5	19.5	19.5	19.5	19.5
LTE Band4	24.0	24.0	24.0	24.0	24.0	24.0	24.0	24.0	24.0	24.0	24.0	24.0	24.0	24.0	24.0	24.0	24.0	24.0	21.5	21.5	21.5	21.5	21.5	21.5	21.5
LTE Band66	24.0	24.0	24.0	24.0	24.0	24.0	24.0	24.0	24.0	24.0	24.0	24.0	24.0	24.0	24.0	24.0	24.0	24.0	21.5	21.5	21.5	21.5	21.5	21.5	21.5

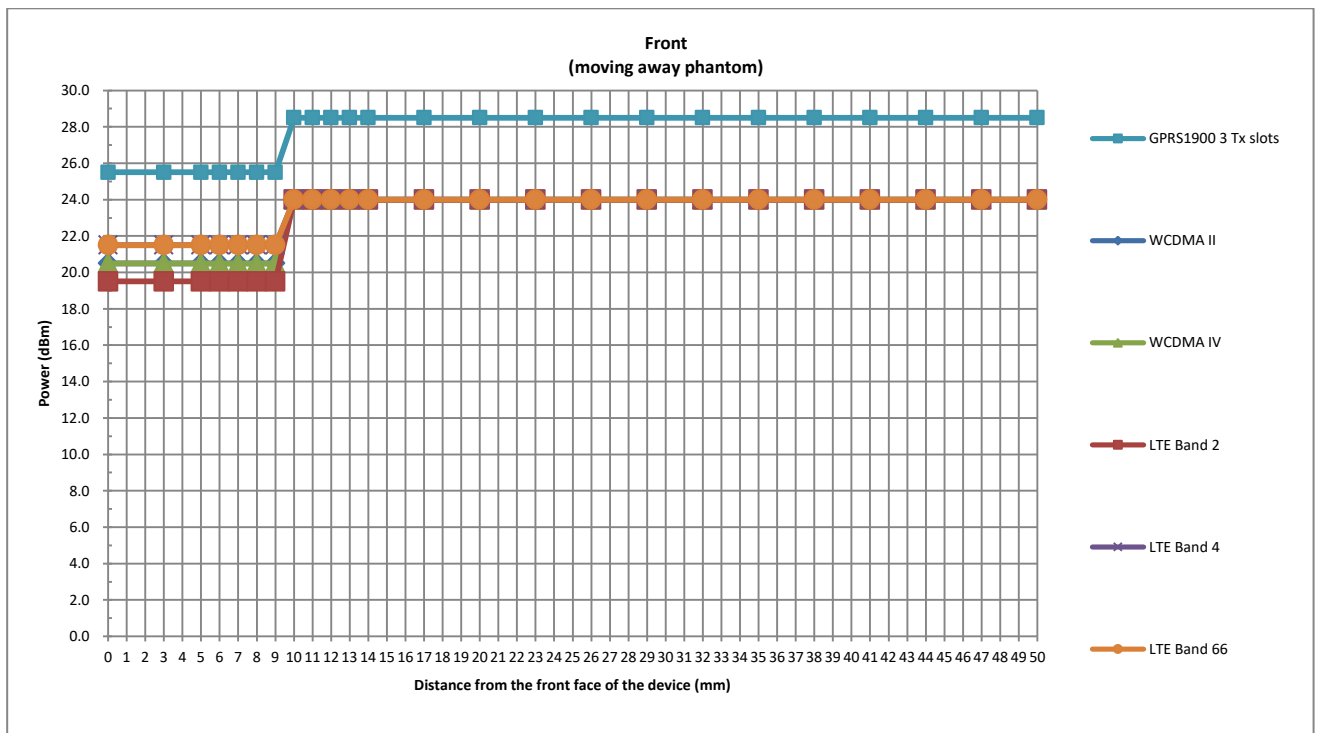



Handheld Triggering Distance (mm) and Triggering Power (dBm)																									
Back																									
Distance	50	47	44	41	38	35	32	29	26	23	20	18	17	16	15	14	13	12	11	10	9	8	6	3	0
GPRS1900 4 Tx slots	28.5	28.5	28.5	28.5	28.5	28.5	28.5	28.5	28.5	28.5	28.5	28.5	28.5	28.5	28.5	28.5	28.5	25.5	25.5	25.5	25.5	25.5	25.5	25.5	25.5
WCDMA II	24.0	24.0	24.0	24.0	24.0	24.0	24.0	24.0	24.0	24.0	24.0	24.0	24.0	24.0	24.0	24.0	24.0	20.5	20.5	20.5	20.5	20.5	20.5	20.5	20.5
WCDMA IV	24.0	24.0	24.0	24.0	24.0	24.0	24.0	24.0	24.0	24.0	24.0	24.0	24.0	24.0	24.0	24.0	24.0	20.5	20.5	20.5	20.5	20.5	20.5	20.5	20.5
LTE Band2	24.0	24.0	24.0	24.0	24.0	24.0	24.0	24.0	24.0	24.0	24.0	24.0	24.0	24.0	24.0	24.0	24.0	19.5	19.5	19.5	19.5	19.5	19.5	19.5	19.5
LTE Band4	24.0	24.0	24.0	24.0	24.0	24.0	24.0	24.0	24.0	24.0	24.0	24.0	24.0	24.0	24.0	24.0	24.0	21.5	21.5	21.5	21.5	21.5	21.5	21.5	21.5
LTE Band66	24.0	24.0	24.0	24.0	24.0	24.0	24.0	24.0	24.0	24.0	24.0	24.0	24.0	24.0	24.0	24.0	24.0	21.5	21.5	21.5	21.5	21.5	21.5	21.5	21.5

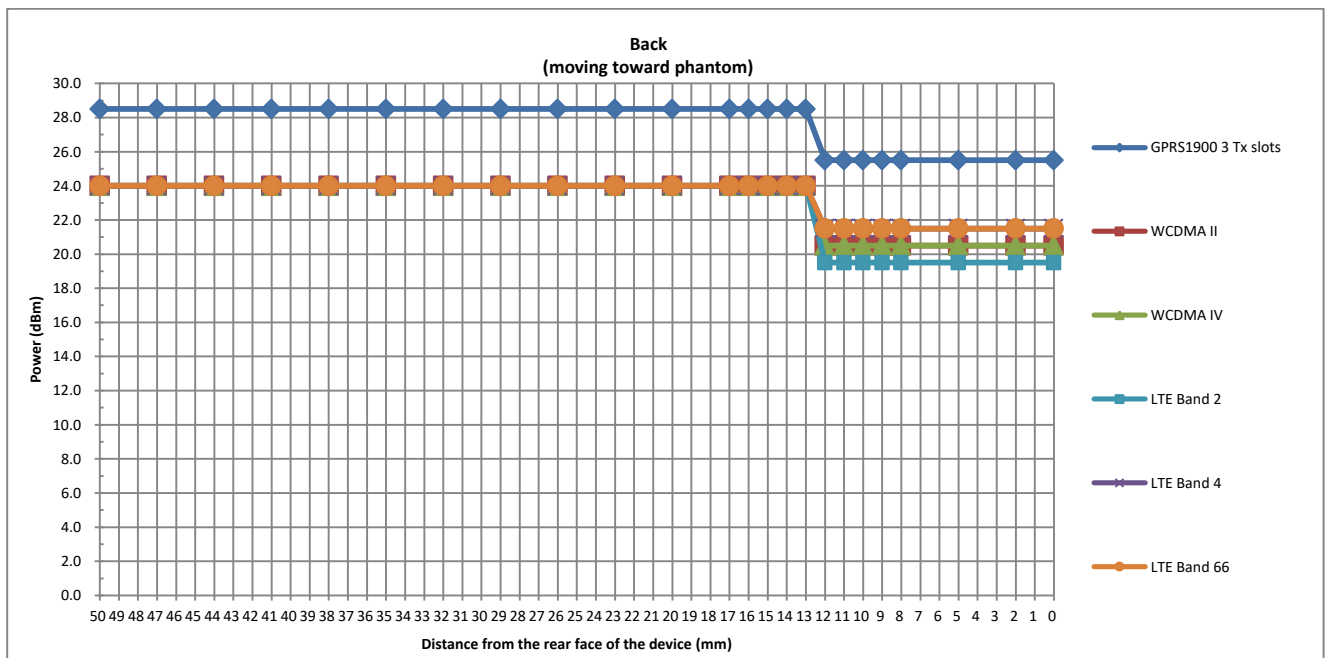



Handheld Triggering Distance (mm) and Triggering Power (dBm)																										
Back																										
Distance	50	48	45	42	39	36	33	30	27	24	21	20	19	18	17	16	15	14	13	12	11	10	9	6	3	0
GPRS1900 4 Tx slots	28.5	28.5	28.5	28.5	28.5	28.5	28.5	28.5	28.5	28.5	28.5	28.5	28.5	28.5	28.5	28.5	28.5	25.5	25.5	25.5	25.5	25.5	25.5	25.5	25.5	25.5
WCDMA II	24.0	24.0	24.0	24.0	24.0	24.0	24.0	24.0	24.0	24.0	24.0	24.0	24.0	24.0	24.0	24.0	24.0	20.5	20.5	20.5	20.5	20.5	20.5	20.5	20.5	20.5
WCDMA IV	24.0	24.0	24.0	24.0	24.0	24.0	24.0	24.0	24.0	24.0	24.0	24.0	24.0	24.0	24.0	24.0	24.0	20.5	20.5	20.5	20.5	20.5	20.5	20.5	20.5	20.5
LTE Band2	24.0	24.0	24.0	24.0	24.0	24.0	24.0	24.0	24.0	24.0	24.0	24.0	24.0	24.0	24.0	24.0	24.0	19.5	19.5	19.5	19.5	19.5	19.5	19.5	19.5	19.5
LTE Band4	24.0	24.0	24.0	24.0	24.0	24.0	24.0	24.0	24.0	24.0	24.0	24.0	24.0	24.0	24.0	24.0	24.0	21.5	21.5	21.5	21.5	21.5	21.5	21.5	21.5	21.5
LTE Band66	24.0	24.0	24.0	24.0	24.0	24.0	24.0	24.0	24.0	24.0	24.0	24.0	24.0	24.0	24.0	24.0	24.0	21.5	21.5	21.5	21.5	21.5	21.5	21.5	21.5	21.5

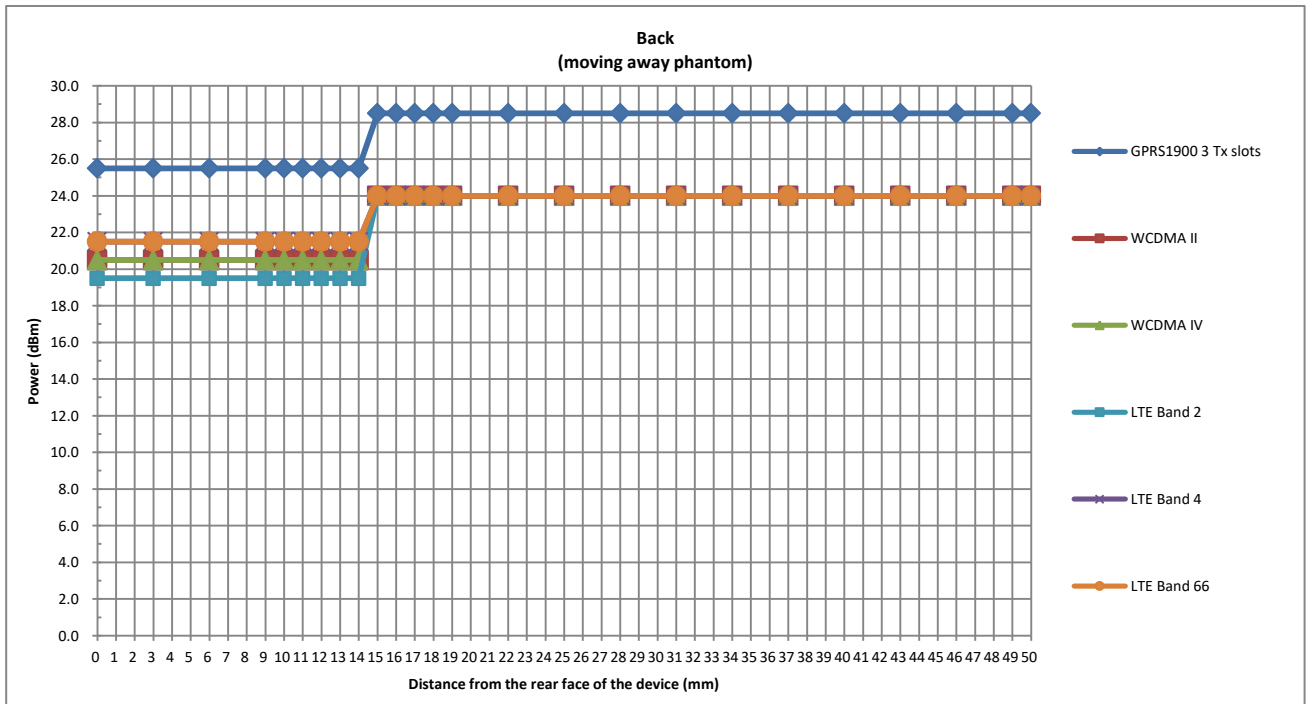



Handheld Triggering Distance (mm) and Triggering Power (dBm)																									
Bottom Side																									
Distance	50	47	44	41	38	35	32	29	26	23	20	17	16	15	14	13	12	11	10	9	8	7	4	1	0
GPRS1900 3 Tx slots	28.5	28.5	28.5	28.5	28.5	28.5	28.5	28.5	28.5	28.5	28.5	28.5	28.5	28.5	28.5	28.5	25.5	25.5	25.5	25.5	25.5	25.5	25.5	25.5	25.5
WCDMA II	24.0	24.0	24.0	24.0	24.0	24.0	24.0	24.0	24.0	24.0	24.0	24.0	24.0	24.0	24.0	24.0	20.5	20.5	20.5	20.5	20.5	20.5	20.5	20.5	20.5
WCDMA IV	24.0	24.0	24.0	24.0	24.0	24.0	24.0	24.0	24.0	24.0	24.0	24.0	24.0	24.0	24.0	24.0	20.5	20.5	20.5	20.5	20.5	20.5	20.5	20.5	20.5
LTE Band2	24.0	24.0	24.0	24.0	24.0	24.0	24.0	24.0	24.0	24.0	24.0	24.0	24.0	24.0	24.0	24.0	21.5	21.5	21.5	21.5	21.5	21.5	21.5	21.5	21.5
LTE Band4	24.0	24.0	24.0	24.0	24.0	24.0	24.0	24.0	24.0	24.0	24.0	24.0	24.0	24.0	24.0	24.0	21.5	21.5	21.5	21.5	21.5	21.5	21.5	21.5	21.5
LTE Band66	24.0	24.0	24.0	24.0	24.0	24.0	24.0	24.0	24.0	24.0	24.0	24.0	24.0	24.0	24.0	24.0	19.5	19.5	19.5	19.5	19.5	19.5	19.5	19.5	19.5

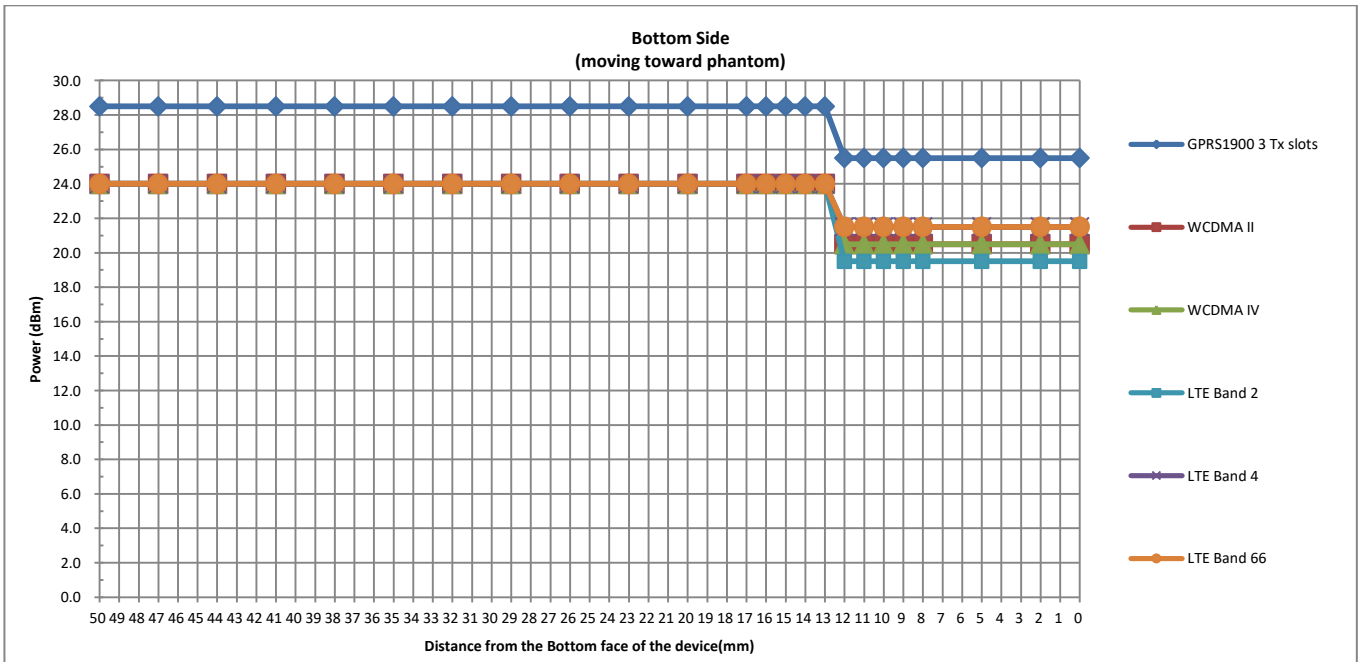



Handheld Triggering Distance (mm) and Triggering Power (dBm)																											
Bottom Side																											
Distance	50	46	43	40	37	34	31	28	25	22	21	20	19	18	17	16	15	14	13	12	11	10	9	6	3	0	
GPRS1900 3 Tx slots	28.5	28.5	28.5	28.5	28.5	28.5	28.5	28.5	28.5	28.5	28.5	28.5	28.5	28.5	28.5	25.5	25.5	25.5	25.5	25.5	25.5	25.5	25.5	25.5	25.5	25.5	
WCDMA II	24.0	24.0	24.0	24.0	24.0	24.0	24.0	24.0	24.0	24.0	24.0	24.0	24.0	24.0	24.0	20.5	20.5	20.5	20.5	20.5	20.5	20.5	20.5	20.5	20.5	20.5	20.5
WCDMA IV	24.0	24.0	24.0	24.0	24.0	24.0	24.0	24.0	24.0	24.0	24.0	24.0	24.0	24.0	24.0	20.5	20.5	20.5	20.5	20.5	20.5	20.5	20.5	20.5	20.5	20.5	20.5
LTE Band2	24.0	24.0	24.0	24.0	24.0	24.0	24.0	24.0	24.0	24.0	24.0	24.0	24.0	24.0	24.0	21.5	21.5	21.5	21.5	21.5	21.5	21.5	21.5	21.5	21.5	21.5	21.5
LTE Band4	24.0	24.0	24.0	24.0	24.0	24.0	24.0	24.0	24.0	24.0	24.0	24.0	24.0	24.0	24.0	19.5	19.5	19.5	19.5	19.5	19.5	19.5	19.5	19.5	19.5	19.5	19.5
LTE Band66	24.0	24.0	24.0	24.0	24.0	24.0	24.0	24.0	24.0	24.0	24.0	24.0	24.0	24.0	24.0	21.5	21.5	21.5	21.5	21.5	21.5	21.5	21.5	21.5	21.5	21.5	21.5

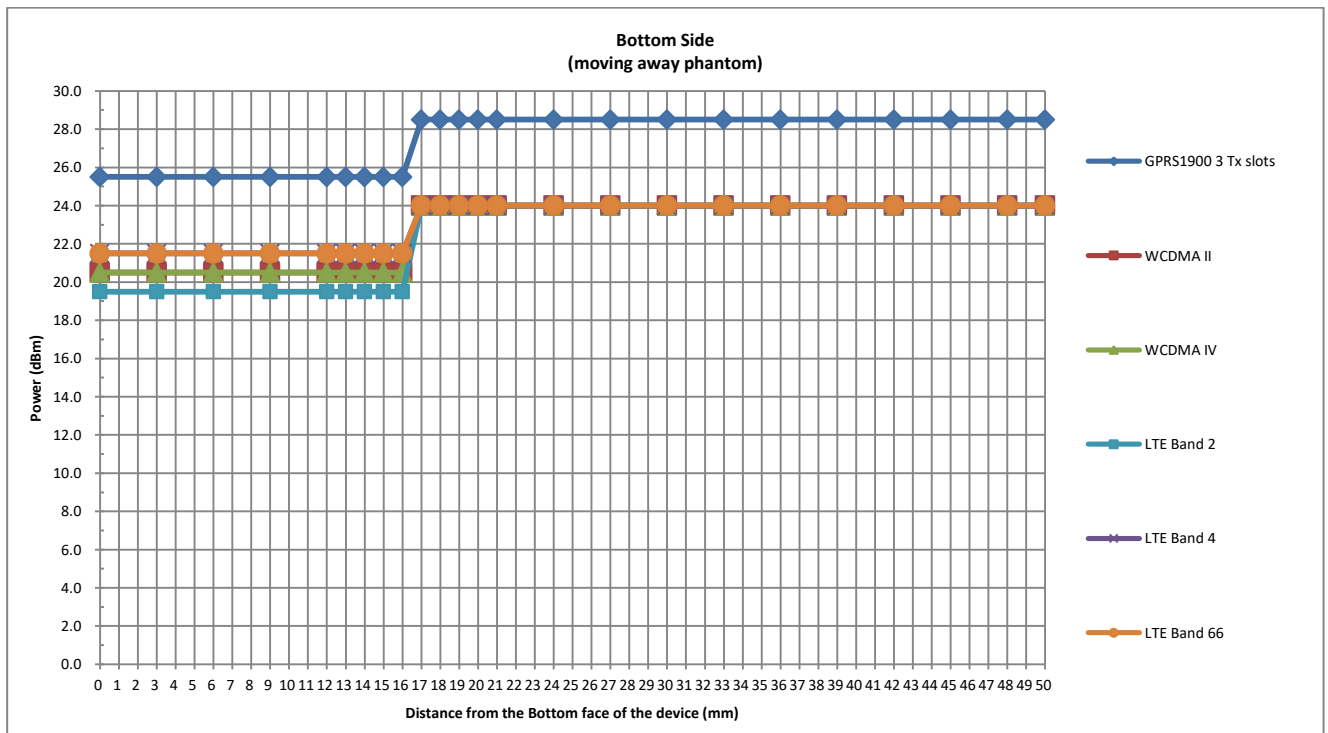

6. RF Exposure Limits

6.1 Uncontrolled Environment

Uncontrolled Environments are defined as locations where there is the exposure of individuals who have no knowledge or control of their exposure. The general population/uncontrolled exposure limits are applicable to situations in which the general public may be exposed or in which persons who are exposed as a consequence of their employment may not be made fully aware of the potential for exposure or cannot exercise control over their exposure. Members of the general public would come under this category when exposure is not employment-related; for example, in the case of a wireless transmitter that exposes persons in its vicinity.

6.2 Controlled Environment

Controlled Environments are defined as locations where there is exposure that may be incurred by persons who are aware of the potential for exposure, (i.e. as a result of employment or occupation). In general, occupational/controlled exposure limits are applicable to situations in which persons are exposed as a consequence of their employment, who have been made fully aware of the potential for exposure and can exercise control over their exposure. The exposure category is also applicable when the exposure is of a transient nature due to incidental passage through a location where the exposure levels may be higher than the general population/uncontrolled limits, but the exposed person is fully aware of the potential for exposure and can exercise control over his or her exposure by leaving the area or by some other appropriate means.

Limits for Occupational/Controlled Exposure (W/kg)

Whole-Body	Partial-Body	Hands, Wrists, Feet and Ankles
0.4	8.0	20.0

Limits for General Population/Uncontrolled Exposure (W/kg)

Whole-Body	Partial-Body	Hands, Wrists, Feet and Ankles
0.08	1.6	4.0

Whole-Body SAR is averaged over the entire body, partial-body SAR is averaged over any 1gram of tissue defined as a tissue volume in the shape of a cube. SAR for hands, wrists, feet and ankles is averaged over any 10 grams of tissue defined as a tissue volume in the shape of a cube.

7. Specific Absorption Rate (SAR)

7.1 Introduction

SAR is related to the rate at which energy is absorbed per unit mass in an object exposed to a radio field. The SAR distribution in a biological body is complicated and is usually carried out by experimental techniques or numerical modeling. The standard recommends limits for two tiers of groups, occupational/controlled and general population/uncontrolled, based on a person's awareness and ability to exercise control over his or her exposure. In general, occupational/controlled exposure limits are higher than the limits for general population/uncontrolled.

7.2 SAR Definition

The SAR definition is the time derivative (rate) of the incremental energy (dW) absorbed by (dissipated in) an incremental mass (dm) contained in a volume element (dv) of a given density (ρ). The equation description is as below:

$$\text{SAR} = \frac{d}{dt} \left(\frac{dW}{dm} \right) = \frac{d}{dt} \left(\frac{dW}{\rho dv} \right)$$

SAR is expressed in units of Watts per kilogram (W/kg)

$$\text{SAR} = \frac{\sigma |E|^2}{\rho}$$

Where: σ is the conductivity of the tissue, ρ is the mass density of the tissue and E is the RMS electrical field strength.

8. System Description and Setup

The DASY system used for performing compliance tests consists of the following items:

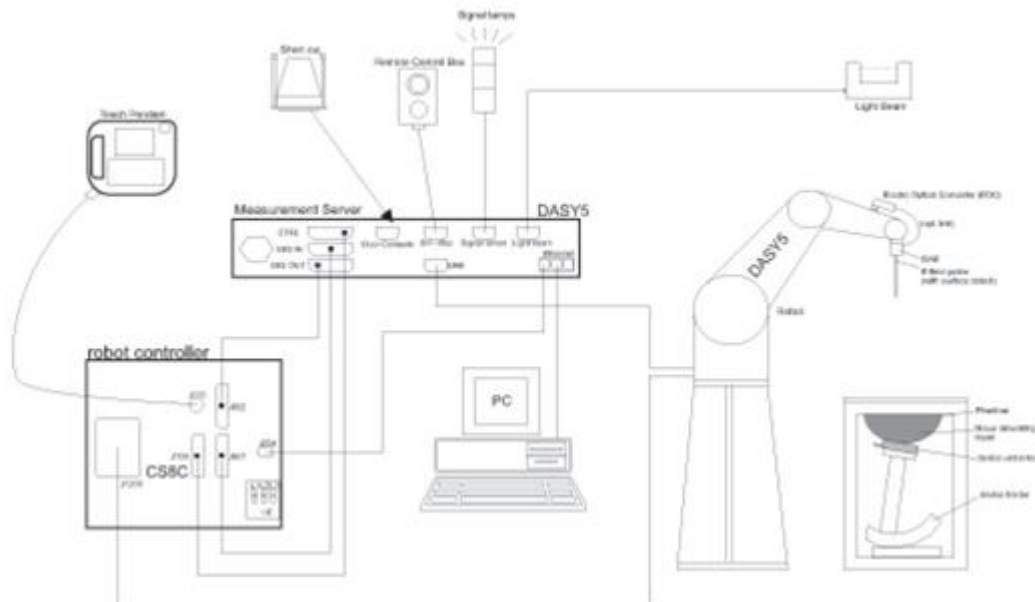

- A standard high precision 6-axis robot with controller, teach pendant and software. An arm extension for accommodating the data acquisition electronics (DAE).
- An isotropic Field probe optimized and calibrated for the targeted measurement.
- A data acquisition electronics (DAE) which performs the signal amplification, signal multiplexing, AD-conversion, offset measurements, mechanical surface detection, collision detection, etc. The unit is battery powered with standard or rechargeable batteries. The signal is optically transmitted to the EOC.
- The Electro-optical converter (EOC) performs the conversion from optical to electrical signals for the digital communication to the DAE. To use optical surface detection, a special version of the EOC is required. The EOC signal is transmitted to the measurement server.
- The function of the measurement server is to perform the time critical tasks such as signal filtering, control of the robot operation and fast movement interrupts.
- The Light Beam used is for probe alignment. This improves the (absolute) accuracy of the probe positioning.
- A computer running WinXP or Win7 and the DASY5 software.
- Remote control and teach pendant as well as additional circuitry for robot safety such as warning lamps, etc.
- The phantom, the device holder and other accessories according to the targeted measurement.

8.1 E-Field Probe

The SAR measurement is conducted with the dosimetric probe (manufactured by SPEAG).The probe is specially designed and calibrated for use in liquid with high permittivity. The dosimetric probe has special calibration in liquid at different frequency. This probe has a built in optical surface detection system to prevent from collision with phantom.

<EX3DV4 Probe>

Construction	Symmetric design with triangular core Built-in shielding against static charges PEEK enclosure material (resistant to organic solvents, e.g., DGBE)	
Frequency	10 MHz – >6 GHz Linearity: ±0.2 dB (30 MHz – 6 GHz)	
Directivity	±0.3 dB in TSL (rotation around probe axis) ±0.5 dB in TSL (rotation normal to probe axis)	
Dynamic Range	10 µW/g – >100 mW/g Linearity: ±0.2 dB (noise: typically <1 µW/g)	
Dimensions	Overall length: 337 mm (tip: 20 mm) Tip diameter: 2.5 mm (body: 12 mm) Typical distance from probe tip to dipole centers: 1 mm	

<ES3DV3 Probe>

Construction	Symmetric design with triangular core Interleaved sensors Built-in shielding against static charges PEEK enclosure material (resistant to organic solvents, e.g., DGBE)	
Frequency	10 MHz – 4 GHz; Linearity: ±0.2 dB (30 MHz – 4 GHz)	
Directivity	±0.2 dB in TSL (rotation around probe axis) ±0.3 dB in TSL (rotation normal to probe axis)	
Dynamic Range	5 µW/g – >100 mW/g; Linearity: ±0.2 dB	
Dimensions	Overall length: 337 mm (tip: 20 mm) Tip diameter: 3.9 mm (body: 12 mm) Distance from probe tip to dipole centers: 3.0 mm	

8.2 Data Acquisition Electronics (DAE)

The data acquisition electronics (DAE) consists of a highly sensitive electrometer-grade preamplifier with auto-zeroing, a channel and gain-switching multiplexer, a fast 16 bit AD-converter and a command decoder and control logic unit. Transmission to the measurement server is accomplished through an optical downlink for data and status information as well as an optical uplink for commands and the clock.

The input impedance of the DAE is 200 MOhm; the inputs are symmetrical and floating. Common mode rejection is above 80 dB.



Photo of DAE

8.3 Phantom

<SAM Twin Phantom>

Shell Thickness	2 ± 0.2 mm; Center ear point: 6 ± 0.2 mm	
Filling Volume	Approx. 25 liters	
Dimensions	Length: 1000 mm; Width: 500 mm; Height: adjustable feet	
Measurement Areas	Left Hand, Right Hand, Flat Phantom	

The bottom plate contains three pair of bolts for locking the device holder. The device holder positions are adjusted to the standard measurement positions in the three sections. A white cover is provided to tap the phantom during off-periods to prevent water evaporation and changes in the liquid parameters. On the phantom top, three reference markers are provided to identify the phantom position with respect to the robot.

<ELI Phantom>

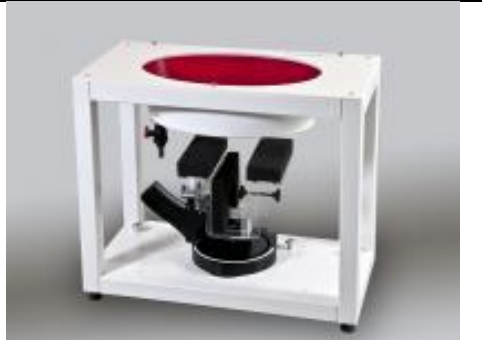
Shell Thickness	2 ± 0.2 mm (sagging: <1%)	
Filling Volume	Approx. 30 liters	
Dimensions	Major ellipse axis: 600 mm Minor axis: 400 mm	

The ELI phantom is intended for compliance testing of handheld and body-mounted wireless devices in the frequency range of 30 MHz to 6 GHz. ELI4 is fully compatible with standard and all known tissue simulating liquids.

8.4 Device Holder

<Mounting Device for Hand-Held Transmitter>

In combination with the Twin SAM V5.0/V5.0c or ELI phantoms, the Mounting Device for Hand-Held Transmitters enables rotation of the mounted transmitter device to specified spherical coordinates. At the heads, the rotation axis is at the ear opening. Transmitter devices can be easily and accurately positioned according to IEC 62209-1, IEEE 1528, FCC, or other specifications. The device holder can be locked for positioning at different phantom sections (left head, right head, flat). And upgrade kit to Mounting Device to enable easy mounting of wider devices like big smart-phones, e-books, small tablets, etc. It holds devices with width up to 140 mm.



Mounting Device for Hand-Held Transmitters



Mounting Device Adaptor for Wide-Phones

<Mounting Device for Laptops and other Body-Worn Transmitters>

The extension is lightweight and made of POM, acrylic glass and foam. It fits easily on the upper part of the mounting device in place of the phone positioned. The extension is fully compatible with the SAM Twin and ELI phantoms.



Mounting Device for Laptops

9. Measurement Procedures

The measurement procedures are as follows:

<Conducted power measurement>

- (a) For WWAN power measurement, use base station simulator to configure EUT WWAN transmission in conducted connection with RF cable, at maximum power in each supported wireless interface and frequency band.
- (b) Read the WWAN RF power level from the base station simulator.
- (c) For WLAN/BT power measurement, use engineering software to configure EUT WLAN/BT continuously transmission, at maximum RF power in each supported wireless interface and frequency band
- (d) Connect EUT RF port through RF cable to the power meter, and measure WLAN/BT output power

<SAR measurement>

- (a) Use base station simulator to configure EUT WWAN transmission in radiated connection, and engineering software to configure EUT WLAN/BT continuously transmission, at maximum RF power, in the highest power channel.
- (b) Place the EUT in the positions as Appendix D demonstrates.
- (c) Set scan area, grid size and other setting on the DASY software.
- (d) Measure SAR results for the highest power channel on each testing position.
- (e) Find out the largest SAR result on these testing positions of each band
- (f) Measure SAR results for other channels in worst SAR testing position if the reported SAR of highest power channel is larger than 0.8 W/kg

According to the test standard, the recommended procedure for assessing the peak spatial-average SAR value consists of the following steps:

- (a) Power reference measurement
- (b) Area scan
- (c) Zoom scan
- (d) Power drift measurement

9.1 Spatial Peak SAR Evaluation

The procedure for spatial peak SAR evaluation has been implemented according to the test standard. It can be conducted for 1g and 10g, as well as for user-specific masses. The DASY software includes all numerical procedures necessary to evaluate the spatial peak SAR value.

The base for the evaluation is a "cube" measurement. The measured volume must include the 1g and 10g cubes with the highest averaged SAR values. For that purpose, the center of the measured volume is aligned to the interpolated peak SAR value of a previously performed area scan.

The entire evaluation of the spatial peak values is performed within the post-processing engine (SEMCAD). The system always gives the maximum values for the 1g and 10g cubes. The algorithm to find the cube with highest averaged SAR is divided into the following stages:

- (a) Extraction of the measured data (grid and values) from the Zoom Scan
- (b) Calculation of the SAR value at every measurement point based on all stored data (A/D values and measurement parameters)
- (c) Generation of a high-resolution mesh within the measured volume
- (d) Interpolation of all measured values from the measurement grid to the high-resolution grid
- (e) Extrapolation of the entire 3-D field distribution to the phantom surface over the distance from sensor to surface
- (f) Calculation of the averaged SAR within masses of 1g and 10g

9.2 Power Reference Measurement

The Power Reference Measurement and Power Drift Measurements are for monitoring the power drift of the device under test in the batch process. The minimum distance of probe sensors to surface determines the closest measurement point to phantom surface. This distance cannot be smaller than the distance of sensor calibration points to probe tip as defined in the probe properties.

9.3 Area Scan

The area scan is used as a fast scan in two dimensions to find the area of high field values, before doing a fine measurement around the hot spot. The sophisticated interpolation routines implemented in DASY software can find the maximum found in the scanned area, within a range of the global maximum. The range (in dB0 is specified in the standards for compliance testing. For example, a 2 dB range is required in IEEE standard 1528 and IEC 62209 standards, whereby 3 dB is a requirement when compliance is assessed in accordance with the ARIB standard (Japan), if only one zoom scan follows the area scan, then only the absolute maximum will be taken as reference. For cases where multiple maximums are detected, the number of zoom scans has to be increased accordingly.

Area scan parameters extracted from FCC KDB 865664 D01v01r04 SAR measurement 100 MHz to 6 GHz.

	≤ 3 GHz	> 3 GHz
Maximum distance from closest measurement point (geometric center of probe sensors) to phantom surface	5 ± 1 mm	$\frac{1}{2} \cdot \delta \cdot \ln(2) \pm 0.5$ mm
Maximum probe angle from probe axis to phantom surface normal at the measurement location	$30^\circ \pm 1^\circ$	$20^\circ \pm 1^\circ$
Maximum area scan spatial resolution: Δx_{Area} , Δy_{Area}	≤ 2 GHz: ≤ 15 mm $2 - 3$ GHz: ≤ 12 mm	$3 - 4$ GHz: ≤ 12 mm $4 - 6$ GHz: ≤ 10 mm
	When the x or y dimension of the test device, in the measurement plane orientation, is smaller than the above, the measurement resolution must be \leq the corresponding x or y dimension of the test device with at least one measurement point on the test device.	

9.4 Zoom Scan

Zoom scans are used to assess the peak spatial SAR values within a cubic averaging volume containing 1 gram and 10 gram of simulated tissue. The zoom scan measures points (refer to table below) within a cube whose base faces are centered on the maxima found in a preceding area scan job within the same procedure. When the measurement is done, the zoom scan evaluates the averaged SAR for 1 gram and 10 gram and displays these values next to the job's label.

Zoom scan parameters extracted from FCC KDB 865664 D01v01r04 SAR measurement 100 MHz to 6 GHz.

		≤ 3 GHz	> 3 GHz	
Maximum zoom scan spatial resolution: Δx_{Zoom} , Δy_{Zoom}		≤ 2 GHz: ≤ 8 mm 2 – 3 GHz: ≤ 5 mm*	3 – 4 GHz: ≤ 5 mm* 4 – 6 GHz: ≤ 4 mm*	
Maximum zoom scan spatial resolution, normal to phantom surface	uniform grid: $\Delta z_{Zoom}(n)$	≤ 5 mm	3 – 4 GHz: ≤ 4 mm 4 – 5 GHz: ≤ 3 mm 5 – 6 GHz: ≤ 2 mm	
	graded grid	$\Delta z_{Zoom}(1)$: between 1 st two points closest to phantom surface	≤ 4 mm	3 – 4 GHz: ≤ 3 mm 4 – 5 GHz: ≤ 2.5 mm 5 – 6 GHz: ≤ 2 mm
		$\Delta z_{Zoom}(n>1)$: between subsequent points	$\leq 1.5 \cdot \Delta z_{Zoom}(n-1)$	
Minimum zoom scan volume	x, y, z	≥ 30 mm	3 – 4 GHz: ≥ 28 mm 4 – 5 GHz: ≥ 25 mm 5 – 6 GHz: ≥ 22 mm	
Note: δ is the penetration depth of a plane-wave at normal incidence to the tissue medium; see draft standard IEEE P1528-2011 for details. * When zoom scan is required and the <i>reported</i> SAR from the <i>area scan based 1-g SAR estimation</i> procedures of KDB 447498 is ≤ 1.4 W/kg, ≤ 8 mm, ≤ 7 mm and ≤ 5 mm zoom scan resolution may be applied, respectively, for 2 GHz to 3 GHz, 3 GHz to 4 GHz and 4 GHz to 6 GHz.				

9.5 Volume Scan Procedures

The volume scan is used to assess overlapping SAR distributions for antennas transmitting in different frequency bands. It is equivalent to an oversized zoom scan used in standalone measurements. The measurement volume will be used to enclose all the simultaneous transmitting antennas. For antennas transmitting simultaneously in different frequency bands, the volume scan is measured separately in each frequency band. In order to sum correctly to compute the 1g aggregate SAR, the EUT remain in the same test position for all measurements and all volume scan use the same spatial resolution and grid spacing. When all volume scan were completed, the software, SEMCAD postprocessor can combine and subsequently superpose these measurement data to calculating the multiband SAR.

9.6 Power Drift Monitoring

All SAR testing is under the EUT install full charged battery and transmit maximum output power. In DASYS measurement software, the power reference measurement and power drift measurement procedures are used for monitoring the power drift of EUT during SAR test. Both these procedures measure the field at a specified reference position before and after the SAR testing. The software will calculate the field difference in dB. If the power drifts more than 5%, the SAR will be retested.



10. Test Equipment List

Manufacturer	Name of Equipment	Type/Model	Serial Number	Calibration	
				Last Cal.	Due Date
SPEAG	750MHz System Validation Kit	D750V3	1087	2019/3/27	2021/3/26
SPEAG	835MHz System Validation Kit	D835V2	4d151	2019/3/27	2021/3/26
SPEAG	1750MHz System Validation Kit	D1750V2	1090	2019/3/27	2021/3/26
SPEAG	1900MHz System Validation Kit	D1900V2	5d170	2019/3/26	2021/3/25
SPEAG	2450MHz System Validation Kit	D2450V2	908	2019/3/25	2021/3/24
SPEAG	2600MHz System Validation Kit	D2600V2	1061	2018/12/7	2020/12/6
SPEAG	5000MHz System Validation Kit	D5GHzV2	1113	2019/9/24	2021/9/23
SPEAG	Data Acquisition Electronics	DAE4	1210	2019/7/23	2020/7/22
SPEAG	Data Acquisition Electronics	DAE4	1338	2019/11/20	2020/11/19
SPEAG	Dosimetric E-Field Probe	EX3DV4	3857	2019/5/27	2020/5/26
SPEAG	Dosimetric E-Field Probe	ES3DV3	3293	2019/11/25	2020/11/24
SPEAG	SAM Twin Phantom	QD 000 P40 CB	TP-1753	NCR	NCR
SPEAG	SAM Twin Phantom	QD 000 P40 CB	TP-1754	NCR	NCR
SPEAG	Phone Positioner	N/A	N/A	NCR	NCR
Anritsu	Radio Communication Analyzer	MT8821C	6201432831	2019/4/17	2020/4/16
Agilent	Wireless Communication Test Set	E5515C	MY52102706	2019/4/17	2020/4/16
Agilent	ENA Series Network Analyzer	E5071C	MY46111157	2019/4/17	2020/4/16
SPEAG	Dielectric Probe Kit	DAK-3.5	1138	2019/11/20	2020/11/19
Anritsu	Vector Signal Generator	MG3710A	6201682672	2020/1/8	2021/1/7
Rohde & Schwarz	Power Meter	NRVD	102081	2019/8/15	2020/8/14
Rohde & Schwarz	Power Sensor	NRV-Z5	100538	2019/8/14	2020/8/13
Rohde & Schwarz	Power Sensor	NRV-Z5	100539	2019/8/14	2020/8/13
R&S	CBT BLUETOOTH TESTER	CBT	101641	2020/1/8	2021/1/7
EXA	Spectrum Analyzer	FSV7	101631	2020/1/8	2021/1/7
Testo	Hygrometer	608-H1	1241332088	2020/1/8	2021/1/7
FLUKE	DIGITAC THERMOMETER	51II	97240029	2019/8/15	2020/8/14
ARRA	Power Divider	A3200-2	N/A		Note
MCL	Attenuation1	BW-S10W5+	N/A		Note
MCL	Attenuation2	BW-S10W5+	N/A		Note
MCL	Attenuation3	BW-S10W5+	N/A		Note
Agilent	Dual Directional Coupler	778D	20500		Note
Agilent	Dual Directional Coupler	11691D	MY48151020		Note
BONN	POWER AMPLIFIER	BLMA 0830-3	087193A		Note
BONN	POWER AMPLIFIER	BLMA 2060-2	087193B		Note

Note:

1. Prior to system verification and validation, the path loss from the signal generator to the system check source and the power meter, which includes the amplifier, cable, attenuator and directional coupler, was measured by the network analyzer. The reading of the power meter was offset by the path loss difference between the path to the power meter and the path to the system check source to monitor the actual power level fed to the system check
2. Referring to KDB 865664 D01v01r04, the dipole calibration interval can be extended to 3 years with justification. The dipoles are also not physically damaged, or repaired during the interval.
3. The justification data of dipole can be found in appendix C. The return loss is < -20dB, within 20% of prior calibration, the impedance is within 5 ohm of prior calibration.

11. System Verification

11.1 Tissue Simulating Liquids

For the measurement of the field distribution inside the SAM phantom with DASY, the phantom must be filled with around 25 liters of homogeneous body tissue simulating liquid. For head SAR testing, the liquid height from the ear reference point (ERP) of the phantom to the liquid top surface is larger than 15 cm, which is shown in Fig. 11.1. For body SAR testing, the liquid height from the center of the flat phantom to the liquid top surface is larger than 15 cm, which is shown in Fig. 11.2.

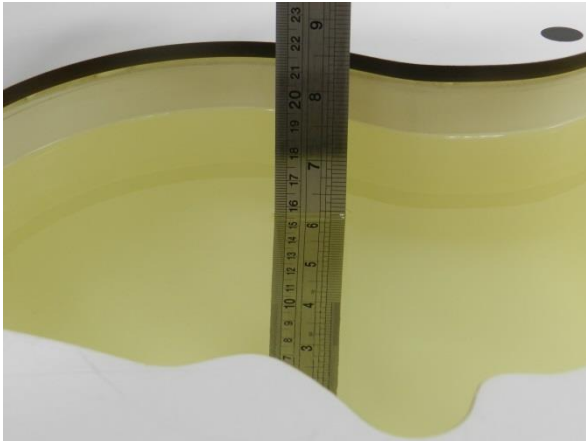

Fig 11.1 Photo of Liquid Height for Head SAR

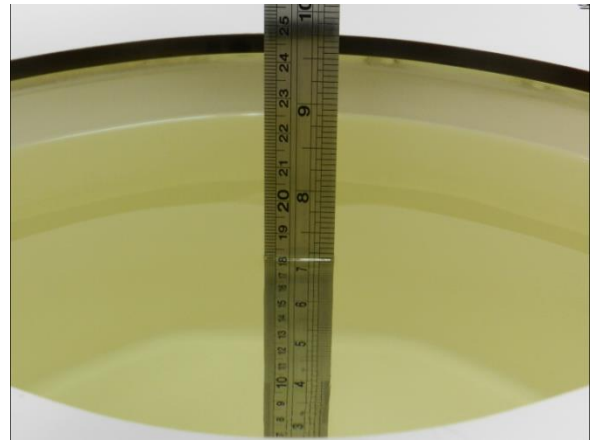

Fig 11.2 Photo of Liquid Height for Body SAR

11.2 Tissue Verification

The following tissue formulations are provided for reference only as some of the parameters have not been thoroughly verified. The composition of ingredients may be modified accordingly to achieve the desired target tissue parameters required for routine SAR evaluation.

Frequency (MHz)	Water (%)	Sugar (%)	Cellulose (%)	Salt (%)	Preventol (%)	DGBE (%)	Conductivity (σ)	Permittivity (ϵ_r)
For Head								
750	41.1	57.0	0.2	1.4	0.2	0	0.89	41.9
835	40.3	57.9	0.2	1.4	0.2	0	0.90	41.5
1800, 1900, 2000	55.2	0	0	0.3	0	44.5	1.40	40.0
2450	55.0	0	0	0	0	45.0	1.80	39.2
2600	54.8	0	0	0.1	0	45.1	1.96	39.0

Simulating Liquid for 5GHz, Manufactured by SPEAG

Ingredients	(% by weight)
Water	64~78%
Mineral oil	11~18%
Emulsifiers	9~15%
Additives and Salt	2~3%

<Tissue Dielectric Parameter Check Results>

Frequency (MHz)	Tissue Type	Liquid Temp. (°C)	Conductivity (σ)	Permittivity (ϵ_r)	Conductivity Target (σ)	Permittivity Target (ϵ_r)	Delta (σ) (%)	Delta (ϵ_r) (%)	Limit (%)	Date
750	Head	22.7	0.901	42.407	0.89	41.90	1.24	1.21	±5	2020/3/26
835	Head	22.7	0.905	41.314	0.90	41.50	0.56	-0.45	±5	2020/3/28
1750	Head	22.6	1.363	39.029	1.37	40.10	-0.51	-2.67	±5	2020/3/29
1900	Head	22.8	1.403	39.091	1.40	40.00	0.21	-2.27	±5	2020/4/3
2450	Head	22.7	1.854	38.441	1.80	39.20	3.00	-1.94	±5	2020/3/31
2600	Head	22.8	2.032	37.935	1.96	39.00	3.67	-2.73	±5	2020/4/7
2600	Head	22.8	1.934	40.117	1.96	39.00	-1.33	2.86	±5	2020/4/8
5250	Head	22.9	4.600	36.384	4.71	35.90	-2.34	1.35	±5	2020/4/10
5600	Head	22.9	4.990	35.802	5.07	35.50	-1.58	0.85	±5	2020/4/11
5750	Head	22.7	5.167	35.552	5.22	35.40	-1.02	0.43	±5	2020/4/11

11.3 System Performance Check Results

Comparing to the original SAR value provided by SPEAG, the verification data should be within its specification of 10 %. Below table shows the target SAR and measured SAR after normalized to 1W input power. The table below indicates the system performance check can meet the variation criterion and the plots can be referred to Appendix A of this report.

<1g SAR>

Date	Frequency (MHz)	Tissue Type	Input Power (mW)	Dipole S/N	Probe S/N	DAE S/N	Measured 1g SAR (W/kg)	Targeted 1g SAR (W/kg)	Normalized 1g SAR (W/kg)	Deviation (%)
2020/3/26	750	Head	250	1087	3293	1338	2.11	8.36	8.44	0.96
2020/3/28	835	Head	250	4d151	3293	1338	2.42	9.30	9.68	4.09
2020/3/29	1750	Head	250	1090	3293	1338	9.26	36.40	37.04	1.76
2020/4/3	1900	Head	250	5d170	3293	1338	9.79	39.00	39.16	0.41
2020/3/31	2450	Head	250	908	3293	1338	13.10	52.80	52.4	-0.76
2020/4/7	2600	Head	250	1061	3293	1338	14.80	57.70	59.2	2.60
2020/4/8	2600	Head	250	1061	3293	1338	13.80	57.70	55.2	-4.33
2020/4/10	5250	Head	100	1113	3857	1210	8.03	80.50	80.3	-0.25
2020/4/11	5600	Head	100	1113	3857	1210	8.45	83.40	84.5	1.32
2020/4/11	5750	Head	100	1113	3857	1210	7.83	80.00	78.3	-2.13

<10g SAR>

Date	Frequency (MHz)	Tissue Type	Input Power (mW)	Dipole S/N	Probe S/N	DAE S/N	Measured 10g SAR (W/kg)	Targeted 10g SAR (W/kg)	Normalized 10g SAR (W/kg)	Deviation (%)
2020/3/28	835	Head	250	4d151	3293	1338	1.59	6.16	6.36	3.25
2020/3/29	1750	Head	250	1090	3293	1338	4.91	19.20	19.64	2.29
2020/4/3	1900	Head	250	5d170	3293	1338	4.99	20.30	19.96	-1.67
2020/3/31	2450	Head	250	908	3293	1338	5.91	24.20	23.64	-2.31
2020/4/7	2600	Head	250	1061	3293	1338	6.44	25.90	25.76	-0.54
2020/4/8	2600	Head	250	1061	3293	1338	6.18	25.90	24.72	-4.56
2020/4/10	5250	Head	100	1113	3857	1210	2.33	23.10	23.3	0.87
2020/4/11	5600	Head	100	1113	3857	1210	2.43	23.80	24.3	2.10
2020/4/11	5750	Head	100	1113	3857	1210	2.24	22.80	22.4	-1.75

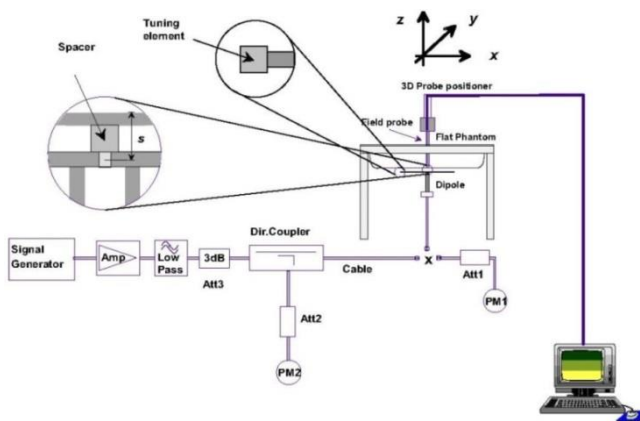

Fig 11.3.1 System Performance Check Setup



Fig 11.3.2 Setup Photo

12. RF Exposure Positions

12.1 Ear and handset reference point

Figure 12.1.1 shows the front, back, and side views of the SAM phantom. The center-of-mouth reference point is labeled “M,” the left ear reference point (ERP) is marked “LE,” and the right ERP is marked “RE.” Each ERP is 15 mm along the B-M (back-mouth) line behind the entrance-to-ear-canal (EEC) point, as shown in Figure 12.1.2 The Reference Plane is defined as passing through the two ear reference points and point M. The line N-F (neck-front), also called the reference pivoting line, is normal to the Reference Plane and perpendicular to both a line passing through RE and LE and the B-M line (see Figure 12.1.3). Both N-F and B-M lines should be marked on the exterior of the phantom shell to facilitate handset positioning. Posterior to the N-F line the ear shape is a flat surface with 6 mm thickness at each ERP, and forward of the N-F line the ear is truncated, as illustrated in Figure 12.1.2. The ear truncation is introduced to preclude the ear lobe from interfering with handset tilt, which could lead to unstable positioning at the cheek.

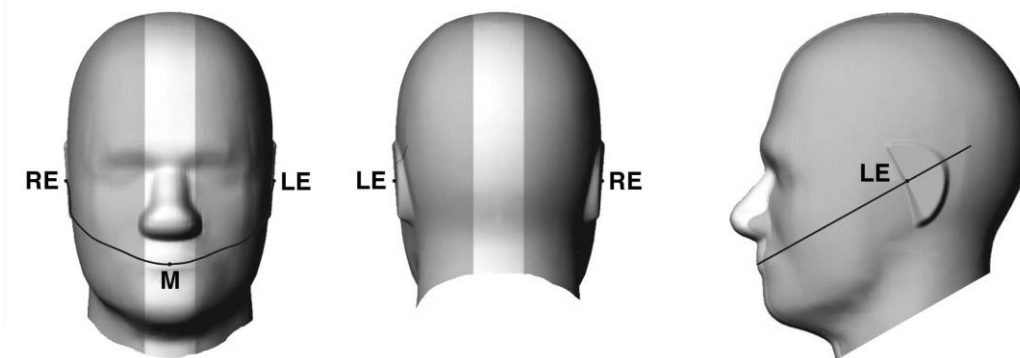

Fig 12.1.1 Front, back, and side views of SAM twin phantom

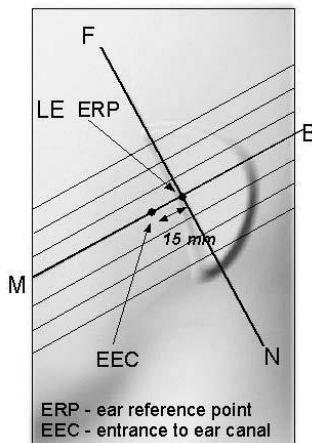

Fig 12.1.2 Close-up side view of phantom showing the ear region.

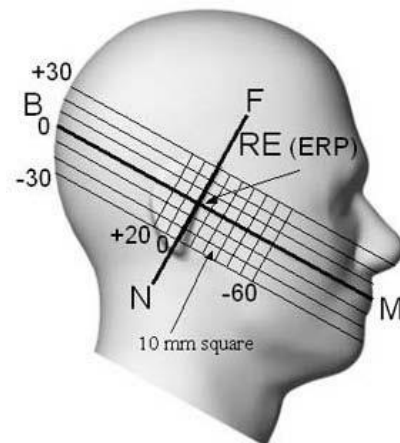

Fig 12.1.3 Side view of the phantom showing relevant markings and seven cross-sectional plane locations

12.2 Definition of the cheek position

1. Ready the handset for talk operation, if necessary. For example, for handsets with a cover piece (flip cover), open the cover. If the handset can transmit with the cover closed, both configurations must be tested.
2. Define two imaginary lines on the handset—the vertical centerline and the horizontal line. The vertical centerline passes through two points on the front side of the handset—the midpoint of the width w_t of the handset at the level of the acoustic output (point A in Figure 12.2.1 and Figure 12.2.2), and the midpoint of the width w_b of the bottom of the handset (point B). The horizontal line is perpendicular to the vertical centerline and passes through the center of the acoustic output (see Figure 12.2.1). The two lines intersect at point A. Note that for many handsets, point A coincides with the center of the acoustic output; however, the acoustic output may be located elsewhere on the horizontal line. Also note that the vertical centerline is not necessarily parallel to the front face of the handset (see Figure 12.2.2), especially for clamshell handsets, handsets with flip covers, and other irregularly-shaped handsets.
3. Position the handset close to the surface of the phantom such that point A is on the (virtual) extension of the line passing through points RE and LE on the phantom (see Figure 12.2.3), such that the plane defined by the vertical centerline and the horizontal line of the handset is approximately parallel to the sagittal plane of the phantom.
4. Translate the handset towards the phantom along the line passing through RE and LE until handset point A touches the pinna at the ERP.
5. While maintaining the handset in this plane, rotate it around the LE-RE line until the vertical centerline is in the plane normal to the plane containing B-M and N-F lines, i.e., the Reference Plane.
6. Rotate the handset around the vertical centerline until the handset (horizontal line) is parallel to the N-F line.
7. While maintaining the vertical centerline in the Reference Plane, keeping point A on the line passing through RE and LE, and maintaining the handset contact with the pinna, rotate the handset about the N-F line until any point on the handset is in contact with a phantom point below the pinna on the cheek. See Figure 12.2.3. The actual rotation angles should be documented in the test report.

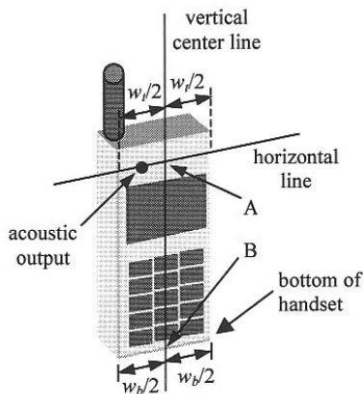

Fig 12.2.1 Handset vertical and horizontal reference lines—“fixed case”

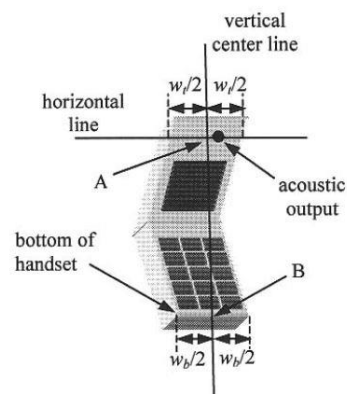

Fig 12.2.2 Handset vertical and horizontal reference lines—“clam-shell case”

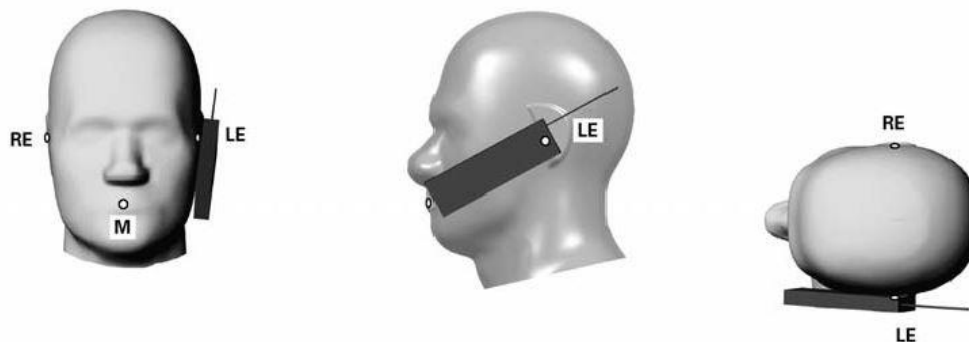

Fig 12.2.3 cheek or touch position. The reference points for the right ear (RE), left ear (LE), and mouth (M), which establish the Reference Plane for handset positioning, are indicated.

12.3 Definition of the tilt position

1. Ready the handset for talk operation, if necessary. For example, for handsets with a cover piece (flip cover), open the cover. If the handset can transmit with the cover closed, both configurations must be tested.
2. While maintaining the orientation of the handset, move the handset away from the pinna along the line passing through RE and LE far enough to allow a rotation of the handset away from the cheek by 15°.
3. Rotate the handset around the horizontal line by 15°.
4. While maintaining the orientation of the handset, move the handset towards the phantom on the line passing through RE and LE until any part of the handset touches the ear. The tilt position is obtained when the contact point is on the pinna. See Figure 12.3.1. If contact occurs at any location other than the pinna, e.g., the antenna at the back of the phantom head, the angle of the handset should be reduced. In this case, the tilt position is obtained if any point on the handset is in contact with the pinna and a second point

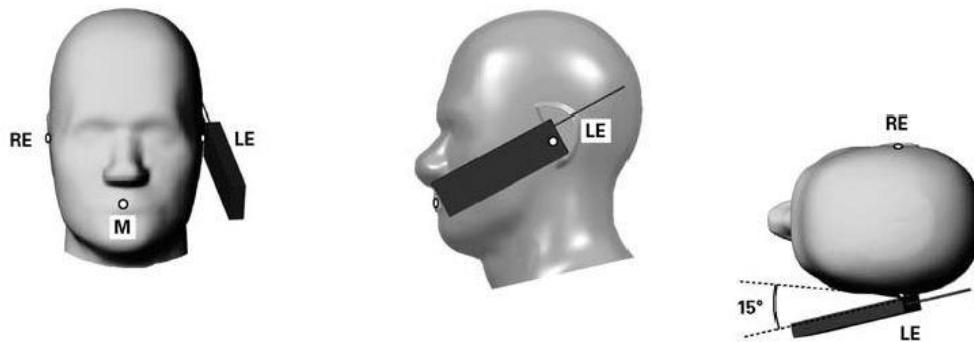

Fig 12.3.1 Tilt position. The reference points for the right ear (RE), left ear (LE), and mouth (M), which define the Reference Plane for handset positioning, are indicated.

12.4 Body Worn Accessory

Body-worn operating configurations are tested with the belt-clips and holsters attached to the device and positioned against a flat phantom in a normal use configuration (see Figure 12.4). Per KDB648474 D04v01r03, body-worn accessory exposure is typically related to voice mode operations when handsets are carried in body-worn accessories. The body-worn accessory procedures in FCC KDB 447498 D01v06 should be used to test for body-worn accessory SAR compliance, without a headset connected to it. This enables the test results for such configuration to be compatible with that required for hotspot mode when the body-worn accessory test separation distance is greater than or equal to that required for hotspot mode, when applicable. When the reported SAR for body-worn accessory, measured without a headset connected to the handset is $> 1.2 \text{ W/kg}$, the highest reported SAR configuration for that wireless mode and frequency band should be repeated for that body-worn accessory with a headset attached to the handset.

Accessories for body-worn operation configurations are divided into two categories: those that do not contain metallic components and those that do contain metallic components. When multiple accessories that do not contain metallic components are supplied with the device, the device is tested with only the accessory that dictates the closest spacing to the body. Then multiple accessories that contain metallic components are tested with the device with each accessory. If multiple accessories share an identical metallic component (i.e. the same metallic belt-clip used with different holsters with no other metallic components) only the accessory that dictates the closest spacing to the body is tested.

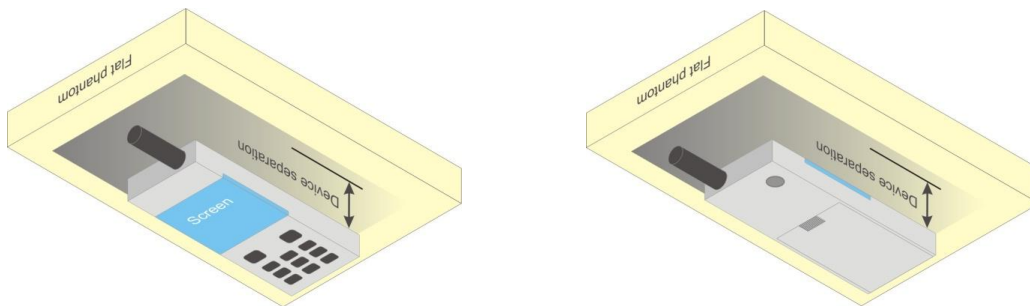

Fig 12.4 Body Worn Position

12.5 Product Specific 10g SAR Exposure

For smart phones with a display diagonal dimension > 15.0 cm or an overall diagonal dimension > 16.0 cm that provide similar mobile web access and multimedia support found in mini-tablets or UMPC mini-tablets that support voice calls next to the ear, According to KDB648474 D04v01r03, the following phablet procedures should be applied to evaluate SAR compliance for each applicable wireless modes and frequency band. Devices marketed as phablets, regardless of form factors and operating characteristics must be tested as a phablet to determine SAR compliance

1. The normally required head and body-worn accessory SAR test procedures for handsets, including hotspot mode, must be applied.
2. The UMPC mini-tablet procedures must also be applied to test the SAR of all surfaces and edges with an antenna located at ≤ 25 mm from that surface or edge, in direct contact with a flat phantom, for 10-g extremity SAR according to the body-equivalent tissue dielectric parameters in KDB 865664 to address interactive hand use exposure conditions.6 The UMPC mini-tablet 1-g SAR at 5 mm is not required. When hotspot mode applies, 10-g extremity SAR is required only for the surfaces and edges with hotspot mode 1-g reported SAR > 1.2 W/kg.

12.6 Wireless Router

Some battery-operated handsets have the capability to transmit and receive user through simultaneous transmission of WIFI simultaneously with a separate licensed transmitter. The FCC has provided guidance in FCC KDB Publication 941225 D06 v02r01 where SAR test considerations for handsets (L x W ≥ 9 cm x 5 cm) are based on a composite test separation distance of 10mm from the front, back and edges of the device containing transmitting antennas within 2.5cm of their edges, determined from general mixed use conditions for this type of devices. Since the hotspot SAR results may overlap with the body-worn accessory SAR requirements, the more conservative configurations can be considered, thus excluding some body-worn accessory SAR tests.

When the user enables the personal wireless router functions for the handset, actual operations include simultaneous transmission of both the WIFI transmitter and another licensed transmitter. Both transmitters often do not transmit at the same transmitting frequency and thus cannot be evaluated for SAR under actual use conditions due to the limitations of the SAR assessment probes. Therefore, SAR must be evaluated for each frequency transmission and mode separately and spatially summed with the WIFI transmitter according to FCC KDB Publication 447498 D01v06 publication procedures. The "Portable Hotspot" feature on the handset was NOT activated during SAR assessments, to ensure the SAR measurements were evaluated for a single transmission frequency RF signal at a time.

Distance of the Antenna to the EUT surface/edge						
Antennas	Back	Front	Top Side	Bottom Side	Right Side	Left Side
WWAN Antenna 1	≤ 25mm	≤ 25mm	>25mm	≤ 25mm	≤ 25mm	≤ 25mm
WWAN Antenna 2	≤ 25mm	≤ 25mm	>25mm	≤ 25mm	>25mm	≤ 25mm
2.4GHz WLAN & BT	≤ 25mm	≤ 25mm	≤ 25mm	>25mm	≤ 25mm	>25mm
5GHz WLAN	≤ 25mm	≤ 25mm	≤ 25mm	>25mm	≤ 25mm	>25mm

Positions for SAR tests; Hotspot mode						
Antennas	Back	Front	Top Side	Bottom Side	Right Side	Left Side
WWAN Antenna 1	Yes	Yes	No	Yes	Yes	Yes
WWAN Antenna 2	Yes	Yes	No	Yes	No	Yes
2.4GHz WLAN & BT	Yes	Yes	Yes	No	Yes	No
5GHz WLAN	Yes	Yes	Yes	No	Yes	No

Note:

1. This device has two WWAN transmitter antennas. WWAN antenna 1 is located at the right of bottom edge of the device and WWAN antenna 2 is located at the left side of bottom edge of the device which can refer to antenna location chapter. WWAN antenna 1 frequency bands include GSM850/1900, WCDMA Band II/IV/V, and LTE Band 2/4/5/12/17/26/66, WWAN antenna 2 frequency band include LTE Band 7/38/41.
2. 2.4GHz WLAN & BT Antenna is located at the Right-top of the device
3. 5GHz WLAN Antenna is located at the Right-top of the device

13. Conducted RF Output Power (Unit: dBm)

The detailed conducted power table can refer to Appendix E.

<GSM Conducted Power>

1. Per KDB 447498 D01v06, the maximum output power channel is used for SAR testing and for further SAR test reduction.
2. Per KDB 941225 D01v03r01, for SAR test reduction for GSM / GPRS / EDGE modes is determined by the source-based time-averaged output power including tune-up tolerance. The mode with highest specified time-averaged output power should be tested for SAR compliance in the applicable exposure conditions. For modes with the same specified maximum output power and tolerance, the higher number time-slot configuration should be tested. Therefore, the GPRS 3Tx slots for GSM850/GSM1900 are considered as the primary mode.
3. Other configurations of GSM / GPRS / EDGE are considered as secondary modes. The 3G SAR test reduction procedure is applied, when the maximum output power and tune-up tolerance specified for production units in a secondary mode is $\leq \frac{1}{4}$ dB higher than the primary mode, SAR measurement is not required for the secondary mode.

<WCDMA Conducted Power>

1. The following tests were conducted according to the test requirements outlines in 3GPP TS 34.121 specification.
2. The procedures in KDB 941225 D01v03r01 are applied for 3GPP Rel. 6 HSPA to configure the device in the required sub-test mode(s) to determine SAR test exclusion.
3. For DC-HSDPA, the device was configured according to the H-Set 12, Fixed Reference Channel (FRC) configuration in Table C.8.1.12 of 3GPP TS 34.121-1, with the primary and the secondary serving HS-DSCH Cell enabled during the power measurement.

A summary of these settings are illustrated below:

HSDPA Setup Configuration:

- a. The EUT was connected to Base Station Agilent E5515C referred to the Setup Configuration.
- b. The RF path losses were compensated into the measurements.
- c. A call was established between EUT and Base Station with following setting:
 - i. Set Gain Factors (β_c and β_d) and parameters were set according to each
 - ii. Specific sub-test in the following table, C10.1.4, quoted from the TS 34.121
 - iii. Set RMC 12.2Kbps + HSDPA mode.
 - iv. Set Cell Power = -86 dBm
 - v. Set HS-DSCH Configuration Type to FRC (H-set 1, QPSK)
 - vi. Select HSDPA Uplink Parameters
 - vii. Set Delta ACK, Delta NACK and Delta CQI = 8
 - viii. Set Ack-Nack Repetition Factor to 3
 - ix. Set CQI Feedback Cycle (k) to 4 ms
 - x. Set CQI Repetition Factor to 2
 - xi. Power Ctrl Mode = All Up bits
- d. The transmitted maximum output power was recorded.

Table C.10.1.4: β values for transmitter characteristics tests with HS-DPCCH

Sub-test	β_c	β_d	β_d (SF)	β_c/β_d	β_{HS} (Note 1, Note 2)	CM (dB) (Note 3)	MPR (dB) (Note 3)
1	2/15	15/15	64	2/15	4/15	0.0	0.0
2	12/15 (Note 4)	15/15 (Note 4)	64	12/15 (Note 4)	24/15	1.0	0.0
3	15/15	8/15	64	15/8	30/15	1.5	0.5
4	15/15	4/15	64	15/4	30/15	1.5	0.5

Note 1: Δ_{ACK} , Δ_{NACK} and $\Delta_{CQI} = 30/15$ with $\beta_{HS} = 30/15 * \beta_c$.

Note 2: For the HS-DPCCH power mask requirement test in clause 5.2C, 5.7A, and the Error Vector Magnitude (EVM) with HS-DPCCH test in clause 5.13.1A, and HSDPA EVM with phase discontinuity in clause 5.13.1AA, Δ_{ACK} and $\Delta_{NACK} = 30/15$ with $\beta_{HS} = 30/15 * \beta_c$, and $\Delta_{CQI} = 24/15$ with $\beta_{HS} = 24/15 * \beta_c$.

Note 3: CM = 1 for $\beta_c/\beta_d = 12/15$, $\beta_{HS}/\beta_c = 24/15$. For all other combinations of DPDCCH, DPCCH and HS-DPCCH the MPR is based on the relative CM difference. This is applicable for only UEs that support HSDPA in release 6 and later releases.

Note 4: For subtest 2 the β_c/β_d ratio of 12/15 for the TFC during the measurement period (TF1, TF0) is achieved by setting the signalled gain factors for the reference TFC (TF1, TF1) to $\beta_c = 11/15$ and $\beta_d = 15/15$.

Setup Configuration

HSUPA Setup Configuration:

- a. The EUT was connected to Base Station Agilent E5515C referred to the Setup Configuration.
- b. The RF path losses were compensated into the measurements.
- c. A call was established between EUT and Base Station with following setting * :
 - i. Call Configs = 5.2B, 5.9B, 5.10B, and 5.13.2B with QPSK
 - ii. Set the Gain Factors (β_c and β_d) and parameters (AG Index) were set according to each specific sub-test in the following table, C11.1.3, quoted from the TS 34.121
 - iii. Set Cell Power = -86 dBm
 - iv. Set Channel Type = 12.2k + HSPA
 - v. Set UE Target Power
 - vi. Power Ctrl Mode= Alternating bits
 - vii. Set and observe the E-TFCI
 - viii. Confirm that E-TFCI is equal to the target E-TFCI of 75 for sub-test 1, and other subtest's E-TFCI
- d. The transmitted maximum output power was recorded.

Table C.11.1.3: β values for transmitter characteristics tests with HS-DPCCH and E-DCH

Sub-test	β_c	β_d	β_d (SF)	β_c/β_d	β_{HS} (Note1)	β_{ec}	β_{ed} (Note 4) (Note 5)	β_{ed} (SF)	β_{ed} (Codes)	CM (dB) (Note 2)	MPR (dB) (Note 2) (Note 6)	AG Index (Note 5)	E-TFCI
1	11/15 (Note 3)	15/15 (Note 3)	64	11/15 (Note 3)	22/15	209/25	1309/225	4	1	1.0	0.0	20	75
2	6/15	15/15	64	6/15	12/15	12/15	94/75	4	1	3.0	2.0	12	67
3	15/15	9/15	64	15/9	30/15	30/15	β_{ed1} : 47/15 β_{ed2} : 47/15	4 4	2	2.0	1.0	15	92
4	2/15	15/15	64	2/15	4/15	2/15	56/75	4	1	3.0	2.0	17	71
5	15/15	0	-	-	5/15	5/15	47/15	4	1	1.0	0.0	12	67

Note 1: For sub-test 1 to 4, Δ_{ACK} , Δ_{NACK} and $\Delta_{CQI} = 30/15$ with $\beta_{hs} = 30/15 * \beta_c$. For sub-test 5, Δ_{ACK} , Δ_{NACK} and $\Delta_{CQI} = 5/15$ with $\beta_{hs} = 5/15 * \beta_c$.

Note 2: CM = 1 for $\beta_c/\beta_d=12/15$, $\beta_{hs}/\beta_c=24/15$. For all other combinations of DPDCH, DPCCH, HS- DPCCH, E-DPDCH and E-DPCCH the MPR is based on the relative CM difference.

Note 3: For subtest 1 the β_c/β_d ratio of 11/15 for the TFC during the measurement period (TF1, TF0) is achieved by setting the signalled gain factors for the reference TFC (TF1, TF1) to $\beta_c = 10/15$ and $\beta_d = 15/15$.

Note 4: In case of testing by UE using E-DPDCH Physical Layer category 1, Sub-test 3 is omitted according to TS25.306 Table 5.1g.

Note 5: β_{ed} can not be set directly; it is set by Absolute Grant Value.

Note 6: For subtests 2, 3 and 4, UE may perform E-DPDCH power scaling at max power which could results in slightly smaller MPR values.

Setup Configuration

DC-HSDPA 3GPP release 8 Setup Configuration:

- a. The EUT was connected to Base Station referred to the Setup Configuration below
- b. The RF path losses were compensated into the measurements.
- c. A call was established between EUT and Base Station with following setting:
 - i. Set RMC 12.2Kbps + HSDPA mode.
 - ii. Set Cell Power = -25 dBm
 - iii. Set HS-DSCH Configuration Type to FRC (H-set 12, QPSK)
 - iv. Select HSDPA Uplink Parameters
 - v. Set Gain Factors (β_c and β_d) and parameters were set according to each Specific sub-test in the following table, C10.1.4, quoted from the TS 34.121
 - a). Subtest 1: $\beta_c/\beta_d=2/15$
 - b). Subtest 2: $\beta_c/\beta_d=12/15$
 - c). Subtest 3: $\beta_c/\beta_d=15/8$
 - d). Subtest 4: $\beta_c/\beta_d=15/4$
 - vi. Set Delta ACK, Delta NACK and Delta CQI = 8
 - vii. Set Ack-Nack Repetition Factor to 3
 - viii. Set CQI Feedback Cycle (k) to 4 ms
 - ix. Set CQI Repetition Factor to 2
 - x. Power Ctrl Mode = All Up bits
- d. The transmitted maximum output power was recorded.

The following tests were conducted according to the test requirements outlines in 3GPP TS 34.121 specification. A summary of these settings are illustrated below:

C.8.1.12 Fixed Reference Channel Definition H-Set 12

Table C.8.1.12: Fixed Reference Channel H-Set 12

Parameter	Unit	Value
Nominal Avg. Inf. Bit Rate	kbps	60
Inter-TTI Distance	TTI's	1
Number of HARQ Processes	Processes	6
Information Bit Payload (N_{INF})	Bits	120
Number Code Blocks	Blocks	1
Binary Channel Bits Per TTI	Bits	960
Total Available SML's in UE	SML's	19200
Number of SML's per HARQ Proc.	SML's	3200
Coding Rate		0.15
Number of Physical Channel Codes	Codes	1
Modulation		QPSK
Note 1: The RMC is intended to be used for DC-HSDPA mode and both cells shall transmit with identical parameters as listed in the table. Note 2: Maximum number of transmission is limited to 1, i.e., retransmission is not allowed. The redundancy and constellation version 0 shall be used.		

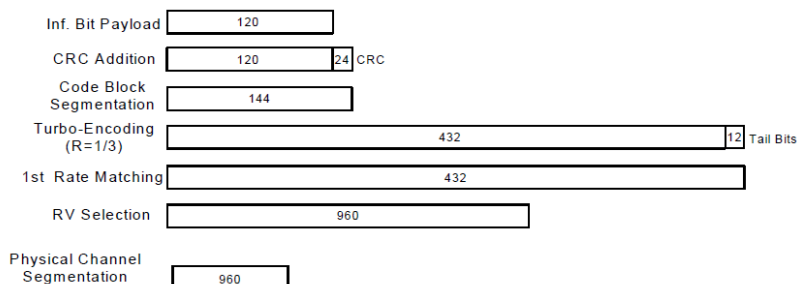

Figure C.8.19: Coding rate for Fixed reference Channel H-Set 12 (QPSK)

Setup Configuration

<WCDMA Conducted Power>

General Note:

- Per KDB 941225 D01v03r01, for SAR testing is measured using a 12.2 kbps RMC with TPC bits configured to all "1's".
- Per KDB 941225 D01v03r01, RMC 12.2kbps setting is used to evaluate SAR. The maximum output power and tune-up tolerance specified for production units in HSDPA / HSUPA / DC-HSDPA is $\leq \frac{1}{4}$ dB higher than RMC 12.2Kbps or when the highest reported SAR of the RMC12.2Kbps is scaled by the ratio of specified maximum output power and tune-up tolerance of HSDPA / HSUPA / DC-HSDPA to RMC12.2Kbps and the adjusted SAR is ≤ 1.2 W/kg, SAR measurement is not required for HSDPA / HSUPA / DC-HSDPA, and according to the following RF output power, the output power results of the secondary modes (HSDPA / HSUPA / DC-HSDPA) are less than $\frac{1}{4}$ dB higher than the primary modes; therefore, SAR measurement is not required for HSDPA / HSUPA / DC-HSDPA

<LTE Conducted Power>

General Note:

1. Anritsu MT8820C base station simulator was used to setup the connection with EUT; the frequency band, channel bandwidth, RB allocation configuration, modulation type are set in the base station simulator to configure EUT transmitting at maximum power and at different configurations which are requested to be reported to FCC, for conducted power measurement and SAR testing.
2. Per KDB 941225 D05v02r05, when a properly configured base station simulator is used for the SAR and power measurements, spectrum plots for each RB allocation and offset configuration is not required.
3. Per KDB 941225 D05v02r05, start with the largest channel bandwidth and measure SAR for QPSK with 1 RB allocation, using the RB offset and required test channel combination with the highest maximum output power for RB offsets at the upper edge, middle and lower edge of each required test channel.
4. Per KDB 941225 D05v02r05, 50% RB allocation for QPSK SAR testing follows 1RB QPSK allocation procedure.
5. Per KDB 941225 D05v02r05, for QPSK with 100% RB allocation, SAR is not required when the highest maximum output power for 100 % RB allocation is less than the highest maximum output power in 50% and 1 RB allocations and the highest reported SAR for 1 RB and 50% RB allocation are ≤ 0.8 W/kg. Otherwise, SAR is measured for the highest output power channel; and if the reported SAR is > 1.45 W/kg, the remaining required test channels must also be tested.
6. Per KDB 941225 D05v02r05, 16QAM/64QAM output power for each RB allocation configuration is $>$ not $\frac{1}{2}$ dB higher than the same configuration in QPSK and the reported SAR for the QPSK configuration is ≤ 1.45 W/kg; Per KDB 941225 D05v02r05, 16QAM/64QAM SAR testing is not required.
7. Per KDB 941225 D05v02r05, smaller bandwidth output power for each RB allocation configuration is $>$ not $\frac{1}{2}$ dB higher than the same configuration in the largest supported bandwidth, and the reported SAR for the largest supported bandwidth is ≤ 1.45 W/kg; Per KDB 941225 D05v02r05, smaller bandwidth SAR testing is not required.
8. For LTE B4 / B5 / B12 / B17 / B26 the maximum bandwidth does not support three non-overlapping channels, per KDB 941225 D05v02r05, when a device supports overlapping channel assignment in a channel bandwidth configuration, the middle channel of the group of overlapping channels should be selected for testing.
9. LTE B17 / B5 / B4 / B38 SAR test was covered by B12 / B26 / B66 / B41; according to April 2015 TCB workshop, SAR test for overlapping LTE bands can be reduced if
 - a. the maximum output power, including tolerance, for the smaller band is \leq the larger band to qualify for the SAR test exclusion
 - b. the channel bandwidth and other operating parameters for the smaller band are fully supported by the larger band
10. According to 2017 TCB workshop, for 64 QAM and 16 QAM should be verified by checking the signal constellation with a call box to avoid incorrect maximum power levels due to MPR and other requirements associated with signal modulation, and the following figure is taken from the "Fundamental Measurement >> Modulation Analysis >> constellation" mode of the device connect to the MT8821C base station, therefore, the device 64QAM and 16QAM signal modulation are correct.

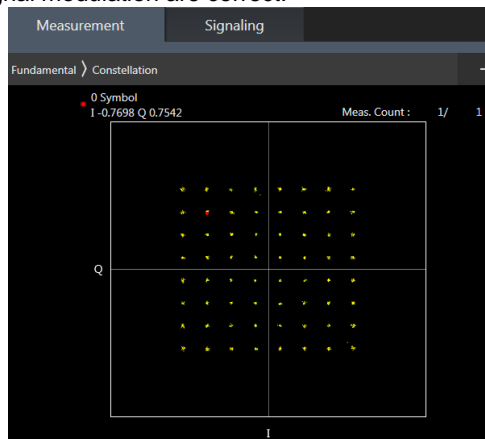

64QAM

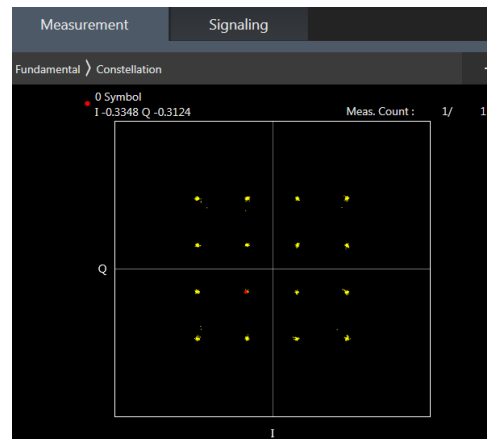

16QAM

<TDD LTE SAR Measurement>

TDD LTE configuration setup for SAR measurement

SAR was tested with a fixed periodic duty factor according to the highest transmission duty factor implemented for the device and supported by 3GPP.

- a. 3GPP TS 36.211 section 4.2 for Type 2 Frame Structure and Table 4.2-2 for uplink-downlink configurations
- b. "special subframe S" contains both uplink and downlink transmissions, it has been taken into consideration to determine the transmission duty factor according to the worst case uplink and downlink cyclic prefix requirements for UpPTS
- c. Establishing connections with base station simulators ensure a consistent means for testing SAR and recommended for evaluating SAR. The Anritsu MT8820C (firmware: #22.52#004) was used for LTE output power measurements and SAR testing.

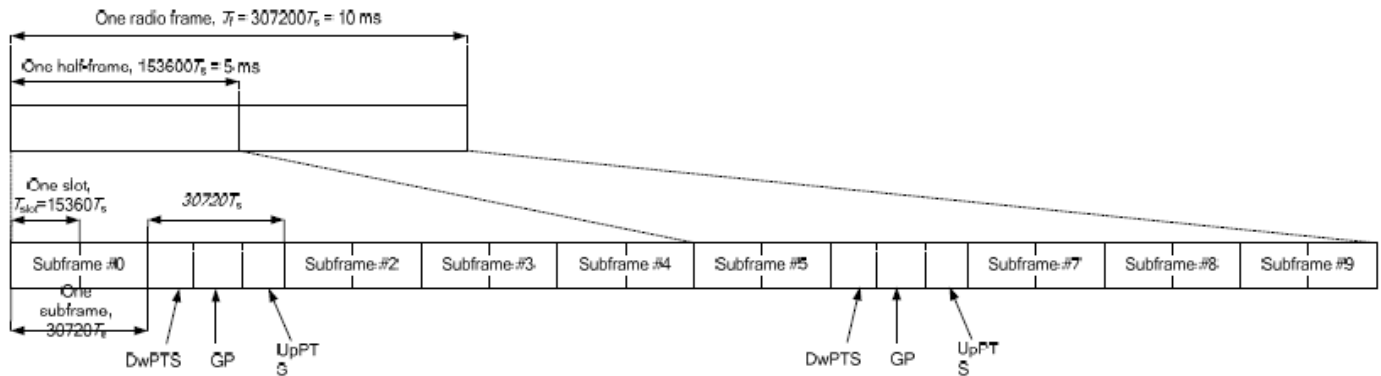

Figure 4.2-1: Frame structure type 2 (for 5 ms switch-point periodicity).

Table 4.2-2: Uplink-downlink configurations.

Uplink-downlink configuration	Downlink-to-Uplink Switch-point periodicity	Subframe number									
		0	1	2	3	4	5	6	7	8	9
0	5 ms	D	S	U	U	U	D	S	U	U	U
1	5 ms	D	S	U	U	D	D	S	U	U	D
2	5 ms	D	S	U	D	D	D	S	U	D	D
3	10 ms	D	S	U	U	U	D	D	D	D	D
4	10 ms	D	S	U	U	D	D	D	D	D	D
5	10 ms	D	S	U	D	D	D	D	D	D	D
6	5 ms	D	S	U	U	U	D	S	U	U	D

Table 4.2-1: Configuration of special subframe (lengths of DwPTS/GP/UpPTS).

Special subframe configuration	Normal cyclic prefix in downlink			Extended cyclic prefix in downlink		
	DwPTS	UpPTS		DwPTS	UpPTS	
		Normal cyclic prefix in uplink	Extended cyclic prefix in uplink		Normal cyclic prefix in uplink	Extended cyclic prefix in uplink
0	6592 · Ts	2192 · Ts	2560 · Ts	7680 · Ts	2192 · Ts	2560 · Ts
1	19760 · Ts			20480 · Ts		
2	21952 · Ts			23040 · Ts		
3	24144 · Ts			25600 · Ts		
4	26336 · Ts	4384 · Ts	5120 · Ts	7680 · Ts	4384 · Ts	5120 · Ts
5	6592 · Ts			20480 · Ts		
6	19760 · Ts			23040 · Ts		
7	21952 · Ts			12800 · Ts		
8	24144 · Ts	-	-	-	-	-
9	13168 · Ts	-	-	-	-	-

Special subframe (30720·T _s): Normal cyclic prefix in downlink (UpPTS)			
	Special subframe configuration	Normal cyclic prefix in uplink	Extended cyclic prefix in uplink
Uplink duty factor in one special subframe	0~4	7.13%	8.33%
	5~9	14.3%	16.7%

Special subframe(30720·T _s): Extended cyclic prefix in downlink (UpPTS)			
	Special subframe configuration	Normal cyclic prefix in uplink	Extended cyclic prefix in uplink
Uplink duty factor in one special subframe	0~3	7.13%	8.33%
	4~7	14.3%	16.7%

The highest duty factor is resulted from:

For LTE Band 41 Power class 3

- i. Uplink-downlink configuration: 0. In a half-frame consisted of 5 subframes, uplink operation is in 3 uplink subframes and 1 special subframe.
- ii. special subframe configuration: 5-9 for normal cyclic prefix in downlink, 4-7 for extended cyclic prefix in downlink
- iii. for special subframe with extended cyclic prefix in uplink, the total uplink duty factor in one half-frame is: $(3+0.167)/5 = 63.3\%$
- iv. for special subframe with normal cyclic prefix in uplink, the total uplink duty factor in one half-frame is: $(3+0.143)/5 = 62.9\%$
- v. For TDD LTE SAR measurement, the duty cycle 1:1.59 (62.9 %) was used perform testing and considering the theoretical duty cycle of 63.3% for extended cyclic prefix in the uplink, and the theoretical duty cycle of 62.9% for normal cyclic prefix in uplink, a scaling factor of extended cyclic prefix $63.3\%/62.9\% = 1.006$ is applied to scale-up the measured SAR result. The scaled TDD LTE SAR = measured SAR (W/kg)* Tune-up Scaling Factor* scaling factor for extended cyclic prefix.

<LTE Carrier Aggregation>

General Note:

1. This device supports Carrier Aggregation on downlink for inter and intra band. For the device supports bands and bandwidths and configurations are provided as follow table was according to 3GPP.
2. In applying the existing power measurement procedures of KDB 941225 D05A for DL CA SAR test exclusion, only the subset with the largest number of combinations of frequency bands and CCs in each row need combination, and for this device that all the configurations were choose to power measurement.

Index	2CC
2CC #1	CA_2A-4A
2CC #2	CA_2A-7A
2CC #3	CA_4A-4A
2CC #4	CA_4A-5A
2CC #5	CA_4A-7A
2CC #6	CA_4A-12A
2CC #7	CA_5A-7A
2CC #8	CA_7B
2CC #9	CA_7C
2CC #10	CA_7A-7A
2CC #11	CA_41C
2CC #12	CA_41A-41A
2CC #13	CA_12A-66A
2CC #14	CA_66B
2CC #15	CA_66C
2CC #16	CA_66A-66A

LTE Carrier Aggregation Conducted Power (Downlink)

- i. According to KDB941225 D05A v01r02, Uplink maximum output power measurement with downlink carrier aggregation active should be measured, using the highest output channel measured without downlink carrier aggregation, to confirm that uplink maximum output power with downlink carrier aggregation active remains within the specified tune-up tolerance limits and not more than ¼ dB higher than the maximum output measured without downlink carrier aggregation active.
- ii. Uplink maximum output power with downlink carrier aggregation active does not show more than ¼ dB higher than the maximum output power without downlink carrier aggregation active, therefore SAR evaluation with downlink carrier aggregation active can be excluded.
- iii. The device supports downlink two carrier aggregation. For power measurement were control and acknowledge data is sent on uplink channels that operate identical to specifications when downlink carrier aggregation is inactive.
- iv. Selected highest measured power when downlink carrier aggregation is inactive for conducted power comparison with downlink carrier aggregation is active, to confirm that when downlink carrier aggregation is active uplink maximum output power remains within the specified tune-up tolerance limits and not more than ¼ dB higher than the maximum output power measured when downlink carrier aggregation inactive.
- v. For inter-band CA, the SCC selected highest bandwidth and near the middle of its transmission band. For SCC DL RB size and offset will base on the PCC corresponding RB allocation.
- vi. For non-contiguous intra-band CA, the SCC selected to provide maximum separation from the PCC and must remain fully within the downlink transmission band.
- vii. For Intra-band, contiguous CA, the downlink channels selected to perform the uplink power measurement must satisfy 3GPP channel spacing (5.4.1A of 3GPP TS 36.521 or equivalent) and channel bandwidth (5.4.2A) requirements.

$$\text{Nominal channel spacing} = \left\lceil \frac{BW_{\text{Channel}(1)} + BW_{\text{Channel}(2)} - 0.1|BW_{\text{Channel}(1)} - BW_{\text{Channel}(2)}|}{0.6} \right\rceil 0.3 \text{ [MHz]}$$

**<WLAN Conducted Power>****General Note:**

1. Per KDB 248227 D01v02r02, SAR test reduction is determined according to 802.11 transmission mode configurations and certain exposure conditions with multiple test positions. In the 2.4 GHz band, separate SAR procedures are applied to DSSS and OFDM configurations to simplify DSSS test requirements. For OFDM, in both 2.4 and 5 GHz bands, an initial test configuration must be determined for each standalone and aggregated frequency band, according to the transmission mode configuration with the highest maximum output power specified for production units to perform SAR measurements. If the same highest maximum output power applies to different combinations of channel bandwidths, modulations and data rates, additional procedures are applied to determine which test configurations require SAR measurement. When applicable, an initial test position may be applied to reduce the number of SAR measurements required for next to the ear, UMPC mini-tablet or hotspot mode configurations with multiple test positions.
2. For 2.4 GHz 802.11b DSSS, either the initial test position procedure for multiple exposure test positions or the DSSS procedure for fixed exposure position is applied; these are mutually exclusive. For 2.4 GHz and 5 GHz OFDM configurations, the initial test configuration is applied to measure SAR using either the initial test position procedure for multiple exposure test position configurations or the initial test configuration procedures for fixed exposure test conditions. Based on the reported SAR of the measured configurations and maximum output power of the transmission mode configurations that are not included in the initial test configuration, the subsequent test configuration and initial test position procedures are applied to determine if SAR measurements are required for the remaining OFDM transmission configurations. In general, the number of test channels that require SAR measurement is minimized based on maximum output power measured for the test sample(s).
3. For OFDM transmission configurations in the 2.4 GHz and 5 GHz bands, When the same maximum power is specified for multiple transmission modes in a frequency band, the largest channel bandwidth, lowest order modulation, lowest data rate and lowest order 802.11a/g/n/ac mode is used for SAR measurement, on the highest measured output power channel for each frequency band.
4. DSSS and OFDM configurations are considered separately according to the required SAR procedures. SAR is measured in the initial test position using the 802.11 transmission mode configuration required by the DSSS procedure or initial test configuration and subsequent test configuration(s) according to the OFDM procedures.18 The initial test position procedure is described in the following:
 - a. When the reported SAR of the initial test position is ≤ 0.4 W/kg, further SAR measurement is not required for the other test positions in that exposure configuration and 802.11 transmission mode combinations within the frequency band or aggregated band.
 - b. When the reported SAR of the test position is > 0.4 W/kg, SAR is repeated for the 802.11 transmission mode configuration tested in the initial test position to measure the subsequent next closet/smallest test separation distance and maximum coupling test position on the highest maximum output power channel, until the report SAR is ≤ 0.8 W/kg or all required test position are tested.
 - c. For all positions/configurations, when the reported SAR is > 0.8 W/kg, SAR is measured for these test positions/configurations on the subsequent next highest measured output power channel(s) until the reported



<2.4GHz Bluetooth>

General Note:

- 1. For 2.4GHz Bluetooth SAR testing was selected 1Mbps, due to its highest average power.
- 2. The Bluetooth duty cycle is 77.39 % as following figure, according to 2016 Oct. TCB workshop for Bluetooth SAR scaling need further consideration and the theoretical duty cycle is 83.3%, therefore the actual duty cycle will be scaled up to the theoretical value of Bluetooth reported SAR calculation

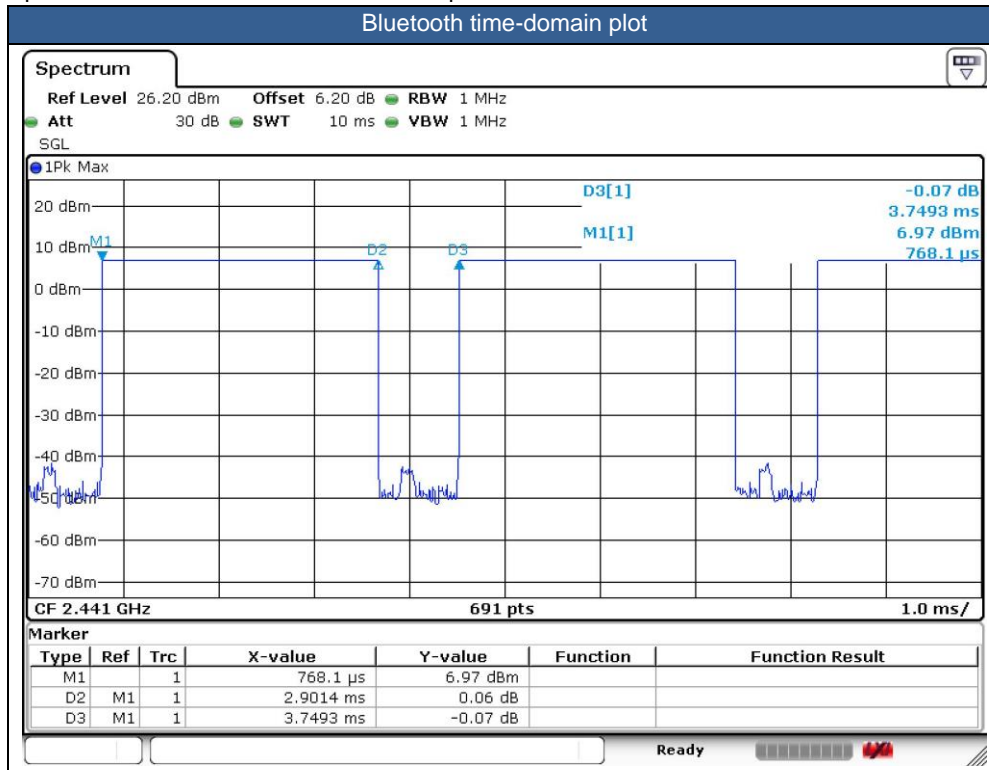



14. SAR Test Results

General Note:

1. Per KDB 447498 D01v06, the reported SAR is the measured SAR value adjusted for maximum tune-up tolerance.
 - a. Tune-up scaling Factor = tune-up limit power (mW) / EUT RF power (mW), where tune-up limit is the maximum rated power among all production units.
 - b. For SAR testing of WLAN signal with non-100% duty cycle, the measured SAR is scaled-up by the duty cycle scaling factor which is equal to "1/(duty cycle)"
 - c. For WWAN: Reported SAR(W/kg)= Measured SAR(W/kg)*Tune-up Scaling Factor
 - d. For BT/WLAN: Reported SAR(W/kg)= Measured SAR(W/kg)* Duty Cycle scaling factor * Tune-up scaling factor
 - e. For TDD LTE SAR measurement, the duty cycle 1:1.59 (62.9 %) was used perform testing and considering the theoretical duty cycle of 63.3% for extended cyclic prefix in the uplink, and the theoretical duty cycle of 62.9% for normal cyclic prefix in uplink, a scaling factor of extended cyclic prefix $63.3\%/62.9\% = 1.006$ is applied to scale-up the measured SAR result. The Reported TDD LTE SAR = measured SAR (W/kg)* Tune-up Scaling Factor* scaling factor for extended cyclic prefix.
2. Per KDB 447498 D01v06, for each exposure position, testing of other required channels within the operating mode of a frequency band is not required when the *reported* 1-g or 10-g SAR for the mid-band or highest output power channel is:
 - ≤ 0.8 W/kg or 2.0 W/kg, for 1-g or 10-g respectively, when the transmission band is ≤ 100 MHz
 - ≤ 0.6 W/kg or 1.5 W/kg, for 1-g or 10-g respectively, when the transmission band is between 100 MHz and 200 MHz
 - ≤ 0.4 W/kg or 1.0 W/kg, for 1-g or 10-g respectively, when the transmission band is ≥ 200 MHz
3. Per KDB 865664 D01v01r04, for each frequency band, repeated SAR measurement is required when the measured SAR is ≥ 0.8 W/kg. Per KDB 865664 D01v01r04, if the extremity repeated SAR is necessary, the same procedures should be adapted for measurements according to extremity and occupational exposure limits by applying a factor of 2.5 for extremity exposure and a factor of 5 for occupational exposure to the corresponding SAR thresholds.
4. Pre KDB648474 D04v01r03, when the reported SAR for a body-worn accessory, measured without a headset connected to the handset, is > 1.2 W/kg, the highest reported SAR configuration for that wireless mode and frequency band should be repeated for that body-worn accessory with a headset attached to the handset. When headset SAR is less than or equal than without headset SAR, no need to verify the remaining channels for headset SAR.
5. When the phone is in talking mode and receiver worked, then power reduction will be implemented immediately at WLAN2.4GHz/WLAN5.2GHz/5.3GHz.
6. When handheld state, when WWAN transmit simultaneous with WLAN/Bluetooth, for WLAN2.4G / 5.2GHz / 5.3GHz / 5.5GHz / 5.8GHz, product specific 10g SAR condition reduced powers will be active for front or back side. Other faces full power can be tested pass, so reduced power no need to be evaluated.
7. The device employs proximity sensors that detect the presence of the user's body at the front or back faces of the device. When front or back body worn condition is detected, GSM850/1900, WCDMA band II/IV, LTE band 2/4/7/66/38/41 and WLAN2.4GHz/WLAN5.2GHz/5.3GHz/5.5GHz/5.8GHz reduced power will be active. (P-sensor can't work at detecting presence of the user's body at the four edges of the device.)
8. P-sensor can detect handheld state, GSM1900, WCDMA band II/IV and LTE B2/4/66 for front/back/bottom sides of product specific 10g SAR condition reduced powers will be active.
9. When hotspot mode is enabled, power reduction will be activated to limit the maximum power of GSM850/1900, WCDMA band II/IV, LTE band 2/4/7/66/38/41 and 2.4GHz/WLAN/5.2GHz/WLAN/5.8GHz.
10. For P-sensor reduced power level is higher than hotspot reduced power for GSM1900, WCDMA band IV and LTE band 2/4/66/38/41, so for front/back P-sensor SAR can represent conservatively for front/back hotspot SAR.
11. This device has two WWAN transmitter antennas. WWAN antenna 1 is located at the right of bottom edge of the device and WWAN antenna 2 is located at the left side of bottom edge of the device which can refer to antenna location chapter. WWAN antenna 1 frequency bands include GSM850/1900, WCDMA Band II/IV/V, and LTE Band 2/4/5/12/17/26/66, WWAN antenna 2 frequency band include LTE Band 7/38/41.
12. Per KDB648474 D04v01r03, for smart phones with a display diagonal dimension > 15.0 cm or an overall diagonal dimension > 16.0 cm, when hotspot mode applies, 10-g extremity SAR is required only for the surfaces and edges with hotspot mode 1-g reported SAR > 1.2 W/kg, however, when power reduction applies to hotspot mode the measured SAR must be scaled to the maximum output power (for handheld on state, the maximum full power means reduced power), including tolerance, allowed for phablet modes to compare with the 1.2 W/kg SAR test reduction threshold.
 - a. For this device SAR for WWAN/WLAN transmitter scaled to maximum output power mode for product specific 10g SAR is higher than 1.2 W/kg of GSM850/1900, WCDMA Band II/IV/V, LTE Band 2/4/5/7/26/41/66, and WLAN 2.4/5.25.3/5.5/5.8GHz therefore product specific 10g SAR is necessary.
 - b. WLAN 5.3/5.5GHz tested the product specific 10g SAR since it has no hotspot mode.
 - c. When 10-g product specific 10g SAR is considered, SAR thresholds is specified in the procedures for SAR test reduction and exclusion should be multiplied by 2.5.



13. For verification of compliance of power reduction scheme, additional SAR testing with EUT transmitting at full RF power at a conservative trigger distance was performed for body worn:
Front: [12 mm](#)
Back: [18 mm](#)
14. For verification of compliance of power reduction scheme, additional SAR testing with EUT transmitting at full RF power at a conservative trigger distance was performed for handheld:
Front: [6 mm](#)
Back: [11 mm](#)
Bottom side: [11 mm](#)

GSM Note:

1. Per KDB 941225 D01v03r01, for SAR test reduction for GSM / GPRS / EDGE modes is determined by the source-based time-averaged output power including tune-up tolerance. The mode with highest specified time-averaged output power should be tested for SAR compliance in the applicable exposure conditions. For modes with the same specified maximum output power and tolerance, the higher number time-slot configuration should be tested. Therefore, the GPRS 2Tx slots for GSM850 and the GPRS 4Tx slots for GSM1900 are considered as the primary mode.
2. Other configurations of GSM / GPRS / EDGE are considered as secondary modes. The 3G SAR test reduction procedure is applied, when the maximum output power and tune-up tolerance specified for production units in a secondary mode is \leq ¼ dB higher than the primary mode, SAR measurement is not required for the secondary mode.

WCDMA Note:

1. Per KDB 941225 D01v03r01, for SAR testing is measured using a 12.2 kbps RMC with TPC bits configured to all "1's".
2. Per KDB 941225 D01v03r01, RMC 12.2kbps setting is used to evaluate SAR. The maximum output power and tune-up tolerance specified for production units in HSDPA / HSUPA / DC-HSDPA is \leq ¼ dB higher than RMC 12.2Kbps or when the highest reported SAR of the RMC12.2Kbps is scaled by the ratio of specified maximum output power and tune-up tolerance of HSDPA / HSUPA / DC-HSDPA to RMC12.2Kbps and the adjusted SAR is \leq 1.2 W/kg, SAR measurement is not required for HSDPA / HSUPA / DC-HSDPA, and according to the following RF output power, the output power results of the secondary modes (HSDPA / HSUPA / DC-HSDPA) are less than ¼ dB higher than the primary modes; therefore, SAR measurement is not required for HSDPA / HSUPA / DC-HSDPA.

LTE Note:

1. Per KDB 941225 D05v02r05, start with the largest channel bandwidth and measure SAR for QPSK with 1 RB allocation, using the RB offset and required test channel combination with the highest maximum output power for RB offsets at the upper edge, middle and lower edge of each required test channel.
2. Per KDB 941225 D05v02r05, 50% RB allocation for QPSK SAR testing follows 1RB QPSK allocation procedure.
3. Per KDB 941225 D05v02r05, for QPSK with 100% RB allocation, SAR is not required when the highest maximum output power for 100 % RB allocation is less than the highest maximum output power in 50% and 1 RB allocations and the highest reported SAR for 1 RB and 50% RB allocation are ≤ 0.8 W/kg. Otherwise, SAR is measured for the highest output power channel; and if the reported SAR is > 1.45 W/kg, the remaining required test channels must also be tested.
4. Per KDB 941225 D05v02r05, 16QAM/64QAM output power for each RB allocation configuration is $>$ not $\frac{1}{2}$ dB higher than the same configuration in QPSK and the reported SAR for the QPSK configuration is ≤ 1.45 W/kg; Per KDB 941225 D05v02r05, 16QAM/64QAM SAR testing is not required.
5. Per KDB 941225 D05v02r05, smaller bandwidth output power for each RB allocation configuration is $>$ not $\frac{1}{2}$ dB higher than the same configuration in the largest supported bandwidth, and the reported SAR for the largest supported bandwidth is ≤ 1.45 W/kg; Per KDB 941225 D05v02r05, smaller bandwidth SAR testing is not required.
6. This device supports HPUE for LTE band 41 with class 2 level, so HPUE SAR has been performed.
7. For LTE B4 / B5 / B12 / B17 / B26 / B71 the maximum bandwidth does not support three non-overlapping channels, per KDB 941225 D05v02r05, when a device supports overlapping channel assignment in a channel bandwidth configuration, the middle channel of the group of overlapping channels should be selected for testing.
8. LTE B4 / B5 / B17 / B38 SAR test was covered by LTE B66 / B26 / B12 / B41; according to April 2015 TCB workshop, SAR test for overlapping LTE bands can be reduced if
 - c. the maximum output power, including tolerance, for the smaller band is \leq the larger band to qualify for the SAR test exclusion
 - d. the channel bandwidth and other operating parameters for the smaller band are fully supported by the larger band

WLAN Note:

1. Per KDB 248227 D01v02r02, for 2.4GHz 802.11g/n SAR testing is not required when the highest reported SAR for DSSS is adjusted by the ratio of OFDM to DSSS specified maximum output power and the adjusted SAR is ≤ 1.2 W/kg.
2. Per KDB 248227 D01v02r02, U-NII-1 SAR testing is not required when the U-NII-2A band highest reported SAR for a test configuration is ≤ 1.2 W/kg, SAR is not required for U-NII-1 band.
3. When the reported SAR of the test position is > 0.4 W/kg, SAR is repeated for the 802.11 transmission mode configuration tested in the initial test position to measure the subsequent next closet/smallest test separation distance and maximum coupling test position on the highest maximum output power channel, until the report SAR is ≤ 0.8 W/kg or all required test position are tested.
4. For all positions / configurations, when the reported SAR is > 0.8 W/kg, SAR is measured for these test positions / configurations on the subsequent next highest measured output power channel(s) until the reported SAR is ≤ 1.2 W/kg or all required channels are tested.
5. During SAR testing the WLAN transmission was verified using a spectrum analyzer.
6. Based on WLAN 2.4GHz and Bluetooth share the same antenna, so Bluetooth RF exposure evaluation chose the worst position of WLAN 2.4GHz Ant to perform Bluetooth SAR test, and used this Bluetooth SAR value conservatively represent other position do co-located analysis with WWAN.
7. Bluetooth distance body SAR performed to do co-located analysis with WWAN analysis.



14.1 Head SAR

<GSM SAR>

Plot No.	Band	Mode	Test Position	Power Reduction	Ch.	Freq. (MHz)	Average Power (dBm)	Tune-Up Limit (dBm)	Tune-up Scaling Factor	Power Drift (dB)	Measured 1g SAR (W/kg)	Reported 1g SAR (W/kg)
01	GSM850	GPRS 3 Tx slots	Right Cheek	Full	128	824.2	30.51	31.50	1.256	0.01	0.097	0.122
	GSM850	GPRS 3 Tx slots	Right Tilted	Full	128	824.2	30.51	31.50	1.256	0.04	0.022	0.027
	GSM850	GPRS 3 Tx slots	Left Cheek	Full	128	824.2	30.51	31.50	1.256	0.08	0.087	0.109
	GSM850	GPRS 3 Tx slots	Left Tilted	Full	128	824.2	30.51	31.50	1.256	0.05	0.041	0.051
02	GSM1900	GPRS 3 Tx slots	Right Cheek	Full	810	1909.8	27.65	28.50	1.216	0.02	0.042	0.050
	GSM1900	GPRS 3 Tx slots	Right Tilted	Full	810	1909.8	27.65	28.50	1.216	0.02	0.028	0.034
	GSM1900	GPRS 3 Tx slots	Left Cheek	Full	810	1909.8	27.65	28.50	1.216	0.08	0.041	0.050
	GSM1900	GPRS 3 Tx slots	Left Tilted	Full	810	1909.8	27.65	28.50	1.216	-0.03	0.031	0.037

<WCDMA SAR>

Plot No.	Band	Mode	Test Position	Power Reduction	Ch.	Freq. (MHz)	Average Power (dBm)	Tune-Up Limit (dBm)	Tune-up Scaling Factor	Power Drift (dB)	Measured 1g SAR (W/kg)	Reported 1g SAR (W/kg)
03	WCDMA II	RMC 12.2Kbps	Right Cheek	Full	9538	1907.6	23.90	24.00	1.023	0.01	0.112	0.115
	WCDMA II	RMC 12.2Kbps	Right Tilted	Full	9538	1907.6	23.90	24.00	1.023	-0.04	0.067	0.069
	WCDMA II	RMC 12.2Kbps	Left Cheek	Full	9538	1907.6	23.90	24.00	1.023	0.01	0.094	0.096
	WCDMA II	RMC 12.2Kbps	Left Tilted	Full	9538	1907.6	23.90	24.00	1.023	0.01	0.087	0.089
04	WCDMA IV	RMC 12.2Kbps	Right Cheek	Full	1513	1752.6	23.74	24.00	1.062	0.11	0.186	0.197
	WCDMA IV	RMC 12.2Kbps	Right Tilted	Full	1513	1752.6	23.74	24.00	1.062	0.05	0.079	0.084
	WCDMA IV	RMC 12.2Kbps	Left Cheek	Full	1513	1752.6	23.74	24.00	1.062	0.01	0.155	0.165
	WCDMA IV	RMC 12.2Kbps	Left Tilted	Full	1513	1752.6	23.74	24.00	1.062	0.03	0.132	0.140
05	WCDMA V	RMC 12.2Kbps	Right Cheek	Full	4132	826.4	23.96	24.00	1.009	0.04	0.331	0.334
	WCDMA V	RMC 12.2Kbps	Right Tilted	Full	4132	826.4	23.96	24.00	1.009	0.04	0.163	0.165
	WCDMA V	RMC 12.2Kbps	Left Cheek	Full	4132	826.4	23.96	24.00	1.009	0.09	0.290	0.293
	WCDMA V	RMC 12.2Kbps	Left Tilted	Full	4132	826.4	23.96	24.00	1.009	0.07	0.173	0.175



<FDD LTE SAR>

Plot No.	Band	BW (MHz)	Modulation	RB Size	RB offset	Test Position	Power Reduction	Ch.	Freq. (MHz)	Average Power (dBm)	Tune-Up Limit (dBm)	Tune-up Scaling Factor	Power Drift (dB)	Measured 1g SAR (W/kg)	Reported 1g SAR (W/kg)
	LTE Band 2	20M	QPSK	1	0	Right Cheek	Full	18900	1880	22.93	24.00	1.279	0.03	0.132	0.169
	LTE Band 2	20M	QPSK	50	0	Right Cheek	Full	18900	1880	22.06	23.00	1.242	0.01	0.069	0.085
	LTE Band 2	20M	QPSK	1	0	Right Tilted	Full	18900	1880	22.93	24.00	1.279	0.03	0.073	0.093
	LTE Band 2	20M	QPSK	50	0	Right Tilted	Full	18900	1880	22.06	23.00	1.242	0.03	0.038	0.047
06	LTE Band 2	20M	QPSK	1	0	Left Cheek	Full	18900	1880	22.93	24.00	1.279	0.03	0.136	0.174
	LTE Band 2	20M	QPSK	50	0	Left Cheek	Full	18900	1880	22.06	23.00	1.242	0.01	0.067	0.083
	LTE Band 2	20M	QPSK	1	0	Left Tilted	Full	18900	1880	22.93	24.00	1.279	0.01	0.124	0.159
	LTE Band 2	20M	QPSK	50	0	Left Tilted	Full	18900	1880	22.06	23.00	1.242	0.03	0.065	0.081
07	LTE Band 26	15M	QPSK	1	0	Right Cheek	Full	26865	831.5	22.95	24.00	1.274	0.05	0.266	0.339
	LTE Band 26	15M	QPSK	36	0	Right Cheek	Full	26865	831.5	22.09	23.00	1.233	0.02	0.155	0.191
	LTE Band 26	15M	QPSK	1	0	Right Tilted	Full	26865	831.5	22.95	24.00	1.274	0.01	0.142	0.181
	LTE Band 26	15M	QPSK	36	0	Right Tilted	Full	26865	831.5	22.09	23.00	1.233	0.03	0.078	0.096
	LTE Band 26	15M	QPSK	1	0	Left Cheek	Full	26865	831.5	22.95	24.00	1.274	0.01	0.242	0.308
	LTE Band 26	15M	QPSK	36	0	Left Cheek	Full	26865	831.5	22.09	23.00	1.233	0.02	0.141	0.174
	LTE Band 26	15M	QPSK	1	0	Left Tilted	Full	26865	831.5	22.95	24.00	1.274	0.01	0.134	0.171
	LTE Band 26	15M	QPSK	36	0	Left Tilted	Full	26865	831.5	22.09	23.00	1.233	0.09	0.071	0.088
08	LTE Band 12	10M	QPSK	1	0	Right Cheek	Full	23095	707.5	22.88	24.00	1.294	0.19	0.210	0.272
	LTE Band 12	10M	QPSK	25	0	Right Cheek	Full	23095	707.5	21.86	23.00	1.300	-0.02	0.120	0.156
	LTE Band 12	10M	QPSK	1	0	Right Tilted	Full	23095	707.5	22.88	24.00	1.294	-0.04	0.091	0.117
	LTE Band 12	10M	QPSK	25	0	Right Tilted	Full	23095	707.5	21.86	23.00	1.300	0.08	0.057	0.073
	LTE Band 12	10M	QPSK	1	0	Left Cheek	Full	23095	707.5	22.88	24.00	1.294	0.07	0.194	0.251
	LTE Band 12	10M	QPSK	25	0	Left Cheek	Full	23095	707.5	21.86	23.00	1.300	0.05	0.109	0.142
	LTE Band 12	10M	QPSK	1	0	Left Tilted	Full	23095	707.5	22.88	24.00	1.294	0.05	0.088	0.114
	LTE Band 12	10M	QPSK	25	0	Left Tilted	Full	23095	707.5	21.86	23.00	1.300	0.03	0.050	0.065
09	LTE Band 66	20M	QPSK	1	0	Right Cheek	Full	132322	1745	23.06	24.00	1.242	0.01	0.135	0.168
	LTE Band 66	20M	QPSK	50	0	Right Cheek	Full	132322	1745	22.09	23.00	1.233	0.03	0.108	0.133
	LTE Band 66	20M	QPSK	1	0	Right Tilted	Full	132322	1745	23.06	24.00	1.242	0.01	0.068	0.085
	LTE Band 66	20M	QPSK	50	0	Right Tilted	Full	132322	1745	22.09	23.00	1.233	0.03	0.055	0.068
	LTE Band 66	20M	QPSK	1	0	Left Cheek	Full	132322	1745	23.06	24.00	1.242	0.01	0.104	0.129
	LTE Band 66	20M	QPSK	50	0	Left Cheek	Full	132322	1745	22.09	23.00	1.233	0.01	0.090	0.111
	LTE Band 66	20M	QPSK	1	0	Left Tilted	Full	132322	1745	23.06	24.00	1.242	0.03	0.094	0.117
	LTE Band 66	20M	QPSK	50	0	Left Tilted	Full	132322	1745	22.09	23.00	1.233	0.01	0.075	0.092
10	LTE Band 7	20M	QPSK	1	0	Right Cheek	Full	21100	2535	22.44	24.00	1.432	0.07	0.101	0.145
	LTE Band 7	20M	QPSK	50	0	Right Cheek	Full	21100	2535	21.47	23.00	1.422	0.03	0.055	0.078
	LTE Band 7	20M	QPSK	1	0	Right Tilted	Full	21100	2535	22.44	24.00	1.432	0.03	0.067	0.095
	LTE Band 7	20M	QPSK	50	0	Right Tilted	Full	21100	2535	21.47	23.00	1.422	0.04	0.035	0.049
	LTE Band 7	20M	QPSK	1	0	Left Cheek	Full	21100	2535	22.44	24.00	1.432	0.01	0.064	0.092
	LTE Band 7	20M	QPSK	50	0	Left Cheek	Full	21100	2535	21.47	23.00	1.422	0.03	0.039	0.055
	LTE Band 7	20M	QPSK	1	0	Left Tilted	Full	21100	2535	22.44	24.00	1.432	0.01	0.030	0.043
	LTE Band 7	20M	QPSK	50	0	Left Tilted	Full	21100	2535	21.47	23.00	1.422	0.01	0.018	0.025



<TDD LTE SAR>

Plot No.	Band	BW (MHz)	Modulation	RB Size	RB offset	Test Position	Power Reduction	Ch.	Freq. (MHz)	Average Power (dBm)	Tune-Up Limit (dBm)	Tune-up Scaling Factor	Duty Cycle %	Duty Cycle Scaling Factor	Power Drift (dB)	Measured 1g SAR (W/kg)	Reported 1g SAR (W/kg)
11	LTE Band 41	20M	QPSK	1	0	Right Cheek	Full	40640	2595	22.67	24.00	1.358	62.9	1.006	-0.06	0.087	0.119
	LTE Band 41	20M	QPSK	50	0	Right Cheek	Full	40640	2595	21.45	23.00	1.429	62.9	1.006	0.07	0.048	0.069
	LTE Band 41	20M	QPSK	1	0	Right Tilted	Full	40640	2595	22.67	24.00	1.358	62.9	1.006	0.01	0.073	0.100
	LTE Band 41	20M	QPSK	50	0	Right Tilted	Full	40640	2595	21.45	23.00	1.429	62.9	1.006	0.05	0.041	0.059
	LTE Band 41	20M	QPSK	1	0	Left Cheek	Full	40640	2595	22.67	24.00	1.358	62.9	1.006	0.02	0.060	0.081
	LTE Band 41	20M	QPSK	50	0	Left Cheek	Full	40640	2595	21.45	23.00	1.429	62.9	1.006	-0.08	0.032	0.046
	LTE Band 41	20M	QPSK	1	0	Left Tilted	Full	40640	2595	22.67	24.00	1.358	62.9	1.006	-0.03	0.038	0.051
	LTE Band 41	20M	QPSK	50	0	Left Tilted	Full	40640	2595	21.45	23.00	1.429	62.9	1.006	0.03	0.021	0.030

<WLAN 2.4GHz SAR>

Plot No.	Band	Mode	Test Position	Power Reduction	Ch.	Freq. (MHz)	Average Power (dBm)	Tune-Up Limit (dBm)	Tune-up Scaling Factor	Duty Cycle %	Duty Cycle Scaling Factor	Power Drift (dB)	Measured 1g SAR (W/kg)	Reported 1g SAR (W/kg)
	WLAN2.4GHz	802.11b 1Mbps	Right Cheek	Reduced	1	2412	17.29	18.00	1.178	100	1.000	0.01	0.463	0.545
	WLAN2.4GHz	802.11b 1Mbps	Right Tilted	Reduced	1	2412	17.29	18.00	1.178	100	1.000	0.02	0.485	0.571
12	WLAN2.4GHz	802.11b 1Mbps	Left Cheek	Reduced	1	2412	17.29	18.00	1.178	100	1.000	0.08	0.936	1.102
	WLAN2.4GHz	802.11b 1Mbps	Left Cheek	Reduced	11	2462	17.08	18.00	1.236	100	1.000	-0.03	0.882	1.090
	WLAN2.4GHz	802.11b 1Mbps	Left Tilted	Reduced	1	2412	17.29	18.00	1.178	100	1.000	0.01	0.631	0.743



<WLAN 5GHz SAR>

Plot No.	Band	Mode	Test Position	Power Reduction	Ch.	Freq. (MHz)	Average Power (dBm)	Tune-Up Limit (dBm)	Tune-up Scaling Factor	Duty Cycle %	Duty Cycle Scaling Factor	Power Drift (dB)	Measured 1g SAR (W/kg)	Reported 1g SAR (W/kg)
	WLAN5.3GHz	802.11n-HT40 MCS0	Right Cheek	Reduced	62	5310	15.89	16.00	1.026	96.3	1.038	0.03	0.791	0.842
	WLAN5.3GHz	802.11n-HT40 MCS0	Right Cheek	Reduced	54	5270	15.85	16.00	1.035	96.3	1.038	0.04	0.818	0.879
	WLAN5.3GHz	802.11n-HT40 MCS0	Right Tilted	Reduced	62	5310	15.89	16.00	1.026	96.3	1.038	0.03	0.753	0.802
	WLAN5.3GHz	802.11n-HT40 MCS0	Right Tilted	Reduced	54	5270	15.85	16.00	1.035	96.3	1.038	0.01	0.851	0.914
13	WLAN5.3GHz	802.11n-HT40 MCS0	Left Cheek	Reduced	62	5310	15.89	16.00	1.026	96.3	1.038	-0.13	1.120	1.192
	WLAN5.3GHz	802.11n-HT40 MCS0	Left Cheek	Reduced	54	5270	15.85	16.00	1.035	96.3	1.038	0.03	0.882	0.948
	WLAN5.3GHz	802.11n-HT40 MCS0	Left Tilted	Reduced	62	5310	15.89	16.00	1.026	96.3	1.038	-0.08	0.987	1.051
	WLAN5.3GHz	802.11n-HT40 MCS0	Left Tilted	Reduced	54	5270	15.85	16.00	1.035	96.3	1.038	0.07	1.050	1.128
	WLAN5.5GHz	802.11n-HT40 MCS0	Right Cheek	Full	134	5670	18.46	19.00	1.132	96.3	1.038	-0.1	0.849	0.998
	WLAN5.5GHz	802.11n-HT40 MCS0	Right Cheek	Full	102	5510	17.57	19.00	1.390	96.3	1.038	0.03	0.733	1.058
	WLAN5.5GHz	802.11n-HT40 MCS0	Right Tilted	Full	134	5670	18.46	19.00	1.132	96.3	1.038	-0.04	0.967	1.137
14	WLAN5.5GHz	802.11n-HT40 MCS0	Right Tilted	Full	102	5510	17.57	19.00	1.390	96.3	1.038	-0.07	0.796	1.148
	WLAN5.5GHz	802.11n-HT40 MCS0	Left Cheek	Full	134	5670	18.46	19.00	1.132	96.3	1.038	-0.01	0.593	0.697
	WLAN5.5GHz	802.11n-HT40 MCS0	Left Tilted	Full	134	5670	18.46	19.00	1.132	96.3	1.038	0.03	0.551	0.648
	WLAN5.8GHz	802.11a 6Mbps	Right Cheek	Full	165	5825	18.25	19.00	1.189	98.26	1.018	0.01	0.812	0.982
	WLAN5.8GHz	802.11a 6Mbps	Right Cheek	Full	157	5785	18.21	19.00	1.199	98.26	1.018	-0.02	0.964	1.177
	WLAN5.8GHz	802.11a 6Mbps	Right Tilted	Full	165	5825	18.25	19.00	1.189	98.26	1.018	-0.09	0.757	0.916
15	WLAN5.8GHz	802.11a 6Mbps	Right Tilted	Full	157	5785	18.21	19.00	1.199	98.26	1.018	-0.09	0.971	1.186
	WLAN5.8GHz	802.11a 6Mbps	Left Cheek	Full	165	5825	18.25	19.00	1.189	98.26	1.018	-0.12	0.825	0.998
	WLAN5.8GHz	802.11a 6Mbps	Left Cheek	Full	157	5785	18.21	19.00	1.199	98.26	1.018	-0.03	0.696	0.850
	WLAN5.8GHz	802.11a 6Mbps	Left Tilted	Full	165	5825	18.25	19.00	1.189	98.26	1.018	-0.02	0.781	0.945
	WLAN5.8GHz	802.11a 6Mbps	Left Tilted	Full	157	5785	18.21	19.00	1.199	98.26	1.018	-0.02	0.645	0.788

<Bluetooth SAR>

Plot No.	Band	Mode	Test Position	Power Mode	Ch.	Freq. (MHz)	Average Power (dBm)	Tune-Up Limit (dBm)	Tune-up Scaling Factor	Duty Cycle %	Duty Cycle Scaling Factor	Power Drift (dB)	Measured 1g SAR (W/kg)	Reported 1g SAR (W/kg)
16	Bluetooth	1Mbps	Left Cheek	Full	00	2402	7.67	9.00	1.357	77.39	1.076	0.03	0.060	0.088



14.2 Hotspot SAR

<GSM SAR>

Plot No.	Band	Mode	Test Position	Gap (mm)	Power Reduction	Ch.	Freq. (MHz)	Average Power (dBm)	Tune-Up Limit (dBm)	Tune-up Scaling Factor	Power Drift (dB)	Measured 1g SAR (W/kg)	Reported 1g SAR (W/kg)
	GSM850	GPRS 3 Tx slots	Front	5	Reduced	128	824.2	29.11	30.50	1.377	0.08	0.369	0.508
	GSM850	GPRS 3 Tx slots	Back	5	Reduced	128	824.2	29.11	30.50	1.377	0.02	0.601	0.828
	GSM850	GPRS 3 Tx slots	Back	5	Reduced	189	836.4	29.05	30.50	1.396	0.03	0.875	1.222
	GSM850	GPRS 3 Tx slots	Back	5	Reduced	251	848.8	28.86	30.50	1.459	0.07	0.880	1.284
	GSM850	GPRS 3 Tx slots	Left Side	5	Reduced	128	824.2	29.11	30.50	1.377	0.06	0.298	0.410
	GSM850	GPRS 3 Tx slots	Right Side	5	Reduced	128	824.2	29.11	30.50	1.377	0.09	0.401	0.552
	GSM850	GPRS 3 Tx slots	Bottom Side	5	Reduced	128	824.2	29.11	30.50	1.377	0.02	0.770	1.060
17	GSM850	GPRS 3 Tx slots	Bottom Side	5	Reduced	189	836.4	29.05	30.50	1.396	0.09	0.946	1.321
	GSM850	GPRS 3 Tx slots	Bottom Side	5	Reduced	251	848.8	28.86	30.50	1.459	0.06	0.795	1.160
	GSM1900	GPRS 3 Tx slots	Front	5	Reduced	810	1909.8	23.15	24.00	1.216	-0.12	0.654	0.795
	GSM1900	GPRS 3 Tx slots	Back	5	Reduced	810	1909.8	23.15	24.00	1.216	0.06	1.080	1.313
	GSM1900	GPRS 3 Tx slots	Back	5	Reduced	512	1850.2	22.74	24.00	1.337	0.13	0.862	1.152
	GSM1900	GPRS 3 Tx slots	Back	5	Reduced	661	1880	22.93	24.00	1.279	0.05	0.915	1.171
	GSM1900	GPRS 3 Tx slots	Left Side	5	Reduced	810	1909.8	22.36	23.00	1.159	0.09	0.145	0.168
	GSM1900	GPRS 3 Tx slots	Right Side	5	Reduced	810	1909.8	22.36	23.00	1.159	0.11	0.151	0.175
18	GSM1900	GPRS 3 Tx slots	Bottom Side	5	Reduced	810	1909.8	22.36	23.00	1.159	0.09	1.190	1.379
	GSM1900	GPRS 3 Tx slots	Bottom Side	5	Reduced	512	1850.2	22.00	23.00	1.259	-0.03	0.895	1.127
	GSM1900	GPRS 3 Tx slots	Bottom Side	5	Reduced	661	1880	21.93	23.00	1.279	-0.06	1.070	1.369



<WCDMA SAR>

Plot No.	Band	Mode	Test Position	Gap (mm)	Power Reduction	Ch.	Freq. (MHz)	Average Power (dBm)	Tune-Up Limit (dBm)	Tune-up Scaling Factor	Power Drift (dB)	Measured 1g SAR (W/kg)	Reported 1g SAR (W/kg)
	WCDMA II	RMC 12.2Kbps	Front	5	Reduced	9538	1907.6	16.55	17.00	1.109	0.09	0.782	0.867
	WCDMA II	RMC 12.2Kbps	Front	5	Reduced	9262	1852.4	16.48	17.00	1.127	0.04	0.641	0.723
	WCDMA II	RMC 12.2Kbps	Front	5	Reduced	9400	1880	16.41	17.00	1.146	-0.05	0.697	0.798
19	WCDMA II	RMC 12.2Kbps	Back	5	Reduced	9538	1907.6	16.55	17.00	1.109	0.09	1.250	1.386
	WCDMA II	RMC 12.2Kbps	Back	5	Reduced	9262	1852.4	16.48	17.00	1.127	-0.01	0.991	1.117
	WCDMA II	RMC 12.2Kbps	Back	5	Reduced	9400	1880	16.41	17.00	1.146	0.08	1.090	1.249
	WCDMA II	RMC 12.2Kbps	Left Side	5	Reduced	9538	1907.6	16.13	17.00	1.222	0.15	0.059	0.072
	WCDMA II	RMC 12.2Kbps	Right Side	5	Reduced	9538	1907.6	16.13	17.00	1.222	0.03	0.054	0.066
	WCDMA II	RMC 12.2Kbps	Bottom Side	5	Reduced	9538	1907.6	16.13	17.00	1.222	0.03	1.070	1.307
	WCDMA II	RMC 12.2Kbps	Bottom Side	5	Reduced	9262	1852.4	16.11	17.00	1.227	0.03	1.010	1.240
	WCDMA II	RMC 12.2Kbps	Bottom Side	5	Reduced	9400	1880	16.00	17.00	1.259	0.03	0.925	1.165
	WCDMA IV	RMC 12.2Kbps	Front	5	Reduced	1513	1752.6	17.28	18.00	1.180	-0.01	0.789	0.931
	WCDMA IV	RMC 12.2Kbps	Front	5	Reduced	1312	1712.4	17.05	18.00	1.245	0.03	0.588	0.732
	WCDMA IV	RMC 12.2Kbps	Front	5	Reduced	1413	1732.6	17.11	18.00	1.227	-0.07	0.678	0.832
20	WCDMA IV	RMC 12.2Kbps	Back	5	Reduced	1513	1752.6	17.28	18.00	1.180	0	1.170	1.381
	WCDMA IV	RMC 12.2Kbps	Back	5	Reduced	1312	1712.4	17.05	18.00	1.245	0.03	0.956	1.190
	WCDMA IV	RMC 12.2Kbps	Back	5	Reduced	1413	1732.6	17.11	18.00	1.227	0.03	1.100	1.350
	WCDMA IV	RMC 12.2Kbps	Left Side	5	Reduced	1513	1752.6	15.97	16.50	1.130	0.01	0.045	0.051
	WCDMA IV	RMC 12.2Kbps	Right Side	5	Reduced	1513	1752.6	15.97	16.50	1.130	0.07	0.066	0.075
	WCDMA IV	RMC 12.2Kbps	Bottom Side	5	Reduced	1513	1752.6	15.97	16.50	1.130	0.06	1.200	1.356
	WCDMA IV	RMC 12.2Kbps	Bottom Side	5	Reduced	1312	1712.4	15.8	16.50	1.175	0.03	0.880	1.034
	WCDMA IV	RMC 12.2Kbps	Bottom Side	5	Reduced	1413	1732.6	15.94	16.50	1.138	0.03	0.995	1.132
	WCDMA V	RMC 12.2Kbps	Front	5	Full	4132	826.4	23.96	24.00	1.009	-0.16	0.788	0.795
	WCDMA V	RMC 12.2Kbps	Back	5	Full	4132	826.4	23.96	24.00	1.009	-0.01	1.230	1.241
	WCDMA V	RMC 12.2Kbps	Back	5	Full	4182	836.4	23.86	24.00	1.033	0.04	1.250	1.291
21	WCDMA V	RMC 12.2Kbps	Back	5	Full	4233	846.6	23.63	24.00	1.089	0.02	1.190	1.296
	WCDMA V	RMC 12.2Kbps	Left Side	5	Full	4132	826.4	23.96	24.00	1.009	0.05	0.369	0.372
	WCDMA V	RMC 12.2Kbps	Right Side	5	Full	4132	826.4	23.96	24.00	1.009	0.03	0.654	0.660
	WCDMA V	RMC 12.2Kbps	Bottom Side	5	Full	4132	826.4	23.96	24.00	1.009	0.09	0.934	0.943
	WCDMA V	RMC 12.2Kbps	Bottom Side	5	Full	4182	836.4	23.86	24.00	1.033	0.06	1.210	1.250
	WCDMA V	RMC 12.2Kbps	Bottom Side	5	Full	4233	846.6	23.63	24.00	1.089	0.04	1.100	1.198



<FDD LTE SAR>

Plot No.	Band	BW (MHz)	Modulation	RB Size	RB offset	Test Position	Gap (mm)	Power Reduction	Ch.	Freq. (MHz)	Average Power (dBm)	Tune-Up Limit (dBm)	Tune-up Scaling Factor	Power Drift (dB)	Measured 1g SAR (W/kg)	Reported 1g SAR (W/kg)
	LTE Band 2	20M	QPSK	1	0	Front	5	Reduced	18900	1880	16.43	17.00	1.140	0.18	0.776	0.885
	LTE Band 2	20M	QPSK	1	0	Front	5	Reduced	18700	1860	16.19	17.00	1.205	0.07	0.674	0.812
	LTE Band 2	20M	QPSK	1	0	Front	5	Reduced	19100	1900	16.14	17.00	1.219	0.01	0.814	0.992
	LTE Band 2	20M	QPSK	50	0	Front	5	Reduced	18900	1880	16.11	17.00	1.227	0.05	0.765	0.939
	LTE Band 2	20M	QPSK	50	0	Front	5	Reduced	18700	1860	15.91	17.00	1.285	0.12	0.793	1.019
	LTE Band 2	20M	QPSK	50	0	Front	5	Reduced	19100	1900	16.10	17.00	1.230	0.02	0.821	1.010
	LTE Band 2	20M	QPSK	100	0	Front	5	Reduced	18900	1880	16.13	17.00	1.222	0.19	0.784	0.958
	LTE Band 2	20M	QPSK	1	0	Back	5	Reduced	18900	1880	16.43	17.00	1.140	-0.03	0.921	1.050
	LTE Band 2	20M	QPSK	1	0	Back	5	Reduced	18700	1860	16.19	17.00	1.205	0.05	0.772	0.930
	LTE Band 2	20M	QPSK	1	0	Back	5	Reduced	19100	1900	16.14	17.00	1.219	-0.16	0.810	0.987
	LTE Band 2	20M	QPSK	50	0	Back	5	Reduced	18900	1880	16.11	17.00	1.227	-0.19	0.753	0.924
	LTE Band 2	20M	QPSK	50	0	Back	5	Reduced	18700	1860	15.91	17.00	1.285	0.04	0.945	1.215
	LTE Band 2	20M	QPSK	50	0	Back	5	Reduced	19100	1900	16.10	17.00	1.230	0.15	0.876	1.078
	LTE Band 2	20M	QPSK	100	0	Back	5	Reduced	18900	1880	16.13	17.00	1.222	-0.02	0.763	0.932
	LTE Band 2	20M	QPSK	1	0	Left side	5	Reduced	18900	1880	14.63	15.00	1.089	0.07	0.041	0.044
	LTE Band 2	20M	QPSK	50	0	Left side	5	Reduced	18900	1880	14.25	15.00	1.189	0.04	0.039	0.046
	LTE Band 2	20M	QPSK	1	0	Right Side	5	Reduced	18900	1880	14.63	15.00	1.089	0.19	0.041	0.044
	LTE Band 2	20M	QPSK	50	0	Right Side	5	Reduced	18900	1880	14.25	15.00	1.189	0.03	0.037	0.044
	LTE Band 2	20M	QPSK	1	0	Bottom Side	5	Reduced	18900	1880	14.63	15.00	1.089	-0.03	1.110	1.209
	LTE Band 2	20M	QPSK	1	0	Bottom Side	5	Reduced	18700	1860	14.34	15.00	1.164	-0.14	0.890	1.036
	LTE Band 2	20M	QPSK	1	0	Bottom Side	5	Reduced	19100	1900	14.32	15.00	1.169	0.15	1.130	1.322
	LTE Band 2	20M	QPSK	50	0	Bottom Side	5	Reduced	18900	1880	14.25	15.00	1.189	-0.06	1.000	1.189
	LTE Band 2	20M	QPSK	50	0	Bottom Side	5	Reduced	18700	1860	14.12	15.00	1.225	-0.09	0.856	1.048
22	LTE Band 2	20M	QPSK	50	0	Bottom Side	5	Reduced	19100	1900	14.24	15.00	1.191	0.02	1.120	1.334
	LTE Band 2	20M	QPSK	100	0	Bottom Side	5	Reduced	18900	1880	14.23	15.00	1.194	-0.07	1.020	1.218
	LTE Band 26	15M	QPSK	1	0	Front	5	Full	26865	831.5	22.95	24.00	1.274	0.01	0.877	1.117
	LTE Band 26	15M	QPSK	36	0	Front	5	Full	26865	831.5	22.09	23.00	1.233	0.13	0.486	0.599
	LTE Band 26	15M	QPSK	75	0	Front	5	Full	26865	831.5	22.05	23.00	1.245	0.09	0.476	0.592
23	LTE Band 26	15M	QPSK	1	0	Back	5	Full	26865	831.5	22.95	24.00	1.274	-0.02	0.895	1.140
	LTE Band 26	15M	QPSK	36	0	Back	5	Full	26865	831.5	22.09	23.00	1.233	0.07	0.638	0.787
	LTE Band 26	15M	QPSK	75	0	Back	5	Full	26865	831.5	22.05	23.00	1.245	-0.01	0.447	0.556
	LTE Band 26	15M	QPSK	1	0	Left side	5	Full	26865	831.5	22.95	24.00	1.274	-0.09	0.343	0.437
	LTE Band 26	15M	QPSK	36	0	Left side	5	Full	26865	831.5	22.09	23.00	1.233	0.03	0.181	0.223
	LTE Band 26	15M	QPSK	1	0	Right Side	5	Full	26865	831.5	22.95	24.00	1.274	0.07	0.568	0.723
	LTE Band 26	15M	QPSK	36	0	Right Side	5	Full	26865	831.5	22.09	23.00	1.233	0.08	0.309	0.381
	LTE Band 26	15M	QPSK	1	0	Bottom Side	5	Full	26865	831.5	22.95	24.00	1.274	0.05	0.875	1.114
	LTE Band 26	15M	QPSK	36	0	Bottom Side	5	Full	26865	831.5	22.09	23.00	1.233	0.06	0.484	0.597
	LTE Band 26	15M	QPSK	75	0	Bottom Side	5	Full	26865	831.5	22.05	23.00	1.245	-0.16	0.464	0.577
	LTE Band 12	10M	QPSK	1	0	Front	5	Full	23095	707.5	22.88	24.00	1.294	0.01	0.435	0.563
	LTE Band 12	10M	QPSK	25	0	Front	5	Full	23095	707.5	21.86	23.00	1.300	0.03	0.245	0.319
24	LTE Band 12	10M	QPSK	1	0	Back	5	Full	23095	707.5	22.88	24.00	1.294	-0.02	0.775	1.003
	LTE Band 12	10M	QPSK	25	0	Back	5	Full	23095	707.5	21.86	23.00	1.300	0.01	0.464	0.603
	LTE Band 12	10M	QPSK	50	0	Back	5	Full	23095	707.5	21.80	23.00	1.318	0.04	0.473	0.624
	LTE Band 12	10M	QPSK	1	0	Left side	5	Full	23095	707.5	22.88	24.00	1.294	0.05	0.288	0.373
	LTE Band 12	10M	QPSK	25	0	Left side	5	Full	23095	707.5	21.86	23.00	1.300	0.05	0.170	0.221
	LTE Band 12	10M	QPSK	1	0	Right Side	5	Full	23095	707.5	22.88	24.00	1.294	0.03	0.395	0.511
	LTE Band 12	10M	QPSK	25	0	Right Side	5	Full	23095	707.5	21.86	23.00	1.300	-0.02	0.233	0.303
	LTE Band 12	10M	QPSK	1	0	Bottom Side	5	Full	23095	707.5	22.88	24.00	1.294	0.01	0.588	0.761
	LTE Band 12	10M	QPSK	25	0	Bottom Side	5	Full	23095	707.5	21.86	23.00	1.300	0.1	0.341	0.443



Plot No.	Band	BW (MHz)	Modulation	RB Size	RB offset	Test Position	Gap (mm)	Power Reduction	Ch.	Freq. (MHz)	Average Power (dBm)	Tune-Up Limit (dBm)	Tune-up Scaling Factor	Power Drift (dB)	Measured 1g SAR (W/kg)	Reported 1g SAR (W/kg)
	LTE Band 66	20M	QPSK	1	0	Front	5	Reduced	132322	1745	18.79	19.00	1.050	0.1	0.673	0.706
	LTE Band 66	20M	QPSK	50	0	Front	5	Reduced	132322	1745	18.50	19.00	1.122	0.07	0.408	0.458
	LTE Band 66	20M	QPSK	1	0	Back	5	Reduced	132322	1745	18.79	19.00	1.050	0.16	1.100	1.154
	LTE Band 66	20M	QPSK	1	0	Back	5	Reduced	132072	1720	18.48	19.00	1.127	0.15	0.924	1.042
	LTE Band 66	20M	QPSK	1	0	Back	5	Reduced	132572	1770	18.38	19.00	1.153	0.03	1.190	1.373
	LTE Band 66	20M	QPSK	50	0	Back	5	Reduced	132322	1745	18.50	19.00	1.122	0.05	1.130	1.268
	LTE Band 66	20M	QPSK	50	0	Back	5	Reduced	132072	1720	18.38	19.00	1.153	0.01	0.937	1.081
	LTE Band 66	20M	QPSK	50	0	Back	5	Reduced	132572	1770	18.48	19.00	1.127	-0.03	1.220	1.375
25	LTE Band 66	20M	QPSK	100	0	Back	5	Reduced	132322	1745	18.32	19.00	1.169	0.09	1.180	1.380
	LTE Band 66	20M	QPSK	1	0	Left side	5	Reduced	132322	1745	16.82	17.50	1.169	0.18	0.039	0.045
	LTE Band 66	20M	QPSK	50	0	Left side	5	Reduced	132322	1745	16.76	17.50	1.186	-0.06	0.041	0.048
	LTE Band 66	20M	QPSK	1	0	Right Side	5	Reduced	132322	1745	16.82	17.50	1.169	-0.12	0.054	0.064
	LTE Band 66	20M	QPSK	50	0	Right Side	5	Reduced	132322	1745	16.76	17.50	1.186	0.07	0.059	0.070
	LTE Band 66	20M	QPSK	1	0	Bottom Side	5	Reduced	132322	1745	16.82	17.50	1.169	0.07	1.010	1.181
	LTE Band 66	20M	QPSK	1	0	Bottom Side	5	Reduced	132072	1720	16.57	17.50	1.239	-0.03	0.871	1.079
	LTE Band 66	20M	QPSK	1	0	Bottom Side	5	Reduced	132572	1770	16.66	17.50	1.213	0.05	1.070	1.298
	LTE Band 66	20M	QPSK	50	0	Bottom Side	5	Reduced	132322	1745	16.76	17.50	1.186	-0.01	1.090	1.292
	LTE Band 66	20M	QPSK	50	0	Bottom Side	5	Reduced	132072	1720	16.68	17.50	1.208	0.01	0.898	1.085
	LTE Band 66	20M	QPSK	50	0	Bottom Side	5	Reduced	132572	1770	16.73	17.50	1.194	0.08	1.150	1.373
	LTE Band 66	20M	QPSK	100	0	Bottom Side	5	Reduced	132322	1745	16.67	17.50	1.211	0.06	1.130	1.368
	LTE Band 7	20M	QPSK	1	0	Front	5	Reduced	21100	2535	19.91	21.00	1.285	0.08	0.450	0.578
	LTE Band 7	20M	QPSK	50	0	Front	5	Reduced	21100	2535	19.70	21.00	1.349	0.08	0.458	0.618
	LTE Band 7	20M	QPSK	1	0	Back	5	Reduced	21100	2535	19.91	21.00	1.285	-0.11	0.603	0.775
	LTE Band 7	20M	QPSK	50	0	Back	5	Reduced	21100	2535	19.70	21.00	1.349	-0.16	0.782	1.055
	LTE Band 7	20M	QPSK	50	0	Back	5	Reduced	20850	2510	19.68	21.00	1.355	0.16	0.725	0.983
	LTE Band 7	20M	QPSK	50	0	Back	5	Reduced	21350	2560	19.56	21.00	1.393	0.04	0.929	1.294
	LTE Band 7	20M	QPSK	100	0	Back	5	Reduced	21100	2535	19.54	21.00	1.400	0.06	0.892	1.248
	LTE Band 7	20M	QPSK	1	0	Left side	5	Reduced	21100	2535	19.91	21.00	1.285	0.03	0.533	0.685
	LTE Band 7	20M	QPSK	50	0	Left side	5	Reduced	21100	2535	19.70	21.00	1.349	0.19	0.542	0.731
	LTE Band 7	20M	QPSK	1	0	Bottom Side	5	Reduced	21100	2535	19.91	21.00	1.285	0.06	0.748	0.961
	LTE Band 7	20M	QPSK	1	0	Bottom Side	5	Reduced	20850	2510	19.78	21.00	1.324	0.02	0.656	0.869
	LTE Band 7	20M	QPSK	1	0	Bottom Side	5	Reduced	21350	2560	19.89	21.00	1.291	0.03	0.897	1.158
	LTE Band 7	20M	QPSK	50	0	Bottom Side	5	Reduced	21100	2535	19.70	21.00	1.349	0.13	0.799	1.078
	LTE Band 7	20M	QPSK	50	0	Bottom Side	5	Reduced	20850	2510	19.68	21.00	1.355	0.02	0.749	1.015
26	LTE Band 7	20M	QPSK	50	0	Bottom Side	5	Reduced	21350	2560	19.56	21.00	1.393	-0.1	0.933	1.300
	LTE Band 7	20M	QPSK	100	0	Bottom Side	5	Reduced	21100	2535	19.54	21.00	1.400	0.05	0.834	1.167



<TDD LTE SAR>

Plot No.	Band	BW (MHz)	Modulation	RB Size	RB offset	Test Position	Gap (mm)	Power Reduction	Ch.	Freq. (MHz)	Average Power (dBm)	Tune-Up Limit (dBm)	Tune-up Scaling Factor	Duty Cycle %	Duty Cycle Scaling Factor	Power Drift (dB)	Measured 1g SAR (W/kg)	Reported 1g SAR (W/kg)
	LTE Band 41	20M	QPSK	1	0	Front	5	Reduced	40640	2595	21.41	23.00	1.442	62.9	1.006	-0.04	0.555	0.805
	LTE Band 41	20M	QPSK	1	0	Front	5	Reduced	40140	2545	21.23	23.00	1.503	62.9	1.006	0.09	0.354	0.535
	LTE Band 41	20M	QPSK	1	0	Front	5	Reduced	40390	2570	21.02	23.00	1.578	62.9	1.006	0.16	0.553	0.878
	LTE Band 41	20M	QPSK	1	0	Front	5	Reduced	40890	2620	21.40	23.00	1.445	62.9	1.006	0.13	0.559	0.813
	LTE Band 41	20M	QPSK	1	0	Front	5	Reduced	41140	2645	21.33	23.00	1.469	62.9	1.006	0.19	0.550	0.813
	LTE Band 41	20M	QPSK	50	0	Front	5	Reduced	40640	2595	21.39	23.00	1.449	62.9	1.006	0.05	0.426	0.621
	LTE Band 41	20M	QPSK	50	0	Front	5	Reduced	40140	2545	21.13	23.00	1.538	62.9	1.006	0.09	0.451	0.698
	LTE Band 41	20M	QPSK	50	0	Front	5	Reduced	40390	2570	21.14	23.00	1.535	62.9	1.006	-0.09	0.454	0.701
	LTE Band 41	20M	QPSK	50	0	Front	5	Reduced	40890	2620	21.38	23.00	1.452	62.9	1.006	0.01	0.426	0.622
	LTE Band 41	20M	QPSK	50	0	Front	5	Reduced	41140	2645	21.19	23.00	1.517	62.9	1.006	0.03	0.435	0.664
	LTE Band 41	20M	QPSK	100	0	Front	5	Reduced	40640	2595	21.26	23.00	1.493	62.9	1.006	0.03	0.422	0.634
	LTE Band 41	20M	QPSK	1	0	Back	5	Reduced	40640	2595	21.41	23.00	1.442	62.9	1.006	0.09	0.830	1.204
	LTE Band 41	20M	QPSK	1	0	Back	5	Reduced	40140	2545	21.23	23.00	1.503	62.9	1.006	0.08	0.646	0.977
	LTE Band 41	20M	QPSK	1	0	Back	5	Reduced	40390	2570	21.02	23.00	1.578	62.9	1.006	0.07	0.755	1.198
	LTE Band 41	20M	QPSK	1	0	Back	5	Reduced	40890	2620	21.40	23.00	1.445	62.9	1.006	0.16	0.870	1.265
	LTE Band 41	20M	QPSK	1	0	Back	5	Reduced	41140	2645	21.33	23.00	1.469	62.9	1.006	-0.02	0.896	1.324
	LTE Band 41	20M	QPSK	50	0	Back	5	Reduced	40640	2595	21.39	23.00	1.449	62.9	1.006	0.12	0.560	0.816
	LTE Band 41	20M	QPSK	50	0	Back	5	Reduced	40140	2545	21.13	23.00	1.538	62.9	1.006	-0.02	0.497	0.769
	LTE Band 41	20M	QPSK	50	0	Back	5	Reduced	40390	2570	21.14	23.00	1.535	62.9	1.006	-0.13	0.560	0.865
	LTE Band 41	20M	QPSK	50	0	Back	5	Reduced	40890	2620	21.38	23.00	1.452	62.9	1.006	-0.15	0.639	0.933
	LTE Band 41	20M	QPSK	50	0	Back	5	Reduced	41140	2645	21.19	23.00	1.517	62.9	1.006	0.19	0.666	1.016
	LTE Band 41	20M	QPSK	100	0	Back	5	Reduced	40640	2595	21.26	23.00	1.493	62.9	1.006	-0.11	0.610	0.916
	LTE Band 41	20M	QPSK	1	0	Left side	5	Reduced	40640	2595	21.41	22.50	1.285	62.9	1.006	-0.12	0.534	0.690
	LTE Band 41	20M	QPSK	1	0	Left side	5	Reduced	40140	2545	21.23	22.50	1.340	62.9	1.006	0.13	0.509	0.686
	LTE Band 41	20M	QPSK	1	0	Left side	5	Reduced	40390	2570	21.02	22.50	1.406	62.9	1.006	0.05	0.497	0.703
	LTE Band 41	20M	QPSK	1	0	Left side	5	Reduced	40890	2620	21.40	22.50	1.288	62.9	1.006	0.09	0.439	0.569
	LTE Band 41	20M	QPSK	1	0	Left side	5	Reduced	41140	2645	21.33	22.50	1.309	62.9	1.006	0.09	0.352	0.464
	LTE Band 41	20M	QPSK	50	0	Left side	5	Reduced	40640	2595	21.39	22.50	1.291	62.9	1.006	-0.09	0.366	0.475
	LTE Band 41	20M	QPSK	100	0	Left side	5	Reduced	40640	2595	21.26	22.50	1.330	62.9	1.006	0.04	0.354	0.474
	LTE Band 41	20M	QPSK	1	0	Bottom Side	5	Reduced	40640	2595	21.41	22.50	1.285	62.9	1.006	0.04	0.744	0.962
	LTE Band 41	20M	QPSK	1	0	Bottom Side	5	Reduced	40140	2545	21.23	22.50	1.340	62.9	1.006	0.09	0.847	1.142
27	LTE Band 41	20M	QPSK	1	0	Bottom Side	5	Reduced	40390	2570	21.02	22.50	1.406	62.9	1.006	0.02	0.981	1.388
	LTE Band 41	20M	QPSK	1	0	Bottom Side	5	Reduced	40890	2620	21.40	22.50	1.288	62.9	1.006	0.14	1.060	1.374
	LTE Band 41	20M	QPSK	1	0	Bottom Side	5	Reduced	41140	2645	21.33	22.50	1.309	62.9	1.006	0.05	0.994	1.309
	LTE Band 41	20M	QPSK	50	0	Bottom Side	5	Reduced	40640	2595	21.39	22.50	1.291	62.9	1.006	0.04	0.581	0.755
	LTE Band 41	20M	QPSK	50	0	Bottom Side	5	Reduced	40140	2545	21.13	22.50	1.371	62.9	1.006	0.09	0.525	0.724
	LTE Band 41	20M	QPSK	50	0	Bottom Side	5	Reduced	40390	2570	21.14	22.50	1.368	62.9	1.006	0.06	0.568	0.782
	LTE Band 41	20M	QPSK	50	0	Bottom Side	5	Reduced	40890	2620	21.38	22.50	1.294	62.9	1.006	0.07	0.579	0.754
	LTE Band 41	20M	QPSK	50	0	Bottom Side	5	Reduced	41140	2645	21.19	22.50	1.352	62.9	1.006	0.03	0.580	0.789
	LTE Band 41	20M	QPSK	100	0	Bottom Side	5	Reduced	40640	2595	21.26	22.50	1.330	62.9	1.006	0.02	0.590	0.790



<WLAN 2.4GHz SAR>

Plot No.	Band	Mode	Test Position	Gap (mm)	Power Reduction	Ch.	Freq. (MHz)	Average Power (dBm)	Tune-Up Limit (dBm)	Tune-up Scaling Factor	Duty Cycle %	Duty Cycle Scaling Factor	Power Drift (dB)	Measured 1g SAR (W/kg)	Reported 1g SAR (W/kg)
	WLAN2.4GHz	802.11b 1Mbps	Front	5	Reduced	1	2412	19.98	21.00	1.265	100	1.000	0	0.893	1.129
28	WLAN2.4GHz	802.11b 1Mbps	Front	5	Reduced	11	2462	19.87	21.00	1.297	100	1.000	0.03	0.904	1.173
	WLAN2.4GHz	802.11b 1Mbps	Back	5	Reduced	1	2412	19.98	21.00	1.265	100	1.000	0.03	0.866	1.095
	WLAN2.4GHz	802.11b 1Mbps	Back	5	Reduced	11	2462	19.87	21.00	1.297	100	1.000	0.01	0.872	1.131
	WLAN2.4GHz	802.11b 1Mbps	Left Side	5	Reduced	1	2412	19.98	21.00	1.265	100	1.000	0.01	0.085	0.107
	WLAN2.4GHz	802.11b 1Mbps	Right Side	5	Reduced	1	2412	19.98	21.00	1.265	100	1.000	0.03	0.834	1.055
	WLAN2.4GHz	802.11b 1Mbps	Right Side	5	Reduced	11	2462	19.87	21.00	1.297	100	1.000	0.06	0.815	1.057
	WLAN2.4GHz	802.11b 1Mbps	Top Side	5	Reduced	1	2412	19.98	21.00	1.265	100	1.000	0.03	0.815	1.031
	WLAN2.4GHz	802.11b 1Mbps	Top Side	5	Reduced	11	2462	19.87	21.00	1.297	100	1.000	0.01	0.742	0.963

<WLAN 5GHz SAR>

Plot No.	Band	Mode	Test Position	Gap (mm)	Power Reduction	Ch.	Freq. (MHz)	Average Power (dBm)	Tune-Up Limit (dBm)	Tune-up Scaling Factor	Duty Cycle %	Duty Cycle Scaling Factor	Power Drift (dB)	Measured 1g SAR (W/kg)	Reported 1g SAR (W/kg)
	WLAN5.2GHz	802.11n-HT40 MCS0	Front	5	Reduced	38	5190	14.71	15.00	1.069	96.3	1.038	0.02	0.311	0.345
29	WLAN5.2GHz	802.11n-HT40 MCS0	Back	5	Reduced	38	5190	14.71	15.00	1.069	96.3	1.038	-0.01	1.060	1.176
	WLAN5.2GHz	802.11n-HT40 MCS0	Back	5	Reduced	46	5230	14.67	15.00	1.079	96.3	1.038	-0.09	1.000	1.120
	WLAN5.2GHz	802.11n-HT40 MCS0	Left Side	5	Reduced	38	5190	14.71	15.00	1.069	96.3	1.038	-0.05	0.107	0.119
	WLAN5.2GHz	802.11n-HT40 MCS0	Right Side	5	Reduced	38	5190	14.71	15.00	1.069	96.3	1.038	-0.02	0.322	0.357
	WLAN5.2GHz	802.11n-HT40 MCS0	Top Side	5	Reduced	38	5190	14.71	15.00	1.069	96.3	1.038	0.02	0.669	0.742
	WLAN5.8GHz	802.11a 6Mbps	Front	5	Reduced	165	5825	14.43	14.50	1.016	98.26	1.018	0.03	0.199	0.206
30	WLAN5.8GHz	802.11a 6Mbps	Back	5	Reduced	165	5825	14.43	14.50	1.016	98.26	1.018	0.01	1.070	1.107
	WLAN5.8GHz	802.11a 6Mbps	Back	5	Reduced	149	5745	14.39	14.50	1.026	98.26	1.018	0.03	0.958	1.000
	WLAN5.8GHz	802.11a 6Mbps	Right Side	5	Reduced	165	5825	14.43	14.50	1.016	98.26	1.018	0.03	0.046	0.048
	WLAN5.8GHz	802.11a 6Mbps	Top Side	5	Reduced	165	5825	14.43	14.50	1.016	98.26	1.018	0.03	0.234	0.242

<Bluetooth SAR>

Plot No.	Band	Mode	Test Position	Gap (mm)	Power Reduction	Ch.	Freq. (MHz)	Average Power (dBm)	Tune-Up Limit (dBm)	Tune-up Scaling Factor	Duty Cycle %	Duty Cycle Scaling Factor	Power Drift (dB)	Measured 1g SAR (W/kg)	Reported 1g SAR (W/kg)
	Bluetooth	1Mbps	Front	5	Full	00	2402	7.67	9.00	1.357	77.39	1.076	0.01	0.036	0.053
31	Bluetooth	1Mbps	Back	5	Full	00	2402	7.67	9.00	1.357	77.39	1.076	0.01	0.036	0.053



14.3 Body Worn Accessory SAR

<GSM SAR>

Plot No.	Band	Mode	Test Position	Gap (mm)	Headset	Power Reduction	Ch.	Freq. (MHz)	Average Power (dBm)	Tune-Up Limit (dBm)	Tune-up Scaling Factor	Power Drift (dB)	Measured 1g SAR (W/kg)	Reported 1g SAR (W/kg)
	GSM850	GPRS 3 Tx slots	Front	5	-	Reduced	128	824.2	29.11	30.50	1.377	0.08	0.369	0.508
	GSM850	GPRS 3 Tx slots	Back	5	-	Reduced	128	824.2	29.11	30.50	1.377	0.02	0.601	0.828
	GSM850	GPRS 3 Tx slots	Back	5	-	Reduced	189	836.4	29.05	30.50	1.396	0.03	0.875	1.222
	GSM850	GPRS 3 Tx slots	Back	5	-	Reduced	251	848.8	28.86	30.50	1.459	0.07	0.880	1.284
32	GSM850	GPRS 3 Tx slots	Back	5	Headset	Reduced	251	848.8	28.86	30.50	1.459	-0.07	0.931	1.358
	GSM850	GPRS 3 Tx slots	Back	5	Headset	Reduced	128	824.2	29.11	30.50	1.377	-0.15	0.513	0.707
	GSM850	GPRS 3 Tx slots	Back	5	Headset	Reduced	189	836.4	29.05	30.50	1.396	0.07	0.952	1.329
	GSM850	GPRS 3 Tx slots	Front	12	-	Full	128	824.2	30.51	31.50	1.256	-0.01	0.272	0.342
	GSM850	GPRS 3 Tx slots	Back	18	-	Full	251	848.8	30.26	31.50	1.330	0.06	0.340	0.452
	GSM1900	GPRS 3 Tx slots	Front	5	-	Reduced	810	1909.8	23.15	24.00	1.216	-0.12	0.654	0.795
33	GSM1900	GPRS 3 Tx slots	Back	5	-	Reduced	810	1909.8	23.15	24.00	1.216	0.06	1.080	1.313
	GSM1900	GPRS 3 Tx slots	Back	5	-	Reduced	512	1850.2	22.74	24.00	1.337	0.13	0.862	1.152
	GSM1900	GPRS 3 Tx slots	Back	5	-	Reduced	661	1880	22.93	24.00	1.279	0.05	0.915	1.171
	GSM1900	GPRS 3 Tx slots	Back	5	Headset	Reduced	810	1909.8	23.15	24.00	1.216	0.01	0.989	1.203
	GSM1900	GPRS 3 Tx slots	Front	12	-	Full	810	1909.8	27.65	28.50	1.216	0.09	0.485	0.590
	GSM1900	GPRS 3 Tx slots	Back	18	-	Full	810	1909.8	27.65	28.50	1.216	-0.02	0.523	0.636

<WCDMA SAR>

Plot No.	Band	Mode	Test Position	Gap (mm)	Headset	Power Reduction	Ch.	Freq. (MHz)	Average Power (dBm)	Tune-Up Limit (dBm)	Tune-up Scaling Factor	Power Drift (dB)	Measured 1g SAR (W/kg)	Reported 1g SAR (W/kg)
	WCDMA II	RMC 12.2Kbps	Front	5	-	Reduced	9538	1907.6	16.55	17.00	1.109	0.09	0.782	0.867
	WCDMA II	RMC 12.2Kbps	Front	5	-	Reduced	9262	1852.4	16.48	17.00	1.127	0.04	0.641	0.723
	WCDMA II	RMC 12.2Kbps	Front	5	-	Reduced	9400	1880	16.41	17.00	1.146	-0.05	0.697	0.798
34	WCDMA II	RMC 12.2Kbps	Back	5	-	Reduced	9538	1907.6	16.55	17.00	1.109	0.09	1.250	1.386
	WCDMA II	RMC 12.2Kbps	Back	5	-	Reduced	9262	1852.4	16.48	17.00	1.127	-0.01	0.991	1.117
	WCDMA II	RMC 12.2Kbps	Back	5	-	Reduced	9400	1880	16.41	17.00	1.146	0.08	1.090	1.249
	WCDMA II	RMC 12.2Kbps	Back	5	Headset	Reduced	9538	1907.6	16.55	17.00	1.109	0.13	1.160	1.287
	WCDMA II	RMC 12.2Kbps	Front	12	-	Full	9538	1907.6	23.90	24.00	1.023	-0.18	0.987	1.010
	WCDMA II	RMC 12.2Kbps	Back	18	-	Full	9538	1907.6	23.90	24.00	1.023	-0.13	0.883	0.904
	WCDMA IV	RMC 12.2Kbps	Front	5	-	Reduced	1513	1752.6	17.28	18.00	1.180	-0.01	0.789	0.931
	WCDMA IV	RMC 12.2Kbps	Front	5	-	Reduced	1312	1712.4	17.05	18.00	1.245	0.03	0.588	0.732
	WCDMA IV	RMC 12.2Kbps	Front	5	-	Reduced	1413	1732.6	17.11	18.00	1.227	-0.07	0.678	0.832
35	WCDMA IV	RMC 12.2Kbps	Back	5	-	Reduced	1513	1752.6	17.28	18.00	1.180	0	1.170	1.381
	WCDMA IV	RMC 12.2Kbps	Back	5	-	Reduced	1312	1712.4	17.05	18.00	1.245	0.03	0.956	1.190
	WCDMA IV	RMC 12.2Kbps	Back	5	-	Reduced	1413	1732.6	17.11	18.00	1.227	0.03	1.100	1.350
	WCDMA IV	RMC 12.2Kbps	Back	5	Headset	Reduced	1513	1752.6	17.28	18.00	1.180	-0.05	1.120	1.322
	WCDMA IV	RMC 12.2Kbps	Front	12	-	Full	1513	1752.6	23.74	24.00	1.062	0.13	0.940	0.998
	WCDMA IV	RMC 12.2Kbps	Back	18	-	Full	1513	1752.6	23.74	24.00	1.062	0.18	0.772	0.820
	WCDMA V	RMC 12.2Kbps	Front	5	-	Full	4132	826.4	23.96	24.00	1.009	-0.16	0.788	0.795
	WCDMA V	RMC 12.2Kbps	Back	5	-	Full	4132	826.4	23.96	24.00	1.009	-0.01	1.230	1.241
	WCDMA V	RMC 12.2Kbps	Back	5	-	Full	4182	836.4	23.86	24.00	1.033	0.04	1.250	1.291
36	WCDMA V	RMC 12.2Kbps	Back	5	-	Full	4233	846.6	23.63	24.00	1.089	0.02	1.190	1.296
	WCDMA V	RMC 12.2Kbps	Back	5	Headset	Full	4233	846.6	23.63	24.00	1.089	0.06	0.801	0.872



<FDD LTE SAR>

Plot No.	Band	BW (MHz)	Modulation	RB Size	RB offset	Test Position	Gap (mm)	Headset	Power Reduction	Ch.	Freq. (MHz)	Average Power (dBm)	Tune-Up Limit (dBm)	Tune-up Scaling Factor	Power Drift (dB)	Measured 1g SAR (W/kg)	Reported 1g SAR (W/kg)
	LTE Band 2	20M	QPSK	1	0	Front	5	-	Reduced	18900	1880	16.43	17.00	1.140	0.18	0.776	0.885
	LTE Band 2	20M	QPSK	1	0	Front	5	-	Reduced	18700	1860	16.19	17.00	1.205	0.07	0.674	0.812
	LTE Band 2	20M	QPSK	1	0	Front	5	-	Reduced	19100	1900	16.14	17.00	1.219	0.01	0.814	0.992
	LTE Band 2	20M	QPSK	50	0	Front	5	-	Reduced	18900	1880	16.11	17.00	1.227	0.05	0.765	0.939
	LTE Band 2	20M	QPSK	50	0	Front	5	-	Reduced	18700	1860	15.91	17.00	1.285	0.12	0.793	1.019
	LTE Band 2	20M	QPSK	50	0	Front	5	-	Reduced	19100	1900	16.10	17.00	1.230	0.02	0.821	1.010
	LTE Band 2	20M	QPSK	100	0	Front	5	-	Reduced	18900	1880	16.13	17.00	1.222	0.19	0.784	0.958
	LTE Band 2	20M	QPSK	1	0	Back	5	-	Reduced	18900	1880	16.43	17.00	1.140	-0.03	0.921	1.050
	LTE Band 2	20M	QPSK	1	0	Back	5	-	Reduced	18700	1860	16.19	17.00	1.205	0.05	0.772	0.930
	LTE Band 2	20M	QPSK	1	0	Back	5	-	Reduced	19100	1900	16.14	17.00	1.219	-0.16	0.810	0.987
	LTE Band 2	20M	QPSK	50	0	Back	5	-	Reduced	18900	1880	16.11	17.00	1.227	-0.19	0.753	0.924
37	LTE Band 2	20M	QPSK	50	0	Back	5	-	Reduced	18700	1860	15.91	17.00	1.285	0.04	0.945	1.215
	LTE Band 2	20M	QPSK	50	0	Back	5	-	Reduced	19100	1900	16.10	17.00	1.230	0.15	0.876	1.078
	LTE Band 2	20M	QPSK	100	0	Back	5	-	Reduced	18900	1880	16.13	17.00	1.222	-0.02	0.763	0.932
	LTE Band 2	20M	QPSK	50	0	Back	5	Headset	Reduced	18700	1860	15.91	17.00	1.285	-0.03	0.846	1.087
	LTE Band 2	20M	QPSK	1	0	Front	12	-	Full	18700	1860	22.77	24.00	1.327	0.04	0.518	0.688
	LTE Band 2	20M	QPSK	1	0	Back	18	-	Full	18700	1860	22.77	24.00	1.327	-0.07	0.319	0.423
	LTE Band 26	15M	QPSK	1	0	Front	5	-	Full	26865	831.5	22.95	24.00	1.274	0.01	0.877	1.117
	LTE Band 26	15M	QPSK	36	0	Front	5	-	Full	26865	831.5	22.09	23.00	1.233	0.13	0.486	0.599
	LTE Band 26	15M	QPSK	75	0	Front	5	-	Full	26865	831.5	22.05	23.00	1.245	0.09	0.476	0.592
38	LTE Band 26	15M	QPSK	1	0	Back	5	-	Full	26865	831.5	22.95	24.00	1.274	-0.02	0.895	1.140
	LTE Band 26	15M	QPSK	36	0	Back	5	-	Full	26865	831.5	22.09	23.00	1.233	0.07	0.638	0.787
	LTE Band 26	15M	QPSK	75	0	Back	5	-	Full	26865	831.5	22.05	23.00	1.245	-0.01	0.447	0.556
	LTE Band 12	10M	QPSK	1	0	Front	5	-	Full	23095	707.5	22.88	24.00	1.294	0.01	0.435	0.563
	LTE Band 12	10M	QPSK	25	0	Front	5	-	Full	23095	707.5	21.86	23.00	1.300	0.03	0.245	0.319
39	LTE Band 12	10M	QPSK	1	0	Back	5	-	Full	23095	707.5	22.88	24.00	1.294	-0.02	0.775	1.003
	LTE Band 12	10M	QPSK	25	0	Back	5	-	Full	23095	707.5	21.86	23.00	1.300	0.01	0.464	0.603
	LTE Band 12	10M	QPSK	50	0	Back	5	-	Full	23095	707.5	21.80	23.00	1.318	0.04	0.473	0.624
	LTE Band 66	20M	QPSK	1	0	Front	5	-	Reduced	132322	1745	18.79	19.00	1.050	0.1	0.673	0.706
	LTE Band 66	20M	QPSK	50	0	Front	5	-	Reduced	132322	1745	18.50	19.00	1.122	0.07	0.408	0.458
	LTE Band 66	20M	QPSK	1	0	Back	5	-	Reduced	132322	1745	18.79	19.00	1.050	0.16	1.100	1.154
	LTE Band 66	20M	QPSK	1	0	Back	5	-	Reduced	132072	1720	18.48	19.00	1.127	0.15	0.924	1.042
	LTE Band 66	20M	QPSK	1	0	Back	5	-	Reduced	132572	1770	18.38	19.00	1.153	0.03	1.190	1.373
	LTE Band 66	20M	QPSK	50	0	Back	5	-	Reduced	132322	1745	18.50	19.00	1.122	0.05	1.130	1.268
	LTE Band 66	20M	QPSK	50	0	Back	5	-	Reduced	132072	1720	18.38	19.00	1.153	0.01	0.937	1.081
	LTE Band 66	20M	QPSK	50	0	Back	5	-	Reduced	132572	1770	18.48	19.00	1.127	-0.03	1.220	1.375
40	LTE Band 66	20M	QPSK	100	0	Back	5	-	Reduced	132322	1745	18.32	19.00	1.169	0.09	1.180	1.380
	LTE Band 66	20M	QPSK	100	0	Back	5	Headset	Reduced	132322	1745	18.32	19.00	1.169	0.19	1.080	1.263
	LTE Band 66	20M	QPSK	1	0	Front	12	-	Full	132322	1745	23.06	24.00	1.242	0.04	0.655	0.813
	LTE Band 66	20M	QPSK	1	0	Back	18	-	Full	132322	1745	23.06	24.00	1.242	0.03	0.411	0.510
	LTE Band 7	20M	QPSK	1	0	Front	5	-	Reduced	21100	2535	19.91	21.00	1.285	0.08	0.450	0.578
	LTE Band 7	20M	QPSK	50	0	Front	5	-	Reduced	21100	2535	19.70	21.00	1.349	0.08	0.458	0.618
	LTE Band 7	20M	QPSK	1	0	Back	5	-	Reduced	21100	2535	19.91	21.00	1.285	-0.11	0.603	0.775
	LTE Band 7	20M	QPSK	50	0	Back	5	-	Reduced	21100	2535	19.70	21.00	1.349	-0.16	0.782	1.055
	LTE Band 7	20M	QPSK	50	0	Back	5	-	Reduced	20850	2510	19.68	21.00	1.355	0.16	0.725	0.983
	LTE Band 7	20M	QPSK	50	0	Back	5	-	Reduced	21350	2560	19.56	21.00	1.393	0.04	0.929	1.294
	LTE Band 7	20M	QPSK	100	0	Back	5	-	Reduced	21100	2535	19.54	21.00	1.400	0.06	0.892	1.248
41	LTE Band 7	20M	QPSK	50	0	Back	5	Headset	Reduced	21350	2560	19.56	21.00	1.393	0.06	0.972	1.354
	LTE Band 7	20M	QPSK	50	0	Back	5	Headset	Reduced	21100	2535	19.70	21.00	1.349	0.03	0.901	1.215
	LTE Band 7	20M	QPSK	50	0	Back	5	Headset	Reduced	20850	2510	19.68	21.00	1.355	-0.03	0.861	1.167
	LTE Band 7	20M	QPSK	1	0	Front	12	-	Full	21100	2535	22.44	24.00	1.432	-0.03	0.328	0.470
	LTE Band 7	20M	QPSK	1	0	Back	18	-	Full	21350	2560	22.36	24.00	1.459	0.04	0.222	0.324



<TDD LTE SAR>

Plot No.	Band	BW (MHz)	Modulation	RB Size	RB offset	Test Position	Gap (mm)	Headset	Power Reduction	Ch.	Freq. (MHz)	Average Power (dBm)	Tune-Up Limit (dBm)	Tune-up Scaling Factor	Duty Cycle %	Duty Cycle Scaling Factor	Power Drift (dB)	Measured 1g SAR (W/kg)	Reported 1g SAR (W/kg)
	LTE Band 41	20M	QPSK	1	0	Front	5	-	Reduced	40640	2595	21.41	23.00	1.442	62.9	1.006	-0.04	0.555	0.805
	LTE Band 41	20M	QPSK	1	0	Front	5	-	Reduced	40140	2545	21.23	23.00	1.503	62.9	1.006	0.09	0.354	0.535
	LTE Band 41	20M	QPSK	1	0	Front	5	-	Reduced	40390	2570	21.02	23.00	1.578	62.9	1.006	0.16	0.553	0.878
	LTE Band 41	20M	QPSK	1	0	Front	5	-	Reduced	40890	2620	21.40	23.00	1.445	62.9	1.006	0.13	0.559	0.813
	LTE Band 41	20M	QPSK	1	0	Front	5	-	Reduced	41140	2645	21.33	23.00	1.469	62.9	1.006	0.19	0.550	0.813
	LTE Band 41	20M	QPSK	50	0	Front	5	-	Reduced	40640	2595	21.39	23.00	1.449	62.9	1.006	0.05	0.426	0.621
	LTE Band 41	20M	QPSK	50	0	Front	5	-	Reduced	40140	2545	21.13	23.00	1.538	62.9	1.006	0.09	0.451	0.698
	LTE Band 41	20M	QPSK	50	0	Front	5	-	Reduced	40390	2570	21.14	23.00	1.535	62.9	1.006	-0.09	0.454	0.701
	LTE Band 41	20M	QPSK	50	0	Front	5	-	Reduced	40890	2620	21.38	23.00	1.452	62.9	1.006	0.01	0.426	0.622
	LTE Band 41	20M	QPSK	50	0	Front	5	-	Reduced	41140	2645	21.19	23.00	1.517	62.9	1.006	0.03	0.435	0.664
	LTE Band 41	20M	QPSK	100	0	Front	5	-	Reduced	40640	2595	21.26	23.00	1.493	62.9	1.006	0.03	0.422	0.634
	LTE Band 41	20M	QPSK	1	0	Back	5	-	Reduced	40640	2595	21.41	23.00	1.442	62.9	1.006	0.09	0.830	1.204
	LTE Band 41	20M	QPSK	1	0	Back	5	-	Reduced	40140	2545	21.23	23.00	1.503	62.9	1.006	0.08	0.646	0.977
	LTE Band 41	20M	QPSK	1	0	Back	5	-	Reduced	40390	2570	21.02	23.00	1.578	62.9	1.006	0.07	0.755	1.198
	LTE Band 41	20M	QPSK	1	0	Back	5	-	Reduced	40890	2620	21.40	23.00	1.445	62.9	1.006	0.16	0.870	1.265
42	LTE Band 41	20M	QPSK	1	0	Back	5	-	Reduced	41140	2645	21.33	23.00	1.469	62.9	1.006	-0.02	0.896	1.324
	LTE Band 41	20M	QPSK	50	0	Back	5	-	Reduced	40640	2595	21.39	23.00	1.449	62.9	1.006	0.12	0.560	0.816
	LTE Band 41	20M	QPSK	50	0	Back	5	-	Reduced	40140	2545	21.13	23.00	1.538	62.9	1.006	-0.02	0.497	0.769
	LTE Band 41	20M	QPSK	50	0	Back	5	-	Reduced	40390	2570	21.14	23.00	1.535	62.9	1.006	-0.13	0.560	0.865
	LTE Band 41	20M	QPSK	50	0	Back	5	-	Reduced	40890	2620	21.38	23.00	1.452	62.9	1.006	-0.15	0.639	0.933
	LTE Band 41	20M	QPSK	50	0	Back	5	-	Reduced	41140	2645	21.19	23.00	1.517	62.9	1.006	0.19	0.666	1.016
	LTE Band 41	20M	QPSK	100	0	Back	5	-	Reduced	40640	2595	21.26	23.00	1.493	62.9	1.006	-0.11	0.610	0.916
	LTE Band 41	20M	QPSK	1	0	Back	5	Headset	Reduced	41140	2645	21.33	23.00	1.469	62.9	1.006	0.06	0.826	1.221
	LTE Band 41	20M	QPSK	1	0	Front	12	-	Full	40390	2570	22.63	24.00	1.371	62.9	1.006	-0.09	0.165	0.228
	LTE Band 41	20M	QPSK	1	0	Back	18	-	Full	41140	2645	22.55	24.00	1.396	62.9	1.006	0.02	0.100	0.140



<WLAN 2.4GHz SAR>

Plot No.	Band	Mode	Test Position	Gap (mm)	Power Reduction	Ch.	Freq. (MHz)	Average Power (dBm)	Tune-Up Limit (dBm)	Tune-up Scaling Factor	Duty Cycle %	Duty Cycle Scaling Factor	Power Drift (dB)	Measured 1g SAR (W/kg)	Reported 1g SAR (W/kg)
	WLAN2.4GHz	802.11b 1Mbps	Front	5	Reduced	1	2412	19.98	21.00	1.265	100	1.000	0	0.893	1.129
43	WLAN2.4GHz	802.11b 1Mbps	Front	5	Reduced	11	2462	19.87	21.00	1.297	100	1.000	0.03	0.904	1.173
	WLAN2.4GHz	802.11b 1Mbps	Back	5	Reduced	1	2412	19.98	21.00	1.265	100	1.000	0.03	0.866	1.095
	WLAN2.4GHz	802.11b 1Mbps	Back	5	Reduced	11	2462	19.87	21.00	1.297	100	1.000	0.01	0.872	1.131
	WLAN2.4GHz	802.11b 1Mbps	Front	12	Full	11	2462	20.92	22.50	1.439	100	1.000	0.03	0.589	0.847
	WLAN2.4GHz	802.11b 1Mbps	Back	18	Full	11	2462	20.92	22.50	1.439	100	1.000	0.01	0.334	0.481

<WLAN 5GHz SAR>

Plot No.	Band	Mode	Test Position	Gap (mm)	Power Reduction	Ch.	Freq. (MHz)	Average Power (dBm)	Tune-Up Limit (dBm)	Tune-up Scaling Factor	Duty Cycle %	Duty Cycle Scaling Factor	Power Drift (dB)	Measured 1g SAR (W/kg)	Reported 1g SAR (W/kg)
	WLAN5.2GHz	802.11n-HT40 MCS0	Front	5	Reduced	38	5190	14.71	15.00	1.069	96.3	1.038	0.02	0.311	0.345
44	WLAN5.2GHz	802.11n-HT40 MCS0	Back	5	Reduced	38	5190	14.71	15.00	1.069	96.3	1.038	-0.09	1.060	1.176
	WLAN5.2GHz	802.11n-HT40 MCS0	Back	5	Reduced	46	5230	14.67	15.00	1.079	96.3	1.038	-0.09	1.000	1.120
	WLAN5.2GHz	802.11n-HT40 MCS0	Front	12	Full	38	5190	17.31	19.00	1.476	96.3	1.038	0.02	0.307	0.470
	WLAN5.2GHz	802.11n-HT40 MCS0	Back	18	Full	38	5190	17.31	19.00	1.476	96.3	1.038	-0.09	0.471	0.721
	WLAN5.3GHz	802.11n-HT40 MCS0	Front	5	Reduced	62	5310	13.68	14.50	1.208	96.3	1.038	0.02	0.348	0.436
45	WLAN5.3GHz	802.11n-HT40 MCS0	Back	5	Reduced	62	5310	13.68	14.50	1.208	96.3	1.038	0.01	0.929	1.165
	WLAN5.3GHz	802.11n-HT40 MCS0	Back	5	Reduced	54	5270	13.66	14.50	1.213	96.3	1.038	-0.08	0.928	1.169
	WLAN5.3GHz	802.11n-HT40 MCS0	Front	12	Full	62	5310	17.98	19.00	1.265	96.3	1.038	0.03	0.450	0.591
	WLAN5.3GHz	802.11n-HT40 MCS0	Back	18	Full	62	5310	17.98	19.00	1.265	96.3	1.038	0.01	0.566	0.743
	WLAN5.5GHz	802.11n-HT40 MCS0	Front	5	Reduced	134	5670	14.57	15.00	1.104	96.3	1.038	0.03	0.210	0.241
46	WLAN5.5GHz	802.11n-HT40 MCS0	Back	5	Reduced	134	5670	14.57	15.00	1.104	96.3	1.038	-0.04	0.979	1.122
	WLAN5.5GHz	802.11n-HT40 MCS0	Back	5	Reduced	110	5550	14.27	15.00	1.183	96.3	1.038	-0.08	0.880	1.081
	WLAN5.5GHz	802.11n-HT40 MCS0	Front	12	Full	134	5670	18.46	19.00	1.132	96.3	1.038	0	0.257	0.302
	WLAN5.5GHz	802.11n-HT40 MCS0	Back	18	Full	134	5670	18.46	19.00	1.132	96.3	1.038	0.01	0.846	0.994
	WLAN5.8GHz	802.11a 6Mbps	Front	5	Reduced	165	5825	14.43	14.50	1.016	98.26	1.018	0.03	0.199	0.206
47	WLAN5.8GHz	802.11a 6Mbps	Back	5	Reduced	165	5825	14.43	14.50	1.016	98.26	1.018	0.01	1.070	1.107
	WLAN5.8GHz	802.11a 6Mbps	Back	5	Reduced	149	5745	14.39	14.50	1.026	98.26	1.018	0.03	0.958	1.000
	WLAN5.8GHz	802.11a 6Mbps	Front	12	Full	165	5825	18.25	19.00	1.189	98.26	1.018	0.03	0.296	0.358
	WLAN5.8GHz	802.11a 6Mbps	Back	18	Full	165	5825	18.25	19.00	1.189	98.26	1.018	0.03	0.835	1.010

<Bluetooth SAR>

Plot No.	Band	Mode	Test Position	Gap (mm)	Power Reduction	Ch.	Freq. (MHz)	Average Power (dBm)	Tune-Up Limit (dBm)	Tune-up Scaling Factor	Duty Cycle %	Duty Cycle Scaling Factor	Power Drift (dB)	Measured 1g SAR (W/kg)	Reported 1g SAR (W/kg)
	Bluetooth	1Mbps	Front	5	Full	0	2402	7.67	9.00	1.357	77.39	1.076	0.06	0.036	0.053
48	Bluetooth	1Mbps	Back	5	Full	0	2402	7.67	9.00	1.357	77.39	1.076	0.01	0.036	0.053

14.4 Product specific 10g SAR

<GSM SAR>

Plot No.	Band	Mode	Test Position	Gap (mm)	Power Reduction	Ch.	Freq. (MHz)	Average Power (dBm)	Tune-Up Limit (dBm)	Tune-up Scaling Factor	Power Drift (dB)	Measured 10g SAR (W/kg)	Reported 10g SAR (W/kg)
	GSM850	GPRS 3 Tx slots	Bottom Side	0	Full	128	824.2	30.51	31.50	1.256	0.03	0.580	0.728
49	GSM850	GPRS 3 Tx slots	Back	0	Full	128	824.2	30.51	31.50	1.256	0.17	0.608	0.764
	GSM1900	GPRS 3 Tx slots	Front	0	Reduced	810	1909.8	25.20	25.50	1.072	-0.16	2.320	2.486
	GSM1900	GPRS 3 Tx slots	Front	0	Reduced	512	1850.2	25.07	25.50	1.104	0.07	1.900	2.098
	GSM1900	GPRS 3 Tx slots	Front	0	Reduced	661	1880	25.05	25.50	1.109	0.19	2.220	2.462
	GSM1900	GPRS 3 Tx slots	Back	0	Reduced	810	1909.8	25.20	25.50	1.072	0.17	2.320	2.486
	GSM1900	GPRS 3 Tx slots	Back	0	Reduced	512	1850.2	25.07	25.50	1.104	-0.06	2.370	2.617
50	GSM1900	GPRS 3 Tx slots	Back	0	Reduced	661	1880	25.05	25.50	1.109	0.07	2.700	2.995
	GSM1900	GPRS 3 Tx slots	Bottom Side	0	Reduced	810	1909.8	25.20	25.50	1.072	0.01	2.130	2.282
	GSM1900	GPRS 3 Tx slots	Bottom Side	0	Reduced	512	1850.2	25.07	25.50	1.104	0.02	2.340	2.584
	GSM1900	GPRS 3 Tx slots	Bottom Side	0	Reduced	661	1880	25.05	25.50	1.109	0.06	2.350	2.607
	GSM1900	GPRS 3 Tx slots	Front	6	Full	810	1909.8	27.65	28.50	1.216	0.04	0.632	0.769
	GSM1900	GPRS 3 Tx slots	Back	11	Full	810	1909.8	27.65	28.50	1.216	-0.06	0.709	0.862
	GSM1900	GPRS 3 Tx slots	Bottom Side	11	Full	810	1909.8	27.65	28.50	1.216	0.01	0.761	0.926

<WCDMA SAR>

Plot No.	Band	Mode	Test Position	Gap (mm)	Power Reduction	Ch.	Freq. (MHz)	Average Power (dBm)	Tune-Up Limit (dBm)	Tune-up Scaling Factor	Power Drift (dB)	Measured 10g SAR (W/kg)	Reported 10g SAR (W/kg)
	WCDMA II	RMC 12.2Kbps	Front	0	Reduced	9538	1907.6	20.48	20.50	1.005	0.07	2.560	2.572
	WCDMA II	RMC 12.2Kbps	Front	0	Reduced	9262	1852.4	20.47	20.50	1.007	0.08	2.220	2.235
	WCDMA II	RMC 12.2Kbps	Front	0	Reduced	9400	1880	20.32	20.50	1.042	0.06	2.320	2.418
	WCDMA II	RMC 12.2Kbps	Back	0	Reduced	9538	1907.6	20.48	20.50	1.005	0.05	2.810	2.823
	WCDMA II	RMC 12.2Kbps	Back	0	Reduced	9262	1852.4	20.47	20.50	1.007	-0.15	2.930	2.950
	WCDMA II	RMC 12.2Kbps	Back	0	Reduced	9400	1880	20.32	20.50	1.042	-0.16	2.690	2.804
	WCDMA II	RMC 12.2Kbps	Bottom Side	0	Reduced	9538	1907.6	20.48	20.50	1.005	0.04	3.050	3.064
51	WCDMA II	RMC 12.2Kbps	Bottom Side	0	Reduced	9262	1852.4	20.47	20.50	1.007	0.07	3.230	3.252
	WCDMA II	RMC 12.2Kbps	Bottom Side	0	Reduced	9400	1880	20.32	20.50	1.042	0.04	3.030	3.158
	WCDMA II	RMC 12.2Kbps	Front	6	Full	9538	1907.6	23.90	24.00	1.023	0.01	1.210	1.238
	WCDMA II	RMC 12.2Kbps	Back	11	Full	9262	1852.4	23.88	24.00	1.028	0.06	1.030	1.059
	WCDMA II	RMC 12.2Kbps	Bottom Side	11	Full	9262	1852.4	23.88	24.00	1.028	0.09	1.560	1.604
	WCDMA IV	RMC 12.2Kbps	Front	0	Reduced	1513	1752.6	20.07	20.50	1.104	0.08	1.910	2.109
	WCDMA IV	RMC 12.2Kbps	Front	0	Reduced	1312	1712.4	19.96	20.50	1.132	0.01	1.680	1.902
	WCDMA IV	RMC 12.2Kbps	Front	0	Reduced	1413	1732.6	20.03	20.50	1.114	0.05	1.820	2.028
	WCDMA IV	RMC 12.2Kbps	Back	0	Reduced	1513	1752.6	20.07	20.50	1.104	0.02	2.990	3.301
	WCDMA IV	RMC 12.2Kbps	Back	0	Reduced	1312	1712.4	19.96	20.50	1.132	0.01	2.830	3.205
	WCDMA IV	RMC 12.2Kbps	Back	0	Reduced	1413	1732.6	20.03	20.50	1.114	0.05	2.780	3.098
	WCDMA IV	RMC 12.2Kbps	Bottom Side	0	Reduced	1513	1752.6	20.07	20.50	1.104	0.08	2.940	3.246
52	WCDMA IV	RMC 12.2Kbps	Bottom Side	0	Reduced	1312	1712.4	19.96	20.50	1.132	0.08	3.090	3.499
	WCDMA IV	RMC 12.2Kbps	Bottom Side	0	Reduced	1413	1732.6	20.03	20.50	1.114	0.14	3.030	3.376
	WCDMA IV	RMC 12.2Kbps	Front	6	Full	1513	1752.6	23.74	24.00	1.062	0.03	1.230	1.306
	WCDMA IV	RMC 12.2Kbps	Back	11	Full	1513	1752.6	23.74	24.00	1.062	0.06	1.100	1.168
	WCDMA IV	RMC 12.2Kbps	Bottom Side	11	Full	1312	1712.4	23.56	24.00	1.107	0.09	1.290	1.428
	WCDMA V	RMC 12.2Kbps	Back	0	Full	4132	826.4	23.96	24.00	1.009	0.08	2.210	2.230
53	WCDMA V	RMC 12.2Kbps	Back	0	Full	4182	836.4	23.86	24.00	1.033	0.03	2.380	2.458
	WCDMA V	RMC 12.2Kbps	Back	0	Full	4233	846.6	23.63	24.00	1.089	0.03	1.770	1.927
	WCDMA V	RMC 12.2Kbps	Bottom Side	0	Full	4132	826.4	23.96	24.00	1.009	0.13	0.670	0.676



<FDD LTE SAR>

Plot No.	Band	BW (MHz)	Modulation	RB Size	RB Offset	Test Position	Gap (mm)	Power Mode	Ch.	Freq. (MHz)	Average Power (dBm)	Tune-Up Limit (dBm)	Tune-up Scaling Factor	Power Drift (dB)	Measured 10g SAR (W/kg)	Reported 10g SAR (W/kg)
	LTE Band 2	20M	QPSK	1	0	Front	0	Reduced	18900	1880	18.47	19.50	1.268	0.08	1.350	1.711
	LTE Band 2	20M	QPSK	50	0	Front	0	Reduced	18900	1880	18.17	19.50	1.358	0.03	1.360	1.847
	LTE Band 2	20M	QPSK	1	0	Back	0	Reduced	18900	1880	18.47	19.50	1.268	0.16	1.890	2.396
	LTE Band 2	20M	QPSK	1	0	Back	0	Reduced	18700	1860	18.24	19.50	1.337	-0.14	1.980	2.646
	LTE Band 2	20M	QPSK	1	0	Back	0	Reduced	19100	1900	18.36	19.50	1.300	0.08	1.760	2.288
	LTE Band 2	20M	QPSK	50	0	Back	0	Reduced	18900	1880	18.17	19.50	1.358	0.04	1.840	2.499
	LTE Band 2	20M	QPSK	50	0	Back	0	Reduced	18700	1860	18.03	19.50	1.403	-0.17	1.900	2.665
	LTE Band 2	20M	QPSK	50	0	Back	0	Reduced	19100	1900	18.16	19.50	1.361	-0.07	1.620	2.206
	LTE Band 2	20M	QPSK	100	0	Back	0	Reduced	18900	1880	18.12	19.50	1.374	0.04	1.800	2.473
	LTE Band 2	20M	QPSK	1	0	Bottom Side	0	Reduced	18900	1880	18.47	19.50	1.268	0.03	2.340	2.966
	LTE Band 2	20M	QPSK	1	0	Bottom Side	0	Reduced	18700	1860	18.24	19.50	1.337	0.09	2.350	3.141
	LTE Band 2	20M	QPSK	1	0	Bottom Side	0	Reduced	19100	1900	18.36	19.50	1.300	0.04	2.190	2.847
	LTE Band 2	20M	QPSK	50	0	Bottom Side	0	Reduced	18900	1880	18.17	19.50	1.358	-0.01	2.270	3.083
54	LTE Band 2	20M	QPSK	50	0	Bottom Side	0	Reduced	18700	1860	18.03	19.50	1.403	0.01	2.310	3.240
	LTE Band 2	20M	QPSK	50	0	Bottom Side	0	Reduced	19100	1900	18.16	19.50	1.361	0.04	2.190	2.982
	LTE Band 2	20M	QPSK	100	0	Bottom Side	0	Reduced	18900	1880	18.12	19.50	1.374	0.03	2.240	3.078
	LTE Band 2	20M	QPSK	1	0	Front	6	Full	18900	1880	22.93	24.00	1.279	-0.06	1.200	1.535
	LTE Band 2	20M	QPSK	1	0	Back	11	Full	18700	1860	22.77	24.00	1.327	0.01	0.512	0.680
	LTE Band 2	20M	QPSK	1	0	Bottom Side	11	Full	18700	1860	22.77	24.00	1.327	0.05	0.714	0.948
	LTE Band 66	20M	QPSK	1	0	Front	0	Reduced	132322	1745	20.42	21.50	1.282	0.09	1.300	1.667
	LTE Band 66	20M	QPSK	50	0	Front	0	Reduced	132322	1745	20.15	21.50	1.365	0.06	1.400	1.910
	LTE Band 66	20M	QPSK	1	0	Back	0	Reduced	132322	1745	20.42	21.50	1.282	0.08	2.190	2.808
	LTE Band 66	20M	QPSK	1	0	Back	0	Reduced	132072	1720	20.16	21.50	1.361	0.07	2.120	2.886
	LTE Band 66	20M	QPSK	1	0	Back	0	Reduced	132572	1770	20.16	21.50	1.361	-0.16	2.160	2.941
	LTE Band 66	20M	QPSK	50	0	Back	0	Reduced	132322	1745	20.15	21.50	1.365	0.03	2.210	3.016
	LTE Band 66	20M	QPSK	50	0	Back	0	Reduced	132072	1720	20.14	21.50	1.368	0.09	2.100	2.872
	LTE Band 66	20M	QPSK	50	0	Back	0	Reduced	132572	1770	20.13	21.50	1.371	0.06	2.070	2.838
	LTE Band 66	20M	QPSK	100	0	Back	0	Reduced	132322	1745	20.12	21.50	1.374	0.06	2.150	2.954
	LTE Band 66	20M	QPSK	1	0	Bottom Side	0	Reduced	132322	1745	20.42	21.50	1.282	-0.03	2.340	3.001
	LTE Band 66	20M	QPSK	1	0	Bottom Side	0	Reduced	132072	1720	20.16	21.50	1.361	-0.15	2.250	3.063
55	LTE Band 66	20M	QPSK	1	0	Bottom Side	0	Reduced	132572	1770	20.16	21.50	1.361	0.07	2.370	3.227
	LTE Band 66	20M	QPSK	50	0	Bottom Side	0	Reduced	132322	1745	20.15	21.50	1.365	0.09	2.300	3.139
	LTE Band 66	20M	QPSK	50	0	Bottom Side	0	Reduced	132072	1720	20.14	21.50	1.368	0.06	2.280	3.118
	LTE Band 66	20M	QPSK	50	0	Bottom Side	0	Reduced	132572	1770	20.13	21.50	1.371	0.04	2.300	3.153
	LTE Band 66	20M	QPSK	100	0	Bottom Side	0	Reduced	132322	1745	20.12	21.50	1.374	0.03	2.200	3.023
	LTE Band 66	20M	QPSK	1	0	Front	6	Full	132322	1745	23.06	24.00	1.242	-0.04	0.861	1.069
	LTE Band 66	20M	QPSK	1	0	Back	11	Full	132322	1745	23.06	24.00	1.242	-0.02	0.690	0.857
	LTE Band 66	20M	QPSK	1	0	Bottom Side	11	Full	132572	1770	23.01	24.00	1.256	0.19	0.800	1.005



FCC SAR Test Report

Report No. : FA011607

Plot No.	Band	BW (MHz)	Modulation	RB Size	RB Offset	Test Position	Gap (mm)	Power Mode	Ch.	Freq. (MHz)	Average Power (dBm)	Tune-Up Limit (dBm)	Tune-up Scaling Factor	Power Drift (dB)	Measured 10g SAR (W/kg)	Reported 10g SAR (W/kg)
	LTE Band 7	20M	QPSK	1	0	Left side	0	Full	21100	2535	22.44	24.00	1.432	0.09	0.903	1.293
	LTE Band 7	20M	QPSK	50	0	Left side	0	Full	21100	2535	21.47	23.00	1.422	0.03	0.526	0.748
	LTE Band 7	20M	QPSK	1	0	Front	0	Full	21100	2535	22.44	24.00	1.432	0.03	2.190	3.136
	LTE Band 7	20M	QPSK	1	0	Front	0	Full	20850	2510	22.36	24.00	1.459	0.09	2.030	2.961
	LTE Band 7	20M	QPSK	1	0	Front	0	Full	21350	2560	22.36	24.00	1.459	0.05	2.010	2.932
	LTE Band 7	20M	QPSK	50	0	Front	0	Full	21100	2535	21.47	23.00	1.422	0.05	1.030	1.465
	LTE Band 7	20M	QPSK	100	0	Front	0	Full	21100	2535	21.43	23.00	1.435	0.05	1.030	1.479
	LTE Band 7	20M	QPSK	1	0	Back	0	Full	21100	2535	22.44	24.00	1.432	0.09	2.290	3.280
56	LTE Band 7	20M	QPSK	1	0	Back	0	Full	20850	2510	22.36	24.00	1.459	0.01	2.260	3.297
	LTE Band 7	20M	QPSK	1	0	Back	0	Full	21350	2560	22.36	24.00	1.459	0.07	2.160	3.151
	LTE Band 7	20M	QPSK	50	0	Back	0	Full	21100	2535	21.47	23.00	1.422	0.09	1.340	1.906
	LTE Band 7	20M	QPSK	100	0	Back	0	Full	21100	2535	21.43	23.00	1.435	-0.06	1.360	1.952
	LTE Band 7	20M	QPSK	1	0	Bottom Side	0	Full	21100	2535	22.44	24.00	1.432	0.03	2.110	3.022
	LTE Band 7	20M	QPSK	1	0	Bottom Side	0	Full	20850	2510	22.36	24.00	1.459	0.02	2.050	2.991
	LTE Band 7	20M	QPSK	1	0	Bottom Side	0	Full	21350	2560	22.36	24.00	1.459	0.1	2.160	3.151
	LTE Band 7	20M	QPSK	50	0	Bottom Side	0	Full	21100	2535	21.47	23.00	1.422	0.04	1.300	1.849
	LTE Band 7	20M	QPSK	100	0	Bottom Side	0	Full	21100	2535	21.43	23.00	1.435	0.04	1.310	1.880

<TDD LTE SAR>

Plot No.	Band	BW (MHz)	Modulation	RB Size	RB Offset	Test Position	Gap (mm)	Power Mode	Ch.	Freq. (MHz)	Average Power (dBm)	Tune-Up Limit (dBm)	Tune-up Scaling Factor	Duty Cycle %	Duty Cycle Scaling Factor	Power Drift (dB)	Measured 10g SAR (W/kg)	Reported 10g SAR (W/kg)
	LTE Band 41	20M	QPSK	1	0	Front	0	Full	40640	2595	22.67	24.00	1.358	62.9	1.006	0.01	1.230	1.681
	LTE Band 41	20M	QPSK	1	0	Front	0	Full	40140	2545	22.56	24.00	1.393	62.9	1.006	-0.01	1.070	1.500
	LTE Band 41	20M	QPSK	1	0	Front	0	Full	40390	2570	22.63	24.00	1.371	62.9	1.006	0.05	1.180	1.627
	LTE Band 41	20M	QPSK	1	0	Front	0	Full	40890	2620	22.42	24.00	1.439	62.9	1.006	0.13	1.200	1.737
	LTE Band 41	20M	QPSK	1	0	Front	0	Full	41140	2645	22.55	24.00	1.396	62.9	1.006	0.04	1.100	1.545
	LTE Band 41	20M	QPSK	50	0	Front	0	Full	40640	2595	21.45	23.00	1.429	62.9	1.006	0.04	0.665	0.956
	LTE Band 41	20M	QPSK	100	0	Front	0	Full	40640	2595	21.36	23.00	1.459	62.9	1.006	-0.04	0.650	0.954
	LTE Band 41	20M	QPSK	1	0	Back	0	Full	40640	2595	22.67	24.00	1.358	62.9	1.006	0.01	1.600	2.186
	LTE Band 41	20M	QPSK	1	0	Back	0	Full	40140	2545	22.56	24.00	1.393	62.9	1.006	0.04	1.380	1.934
	LTE Band 41	20M	QPSK	1	0	Back	0	Full	40390	2570	22.63	24.00	1.371	62.9	1.006	0.05	1.450	2.000
57	LTE Band 41	20M	QPSK	1	0	Back	0	Full	40890	2620	22.42	24.00	1.439	62.9	1.006	0.08	1.520	2.200
	LTE Band 41	20M	QPSK	1	0	Back	0	Full	41140	2645	22.55	24.00	1.396	62.9	1.006	0.02	1.540	2.163
	LTE Band 41	20M	QPSK	50	0	Back	0	Full	40640	2595	21.45	23.00	1.429	62.9	1.006	0.06	0.923	1.327
	LTE Band 41	20M	QPSK	100	0	Back	0	Full	40640	2595	21.36	23.00	1.459	62.9	1.006	0.08	0.923	1.355
	LTE Band 41	20M	QPSK	1	0	Bottom Side	0	Full	40640	2595	22.67	24.00	1.358	62.9	1.006	0.09	1.140	1.558
	LTE Band 41	20M	QPSK	1	0	Bottom Side	0	Full	40140	2545	22.56	24.00	1.393	62.9	1.006	0.12	1.120	1.570
	LTE Band 41	20M	QPSK	1	0	Bottom Side	0	Full	40390	2570	22.63	24.00	1.371	62.9	1.006	0.05	1.200	1.655
	LTE Band 41	20M	QPSK	1	0	Bottom Side	0	Full	40890	2620	22.42	24.00	1.439	62.9	1.006	0.01	1.140	1.650
	LTE Band 41	20M	QPSK	1	0	Bottom Side	0	Full	41140	2645	22.55	24.00	1.396	62.9	1.006	0.02	1.060	1.489
	LTE Band 41	20M	QPSK	50	0	Bottom Side	0	Full	40640	2595	21.45	24.00	1.799	62.9	1.006	-0.08	0.625	1.131
	LTE Band 41	20M	QPSK	100	0	Bottom Side	0	Full	40640	2595	21.36	23.00	1.459	62.9	1.006	0.02	0.607	0.891



<WLAN 2.4GHz SAR>

Plot No.	Band	Mode	Test Position	Gap (mm)	Power Mode	Ch.	Freq. (MHz)	Average Power (dBm)	Tune-Up Limit (dBm)	Tune-up Scaling Factor	Duty Cycle %	Duty Cycle Scaling Factor	Power Drift (dB)	Measured 10g SAR (W/kg)	Reported 10g SAR (W/kg)
	WLAN2.4GHz	802.11b 1Mbps	Front	0	Full	6	2437	20.84	22.50	1.466	100	1.000	0.06	2.060	3.019
58	WLAN2.4GHz	802.11b 1Mbps	Front	0	Full	11	2462	20.92	22.50	1.439	100	1.000	0.03	2.150	3.093
	WLAN2.4GHz	802.11b 1Mbps	Back	0	Full	6	2437	20.84	22.50	1.466	100	1.000	0.01	2.000	2.931
	WLAN2.4GHz	802.11b 1Mbps	Back	0	Full	11	2462	20.92	22.50	1.439	100	1.000	0.03	2.130	3.065
	WLAN2.4GHz	802.11b 1Mbps	Right Side	0	Full	11	2462	20.92	22.50	1.439	100	1.000	0.01	0.959	1.380
	WLAN2.4GHz	802.11b 1Mbps	Top Side	0	Full	6	2437	20.84	22.50	1.466	100	1.000	0.03	1.790	2.623
	WLAN2.4GHz	802.11b 1Mbps	Top Side	0	Full	11	2462	20.92	22.50	1.439	100	1.000	0.01	1.630	2.345
	WLAN2.4GHz	802.11b 1Mbps	Front	0	Reduced	6	2437	20.84	21.50	1.164	100	1.000	0.06	2.060	2.398
	WLAN2.4GHz	802.11b 1Mbps	Front	0	Reduced	11	2462	20.92	21.50	1.143	100	1.000	0.03	2.140	2.446
	WLAN2.4GHz	802.11b 1Mbps	Back	0	Reduced	6	2437	20.84	21.50	1.164	100	1.000	0.01	2.000	2.328
	WLAN2.4GHz	802.11b 1Mbps	Back	0	Reduced	11	2462	20.92	21.50	1.143	100	1.000	0.03	2.130	2.434

<WLAN 5GHz SAR>

Plot No.	Band	Mode	Test Position	Gap (mm)	Power Mode	Ch.	Freq. (MHz)	Average Power (dBm)	Tune-Up Limit (dBm)	Tune-up Scaling Factor	Duty Cycle %	Duty Cycle Scaling Factor	Power Drift (dB)	Measured 10g SAR (W/kg)	Reported 10g SAR (W/kg)
59	WLAN5.2GHz	802.11n-HT40 MCS0	Back	0	Full	38	5190	17.31	19.00	1.476	96.3	1.038	0.05	2.150	3.293
	WLAN5.2GHz	802.11n-HT40 MCS0	Back	0	Full	46	5230	17.29	19.00	1.483	96.3	1.038	-0.03	2.080	3.201
	WLAN5.2GHz	802.11n-HT40 MCS0	Top Side	0	Full	38	5190	17.31	19.00	1.476	96.3	1.038	0.02	1.670	2.558
	WLAN5.2GHz	802.11n-HT40 MCS0	Top Side	0	Full	46	5230	17.29	19.00	1.483	96.3	1.038	0.02	1.480	2.278
	WLAN5.2GHz	802.11n-HT40 MCS0	Back	0	Reduced	38	5190	17.31	18.00	1.172	96.3	1.038	0.05	2.150	2.616
	WLAN5.2GHz	802.11n-HT40 MCS0	Back	0	Reduced	46	5230	17.29	18.00	1.178	96.3	1.038	-0.03	2.080	2.542
	WLAN5.2GHz	802.11n-HT40 MCS0	Back	11	Full	38	5190	17.31	19.00	1.476	96.3	1.038	0.05	0.352	0.539
	WLAN5.3GHz	802.11n-HT40 MCS0	Front	0	Full	62	5310	17.98	19.00	1.265	96.3	1.038	0.01	1.290	1.694
	WLAN5.3GHz	802.11n-HT40 MCS0	Back	0	Full	62	5310	17.98	19.00	1.265	96.3	1.038	-0.02	2.030	2.665
60	WLAN5.3GHz	802.11n-HT40 MCS0	Back	0	Full	54	5270	17.78	19.00	1.324	96.3	1.038	0.06	2.080	2.859
	WLAN5.3GHz	802.11n-HT40 MCS0	Back	0	Reduced	62	5310	17.98	18.00	1.005	96.3	1.038	-0.02	2.030	2.117
	WLAN5.3GHz	802.11n-HT40 MCS0	Back	0	Reduced	54	5270	17.78	18.00	1.052	96.3	1.038	0.06	2.080	2.271
	WLAN5.3GHz	802.11n-HT40 MCS0	Right Side	0	Full	62	5310	17.98	19.00	1.265	96.3	1.038	-0.05	0.528	0.693
	WLAN5.3GHz	802.11n-HT40 MCS0	Top Side	0	Full	62	5310	17.98	19.00	1.265	96.3	1.038	0.01	2.020	2.652
	WLAN5.3GHz	802.11n-HT40 MCS0	Top Side	0	Full	54	5270	17.78	19.00	1.324	96.3	1.038	0.01	1.730	2.378
	WLAN5.3GHz	802.11n-HT40 MCS0	Back	11	Full	54	5270	17.78	19.00	1.324	96.3	1.038	-0.02	0.436	0.599
	WLAN5.5GHz	802.11n-HT40 MCS0	Front	0	Full	134	5670	18.46	19.00	1.132	96.3	1.038	0.01	0.586	0.689
61	WLAN5.5GHz	802.11n-HT40 MCS0	Back	0	Full	134	5670	18.46	19.00	1.132	96.3	1.038	-0.01	2.420	2.845
	WLAN5.5GHz	802.11n-HT40 MCS0	Back	0	Full	102	5510	17.57	19.00	1.390	96.3	1.038	0.01	1.490	2.150
	WLAN5.5GHz	802.11n-HT40 MCS0	Back	0	Reduced	134	5670	18.46	18.50	1.009	96.3	1.038	-0.01	2.420	2.535
	WLAN5.5GHz	802.11n-HT40 MCS0	Back	0	Reduced	102	5510	17.57	18.50	1.239	96.3	1.038	0.01	1.490	1.916
	WLAN5.5GHz	802.11n-HT40 MCS0	Right Side	0	Full	134	5670	18.46	19.00	1.132	96.3	1.038	0.07	0.124	0.146
	WLAN5.5GHz	802.11n-HT40 MCS0	Top Side	0	Full	134	5670	18.46	19.00	1.132	96.3	1.038	0.06	0.532	0.625
	WLAN5.5GHz	802.11n-HT40 MCS0	Back	11	Full	134	5670	18.46	19.00	1.132	96.3	1.038	-0.01	0.416	0.489
62	WLAN5.8GHz	802.11a 6Mbps	Back	0	Full	165	5825	18.25	19.00	1.189	98.26	1.018	0.03	2.590	3.134
	WLAN5.8GHz	802.11a 6Mbps	Back	0	Full	157	5785	18.21	19.00	1.199	98.26	1.018	0.01	2.500	3.053
	WLAN5.8GHz	802.11a 6Mbps	Back	0	Reduced	165	5825	18.25	18.50	1.059	98.26	1.018	0.03	2.590	2.793
	WLAN5.8GHz	802.11a 6Mbps	Back	0	Reduced	157	5785	18.21	18.50	1.069	98.26	1.018	0.01	2.500	2.721
	WLAN5.8GHz	802.11a 6Mbps	Back	11	Full	165	5825	18.25	19.00	1.189	98.26	1.018	0.03	0.473	0.572



14.5 Repeated SAR Measurement

<1g SAR>

No.	Band	BW (MHz)	Modulation	RB Size	RB Offset	Mode	Test Position	Gap (mm)	Power Mode	Ch.	Freq. (MHz)	Average Power (dBm)	Tune-Up Limit (dBm)	Tune-up Scaling Factor	Duty Cycle %	Duty Cycle Scaling Factor	Power Drift (dB)	Measured 1g SAR (W/kg)	Ratio	Reported 1g SAR (W/kg)
1st	WLAN5.3GHz	-	-	-	-	802.11n-HT40 MCS0	Left Cheek	0	Reduced	62	5310	15.89	16.00	1.026	96.3	1.038	-0.13	1.120	1	1.192
2nd	WLAN5.3GHz	-	-	-	-	802.11n-HT40 MCS0	Left Cheek	0	Reduced	62	5310	15.89	16.00	1.026	96.3	1.038	-0.05	1.070	1.047	1.139
1st	WCDMA II	-	-	-	-	RMC 12.2Kbps	Back	5	Reduced	9538	1907.6	16.55	17.00	1.109	-	1.000	0.09	1.250	1	1.386
2nd	WCDMA II	-	-	-	-	RMC 12.2Kbps	Back	5	Reduced	9538	1907.6	16.55	17.00	1.109	-	1.000	-0.03	1.190	1.050	1.320
1st	WCDMA V	-	-	-	-	RMC 12.2Kbps	Back	5	Full	4182	836.4	23.86	24.00	1.033	-	1.000	0.04	1.250	1	1.291
2nd	WCDMA V	-	-	-	-	RMC 12.2Kbps	Back	5	Full	4182	836.4	23.86	24.00	1.033	-	1.000	-0.03	1.230	1.016	1.270
1st	LTE Band 66	20M	QPSK	50	0	-	Back	5	Reduced	132572	1770	18.48	19.00	1.127	-	1.000	-0.03	1.220	1	1.375
2nd	LTE Band 66	20M	QPSK	50	0	-	Back	5	Reduced	132572	1770	18.48	19.00	1.127	-	1.000	0.06	1.190	1.025	1.341
1st	LTE Band 41	20M	QPSK	1	0	-	Bottom Side	5	Reduced	40890	2620	21.40	22.50	1.288	62.9	1.006	0.14	1.060	1	1.374
2nd	LTE Band 41	20M	QPSK	1	0	-	Bottom Side	5	Reduced	40890	2620	21.40	22.50	1.288	62.9	1.006	0.03	1.020	1.039	1.322
1st	WLAN2.4GHz	-	-	-	-	802.11b 1Mbps	Left Cheek	5	Reduced	1	2412	17.29	18.00	1.178	100	1.000	0.08	0.936	1	1.102
2nd	WLAN2.4GHz	-	-	-	-	802.11b 1Mbps	Left Cheek	5	Reduced	1	2412	17.29	18.00	1.178	100	1.000	0.02	0.926	1.011	1.090
1st	WLAN5.5GHz	-	-	-	-	802.11n-HT40 MCS0	Back	5	Reduced	134	5670	14.57	15.00	1.104	96.3	1.038	-0.04	0.979	1	1.122
2nd	WLAN5.5GHz	-	-	-	-	802.11n-HT40 MCS0	Back	5	Reduced	134	5670	14.57	15.00	1.104	96.3	1.038	0.06	0.973	1.006	1.115
1st	WLAN5.8GHz	-	-	-	-	802.11a 6Mbps	Back	5	Reduced	165	5825	14.43	14.50	1.016	98.26	1.018	0.01	1.070	1	1.107
2nd	WLAN5.8GHz	-	-	-	-	802.11a 6Mbps	Back	5	Reduced	165	5825	14.43	14.50	1.016	98.26	1.018	0.04	1.050	1.019	1.086

<10g SAR>

No.	Band	BW (MHz)	Modulation	RB Size	RB Offset	Mode	Test Position	Gap (mm)	Power Mode	Ch.	Freq. (MHz)	Average Power (dBm)	Tune-Up Limit (dBm)	Tune-up Scaling Factor	Duty Cycle %	Duty Cycle Scaling Factor	Power Drift (dB)	Measured 10g SAR (W/kg)	Ratio	Reported 10g SAR (W/kg)
1st	WCDMA II	-	-	-	-	RMC 12.2Kbps	Bottom Side	0	Reduced	9262	1852.4	20.47	20.50	1.007	-	1.000	0.07	3.230	1	3.252
2nd	WCDMA II	-	-	-	-	RMC 12.2Kbps	Bottom Side	0	Reduced	9262	1852.4	20.47	20.50	1.007	-	1.000	0.01	3.170	1.019	3.192
1st	WCDMA IV	-	-	-	-	RMC 12.2Kbps	Bottom Side	0	Reduced	1312	1712.4	19.96	20.50	1.132	-	1.000	0.08	3.090	1	3.499
2nd	WCDMA IV	-	-	-	-	RMC 12.2Kbps	Bottom Side	0	Reduced	1312	1712.4	19.96	20.50	1.132	-	1.000	0.06	3.010	1.027	3.409
1st	WCDMA V	-	-	-	-	RMC 12.2Kbps	Back	0	Full	4182	836.4	23.86	24.00	1.033	-	1.000	0.03	2.380	1	2.458
2nd	WCDMA V	-	-	-	-	RMC 12.2Kbps	Back	0	Full	4182	836.4	23.86	24.00	1.033	-	1.000	0.09	2.310	1.030	2.386
1st	LTE Band 7	20M	QPSK	1	0	-	Back	0	Full	27710	2310	22.44	24.00	1.432	-	1.000	0.09	2.290	1	3.280
2nd	LTE Band 7	20M	QPSK	1	0	-	Back	0	Full	21100	2535	22.44	24.00	1.432	-	1.000	0.03	2.250	1.018	3.222
1st	WLAN2.4GHz	-	-	-	-	802.11b 1Mbps	Front	0	Full	11	2462	20.92	22.50	1.439	100	1.000	0.03	2.150	1	3.093
2nd	WLAN2.4GHz	-	-	-	-	802.11b 1Mbps	Front	0	Full	11	2462	20.92	22.50	1.439	100	1.000	0.01	2.090	1.029	3.007
1st	WLAN5.2GHz	-	-	-	-	802.11n-HT40 MCS0	Back	0	Full	38	5190	17.31	19.00	1.476	96.3	1.038	0.05	2.150	1	3.293
2nd	WLAN5.2GHz	-	-	-	-	802.11n-HT40 MCS0	Back	0	Full	38	5190	17.31	19.00	1.476	96.3	1.038	-0.02	2.090	1.029	3.201
1st	WLAN5.5GHz	-	-	-	-	802.11n-HT40 MCS0	Back	0	Full	134	5670	18.46	19.00	1.132	96.3	1.038	-0.01	2.420	1	2.845
2nd	WLAN5.5GHz	-	-	-	-	802.11n-HT40 MCS0	Back	0	Full	134	5670	18.46	19.00	1.132	96.3	1.038	0.04	2.360	1.025	2.774
1st	WLAN5.8GHz	-	-	-	-	802.11a 6Mbps	Back	0	Full	165	5825	18.25	19.00	1.189	98.26	1.018	0.03	2.590	1	3.134
2nd	WLAN5.8GHz	-	-	-	-	802.11a 6Mbps	Back	0	Full	165	5825	18.25	19.00	1.189	98.26	1.018	0.08	2.520	1.028	3.049

General Note:

- Per KDB 865664 D01v01r04, for each frequency band, repeated SAR measurement is required only when the measured SAR is $\geq 0.8W/kg$.
- Per KDB 865664 D01v01r04, if the ratio among the repeated measurement is ≤ 1.2 and the measured SAR $< 1.45W/kg$, only one repeated measurement is required.
- Per KDB 865664 D01v01r04, if the extremity repeated SAR is necessary, the same procedures should be adapted for measurements according to extremity and occupational exposure limits by applying a factor of 2.5 for extremity exposure and a factor of 5 for occupational exposure to the corresponding SAR thresholds.
- The ratio is the difference in percentage between original and repeated *measured SAR*.
- All measurement SAR result is scaled-up to account for tune-up tolerance and is compliant.

15. Simultaneous Transmission Analysis

No.	Simultaneous Transmission Configurations	Portable Handset			
		Head	Body-worn	Hotspot	Product specific 10g SAR
1.	GSM Voice + WLAN2.4GHz	Yes	Yes		
2.	GPRS/EDGE + WLAN2.4GHz	Yes	Yes	Yes	Yes
3.	WCDMA + WLAN2.4GHz	Yes	Yes	Yes	Yes
4.	LTE + WLAN2.4GHz	Yes	Yes	Yes	Yes
5.	GSM Voice + WLAN5.3/5.5GHz	Yes	Yes		
6.	GPRS/EDGE + WLAN5.3/5.5GHz	Yes	Yes		Yes
7.	WCDMA + WLAN5.3/5.5GHz	Yes	Yes		Yes
8.	LTE + WLAN5.3/5.5GHz	Yes	Yes		Yes
9.	GSM Voice + WLAN5.2/5.8GHz	Yes	Yes		
10.	GPRS/EDGE + WLAN5.2/5.8GHz	Yes	Yes	Yes	Yes
11.	WCDMA + WLAN5.2/5.8GHz	Yes	Yes	Yes	Yes
12.	LTE + WLAN5.2/5.8GHz	Yes	Yes	Yes	Yes
13.	GSM Voice + Bluetooth	Yes	Yes		
14.	GPRS/EDGE + Bluetooth	Yes	Yes	Yes	Yes
15.	WCDMA + Bluetooth	Yes	Yes	Yes	Yes
16.	LTE + Bluetooth	Yes	Yes	Yes	Yes

General Note:

1. This device supports VoIP in GPRS, EGPRS, WCDMA and LTE (e.g. for 3rd-party VoIP), LTE supports VoLTE operation.
2. EUT will choose each GSM, WCDMA and LTE according to the network signal condition; therefore, they will not operate simultaneously at any moment.
3. This device 2.4GHz WLAN support hotspot operation and Bluetooth support tethering applications.
4. This device 2.4GHz WLAN/ 5.2GHz WLAN/5.8GHz WLAN support hotspot operation, and 5.2GHz WLAN/5.8GHz WLAN supports WLAN Direct (GC/GO), and 5.3GHz / 5.5GHz supports WLAN Direct (GC only).
5. EUT will choose either WLAN 2.4GHz or WLAN 5GHz according to the network signal condition; therefore, 2.4GHz WLAN and 5GHz WLAN will not operate simultaneously at any moment though they have independent antenna.
6. WLAN 2.4GHz and Bluetooth share the same antenna so can't transmit simultaneously.
7. According to the EUT character, WLAN 5GHz and Bluetooth can't transmit simultaneously.
8. Chose the worst zoom scan SAR of WLAN correspondingly for co-located with WWAN analysis.
9. The reported SAR summation is calculated based on the same configuration and test position.
10. Per KDB 447498 D01v06, simultaneous transmission SAR is compliant if,
 - i) 1g Scalar SAR summation < 1.6W/kg and 10g Scalar SAR summation < 4.0W/kg.
 - ii) $SPLSR = (SAR1 + SAR2)^{1.5} / (\text{min. separation distance, mm})$, and the peak separation distance is determined from the square root of $[(x1-x2)^2 + (y1-y2)^2 + (z1-z2)^2]$, where (x1, y1, z1) and (x2, y2, z2) are the coordinates of the extrapolated peak SAR locations in the zoom scan.
 - iii) If $SPLSR \leq 0.04$ for 1g SAR and $SPLSR \leq 0.10$ for 10g SAR, simultaneously transmission SAR measurement is not necessary.
 - iv) Simultaneously transmission SAR measurement, and the reported multi-band 1g SAR < 1.6W/kg and 10g SAR < 4.0W/kg.
 - v) The SPLSR calculated results please refer to section 15.5.



15.1 Head Exposure Conditions

WWAN Band		Exposure Position	1	2	3	4	1+2 Summed 1g SAR (W/kg)	1+3 Summed 1g SAR (W/kg)	1+4 Summed 1g SAR (W/kg)
			WWAN 1g SAR (W/kg)	2.4GHz WLAN 1g SAR (W/kg)	5GHz WLAN 1g SAR (W/kg)	Bluetooth 1g SAR (W/kg)			
GSM	GSM850	Right Cheek	0.122	0.545	1.177	0.088	0.67	1.30	0.21
		Right Tilted	0.027	0.571	1.186	0.088	0.60	1.21	0.12
		Left Cheek	0.109	1.102	1.192	0.088	1.21	1.30	0.20
		Left Tilted	0.051	0.743	1.128	0.088	0.79	1.18	0.14
	GSM1900	Right Cheek	0.050	0.545	1.177	0.088	0.60	1.23	0.14
		Right Tilted	0.034	0.571	1.186	0.088	0.61	1.22	0.12
		Left Cheek	0.050	1.102	1.192	0.088	1.15	1.24	0.14
		Left Tilted	0.037	0.743	1.128	0.088	0.78	1.17	0.13
WCDMA	WCDMA II	Right Cheek	0.115	0.545	1.177	0.088	0.66	1.29	0.20
		Right Tilted	0.069	0.571	1.186	0.088	0.64	1.26	0.16
		Left Cheek	0.096	1.102	1.192	0.088	1.20	1.29	0.18
		Left Tilted	0.089	0.743	1.128	0.088	0.83	1.22	0.18
	WCDMA IV	Right Cheek	0.197	0.545	1.177	0.088	0.74	1.37	0.29
		Right Tilted	0.084	0.571	1.186	0.088	0.66	1.27	0.17
		Left Cheek	0.165	1.102	1.192	0.088	1.27	1.36	0.25
		Left Tilted	0.140	0.743	1.128	0.088	0.88	1.27	0.23
	WCDMA V	Right Cheek	0.334	0.545	1.177	0.088	0.88	1.51	0.42
		Right Tilted	0.165	0.571	1.186	0.088	0.74	1.35	0.25
		Left Cheek	0.293	1.102	1.192	0.088	1.40	1.49	0.38
		Left Tilted	0.175	0.743	1.128	0.088	0.92	1.30	0.26
LTE	LTE Band 2	Right Cheek	0.169	0.545	1.177	0.088	0.71	1.35	0.26
		Right Tilted	0.093	0.571	1.186	0.088	0.66	1.28	0.18
		Left Cheek	0.174	1.102	1.192	0.088	1.28	1.37	0.26
		Left Tilted	0.159	0.743	1.128	0.088	0.90	1.29	0.25
	LTE Band 7	Right Cheek	0.145	0.545	1.177	0.088	0.69	1.32	0.23
		Right Tilted	0.095	0.571	1.186	0.088	0.67	1.28	0.18
		Left Cheek	0.092	1.102	1.192	0.088	1.19	1.28	0.18
		Left Tilted	0.043	0.743	1.128	0.088	0.79	1.17	0.13
	LTE Band 12	Right Cheek	0.272	0.545	1.177	0.088	0.82	1.45	0.36
		Right Tilted	0.117	0.571	1.186	0.088	0.69	1.30	0.21
		Left Cheek	0.251	1.102	1.192	0.088	1.35	1.44	0.34
		Left Tilted	0.114	0.743	1.128	0.088	0.86	1.24	0.20
	LTE Band 26	Right Cheek	0.339	0.545	1.177	0.088	0.88	1.52	0.43
		Right Tilted	0.181	0.571	1.186	0.088	0.75	1.37	0.27
		Left Cheek	0.308	1.102	1.192	0.088	1.41	1.50	0.40
		Left Tilted	0.171	0.743	1.128	0.088	0.91	1.30	0.26
	LTE Band 66	Right Cheek	0.168	0.545	1.177	0.088	0.71	1.35	0.26
		Right Tilted	0.085	0.571	1.186	0.088	0.66	1.27	0.17
		Left Cheek	0.129	1.102	1.192	0.088	1.23	1.32	0.22
		Left Tilted	0.117	0.743	1.128	0.088	0.86	1.25	0.21
	LTE Band 41	Right Cheek	0.119	0.545	1.177	0.088	0.66	1.30	0.21
		Right Tilted	0.100	0.571	1.186	0.088	0.67	1.29	0.19
		Left Cheek	0.081	1.102	1.192	0.088	1.18	1.27	0.17
		Left Tilted	0.051	0.743	1.128	0.088	0.79	1.18	0.14



15.2 Hotspot Exposure Conditions

WWAN Band	Exposure Position	1	2	3	4	1+2			1+3			1+4	
		WWAN	2.4GHz WLAN	5GHz WLAN	Bluetooth	Summed 1g SAR (W/kg)	Case No	SPLSR	Summed 1g SAR (W/kg)	Case No	SPLSR	Summed 1g SAR (W/kg)	
		1g SAR (W/kg)	1g SAR (W/kg)	1g SAR (W/kg)	1g SAR (W/kg)								
GSM	GSM850	Front	0.508	1.173	0.345	0.053	1.68	#01	0.01	0.85			0.56
		Back	1.284	1.131	1.176	0.053	2.42	#02	0.03	2.46	#03	0.03	1.34
		Left side	0.410	0.107	0.119	0.053	0.52			0.53			0.46
		Right side	0.552	1.057	0.357	0.053	1.61	#04	0.03	0.91			0.61
		Top side		1.031	0.742	0.053	1.03			0.74			0.05
		Bottom side	1.321				1.32			1.32			1.32
	GSM1900	Front	0.795	1.173	0.345	0.053	1.97	#05	0.02	1.14			0.85
		Back	1.313	1.131	1.176	0.053	2.44	#06	0.03	2.49	#07	0.03	1.37
		Left side	0.168	0.107	0.119	0.053	0.28			0.29			0.22
		Right side	0.175	1.057	0.357	0.053	1.23			0.53			0.23
		Top side		1.031	0.742	0.053	1.03			0.74			0.05
		Bottom side	1.379				1.38			1.38			1.38
WCDMA	WCDMA II	Front	0.867	1.173	0.345	0.053	2.04	#08	0.02	1.21			0.92
		Back	1.386	1.131	1.176	0.053	2.52	#09	0.03	2.56	#10	0.03	1.44
		Left side	0.072	0.107	0.119	0.053	0.18			0.19			0.13
		Right side	0.066	1.057	0.357	0.053	1.12			0.42			0.12
		Top side		1.031	0.742	0.053	1.03			0.74			0.05
		Bottom side	1.307				1.31			1.31			1.31
	WCDMA IV	Front	0.931	1.173	0.345	0.053	2.10	#11	0.02	1.28			0.98
		Back	1.381	1.131	1.176	0.053	2.51	#12	0.03	2.56	#13	0.03	1.43
		Left side	0.051	0.107	0.119	0.053	0.16			0.17			0.10
		Right side	0.075	1.057	0.357	0.053	1.13			0.43			0.13
		Top side		1.031	0.742	0.053	1.03			0.74			0.05
		Bottom side	1.356				1.36			1.36			1.36
	WCDMA V	Front	0.795	1.173	0.345	0.053	1.97	#14	0.02	1.14			0.85
		Back	1.296	1.131	1.176	0.053	2.43	#15	0.03	2.47	#16	0.03	1.35
		Left side	0.372	0.107	0.119	0.053	0.48			0.49			0.43
		Right side	0.660	1.057	0.357	0.053	1.72	#17	0.04	1.02			0.71
		Top side		1.031	0.742	0.053	1.03			0.74			0.05
		Bottom side	1.250				1.25			1.25			1.25
LTE	LTE Band 2	Front	1.019	1.173	0.345	0.053	2.19	#18	0.02	1.36			1.07
		Back	1.215	1.131	1.176	0.053	2.35	#19	0.03	2.39	#20	0.03	1.27
		Left side	0.046	0.107	0.119	0.053	0.15			0.17			0.10
		Right side	0.044	1.057	0.357	0.053	1.10			0.40			0.10
		Top side		1.031	0.742	0.053	1.03			0.74			0.05
		Bottom side	1.334				1.33			1.33			1.33
	LTE Band 7	Front	0.618	1.173	0.345	0.053	1.79	#21	0.02	0.96			0.67
		Back	1.294	1.131	1.176	0.053	2.43	#22	0.03	2.47	#23	0.03	1.35
		Left side	0.731	0.107	0.119	0.053	0.84			0.85			0.78
		Right side		1.057	0.357	0.053	1.06			0.36			0.05
		Top side		1.031	0.742	0.053	1.03			0.74			0.05
		Bottom side	1.300				1.30			1.30			1.30
	LTE Band 12	Front	0.563	1.173	0.345	0.053	1.74	#24	0.01	0.91			0.62
		Back	1.003	1.131	1.176	0.053	2.13	#25	0.02	2.18	#26	0.02	1.06
		Left side	0.373	0.107	0.119	0.053	0.48			0.49			0.43
		Right side	0.511	1.057	0.357	0.053	1.57			0.87			0.56
		Top side		1.031	0.742	0.053	1.03			0.74			0.05
		Bottom side	0.761				0.76			0.76			0.76



WWAN Band	Exposure Position	1	2	3	4	1+2			1+3			1+4	
		WWAN	2.4GHz WLAN	5GHz WLAN	Bluetooth	Summed 1g SAR (W/kg)	Case No	SPLSR	Summed 1g SAR (W/kg)	Case No	SPLSR	Summed 1g SAR (W/kg)	
		1g SAR (W/kg)	1g SAR (W/kg)	1g SAR (W/kg)	1g SAR (W/kg)								
LTE	LTE Band 26	Front	1.117	1.173	0.345	0.053	2.29	#27	0.02	1.46			1.17
		Back	1.140	1.131	1.176	0.053	2.27	#28	0.02	2.32	#29	0.02	1.19
		Left side	0.437	0.107	0.119	0.053	0.54			0.56			0.49
		Right side	0.723	1.057	0.357	0.053	1.78	#30	0.04	1.08			0.78
		Top side		1.031	0.742	0.053	1.03			0.74			0.05
		Bottom side	1.114				1.11			1.11			1.11
	LTE Band 66	Front	0.706	1.173	0.345	0.053	1.88	#31	0.02	1.05			0.76
		Back	1.380	1.131	1.176	0.053	2.51	#32	0.03	2.56	#32	0.03	1.43
		Left side	0.048	0.107	0.119	0.053	0.16			0.17			0.10
		Right side	0.070	1.057	0.357	0.053	1.13			0.43			0.12
		Top side		1.031	0.742	0.053	1.03			0.74			0.05
		Bottom side	1.373				1.37			1.37			1.37
	LTE Band 41	Front	0.878	1.173	0.345	0.053	2.05	#34	0.02	1.22			0.93
		Back	1.324	1.131	1.176	0.053	2.46	#35	0.03	2.50	#36	0.03	1.38
		Left side	0.703	0.107	0.119	0.053	0.81			0.82			0.76
		Right side		1.057	0.357	0.053	1.06			0.36			0.05
		Top side		1.031	0.742	0.053	1.03			0.74			0.05
		Bottom side	1.388				1.39			1.39			1.39



15.3 Body-Worn Accessory Exposure Conditions

WWAN Band	Exposure Position	1	2	3	4	1+2			1+3			1+4	
		WWAN 1g SAR (W/kg)	2.4GHz WLAN 1g SAR (W/kg)	5GHz WLAN 1g SAR (W/kg)	Bluetooth 1g SAR (W/kg)	Summed 1g SAR (W/kg)	Case No	SPLSR	Summed 1g SAR (W/kg)	Case No	SPLSR	Summed 1g SAR (W/kg)	
GSM	GSM850	Front	0.508	1.173	0.436	0.053	1.68	#01	0.01	0.94			0.56
		Back	1.284	1.131	1.176	0.053	2.42	#02	0.03	2.46	#03	0.03	1.34
		Back with Headset	1.358				1.36			1.36			1.36
	GSM1900	Front	0.795	1.173	0.436	0.053	1.97	#05	0.02	1.23			0.85
		Back	1.313	1.131	1.176	0.053	2.44	#06	0.03	2.49	#07	0.03	1.37
		Back with Headset	1.203				1.20			1.20			1.20
WCDMA	WCDMA II	Front	0.867	1.173	0.436	0.053	2.04	#08	0.02	1.30			0.92
		Back	1.386	1.131	1.176	0.053	2.52	#09	0.03	2.56	#10	0.03	1.44
		Back with Headset	1.287				1.29			1.29			1.29
	WCDMA IV	Front	0.931	1.173	0.436	0.053	2.10	#11	0.02	1.37			0.98
		Back	1.381	1.131	1.176	0.053	2.51	#12	0.03	2.56	#13	0.03	1.43
		Back with Headset	1.322				1.32			1.32			1.32
	WCDMA V	Front	0.795	1.173	0.436	0.053	1.97	#14	0.02	1.23			0.85
		Back	1.296	1.131	1.176	0.053	2.43	#15	0.03	2.47	#16	0.03	1.35
		Back with Headset	0.872				0.87			0.87			0.87
LTE	LTE Band 2	Front	1.019	1.173	0.436	0.053	2.19	#18	0.02	1.46			1.07
		Back	1.215	1.131	1.176	0.053	2.35	#19	0.03	2.39	#20	0.03	1.27
		Back with Headset	1.087				1.09			1.09			1.09
	LTE Band 7	Front	0.618	1.173	0.436	0.053	1.79	#21	0.02	1.05			0.67
		Back	1.294	1.131	1.176	0.053	2.43	#22	0.03	2.47	#23	0.03	1.35
		Back with Headset	1.354				1.35			1.35			1.35
	LTE Band 12	Front	0.563	1.173	0.436	0.053	1.74	#24	0.01	1.00			0.62
		Back	1.003	1.131	1.176	0.053	2.13	#25	0.02	2.18	#26	0.02	1.06
	LTE Band 26	Front	1.117	1.173	0.436	0.053	2.29	#27	0.02	1.55			1.17
		Back	1.140	1.131	1.176	0.053	2.27	#28	0.02	2.32	#29	0.02	1.19
	LTE Band 66	Front	0.706	1.173	0.436	0.053	1.88	#31	0.02	1.14			0.76
		Back	1.380	1.131	1.176	0.053	2.51	#32	0.03	2.56	#33	0.03	1.43
		Back with Headset	1.263				1.26			1.26			1.26
	LTE Band 41	Front	0.878	1.173	0.436	0.053	2.05	#31	0.02	1.31			0.93
		Back	1.324	1.131	1.176	0.053	2.46	#35	0.03	2.50	#36	0.03	1.38
Back with Headset		1.221				1.22			1.22			1.22	



FCC SAR Test Report

Report No. : FA011607

WWAN Band		Exposure Position	1	2	3	4	1+2			1+3			1+4
			WWAN 1g SAR (W/kg)	2.4GHz WLAN 1g SAR (W/kg)	5GHz WLAN 1g SAR (W/kg)	Bluetooth 1g SAR (W/kg)	Summed 1g SAR (W/kg)	Case No	SPLSR	Summed 1g SAR (W/kg)	Case No	SPLSR	Summed 1g SAR (W/kg)
GSM	GSM850	Front at 12mm	0.342	0.847	0.591	0.053	1.19			0.93			0.40
		Back at 18mm	0.452	0.481	1.010	0.053	0.93			1.46			0.51
	GSM1900	Front at 12mm	0.590	0.847	0.591	0.053	1.44			1.18			0.64
		Back at 18mm	0.636	0.481	1.010	0.053	1.12			1.65	#37	0.02	0.69
WCDMA	WCDMA II	Front at 12mm	1.010	0.847	0.591	0.053	1.86	#38	0.02	1.60	#39	0.01	1.06
		Back at 18mm	0.904	0.481	1.010	0.053	1.39			1.91	#40	0.02	0.96
	WCDMA IV	Front at 12mm	0.998	0.847	0.591	0.053	1.85	#41	0.02	1.59			1.05
		Back at 18mm	0.820	0.481	1.010	0.053	1.30			1.83	#42	0.02	0.87
LTE	LTE Band 2	Front at 12mm	0.688	0.847	0.591	0.053	1.54			1.28			0.74
		Back at 18mm	0.423	0.481	1.010	0.053	0.90			1.43			0.48
	LTE Band 7	Front at 12mm	0.470	0.847	0.591	0.053	1.32			1.06			0.52
		Back at 18mm	0.324	0.481	1.010	0.053	0.81			1.33			0.38
	LTE Band 66	Front at 12mm	0.813	0.847	0.591	0.053	1.66	#43	0.01	1.40			0.87
		Back at 18mm	0.510	0.481	1.010	0.053	0.99			1.52			0.56
	LTE Band 41	Front at 12mm	0.228	0.847	0.591	0.053	1.08			0.82			0.28
		Back at 18mm	0.140	0.481	1.010	0.053	0.62			1.15			0.19



15.4 Product specific 10g SAR Exposure Conditions

WWAN Band	Exposure Position	1	2	3	1+2			1+3			
		WWAN	2.4GHz WLAN	5GHz WLAN	Summed 10g SAR (W/kg)	Case No	SPLSR	Summed 10g SAR (W/kg)	Case No	SPLSR	
		10g SAR (W/kg)	10g SAR (W/kg)	10g SAR (W/kg)							
GSM	GSM850	Back	0.764	2.434	2.793	3.20			3.56		
		Bottom side	0.728			0.73			0.73		
	GSM1900	Front	2.486	2.446	1.694	4.93	#44	0.07	4.18	#45	0.05
		Back	2.995	2.434	2.793	5.43	#46	0.09	5.79	#47	0.10
		Bottom side	2.607			2.61			2.61		
WCDMA	WCDMA II	Front	2.572	2.446	1.694	5.02	#48	0.07	4.27	#49	0.06
		Back	2.950	2.434	2.793	5.38	#50	0.09	5.74	#51	0.10
		Bottom side	3.252			3.25			3.25		
	WCDMA IV	Front	2.109	2.446	1.694	4.56	#52	0.06	3.80		
		Back	3.301	2.434	2.793	5.74	#53	0.10	6.09	#54	0.10
		Bottom side	3.499			3.50			3.50		
	WCDMA V	Back	2.458	2.434	2.793	4.89	#55	0.07	5.25	#56	0.08
		Bottom side	0.676			0.68			0.68		
LTE	LTE Band 2	Front	1.847	2.446	1.694	4.29	#57	0.06	3.54		
		Back	2.665	2.434	2.793	5.10	#58	0.08	5.46	#59	0.09
		Bottom side	3.240			3.24			3.24		
	LTE Band 7	Front	3.136	2.446	1.694	5.58	#60	0.08	4.83	#61	0.07
		Back	3.297	2.434	2.793	5.73	#62	0.09	6.09	#63	0.10
		Left side	1.293			1.29			1.29		
		Bottom side	3.151			3.15			3.15		
	LTE Band 66	Front	1.910	2.446	1.694	4.36	#64	0.06	3.60		
		Back	3.016	2.434	2.793	5.45	#65	0.09	5.81	#66	0.10
		Bottom side	3.227			3.23			3.23		
	LTE Band 41	Front	1.737	2.446	1.694	4.18	#67	0.06	3.43		
		Back	2.200			4.63	#68	0.07	4.99	#69	0.07
Bottom side		1.655			1.66			1.66			

WWAN Band		Exposure Position	1	2	3	1+2 Summed 10g SAR (W/kg)	1+3 Summed 10g SAR (W/kg)
			WWAN	2.4GHz WLAN Ant 1	5GHz WLAN Ant 1		
			10g SAR (W/kg)	10g SAR (W/kg)	10g SAR (W/kg)		
GSM	GSM1900	Front at 6mm	0.769	2.446	1.694	3.22	2.46
		Back at 11mm	0.862	2.434	0.599	3.30	1.46
		Bottom side at 11mm	0.926			0.93	0.93
WCDMA	WCDMA II	Front at 6mm	1.238	2.446	1.694	3.68	2.93
		Back at 11mm	1.059	2.434	0.599	3.49	1.66
		Bottom side at 11mm	1.604			1.60	1.60
	WCDMA IV	Front at 6mm	1.306	2.446	1.694	3.75	3.00
		Back at 11mm	1.168	2.434	0.599	3.60	1.77
		Bottom side at 11mm	1.428			1.43	1.43
LTE	LTE Band 2	Front at 6mm	1.535	2.446	1.694	3.98	3.23
		Back at 11mm	0.680	2.434	0.599	3.11	1.28
		Bottom side at 11mm	0.948			0.95	0.95
	LTE Band 66	Front at 6mm	1.069	2.446	1.694	3.52	2.76
		Back at 11mm	0.857	2.434	0.599	3.29	1.46
		Bottom side at 11mm	1.005			1.01	1.01

Remark:

1. For Bluetooth Product specific 10g stand-alone SAR is not required for a transmitter or antenna, due to 1g hotspot SAR is <1.2W/kg.
2. If SPLSR ≤ 0.10 for 10g SAR, simultaneously transmission SAR measurement is not necessary.

15.5 SPLSR Evaluation and Analysis

General Note:

1. When standalone SAR is measured for both antennas in the pair, the peak location separation distance is computed by the square root of $[(x1-x2)^2 + (y1-y2)^2 + (z1-z2)^2]$, where $(x1, y1, z1)$ and $(x2, y2, z2)$ are the coordinates in the area scans or extrapolated peak SAR locations in the zoom scans, as appropriate.
2. $SPLSR = (SAR1 + SAR2)1.5 / (\text{min. separation distance, mm})$. If $SPLSR \leq 0.04$ for 1g SAR and $SPLSR \leq 0.10$ for 10g SAR, simultaneously transmission SAR measurement is not necessary.

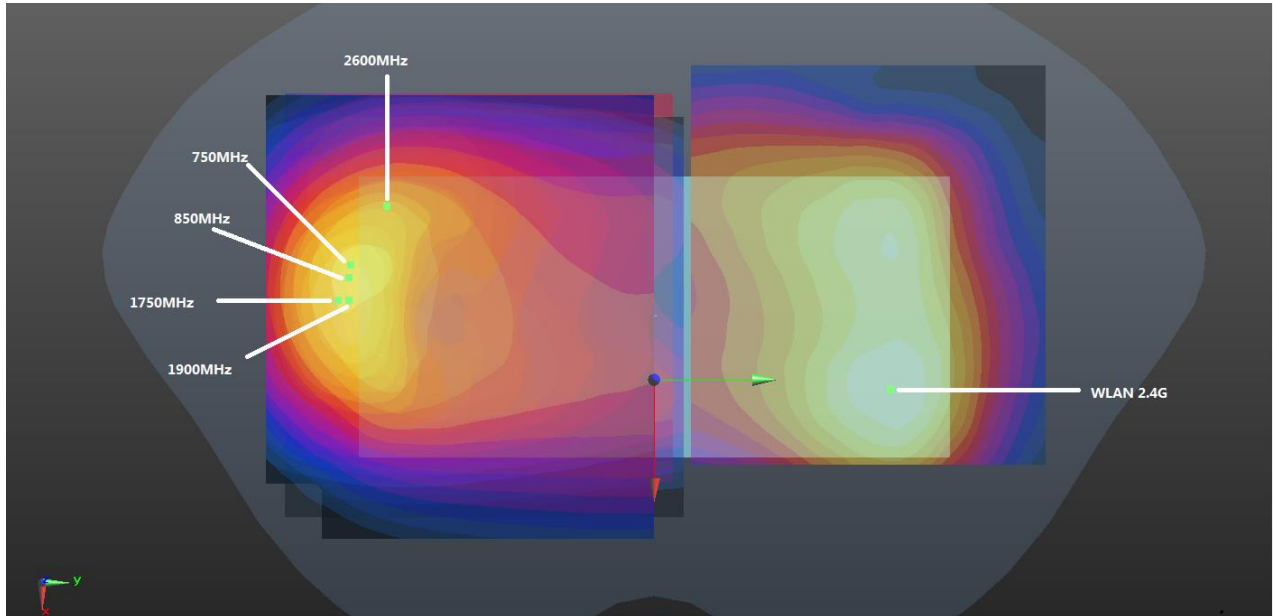

Front (5mm) + 2.4G (5mm)

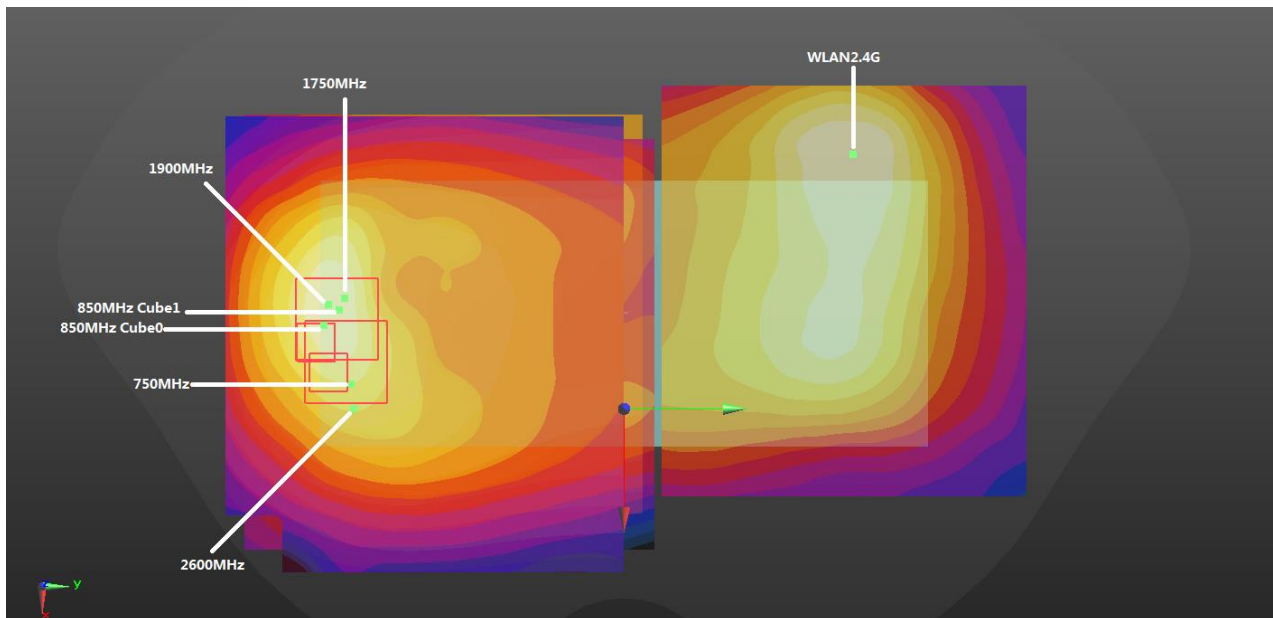

Back (5mm) + 2.4G (5mm)

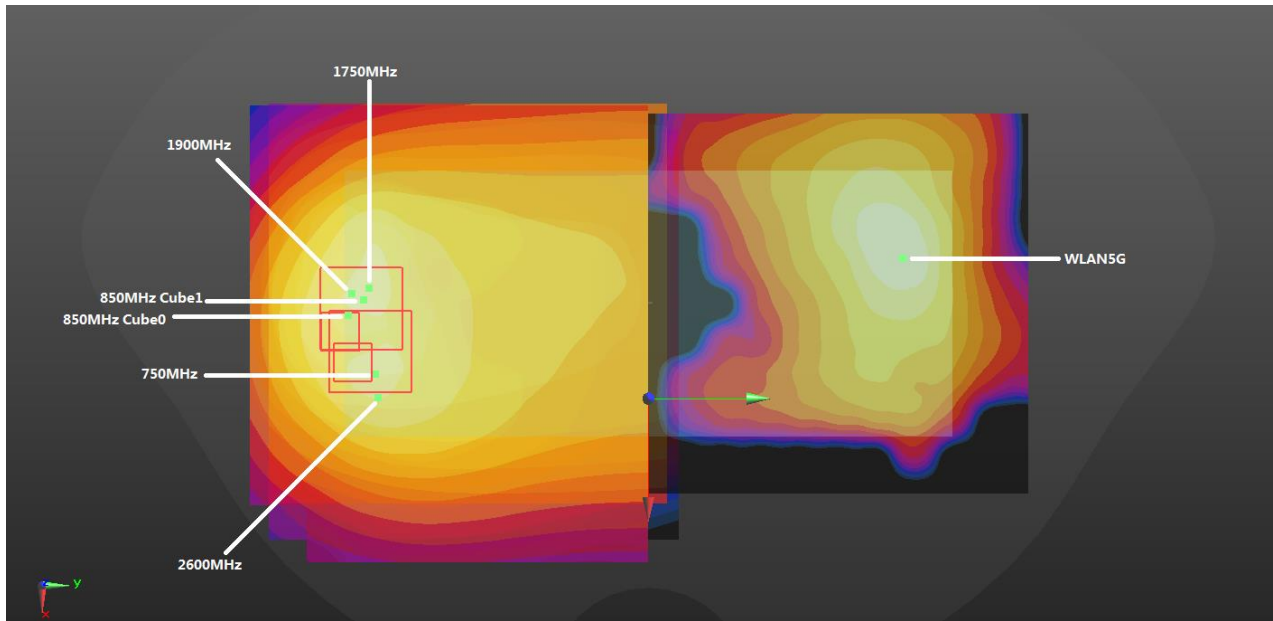

Back (5mm) + 5G (5mm)

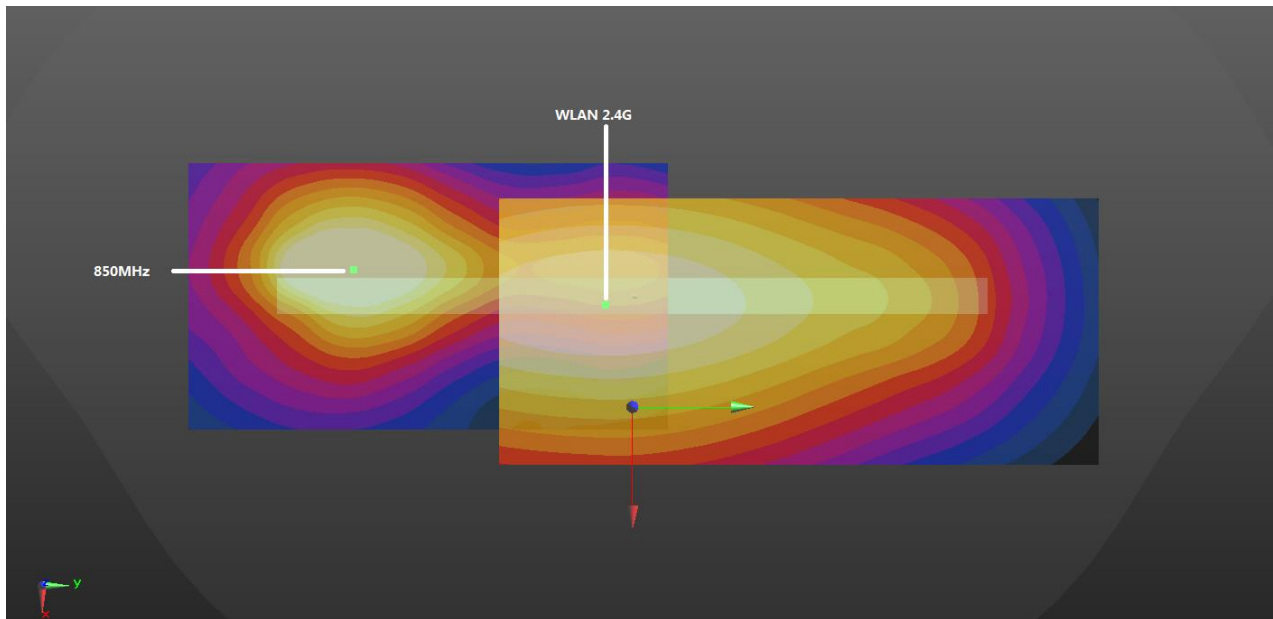

Right (5mm) + 2.4G (5mm)

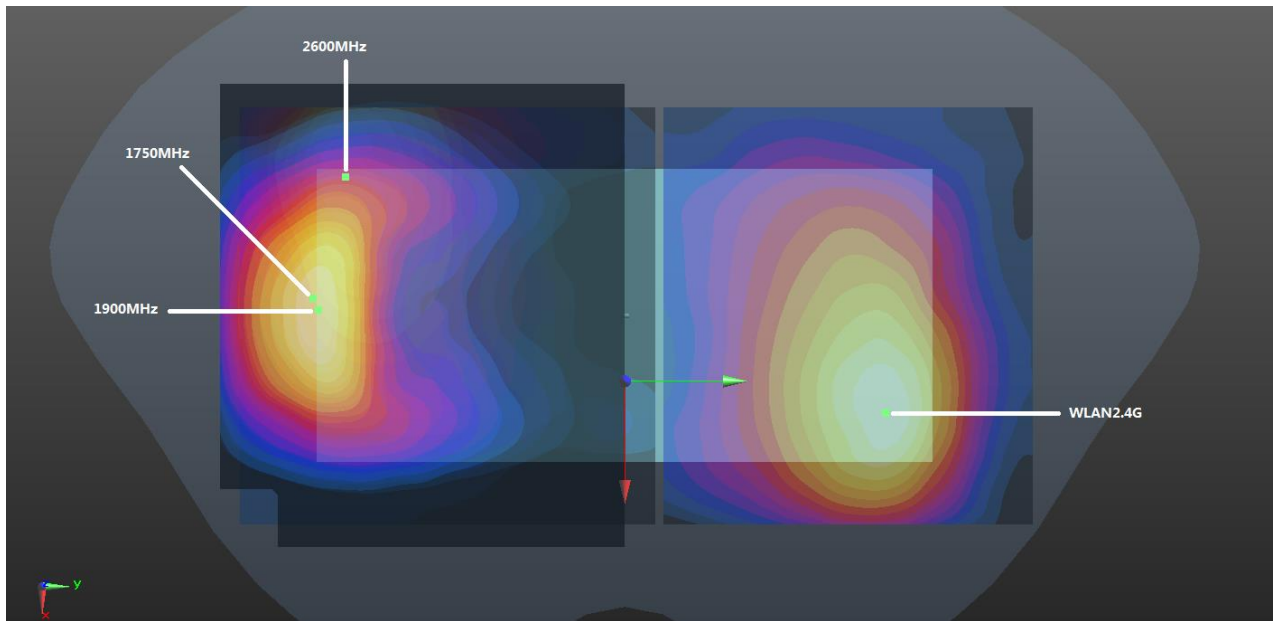

Front (0mm) + 2.4G (0mm)

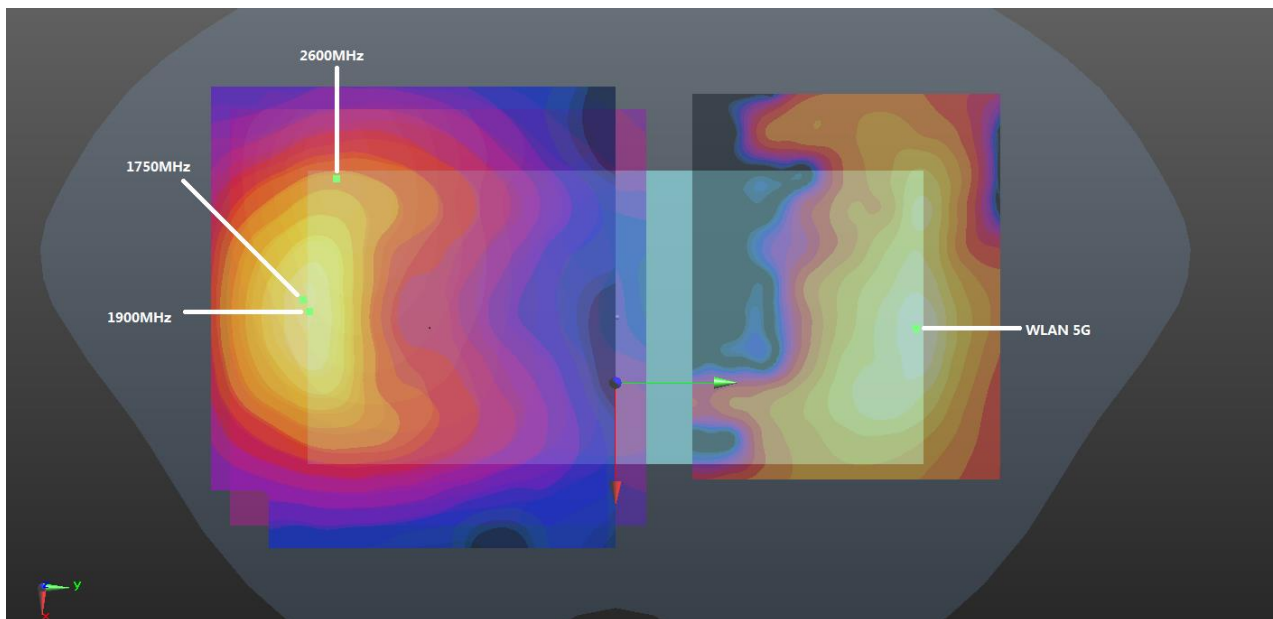

Front (0mm) + 5G (0mm)

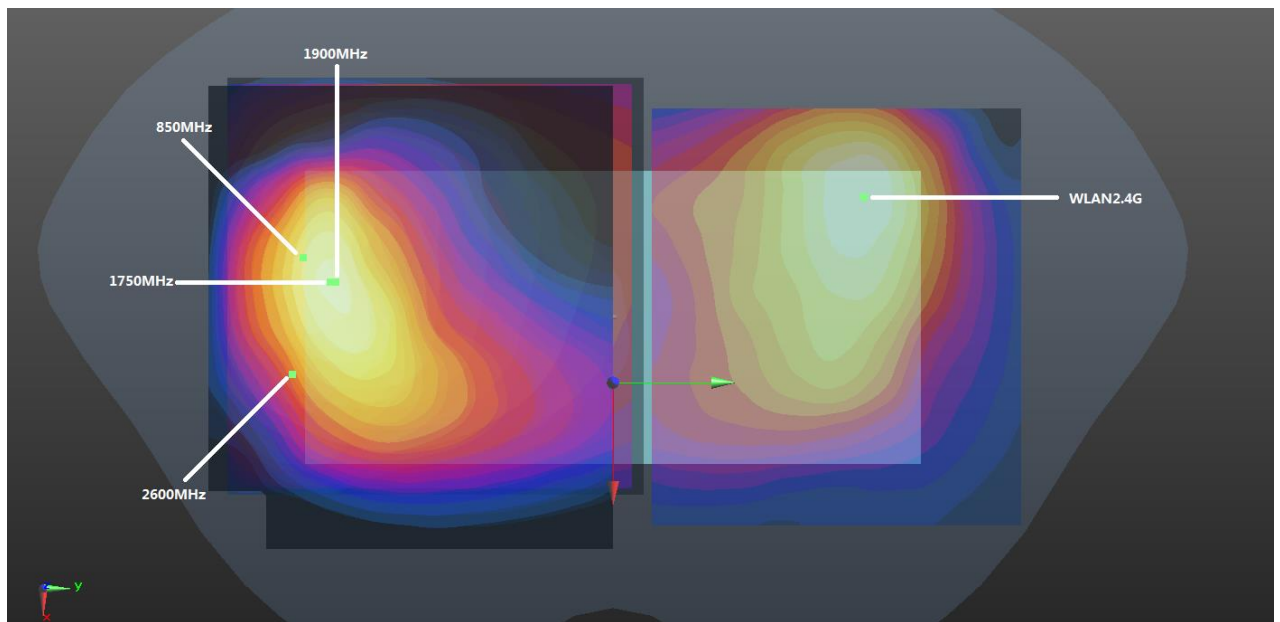

Back (0mm) + 2.4G (0mm)

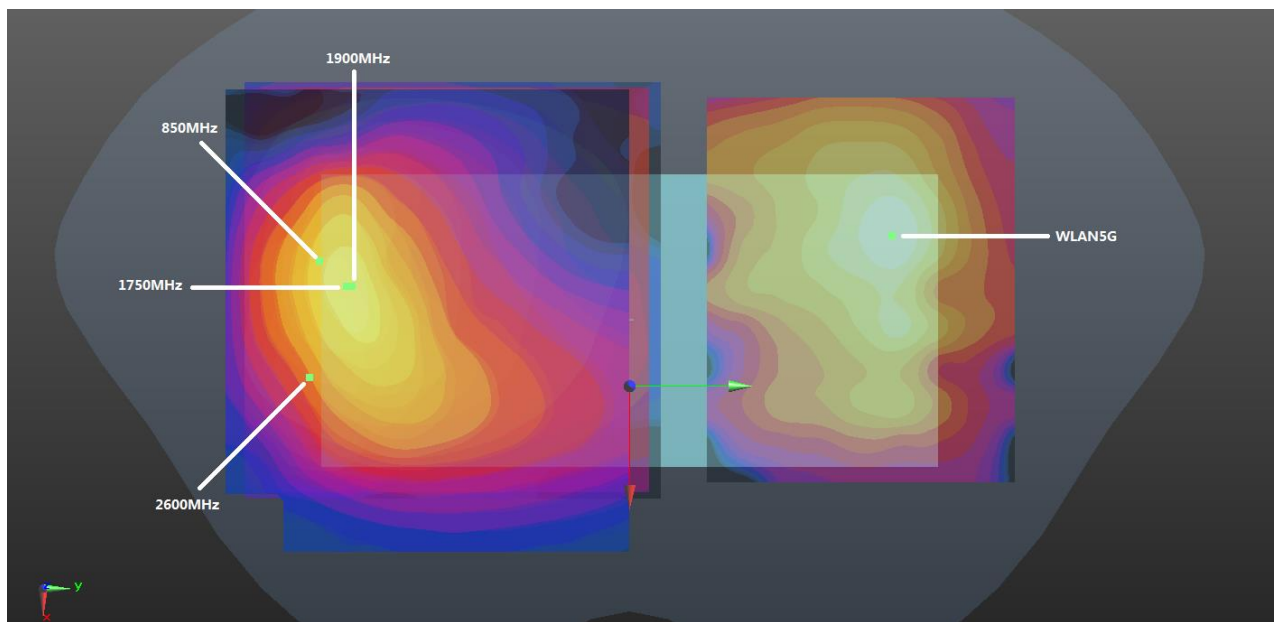

Back (0mm) + 5G (0mm)

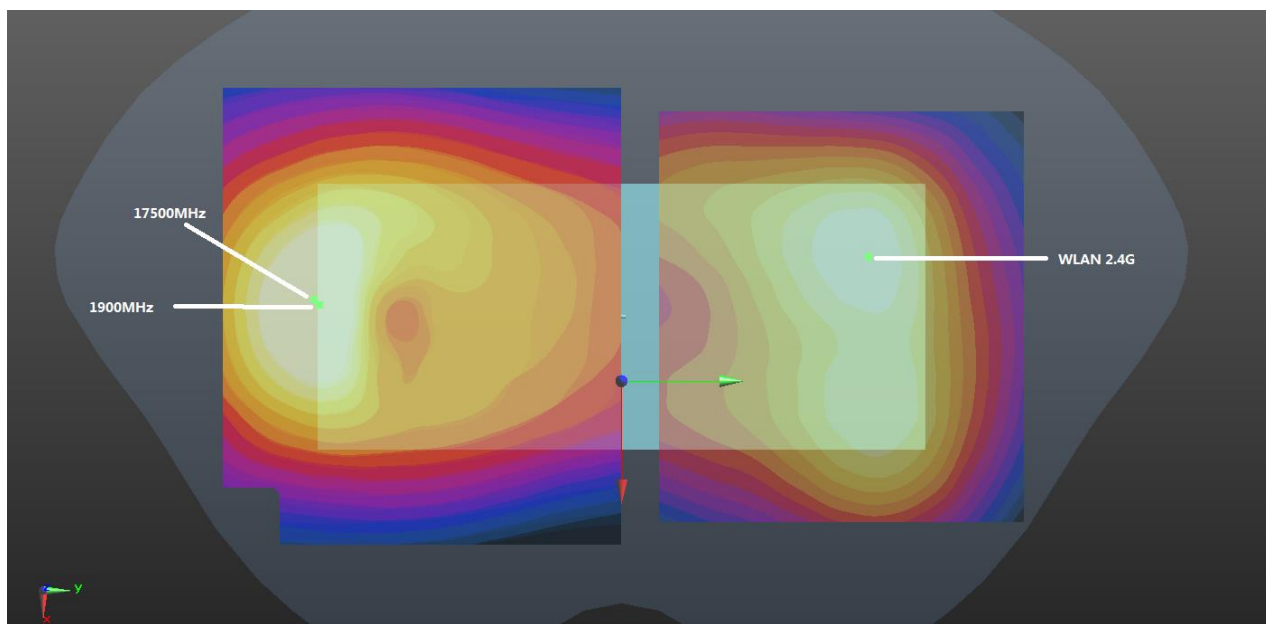

Front (12mm) + 2.4G (12mm)

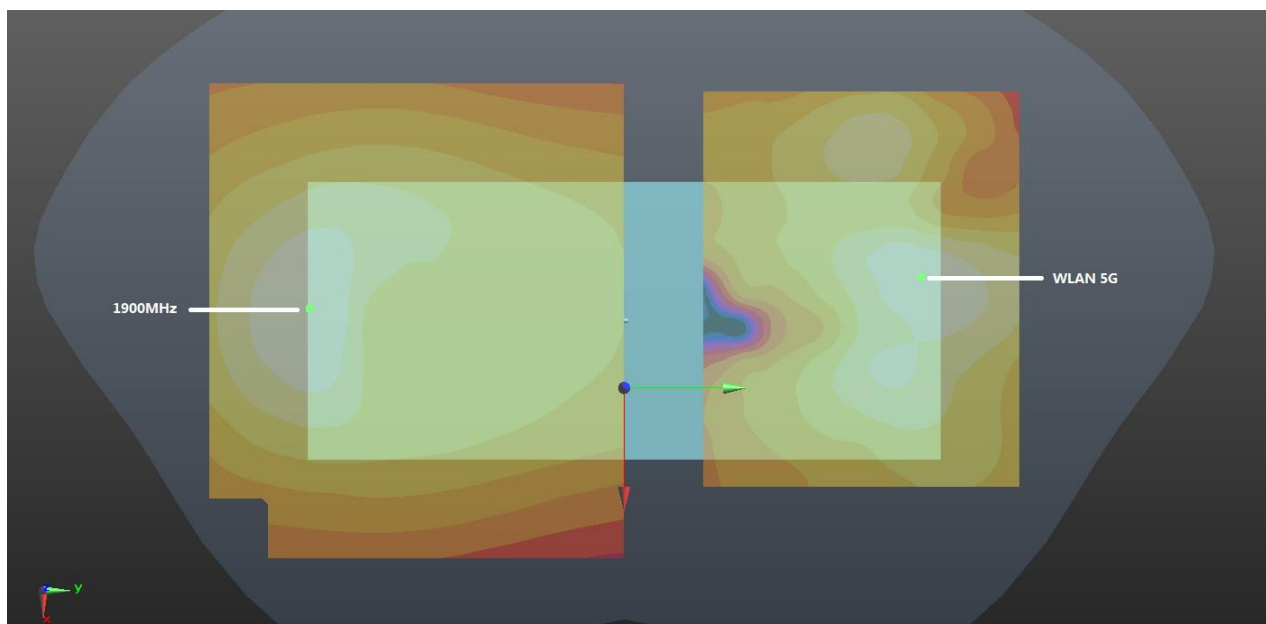

Front (12mm) + 5G (12mm)

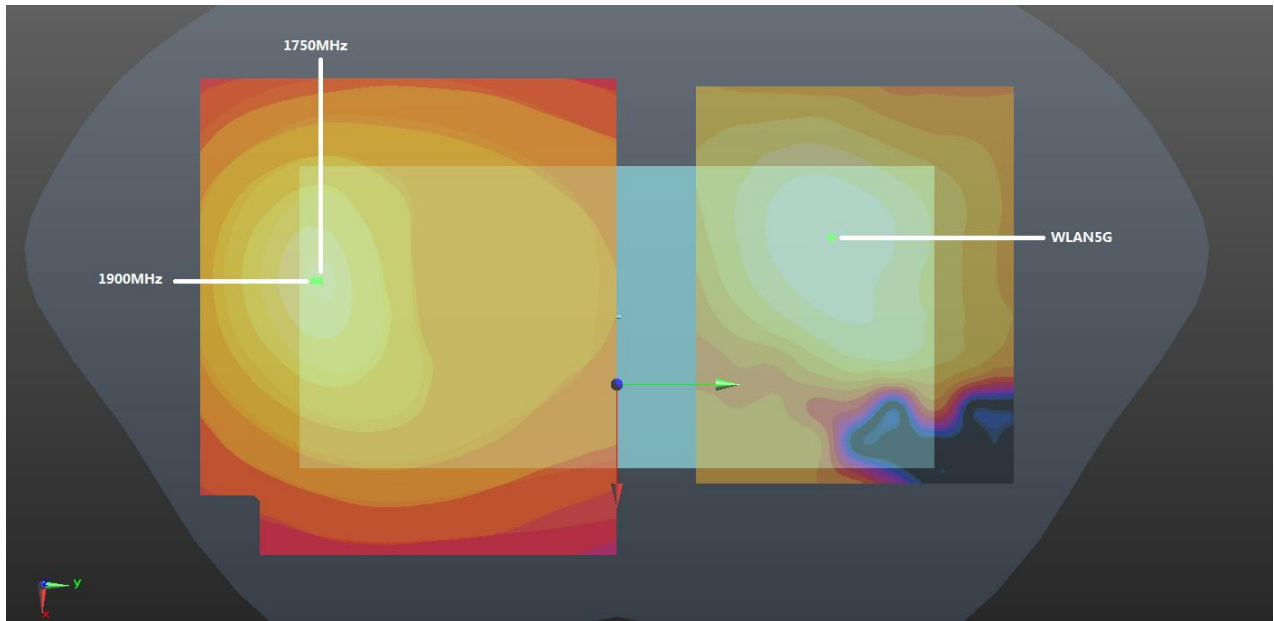

Back (18mm) + 5G (18MM)

5mm											
Case 1	Band	Position	SAR (W/kg)	Gap (mm)	SAR peak location (mm)			3D distance (mm)	Summed SAR (W/kg)	SPLSR Results	Simultaneous SAR
					X	Y	Z				
Case 1	GSM850	Front	0.508	5mm	-10.5	-82.5	-2.12	154.6	1.68	0.01	Not required
	WLAN2.4GHz		1.173	5mm	28.6	67	2.29				
Case 2	Band	Position	SAR (W/kg)	Gap (mm)	SAR peak location (mm)			3D distance (mm)	Summed SAR (W/kg)	SPLSR Results	Simultaneous SAR
					X	Y	Z				
Case 2	GSM850	Back	1.284	5mm	7.1	-76.6	-2.02	142.5	2.42	0.03	Not required
	WLAN2.4GHz		1.131	5mm	-44	56.4	1.75				
Case 3	Band	Position	SAR (W/kg)	Gap (mm)	SAR peak location (cm)			3D distance (mm)	Summed SAR (W/kg)	SPLSR Results	Simultaneous SAR
					X	Y	Z				
Case 3	GSM850	Back	1.284	5mm	7.1	-76.6	-2.02	145.2	2.46	0.03	Not required
	WLAN5GHz		1.176	5mm	-14.4	67	1.48				
Case 4	Band	Position	SAR (W/kg)	Gap (mm)	SAR peak location (mm)			3D distance (mm)	Summed SAR (W/kg)	SPLSR Results	Simultaneous SAR
					X	Y	Z				
Case 4	GSM850	Right Side	0.552	5mm	-5.4	-2.6	-2.96	64.4	1.61	0.03	Not required
	WLAN2.4GHz		1.057	5mm	-8	-66.8	2.07				
Case 5	Band	Position	SAR (W/kg)	Gap (mm)	SAR peak location (mm)			3D distance (mm)	Summed SAR (W/kg)	SPLSR Results	Simultaneous SAR
					X	Y	Z				
Case 5	GSM1900	Front	0.795	5mm	-1.3	-80.9	-2.17	151.0	1.97	0.02	Not required
	WLAN2.4GHz		1.173	5mm	28.6	67	2.29				
Case 6	Band	Position	SAR (W/kg)	Gap (mm)	SAR peak location (cm)			3D distance (mm)	Summed SAR (W/kg)	SPLSR Results	Simultaneous SAR
					X	Y	Z				
Case 6	GSM1900	Back	1.313	5mm	-2.5	-84.4	-2.11	146.8	2.44	0.03	Not required
	WLAN2.4GHz		1.131	5mm	-44	56.4	1.75				
Case 7	Band	Position	SAR (W/kg)	Gap (mm)	SAR peak location (mm)			3D distance (mm)	Summed SAR (W/kg)	SPLSR Results	Simultaneous SAR
					X	Y	Z				
Case 7	GSM1900	Back	1.313	5mm	-2.5	-84.4	-2.11	151.9	2.49	0.03	Not required
	WLAN5GHz		1.176	5mm	-14.4	67	1.48				

Case 8	Band	Position	SAR (W/kg)	Gap (mm)	SAR peak location (mm)			3D distance (mm)	Summed SAR (W/kg)	SPLSR Results	Simultaneous SAR
					X	Y	Z				
	WCDMA II	Front	0.867	5mm	0.2	-79.4	-2.19	149.2	2.04	0.02	Not required
WLAN2.4GHz	1.173		5mm	28.6	67	2.29					
Case 9	Band	Position	SAR (W/kg)	Gap (mm)	SAR peak location (cm)			3D distance (mm)	Summed SAR (W/kg)	SPLSR Results	Simultaneous SAR
					X	Y	Z				
	WCDMA II	Back	1.386	5mm	-12.1	-73.5	-2.31	133.8	2.52	0.03	Not required
WLAN2.4GHz	1.131		5mm	-44	56.4	1.75					
Case 10	Band	Position	SAR (W/kg)	Gap (mm)	SAR peak location (mm)			3D distance (mm)	Summed SAR (W/kg)	SPLSR Results	Simultaneous SAR
					X	Y	Z				
	WCDMA II	Back	1.386	5mm	-12.1	-73.5	-2.31	140.6	2.56	0.03	Not required
WLAN5GHz	1.176		5mm	-14.4	67	1.48					
Case 11	Band	Position	SAR (W/kg)	Gap (mm)	SAR peak location (mm)			3D distance (mm)	Summed SAR (W/kg)	SPLSR Results	Simultaneous SAR
					X	Y	Z				
	WCDMA IV	Front	0.931	5mm	-2.9	-82.3	-2.22	152.7	2.10	0.02	Not required
WLAN2.4GHz	1.173		5mm	28.6	67	2.29					
Case 12	Band	Position	SAR (W/kg)	Gap (mm)	SAR peak location (cm)			3D distance (mm)	Summed SAR (W/kg)	SPLSR Results	Simultaneous SAR
					X	Y	Z				
	WCDMA IV	Back	1.381	5mm	-9	-75	-2.12	136.0	2.51	0.03	Not required
WLAN2.4GHz	1.131		5mm	-44	56.4	1.75					
Case 13	Band	Position	SAR (W/kg)	Gap (mm)	SAR peak location (mm)			3D distance (mm)	Summed SAR (W/kg)	SPLSR Results	Simultaneous SAR
					X	Y	Z				
	WCDMA IV	Back	1.381	5mm	-9	-75	-2.12	142.1	2.56	0.03	Not required
WLAN5GHz	1.176		5mm	-14.4	67	1.48					
Case 14	Band	Position	SAR (W/kg)	Gap (mm)	SAR peak location (mm)			3D distance (mm)	Summed SAR (W/kg)	SPLSR Results	Simultaneous SAR
					X	Y	Z				
	WCDMA V	Front	0.795	5mm	-9.1	-83.5	-2.15	155.2	1.97	0.02	Not required
WLAN2.4GHz	1.173		5mm	28.6	67	2.29					



Case	Band	Position	SAR (W/kg)	Gap (mm)	SAR peak location (cm)			3D distance (mm)	Summed SAR (W/kg)	SPLSR Results	Simultaneous SAR
					X	Y	Z				
					SAR peak location (mm)						
Case 15	WCDMA V	Back	1.296	5mm	12.4	-82	2.24	149.5	2.43	0.03	Not required
	WLAN2.4GHz		1.131	5mm	-44	56.4	1.75				
Case 16	WCDMA V	Back	1.296	5mm	12.4	-82	2.24	151.4	2.47	0.03	Not required
	WLAN5GHz		1.176	5mm	-14.4	67	1.48				
Case 17	WCDMA V	Right Side	0.66	5mm	-9	-3	-2.87	64.0	1.72	0.04	Not required
	WLAN2.4GHz		1.057	5mm	-8	-66.8	2.07				
Case 18	LTE Band 2	Front	1.019	5mm	-3	-83.8	-2.1	154.1	2.19	0.02	Not required
	WLAN2.4GHz		1.173	5mm	28.6	67	2.29				
Case 19	LTE Band 2	Back	1.215	5mm	-9.1	-77.9	-2.19	138.8	2.35	0.03	Not required
	WLAN2.4GHz		1.131	5mm	-44	56.4	1.75				
Case 20	LTE Band 2	Back	1.215	5mm	-9.1	-77.9	-2.19	145.0	2.39	0.03	Not required
	WLAN5GHz		1.176	5mm	-14.4	67	1.48				
Case 21	LTE Band 7	Front	0.618	5mm	-30	-75.4	-1.97	154.0	1.79	0.02	Not required
	WLAN2.4GHz		1.173	5mm	28.6	67	2.29				

Case 22	Band	Position	SAR (W/kg)	Gap (mm)	SAR peak location (mm)			3D distance (mm)	Summed SAR (W/kg)	SPLSR Results	Simultaneous SAR
					X	Y	Z				
	LTE Band 7	Back	1.294	5mm	24	-75.2	-1.69	148.2	2.43	0.03	Not required
WLAN2.4GHz	1.131		5mm	-44	56.4	1.75					

Case 23	Band	Position	SAR (W/kg)	Gap (mm)	SAR peak location (cm)			3D distance (mm)	Summed SAR (W/kg)	SPLSR Results	Simultaneous SAR
					X	Y	Z				
	LTE Band 7	Back	1.294	5mm	24	-75.2	-1.69	147.3	2.47	0.03	Not required
WLAN5GHz	1.176		5mm	-14.4	67	1.48					

Case 24	Band	Position	SAR (W/kg)	Gap (mm)	SAR peak location (mm)			3D distance (mm)	Summed SAR (W/kg)	SPLSR Results	Simultaneous SAR
					X	Y	Z				
	LTE Band 12	Front	0.563	5mm	-9.2	-83.6	2.08	155.3	1.74	0.01	Not required
WLAN2.4GHz	1.173		5mm	28.6	67	2.29					

Case 25	Band	Position	SAR (W/kg)	Gap (mm)	SAR peak location (mm)			3D distance (mm)	Summed SAR (W/kg)	SPLSR Results	Simultaneous SAR	
					X	Y	Z					
Plot No	282	LTE Band 12	Back	1.003	5mm	11	-77.4	2.25	144.7	2.13	0.02	Not required
605	WLAN2.4GHz	1.131		5mm	-44	56.4	1.75					

Case 26	Band	Position	SAR (W/kg)	Gap (mm)	SAR peak location (cm)			3D distance (mm)	Summed SAR (W/kg)	SPLSR Results	Simultaneous SAR
					X	Y	Z				
	LTE Band 12	Back	1.003	5mm	11	-77.4	2.25	146.6	2.18	0.02	Not required
WLAN5GHz	1.176		5mm	-14.4	67	1.48					

Case 27	Band	Position	SAR (W/kg)	Gap (mm)	SAR peak location (mm)			3D distance (mm)	Summed SAR (W/kg)	SPLSR Results	Simultaneous SAR
					X	Y	Z				
	LTE Band 26	Front	1.117	5mm	-8.9	-84	-2.16	155.7	2.29	0.02	Not required
WLAN2.4GHz	1.173		5mm	28.6	67	2.29					

Case 28	Band	Position	SAR (W/kg)	Gap (mm)	SAR peak location (mm)			3D distance (mm)	Summed SAR (W/kg)	SPLSR Results	Simultaneous SAR
					X	Y	Z				
	LTE Band 26	Back	1.14	5mm	7.3	-78.4	-2.1	144.3	2.27	0.02	Not required
	WLAN2.4GHz		1.131	5mm	-44	56.4	1.75				
LTE Band 26	Back	1.063	5mm	4	-79.9	-2.12	144.6	2.19	0.02	Not required	
WLAN2.4GHz		1.131	5mm	-44	56.4	1.75					



Case	Band	Position	SAR (W/kg)	Gap (mm)	SAR peak location (cm)			3D distance (mm)	Summed SAR (W/kg)	SPLSR Results	Simultaneous SAR
					X	Y	Z				
					SAR peak location (mm)						
Case 29	LTE Band 26	Back	1.14	5mm	7.3	-78.4	-2.1	147.1	2.32	0.02	Not required
	WLAN5GHz		1.176	5mm	-14.4	67	1.48				
	LTE Band 26	Back	1.063	5mm	4	-79.9	-2.12	148.1	2.24	0.02	Not required
	WLAN5GHz		1.176	5mm	-14.4	67	1.48				
Case 30	LTE Band 26	Right Side	0.723	5mm	-6	-6	-2.95	61.0	1.78	0.04	Not required
	WLAN2.4GHz		1.057	5mm	-8	-66.8	2.07				
Case 31	LTE Band 66	Front	0.706	5mm	-4.4	-80.8	-2.22	151.5	1.88	0.02	Not required
	WLAN2.4GHz		1.173	5mm	28.6	67	2.29				
Case 32	LTE Band 66	Back	1.38	5mm	-13.6	-76.5	-2.32	136.4	2.51	0.03	Not required
	WLAN2.4GHz		1.131	5mm	-44	56.4	1.75				
Case 33	LTE Band 66	Back	1.38	5mm	-13.6	-76.5	-2.32	143.6	2.56	0.03	Not required
	WLAN5GHz		1.176	5mm	-14.4	67	1.48				
Case 34	LTE Band 41	Front	0.878	5mm	-31	-70	-2.47	149.5	2.05	0.02	Not required
	WLAN2.4GHz		1.173	5mm	28.6	67	2.29				
Case 35	LTE Band 41	Back	1.324	5mm	20.8	-63.2	-1.92	136.1	2.46	0.03	Not required
	WLAN2.4GHz		1.131	5mm	-44	56.4	1.75				
Case 36	LTE Band 41	Back	1.324	5mm	20.8	-63.2	-1.92	134.9	2.50	0.03	Not required
	WLAN5GHz		1.176	5mm	-14.4	67	1.48				

18mm&12mm											
Case 37	Band	Position	SAR (W/kg)	Gap (mm)	SAR peak location (mm)			3D distance (mm)	Summed SAR (W/kg)	SPLSR Results	Simultaneous SAR
					X	Y	Z				
	GSM1900	Back	0.636	18mm	-9	-74.9	-2.12	129.8	1.65	0.02	Not required
WLAN5GHz	1.01		18mm	-13.6	54.8	1.75					
Case 38	Band	Position	SAR (W/kg)	Gap (mm)	SAR peak location (cm)			3D distance (mm)	Summed SAR (W/kg)	SPLSR Results	Simultaneous SAR
					X	Y	Z				
	WCDMA II	Front	1.01	12mm	-1.4	-79.5	-2.08	144.5	1.86	0.02	Not required
WLAN2.4G	0.847		12mm	-16.6	64.2	-3.48					
Case 39	Band	Position	SAR (W/kg)	Gap (mm)	SAR peak location (mm)			3D distance (mm)	Summed SAR (W/kg)	SPLSR Results	Simultaneous SAR
					X	Y	Z				
	WCDMA II	Front	1.01	12mm	-1.4	-79.5	-2.08	155.4	1.60	0.01	Not required
WLAN5GHz	0.585		12mm	3.4	75.8	1.54					
Case 40	Band	Position	SAR (W/kg)	Gap (mm)	SAR peak location (mm)			3D distance (mm)	Summed SAR (W/kg)	SPLSR Results	Simultaneous SAR
					X	Y	Z				
	WCDMA II	Back	0.904	18mm	-10.6	-73.5	-2.22	128.4	1.91	0.02	Not required
WLAN5GHz	1.01		18mm	-13.6	54.8	1.75					
Case 41	Band	Position	SAR (W/kg)	Gap (mm)	SAR peak location (cm)			3D distance (mm)	Summed SAR (W/kg)	SPLSR Results	Simultaneous SAR
					X	Y	Z				
	WCDMA IV	Front	0.998	12mm	-2.9	-81	-2.09	145.9	1.85	0.02	Not required
WLAN2.4G	0.847		12mm	-16.6	64.2	-3.48					
Case 42	Band	Position	SAR (W/kg)	Gap (mm)	SAR peak location (mm)			3D distance (mm)	Summed SAR (W/kg)	SPLSR Results	Simultaneous SAR
					X	Y	Z				
	WCDMA IV	Back	0.82	18mm	-9	-73.4	-2.21	128.3	1.83	0.02	Not required
WLAN5GHz	1.01		18mm	-13.6	54.8	1.75					
Case 43	Band	Position	SAR (W/kg)	Gap (mm)	SAR peak location (mm)			3D distance (mm)	Summed SAR (W/kg)	SPLSR Results	Simultaneous SAR
					X	Y	Z				
	LTE Band 66	Front	0.813	12mm	-5.9	-79.5	-2.07	144.1	1.66	0.01	Not required
WLAN2.4G	0.847		12mm	-16.6	64.2	-3.48					



0mm											
Case 44	Band	Position	SAR (W/kg)	Gap	SAR peak location (cm)			3D distance (mm)	Summed SAR (W/kg)	SPLSR Results	Simultaneous SAR
	GSM1900			(mm)	X	Y	Z				
			WLAN2.4GHz	(mm)	X	Y	Z				
	GSM1900	Front	2.486	0mm	0.1	-81.1	-1.75	153.8	4.93	0.07	Not required
	WLAN2.4GHz		2.446	0mm	25.2	70.6	-3.01				

Case 45	Band	Position	SAR (W/kg)	Gap	SAR peak location (mm)			3D distance (mm)	Summed SAR (W/kg)	SPLSR Results	Simultaneous SAR
	GSM1900			(mm)	X	Y	Z				
			WLAN5GHz	(mm)	X	Y	Z				
	GSM1900	Front	2.486	0mm	0.1	-81.1	-1.75	159.6	4.18	0.05	Not required
	WLAN5GHz		1.694	0mm	12.6	78	1.91				

Case 46	Band	Position	SAR (W/kg)	Gap	SAR peak location (mm)			3D distance (mm)	Summed SAR (W/kg)	SPLSR Results	Simultaneous SAR
	GSM1900			(mm)	X	Y	Z				
			WLAN2.4GHz	(mm)	X	Y	Z				
	GSM1900	Back	2.995	0mm	7	-65.6	-1.7	136.0	5.43	0.09	Not required
	WLAN2.4GHz		2.434	0mm	-30.2	65.2	-3.12				

Case 47	Band	Position	SAR (W/kg)	Gap	SAR peak location (cm)			3D distance (mm)	Summed SAR (W/kg)	SPLSR Results	Simultaneous SAR
	GSM1900			(mm)	X	Y	Z				
			WLAN5GHz	(mm)	X	Y	Z				
	GSM1900	Back	2.995	0mm	7	-65.6	-1.7	137.8	5.79	0.10	Not required
	WLAN5GHz		2.793	0mm	-14.8	70.4	1.98				

Case 48	Band	Position	SAR (W/kg)	Gap	SAR peak location (mm)			3D distance (mm)	Summed SAR (W/kg)	SPLSR Results	Simultaneous SAR
	WCDMA II			(mm)	X	Y	Z				
			WLAN2.4GHz	(mm)	X	Y	Z				
	WCDMA II	Front	2.572	0mm	-1.4	-81	-2.03	153.9	5.02	0.07	Not required
	WLAN2.4GHz		2.446	0mm	25.2	70.6	-3.01				

Case 49	Band	Position	SAR (W/kg)	Gap	SAR peak location (mm)			3D distance (mm)	Summed SAR (W/kg)	SPLSR Results	Simultaneous SAR
	WCDMA II			(mm)	X	Y	Z				
			WLAN5GHz	(mm)	X	Y	Z				
	WCDMA II	Front	2.572	0mm	-1.4	-81	-2.03	159.7	4.27	0.06	Not required
	WLAN5GHz		1.694	0mm	12.6	78	1.91				

Case 50	Band	Position	SAR (W/kg)	Gap	SAR peak location (cm)			3D distance (mm)	Summed SAR (W/kg)	SPLSR Results	Simultaneous SAR
	WCDMA II			(mm)	X	Y	Z				
			WLAN2.4GHz	(mm)	X	Y	Z				
	WCDMA II	Back	2.95	0mm	-10.6	-73.5	-2.17	140.1	5.38	0.09	Not required
	WLAN2.4GHz		2.434	0mm	-30.2	65.2	-3.12				



Case	Band	Position	SAR (W/kg)	Gap (mm)	SAR peak location (mm)			3D distance (mm)	Summed SAR (W/kg)	SPLSR Results	Simultaneous SAR
					X	Y	Z				
					SAR peak location (cm)						
Case 51	WCDMA II	Back	2.95	0mm	-10.6	-73.5	-2.17	144.0	5.74	0.10	Not required
	WLAN5GHz		2.793	0mm	-14.8	70.4	1.98				
Case 52	WCDMA IV	Front	2.109	0mm	-2.9	-81	-2.06	154.2	4.56	0.06	Not required
	WLAN2.4GHz		2.446	0mm	25.2	70.6	-3.01				
Case 53	WCDMA IV	Back	3.301	0mm	-12.2	-73.5	-2.13	139.9	5.74	0.10	Not required
	WLAN2.4GHz		2.434	0mm	-30.2	65.2	-3.12				
Case 54	WCDMA IV	Back	3.301	0mm	-12.2	-73.5	-2.13	144.0	6.09	0.10	Not required
	WLAN5GHz		2.793	0mm	-14.8	70.4	1.98				
Case 55	WCDMA V	Back	2.458	0mm	-21.9	-78.9	2.09	144.4	4.89	0.07	Not required
	WLAN2.4GHz		2.434	0mm	-30.2	65.2	-3.12				
Case 56	WCDMA V	Back	2.458	0mm	-21.9	-78.9	2.09	149.5	5.25	0.08	Not required
	WLAN5GHz		2.793	0mm	-14.8	70.4	1.98				
Case 57	LTE Band 2	Front	1.847	0mm	-1.5	-78	-2.06	151.0	4.29	0.06	Not required
	WLAN2.4GHz		2.446	0mm	25.2	70.6	-3.01				

Case	Band	Position	SAR (W/kg)	Gap (mm)	SAR peak location (mm)			3D distance (mm)	Summed SAR (W/kg)	SPLSR Results	Simultaneous SAR
					X	Y	Z				
					SAR peak location (cm)						
Case 58	LTE Band 2	Back	2.665	0mm	-2.3	-70.9	-1.66	138.9	5.10	0.08	Not required
	WLAN2.4GHz		2.434	0mm	-30.2	65.2	-3.12				
Case 59	LTE Band 2	Back	2.665	0mm	-2.3	-70.9	-1.66	141.9	5.46	0.09	Not required
	WLAN5GHz		2.793	0mm	-14.8	70.4	1.98				
Case 60	LTE Band 7	Front	3.136	0mm	-36	-73.4	-2.34	156.5	5.58	0.08	Not required
	WLAN2.4GHz		2.446	0mm	25.2	70.6	-3.01				
Case 61	LTE Band 7	Front	3.136	0mm	-36	-73.4	-2.34	159.1	4.83	0.07	Not required
	WLAN5GHz		1.694	0mm	12.6	78	1.91				
Case 62	LTE Band 7	Back	3.297	0mm	19.8	-82.2	2.66	155.8	5.73	0.09	Not required
	WLAN2.4GHz		2.434	0mm	-30.2	65.2	-3.12				
Case 63	LTE Band 7	Back	3.297	0mm	19.8	-82.2	2.66	156.5	6.09	0.10	Not required
	WLAN5GHz		2.793	0mm	-14.8	70.4	1.98				
Case 64	LTE Band 66	Front	1.91	0mm	0	-79.6	-2.11	152.3	4.36	0.06	Not required
	WLAN2.4GHz		2.446	0mm	25.2	70.6	-3.01				

Case 65	Band	Position	SAR (W/kg)	Gap (mm)	SAR peak location (cm)			3D distance (mm)	Summed SAR (W/kg)	SPLSR Results	Simultaneous SAR
					X	Y	Z				
	LTE Band 66	Back	3.016	0mm	-15.2	-72	-2.09	138.0	5.45	0.09	Not required
	WLAN2.4GHz		2.434	0mm	-30.2	65.2	-3.12				

Case 66	Band	Position	SAR (W/kg)	Gap (mm)	SAR peak location (mm)			3D distance (mm)	Summed SAR (W/kg)	SPLSR Results	Simultaneous SAR
					X	Y	Z				
	LTE Band 66	Back	3.016	0mm	-15.2	-72	-2.09	142.5	5.81	0.10	Not required
	WLAN5GHz		2.793	0mm	-14.8	70.4	1.98				

Case 67	Band	Position	SAR (W/kg)	Gap (mm)	SAR peak location (mm)			3D distance (mm)	Summed SAR (W/kg)	SPLSR Results	Simultaneous SAR
					X	Y	Z				
	LTE Band 41	Front	1.737	0mm	-28.8	-71.2	-2.25	151.7	4.18	0.06	Not required
	WLAN2.4GHz		2.446	0mm	25.2	70.6	-3.01				

Case 68	Band	Position	SAR (W/kg)	Gap (mm)	SAR peak location (cm)			3D distance (mm)	Summed SAR (W/kg)	SPLSR Results	Simultaneous SAR
					X	Y	Z				
	LTE Band 41	Back	2.2	0mm	15.2	-79	2.68	151.3	4.63	0.07	Not required
	WLAN2.4GHz		2.434	0mm	-30.2	65.2	-3.12				

Case 69	Band	Position	SAR (W/kg)	Gap (mm)	SAR peak location (mm)			3D distance (mm)	Summed SAR (W/kg)	SPLSR Results	Simultaneous SAR
					X	Y	Z				
	LTE Band 41	Back	2.2	0mm	15.2	-79	2.68	152.4	4.99	0.07	Not required
	WLAN5GHz		2.793	0mm	-14.8	70.4	1.98				



16. Supplemental Tuner Tests Results

General Note:

1. The following test procedure was followed to demonstrate that the SAR results in this report represent the appropriate SAR test conditions. For bands with dynamic tuning implemented, SAR will be measured according to the required FCC SAR test procedures with the dynamic tuner active to allow the device to automatically tune to the antenna state for the respective RF exposure test configurations. Additional single point SAR time-sweep measurements will be evaluated for other tuner states to determine that the other tuner configurations would result in equivalent or lower SAR values. The additional tuner hardware has no influence to the antenna characteristics, other than impedance matching.
2. To evaluate all of the tuner states, the 144 tuner states are divided evenly among bands (except for LTE band7/38/41), mode and exposure combinations so that at least one single point SAR measurement is measured in each configuration. Single point time-sweep measurements will be performed at the peak SAR location determined by the zoom scan of the configuration with the highest reported SAR for each combination. The tuner state will be established remotely so that the device is not moved for the entire series of single point SAR for the tuner states in each combination. The SAR probe will remain stationary at the same position throughout the entire series of single point measurements for each combination.
3. This device supports LTE B4 / B5 / B17 and B66 / B26 / B12. Since the supported frequency span for LTE B4 / B5 / B17 falls completely within the supports frequency span for LTE B66 / B26 / B12, both LTE bands have the same target power, and both LTE bands share the same transmission path; therefore, chose LTE B66 / B26 / B12 for dynamic antenna analysis.
4. According to workshop 2019, if any single point SAR measurement result is $> 1.2 \text{ W/kg}$ for a band/exposure condition combination set, all supported tuner states are evaluated with single point SAR measurements for the combination. So we verified the single point SAR that bands with SAR value high than 1.2 W/Kg .
5. The operational decryption contains more information about the design and implementation of the dynamic antenna tuning.

16.1 Supplemental Tuner Head & Body SAR Results

Please refer to Appendix F.

Test Engineer: Nick Hu, Yuan Zhao, Jiaxing Chang, Yuankai Kong



17. Uncertainty Assessment

Per KDB 865664 D01 SAR measurement 100MHz to 6GHz, when the highest measured 1-g SAR within a frequency band is < 1.5 W/kg and the measured 10-g SAR within a frequency band is < 3.75 W/kg. The expanded SAR measurement uncertainty must be $\leq 30\%$, for a confidence interval of $k = 2$. If these conditions are met, extensive SAR measurement uncertainty analysis described in IEEE Std 1528-2013 is not required in SAR reports submitted for equipment approval. For this device, the highest measured 1-g SAR is less 1.5W/kg and highest measured 10-g SAR is less 3.75W/kg. Therefore, the measurement uncertainty table is not required in this report.

18. References

- [1] FCC 47 CFR Part 2 "Frequency Allocations and Radio Treaty Matters; General Rules and Regulations"
- [2] ANSI/IEEE Std. C95.1-1992, "IEEE Standard for Safety Levels with Respect to Human Exposure to Radio Frequency Electromagnetic Fields, 3 kHz to 300 GHz", September 1992
- [3] IEEE Std. 1528-2013, "IEEE Recommended Practice for Determining the Peak Spatial-Average Specific Absorption Rate (SAR) in the Human Head from Wireless Communications Devices: Measurement Techniques", Sep 2013
- [4] SPEAG DASY System Handbook
- [5] FCC KDB 865664 D01 v01r04, "SAR Measurement Requirements for 100 MHz to 6 GHz", Aug 2015.
- [6] FCC KDB 865664 D02 v01r02, "RF Exposure Compliance Reporting and Documentation Considerations" Oct 2015.
- [7] FCC KDB 447498 D01 v06, "Mobile and Portable Device RF Exposure Procedures and Equipment Authorization Policies", Oct 2015
- [8] FCC KDB 648474 D04 v01r03, "SAR Evaluation Considerations for Wireless Handsets", Oct 2015.
- [9] FCC KDB 248227 D01 v02r02, "SAR Guidance for IEEE 802.11 (WiFi) Transmitters", Oct 2015.
- [10] FCC KDB 616217 D04 v01r02, "SAR Evaluation Considerations for Laptop, Notebook, Netbook and Tablet Computers", Oct 2015
- [11] FCC KDB 941225 D01 v03r01, "3G SAR MEAUREMENT PROCEDURES", Oct 2015
- [12] FCC KDB 941225 D05 v02r05, "SAR Evaluation Considerations for LTE Devices", Dec 2015
- [13] FCC KDB 941225 D05A v01r02, "Rel. 10 LTE SAR Test Guidance and KDB Inquiries", Oct 2015
- [14] FCC KDB 941225 D06 v02r01, "SAR Evaluation Procedures for Portable Devices with Wireless Router Capabilities", Oct 2015.

-----THE END-----



Appendix A. Plots of System Performance Check

The plots are shown as follows.

System Check_Head_750MHz

DUT: D750V2 - SN:1087

Communication System: UID 0, CW (0); Frequency: 750 MHz; Duty Cycle: 1:1

Medium: HSL_750 Medium parameters used: $f = 750$ MHz; $\sigma = 0.901$ S/m; $\epsilon_r = 42.407$; $\rho = 1000$ kg/m³

Ambient Temperature : 23.2 °C ; Liquid Temperature : 22.7 °C

DASY5 Configuration:

- Probe: ES3DV3 - SN3293; ConvF(6.56, 6.56, 6.56); Calibrated: 2019.11.25
- Sensor-Surface: 3mm (Mechanical Surface Detection)
- Electronics: DAE4 Sn1338; Calibrated: 2019.11.20
- Phantom: SAM2; Type: SAM; Serial: TP-1754
- Measurement SW: DASY52, Version 52.10 (1); SEMCAD X Version 14.6.11 (7439)

Pin=250mW/Area Scan (61x61x1): Interpolated grid: dx=1.500 mm, dy=1.500 mm
Maximum value of SAR (interpolated) = 2.45 W/kg

Pin=250mW/Zoom Scan (5x5x7)/Cube 0: Measurement grid: dx=8mm, dy=8mm, dz=5mm
Reference Value = 53.78 V/m; Power Drift = -0.01 dB
Peak SAR (extrapolated) = 3.09 W/kg
SAR(1 g) = 2.11 W/kg; SAR(10 g) = 1.4 W/kg
Maximum value of SAR (measured) = 2.46 W/kg

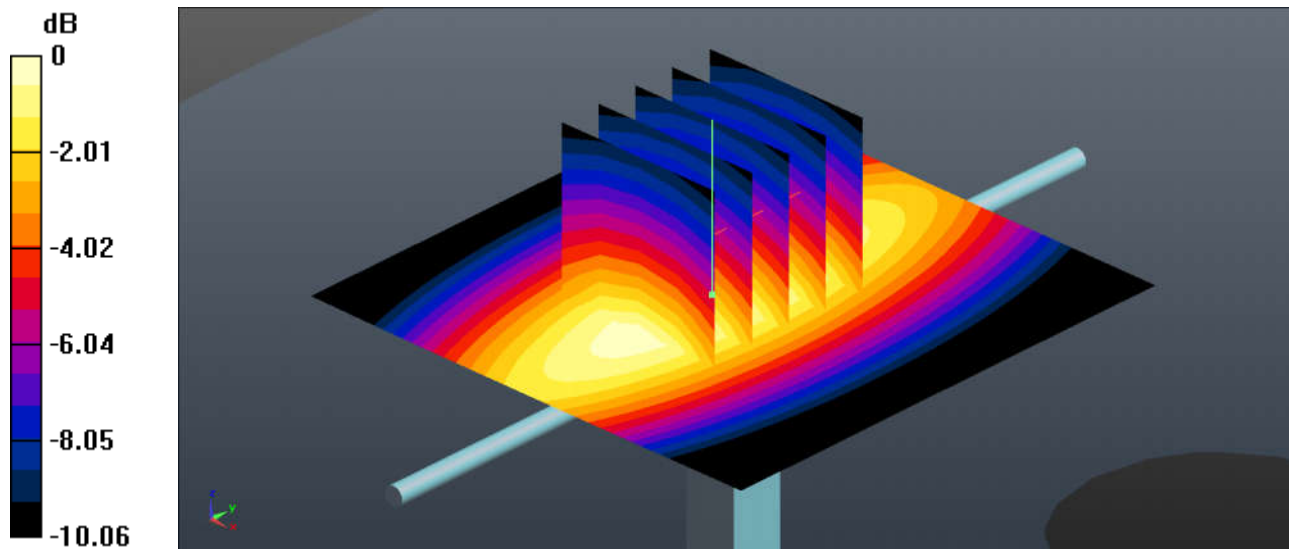

0 dB = 2.46 W/kg = 3.91 dBW/kg

System Check_Head_835MHz

DUT: D835V2 - SN:4d151

Communication System: UID 0, CW (0); Frequency: 835 MHz; Duty Cycle: 1:1

Medium: HSL_835 Medium parameters used: $f = 835 \text{ MHz}$; $\sigma = 0.905 \text{ S/m}$; $\epsilon_r = 41.314$; $\rho = 1000 \text{ kg/m}^3$

Ambient Temperature : $23.3 \text{ }^\circ\text{C}$; Liquid Temperature : $22.7 \text{ }^\circ\text{C}$

DASY5 Configuration:

- Probe: ES3DV3 - SN3293; ConvF(6.39, 6.39, 6.39); Calibrated: 2019.11.25
- Sensor-Surface: 3mm (Mechanical Surface Detection)
- Electronics: DAE4 Sn1338; Calibrated: 2019.11.20
- Phantom: SAM1; Type: SAM; Serial: TP-1753
- Measurement SW: DASY52, Version 52.10 (1); SEMCAD X Version 14.6.11 (7439)

Pin=250mW/Area Scan (61x61x1): Interpolated grid: $dx=1.500 \text{ mm}$, $dy=1.500 \text{ mm}$

Maximum value of SAR (interpolated) = 3.20 W/kg

Pin=250mW/Zoom Scan (5x5x7)/Cube 0: Measurement grid: $dx=8\text{mm}$, $dy=8\text{mm}$, $dz=5\text{mm}$

Reference Value = 61.03 V/m ; Power Drift = 0.06 dB

Peak SAR (extrapolated) = 3.58 W/kg

SAR(1 g) = 2.42 W/kg ; SAR(10 g) = 1.59 W/kg

Maximum value of SAR (measured) = 3.21 W/kg

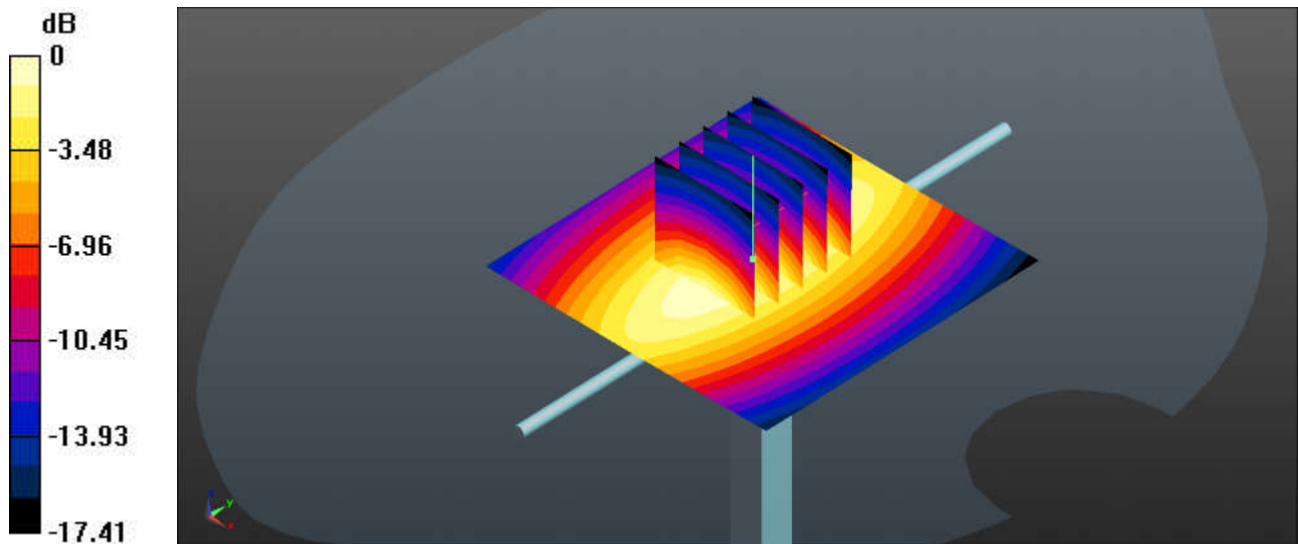

$0 \text{ dB} = 3.20 \text{ W/kg} = 5.05 \text{ dBW/kg}$

System Check_Head_1750MHz

DUT: D1750V2 - SN:1090

Communication System: UID 0, CW (0); Frequency: 1750 MHz; Duty Cycle: 1:1

Medium: HSL_1750 Medium parameters used: $f = 1750$ MHz; $\sigma = 1.363$ S/m; $\epsilon_r = 39.029$; $\rho = 1000$ kg/m³

Ambient Temperature : 23.3 °C; Liquid Temperature : 22.6 °C

DASY5 Configuration:

- Probe: ES3DV3 - SN3293; ConvF(5.53, 5.53, 5.53); Calibrated: 2019.11.25
- Sensor-Surface: 3mm (Mechanical Surface Detection)
- Electronics: DAE4 Sn1338; Calibrated: 2019.11.20
- Phantom: SAM1; Type: SAM; Serial: TP-1753
- Measurement SW: DASY52, Version 52.10 (1); SEMCAD X Version 14.6.11 (7439)

Pin=250mW/Area Scan (61x61x1): Interpolated grid: dx=1.500 mm, dy=1.500 mm

Maximum value of SAR (interpolated) = 14.1 W/kg

Pin=250mW/Zoom Scan (5x5x7)/Cube 0: Measurement grid: dx=8mm, dy=8mm, dz=5mm

Reference Value = 100.1 V/m; Power Drift = 0.13 dB

Peak SAR (extrapolated) = 17.0 W/kg

SAR(1 g) = 9.26 W/kg; SAR(10 g) = 4.91 W/kg

Maximum value of SAR (measured) = 14.3 W/kg

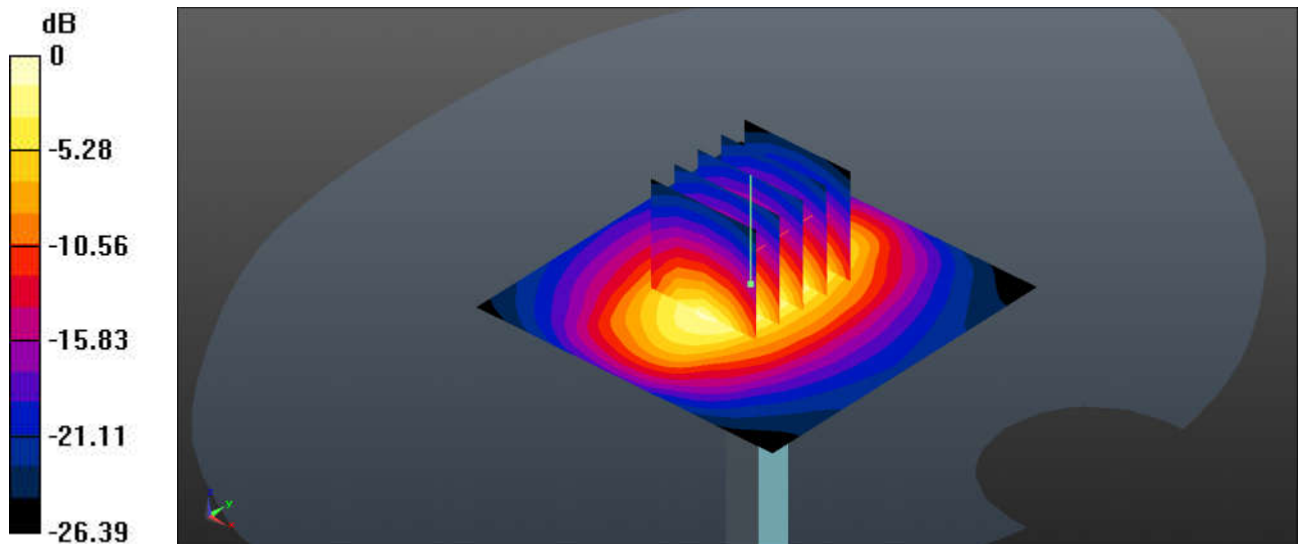

0 dB = 14.1 W/kg = 11.49 dBW/kg

System Check_Head_1900MHz

DUT: D1900V2 - SN:5d170

Communication System: UID 0, CW (0); Frequency: 1900 MHz;Duty Cycle: 1:1
 Medium: HSL_1900 Medium parameters used: $f = 1900 \text{ MHz}$; $\sigma = 1.403 \text{ S/m}$; $\epsilon_r = 39.091$; $\rho = 1000 \text{ kg/m}^3$
 Ambient Temperature : $23.2 \text{ }^\circ\text{C}$; Liquid Temperature : $22.8 \text{ }^\circ\text{C}$

DASY5 Configuration:

- Probe: ES3DV3 - SN3293; ConvF(5.32, 5.32, 5.32); Calibrated: 2019.11.25
- Sensor-Surface: 3mm (Mechanical Surface Detection)
- Electronics: DAE4 Sn1338; Calibrated: 2019.11.20
- Phantom: SAM2; Type: SAM; Serial: TP-1754
- Measurement SW: DASY52, Version 52.10 (1); SEMCAD X Version 14.6.11 (7439)

Pin=250mW/Area Scan (61x61x1): Interpolated grid: $dx=1.500 \text{ mm}$, $dy=1.500 \text{ mm}$
 Maximum value of SAR (interpolated) = 14.3 W/kg

Pin=250mW/Zoom Scan (5x5x7)/Cube 0: Measurement grid: $dx=8\text{mm}$, $dy=8\text{mm}$, $dz=5\text{mm}$
 Reference Value = 85.21 V/m ; Power Drift = -0.05 dB
 Peak SAR (extrapolated) = 18.6 W/kg
SAR(1 g) = 9.79 W/kg; SAR(10 g) = 4.99 W/kg
 Maximum value of SAR (measured) = 14.3 W/kg

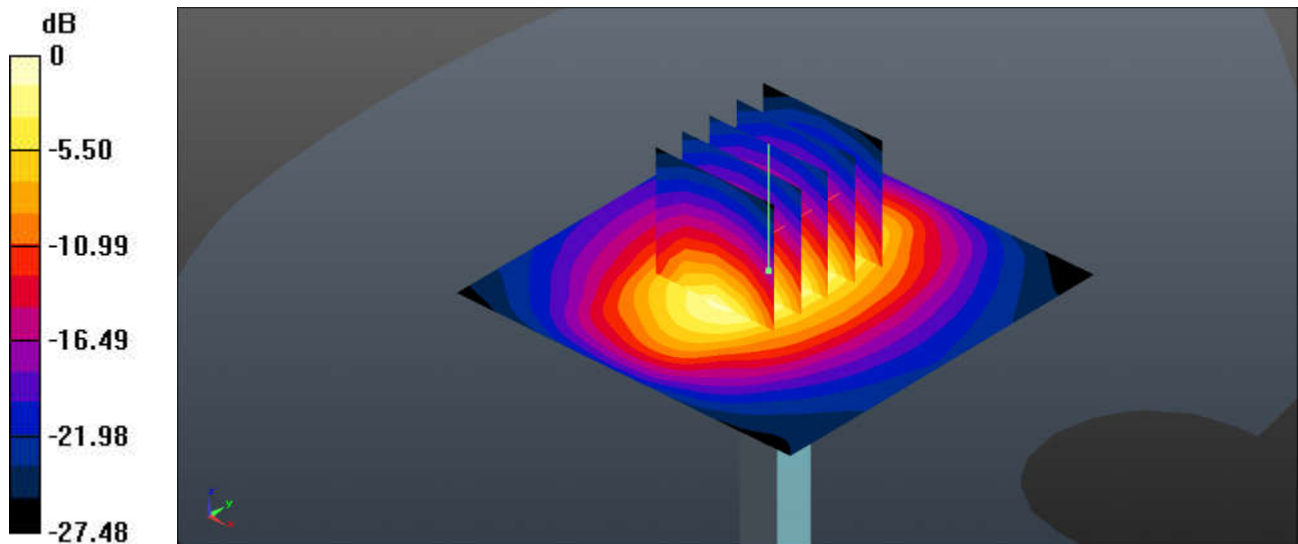

0 dB = $14.3 \text{ W/kg} = 11.55 \text{ dBW/kg}$

System Check_Head_2450MHz

DUT: D2450V2 - SN:908

Communication System: UID 0, CW (0); Frequency: 2450 MHz;Duty Cycle: 1:1
 Medium: HSL_2450 Medium parameters used: $f = 2450 \text{ MHz}$; $\sigma = 1.854 \text{ S/m}$; $\epsilon_r = 38.441$; $\rho = 1000 \text{ kg/m}^3$
 Ambient Temperature : $23.4 \text{ }^\circ\text{C}$; Liquid Temperature : $22.7 \text{ }^\circ\text{C}$

DASY5 Configuration:

- Probe: ES3DV3 - SN3293; ConvF(4.6, 4.6, 4.6); Calibrated: 2019.11.25
- Sensor-Surface: 3mm (Mechanical Surface Detection)
- Electronics: DAE4 Sn1338; Calibrated: 2019.11.20
- Phantom: SAM2; Type: SAM; Serial: TP-1754
- Measurement SW: DASY52, Version 52.10 (1); SEMCAD X Version 14.6.11 (7439)

Pin=250mW/Area Scan (71x71x1): Interpolated grid: $dx=1.200 \text{ mm}$, $dy=1.200 \text{ mm}$
 Maximum value of SAR (interpolated) = 21.4 W/kg

Pin=250mW/Zoom Scan (7x7x7)/Cube 0: Measurement grid: $dx=5\text{mm}$, $dy=5\text{mm}$, $dz=5\text{mm}$
 Reference Value = 73.06 V/m ; Power Drift = 0.08 dB
 Peak SAR (extrapolated) = 28.3 W/kg
SAR(1 g) = 13.1 W/kg ; SAR(10 g) = 5.91 W/kg
 Maximum value of SAR (measured) = 20.4 W/kg

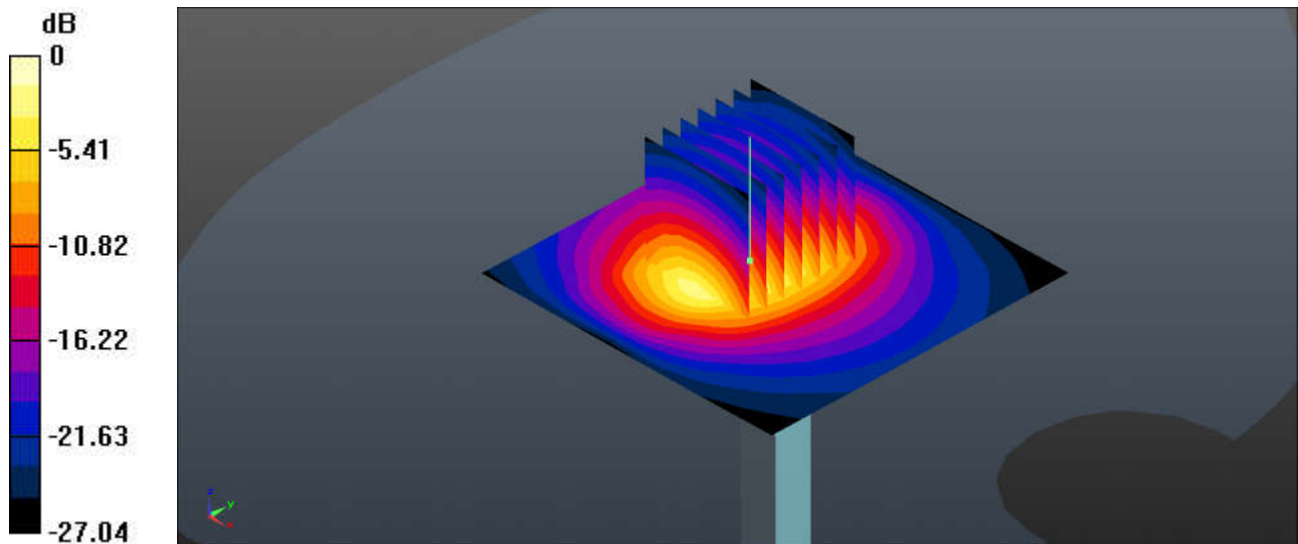

$0 \text{ dB} = 21.4 \text{ W/kg} = 13.30 \text{ dBW/kg}$

System Check_Head_2600MHz(1)

DUT: D2600V2 - SN:1061

Communication System: UID 0, CW (0); Frequency: 2600 MHz;Duty Cycle: 1:1
 Medium: HSL_2600 Medium parameters used: $f = 2600$ MHz; $\sigma = 2.032$ S/m; $\epsilon_r = 37.935$; $\rho = 1000$ kg/m³
 Ambient Temperature : 23.3 °C; Liquid Temperature : 22.8 °C

DASY5 Configuration:

- Probe: ES3DV3 - SN3293; ConvF(4.39, 4.39, 4.39); Calibrated: 2019.11.25
- Sensor-Surface: 3mm (Mechanical Surface Detection)
- Electronics: DAE4 Sn1338; Calibrated: 2019.11.20
- Phantom: SAM1; Type: SAM; Serial: TP-1753
- Measurement SW: DASY52, Version 52.10 (1); SEMCAD X Version 14.6.11 (7439)

Pin=250mW/Area Scan (71x71x1): Interpolated grid: dx=1.200 mm, dy=1.200 mm
 Maximum value of SAR (interpolated) = 24.5 W/kg

Pin=250mW/Zoom Scan (7x7x7)/Cube 0: Measurement grid: dx=5mm, dy=5mm, dz=5mm
 Reference Value = 76.37 V/m; Power Drift = 0.01 dB
 Peak SAR (extrapolated) = 33.3 W/kg
SAR(1 g) = 14.8 W/kg; SAR(10 g) = 6.44 W/kg
 Maximum value of SAR (measured) = 23.7 W/kg

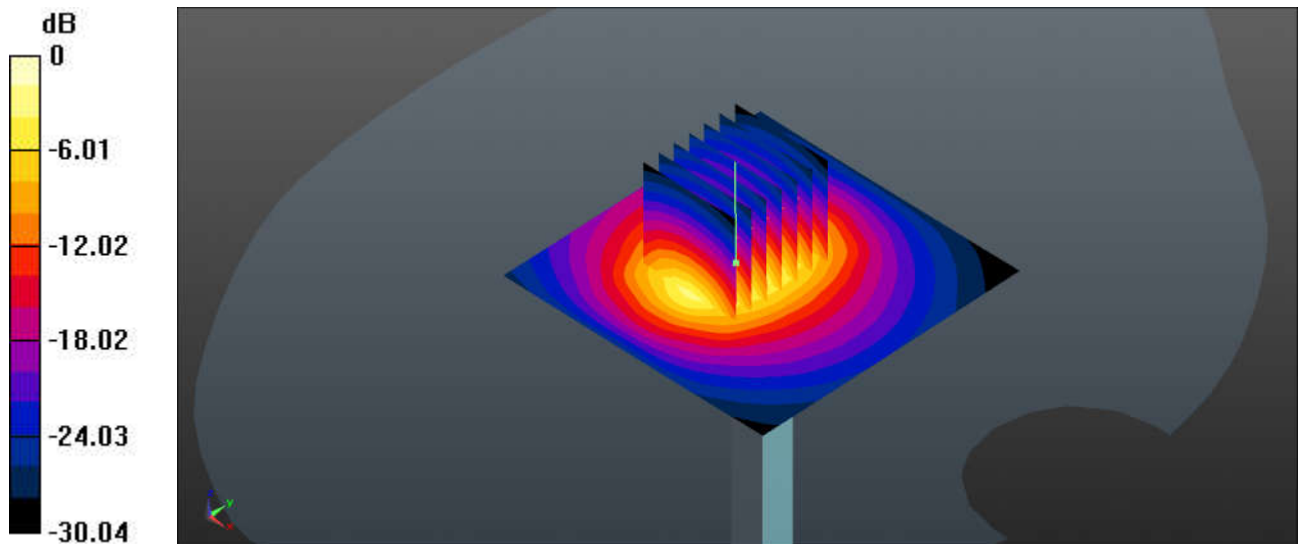

0 dB = 24.5 W/kg = 13.89 dBW/kg

System Check_Head_2600MHz(2)

DUT: D2600V2 - SN:1061

Communication System: UID 0, CW (0); Frequency: 2600 MHz; Duty Cycle: 1:1

Medium: HSL_2600 Medium parameters used: $f = 2600$ MHz; $\sigma = 1.934$ S/m; $\epsilon_r = 40.117$; $\rho = 1000$ kg/m³

Ambient Temperature : 23.3 °C ; Liquid Temperature : 22.8 °C

DASY5 Configuration:

- Probe: ES3DV3 - SN3293; ConvF(4.39, 4.39, 4.39); Calibrated: 2019.11.25
- Sensor-Surface: 3mm (Mechanical Surface Detection)
- Electronics: DAE4 Sn1338; Calibrated: 2019.11.20
- Phantom: SAM1; Type: SAM; Serial: TP-1753
- Measurement SW: DASY52, Version 52.10 (1); SEMCAD X Version 14.6.11 (7439)

Pin=250mW/Area Scan (71x71x1): Interpolated grid: dx=1.200 mm, dy=1.200 mm

Maximum value of SAR (interpolated) = 19.1 W/kg

Pin=250mW/Zoom Scan (7x7x7)/Cube 0: Measurement grid: dx=5mm, dy=5mm, dz=5mm

Reference Value = 102.5 V/m; Power Drift = -0.02 dB

Peak SAR (extrapolated) = 31.4 W/kg

SAR(1 g) = 13.8 W/kg; SAR(10 g) = 6.18 W/kg

Maximum value of SAR (measured) = 18.6 W/kg

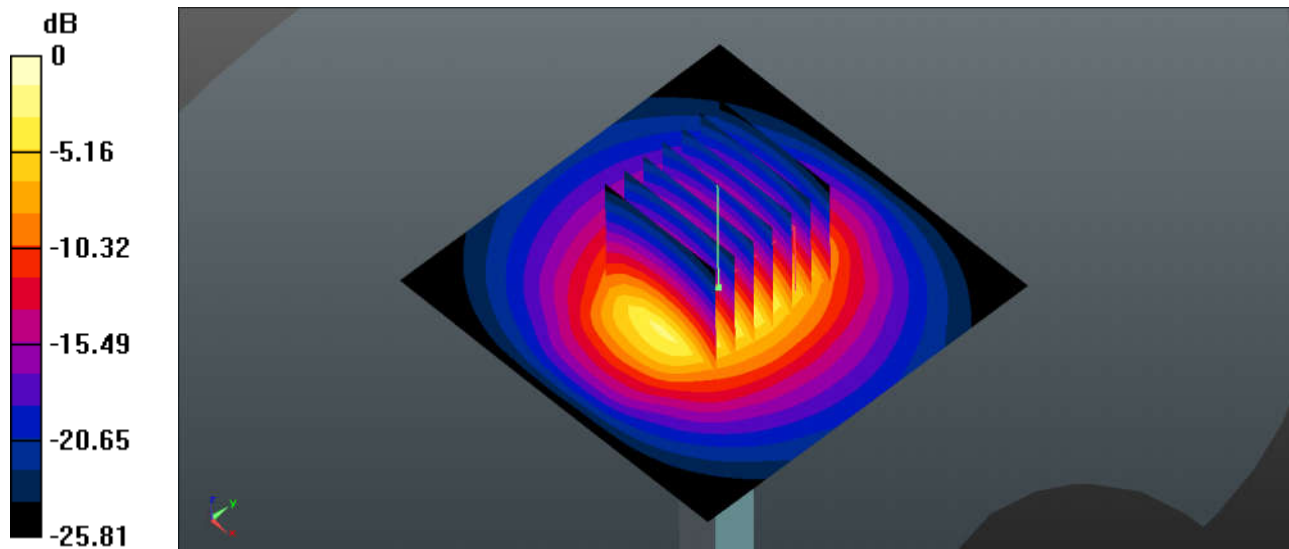

0 dB = 18.6 W/kg = 12.70 dBW/kg

System Check_Head_5250MHz

DUT: D5GHzV2 - SN:1113

Communication System: UID 0, CW (0); Frequency: 5250 MHz; Duty Cycle: 1:1
Medium: HSL_5000 Medium parameters used: $f = 5250$ MHz; $\sigma = 4.6$ S/m; $\epsilon_r = 36.384$; $\rho = 1000$ kg/m³
Ambient Temperature : 23.3 °C; Liquid Temperature : 22.9 °C

DASY5 Configuration:

- Probe: EX3DV4 - SN3857; ConvF(5.19, 5.19, 5.19); Calibrated: 2019.5.27
- Sensor-Surface: 1.4mm (Mechanical Surface Detection)
- Electronics: DAE4 Sn1210; Calibrated: 2019.7.23
- Phantom: SAM1; Type: SAM; Serial: TP-1753
- Measurement SW: DASY52, Version 52.10 (1); SEMCAD X Version 14.6.11 (7439)

Pin=100mW/Area Scan (71x71x1): Interpolated grid: dx=1.000 mm, dy=1.000 mm
Maximum value of SAR (interpolated) = 18.8 W/kg

Pin=100mW/Zoom Scan (8x8x7)/Cube 0: Measurement grid: dx=4mm, dy=4mm, dz=1.4mm
Reference Value = 44.59 V/m; Power Drift = 0.05 dB
Peak SAR (extrapolated) = 29.7 W/kg
SAR(1 g) = 8.03 W/kg; SAR(10 g) = 2.33 W/kg
Maximum value of SAR (measured) = 18.1 W/kg

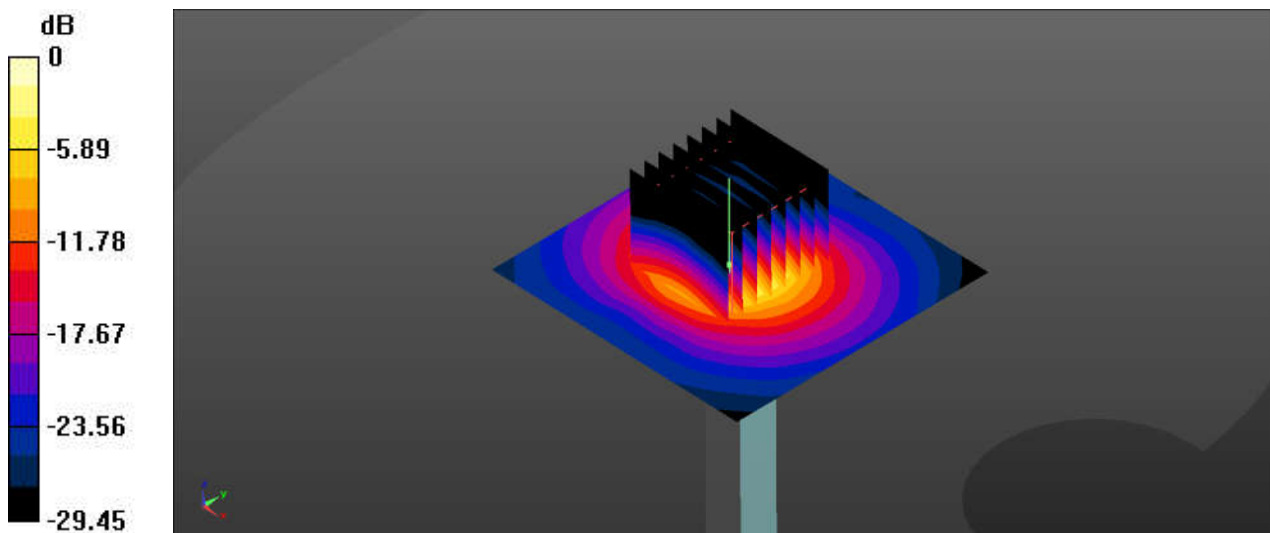

0 dB = 18.8 W/kg = 12.74 dBW/kg

System Check_Head_5600MHz

DUT: D5GHzV2 - SN:1113

Communication System: UID 0, CW (0); Frequency: 5600 MHz;Duty Cycle: 1:1
Medium: HSL_5000 Medium parameters used: $f = 5600$ MHz; $\sigma = 4.99$ S/m; $\epsilon_r = 35.802$; $\rho = 1000$ kg/m³
Ambient Temperature : 23.2 °C; Liquid Temperature : 22.9 °C

DASY5 Configuration:

- Probe: EX3DV4 - SN3857; ConvF(4.92, 4.92, 4.92); Calibrated: 2019.5.27
- Sensor-Surface: 1.4mm (Mechanical Surface Detection)
- Electronics: DAE4 Sn1210; Calibrated: 2019.7.23
- Phantom: SAM1; Type: SAM; Serial: TP-1753
- Measurement SW: DASY52, Version 52.10 (1); SEMCAD X Version 14.6.11 (7439)

Pin=100mW/Area Scan (71x71x1): Interpolated grid: dx=1.000 mm, dy=1.000 mm

Maximum value of SAR (interpolated) = 20.9 W/kg

Pin=100mW/Zoom Scan (8x8x7)/Cube 0: Measurement grid: dx=4mm, dy=4mm, dz=1.4mm

Reference Value = 42.77 V/m; Power Drift = 0.08 dB

Peak SAR (extrapolated) = 33.8 W/kg

SAR(1 g) = 8.45 W/kg; SAR(10 g) = 2.43 W/kg

Maximum value of SAR (measured) = 19.6 W/kg

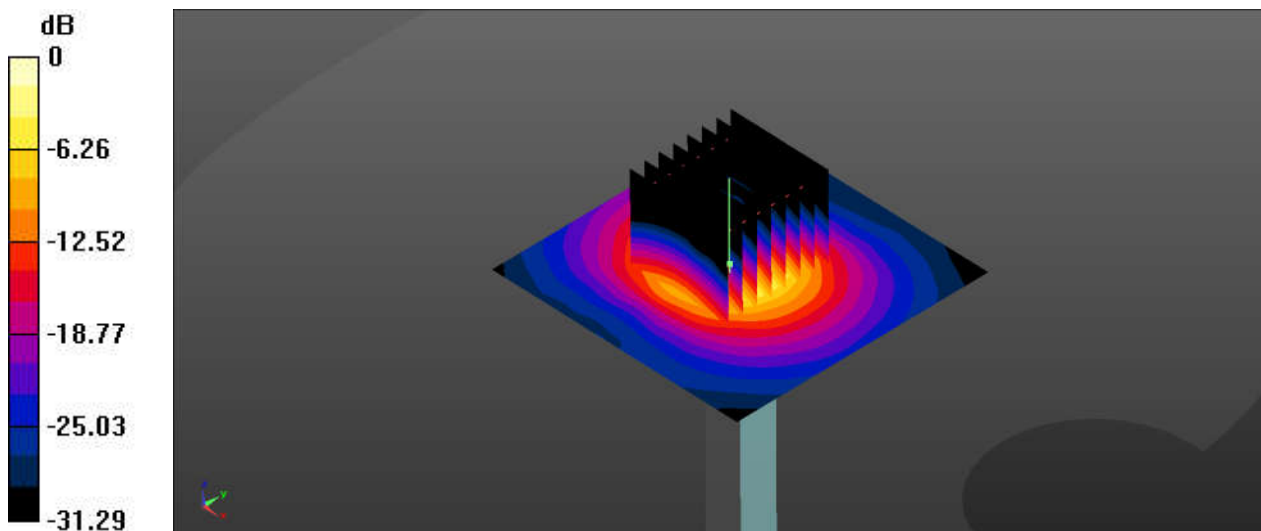

0 dB = 20.9 W/kg = 13.20 dBW/kg

System Check_Head_5750MHz

DUT: D5GHzV2 - SN:1113

Communication System: UID 0, CW (0); Frequency: 5750 MHz; Duty Cycle: 1:1
Medium: HSL_5000 Medium parameters used: $f = 5750$ MHz; $\sigma = 5.167$ S/m; $\epsilon_r = 35.552$; $\rho = 1000$ kg/m³
Ambient Temperature : 23.3 °C ; Liquid Temperature : 22.7 °C

DASY5 Configuration:

- Probe: EX3DV4 - SN3857; ConvF(5.17, 5.17, 5.17); Calibrated: 2019.5.27
- Sensor-Surface: 1.4mm (Mechanical Surface Detection)
- Electronics: DAE4 Sn1210; Calibrated: 2019.7.23
- Phantom: SAM1; Type: SAM; Serial: TP-1753
- Measurement SW: DASY52, Version 52.10 (1); SEMCAD X Version 14.6.11 (7439)

Pin=100mW/Area Scan (71x71x1): Interpolated grid: dx=1.000 mm, dy=1.000 mm
Maximum value of SAR (interpolated) = 19.2 W/kg

Pin=100mW/Zoom Scan (8x8x7)/Cube 0: Measurement grid: dx=4mm, dy=4mm, dz=1.4mm
Reference Value = 30.75 V/m; Power Drift = 0.05 dB
Peak SAR (extrapolated) = 32.9 W/kg
SAR(1 g) = 7.83 W/kg; SAR(10 g) = 2.24 W/kg
Maximum value of SAR (measured) = 18.8 W/kg

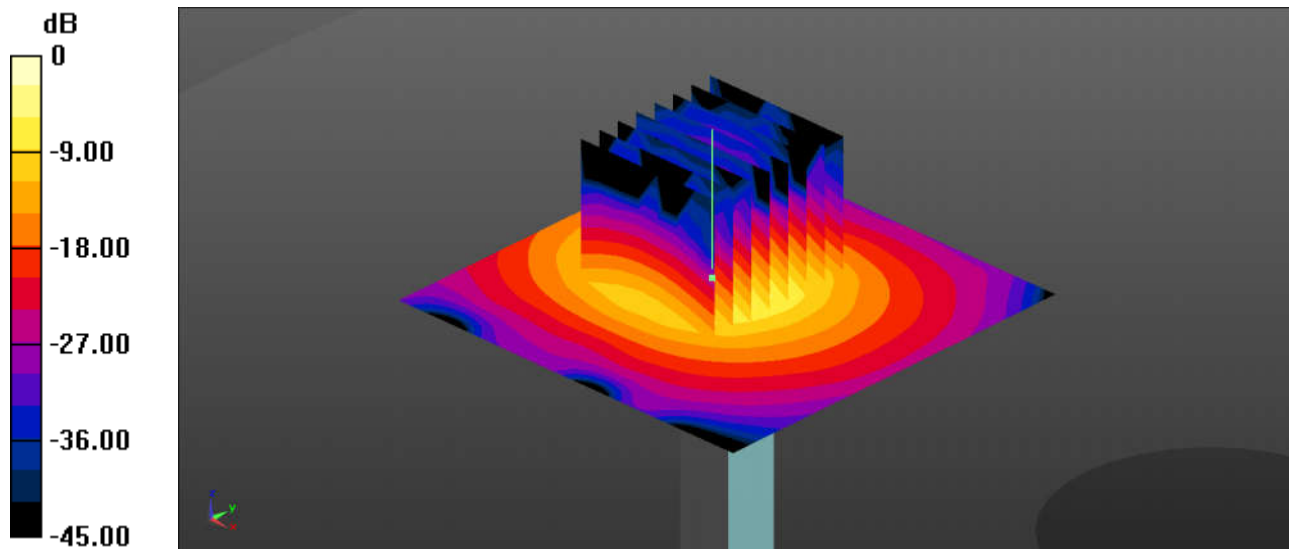



Appendix B. Plots of High SAR Measurement

The plots are shown as follows.

01_GSM850_GPRS 3 Tx slots_Right Cheek_0mm_Ch128

Communication System: UID 0, GSM850 (0); Frequency: 824.2 MHz; Duty Cycle: 1:2.77
 Medium: HSL_835 Medium parameters used: $f = 824.2$ MHz; $\sigma = 0.894$ S/m; $\epsilon_r = 41.454$;
 $\rho = 1000$ kg/m³
 Ambient Temperature : 23.3 °C; Liquid Temperature : 22.7 °C

DASY5 Configuration:

- Probe: ES3DV3 - SN3293; ConvF(6.39, 6.39, 6.39); Calibrated: 2019.11.25
- Sensor-Surface: 3mm (Mechanical Surface Detection)
- Electronics: DAE4 Sn1338; Calibrated: 2019.11.20
- Phantom: SAM2; Type: SAM; Serial: TP-1754
- Measurement SW: DASY52, Version 52.10 (1); SEMCAD X Version 14.6.11 (7439)

Ch128/Area Scan (71x81x1): Interpolated grid: dx=1.500 mm, dy=1.500 mm

Maximum value of SAR (interpolated) = 0.107 W/kg

Ch128/Zoom Scan (6x6x7)/Cube 0: Measurement grid: dx=8mm, dy=8mm, dz=5mm

Reference Value = 2.702 V/m; Power Drift = 0.01 dB

Peak SAR (extrapolated) = 0.122 W/kg

SAR(1 g) = 0.097 W/kg; SAR(10 g) = 0.074 W/kg

Maximum value of SAR (measured) = 0.106 W/kg

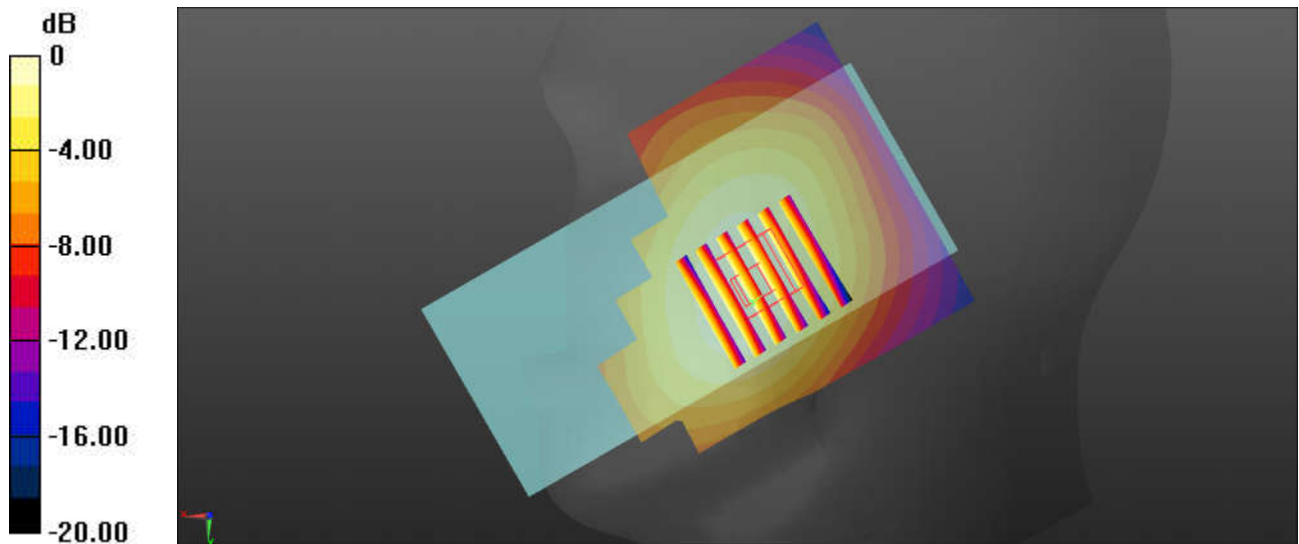

0 dB = 0.107 W/kg = -9.71 dBW/kg

02_GSM1900_GPRS 3 Tx slots_Right Cheek_0mm_Ch810

Communication System: UID 0, PCS (0); Frequency: 1909.8 MHz; Duty Cycle: 1:2.77
 Medium: HSL_1900 Medium parameters used: $f = 1909.8 \text{ MHz}$; $\sigma = 1.413 \text{ S/m}$; $\epsilon_r = 39.046$; $\rho = 1000 \text{ kg/m}^3$
 Ambient Temperature : $23.2 \text{ }^\circ\text{C}$; Liquid Temperature : $22.8 \text{ }^\circ\text{C}$

DASY5 Configuration:

- Probe: ES3DV3 - SN3293; ConvF(5.32, 5.32, 5.32); Calibrated: 2019.11.25
- Sensor-Surface: 3mm (Mechanical Surface Detection)
- Electronics: DAE4 Sn1338; Calibrated: 2019.11.20
- Phantom: SAM2; Type: SAM; Serial: TP-1754
- Measurement SW: DASY52, Version 52.10 (1); SEMCAD X Version 14.6.11 (7439)

Ch810/Area Scan (71x81x1): Interpolated grid: $dx=1.500 \text{ mm}$, $dy=1.500 \text{ mm}$
 Maximum value of SAR (interpolated) = 0.0498 W/kg

Ch810/Zoom Scan (5x5x7)/Cube 0: Measurement grid: $dx=8\text{mm}$, $dy=8\text{mm}$, $dz=5\text{mm}$
 Reference Value = 2.683 V/m ; Power Drift = 0.02 dB
 Peak SAR (extrapolated) = 0.0630 W/kg
SAR(1 g) = 0.042 W/kg ; SAR(10 g) = 0.025 W/kg
 Maximum value of SAR (measured) = 0.0480 W/kg

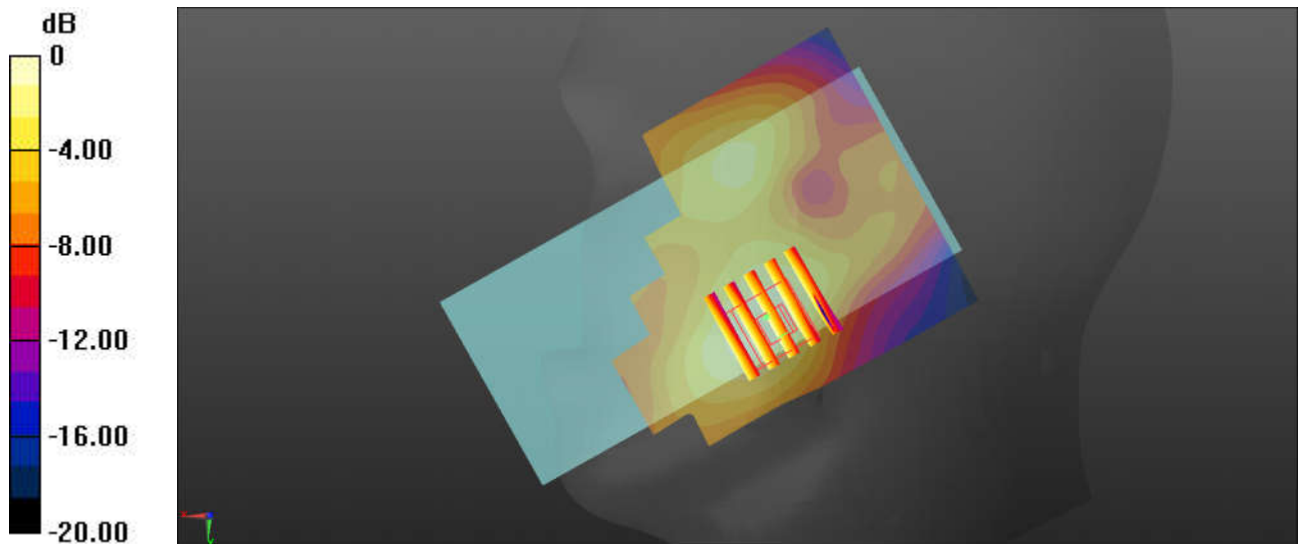

$0 \text{ dB} = 0.0498 \text{ W/kg} = -13.03 \text{ dBW/kg}$

03_WCDMA II_RMC 12.2Kbps_Right Cheek_0mm_Ch9538

Communication System: UID 0, WCDMA (0); Frequency: 1907.6 MHz; Duty Cycle: 1:1
 Medium: HSL_1900 Medium parameters used: $f = 1907.6$ MHz; $\sigma = 1.411$ S/m; $\epsilon_r = 39.055$; $\rho = 1000$ kg/m³
 Ambient Temperature : 23.2 °C; Liquid Temperature : 22.8 °C

DASY5 Configuration:

- Probe: ES3DV3 - SN3293; ConvF(5.32, 5.32, 5.32); Calibrated: 2019.11.25
- Sensor-Surface: 3mm (Mechanical Surface Detection)
- Electronics: DAE4 Sn1338; Calibrated: 2019.11.20
- Phantom: SAM2; Type: SAM; Serial: TP-1754
- Measurement SW: DASY52, Version 52.10 (1); SEMCAD X Version 14.6.11 (7439)

Ch9538/Area Scan (71x81x1): Interpolated grid: dx=1.500 mm, dy=1.500 mm
 Maximum value of SAR (interpolated) = 0.138 W/kg

Ch9538/Zoom Scan (5x5x7)/Cube 0: Measurement grid: dx=8mm, dy=8mm, dz=5mm
 Reference Value = 4.198 V/m; Power Drift = 0.01 dB
 Peak SAR (extrapolated) = 0.178 W/kg
SAR(1 g) = 0.112 W/kg; SAR(10 g) = 0.067 W/kg
 Maximum value of SAR (measured) = 0.131 W/kg

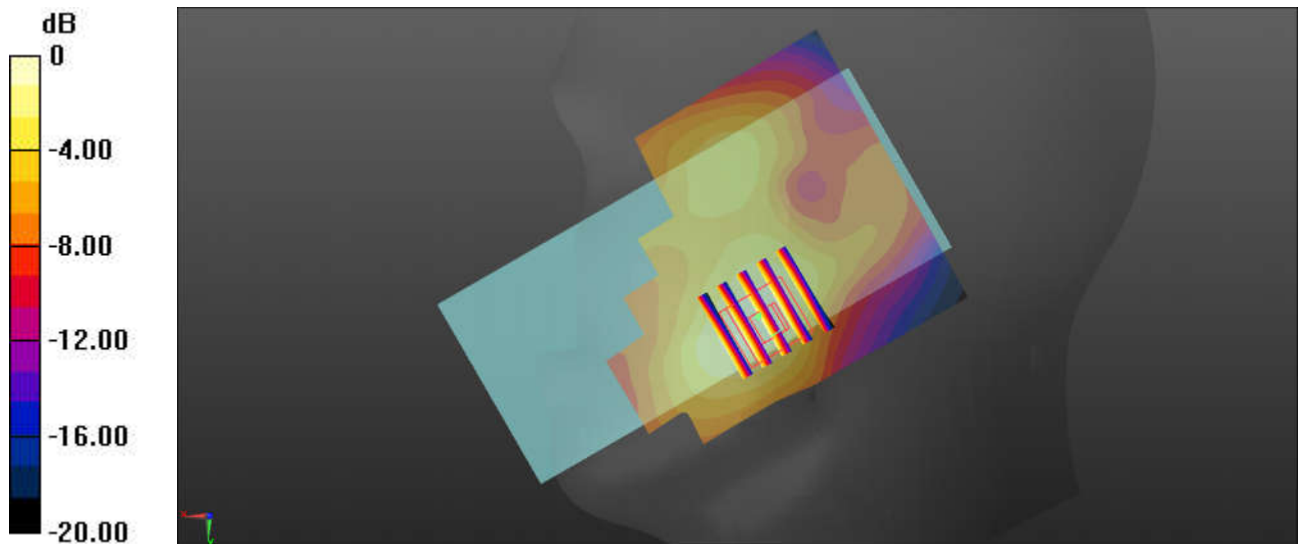

0 dB = 0.138 W/kg = -8.60 dBW/kg

04_WCDMA IV_RMC 12.2Kbps_Right Cheek_0mm_Ch1513

Communication System: UID 0, WCDMA (0); Frequency: 1752.6 MHz; Duty Cycle: 1:1
 Medium: HSL_1750 Medium parameters used: $f = 1752.6$ MHz; $\sigma = 1.366$ S/m; $\epsilon_r = 39.016$; $\rho = 1000$ kg/m³
 Ambient Temperature : 23.3 °C; Liquid Temperature : 22.6 °C

DASY5 Configuration:

- Probe: ES3DV3 - SN3293; ConvF(5.53, 5.53, 5.53); Calibrated: 2019.11.25
- Sensor-Surface: 3mm (Mechanical Surface Detection)
- Electronics: DAE4 Sn1338; Calibrated: 2019.11.20
- Phantom: SAM1; Type: SAM; Serial: TP-1753
- Measurement SW: DASY52, Version 52.10 (1); SEMCAD X Version 14.6.11 (7439)

Ch1513/Area Scan (71x81x1): Interpolated grid: dx=1.500 mm, dy=1.500 mm
 Maximum value of SAR (interpolated) = 0.219 W/kg

Ch1513/Zoom Scan (5x5x7)/Cube 0: Measurement grid: dx=8mm, dy=8mm, dz=5mm
 Reference Value = 5.209 V/m; Power Drift = 0.11 dB
 Peak SAR (extrapolated) = 0.279 W/kg
SAR(1 g) = 0.186 W/kg; SAR(10 g) = 0.116 W/kg
 Maximum value of SAR (measured) = 0.210 W/kg

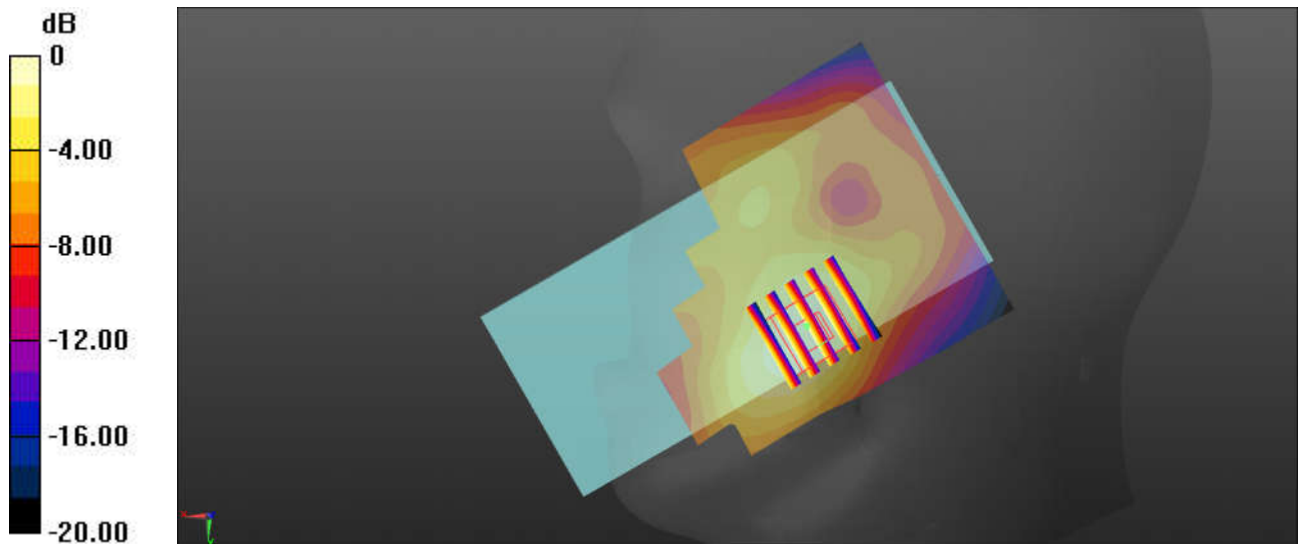

0 dB = 0.219 W/kg = -6.60 dBW/kg

05_WCDMA V_RMC 12.2Kbps_Right Cheek_0mm_Ch4132

Communication System: UID 0, WCDMA (0); Frequency: 826.4 MHz; Duty Cycle: 1:1
Medium: HSL_835 Medium parameters used: $f = 826.4$ MHz; $\sigma = 0.897$ S/m; $\epsilon_r = 41.425$;
 $\rho = 1000$ kg/m³
Ambient Temperature : 23.3 °C; Liquid Temperature : 22.7 °C

DASY5 Configuration:

- Probe: ES3DV3 - SN3293; ConvF(6.39, 6.39, 6.39); Calibrated: 2019.11.25
- Sensor-Surface: 3mm (Mechanical Surface Detection)
- Electronics: DAE4 Sn1338; Calibrated: 2019.11.20
- Phantom: SAM1; Type: SAM; Serial: TP-1753
- Measurement SW: DASY52, Version 52.10 (1); SEMCAD X Version 14.6.11 (7439)

Ch4132/Area Scan (71x81x1): Interpolated grid: dx=1.500 mm, dy=1.500 mm

Maximum value of SAR (interpolated) = 0.369 W/kg

Ch4132/Zoom Scan (5x5x7)/Cube 0: Measurement grid: dx=8mm, dy=8mm, dz=5mm

Reference Value = 5.103 V/m; Power Drift = 0.04 dB

Peak SAR (extrapolated) = 0.417 W/kg

SAR(1 g) = 0.331 W/kg; SAR(10 g) = 0.252 W/kg

Maximum value of SAR (measured) = 0.362 W/kg

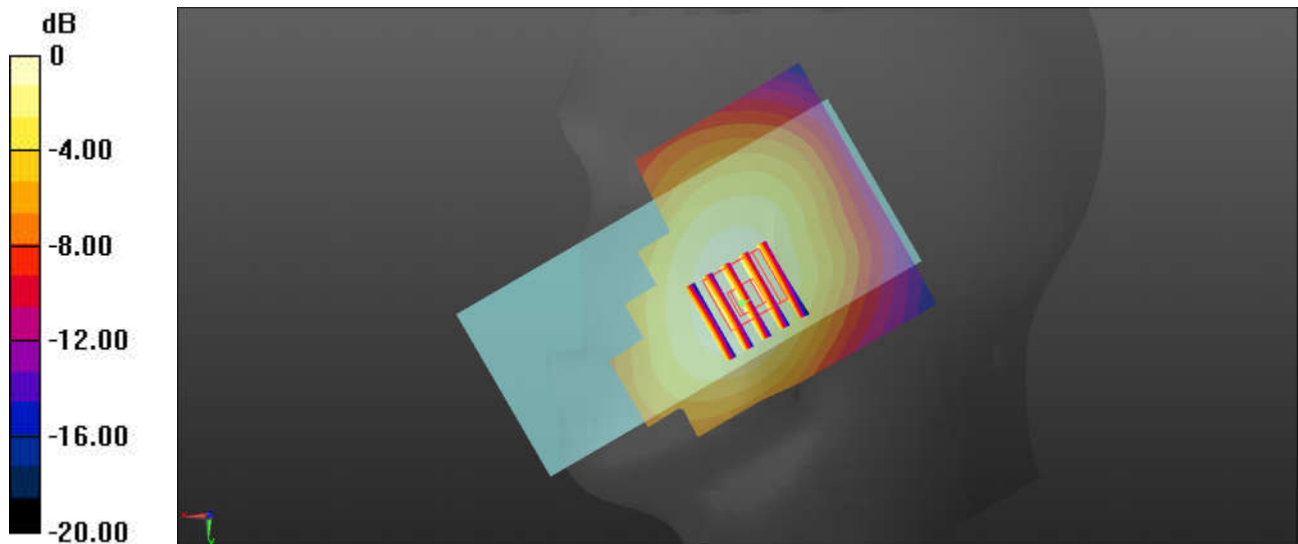

0 dB = 0.369 W/kg = -4.33 dBW/kg