



FCC RF Test Report

APPLICANT : Motorola Mobility LLC
EQUIPMENT : Mobile Cellular Phone
BRAND NAME : Motorola
MODEL NAME : XT2043-4, XT2043-5, XT2043-6
FCC ID : IHDT56YN1
STANDARD : FCC Part 15 Subpart E §15.407
CLASSIFICATION : (NII) Unlicensed National Information Infrastructure

The product was received on Oct. 09, 2019 and testing was completed on Nov. 29, 2019. We, Sporton International (Kunshan) Inc., would like to declare that the tested sample has been evaluated in accordance with the test procedures and has been in compliance with the applicable technical standards.

The test results in this report apply exclusively to the tested model / sample. Without written approval of Sporton International (Kunshan) Inc., the test report shall not be reproduced except in full.

Jason Jia

Reviewed by: Jason Jia / Supervisor

James Huang

Approved by: James Huang / Manager



Sporton International (Kunshan) Inc.

**No. 1098, Pengxi North Road, Kunshan Economic Development Zone Jiangsu Province 215300
People's Republic of China**



TABLE OF CONTENTS

REVISION HISTORY..... 3

SUMMARY OF TEST RESULT 4

1 GENERAL DESCRIPTION 5

 1.1 Applicant 5

 1.2 Manufacturer 5

 1.3 Product Feature of Equipment Under Test..... 5

 1.4 Product Specification of Equipment Under Test..... 6

 1.5 Modification of EUT 6

 1.6 Specification of Accessory..... 6

 1.7 Testing Location 7

 1.8 Test Software..... 7

 1.9 Applicable Standards..... 7

2 TEST CONFIGURATION OF EQUIPMENT UNDER TEST 8

 2.1 Carrier Frequency and Channel 8

 2.2 Test Mode..... 9

 2.3 Connection Diagram of Test System..... 10

 2.4 Support Unit used in test configuration and system 11

 2.5 EUT Operation Test Setup 11

 2.6 Measurement Results Explanation Example..... 11

3 TEST RESULT..... 12

 3.1 6dB and 26dB and 99% Occupied Bandwidth Measurement 12

 3.2 Maximum Conducted Output Power Measurement 15

 3.3 Power Spectral Density Measurement 16

 3.4 Unwanted Emissions Measurement 18

 3.5 AC Conducted Emission Measurement..... 22

 3.6 Automatically Discontinue Transmission 24

 3.7 Antenna Requirements 25

4 LIST OF MEASURING EQUIPMENT 26

5 UNCERTAINTY OF EVALUATION 27

APPENDIX A. CONDUCTED TEST RESULTS

APPENDIX B. AC CONDUCTED EMISSION TEST RESULT

APPENDIX C. RADIATED SPURIOUS EMISSION

APPENDIX D. DUTY CYCLE PLOTS

APPENDIX E. SETUP PHOTOGRAPHS



SUMMARY OF TEST RESULT

Report Section	FCC Rule	Description	Limit	Result	Remark
3.1	15.403(i)	6dB, 26dB and 99% Occupied Bandwidth	> 500kHz	Pass	-
3.2	15.407(a)	Maximum Conducted Output Power	≤ 30 dBm	Pass	-
3.3	15.407(a)	Power Spectral Density	≤ 30 dBm/500kHz	Pass	-
3.4	15.407(b)	Unwanted Emissions	15.407(b)(4)(i) & 15.209(a)	Pass	Under limit 9.49 dB at 339.430 MHz
3.5	15.207	AC Conducted Emission	15.207(a)	Pass	Under limit 10.93 dB at 0.162 MH
3.6	15.407(c)	Automatically Discontinue Transmission	Discontinue Transmission	Pass	-
3.7	15.203 & 15.407(a)	Antenna Requirement	N/A	Pass	-

Declaration of Conformity:
The test results with all measurement uncertainty excluded are presented in accordance with the regulation limits or requirements declared by manufacturers.
Comments and Explanations:
The declared of product specification for EUT presented in the report are provided by the manufacturer, and the manufacturer takes all the responsibilities for the accuracy of product specification.



1 General Description

1.1 Applicant

Motorola Mobility LLC
222 W, Merchandise Mart Plaza, Chicago IL 60654 USA

1.2 Manufacturer

Motorola Mobility LLC
222 W, Merchandise Mart Plaza, Chicago IL 60654 USA

1.3 Product Feature of Equipment Under Test

Product Feature	
Equipment	Mobile Cellular Phone
Brand Name	Motorola
Model Name	XT2043-4, XT2043-5, XT2043-6
FCC ID	IHDT56YN1
EUT supports Radios application	CDMA/EV-DO/GSM/GPRS/EGPRS/WCDMA/HSPA/ DC-HSDPA/HSPA+(16QAM uplink is not supported)/LTE WLAN 2.4GHz 802.11b/g/n HT20 WLAN 5GHz 802.11a/n HT20/HT40 WLAN 5GHz 802.11ac VHT20/VHT40/VHT80 Bluetooth BR/EDR/LE GNSS/FM Receiver
IMEI Code	Conducted: 359084100014845 Conduction: 359084100021188 Radiation: 359084100022632
HW Version	DVT2
SW Version	QPR30.56
EUT Stage	Identical Prototype

Remark:

1. The above EUT's information was declared by manufacturer. Please refer to the specifications or user's manual for more detailed description.
2. The different model names are for different market requirement.



1.4 Product Specification of Equipment Under Test

Standards-related Product Specification	
Tx/Rx Channel Frequency Range	5745 MHz ~ 5825 MHz
Maximum Output Power	<5745 MHz ~ 5825 MHz> 802.11a : 19.52 dBm / 0.0895 W 802.11n HT20 : 18.84 dBm / 0.0766 W 802.11n HT40 : 19.02 dBm / 0.0798 W 802.11ac VHT20 : 18.44 dBm / 0.0698 W 802.11ac VHT40 : 18.67 dBm / 0.0736 W 802.11ac VHT80 : 18.72 dBm / 0.0745 W
99% Occupied Bandwidth	802.11a : 17.58 MHz 802.11n HT20 : 18.63 MHz 802.11n HT40 : 36.56 MHz 802.11ac VHT80 : 75.64 MHz
Type of Modulation	802.11a/n : OFDM (BPSK / QPSK / 16QAM / 64QAM) 802.11ac : OFDM (BPSK / QPSK / 16QAM / 64QAM / 256QAM)
Antenna Type / Gain	Monopole Antenna with gain -5.00 dBi

Note: For 802.11n HT20 / ac VHT20 and 802.11n HT40 / ac VHT40 mode, the whole testing have assessed only 802.11n HT20/ HT40 by referring to their maximum conducted power.

1.5 Modification of EUT

No modifications are made to the EUT during all test items.

1.6 Specification of Accessory

Specification of Accessory				
AC Adapter 1	Brand Name	Motorola (Acbel)	Model Name	SC-41
	Power Rating	I/P: 100-240 Vac, 300mA ; O/P: 5Vdc, 2000mA		
AC Adapter 2	Brand Name	Motorola (Chenyang)	Model Name	SC-41
	Power Rating	I/P: 100-240 Vac, 300mA ; O/P: 5Vdc, 2000mA		
Battery	Brand Name	Motorola (Amperex)	Model Name	KX50
	Power Rating	3.8Vdc, 4000mAh	Type	Li-ion
USB Cable 1	Brand Name	Motorola (Luxshare)	Model Name	SC18C24368
	Signal Line Type	1.0 meter, shielded cable, without ferrite core		
USB Cable 2	Brand Name	Motorola (Saibao)	Model Name	SC18C24367
	Signal Line Type	1.0 meter, shielded cable, without ferrite core		



1.7 Testing Location

Sporton International (Kunshan) Inc. is accredited to ISO/IEC 17025:2017 by American Association for Laboratory Accreditation with Certificate Number 5145.02.

Test Firm	Sporton International (Kunshan) Inc.		
Test Site Location	No. 1098, Pengxi North Road, Kunshan Economic Development Zone Jiangsu Province 215300 People's Republic of China TEL : +86-512-57900158 FAX : +86-512-57900958		
Test Site No.	Sporton Site No.	FCC Designation No.	FCC Test Firm Registration No.
	TH01-KS CO01-KS 03CH06-KS	CN1257	314309

1.8 Test Software

Item	Site	Manufacture	Name	Version
1.	03CH06-KS	AUDIX	E3	6.2009-8-24al
2.	CO01-KS	AUDIX	E3	6.2009-8-24

1.9 Applicable Standards

According to the specifications of the manufacturer, the EUT must comply with the requirements of the following standards:

- 47 CFR Part 15 Subpart E
- FCC KDB 789033 D02 General UNII Test Procedures New Rules v02r01.
- ANSI C63.10-2013

Remark:

1. All test items were verified and recorded according to the standards and without any deviation during the test.
2. This EUT has also been tested and complied with the requirements of FCC Part 15, Subpart B, recorded in a separate test report.



2 Test Configuration of Equipment Under Test

- a. The EUT has been associated with peripherals and configuration operated in a manner tended to maximize its emission characteristics in a typical application. Frequency range investigated: conduction emission (150 kHz to 30 MHz), radiation emission (9 kHz to the 10th harmonic of the highest fundamental frequency or to 40 GHz, whichever is lower). For radiated measurement, pre-scanned in three orthogonal panels, X, Y, Z. The worst cases (X plane) were recorded in this report.
- b. AC power line Conducted Emission was tested under maximum output power.

2.1 Carrier Frequency and Channel

Frequency Band	Channel	Freq. (MHz)	Channel	Freq. (MHz)
5745-5825 MHz Band 4 (U-NII-3)	149	5745	157	5785
	151*	5755	159*	5795
	153	5765	161	5805
	155#	5775	165	5825

Note:

- 1. The above Frequency and Channel in "*" were 802.11n HT40 and 802.11ac VHT40.
- 2. The above Frequency and Channel in "#n" were 802.11ac VHT80.



2.2 Test Mode

Final test modes are considering the modulation and worse data rates as below table.

Modulation	Data Rate
802.11a	6 Mbps
802.11n HT20	MCS0
802.11n HT40	MCS0
802.11ac VHT80	MCS0

AC Conducted Emission	Mode 1 : GSM850 Idle + Bluetooth Link + WLAN Link (5G) + USB Cable 1(Charging from Adapter 1) + Earphone
Remark: For Radiated Test Cases, The tests were performed with Adapter 1, Earphone and USB Cable 1.	

Ch. #		Band IV : 5745-5825 MHz			
		802.11a	802.11n HT20	802.11n HT40	802.11ac VHT80
L	Low	149	149	151	-
M	Middle	157	157	-	155
H	High	165	165	159	-

2.3 Connection Diagram of Test System

For Radiation

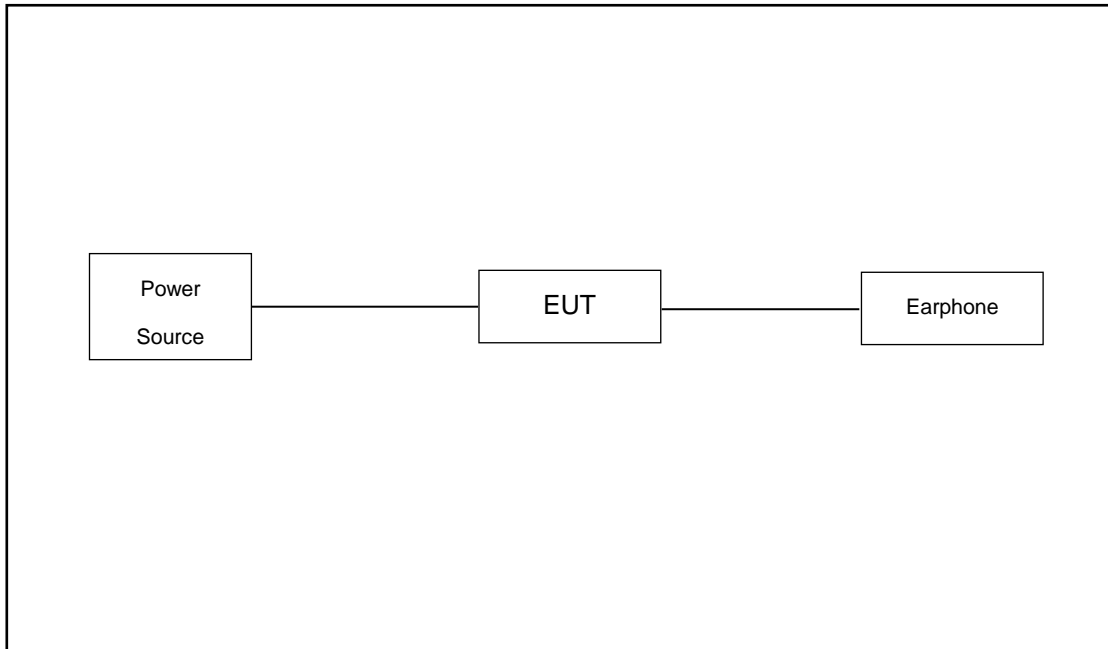

For Conducted Emission

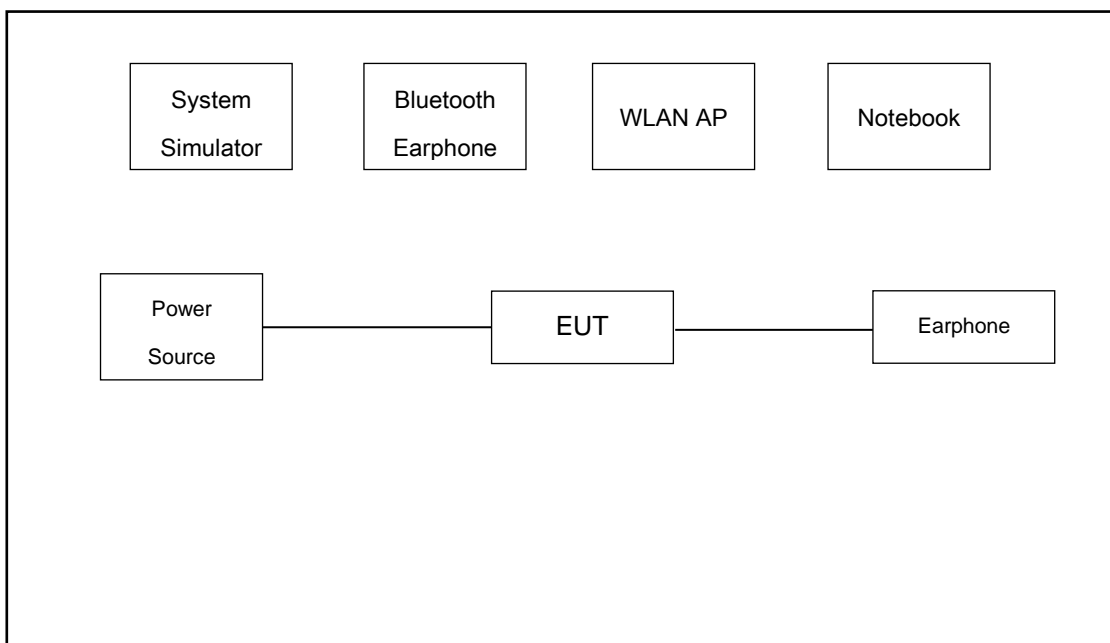

2.4 Support Unit used in test configuration and system

Item	Equipment	Trade Name	Model Name	FCC ID	Data Cable	Power Cord
1.	System Simulator	Anritsu	MT8820C	N/A	N/A	Unshielded, 1.8m
2.	WLAN AP	D-link	DIR-655	KA21R655B1	N/A	Unshielded, 1.8m
3.	Bluetooth Earphone	Lenovo	LBH308	N/A	N/A	N/A
4.	Notebook	Lenovo	G480	QDS-BRCM1050I	N/A	AC I/P: Unshielded, 1.8 m DC O/P: Shielded, 1.8 m
5.	Earphone	Lenovo	N/A	N/A	Unshielded,1.2m	N/A

2.5 EUT Operation Test Setup

For WLAN RF test items, an engineering test program was provided and enabled to make EUT continuously transmit/receive.

For AC power line conducted emissions, the EUT was set to connect with the WLAN AP under large package sizes transmission.

2.6 Measurement Results Explanation Example

For all conducted test items:

The offset level is set in the spectrum analyzer to compensate the RF cable loss between EUT conducted output port and spectrum analyzer. With the offset compensation, the spectrum analyzer reading level is exactly the EUT RF output level.

Example :

The spectrum analyzer offset is derived from RF cable loss.

Offset = RF cable loss.

Following shows an offset computation example with cable loss 7.50 dB.

$$\begin{aligned} \text{Offset(dB)} &= \text{RF cable loss(dB)}. \\ &= 7.50 \text{ (dB)} \end{aligned}$$

3 Test Result

3.1 6dB and 26dB and 99% Occupied Bandwidth Measurement

3.1.1 Description of 6dB and 26dB and 99% Occupied Bandwidth

The minimum 6 dB bandwidth shall be at least 500 kHz.

26dB and 99% Occupied bandwidth are reporting only.

3.1.2 Measuring Instruments

The measuring equipment is listed in the section 4 of this test report.

3.1.3 Test Procedures

1. The testing follows FCC KDB 789033 D02 General UNII Test Procedures New Rules v02r01. Section C) Emission bandwidth for the band 5.725-5.85GHz
2. Set RBW = 100kHz.
3. Set the VBW $\geq 3 \times$ RBW.
4. Detector = Peak.
5. Trace mode = max hold
6. Measure the maximum width of the emission that is 6 dB down from the peak of the emission.
7. Measure and record the results in the test report.

3.1.4 Test Setup

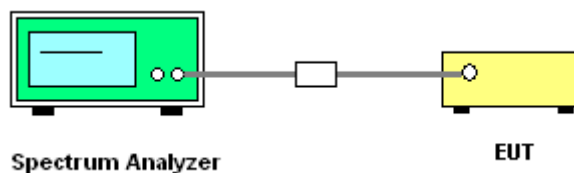

3.1.5 Test Result of 6dB Bandwidth

Please refer to Appendix A.

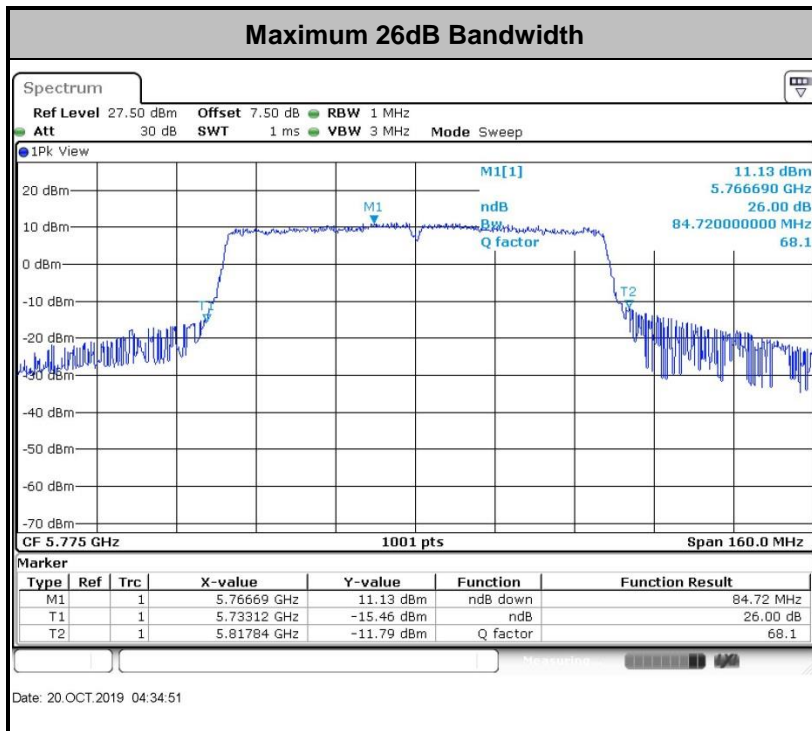
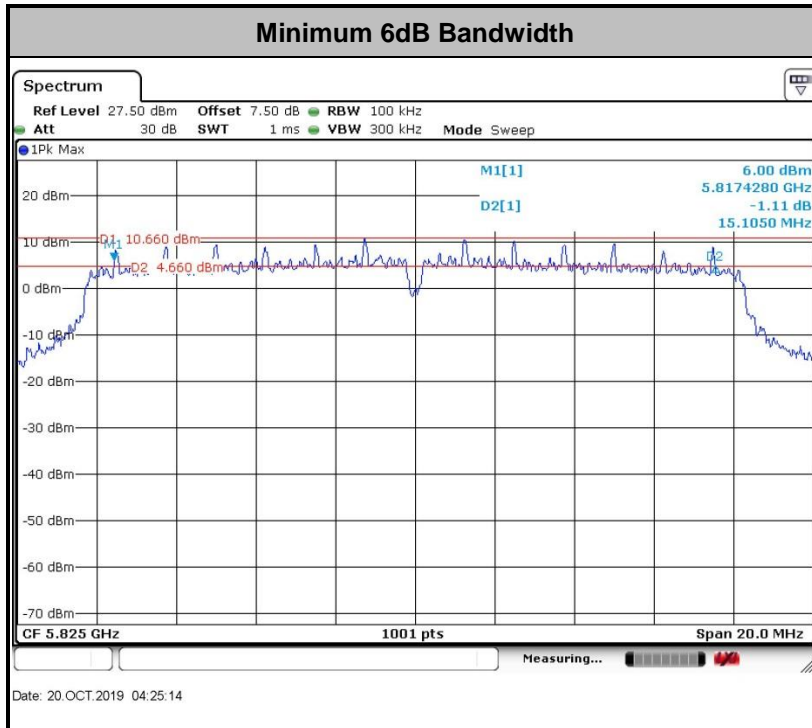

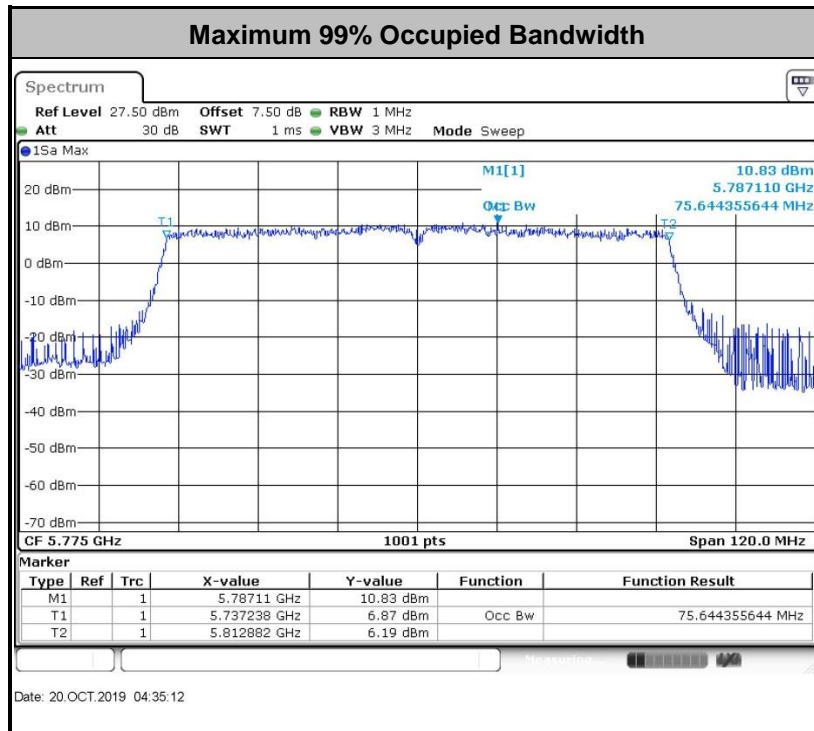

Note: The occupied channel bandwidth is maintained within the band of operation for all of the modulations.

3.2 Maximum Conducted Output Power Measurement

3.2.1 Limit of Maximum Conducted Output Power

For the band 5.725–5.85 GHz, the maximum conducted output power over the frequency band of operation shall not exceed 1 W.

If transmitting antennas of directional gain greater than 6 dBi are used, the peak output power shall be reduced by the amount in dB that the directional gain of the antenna exceeds 6 dBi.

3.2.2 Measuring Instruments

The measuring equipment is listed in the section 4 of this test report.

3.2.3 Test Procedures

The testing follows Method PM of FCC KDB 789033 D02 General UNII Test Procedures New Rules v02r01.

Method PM (Measurement using an RF average power meter):

1. Measurement is performed using a wideband RF power meter.
2. The EUT is configured to transmit continuously with a consistent duty cycle at its maximum power control level.
3. Measure the average power of the transmitter, and the average power is corrected with duty factor, $10 \log(1/x)$, where x is the duty cycle.

3.2.4 Test Setup

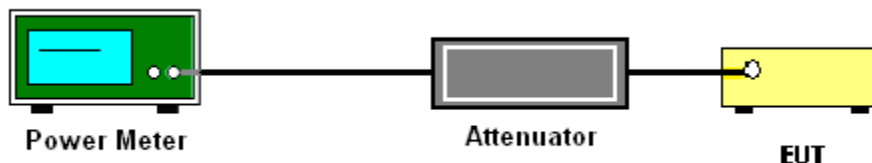

3.2.5 Test Result of Maximum Conducted Output Power

Please refer to Appendix A.



3.3 Power Spectral Density Measurement

3.3.1 Limit of Power Spectral Density

For the band 5.725–5.85 GHz, the maximum power spectral density shall not exceed 30 dBm in any 500-kHz band.

If transmitting antennas of directional gain greater than 6 dBi are used, the peak output power shall be reduced by the amount in dB that the directional gain of the antenna exceeds 6 dBi.

3.3.2 Measuring Instruments

The measuring equipment is listed in the section 4 of this test report.

3.3.3 Test Procedures

The testing follows FCC KDB 789033 D02 General UNII Test Procedures New Rules v02r01. Section F) Maximum power spectral density.

Method SA-2

(trace averaging across on and off times of the EUT transmissions, followed by duty cycle correction).

- Measure the duty cycle.
- Set span to encompass the entire emission bandwidth (EBW) of the signal.
- Set RBW = 300 kHz.
- Set VBW \geq 1 MHz.
- Number of points in sweep \geq 2 Span / RBW.
- Sweep time = auto.
- Detector = RMS
- Trace average at least 100 traces in power averaging mode.
- Add $10 \log(500\text{kHz}/\text{RBW})$ to the test result.
- Add $10 \log(1/x)$, where x is the duty cycle, to the measured power in order to compute the average power during the actual transmission times. For example, add $10 \log(1/0.25) = 6$ dB if the duty cycle is 25 percent.

1. The RF output of EUT was connected to the spectrum analyzer by a low loss cable.
2. Each plot has already offset with cable loss, and attenuator loss. Measure the PSD and record it.

3.3.4 Test Setup

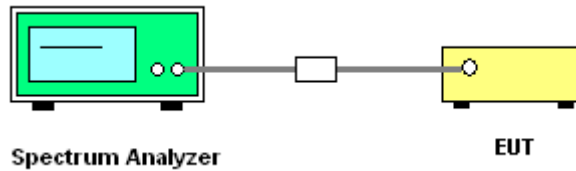

3.3.5 Test Result of Power Spectral Density

Please refer to Appendix A.

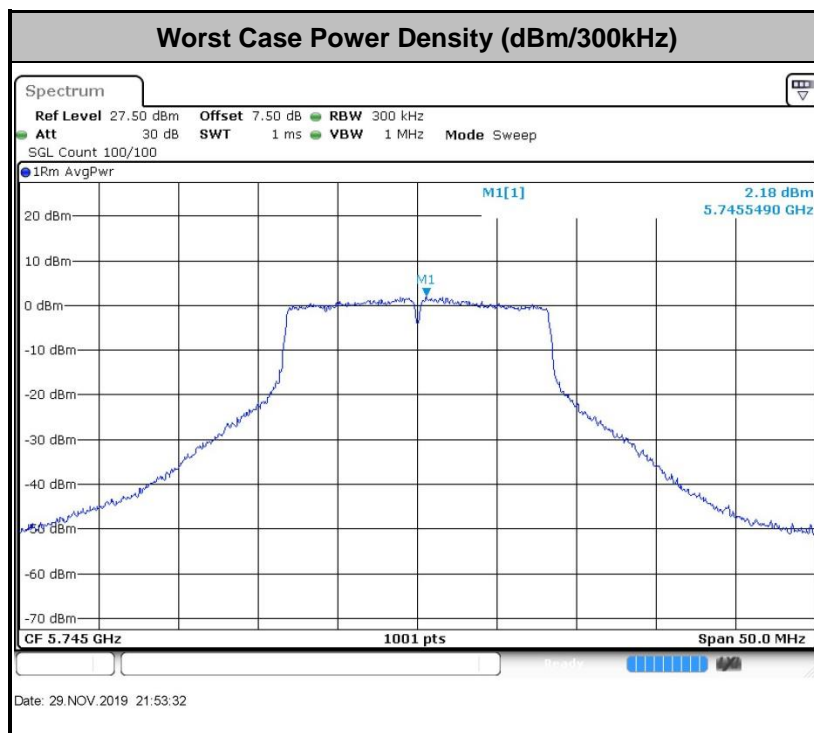



3.4 Unwanted Emissions Measurement

This section is to measure unwanted emissions through radiated measurement for band edge spurious emissions and out of band emissions measurement.

3.4.1 Limit of Unwanted Emissions

- (1) For transmitters operating in the 5.725-5.85 GHz band:
 15.407(b)(4)(i) All emissions shall be limited to a level of -27 dBm/MHz at 75 MHz or more above or below the band edge increasing linearly to 10 dBm/MHz at 25 MHz above or below the band edge, and from 25 MHz above or below the band edge increasing linearly to a level of 15.6 dBm/MHz at 5 MHz above or below the band edge, and from 5 MHz above or below the band edge increasing linearly to a level of 27 dBm/MHz at the band edge.
- (2) Unwanted spurious emissions fallen in restricted bands shall comply with the general field strength limits as below table,

Frequency (MHz)	Field Strength (microvolts/meter)	Measurement Distance (meters)
0.009 – 0.490	2400/F(kHz)	300
0.490 – 1.705	24000/F(kHz)	30
1.705 – 30.0	30	30
30 – 88	100	3
88 – 216	150	3
216 - 960	200	3
Above 960	500	3

EIRP (dBm)	Field Strength at 3m (dBµV/m)
- 27	68.3

Note: The following formula is used to convert the EIRP to field strength.

$$EIRP = E_{Meas} + 20\log (d_{Meas}) -104.7$$

where

EIRP is the equivalent isotropically radiated power, in dBm

E_{Meas} is the field strength of the emission at the measurement distance, in dBµV/m

d_{Meas} is the measurement distance, in m

3.4.2 Measuring Instruments

The measuring equipment is listed in the section 4 of this test report.



3.4.3 Test Procedures

1. The testing follows FCC KDB 789033 D02 General UNII Test Procedures New Rules v02r01. Section G) Unwanted emissions measurement.
 - (1) Procedure for Unwanted Emissions Measurements Below 1000MHz
 - RBW = 120 kHz
 - VBW = 300 kHz
 - Detector = Peak
 - Trace mode = max hold
 - (2) Procedure for Peak Unwanted Emissions Measurements Above 1000 MHz
 - RBW = 1 MHz
 - VBW \geq 3 MHz
 - Detector = Peak
 - Sweep time = auto
 - Trace mode = max hold
 - (3) Procedures for Average Unwanted Emissions Measurements Above 1000MHz
 - RBW = 1 MHz
 - VBW = 10 Hz, when duty cycle is no less than 98 percent.
 - VBW \geq 1/T, when duty cycle is less than 98 percent where T is the minimum transmission duration over which the transmitter is on and is transmitting at its maximum power control level for the tested mode of operation.
2. The EUT was placed on a turntable with 0.8 meter for frequency below 1GHz and 1.5 meter for frequency above 1GHz respectively above ground.
3. The EUT was set 3 meters from the interference receiving antenna which was mounted on the top of a variable height antenna tower.
4. The antenna is a broadband antenna and its height is adjusted between one meter and four meters above ground to find the maximum value of the field strength for both horizontal polarization and vertical polarization of the antenna.
5. For each suspected emission, the EUT was arranged to its worst case and then adjust the antenna tower (from 1 m to 4 m) and turntable (from 0 degree to 360 degrees) to find the maximum reading.
6. For testing below 1GHz, if the emission level of the EUT in peak mode was 3 dB lower than the limit specified, then peak values of EUT will be reported, otherwise, the emissions will be repeated one by one using the CISPR quasi-peak method and reported.
7. For testing above 1GHz, the emission level of the EUT in peak mode was 20dB lower than average limit (that means the emission level in average mode also complies with the limit in average mode), then peak values of EUT will be reported, otherwise, the emissions will be measured in average mode again and reported.

3.4.4 Test Setup

For radiated emissions below 30MHz

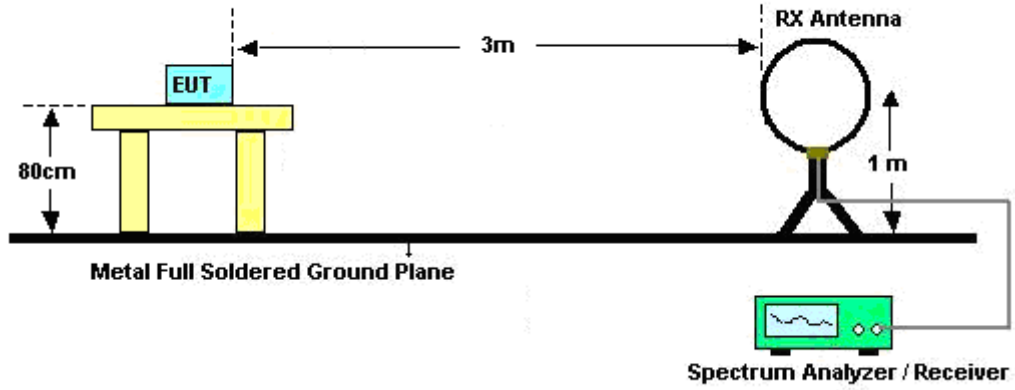

For radiated emissions from 30MHz to 1GHz

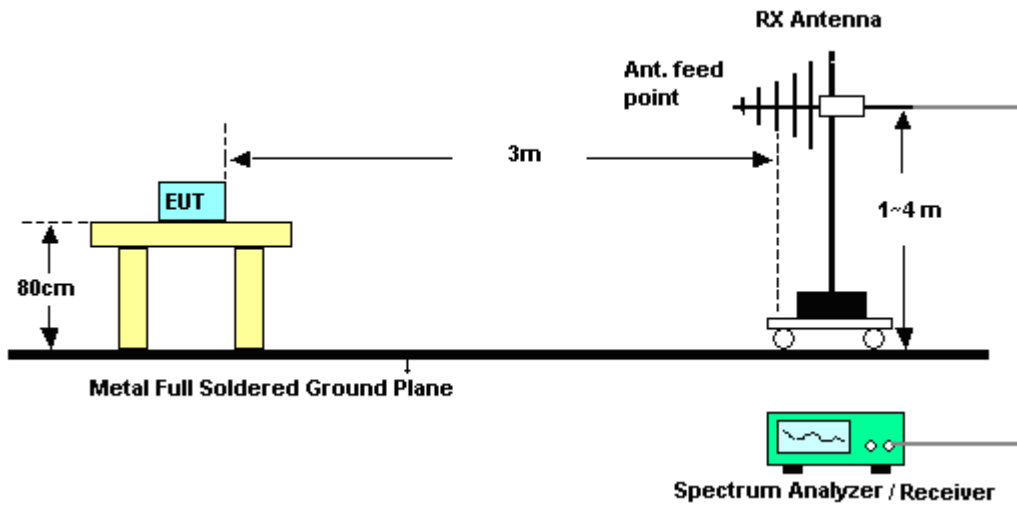

For radiated emissions above 1GHz

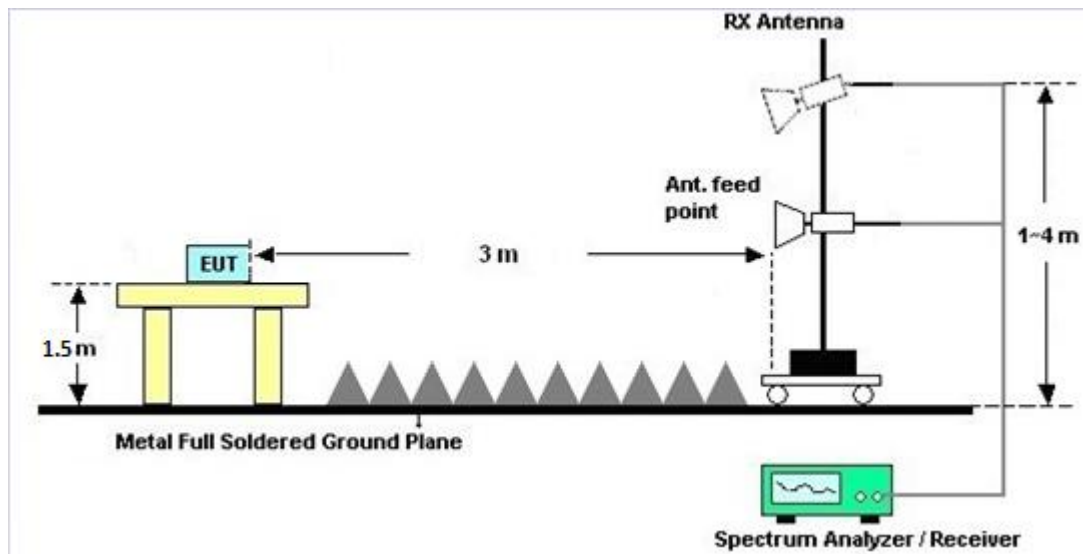

3.4.5 Test Results of Radiated Emissions (9 kHz ~ 30 MHz)

The low frequency, which started from 9 kHz to 30MHz, was pre-scanned and the result which was 20dB lower than the limit line was not reported.

There is a comparison data of both open-field test site and semi-Anechoic chamber, and the result came out very similar.

3.4.6 Test Result of Radiated Band Edges

Please refer to Appendix C.

3.4.7 Duty Cycle

Please refer to Appendix D.

3.4.8 Test Result of Unwanted Radiated Emission (30MHz ~ 10th Harmonic)

Please refer to Appendix C.



3.5 AC Conducted Emission Measurement

3.5.1 Limit of AC Conducted Emission

For equipment that is designed to be connected to the public utility (AC) power line, the radio frequency voltage that is conducted back onto the AC power line on any frequency or frequencies within the band 150 kHz to 30 MHz shall not exceed the limits in the following table.

Frequency of emission (MHz)	Conducted limit (dBµV)	
	Quasi-peak	Average
0.15-0.5	66 to 56*	56 to 46*
0.5-5	56	46
5-30	60	50

*Decreases with the logarithm of the frequency.

3.5.2 Measuring Instruments

The measuring equipment is listed in the section 4 of this test report.

3.5.3 Test Procedures

1. The EUT was placed 0.4 meter from the conducting wall of the shielding room was kept at least 80 centimeters from any other grounded conducting surface.
2. Connect EUT to the power mains through a line impedance stabilization network (LISN).
3. All the support units are connecting to the other LISN.
4. The LISN provides 50 ohm coupling impedance for the measuring instrument.
5. The FCC states that a 50 ohm, 50 microhenry LISN should be used.
6. Both sides of AC line were checked for maximum conducted interference.
7. The frequency range from 150 kHz to 30 MHz was searched.
8. Set the test-receiver system to Peak Detect Function and specified bandwidth with Maximum Hold Mode.

3.5.4 Test Setup



3.5.5 Test Result of AC Conducted Emission

Please refer to Appendix B.



3.6 Automatically Discontinue Transmission

3.6.1 Limit of Automatically Discontinue Transmission

The device shall automatically discontinue transmission in case of either absence of information to transmit or operational failure. These provisions are not intended to preclude the transmission of control or signaling information or the use of repetitive codes used by certain digital technologies to complete frame or burst intervals. Applicants shall include in their application for equipment authorization to describe how this requirement is met.

3.6.2 Measuring Instruments

The measuring equipment is listed in the section 4 of this test report.

3.6.3 Test Result of Automatically Discontinue Transmission

While the EUT is not transmitting any information, the EUT can automatically discontinue transmission and become standby mode for power saving. The EUT can detect the controlling signal of ACK message transmitting from remote device and verify whether it shall resend or discontinue transmission.



3.7 Antenna Requirements

3.7.1 Standard Applicable

If transmitting antenna directional gain is greater than 6 dBi, both the peak transmit power and the peak power spectral density shall be reduced by the amount in dB that the directional gain of the antenna exceeds 6 dBi.

3.7.2 Antenna Anti-Replacement Construction

An embedded-in antenna design is used.

3.7.3 Antenna Gain

The antenna peak gain of EUT is less than 6 dBi. Therefore, it is not necessary to reduce maximum peak output power limit.



4 List of Measuring Equipment

Instrument	Manufacturer	Model No.	Serial No.	Characteristics	Calibration Date	Test Date	Due Date	Remark
Spectrum Analyzer	R&S	FSV40	101040	10Hz~40GHz	Aug. 07, 2019	Oct. 20, 2019~Nov. 29, 2019	Aug. 06, 2020	Conducted (TH01-KS)
Pulse Power Sensor	Anritsu	MA2411B	0917070	300MHz~40GHz	Jan. 14, 2019	Oct. 20, 2019~Nov. 29, 2019	Jan. 13, 2020	Conducted (TH01-KS)
Power Meter	Anritsu	ML2495A	1005002	50MHz Bandwidth	Jan. 14, 2019	Oct. 20, 2019~Nov. 29, 2019	Jan. 13, 2020	Conducted (TH01-KS)
EMI Test Receiver	Keysight	N9038A	MY57290157	3Hz~8.5GHz;Max 30dBm	Jul. 18, 2019	Nov. 20, 2019	Jul. 17, 2020	Radiation (03CH06-KS)
EXA Spectrum Analyzer	Keysight	N9010A	MY55150208	10Hz~44GHz	Apr. 16, 2019	Nov. 20, 2019	Apr. 15, 2020	Radiation (03CH06-KS)
Loop Antenna	R&S	HFH2-Z2	100321	9kHz~30MHz	Oct. 18, 2019	Nov. 20, 2019	Oct. 17, 2020	Radiation (03CH06-KS)
Bilog Antenna	TeseQ	CBL6111D	44483	30MHz~1GHz	Dec. 28, 2018	Nov. 20, 2019	Dec. 27, 2019	Radiation (03CH06-KS)
Double Ridge Horn Antenna	ETS-Lindgren	3117	75959	1GHz~18GHz	Jan. 27, 2019	Nov. 20, 2019	Jan. 26, 2020	Radiation (03CH06-KS)
SHF-EHF Horn	Com-power	AH-840	101070	18GHz~40GHz	Jan. 05, 2019	Nov. 20, 2019	Jan. 04, 2020	Radiation (03CH06-KS)
Amplifier	SONOMA	310N	187289	9KHz ~1GHZ	Aug. 06, 2019	Nov. 20, 2019	Aug. 05, 2020	Radiation (03CH06-KS)
Amplifier	MITEQ	TTA1840-35-HG	2014749	18~40GHz	Jan. 14, 2019	Nov. 20, 2019	Jan. 13, 2020	Radiation (03CH06-KS)
high gain Amplifier	MITEQ	AMF-7D-00101800-30-10P	2025788	1Ghz-18Ghz	Aug. 16, 2019	Nov. 20, 2019	Aug. 15, 2020	Radiation (03CH06-KS)
Amplifier	Keysight	83017A	MY53270203	500MHz~26.5GHz	Apr. 15, 2019	Nov. 20, 2019	Apr. 14, 2020	Radiation (03CH06-KS)
AC Power Source	Chroma	61601	F104090004	N/A	NCR	Nov. 20, 2019	NCR	Radiation (03CH06-KS)
Turn Table	ChamPro	EM 1000-T	060762-T	0~360 degree	NCR	Nov. 20, 2019	NCR	Radiation (03CH06-KS)
Antenna Mast	ChamPro	EM 1000-A	060762-A	1 m~4 m	NCR	Nov. 20, 2019	NCR	Radiation (03CH06-KS)
EMI Receiver	R&S	ESC17	100768	9kHz~7GHz;	Apr. 16, 2019	Oct. 30, 2019	Apr. 15, 2020	Conduction (CO01-KS)
AC LISN	MessTec	AN3016	060103	9kHz~30MHz	Oct. 11, 2019	Oct. 30, 2019	Oct. 10, 2020	Conduction (CO01-KS)
AC LISN (for auxiliary equipment)	MessTec	AN3016	060105	9kHz~30MHz	Nov. 19, 2018	Oct. 30, 2019	Nov. 18, 2019	Conduction (CO01-KS)
AC Power Source	Chroma	61602	ABP000000811	AC 0V~300V, 45Hz~1000Hz	Oct. 11, 2019	Oct. 30, 2019	Oct. 10, 2020	Conduction (CO01-KS)

NCR: No Calibration Required



5 Uncertainty of Evaluation

The measurement uncertainties shown below were calculated in accordance with the requirements of ANSI 63.10-2013. All the measurement uncertainty value were shown with a coverage K=2 to indicate 95% level of confidence. The measurement data show herein meets or exceeds the CISPR measurement uncertainty values specified in CISPR 16-4-2 and can be compared directly to specified limit to determine compliance.

Uncertainty of Conducted Emission Measurement (150kHz ~ 30MHz)

Measuring Uncertainty for a Level of Confidence of 95% (U = 2Uc(y))	2.9dB
---	-------

Uncertainty of Radiated Emission Measurement (30 MHz ~ 1000 MHz)

Measuring Uncertainty for a Level of Confidence of 95% (U = 2Uc(y))	5.0dB
---	-------

Uncertainty of Radiated Emission Measurement (1000 MHz ~ 18000 MHz)

Measuring Uncertainty for a Level of Confidence of 95% (U = 2Uc(y))	5.0dB
---	-------

Uncertainty of Radiated Emission Measurement (18000 MHz ~ 40000 MHz)

Measuring Uncertainty for a Level of Confidence of 95% (U = 2Uc(y))	5.0dB
---	-------



Appendix A. Conducted Test Results

Test Engineer:	Aly Cao	Temperature:	21~25	°C
Test Date:	2019/10/20~2019/11/29	Relative Humidity:	51~54	%

TEST RESULTS DATA
6dB and 26dB EBW and 99% OBW

Band IV									
Mod.	Data Rate	N _{TX}	CH.	Freq. (MHz)	99% Bandwidth (MHz)	26 dB Bandwidth (MHz)	6 dB Bandwidth (MHz)	6dB Bandwidth min. Limit (MHz)	Pass/Fail
11a	6M bps	1	149	5745	17.58	23.726	15.524	0.5	Pass
11a	6Mbps	1	157	5785	17.58	23.826	15.644	0.5	Pass
11a	6Mbps	1	165	5825	17.48	23.427	15.105	0.5	Pass
HT20	MCS 0	1	149	5745	18.58	24.625	15.125	0.5	Pass
HT20	MCS 0	1	157	5785	18.58	24.575	15.125	0.5	Pass
HT20	MCS 0	1	165	5825	18.63	24.226	15.485	0.5	Pass
HT40	MCS 0	1	151	5755	36.56	41.988	35.524	0.5	Pass
HT40	MCS 0	1	159	5795	36.46	41.808	35.125	0.5	Pass
VHT80	MCS 0	1	155	5775	75.64	84.72	75.125	0.5	Pass

TEST RESULTS DATA
Average Power Table

Band IV										
Mod.	Data Rate	N _{TX}	CH.	Freq. (MHz)	Duty Factor (dB)	Average Conducted Power (dBm)	FCC Conducted Power Limit (dBm)	DG (dBi)		Pass/Fail
11a	6M bps	1	149	5745	0.08	19.49	30.00	-5.00		Pass
11a	6Mbps	1	157	5785	0.08	19.50	30.00	-5.00		Pass
11a	6Mbps	1	165	5825	0.08	19.52	30.00	-5.00		Pass
HT20	MCS 0	1	149	5745	0.08	18.80	30.00	-5.00		Pass
HT20	MCS 0	1	157	5785	0.08	18.84	30.00	-5.00		Pass
HT20	MCS 0	1	165	5825	0.08	18.39	30.00	-5.00		Pass
HT40	MCS 0	1	151	5755	0.16	18.92	30.00	-5.00		Pass
HT40	MCS 0	1	159	5795	0.16	19.02	30.00	-5.00		Pass
VHT20	MCS 0	1	149	5745	0.08	18.32	30.00	-5.00		Pass
VHT20	MCS 0	1	157	5785	0.08	18.44	30.00	-5.00		Pass
VHT20	MCS 0	1	165	5825	0.08	18.40	30.00	-5.00		Pass
VHT40	MCS 0	1	151	5755	0.16	18.47	30.00	-5.00		Pass
VHT40	MCS 0	1	159	5795	0.16	18.67	30.00	-5.00		Pass
VHT80	MCS 0	1	155	5775	0.33	18.72	30.00	-5.00		Pass

TEST RESULTS DATA
Power Spectral Density

Band IV										
Mod.	Data Rate	NTX	CH.	Freq. (MHz)	Duty Factor (dB)	10log (500kHz /RBW) Factor (dB)	Average Power Density (dBm/500kHz)	Average PSD Limit (dBm/500kHz)	DG (dBi)	Pass/Fail
11a	6M bps	1	149	5745	0.08	2.22	4.47	30.00	-5.00	Pass
11a	6Mbps	1	157	5785	0.08	2.22	4.27	30.00	-5.00	Pass
11a	6Mbps	1	165	5825	0.08	2.22	4.21	30.00	-5.00	Pass
HT20	MCS 0	1	149	5745	0.08	2.22	3.27	30.00	-5.00	Pass
HT20	MCS 0	1	157	5785	0.08	2.22	3.25	30.00	-5.00	Pass
HT20	MCS 0	1	165	5805	0.08	2.22	3.25	30.00	-5.00	Pass
HT40	MCS 0	1	151	5755	0.16	2.22	0.53	30.00	-5.00	Pass
HT40	MCS 0	1	159	5795	0.16	2.22	0.49	30.00	-5.00	Pass
VHT80	MCS 0	1	155	5775	0.33	2.22	-3.64	30.00	-5.00	Pass



Appendix B. AC Conducted Emission Test Results

Test Engineer :	Amos Zhang	Temperature :	25.3~26.2°C
		Relative Humidity :	38~40%
Test Voltage :	120Vac / 60Hz	Phase :	Line

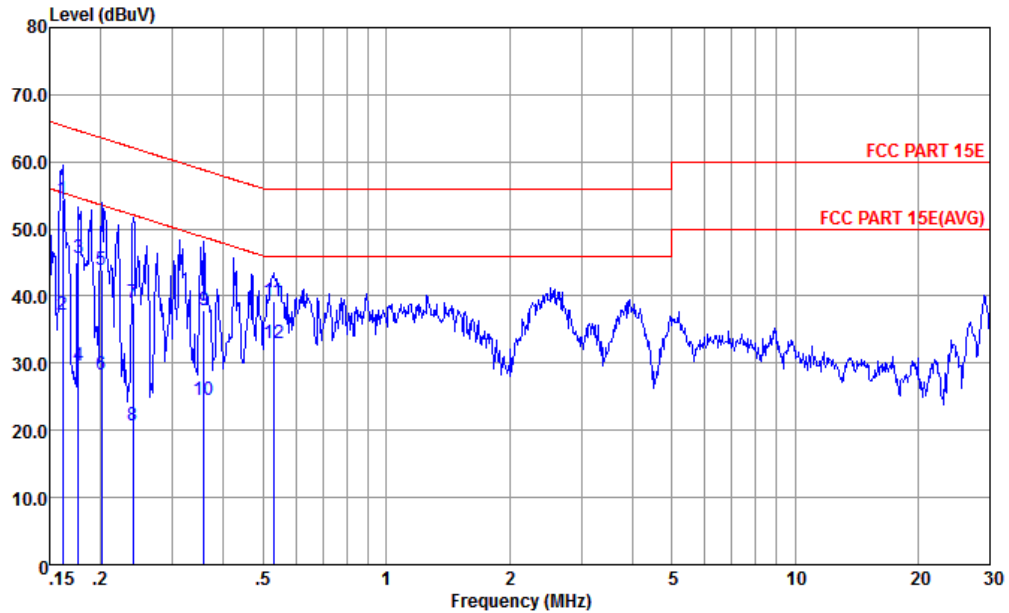

Site : CO01-KS
 Condition : FCC PART 15E LISN-L-181119-060105 LINE

	Freq	Level	Over	Limit	Read	LISN	Cable	Remark
	MHz	dBuV	Limit	Line	Level	Factor	Loss	
			dB	dBuV	dBuV	dB	dB	
1 *	0.162	54.45	-10.93	65.38	43.90	0.10	10.45	QP
2	0.162	37.15	-18.23	55.38	26.60	0.10	10.45	Average
3	0.177	45.62	-19.02	64.64	35.10	0.11	10.41	QP
4	0.177	29.72	-24.92	54.64	19.20	0.11	10.41	Average
5	0.201	43.98	-19.60	63.58	33.50	0.12	10.36	QP
6	0.201	28.38	-25.20	53.58	17.90	0.12	10.36	Average
7	0.240	39.07	-23.01	62.08	28.60	0.13	10.34	QP
8	0.240	20.77	-31.31	52.08	10.30	0.13	10.34	Average
9	0.358	37.93	-20.85	58.78	27.50	0.15	10.28	QP
10	0.358	24.53	-24.25	48.78	14.10	0.15	10.28	Average
11	0.529	39.31	-16.69	56.00	28.90	0.17	10.24	QP
12	0.529	33.01	-12.99	46.00	22.60	0.17	10.24	Average



Test Engineer :	Amos Zhang	Temperature :	25.3~26.2°C
		Relative Humidity :	38~40%
Test Voltage :	120Vac / 60Hz	Phase :	Neutral

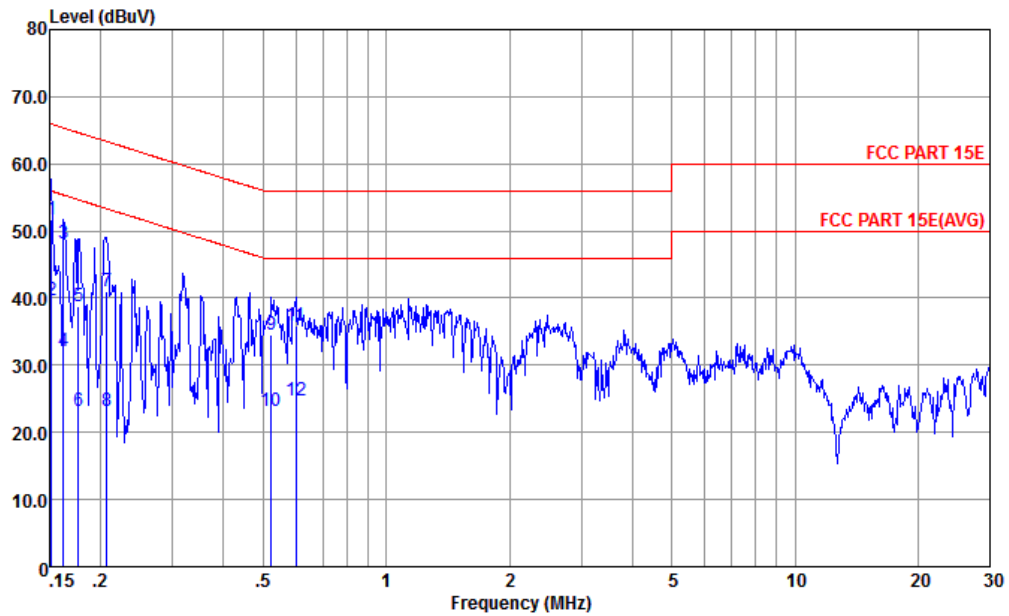

Site : CO01-KS
 Condition : FCC PART 15E LISN-N-181119-060105 NEUTRAL

	Freq	Level	Over	Limit	Read	LISN	Cable	Remark
	MHz	dBuV	Limit	Line	Level	Factor	Loss	
			dB	dBuV	dBuV	dB	dB	
1 *	0.152	51.76	-14.15	65.91	41.10	0.18	10.48	QP
2	0.152	39.56	-16.35	55.91	28.90	0.18	10.48	Average
3	0.162	48.12	-17.22	65.34	37.49	0.18	10.45	QP
4	0.162	32.12	-23.22	55.34	21.49	0.18	10.45	Average
5	0.177	38.79	-25.85	64.64	28.20	0.18	10.41	QP
6	0.177	23.09	-31.55	54.64	12.50	0.18	10.41	Average
7	0.207	41.03	-22.29	63.32	30.50	0.17	10.36	QP
8	0.207	23.13	-30.19	53.32	12.60	0.17	10.36	Average
9	0.524	34.48	-21.52	56.00	24.09	0.15	10.24	QP
10	0.524	23.28	-22.72	46.00	12.89	0.15	10.24	Average
11	0.601	35.88	-20.12	56.00	25.50	0.14	10.24	QP
12	0.601	24.68	-21.32	46.00	14.30	0.14	10.24	Average

Note:

- Level(dBμV) = Read Level(dBμV) + LISN Factor(dB) + Cable Loss(dB)
- Over Limit(dB) = Level(dBμV) – Limit Line(dBμV)



Appendix C. Radiated Spurious Emission

Band 4 - 5725~5850MHz
WIFI 802.11a (Band Edge @ 3m)

WIFI Ant.	Note	Frequency	Level	Over Limit	Limit Line	Read Level	Antenna Factor	Cable Loss	Preamp Factor	Ant Pos	Table Pos	Peak Avg.	Pol.
1		(MHz)	(dBμV/m)	(dB)	(dBμV/m)	(dBμV)	(dB/m)	(dB)	(dB)	(cm)	(deg)	(P/A)	(H/V)
802.11a CH 149 5745MHz		5628.4	56.4	-11.9	68.3	40.56	34.63	11.4	30.19	100	215	P	H
		5694.4	56.49	-44.68	101.17	40.5	34.7	11.52	30.23	100	215	P	H
		5716	57.48	-52.3	109.78	41.44	34.73	11.55	30.24	100	215	P	H
		5724.4	61.89	-59.04	120.93	45.78	34.77	11.58	30.24	100	215	P	H
		5746	109.08	-----	-----	92.93	34.8	11.61	30.26	100	215	P	H
		5746	101.57	-----	-----	85.42	34.8	11.61	30.26	100	215	A	H
		5646	56.61	-11.69	68.3	40.71	34.67	11.42	30.19	102	76	P	V
		5669.6	57.81	-25.03	82.84	41.84	34.7	11.48	30.21	102	76	P	V
		5719.6	58.81	-51.98	110.79	42.7	34.77	11.58	30.24	102	76	P	V
		5724.8	67.17	-54.67	121.84	51.06	34.77	11.58	30.24	102	76	P	V
		5746	112.59	-----	-----	96.44	34.8	11.61	30.26	102	76	P	V
		5746	105.35	-----	-----	89.2	34.8	11.61	30.26	102	76	A	V



WIFI Ant. 1	Note	Frequency (MHz)	Level (dBμV/m)	Over Limit (dB)	Limit Line (dBμV/m)	Read Level (dBμV)	Antenna Factor (dB/m)	Cable Loss (dB)	Preamp Factor (dB)	Ant Pos (cm)	Table Pos (deg)	Peak Avg. (P/A)	Pol. (H/V)
802.11a CH 165 5825MHz		5854.8	57.85	-53.51	111.36	41.33	35.03	11.82	30.33	100	129	P	H
		5866	56.88	-50.94	107.82	40.37	35.03	11.82	30.34	100	129	P	H
		5919.2	58.13	-14.45	72.58	41.5	35.13	11.87	30.37	100	129	P	H
		5989.6	57.66	-10.64	68.3	40.84	35.3	11.94	30.42	100	129	P	H
		5830	108.24	-----	-----	91.82	34.97	11.76	30.31	100	129	P	H
		5830	100.43	-----	-----	84.01	34.97	11.76	30.31	100	129	A	H
		5853.2	58.68	-56.32	115	42.22	35	11.79	30.33	100	75	P	V
		5859.6	57.73	-51.88	109.61	41.22	35.03	11.82	30.34	100	75	P	V
		5923.2	58.47	-11.16	69.63	41.79	35.17	11.88	30.37	100	75	P	V
		5938.8	57.14	-11.16	68.3	40.43	35.2	11.9	30.39	100	75	P	V
		5824	112.41	-----	-----	95.99	34.97	11.76	30.31	100	75	P	V
		5824	104.52	-----	-----	88.1	34.97	11.76	30.31	100	75	A	V
Remark	<ol style="list-style-type: none"> No other spurious found. All results are PASS against Peak and Average limit line. 												



Band 4 5725~5850MHz

WIFI 802.11a (Harmonic @ 3m)

WIFI Ant. 1	Note	Frequency (MHz)	Level (dBμV/m)	Over Limit (dB)	Limit Line (dBμV/m)	Read Level (dBμV)	Antenna Factor (dB/m)	Cable Loss (dB)	Preamp Factor (dB)	Ant Pos (cm)	Table Pos (deg)	Peak Avg. (P/A)	Pol. (H/V)
802.11a CH 149		11490	41.12	-32.88	74	49.86	38.08	16.03	62.85	100	360	P	H
5745MHz		11490	41	-33	74	49.74	38.08	16.03	62.85	100	360	P	V
802.11a CH 157		11570	41.36	-32.64	74	49.82	38.17	16.11	62.74	100	360	P	H
5785MHz		11570	41.59	-32.41	74	50.05	38.17	16.11	62.74	100	360	P	V
802.11a CH 165		11650	41.65	-32.35	74	49.85	38.24	16.18	62.62	100	360	P	H
5825MHz		11650	42.46	-31.54	74	50.66	38.24	16.18	62.62	100	360	P	V
Remark	1. No other spurious found. 2. All results are PASS against Peak and Average limit line.												



Band 4 5725~5850MHz
WIFI 802.11n HT20 (Band Edge @ 3m)

Table with 14 columns: WIFI Ant. 1, Note, Frequency (MHz), Level (dBµV/m), Over Limit (dB), Limit Line (dBµV/m), Read Level (dBµV), Antenna Factor (dB/m), Cable Loss (dB), Preamp Factor (dB), Ant Pos (cm), Table Pos (deg), Peak Avg. (P/A), Pol. (H/V). Rows include data for 802.11n HT20 and CH 149 5745MHz.



WIFI Ant. 1	Note	Frequency (MHz)	Level (dBμV/m)	Over Limit (dB)	Limit Line (dBμV/m)	Read Level (dBμV)	Antenna Factor (dB/m)	Cable Loss (dB)	Preamp Factor (dB)	Ant Pos (cm)	Table Pos (deg)	Peak Avg. (P/A)	Pol. (H/V)
802.11n HT20 CH 165 5825MHz		5853.2	58.35	-56.65	115	41.89	35	11.79	30.33	100	126	P	H
		5872.8	56.66	-49.26	105.92	40.09	35.07	11.84	30.34	100	126	P	H
		5919.2	57.84	-14.74	72.58	41.21	35.13	11.87	30.37	100	126	P	H
		5996.4	56.61	-11.69	68.3	39.79	35.3	11.94	30.42	100	126	P	H
		5830	108.15	-----	-----	91.73	34.97	11.76	30.31	100	126	P	H
		5830	101.07	-----	-----	84.65	34.97	11.76	30.31	100	126	A	H
		5850.02	57.75	-64.5	122.25	41.29	35	11.79	30.33	100	75	P	V
		5866.8	58.79	-48.8	107.59	42.28	35.03	11.82	30.34	100	75	P	V
		5892.8	58.12	-33.97	92.09	41.53	35.1	11.85	30.36	100	75	P	V
		5946.8	57.07	-11.23	68.3	40.36	35.2	11.9	30.39	100	75	P	V
		5824	111.78	-----	-----	95.36	34.97	11.76	30.31	100	75	P	V
	5824	104.97	-----	-----	88.55	34.97	11.76	30.31	100	75	A	V	
Remark	1. No other spurious found. 2. All results are PASS against Peak and Average limit line.												



Band 4 5725~5850MHz
WIFI 802.11n HT20 (Harmonic @ 3m)

Table with 14 columns: WIFI Ant. 1, Note, Frequency (MHz), Level (dBµV/m), Over Limit (dB), Limit Line (dBµV/m), Read Level (dBµV), Antenna Factor (dB/m), Cable Loss (dB), Preamp Factor (dB), Ant Pos (cm), Table Pos (deg), Peak Avg. (P/A), Pol. (H/V). Rows include data for channels 149 (5745MHz), 157 (5785MHz), and 165 (5825MHz). A Remark section at the bottom states: '1. No other spurious found. 2. All results are PASS against Peak and Average limit line.'



Band 4 5725~5850MHz
WIFI 802.11n HT40 (Band Edge @ 3m)

WIFI Ant. 1	Note	Frequency (MHz)	Level (dBμV/m)	Over Limit (dB)	Limit Line (dBμV/m)	Read Level (dBμV)	Antenna Factor (dB/m)	Cable Loss (dB)	Preamp Factor (dB)	Ant Pos (cm)	Table Pos (deg)	Peak Avg. (P/A)	Pol. (H/V)
802.11n HT40 CH 151 5755MHz		5616	56.96	-11.34	68.3	41.13	34.63	11.4	30.2	100	198	P	H
		5695.2	57.39	-44.37	101.76	41.4	34.7	11.52	30.23	100	198	P	H
		5719.2	66.85	-43.83	110.68	50.74	34.77	11.58	30.24	100	198	P	H
		5723.6	65.83	-53.28	119.11	49.72	34.77	11.58	30.24	100	198	P	H
		5850.4	55.69	-65.7	121.39	39.23	35	11.79	30.33	100	198	P	H
		5862.4	55.75	-53.08	108.83	39.24	35.03	11.82	30.34	100	198	P	H
		5907.6	56.39	-24.75	81.14	39.75	35.13	11.87	30.36	100	198	P	H
		5996.4	56.76	-11.54	68.3	39.94	35.3	11.94	30.42	100	198	P	H
		5752	105.44	-----	-----	89.23	34.83	11.64	30.26	100	198	P	H
		5752	98.46	-----	-----	82.25	34.83	11.64	30.26	100	198	A	H
		5638.8	58.02	-10.28	68.3	42.12	34.67	11.42	30.19	100	121	P	V
		5697.2	59.1	-44.14	103.24	43.11	34.7	11.52	30.23	100	121	P	V
		5716.4	70.47	-39.42	109.89	54.43	34.73	11.55	30.24	100	121	P	V
		5722.8	72.88	-44.4	117.28	56.77	34.77	11.58	30.24	100	121	P	V
		5852.8	57.43	-58.49	115.92	40.97	35	11.79	30.33	100	121	P	V
		5855.2	57.4	-53.44	110.84	40.88	35.03	11.82	30.33	100	121	P	V
		5923.6	57.77	-11.56	69.33	41.09	35.17	11.88	30.37	100	121	P	V
		5985.6	57.21	-11.09	68.3	40.43	35.27	11.93	30.42	100	121	P	V
		5752	110.45	-----	-----	94.24	34.83	11.64	30.26	100	121	P	V
	5752	103.83	-----	-----	87.62	34.83	11.64	30.26	100	121	A	V	



WIFI Ant. 1	Note	Frequency (MHz)	Level (dBμV/m)	Over Limit (dB)	Limit Line (dBμV/m)	Read Level (dBμV)	Antenna Factor (dB/m)	Cable Loss (dB)	Preamp Factor (dB)	Ant Pos (cm)	Table Pos (deg)	Peak Avg. (P/A)	Pol. (H/V)
802.11n HT40 CH 159 5795MHz		5650	55.64	-12.66	68.3	39.68	34.7	11.45	30.19	103	197	P	H
		5700	56.65	-48.65	105.3	40.66	34.7	11.52	30.23	103	197	P	H
		5715.6	56.87	-52.8	109.67	40.83	34.73	11.55	30.24	103	197	P	H
		5720.4	55.82	-55.99	111.81	39.71	34.77	11.58	30.24	103	197	P	H
		5853.2	57.19	-57.81	115	40.73	35	11.79	30.33	103	197	P	H
		5865.2	57.47	-50.57	108.04	40.96	35.03	11.82	30.34	103	197	P	H
		5898	57.08	-31.16	88.24	40.49	35.1	11.85	30.36	103	197	P	H
		5982	57.4	-10.9	68.3	40.6	35.27	11.93	30.4	103	197	P	H
		5800	104.75	-----	-----	88.45	34.9	11.7	30.3	103	197	P	H
		5800	97.56	-----	-----	81.26	34.9	11.7	30.3	103	197	A	H
		5632	57.18	-11.12	68.3	41.34	34.63	11.4	30.19	101	75	P	V
		5678	57.51	-31.55	89.06	41.54	34.7	11.48	30.21	101	75	P	V
		5704	57.58	-48.84	106.42	41.53	34.73	11.55	30.23	101	75	P	V
		5724.8	56.68	-65.16	121.84	40.57	34.77	11.58	30.24	101	75	P	V
		5854	58.01	-55.17	113.18	41.49	35.03	11.82	30.33	101	75	P	V
		5855.2	57.91	-52.93	110.84	41.39	35.03	11.82	30.33	101	75	P	V
		5884.8	57.67	-40.35	98.02	41.12	35.07	11.84	30.36	101	75	P	V
		5952	56.66	-11.64	68.3	39.95	35.2	11.9	30.39	101	75	P	V
		5794	108.8	-----	-----	92.5	34.9	11.7	30.3	101	75	P	V
	5794	103.96	-----	-----	87.66	34.9	11.7	30.3	101	75	A	V	
Remark	1. No other spurious found. 2. All results are PASS against Peak and Average limit line.												



Band 4 5725~5850MHz
WIFI 802.11n HT40 (Harmonic @ 3m)

Table with 14 columns: WIFI Ant. 1, Note, Frequency (MHz), Level (dBµV/m), Over Limit (dB), Limit Line (dBµV/m), Read Level (dBµV), Antenna Factor (dB/m), Cable Loss (dB), Preamp Factor (dB), Ant Pos (cm), Table Pos (deg), Peak Avg. (P/A), Pol. (H/V). Rows include data for 802.11n HT40 CH 151 5755MHz and CH 159 5795MHz, plus a Remark section.



Band 4 5725~5850MHz
WIFI 802.11ac VHT80 (Band Edge @ 3m)

WIFI Ant. 1	Note	Frequency (MHz)	Level (dBμV/m)	Over Limit (dB)	Limit Line (dBμV/m)	Read Level (dBμV)	Antenna Factor (dB/m)	Cable Loss (dB)	Preamp Factor (dB)	Ant Pos (cm)	Table Pos (deg)	Peak Avg. (P/A)	Pol. (H/V)
802.11ac VHT80 CH 155 5775MHz		5630	56.99	-11.31	68.3	41.15	34.63	11.4	30.19	100	196	P	H
		5688.8	64.44	-32.6	97.04	48.45	34.7	11.52	30.23	100	196	P	H
		5717.2	65.88	-44.24	110.12	49.84	34.73	11.55	30.24	100	196	P	H
		5724	67.11	-52.91	120.02	51	34.77	11.58	30.24	100	196	P	H
		5854.8	58.91	-52.45	111.36	42.39	35.03	11.82	30.33	100	196	P	H
		5856.8	57.26	-53.14	110.4	40.74	35.03	11.82	30.33	100	196	P	H
		5924.4	56.86	-11.88	68.74	40.18	35.17	11.88	30.37	100	196	P	H
		5927.2	56.45	-11.85	68.3	39.77	35.17	11.88	30.37	100	196	P	H
		5764	101.44	-----	-----	85.25	34.83	11.64	30.28	100	196	P	H
		5764	93.86	-----	-----	77.67	34.83	11.64	30.28	100	196	A	H
		5626.4	56.51	-11.79	68.3	40.68	34.63	11.4	30.2	100	122	P	V
		5688.4	67.42	-29.32	96.74	51.43	34.7	11.52	30.23	100	122	P	V
		5718.8	70.77	-39.79	110.56	54.66	34.77	11.58	30.24	100	122	P	V
		5720.4	72.88	-38.93	111.81	56.77	34.77	11.58	30.24	100	122	P	V
		5850	62.42	-59.88	122.3	45.96	35	11.79	30.33	100	122	P	V
		5855.2	62.38	-48.98	111.36	45.86	35.03	11.82	30.33	100	122	P	V
		5899.6	57.7	-29.36	87.06	41.11	35.1	11.85	30.36	100	122	P	V
		5930.4	57.25	-11.05	68.3	40.57	35.17	11.88	30.37	100	122	P	V
	5770	105.44	-----	-----	89.18	34.87	11.67	30.28	100	122	P	V	
	5770	97.83	-----	-----	81.57	34.87	11.67	30.28	100	122	A	V	

Remark

- No other spurious found.
- All results are PASS against Peak and Average limit line.



Band 4 5725~5850MHz
WIFI 802.11ac VHT80 (Harmonic @ 3m)

Table with 14 columns: WIFI Ant. 1, Note, Frequency (MHz), Level (dBµV/m), Over Limit (dB), Limit Line (dBµV/m), Read Level (dBµV), Antenna Factor (dB/m), Cable Loss (dB), Preamp Factor (dB), Ant Pos (cm), Table Pos (deg), Peak Avg. (P/A), Pol. (H/V). Rows include test results for 802.11ac VHT80 and CH 155 5775MHz, and a Remark section.



Emission below 1GHz

5GHz WIFI 802.11n HT40 (LF @ 3m)

WIFI	Note	Frequency	Level	Over	Limit	Read	Antenna	Cable	Preamp	Ant	Table	Peak	Pol.
Ant.				Limit	Line	Level	Factor	Loss	Factor	Pos	Pos	Avg.	
1		(MHz)	(dBμV/m)	(dB)	(dBμV/m)	(dBμV)	(dB/m)	(dB)	(dB)	(cm)	(deg)	(P/A)	(H/V)
5GHz 802.11n HT40 LF		49.4	18.78	-21.22	40	36.74	14.3	0.7	32.96	-----	-----	P	H
		119.24	31.76	-11.74	43.5	45.45	18.14	1.11	32.94	-----	-----	P	H
		174.53	30.57	-12.93	43.5	46.69	15.44	1.38	32.94	-----	-----	P	H
		214.3	33.54	-9.96	43.5	49.49	15.39	1.59	32.93	-----	-----	P	H
		263.77	30.19	-15.81	46	41.8	19.63	1.76	33	-----	-----	P	H
		339.43	36.51	-9.49	46	47.45	20.2	1.94	33.08	100	360	P	H
		44.55	27.68	-12.32	40	43.71	16.3	0.63	32.96	100	0	P	V
		76.56	22.11	-17.89	40	41.45	12.7	0.88	32.92	-----	-----	P	V
		115.36	25.49	-18.01	43.5	39.44	17.89	1.09	32.93	-----	-----	P	V
		220.12	25.37	-20.63	46	41.39	15.3	1.62	32.94	-----	-----	P	V
		263.77	31.01	-14.99	46	42.62	19.63	1.76	33	-----	-----	P	V
	353.98	26.73	-19.27	46	37.29	20.56	1.97	33.09	-----	-----	P	V	
Remark	1. No other spurious found. 2. All results are PASS against limit line.												



Note symbol

*	Fundamental Frequency which can be ignored. However, the level of any unwanted emissions shall not exceed the level of the fundamental frequency.
!	Test result is over limit line.
P/A	Peak or Average
H/V	Horizontal or Vertical



A calculation example for radiated spurious emission is shown as below:

WIFI	Note	Frequency	Level	Over	Limit	Read	Antenna	Cable	Preamp	Ant	Table	Peak	Pol.
Ant.				Limit	Line	Level	Factor	Loss	Factor	Pos	Pos	Avg.	
2		(MHz)	(dBμV/m)	(dB)	(dBμV/m)	(dBμV)	(dB/m)	(dB)	(dB)	(cm)	(deg)	(P/A)	(H/V)
802.11b		2390	55.45	-18.55	74	54.51	32.22	4.58	35.86	103	308	P	H
CH 01													
2412MHz		2390	43.54	-10.46	54	42.6	32.22	4.58	35.86	103	308	A	H

- Level(dBμV/m) =
Antenna Factor(dB/m) + Cable Loss(dB) + Read Level(dBμV) - Preamp Factor(dB)
- Over Limit(dB) = Level(dBμV/m) – Limit Line(dBμV/m)

For Peak Limit @ 2390MHz:

- Level(dBμV/m)
= Antenna Factor(dB/m) + Cable Loss(dB) + Read Level(dBμV) - Preamp Factor(dB)
= 32.22(dB/m) + 4.58(dB) + 54.51(dBμV) – 35.86 (dB)
= 55.45 (dBμV/m)
- Over Limit(dB)
= Level(dBμV/m) – Limit Line(dBμV/m)
= 55.45(dBμV/m) – 74(dBμV/m)
= -18.55(dB)

For Average Limit @ 2390MHz:

- Level(dBμV/m)
= Antenna Factor(dB/m) + Cable Loss(dB) + Read Level(dBμV) - Preamp Factor(dB)
= 32.22(dB/m) + 4.58(dB) + 42.6(dBμV) – 35.86 (dB)
= 43.54 (dBμV/m)
- Over Limit(dB)
= Level(dBμV/m) – Limit Line(dBμV/m)
= 43.54(dBμV/m) – 54(dBμV/m)
= -10.46(dB)

Both peak and average measured complies with the limit line, so test result is “PASS”.



Appendix D. Duty Cycle Plots

Band	Duty Cycle(%)	T(ms)	1/T(kHz)	VBW Setting
802.11a	98.26	-	-	10Hz
802.11n HT20	98.14	-	-	10Hz
802.11n HT40	96.30	0.942	1.062	1.1KHz
802.11acVHT80	92.71	0.461	2.170	2.2KHz

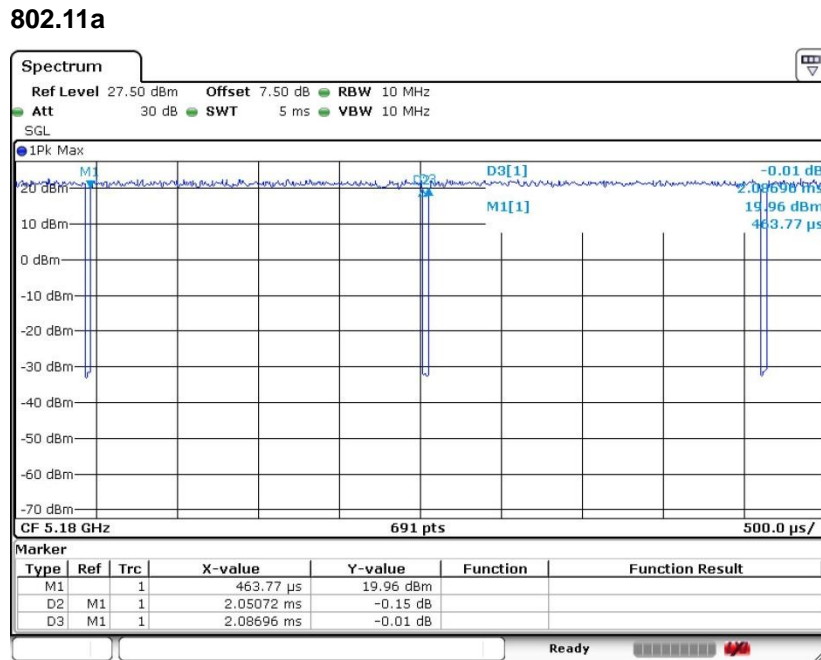



802.11n HT20

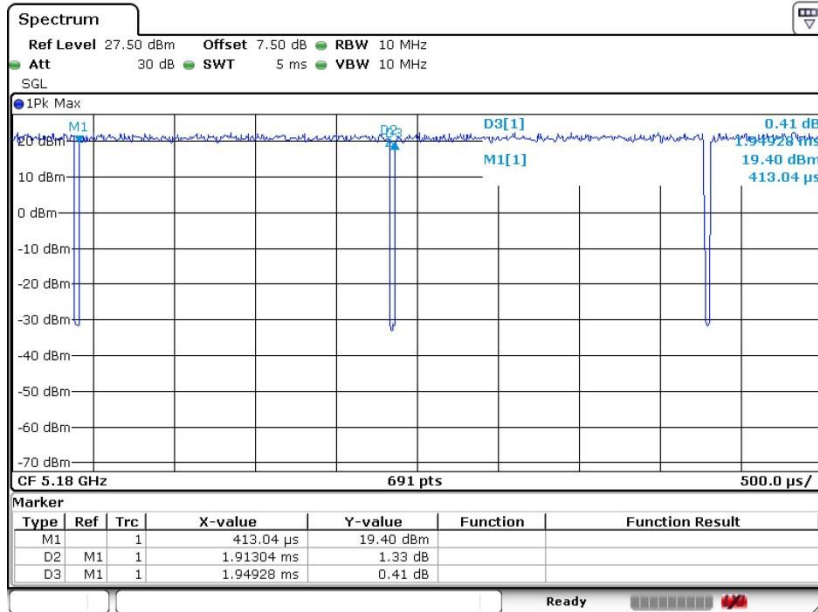

802.11n HT40

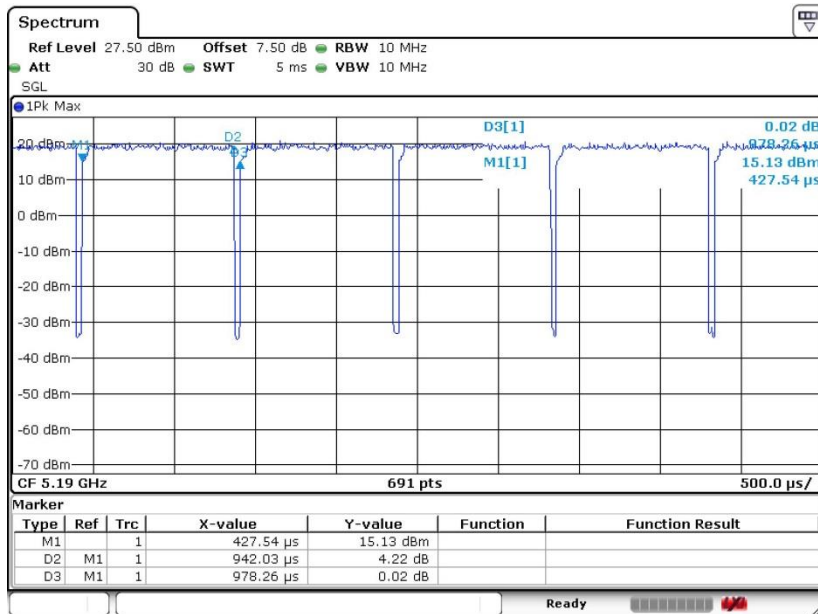



802.11ac VHT80

