



# FCC RF Test Report

**APPLICANT** : Motorola Mobility LLC  
**EQUIPMENT** : Mobile Phone  
**BRAND NAME** : Motorola  
**MODEL NAME** : XT2029-1  
**FCC ID** : IHDT56YM1  
**STANDARD** : FCC Part 15 Subpart C §15.247  
**CLASSIFICATION** : (DSS) Spread Spectrum Transmitter

The product was received on Jul. 29, 2019 and testing was completed on Aug. 20, 2019. We, Sporton International (Kunshan) Inc., would like to declare that the tested sample has been evaluated in accordance with the test procedures and has been in compliance with the applicable technical standards.

The test results in this report apply exclusively to the tested model / sample. Without written approval of Sporton International (Kunshan) Inc., the test report shall not be reproduced except in full.

*Jason Jia*

Reviewed by: Jason Jia / Supervisor

*James Huang*

Approved by: James Huang / Manager



**Sporton International (Kunshan) Inc.**

**No. 1098, Pengxi North Road, Kunshan Economic Development Zone Jiangsu Province 215300  
People's Republic of China**



TABLE OF CONTENTS

REVISION HISTORY..... 3
SUMMARY OF TEST RESULT ..... 4
1 GENERAL DESCRIPTION..... 5
1.1 Applicant ..... 5
1.2 Manufacturer ..... 5
1.3 Product Feature of Equipment Under Test..... 5
1.4 Product Specification of Equipment Under Test..... 6
1.5 Modification of EUT ..... 6
1.6 Testing Location ..... 6
1.7 Applicable Standards..... 7
1.8 Specification of Accessory..... 7
2 TEST CONFIGURATION OF EQUIPMENT UNDER TEST..... 8
2.1 Carrier Frequency Channel ..... 8
2.2 Test Mode..... 9
2.3 Connection Diagram of Test System..... 10
2.4 Support Unit used in test configuration and system ..... 11
2.5 EUT Operation Test Setup ..... 11
2.6 Measurement Results Explanation Example..... 11
3 TEST RESULT ..... 12
3.1 Number of Channel Measurement ..... 12
3.2 Hopping Channel Separation Measurement ..... 14
3.3 Dwell Time Measurement..... 21
3.4 20dB Bandwidth Measurement ..... 23
3.5 Output Power Measurement..... 30
3.6 Conducted Band Edges Measurement..... 32
3.7 Conducted Spurious Emission Measurement ..... 39
3.8 Radiated Band Edges and Spurious Emission Measurement ..... 49
3.9 AC Conducted Emission Measurement..... 53
3.10 Antenna Requirements ..... 55
4 LIST OF MEASURING EQUIPMENT..... 56
5 UNCERTAINTY OF EVALUATION..... 57
APPENDIX A. AC CONDUCTED EMISSION TEST RESULT
APPENDIX B. RADIATED SPURIOUS EMISSION
APPENDIX C. DUTY CYCLE PLOTS
APPENDIX D. SETUP PHOTOGRAPHS



## REVISION HISTORY

REPORT NO.	VERSION	DESCRIPTION	ISSUED DATE
FR972911A	Rev. 01	Initial issue of report	Sep. 11, 2019



### SUMMARY OF TEST RESULT

Report Section	FCC Rule	Description	Limit	Result	Remark
3.1	15.247(a)(1)	Number of Channels	≥ 15Chs	Pass	-
3.2	15.247(a)(1)	Hopping Channel Separation	≥ 2/3 of 20dB BW	Pass	-
3.3	15.247(a)(1)	Dwell Time of Each Channel	≤ 0.4sec in 31.6sec period	Pass	-
3.4	15.247(a)(1)	20dB Bandwidth	NA	Pass	-
3.5	15.247(b)(1)	Peak Output Power	≤ 125 mW	Pass	-
3.6	15.247(d)	Conducted Band Edges	≤ 20dBc	Pass	-
3.7	15.247(d)	Conducted Spurious Emission	≤ 20dBc	Pass	-
3.8	15.247(d)	Radiated Band Edges and Radiated Spurious Emission	15.209(a) & 15.247(d)	Pass	Under limit 6.04 dB at 46.490 MHz
3.9	15.207	AC Conducted Emission	15.207(a)	Pass	Under limit 10.93 dB at 0.156 MHz
3.10	15.203 & 15.247(b)	Antenna Requirement	N/A	Pass	-

**Declaration of Conformity:**

The test results with all measurement uncertainty excluded are presented in accordance with the regulation limits or requirements declared by manufacturers.

**Comments and Explanations:**

The declared of product specification for EUT presented in the report are provided by the manufacturer, and the manufacturer takes all the responsibilities for the accuracy of product specification.



# 1 General Description

## 1.1 Applicant

Motorola Mobility LLC  
222 W, Merchandise Mart Plaza,Chicago,IL60654 USA

## 1.2 Manufacturer

Motorola Mobility LLC  
222 W, Merchandise Mart Plaza,Chicago,IL60654 USA

## 1.3 Product Feature of Equipment Under Test

Product Feature	
Equipment	Mobile Phone
Brand Name	Motorola
Model Name	XT2029-1
FCC ID	IHDT56YM1
EUT supports Radios application	GSM/WCDMA/LTE WLAN 2.4GHz 802.11b/g/n HT20 Bluetooth BR/EDR/LE FM Receiver and GNSS
IMEI Code	Conducted: 357245100006550 Conduction: 357245100002526 Radiation: 357245100002534
HW Version	M3901-P
SW Version	POA29.101
EUT Stage	Identical Prototype

**Remark:**

1. The above EUT's information was declared by manufacturer. Please refer to the specifications or user's manual for more detailed description.
2. There are two types of EUT, the differences could refer the product equality declaration exhibit submitted. According to the difference, we choose the sample 1 (Single SIM card) to full test.



### 1.4 Product Specification of Equipment Under Test

Standards-related Product Specification	
<b>Tx/Rx Frequency Range</b>	2402 MHz ~ 2480 MHz
<b>Number of Channels</b>	79
<b>Carrier Frequency of Each Channel</b>	2402+n*1 MHz; n=0~78
<b>Maximum Output Power to Antenna</b>	Bluetooth BR(1Mbps) : 8.01 dBm (0.0063 W) Bluetooth EDR (2Mbps) : 7.03 dBm (0.0050 W) Bluetooth EDR (3Mbps) : 7.02 dBm (0.0050 W)
<b>Antenna Type / Gain</b>	Loop Antenna with gain -1.45 dBi
<b>Type of Modulation</b>	Bluetooth BR (1Mbps) : GFSK Bluetooth EDR (2Mbps) : $\pi$ /4-DQPSK Bluetooth EDR (3Mbps) : 8-DPSK

### 1.5 Modification of EUT

No modifications are made to the EUT during all test items.

### 1.6 Testing Location

Sporton International (Kunshan) Inc. is accredited to ISO/IEC 17025:2017 by American Association for Laboratory Accreditation with Certificate Number 5145.02.

<b>Test Firm</b>	Sporton International (Kunshan) Inc.		
<b>Test Site Location</b>	No. 1098, Pengxi North Road, Kunshan Economic Development Zone Jiangsu Province 215300 People's Republic of China TEL : +86-512-57900158 FAX : +86-512-57900958		
<b>Test Site No.</b>	<b>Sporton Site No.</b>	<b>FCC Designation No.</b>	<b>FCC Test Firm Registration No.</b>
	CO01-KS 03CH05-KS TH01-KS	CN1257	314309



## 1.7 Applicable Standards

According to the specifications of the manufacturer, the EUT must comply with the requirements of the following standards:

- ♦ 47 CFR Part 15 Subpart C §15.247
- ♦ FCC KDB 558074 D01 15.247 Meas Guidance v05r02
- ♦ ANSI C63.10-2013

**Remark:**

1. All test items were verified and recorded according to the standards and without any deviation during the test.
2. This EUT has also been tested and complied with the requirements of FCC Part 15, Subpart B, recorded in a separate test report.

## 1.8 Specification of Accessory

Specification of Accessory			
AC Adapter 1(US)	Brand Name	Motorola (Acbel)	Model Name SC-61
	Power Rating	I/P: 100-240 Vac, 0.13A, 50/60Hz; O/P: 5Vdc,1A	
AC Adapter 1(AR)	Brand Name	Motorola (Acbel)	Model Name SC-64
	Power Rating	I/P: 100-240 Vac, 0.13A, 50/60Hz; O/P: 5Vdc,1A	
AC Adapter 1(Chile)	Brand Name	Motorola (Acbel)	Model Name SC-62
	Power Rating	I/P: 100-240 Vac, 0.13A, 50/60Hz; O/P: 5Vdc,1A	
AC Adapter 2(US)	Brand Name	Motorola (Chenyang)	Model Name SC-61
	Power Rating	I/P: 100-240 Vac, 0.13A, 50/60Hz; O/P: 5Vdc,1A	
AC Adapter 2(AR)	Brand Name	Motorola (Chenyang)	Model Name SC-64
	Power Rating	I/P: 100-240 Vac, 0.13A, 50/60Hz; O/P: 5Vdc,1A	
Battery 1	Brand Name	Motorola(ATL)	Model Name KS40
	Power Rating	4.4Vdc,3000mAh	Type Li-ion
Battery 2	Brand Name	Motorola(Sunwoda)	Model Name KS40
	Power Rating	4.4Vdc,3000mAh	Type Li-ion
Earphone	Brand Name	Juwei Electronctcs Co ., LTD	Model Name JWEP1131-ZN01
	Signal Line Type	1.10 meter, non-shielded cable, without ferrite core	
USB Cable	Brand Name	Li Qi Electronics	Model Name LQ048018
	Signal Line Type	1.0 meter, shielded cable, without ferrite core	



## 2 Test Configuration of Equipment Under Test

### 2.1 Carrier Frequency Channel

Frequency Band	Channel	Freq. (MHz)	Channel	Freq. (MHz)	Channel	Freq. (MHz)
2400-2483.5 MHz	0	2402	27	2429	54	2456
	1	2403	28	2430	55	2457
	2	2404	29	2431	56	2458
	3	2405	30	2432	57	2459
	4	2406	31	2433	58	2460
	5	2407	32	2434	59	2461
	6	2408	33	2435	60	2462
	7	2409	34	2436	61	2463
	8	2410	35	2437	62	2464
	9	2411	36	2438	63	2465
	10	2412	37	2439	64	2466
	11	2413	38	2440	65	2467
	12	2414	39	2441	66	2468
	13	2415	40	2442	67	2469
	14	2416	41	2443	68	2470
	15	2417	42	2444	69	2471
	16	2418	43	2445	70	2472
	17	2419	44	2446	71	2473
	18	2420	45	2447	72	2474
	19	2421	46	2448	73	2475
	20	2422	47	2449	74	2476
	21	2423	48	2450	75	2477
	22	2424	49	2451	76	2478
	23	2425	50	2452	77	2479
	24	2426	51	2453	78	2480
	25	2427	52	2454	-	-
	26	2428	53	2455	-	-





## 2.2 Test Mode

- a. The EUT has been associated with peripherals and configuration operated in a manner tended to maximize its emission characteristics in a typical application. Frequency range investigated: conduction emission (150 kHz to 30 MHz), radiation emission (9 kHz to the 10th harmonic of the highest fundamental frequency or to 40 GHz, whichever is lower). For radiated measurement, pre-scanned in three orthogonal panels, X, Y, Z. The worst cases (X plane) were recorded in this report, and the worst mode of radiated spurious emissions is Bluetooth 1Mbps mode, and recorded in this report.
- b. AC power line Conducted Emission was tested under maximum output power.

The following summary table is showing all test modes to demonstrate in compliance with the standard.

Summary table of Test Cases			
Test Item	Data Rate / Modulation		
	Bluetooth BR 1Mbps GFSK	Bluetooth EDR 2Mbps $\pi/4$ -DQPSK	Bluetooth EDR 3Mbps 8-DPSK
Conducted Test Cases	Mode 1: CH00_2402 MHz	Mode 4: CH00_2402 MHz	Mode 7: CH00_2402 MHz
	Mode 2: CH39_2441 MHz	Mode 5: CH39_2441 MHz	Mode 8: CH39_2441 MHz
	Mode 3: CH78_2480 MHz	Mode 6: CH78_2480 MHz	Mode 9: CH78_2480 MHz
Radiated Test Cases	Bluetooth BR 1Mbps GFSK		
	Mode 1: CH00_2402 MHz		
	Mode 2: CH39_2441 MHz		
Mode 3: CH78_2480 MHz			
AC Conducted Emission	Mode 1 : GSM 850 Idle + Bluetooth Link + WLAN Link (2.4G) + USB Cable (Charging from Adapter 2) + Earphone		
<b>Remark:</b> 1. For radiated test cases, the worst mode data rate 1Mbps was reported only, because this data rate has the highest RF output power at preliminary tests, and no other significantly frequencies found in conducted spurious emission. 2. For Radiated Test Cases, The tests were performed with Adapter 1, Earphone and USB Cable .			

## 2.3 Connection Diagram of Test System

For Radiation

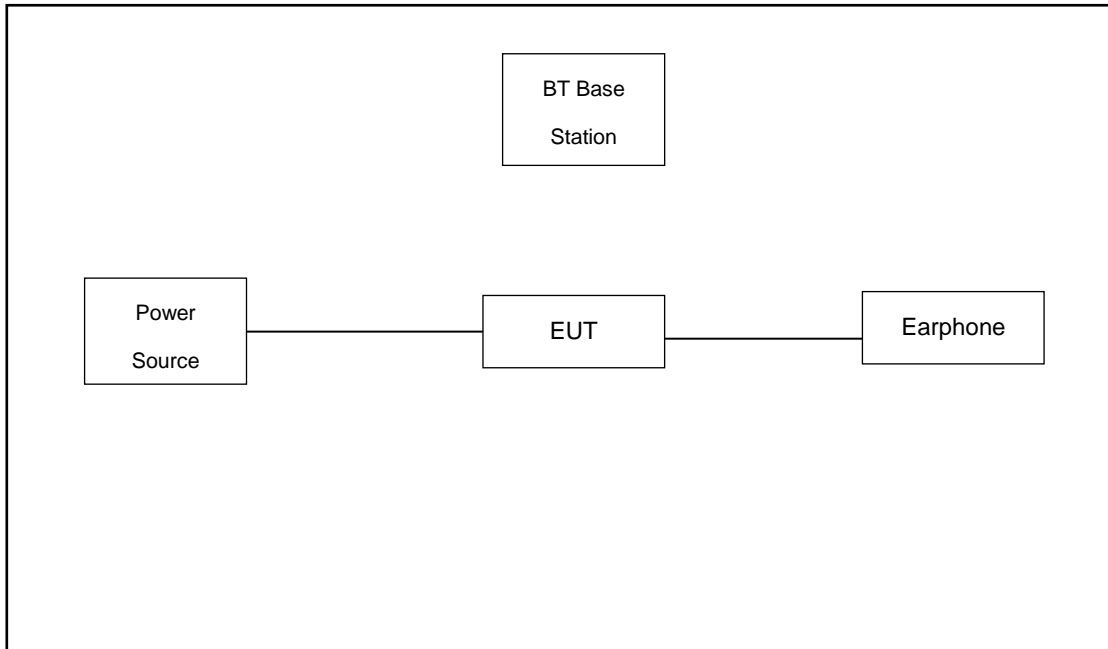

For Conducted Emission

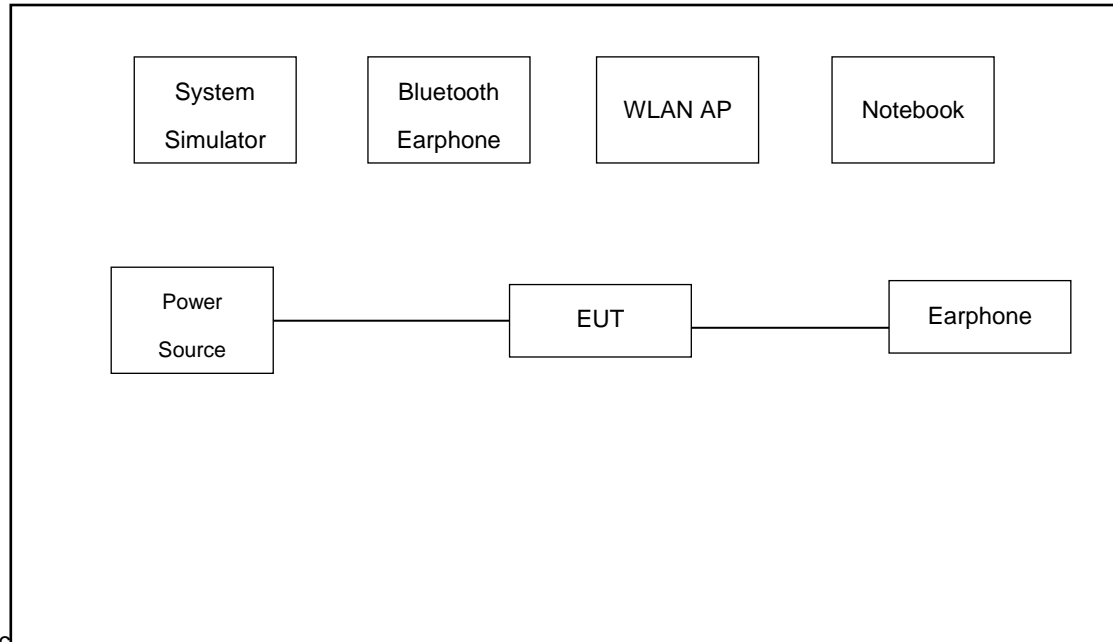

## 2.4 Support Unit used in test configuration and system

Item	Equipment	Trade Name	Model Name	FCC ID	Data Cable	Power Cord
1.	System Simulator	Anritsu	MT8820C	N/A	N/A	Unshielded, 1.8m
2.	WLAN AP	D-Link	DIR-655	KA21R655B1	N/A	Unshielded, 1.8m
3.	Notebook	Lenovo	G480	QDS-BRCM1050I	N/A	AC I/P: Unshielded, 1.8 m DC O/P: Shielded, 1.8 m
4.	Bluetooth Earphone	Lenovo	LBH308	N/A	N/A	N/A
5.	Bluetooth Base station	R&S	CBT	N/A	N/A	Unshielded, 1.8m

## 2.5 EUT Operation Test Setup

For Bluetooth function, the engineering test program was provided and enabled to make EUT connect with Bluetooth base station to continuous transmit/receive.

For AC power line conducted emissions, the EUT was set to connect with the WLAN AP under large package sizes transmission.

## 2.6 Measurement Results Explanation Example

For all conducted test items:

The offset level is set in the spectrum analyzer to compensate the RF cable loss between EUT conducted output port and spectrum analyzer. With the offset compensation, the spectrum analyzer reading level is exactly the EUT RF output level.

Example:

The spectrum analyzer offset is derived from RF cable loss.

*Offset = RF cable loss.*

Following shows an offset computation example with cable loss 5.10 dB.

$$\begin{aligned} \text{Offset(dB)} &= \text{RF cable loss(dB)} . \\ &= 5.10 \text{ (dB)} \end{aligned}$$

### 3 Test Result

#### 3.1 Number of Channel Measurement

##### 3.1.1 Limits of Number of Hopping Frequency

Frequency hopping systems in the 2400-2483.5 MHz band shall use at least 15 channels.

##### 3.1.2 Measuring Instruments

The measuring equipment is listed in the section 4 of this test report.

##### 3.1.3 Test Procedure

1. The testing follows ANSI C63.10-2013 clause 7.8.3.
2. The RF output of EUT was connected to the spectrum analyzer by RF cable and attenuator. The path loss was compensated to the results for each measurement.
3. Set to the maximum power setting and enable the EUT transmit continuously.
4. Enable the EUT hopping function.
5. Use the following spectrum analyzer settings: Span = the frequency band of operation; RBW = 300kHz; VBW  $\geq$  RBW; Sweep = auto; Detector function = peak; Trace = max hold.
6. The number of hopping frequency used is defined as the number of total channel.
7. Record the measurement data derived from spectrum analyzer.

##### 3.1.4 Test Setup

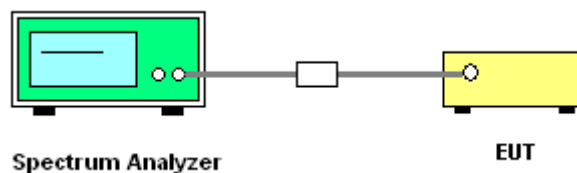



### 3.1.5 Test Result of Number of Hopping Frequency

Test Mode :	1Mbps	Temperature :	21~25°C
Test Engineer :	Lex Wu	Relative Humidity :	51~54%

Number of Hopping (Channel)	Adaptive Frequency Hopping (Channel)	Limits (Channel)	Pass/Fail
79	20	> 15	Pass

Number of Hopping Channel Plot on Channel 00 - 78

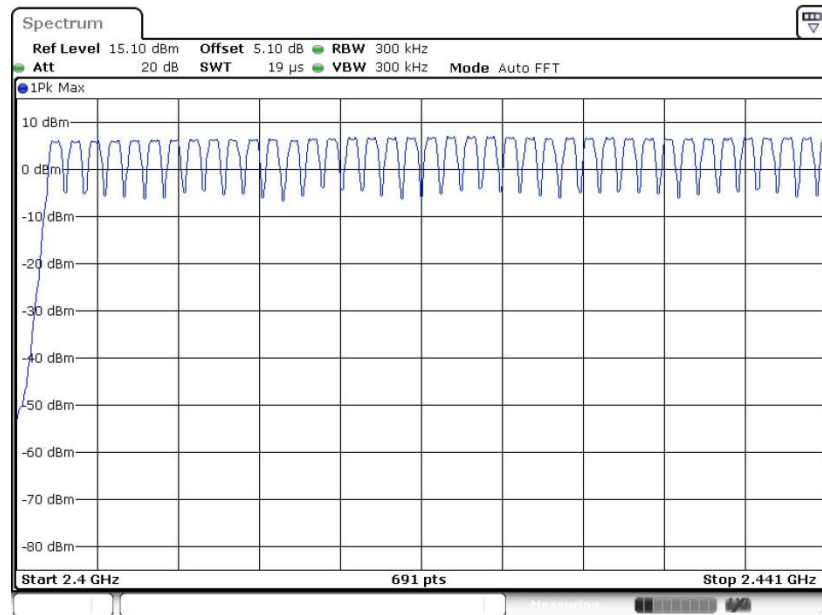

Date: 5.AUG.2019 03:54:40

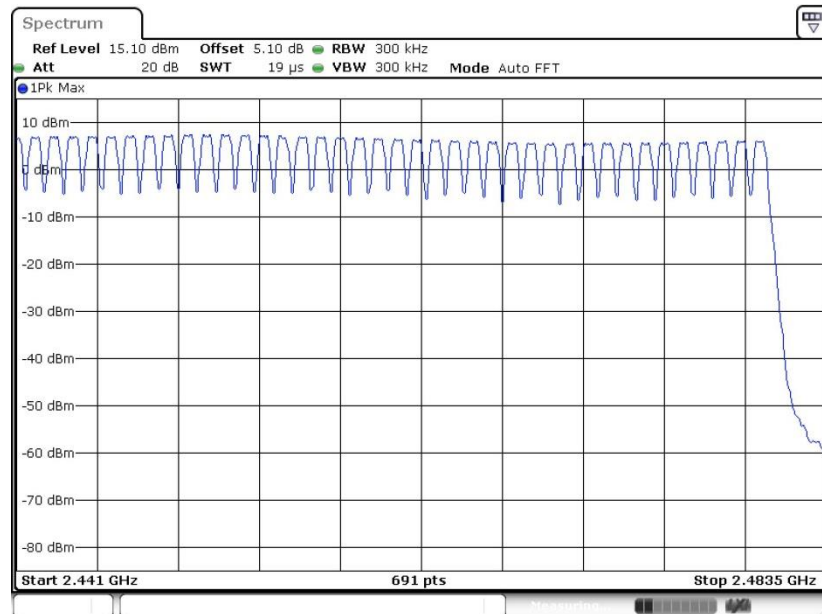

Date: 5.AUG.2019 03:55:13

## 3.2 Hopping Channel Separation Measurement

### 3.2.1 Limit of Hopping Channel Separation

Frequency hopping systems operating in the 2400-2483.5 MHz band may have hopping channel carrier frequencies that are separated by 25 kHz or two-thirds of the 20 dB bandwidth of the hopping channel, whichever is greater.

### 3.2.2 Measuring Instruments

The measuring equipment is listed in the section 4 of this test report.

### 3.2.3 Test Procedures

1. The testing follows ANSI C63.10-2013 clause 7.8.2.
2. The RF output of EUT was connected to the spectrum analyzer by RF cable and attenuator. The path loss was compensated to the results for each measurement.
3. Set to the maximum power setting and enable the EUT transmit continuously.
4. Enable the EUT hopping function.
5. Use the following spectrum analyzer settings:  
Span = wide enough to capture the peaks of two adjacent channels;  
RBW = 300kHz; VBW  $\geq$  RBW; Sweep = auto; Detector function = peak; Trace = max hold.
6. Measure and record the results in the test report.

### 3.2.4 Test Setup

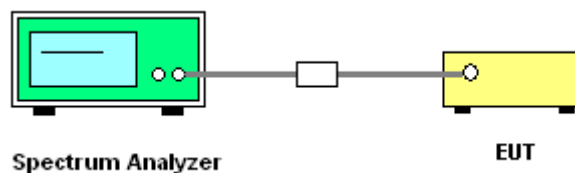



3.2.5 Test Result of Hopping Channel Separation

Test Mode :	1Mbps	Temperature :	21~25°C
Test Engineer :	Lex Wu	Relative Humidity :	51~54%

Channel	Frequency (MHz)	Frequency Separation (MHz)	(2/3 of 20dB BW) Limits (MHz)	Pass/Fail
00	2402	0.9942	0.6947	Pass
39	2441	1.0072	0.6947	Pass
78	2480	1.0029	0.6927	Pass

Channel Separation Plot on Channel 00 - 01

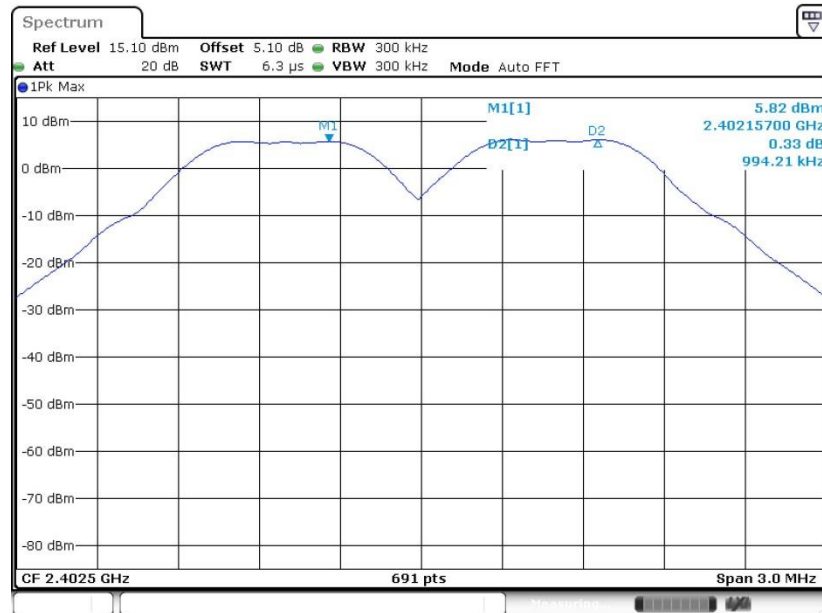

Date: 5.AUG.2019 03:44:59



Channel Separation Plot on Channel 39 - 40

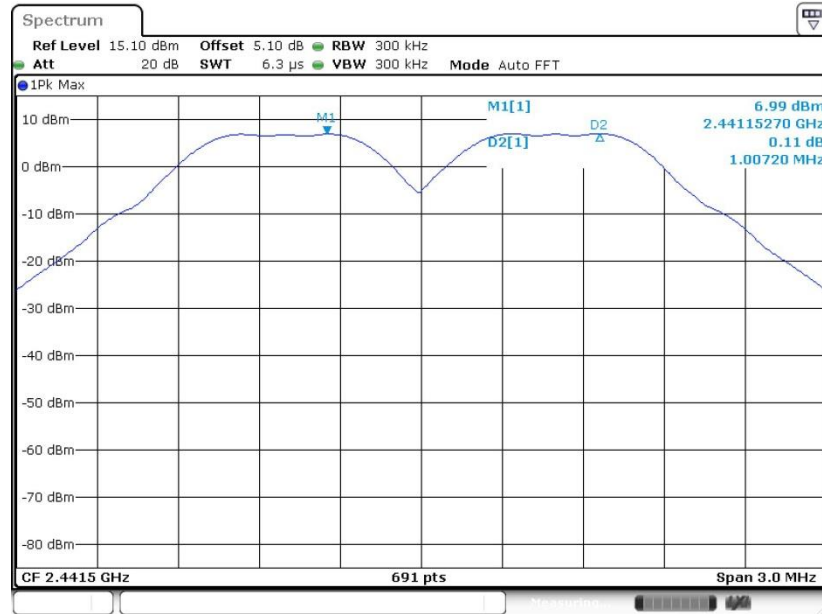

Date: 5.AUG.2019 03:57:43

Channel Separation Plot on Channel 77 - 78

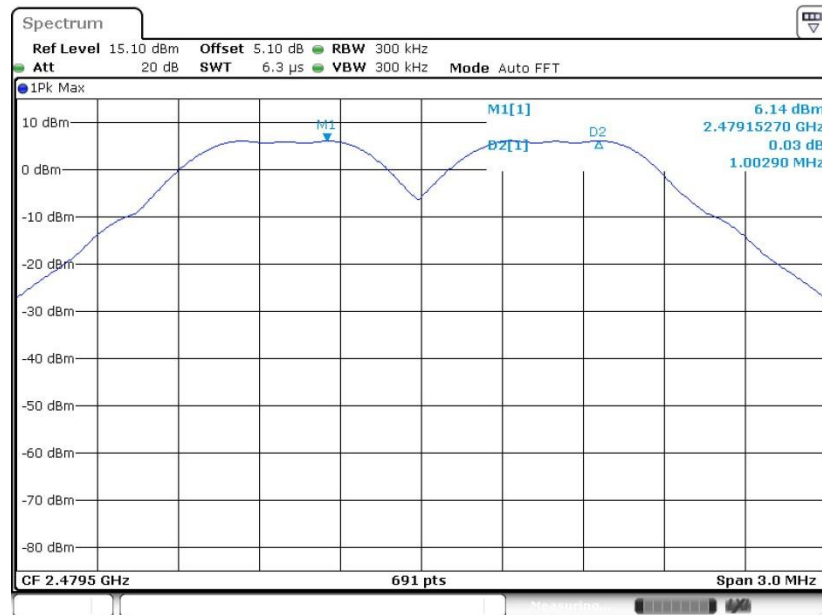

Date: 5.AUG.2019 04:02:04





Test Mode :	2Mbps	Temperature :	21~25°C
Test Engineer :	Lex Wu	Relative Humidity :	51~54%

Channel	Frequency (MHz)	Frequency Separation (MHz)	(2/3 of 20dB BW) Limits (MHz)	Pass/Fail
00	2402	1.0072	0.8365	Pass
39	2441	0.9986	0.8365	Pass
78	2480	0.9986	0.8365	Pass

Channel Separation Plot on Channel 00 - 01

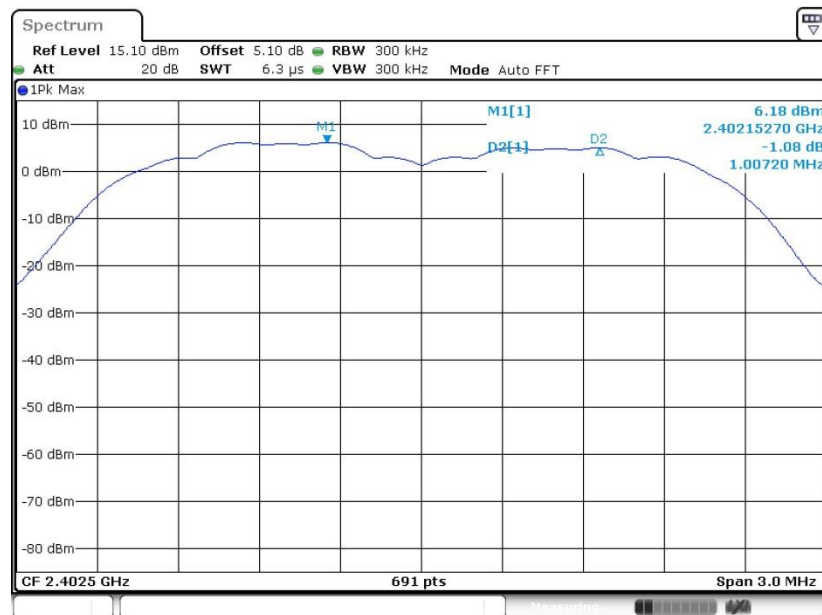

Date: 5.AUG.2019 04:08:13



Channel Separation Plot on Channel 39 - 40

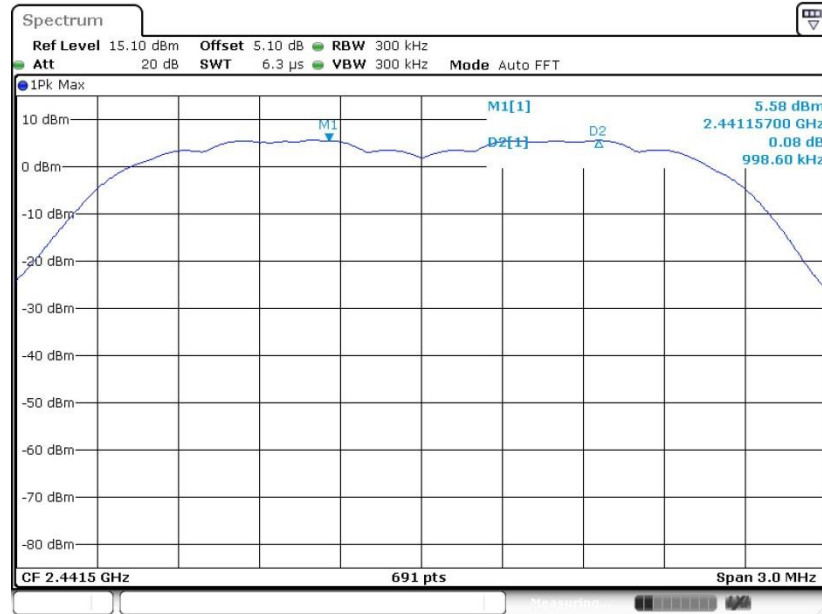

Date: 5.AUG.2019 04:16:53

Channel Separation Plot on Channel 77 - 78

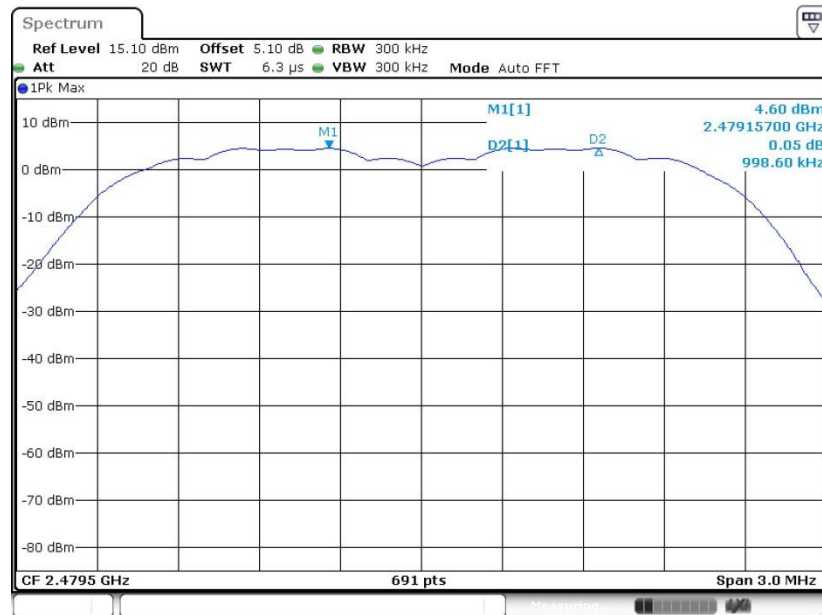

Date: 5.AUG.2019 04:23:52



Test Mode :	3Mbps	Temperature :	21~25°C
Test Engineer :	Lex Wu	Relative Humidity :	51~54%

Channel	Frequency (MHz)	Frequency Separation (MHz)	(2/3 of 20dB BW) Limits (MHz)	Pass/Fail
00	2402	1.0029	0.8307	Pass
39	2441	0.9986	0.8307	Pass
78	2480	0.9986	0.8307	Pass

Channel Separation Plot on Channel 00 - 01

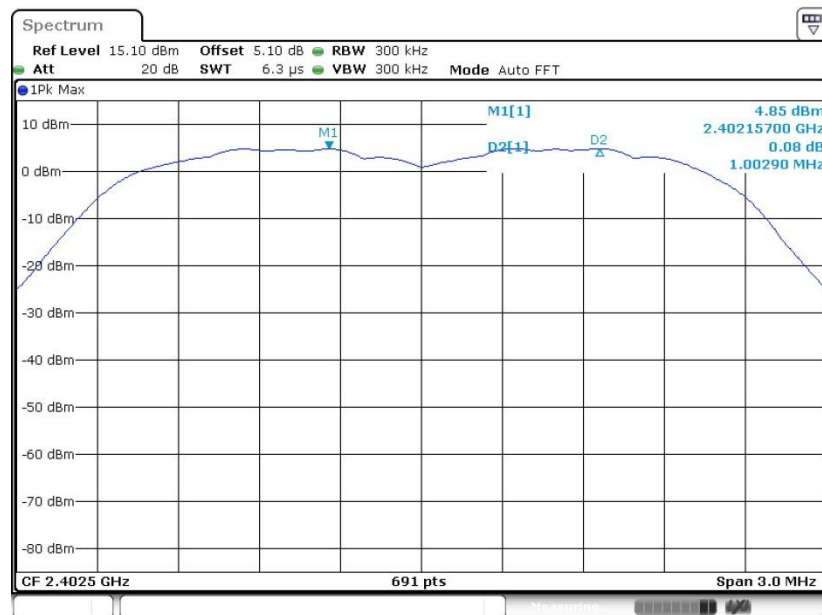



### Channel Separation Plot on Channel 39 - 40

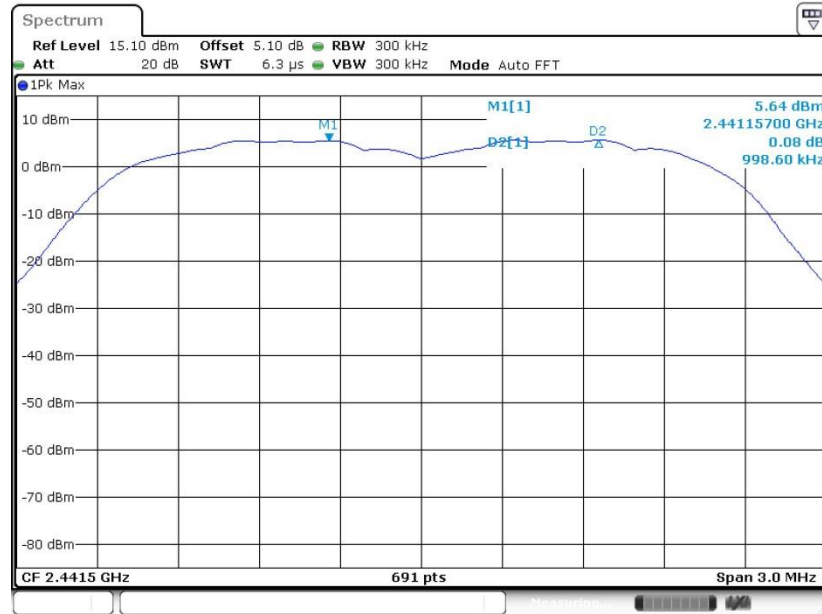

Date: 5.AUG.2019 04:34:16

### Channel Separation Plot on Channel 77 - 78

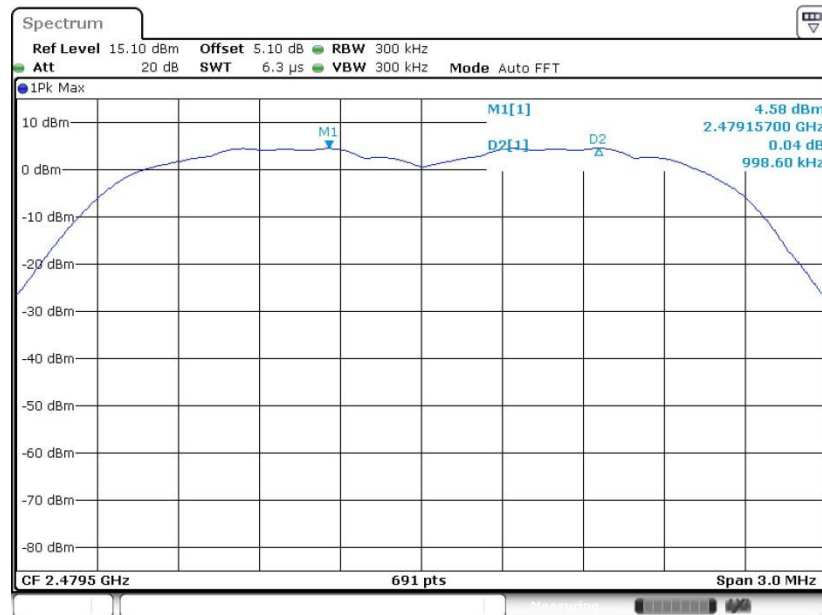

Date: 5.AUG.2019 04:39:33

### 3.3 Dwell Time Measurement

#### 3.3.1 Limit of Dwell Time

The average time of occupancy on any channel shall not be greater than 0.4 seconds within a period of 0.4 seconds multiplied by the number of hopping channels employed.

#### 3.3.2 Measuring Instruments

The measuring equipment is listed in the section 4 of this test report.

#### 3.3.3 Test Procedures

1. The testing follows ANSI C63.10-2013 clause 7.8.4.
2. The RF output of EUT was connected to the spectrum analyzer by RF cable and attenuator. The path loss was compensated to the results for each measurement.
3. Set to the maximum power setting and enable the EUT transmit continuously.
4. Enable the EUT hopping function.
5. Use the following spectrum analyzer settings: Span = zero span, centered on a hopping channel; RBW = 1 MHz; VBW  $\geq$  RBW; Sweep = as necessary to capture the entire dwell time per hopping channel; Detector function = peak; Trace = max hold.
6. Measure and record the results in the test report.

#### 3.3.4 Test Setup

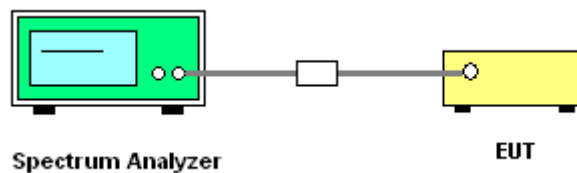



3.3.5 Test Result of Dwell Time

Test Mode :	3DH5	Temperature :	21~25°C
Test Engineer :	Lex Wu	Relative Humidity :	51~54%

Mode	Hopping Channel Number	Hops Over Occupancy Time(hops)	Package Transfer Time (msec)	Dwell Time (sec)	Limits (sec)	Pass/Fail
Normal	79	106.67	2.8826	0.31	0.4	Pass
AFH	20	53.34	2.8826	0.15	0.4	Pass

Package Transfer Time Plot

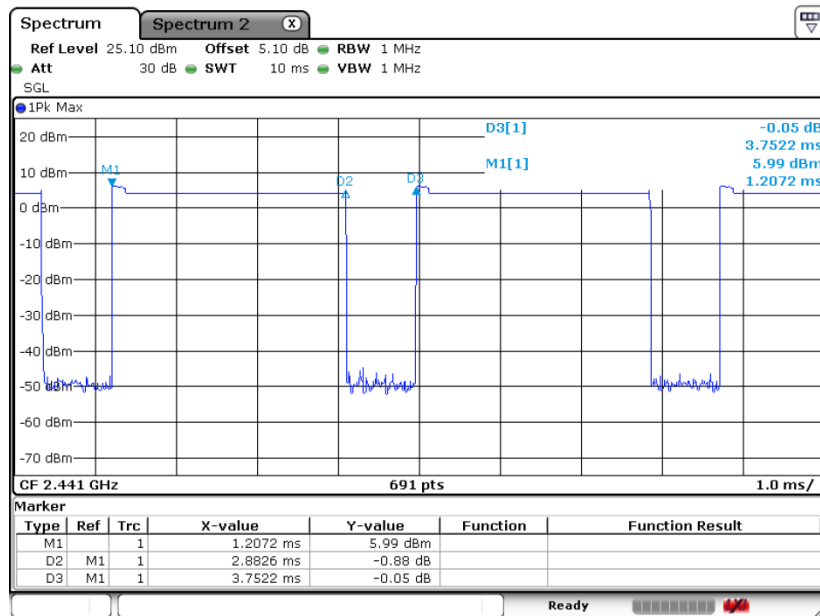

Date: 30.JUL.2019 23:26:05

Remark:

- In normal mode, hopping rate is 1600 hops/s with 6 slots in 79 hopping channels. With channel hopping rate (1600 / 6 / 79) in Occupancy Time Limit (0.4 x 79) (s), Hops Over Occupancy Time comes to (1600 / 6 / 79) x (0.4 x 79) = 106.67 hops.
- In AFH mode, hopping rate is 800 hops/s with 6 slots in 20 hopping channels. With channel hopping rate (800 / 6 / 20) in Occupancy Time Limit (0.4 x 20) (s), Hops Over Occupancy Time comes to (800 / 6 / 20) x (0.4 x 20) = 53.33 hops.
- Dwell Time(s) = Hops Over Occupancy Time (hops) x Package Transfer Time

## 3.4 20dB Bandwidth Measurement

### 3.4.1 Limit of 20dB Bandwidth

Reporting only

### 3.4.2 Measuring Instruments

The measuring equipment is listed in the section 4 of this test report.

### 3.4.3 Test Procedures

1. The testing follows ANSI C63.10-2013 clause 6.9.2 and 6.9.3.
2. The RF output of EUT was connected to the spectrum analyzer by RF cable and attenuator. The path loss was compensated to the results for each measurement.
3. Set to the maximum power setting and enable the EUT transmit continuously.
4. Use the following spectrum analyzer settings for 20dB Bandwidth measurement.  
Span = approximately 2 to 5 times the 20 dB bandwidth, centered on a hopping channel;  
RBW  $\geq$  1% of the 20 dB bandwidth; VBW  $\geq$  RBW; Sweep = auto; Detector function = peak;  
Trace = max hold.
5. Measure and record the results in the test report.

### 3.4.4 Test Setup

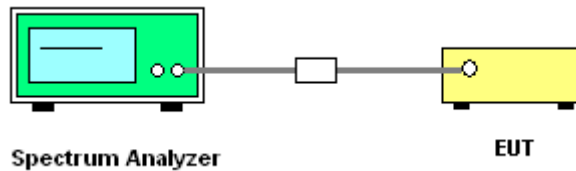



3.4.5 Test Result of 20dB Bandwidth

Test Mode :	1Mbps	Temperature :	21~25°C
Test Engineer :	Lex Wu	Relative Humidity :	51~54%

Channel	Frequency (MHz)	20dB Bandwidth (MHz)
00	2402	1.042
39	2441	1.042
78	2480	1.039

20 dB Bandwidth Plot on Channel 00

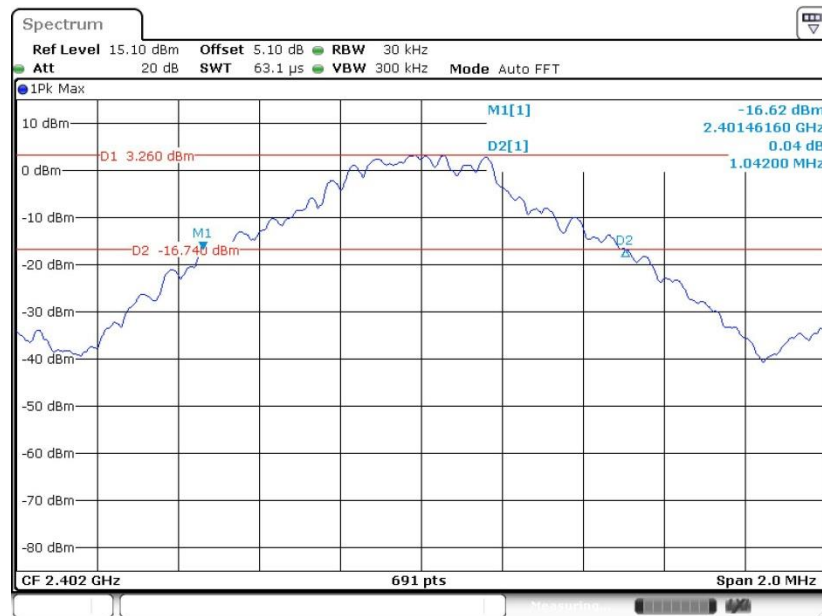

Date: 5.AUG.2019 03:48:25





20 dB Bandwidth Plot on Channel 39

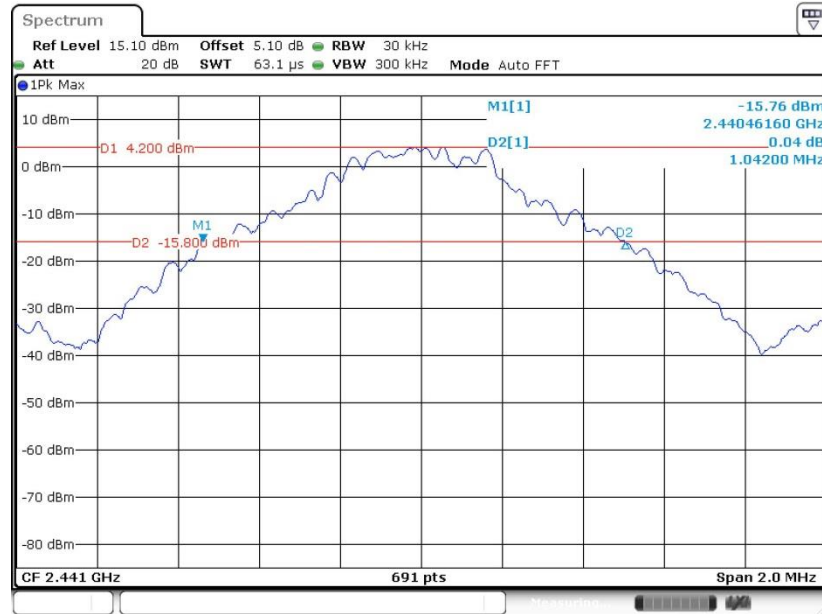

Date: 5.AUG.2019 03:58:49

20 dB Bandwidth Plot on Channel 78

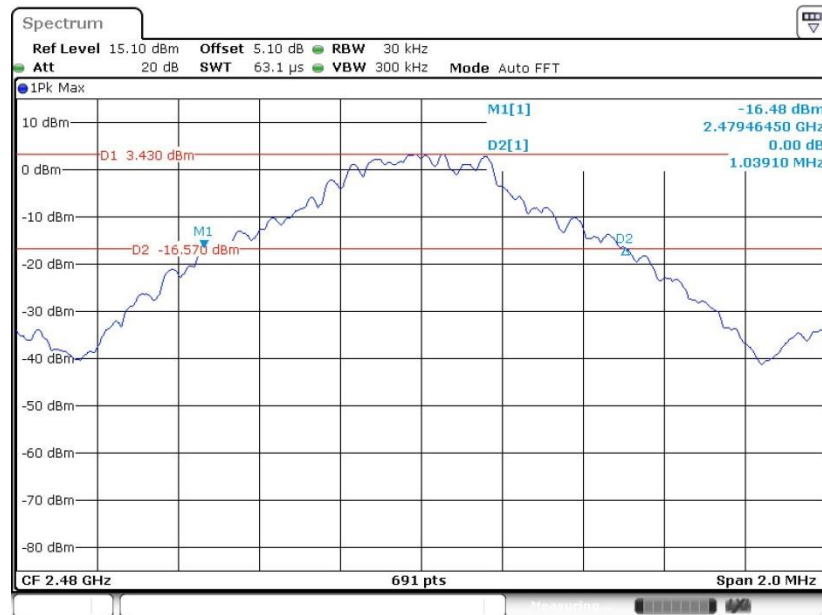

Date: 5.AUG.2019 04:03:06



Test Mode :	2Mbps	Temperature :	21~25°C
Test Engineer :	Lex Wu	Relative Humidity :	51~54%

Channel	Frequency (MHz)	20dB Bandwidth (MHz)
00	2402	1.255
39	2441	1.255
78	2480	1.255

20 dB Bandwidth Plot on Channel 00

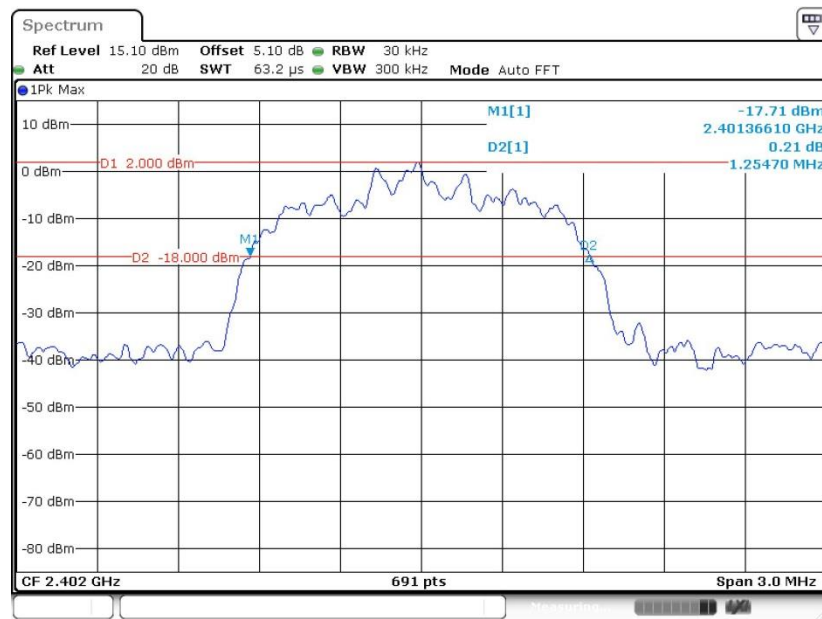

Date: 5.AUG.2019 04:45:24



20 dB Bandwidth Plot on Channel 39

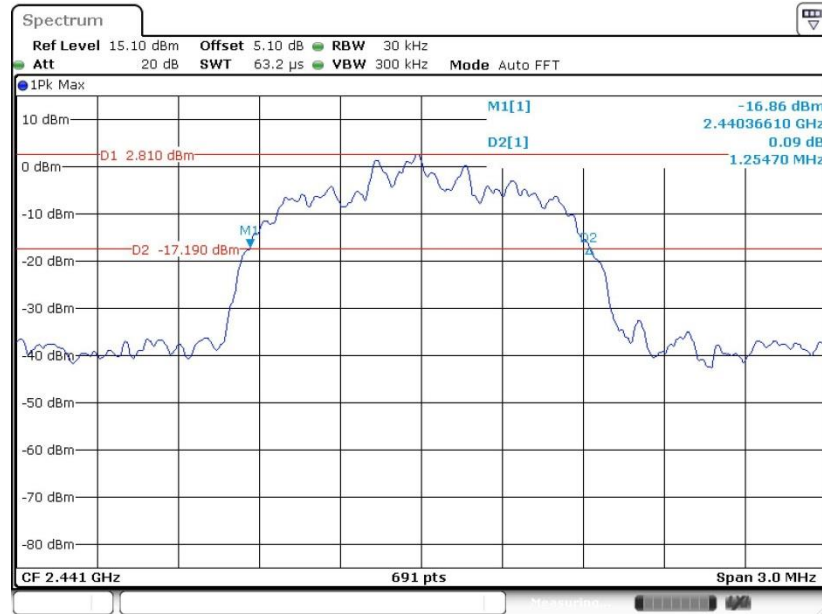

Date: 5.AUG.2019 04:17:44

20 dB Bandwidth Plot on Channel 78

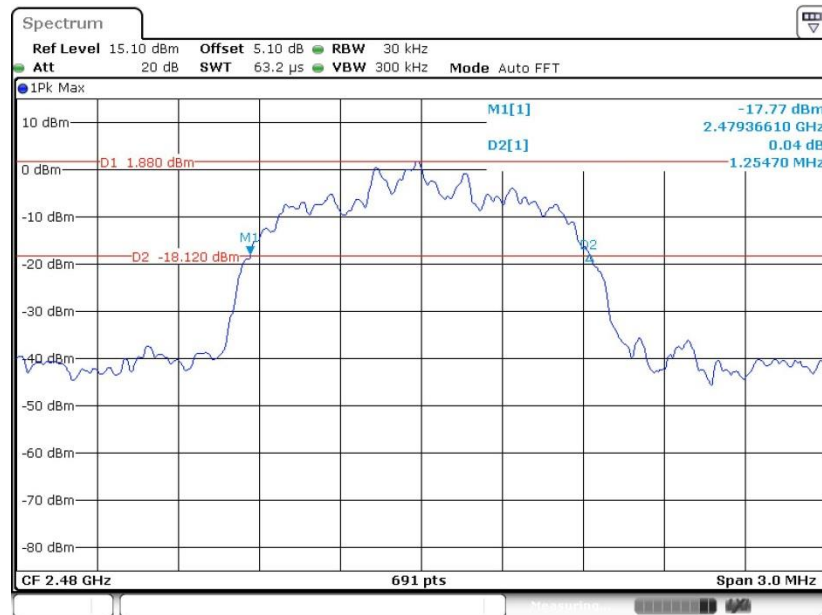

Date: 5.AUG.2019 04:25:20



Test Mode :	3Mbps	Temperature :	21~25°C
Test Engineer :	Lex Wu	Relative Humidity :	51~54%

Channel	Frequency (MHz)	20dB Bandwidth (MHz)
00	2402	1.246
39	2441	1.246
78	2480	1.246

20 dB Bandwidth Plot on Channel 00

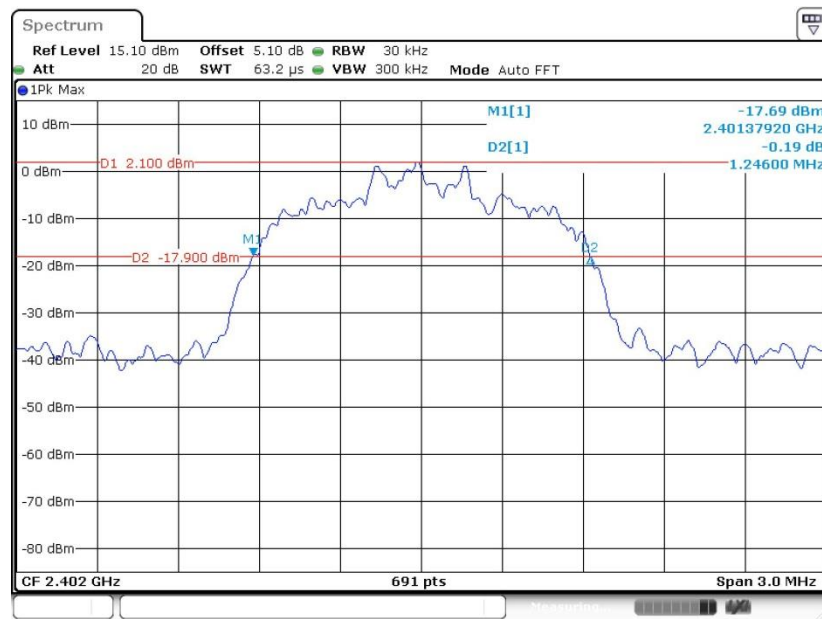

Date: 5.AUG.2019 04:30:34



### 20 dB Bandwidth Plot on Channel 39

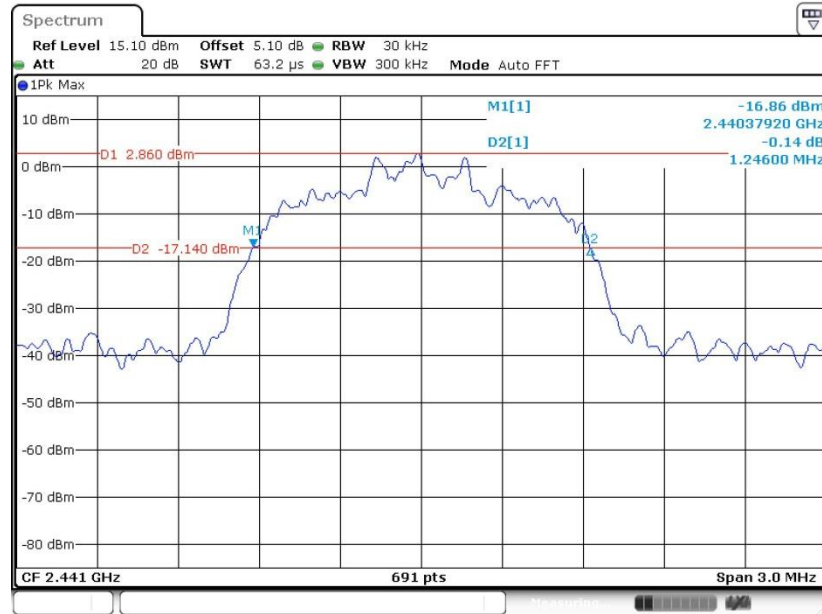

Date: 5.AUG.2019 04:35:24

### 20 dB Bandwidth Plot on Channel 78

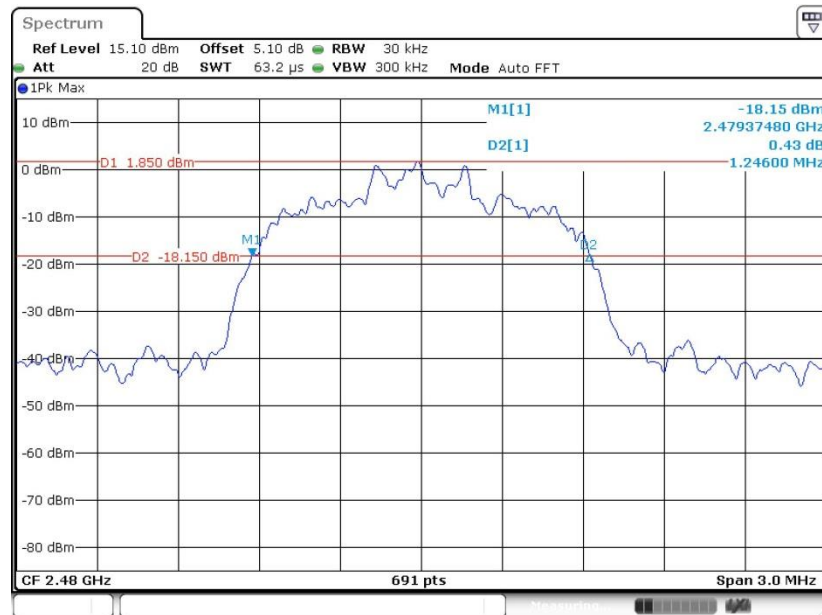

Date: 5.AUG.2019 04:41:05

## 3.5 Output Power Measurement

### 3.5.1 Limit of Output Power

The maximum peak conducted output power of the intentional radiator shall not exceed the following:

- (1) For frequency hopping systems operating in the 2400-2483.5 MHz band employing at least 75 non-overlapping hopping channels, and all frequency hopping systems in the 5725-5850 MHz band: 1 watt. For all other frequency hopping systems in the 2400-2483.5 MHz band 0.125 watts.

### 3.5.2 Measuring Instruments

The measuring equipment is listed in the section 4 of this test report.

### 3.5.3 Test Procedures

1. The testing follows ANSI C63.10-2013 clause 7.8.5.
2. The RF output of EUT was connected to the power meter by RF cable and attenuator. The path loss was compensated to the results for each measurement.
3. Set to the maximum power setting and enable the EUT transmit continuously.
4. Measure the conducted output power with cable loss and record the results in the test report.
5. Measure and record the results in the test report.

### 3.5.4 Test Setup

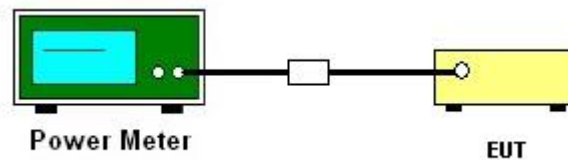



3.5.5 Test Result of Peak Output Power

Test Mode :	1Mbps	Temperature :	21~25°C
Test Engineer :	Lex Wu	Relative Humidity :	51~54%

Channel	Frequency (MHz)	RF Power (dBm)		
		GFSK	Max. Limits (dBm)	Pass/Fail
		1 Mbps		
00	2402	5.41	20.97	Pass
39	2441	8.01	20.97	Pass
78	2480	6.64	20.97	Pass

Test Mode :	2Mbps	Temperature :	21~25°C
Test Engineer :	Lex Wu	Relative Humidity :	51~54%

Channel	Frequency (MHz)	RF Power (dBm)		
		$\pi/4$ -DQPSK	Max. Limits (dBm)	Pass/Fail
		2 Mbps		
00	2402	4.64	20.97	Pass
39	2441	7.03	20.97	Pass
78	2480	5.69	20.97	Pass

Test Mode :	3Mbps	Temperature :	21~25°C
Test Engineer :	Lex Wu	Relative Humidity :	51~54%

Channel	Frequency (MHz)	RF Power (dBm)		
		8-DPSK	Max. Limits (dBm)	Pass/Fail
		3 Mbps		
00	2402	4.64	20.97	Pass
39	2441	7.02	20.97	Pass
78	2480	5.47	20.97	Pass

## 3.6 Conducted Band Edges Measurement

### 3.6.1 Limit of Band Edges

In any 100 kHz bandwidth outside the intentional radiation frequency band, the radio frequency power shall be at least 20 dB below the highest level of the radiated power. In addition, radiated emissions which fall in the restricted bands must also comply with the radiated emission limits.

### 3.6.2 Measuring Instruments

The measuring equipment is listed in the section 4 of this test report.

### 3.6.3 Test Procedures

1. The testing follows ANSI C63.10-2013 clause 7.8.6.
2. Set to the maximum power setting and enable the EUT transmit continuously.
3. Set RBW = 100kHz, VBW = 300kHz. Band edge emissions must be at least 20 dB down from the highest emission level within the authorized band as measured with a 100kHz RBW. The attenuation shall be 30 dB instead of 20 dB when RMS conducted output power procedure is used.
4. Enable hopping function of the EUT and then repeat step 2. and 3.
5. Measure and record the results in the test report.

### 3.6.4 Test Setup

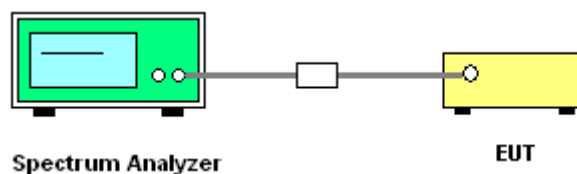





### 3.6.5 Test Result of Conducted Band Edges

Test Mode :	1Mbps	Temperature :	21~25°C
Test Channel :	00 and 78	Relative Humidity :	51~54%
		Test Engineer :	Lex Wu

#### Low Band Edge Plot on Channel 00

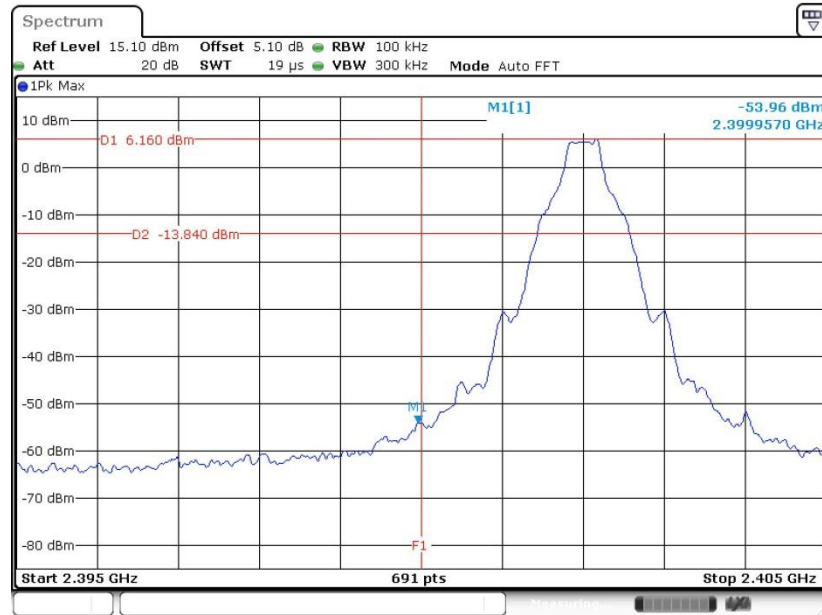

Date: 5.AUG.2019 03:52:04

#### High Band Edge Plot on Channel 78

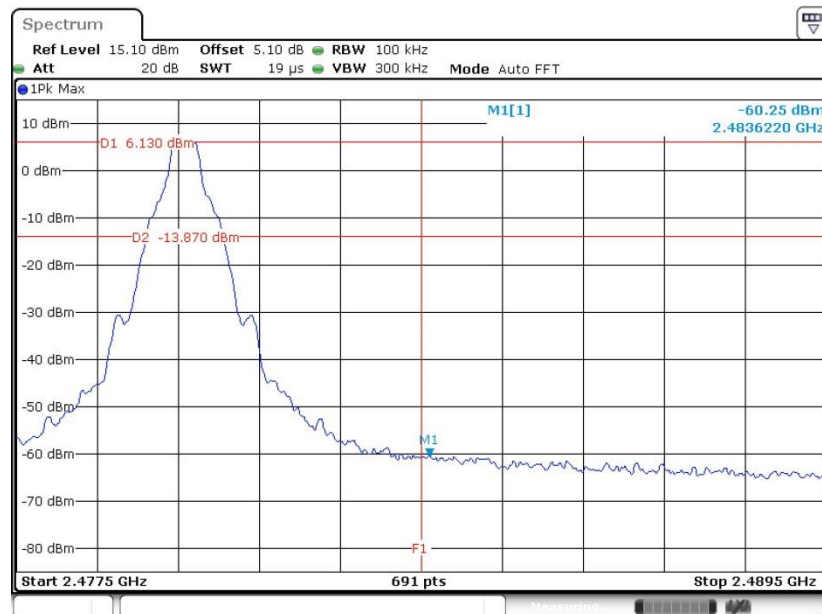

Date: 5.AUG.2019 04:03:28



Test Mode :	2Mbps	Temperature :	21~25°C
Test Channel :	00 and 78	Relative Humidity :	51~54%
		Test Engineer :	Lex Wu

Low Band Edge Plot on Channel 00

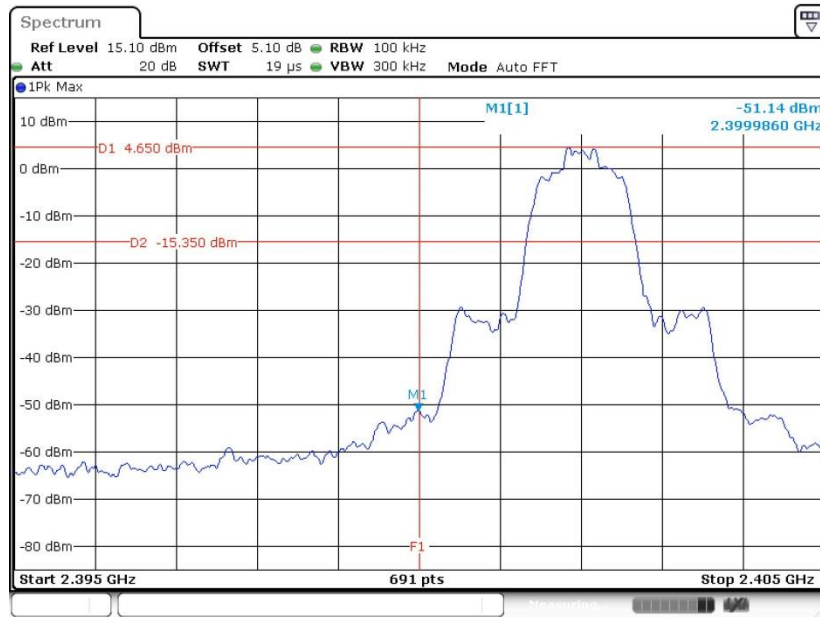

Date: 5.AUG.2019 04:12:12

High Band Edge Plot on Channel 78

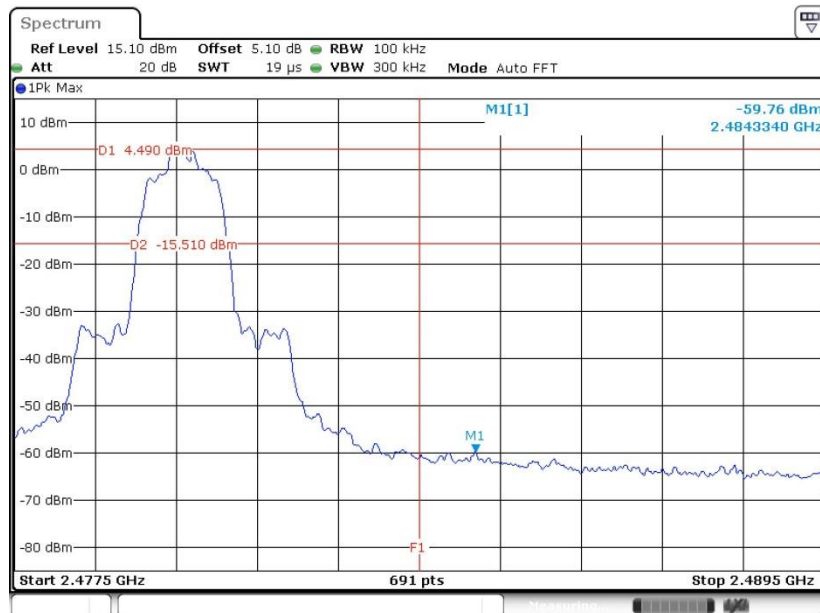

Date: 5.AUG.2019 04:25:44



Test Mode :	3Mbps	Temperature :	21~25°C
Test Channel :	00 and 78	Relative Humidity :	51~54%
		Test Engineer :	Lex Wu

Low Band Edge Plot on Channel 00

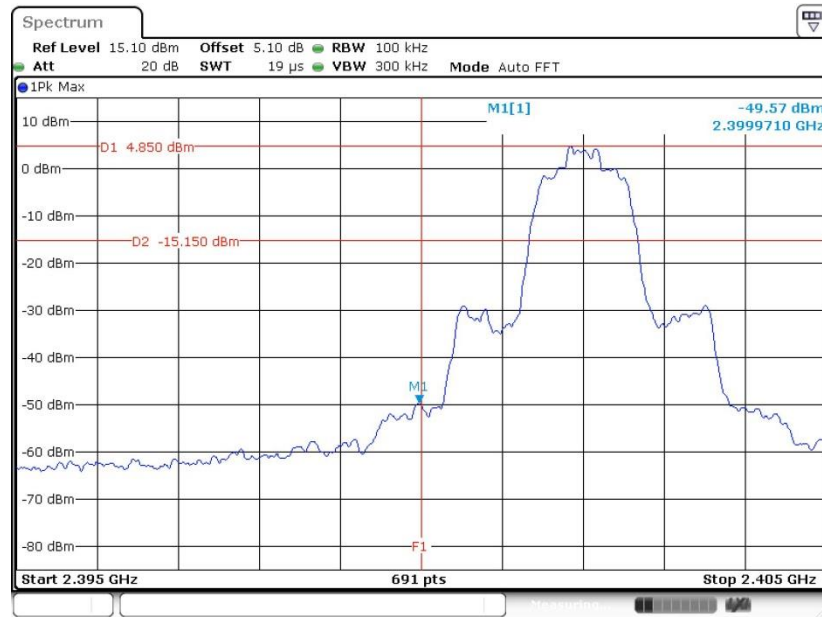

Date: 5.AUG.2019 04:30:56

High Band Edge Plot on Channel 78

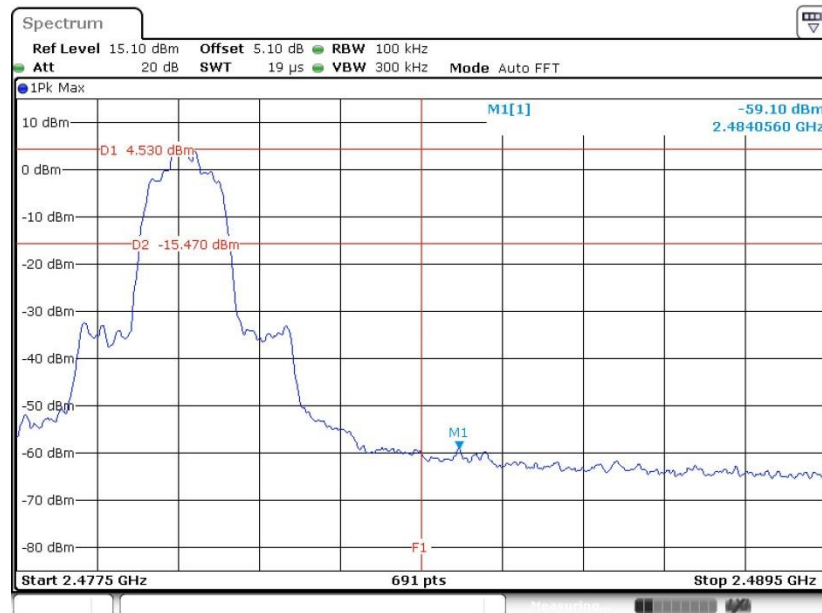

Date: 5.AUG.2019 04:41:31



### 3.6.6 Test Result of Conducted Hopping Mode Band Edges

Test Mode :	1Mbps	Temperature :	21~25°C
Test Engineer :	Lex Wu	Relative Humidity :	51~54%

#### Hopping Mode Low Band Edge Plot

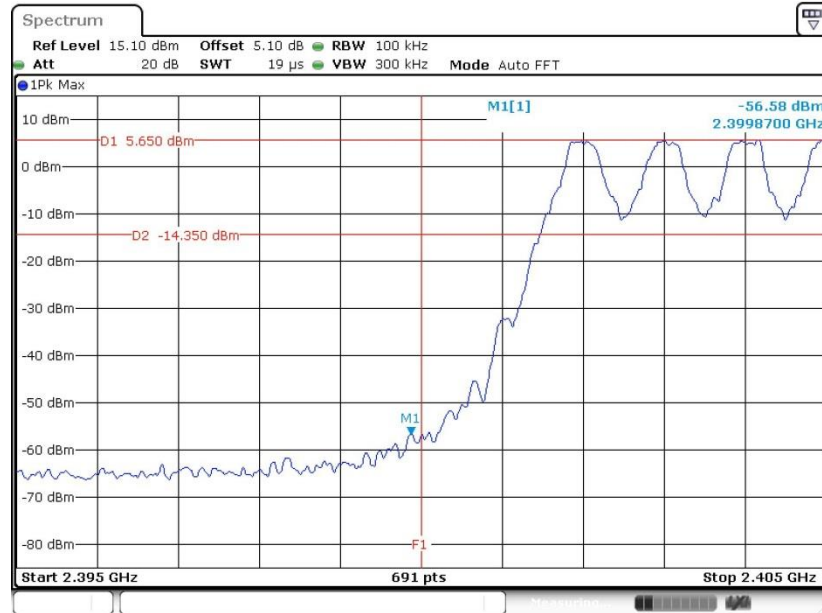

Date: 5.AUG.2019 03:56:22

#### Hopping Mode High Band Edge Plot

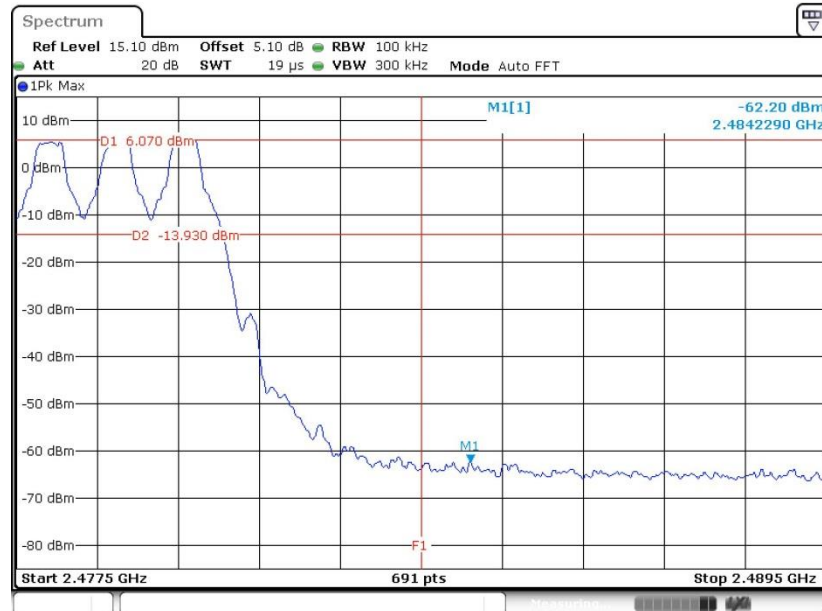

Date: 5.AUG.2019 04:07:09



Test Mode :	2Mbps	Temperature :	21~25°C
Test Engineer :	Lex Wu	Relative Humidity :	51~54%

Hopping Mode Low Band Edge Plot

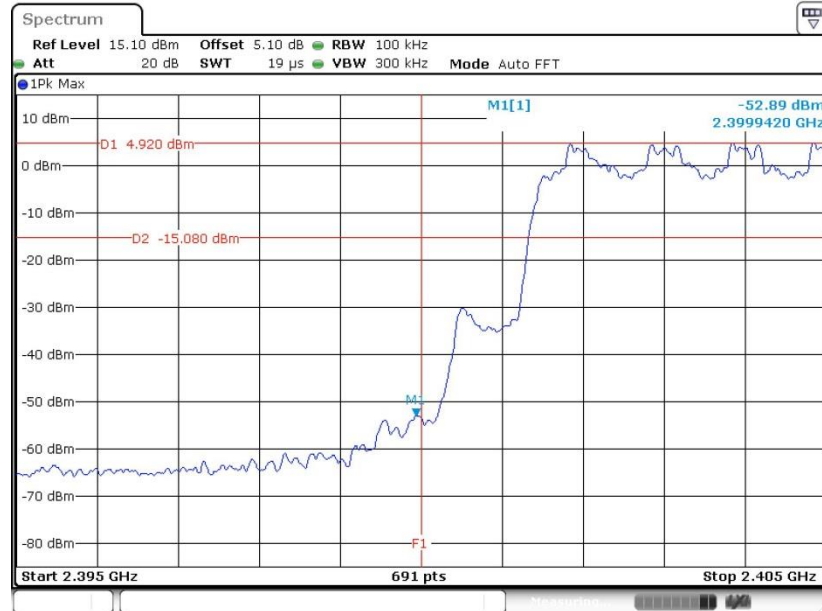

Date: 5.AUG.2019 04:15:24

Hopping Mode High Band Edge Plot

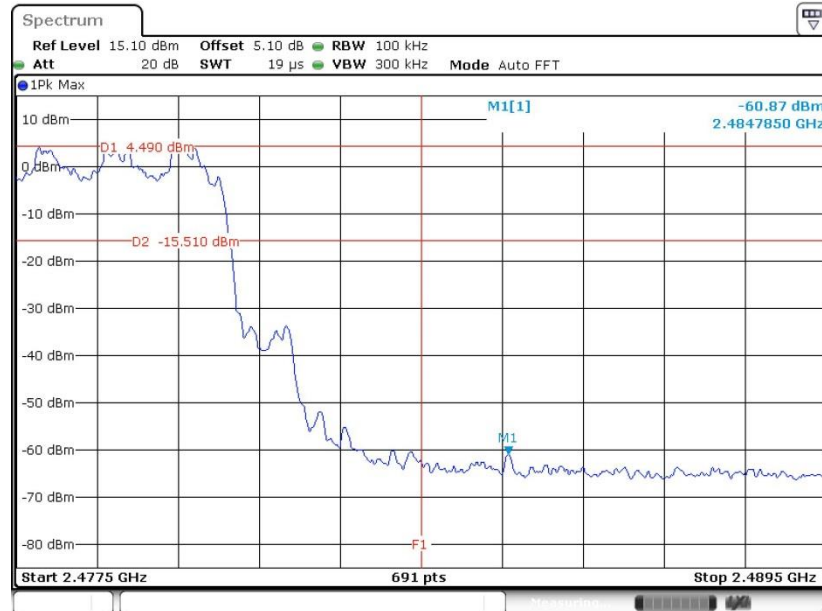

Date: 5.AUG.2019 04:28:09



Test Mode :	3Mbps	Temperature :	21~25°C
Test Engineer :	Lex Wu	Relative Humidity :	51~54%

Hopping Mode Low Band Edge Plot

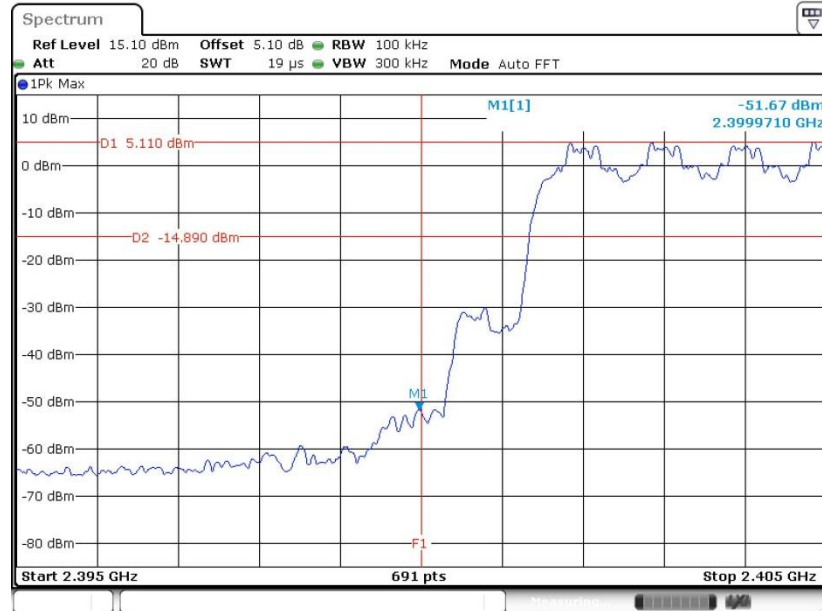

Date: 5.AUG.2019 04:33:07

Hopping Mode High Band Edge Plot

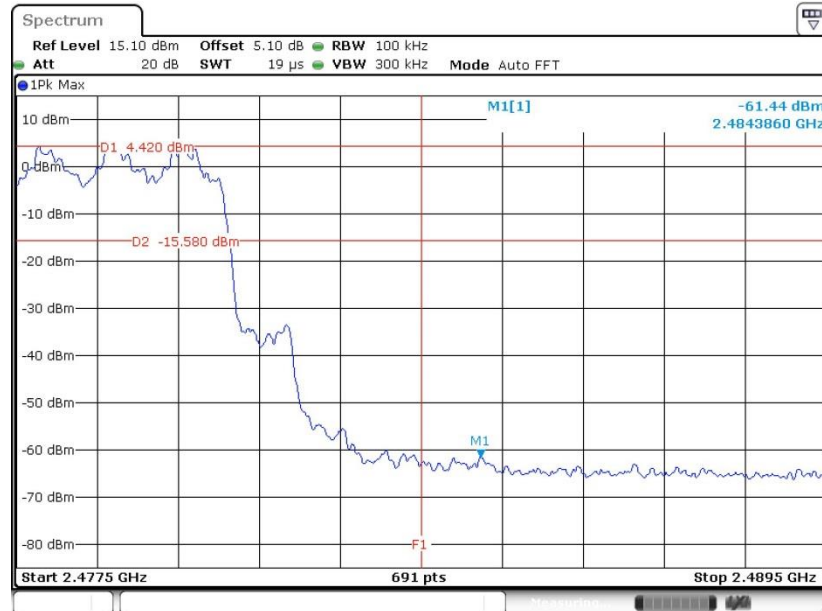

Date: 5.AUG.2019 04:43:45

## 3.7 Conducted Spurious Emission Measurement

### 3.7.1 Limit of Spurious Emission Measurement

In any 100 kHz bandwidth outside the intentional radiation frequency band, the radio frequency power shall be at least 20 dB below the highest level of the radiated power. In addition, radiated emissions which fall in the restricted bands must also comply with the radiated emission limits.

### 3.7.2 Measuring Instruments

The measuring equipment is listed in the section 4 of this test report.

### 3.7.3 Test Procedure

1. The testing follows ANSI C63.10-2013 clause 7.8.8.
2. The RF output of EUT was connected to the spectrum analyzer by RF cable and attenuator. The path loss was compensated to the results for each measurement.
3. Set to the maximum power setting and enable the EUT transmit continuously.
4. Set RBW = 100 kHz, VBW = 300kHz, scan up through 10th harmonic. All harmonics / spurs must be at least 20 dB down from the highest emission level within the authorized band as measured with a 100 kHz RBW.
5. Measure and record the results in the test report.
6. The RF fundamental frequency should be excluded against the limit line in the operating frequency band.

### 3.7.4 Test Setup

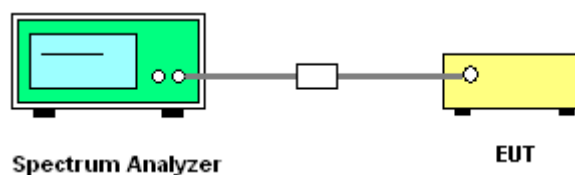



### 3.7.5 Test Result of Conducted Spurious Emission

Test Mode :	1Mbps	Temperature :	21~25°C
Test Channel :	00	Relative Humidity :	51~54%
		Test Engineer :	Lex Wu

CSE Plot on Ch 00 between 30MHz ~ 3 GHz

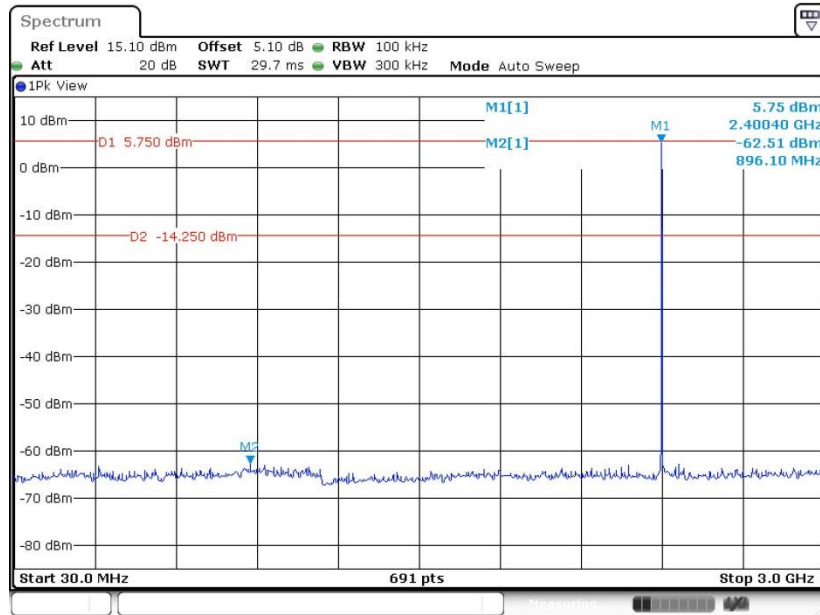

Date: 5.AUG.2019 03:53:27

1Mbps CSE Plot on Ch 00 between 2 GHz ~ 25 GHz

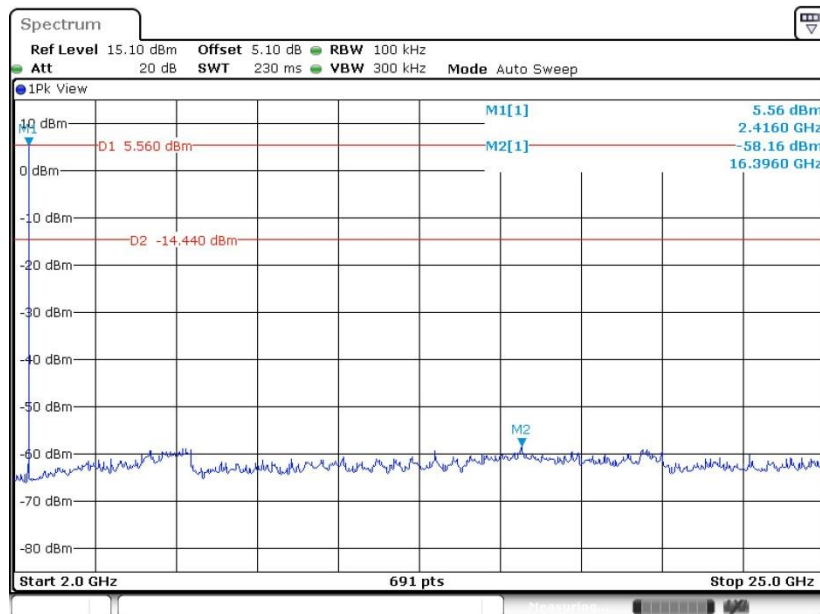

Date: 5.AUG.2019 03:53:56





CSE Plot on Ch 39 between 30MHz ~ 3 GHz

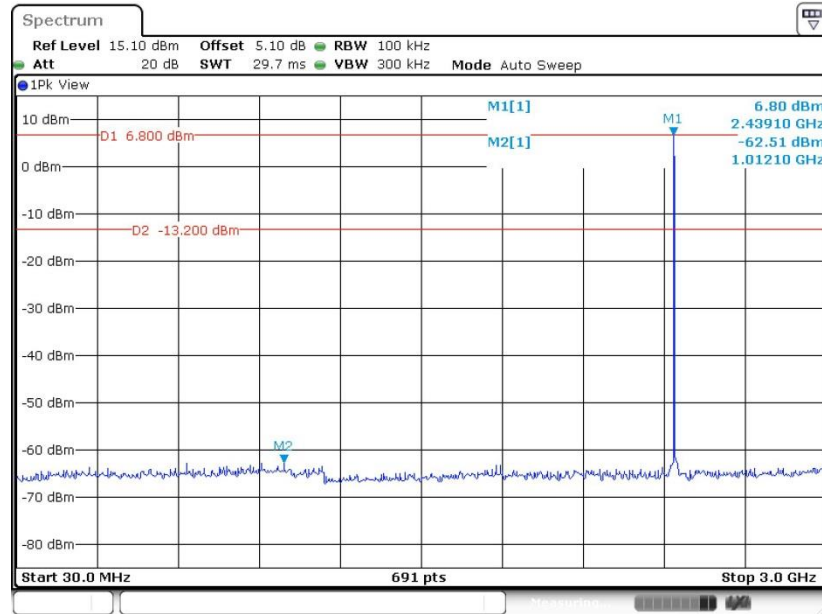

Date: 5.AUG.2019 04:00:37

CSE Plot on Ch 39 between 2 GHz ~ 25 GHz

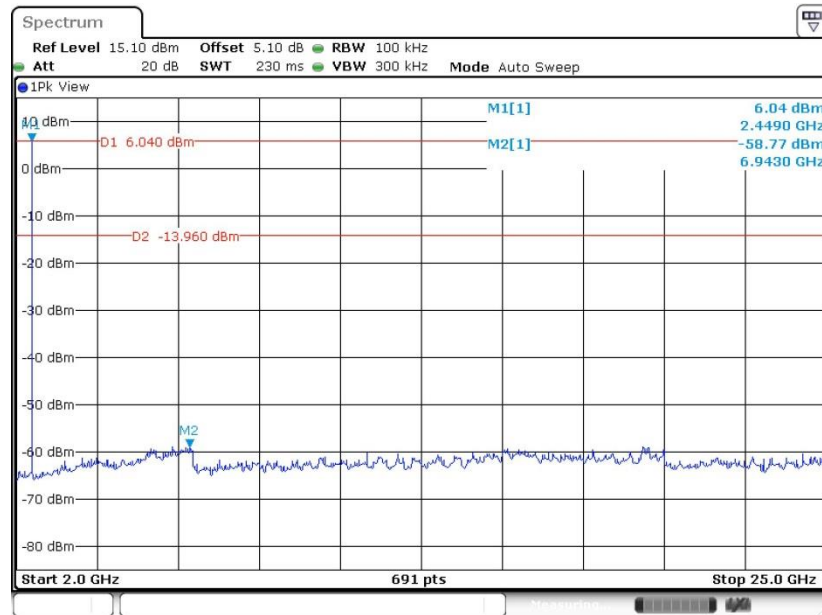

Date: 5.AUG.2019 04:01:04



CSE Plot on Ch 78 between 30MHz ~ 3 GHz

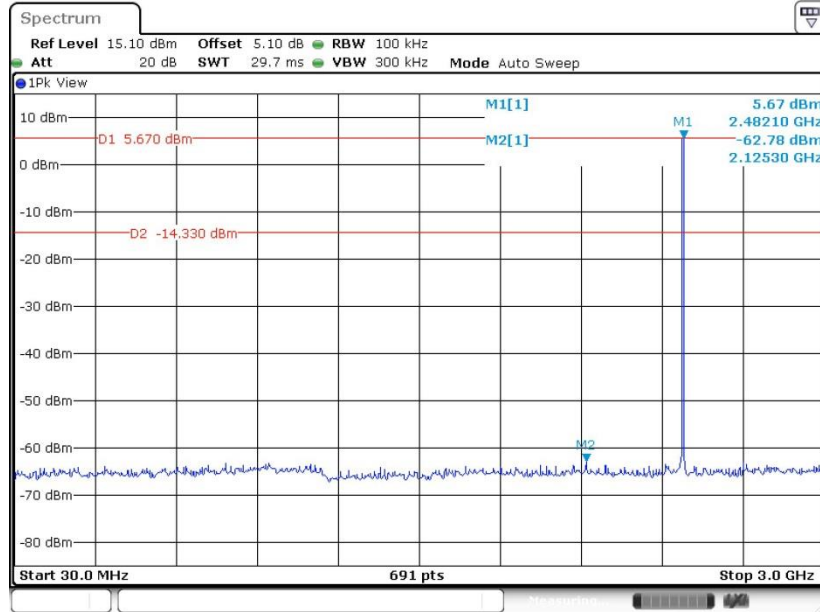

Date: 5.AUG.2019 04:04:37

CSE Plot on Ch 78 between 2 GHz ~ 25 GHz

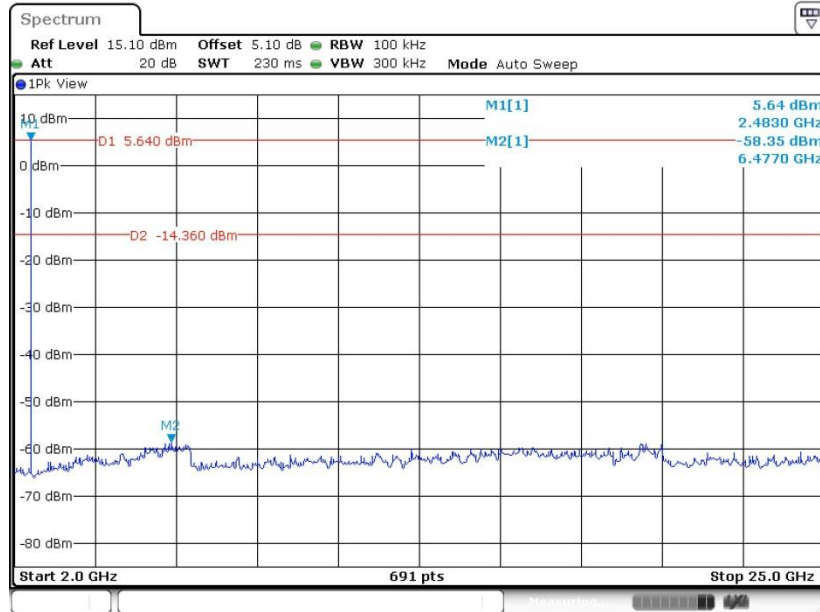

Date: 5.AUG.2019 04:05:15



Test Mode :	2Mbps	Temperature :	21~25°C
Test Channel :	00	Relative Humidity :	51~54%
		Test Engineer :	Lex Wu

CSE Plot on Ch 00 between 30MHz ~ 3 GHz

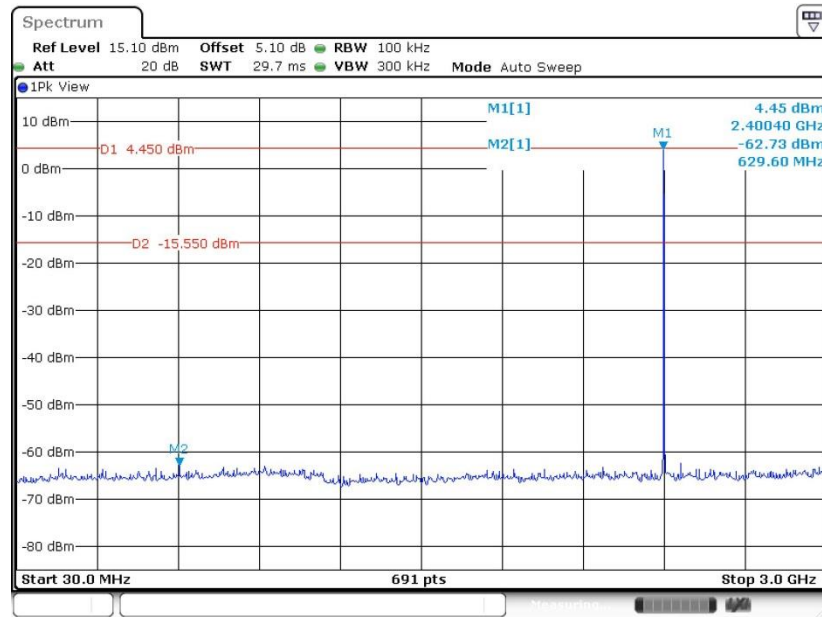

Date: 5.AUG.2019 04:14:28

CSE Plot on Ch 00 between 2 GHz ~ 25 GHz

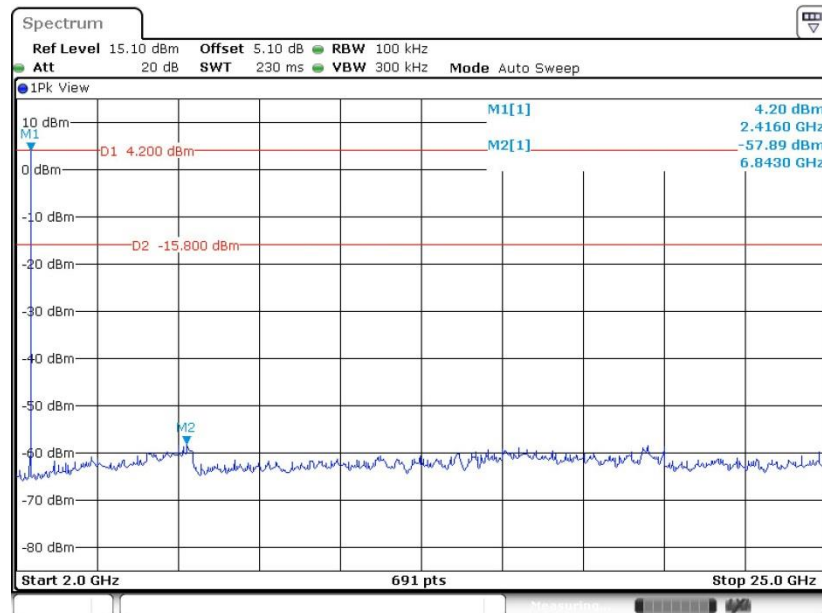

Date: 5.AUG.2019 04:14:57



CSE Plot on Ch 39 between 30MHz ~ 3 GHz

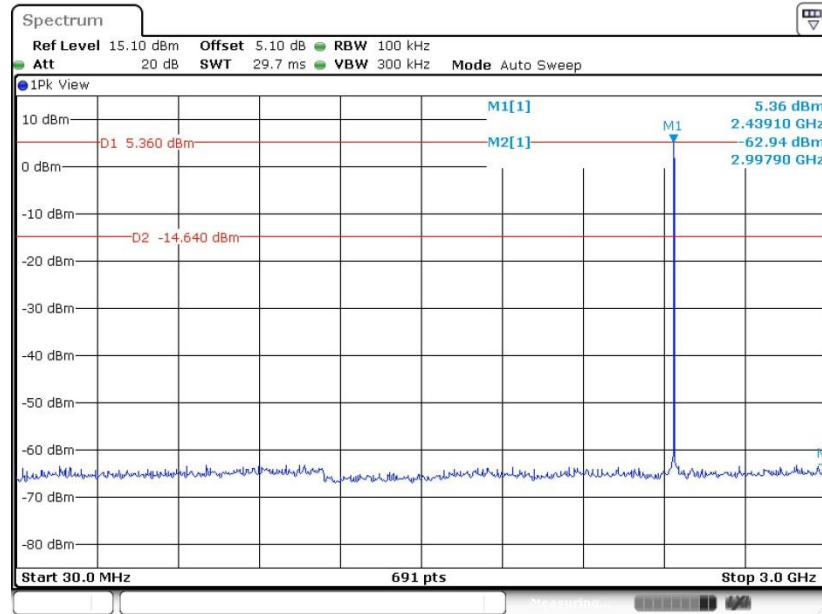

Date: 5.AUG.2019 04:18:59

CSE Plot on Ch 39 between 2 GHz ~ 25 GHz

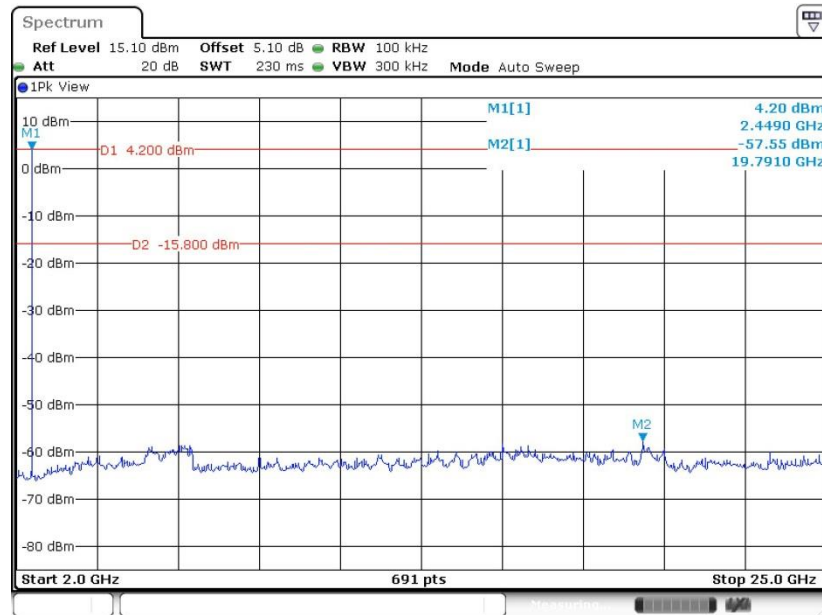

Date: 5.AUG.2019 04:19:26



CSE Plot on Ch 78 between 30MHz ~ 3 GHz

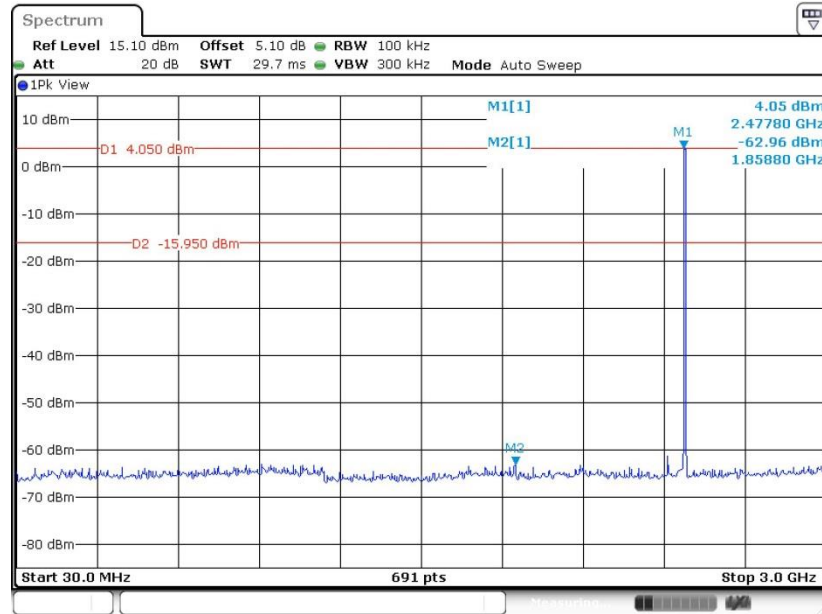

CSE Plot on Ch 78 between 2 GHz ~ 25 GHz

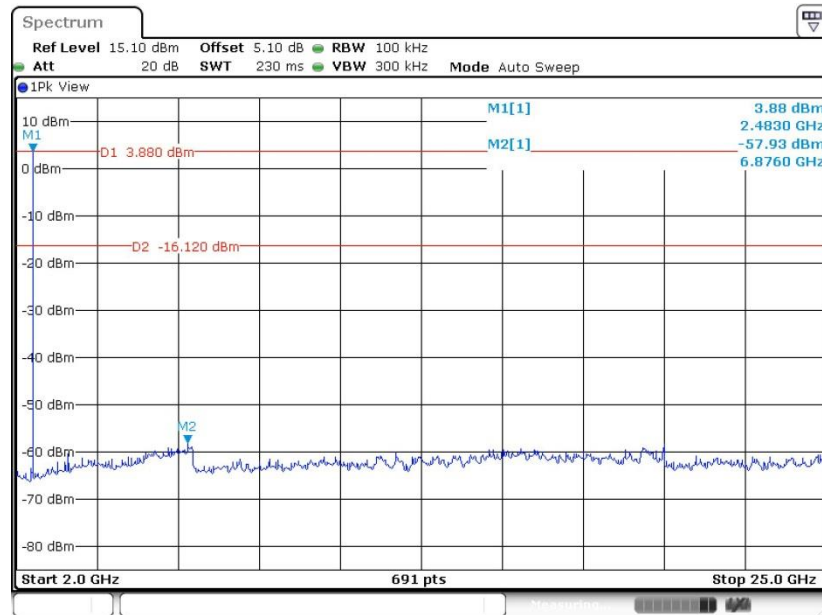



Test Mode :	3Mbps	Temperature :	21~25°C
Test Channel :	00	Relative Humidity :	51~54%
		Test Engineer :	Lex Wu

CSE Plot on Ch 00 between 30MHz ~ 3 GHz

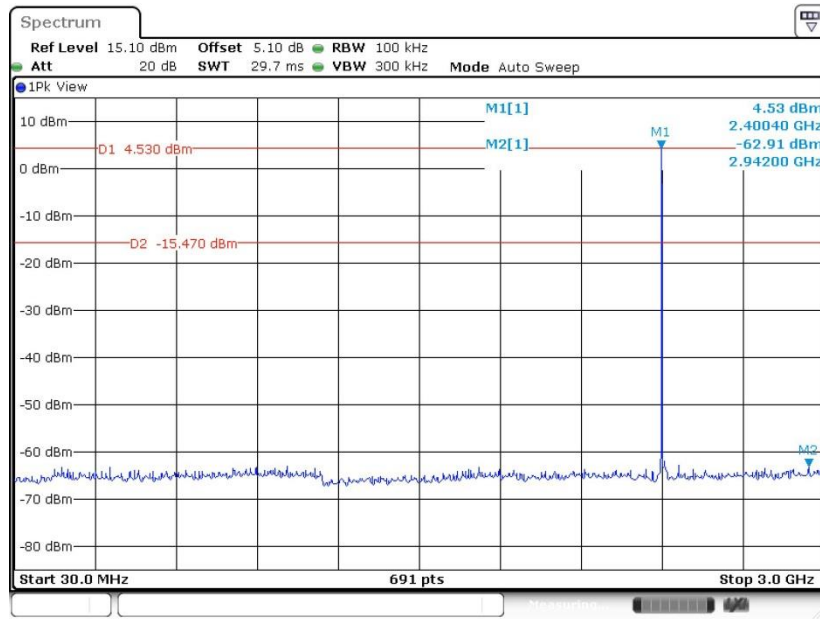

Date: 5.AUG.2019 04:32:12

CSE Plot on Ch 00 between 2 GHz ~ 25 GHz

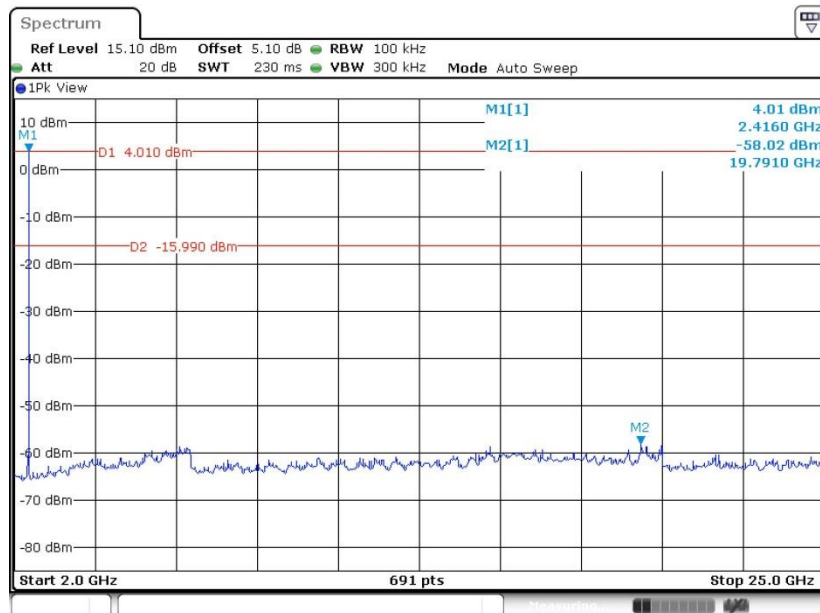

Date: 5.AUG.2019 04:32:43



CSE Plot on Ch 39 between 30MHz ~ 3 GHz

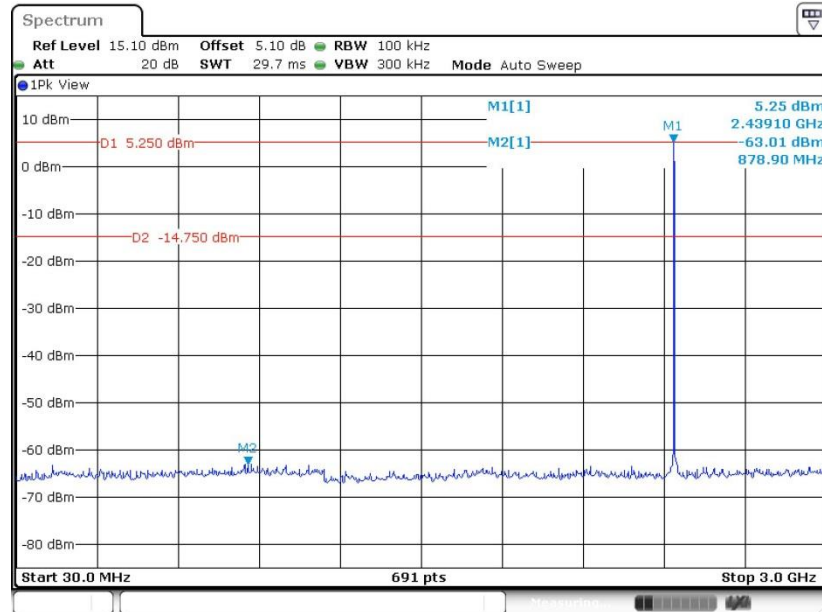

Date: 5.AUG.2019 04:36:38

CSE Plot on Ch 39 between 2 GHz ~ 25 GHz

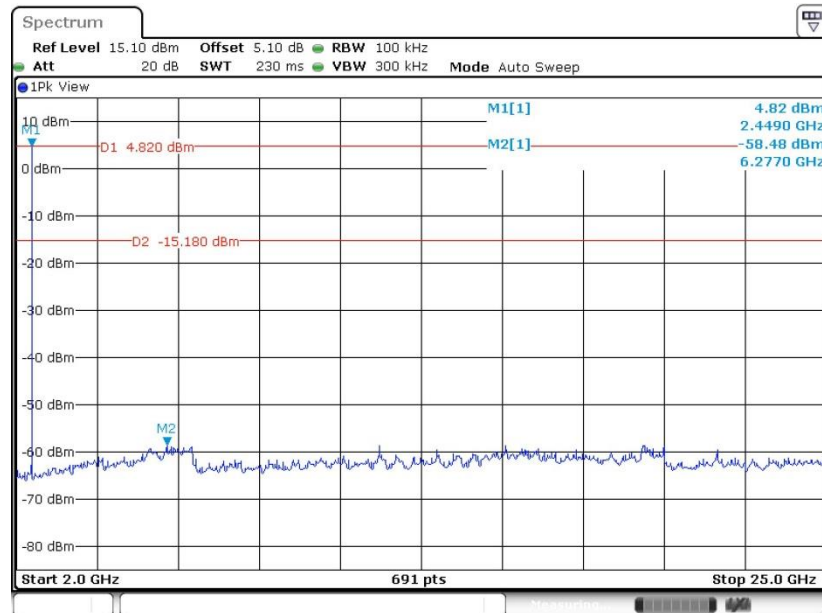

Date: 5.AUG.2019 04:37:06



CSE Plot on Ch 78 between 30MHz ~ 3 GHz

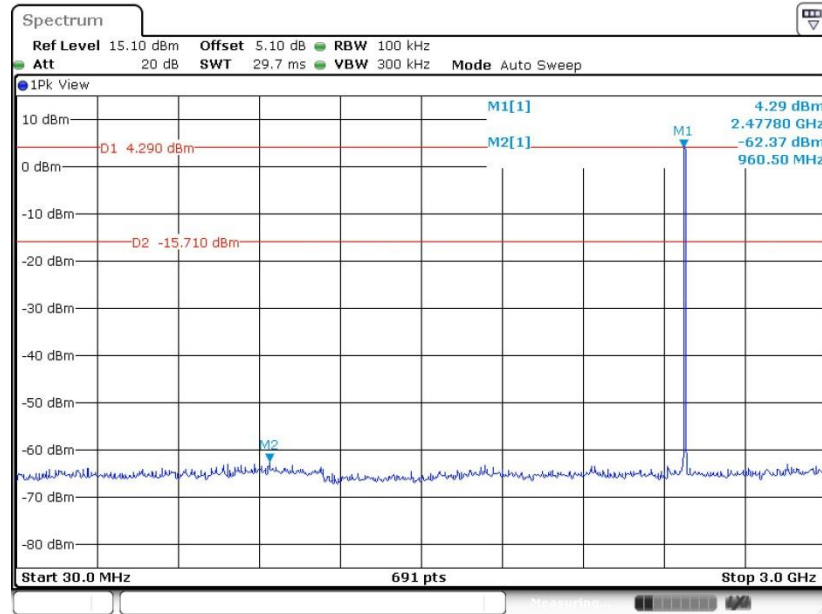

Date: 5.AUG.2019 04:42:54

CSE Plot on Ch 78 between 2 GHz ~ 25 GHz

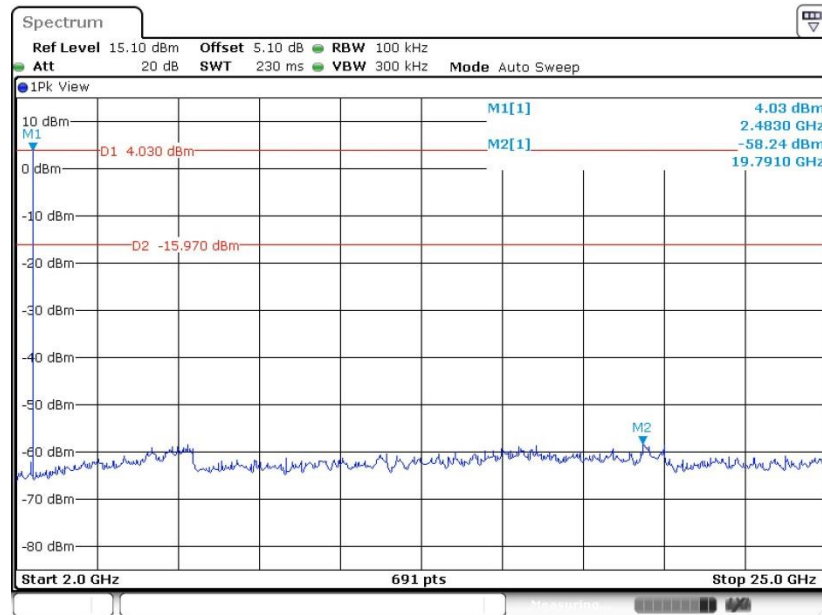

Date: 5.AUG.2019 04:43:22





### 3.8 Radiated Band Edges and Spurious Emission Measurement

#### 3.8.1 Limit of Radiated Band Edges and Spurious Emission

In any 100 kHz bandwidth outside the intentional radiator frequency band, all harmonics/spurious must be at least 20 dB below the highest emission level within the authorized band. In addition, radiated emissions which fall in the restricted bands must also comply with the limits as below.

Frequency (MHz)	Field Strength (microvolts/meter)	Measurement Distance (meters)
0.009 – 0.490	2400/F(kHz)	300
0.490 – 1.705	24000/F(kHz)	30
1.705 – 30.0	30	30
30 – 88	100	3
88 – 216	150	3
216 - 960	200	3
Above 960	500	3

#### 3.8.2 Measuring Instruments

The measuring equipment is listed in the section 4 of this test report.



### 3.8.3 Test Procedures

1. The EUT was placed on a turntable with 0.8 meter for frequency below 1GHz and 1.5 meter for frequency above 1GHz respectively above ground.
2. The EUT was set 3 meters from the interference receiving antenna, which was mounted on the top of a variable height antenna tower.
3. For each suspected emission, the EUT was arranged to its worst case and then tune the Antenna tower (from 1 m to 4 m) and turntable (from 0 degree to 360 degrees) to find the maximum reading. A pre-amp and a high pass filter are used for the test in order to get better signal level to comply with the guidelines.
4. Set to the maximum power setting and enable the EUT transmit continuously.
5. Use the following spectrum analyzer settings:
  - (1) Span shall wide enough to fully capture the emission being measured;
  - (2) Set RBW=100 kHz for  $f < 1 \text{ GHz}$ , RBW=1MHz for  $f > 1\text{GHz}$  ; VBW  $\geq$  RBW; Sweep = auto; Detector function = peak; Trace = max hold for peak
  - (3) For average measurement: use duty cycle correction factor method per 15.35(c).  
Duty cycle = On time/100 milliseconds  
On time =  $N_1 * L_1 + N_2 * L_2 + \dots + N_{n-1} * L_{n-1} + N_n * L_n$   
Where  $N_1$  is number of type 1 pulses,  $L_1$  is length of type 1 pulses, etc.  
Average Emission Level = Peak Emission Level +  $20 * \log(\text{Duty cycle})$
6. Corrected Reading: Antenna Factor + Cable Loss + Read Level - Preamp Factor = Level
7. For testing below 1GHz, if the emission level of the EUT in peak mode was 3 dB lower than the limit specified, then peak values of EUT will be reported, otherwise, the emissions will be repeated one by one using the CISPR quasi-peak method and reported.
8. For testing above 1GHz, the emission level of the EUT in peak mode was 20dB lower than average limit (that means the emission level in average mode also complies with the limit in average mode), then peak values of EUT will be reported, otherwise, the emissions will be measured in average mode again and reported.

Note: The average levels were calculated from the peak level corrected with duty cycle correction factor (-24.79dB) derived from  $20 \log(\text{dwell time}/100\text{ms})$ . This correction is only for signals that hop with the fundamental signal, such as band-edge and harmonic. Other spurious signals that are independent of the hopping signal would not use this correction.

### 3.8.4 Test Setup

For radiated emissions below 30MHz

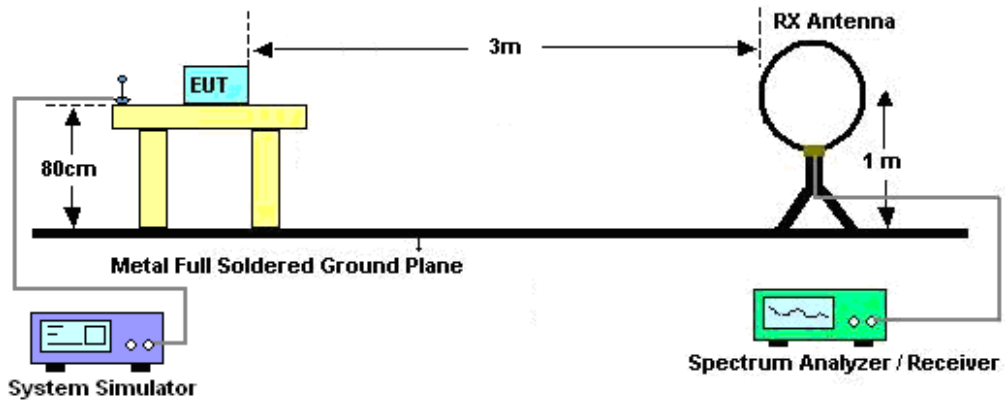

For radiated emissions from 30MHz to 1GHz

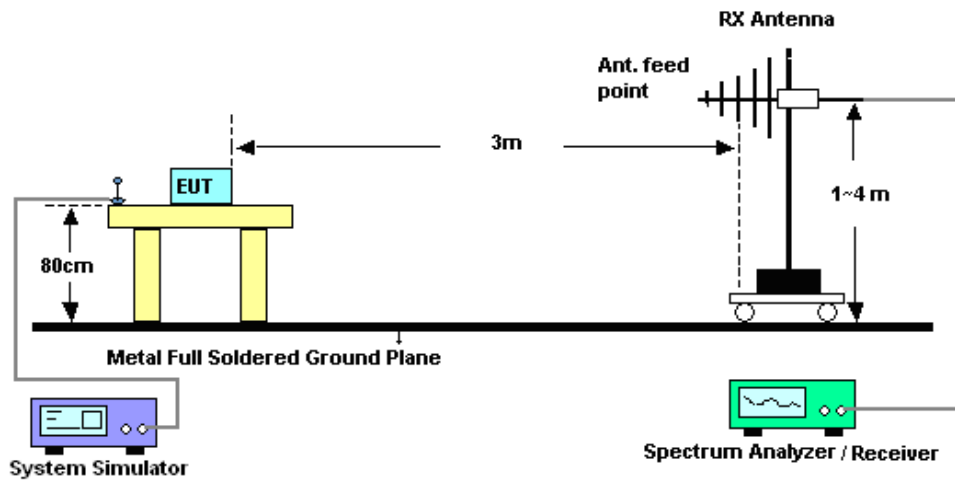

For radiated emissions above 1GHz

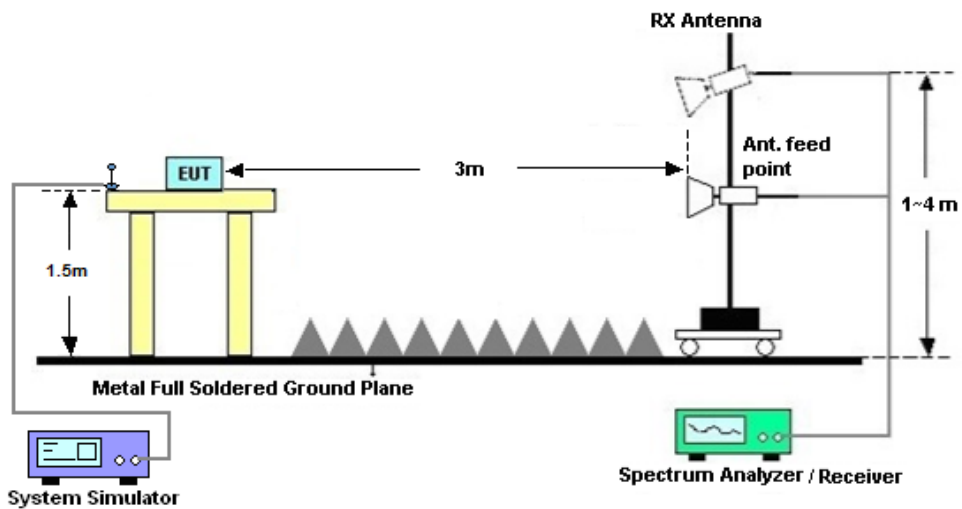



### **3.8.5 Test Results of Radiated Spurious Emissions (9 kHz ~ 30 MHz)**

The low frequency, which started from 9 kHz to 30MHz, was pre-scanned and the result which was 20dB lower than the limit line was not reported.

There is a comparison data of both open-field test site and semi-Anechoic chamber, and the result came out very similar.

### **3.8.6 Test Result of Radiated Spurious at Band Edges**

Please refer to Appendix B.

### **3.8.7 Test Result of Radiated Spurious Emission (30MHz ~ 10<sup>th</sup> Harmonic)**

Please refer to Appendix B.

### **3.8.8 Duty cycle correction factor for average measurement**

Please refer to Appendix C.

## 3.9 AC Conducted Emission Measurement

### 3.9.1 Limit of AC Conducted Emission

For equipment that is designed to be connected to the public utility (AC) power line, the radio frequency voltage that is conducted back onto the AC power line on any frequency or frequencies within the band 150 kHz to 30 MHz shall not exceed the limits in the following table.

Frequency of emission (MHz)	Conducted limit (dB $\mu$ V)	
	Quasi-peak	Average
0.15-0.5	66 to 56*	56 to 46*
0.5-5	56	46
5-30	60	50

\*Decreases with the logarithm of the frequency.

### 3.9.2 Measuring Instruments

The measuring equipment is listed in the section 4 of this test report.

### 3.9.3 Test Procedures

1. The EUT was placed 0.4 meter from the conducting wall of the shielding room was kept at least 80 centimeters from any other grounded conducting surface.
2. Connect EUT to the power mains through a line impedance stabilization network (LISN).
3. All the support units are connecting to the other LISN.
4. The LISN provides 50 ohm coupling impedance for the measuring instrument.
5. The FCC states that a 50 ohm, 50 microhenry LISN should be used.
6. Both sides of AC line were checked for maximum conducted interference.
7. The frequency range from 150 kHz to 30 MHz was searched.
8. Set the test-receiver system to Peak Detect Function and specified bandwidth (IF Bandwidth = 9kHz) with Maximum Hold Mode. Then measurement is also conducted by Average Detector and Quasi-Peak Detector Function respectively.

### 3.9.4 Test Setup

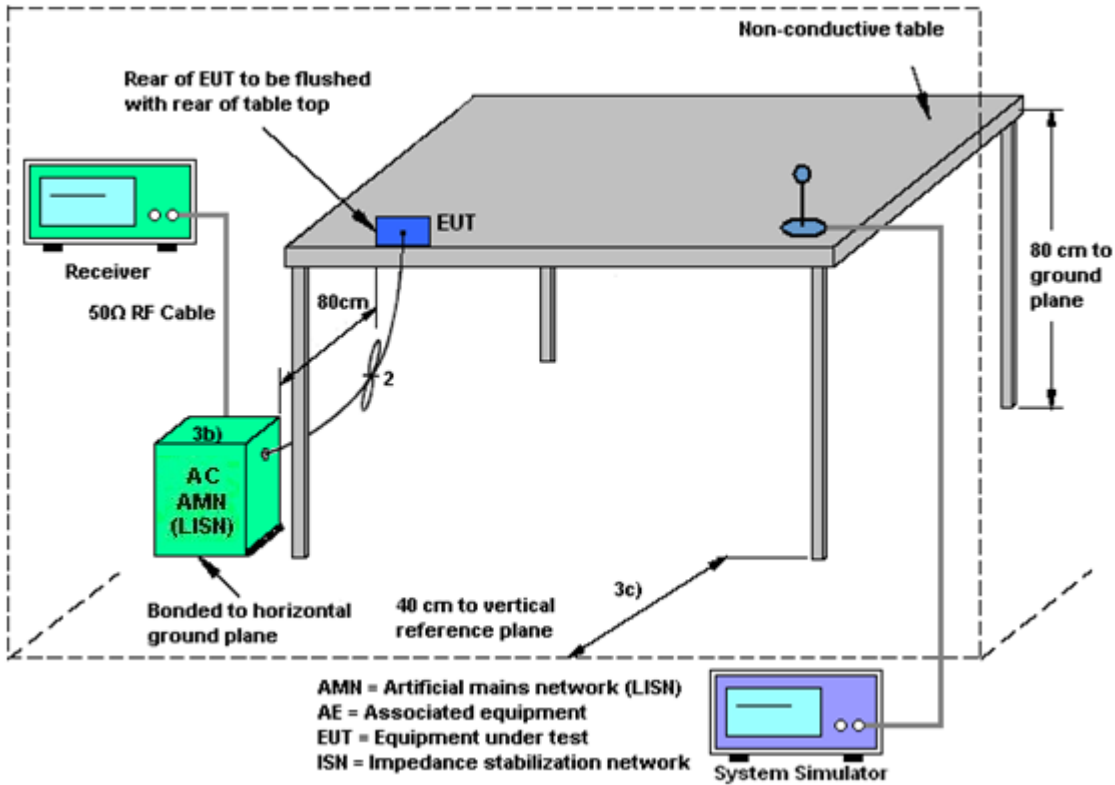

### 3.9.5 Test Result of AC Conducted Emission

Please refer to Appendix A.



## **3.10 Antenna Requirements**

### **3.10.1 Standard Applicable**

If directional gain of transmitting antennas is greater than 6dBi, the power shall be reduced by the same level in dB comparing to gain minus 6dBi. The use of a permanently attached antenna or of an antenna that uses a unique coupling to the intentional radiator shall be considered sufficient to comply with the rule.

### **3.10.2 Antenna Anti-Replacement Construction**

An embedded-in antenna design is used.

### **3.10.3 Antenna Gain**

The antenna peak gain of EUT is less than 6 dBi. Therefore, it is not necessary to reduce maximum peak output power limit.



## 4 List of Measuring Equipment

Instrument	Manufacturer	Model No.	Serial No.	Characteristics	Calibration Date	Test Date	Due Date	Remark
Spectrum Analyzer	R&S	FSV40	101040	10Hz~40GHz	Aug. 07, 2018	Jul. 30, 2019~ Aug. 05, 2019	Aug. 06, 2019	Conducted (TH01-KS)
Pulse Power Sensor	Anritsu	MA2411B	0917070	300MHz~40GHz	Jan. 14, 2019	Jul. 30, 2019~ Aug. 05, 2019	Jan. 13, 2020	Conducted (TH01-KS)
Power Meter	Anritsu	ML2495A	1005002	50MHz Bandwidth	Jan. 14, 2019	Jul. 30, 2019~ Aug. 05, 2019	Jan. 13, 2020	Conducted (TH01-KS)
EMI Test Receiver	Keysight	N9038A	MY564000 04	3Hz~8.5GHz;Max 30dBm	Oct. 12, 2018	Aug. 16, 2019	Oct. 11, 2019	Radiation (03CH05-KS)
EXA Spectrum Analyzer	Keysight	N9010A	MY553705 28	10Hz-44GHz	Oct. 09, 2018	Aug. 16, 2019	Oct. 08, 2019	Radiation (03CH05-KS)
Loop Antenna	R&S	HFH2-Z2	100321	9kHz~30MHz	Oct. 19, 2018	Aug. 16, 2019	Oct. 18, 2019	Radiation (03CH05-KS)
Bilog Antenna	TeseQ	CBL6111D	44483	30MHz-1GHz	Dec. 28, 2018	Aug. 16, 2019	Dec. 27, 2019	Radiation (03CH05-KS)
Double Ridge Horn Antenna	ETS-Lindgren	3117	75959	1GHz~18GHz	Jan. 27, 2019	Aug. 16, 2019	Jan. 26, 2020	Radiation (03CH05-KS)
SHF-EHF Horn	Com-power	AH-840	101070	18GHz~40GHz	Jan. 05, 2019	Aug. 16, 2019	Jan. 04, 2020	Radiation (03CH05-KS)
Amplifier	SONOMA	310N	187289	9KHz-1GHz	Aug. 06, 2019	Aug. 16, 2019	Aug. 05, 2020	Radiation (03CH05-KS)
Amplifier	MITEQ	TTA1840-35-HG	2014749	18~40GHz	Jan. 14, 2019	Aug. 16, 2019	Jan. 13, 2020	Radiation (03CH05-KS)
high gain Amplifier	MITEQ	AMF-7D-0010 1800-30-10P	2025788	1Ghz-18Ghz	Aug. 06, 2019	Aug. 16, 2019	Aug. 05, 2020	Radiation (03CH05-KS)
Amplifier	Keysight	83017A	MY532703 16	500MHz~26.5GHz	Dec. 22, 2018	Aug. 16, 2019	Dec. 21, 2019	Radiation (03CH05-KS)
AC Power Source	Chroma	61601	F1040900 04	N/A	NCR	Aug. 16, 2019	NCR	Radiation (03CH05-KS)
Turn Table	ChamPro	EM 1000-T	060762-T	0~360 degree	NCR	Aug. 16, 2019	NCR	Radiation (03CH05-KS)
Antenna Mast	ChamPro	EM 1000-A	060762-A	1 m~4 m	NCR	Aug. 16, 2019	NCR	Radiation (03CH05-KS)
EMI Receiver	R&S	ESCI7	100768	9kHz~7GHz;	Apr. 16, 2019	Aug. 16, 2019	Apr. 15, 2020	Conduction (CO01-KS)
AC LISN	MessTec	AN3016	060103	9kHz~30MHz	Oct. 12, 2018	Aug. 16, 2019	Oct. 11, 2019	Conduction (CO01-KS)
AC LISN (for auxiliary equipment)	MessTec	AN3016	060105	9kHz~30MHz	Nov. 19, 2018	Aug. 16, 2019	Nov. 18, 2019	Conduction (CO01-KS)
AC Power Source	Chroma	61602	ABP00000 0811	AC 0V~300V, 45Hz~1000Hz	Oct. 12, 2018	Aug. 16, 2019	Oct. 11, 2019	Conduction (CO01-KS)

NCR: No Calibration Required





## 5 Uncertainty of Evaluation

The measurement uncertainties shown below were calculated in accordance with the requirements of ANSI 63.10-2013. All the measurement uncertainty value were shown with a coverage K=2 to indicate 95% level of confidence. The measurement data show herein meets or exceeds the CISPR measurement uncertainty values specified in CISPR 16-4-2 and can be compared directly to specified limit to determine compliance.

### Uncertainty of Conducted Emission Measurement (150 kHz ~ 30 MHz)

Measuring Uncertainty for a Level of Confidence of 95% (U = 2Uc(y))	2.9dB
---	-------

### Uncertainty of Radiated Emission Measurement (30 MHz ~ 1000 MHz)

Measuring Uncertainty for a Level of Confidence of 95% (U = 2Uc(y))	5.0dB
---	-------

### Uncertainty of Radiated Emission Measurement (1000 MHz ~ 18000 MHz)

Measuring Uncertainty for a Level of Confidence of 95% (U = 2Uc(y))	5.0dB
---	-------

### Uncertainty of Radiated Emission Measurement (18000 MHz ~ 40000 MHz)

Measuring Uncertainty for a Level of Confidence of 95% (U = 2Uc(y))	5.0dB
---	-------



## Appendix A. AC Conducted Emission Test Results

Test Engineer :	Amos Zhang	Temperature :	25.3~26.2°C
		Relative Humidity :	38~40%
Test Voltage :	120Vac / 60Hz	Phase :	Line

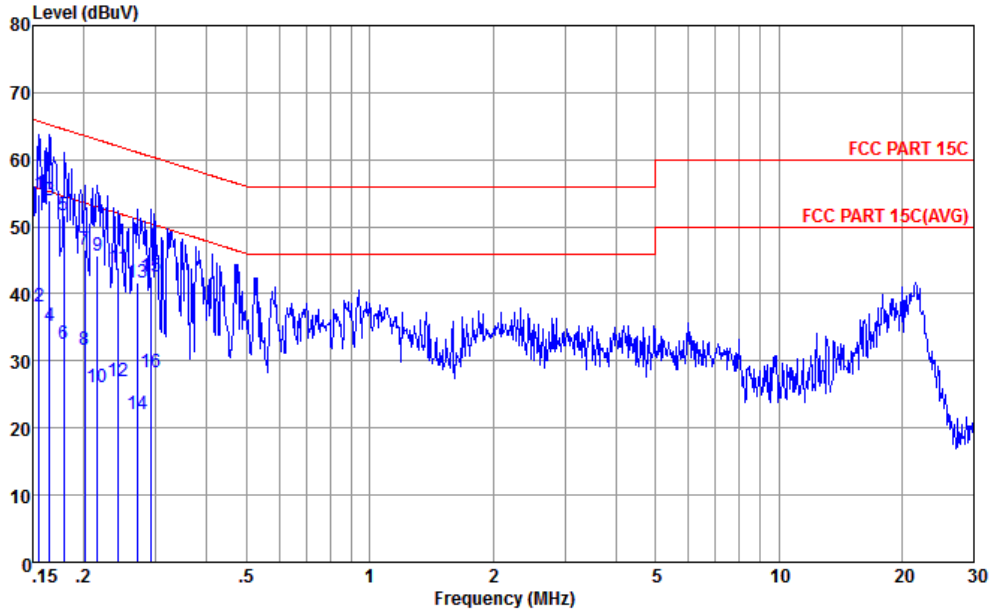

Site : CO01-KS  
 Condition : FCC PART 15C LISN-L-181119-060105 LINE

mode : Mode 1

	Freq	Level	Over	Limit	Read	LISN	Cable	Remark
	MHz	dBuV	dB	dBuV	dBuV	dB	dB	
1 *	0.156	54.76	-10.93	65.69	44.20	0.09	10.47	QP
2	0.156	38.16	-17.53	55.69	27.60	0.09	10.47	Average
3	0.165	53.84	-11.37	65.21	43.30	0.10	10.44	QP
4	0.165	35.14	-20.07	55.21	24.60	0.10	10.44	Average
5	0.179	51.62	-12.93	64.55	41.10	0.11	10.41	QP
6	0.179	32.62	-21.93	54.55	22.10	0.11	10.41	Average
7	0.201	46.68	-16.90	63.58	36.20	0.12	10.36	QP
8	0.201	31.68	-21.90	53.58	21.20	0.12	10.36	Average
9	0.216	45.58	-17.38	62.96	35.11	0.12	10.35	QP
10	0.216	25.98	-26.98	52.96	15.51	0.12	10.35	Average
11	0.243	43.97	-18.03	62.00	33.50	0.13	10.34	QP
12	0.243	27.07	-24.93	52.00	16.60	0.13	10.34	Average
13	0.270	41.66	-19.46	61.12	31.20	0.14	10.32	QP
14	0.270	22.06	-29.06	51.12	11.60	0.14	10.32	Average
15	0.291	42.65	-17.85	60.50	32.20	0.14	10.31	QP
16	0.291	28.35	-22.15	50.50	17.90	0.14	10.31	Average



Test Engineer :	Amos Zhang	Temperature :	25.3~26.2°C
		Relative Humidity :	38~40%
Test Voltage :	120Vac / 60Hz	Phase :	Neutral

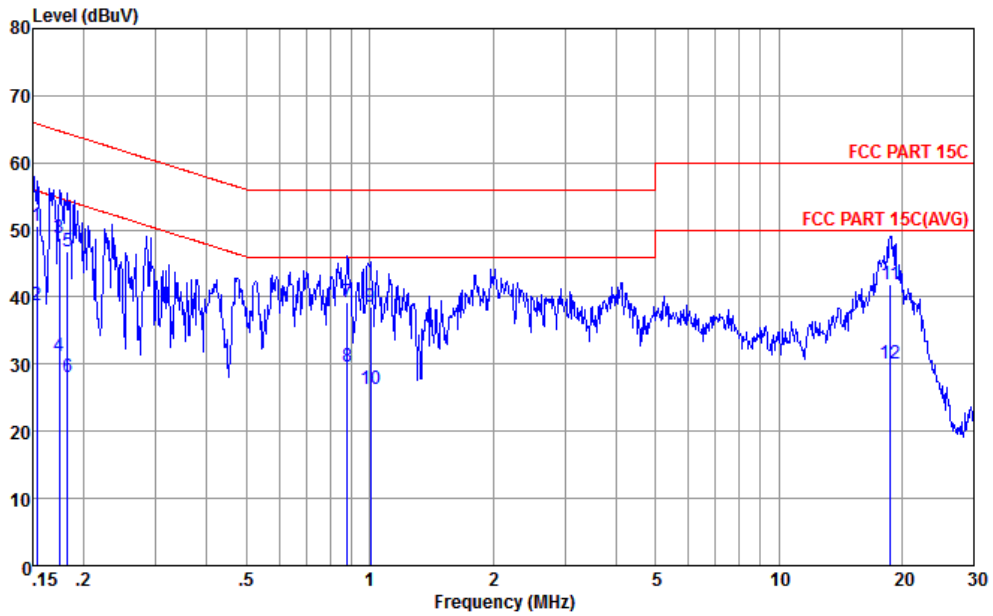

Site : CO01-KS  
 Condition : FCC PART 15C LISN-N-181119-060105 NEUTRAL  
 mode : Mode 1

	Freq	Level	Over	Limit	Read	LISN	Cable	Remark
	MHz	dBuV	Limit	Line	Level	Factor	Loss	
			dB	dBuV	dBuV	dB	dB	
1 *	0.153	50.55	-15.27	65.82	39.90	0.18	10.47	QP
2	0.153	38.85	-16.97	55.82	28.20	0.18	10.47	Average
3	0.174	48.80	-15.97	64.77	38.20	0.18	10.42	QP
4	0.174	31.10	-23.67	54.77	20.50	0.18	10.42	Average
5	0.182	46.78	-17.59	64.37	36.21	0.17	10.40	QP
6	0.182	28.18	-26.19	54.37	17.61	0.17	10.40	Average
7	0.880	39.27	-16.73	56.00	28.90	0.13	10.24	QP
8	0.880	29.67	-16.33	46.00	19.30	0.13	10.24	Average
9	1.005	38.56	-17.44	56.00	28.20	0.13	10.23	QP
10	1.005	26.26	-19.74	46.00	15.90	0.13	10.23	Average
11	18.721	41.78	-18.22	60.00	31.20	0.11	10.47	QP
12	18.721	30.18	-19.82	50.00	19.60	0.11	10.47	Average



### Appendix B. Radiated Spurious Emission

2.4GHz 2400~2483.5MHz

BT (Band Edge @ 3m)

BT	Note	Frequency	Level	Over Limit	Limit Line	Read Level	Antenna Factor	Cable Loss	Preamp Factor	Ant Pos	Table Pos	Peak Avg.	Pol.	
		( MHz )	( dBμV/m )	( dB )	( dBμV/m )	( dBμV )	( dB/m )	( dB )	( dB )	( cm )	( deg )	( P/A )	( H/V )	
BT CH00 2402MHz		2320.92	51.35	-22.65	74	47.42	31.12	5.38	32.57	245	355	P	H	
	*	2320.92	26.56	-27.44	54	-	-	-	-	-	-	A	H	
		2402	91.40	-	-	87.15	31.3	5.48	32.53	245	355	P	H	
		2402	66.61	-	-	-	-	-	-	-	-	A	H	
		2362	51.41	-22.59	74	47.32	31.21	5.43	32.55	101	79	P	V	
	*	2362	26.62	-27.38	54	-	-	-	-	-	-	-	A	V
		2402	86.00	-	-	81.75	31.3	5.48	32.53	101	79	P	V	
		2402	61.21	-	-	-	-	-	-	-	-	-	A	V
BT CH 78 2480MHz	*	2480	97.34	-	-	92.51	31.59	5.55	32.31	294	327	P	H	
		2480	72.55	-	-	-	-	-	-	-	-	A	H	
		2484.53	52.34	-21.66	74	47.51	31.59	5.55	32.31	294	327	P	H	
		2484.53	27.55	-26.45	54	-	-	-	-	-	-	A	H	
	*	2480	95.43	-	-	90.6	31.59	5.55	32.31	373	42	P	V	
		2480	70.64	-	-	-	-	-	-	-	-	A	V	
		2488.38	51.99	-22.01	74	47.11	31.64	5.55	32.31	373	42	P	V	
		2488.38	27.20	-26.80	54	-	-	-	-	-	-	-	A	V
Remark	1. No other spurious found. 2. All results are PASS against Peak and Average limit line.													



2.4GHz 2400~2483.5MHz
BT (Harmonic @ 3m)

Table with 14 columns: BT, Note, Frequency (MHz), Level (dBµV/m), Over Limit (dB), Limit Line (dBµV/m), Read Level (dBµV), Antenna Factor (dB/m), Cable Loss (dB), Preamp Factor (dB), Ant Pos (cm), Table Pos (deg), Peak Avg. (P/A), Pol. (H/V). Rows include data for BT CH 00 (2402MHz), BT CH 39 (2441MHz), and BT CH 78 (2480MHz). A Remark section at the bottom states: '1. No other spurious found. 2. All results are PASS against Peak and Average limit line.'



Emission below 1GHz

2.4GHz BT (LF)

BT	Note	Frequency	Level	Over	Limit	Read	Antenna	Cable	Preamp	Ant	Table	Peak	Pol.
		( MHz )	( dBμV/m )	( dB )	( dBμV/m )	( dBμV )	( dB/m )	( dB )	( dB )	( cm )	( deg )	( P/A )	( H/V )
2.4GHz BT LF		46.49	20.42	-19.58	40	36.32	16.27	0.79	32.96	-	-	P	H
		109.54	24.3	-19.2	43.5	38.87	17.2	1.16	32.93	-	-	P	H
		175.5	32.99	-10.51	43.5	49.09	15.37	1.46	32.93	100	53	P	H
		220.12	28.79	-17.21	46	44.69	15.4	1.64	32.94	-	-	P	H
		314.21	26.69	-19.31	46	38.03	19.75	1.95	33.04	-	-	P	H
		515	25.17	-20.83	46	31.35	24.58	2.5	33.26	-	-	P	H
		46.49	33.96	-6.04	40	49.86	16.27	0.79	32.96	100	98	P	V
		74.62	20.12	-19.88	40	39.12	12.95	0.96	32.91	-	-	P	V
		108.57	22.52	-20.98	43.5	37.18	17.11	1.16	32.93	-	-	P	V
		226.91	24.59	-21.41	46	39.84	16.03	1.67	32.95	-	-	P	V
		319.06	21.55	-24.45	46	32.78	19.86	1.96	33.05	-	-	P	V
		571.26	24.23	-21.77	46	29.3	25.63	2.63	33.33	-	-	P	V

**Remark**

- No other spurious found.
- All results are PASS against limit line.



Note symbol

*	<b>Fundamental Frequency</b> which can be ignored. However, the level of any unwanted emissions shall not exceed the level of the fundamental frequency.
!	Test result is <b>over limit</b> line.
P/A	<b>Peak</b> or <b>Average</b>
H/V	<b>Horizontal</b> or <b>Vertical</b>



A calculation example for radiated spurious emission is shown as below:

WIFI	Note	Frequency	Level	Over	Limit	Read	Antenna	Cable	Preamp	Ant	Table	Peak	Pol.
Ant.				Limit	Line	Level	Factor	Loss	Factor	Pos	Pos	Avg.	
1+2		( MHz )	( dBμV/m )	( dB )	( dBμV/m )	( dBμV )	( dB/m )	( dB )	( dB )	( cm )	( deg )	( P/A )	( H/V )
802.11b		2390	55.45	-18.55	74	54.51	32.22	4.58	35.86	103	308	P	H
CH 01													
2412MHz		2390	43.54	-10.46	54	42.6	32.22	4.58	35.86	103	308	A	H

- Level(dBμV/m) =  
Antenna Factor(dB/m) + Cable Loss(dB) + Read Level(dBμV) - Preamp Factor(dB)
- Over Limit(dB) = Level(dBμV/m) – Limit Line(dBμV/m)

**For Peak Limit @ 2390MHz:**

- Level(dBμV/m)  
= Antenna Factor(dB/m) + Cable Loss(dB) + Read Level(dBμV) - Preamp Factor(dB)  
= 32.22(dB/m) + 4.58(dB) + 54.51(dBμV) – 35.86 (dB)  
= 55.45 (dBμV/m)
- Over Limit(dB)  
= Level(dBμV/m) – Limit Line(dBμV/m)  
= 55.45(dBμV/m) – 74(dBμV/m)  
= -18.55(dB)

**For Average Limit @ 2390MHz:**

- Level(dBμV/m)  
= Antenna Factor(dB/m) + Cable Loss(dB) + Read Level(dBμV) - Preamp Factor(dB)  
= 32.22(dB/m) + 4.58(dB) + 42.6(dBμV) – 35.86 (dB)  
= 43.54 (dBμV/m)
- Over Limit(dB)  
= Level(dBμV/m) – Limit Line(dBμV/m)  
= 43.54(dBμV/m) – 54(dBμV/m)  
= -10.46(dB)

Both peak and average measured complies with the limit line, so test result is “PASS”.



## Appendix C. Duty Cycle Plots

### DH5 on time (One Pulse) Plot on Channel 39

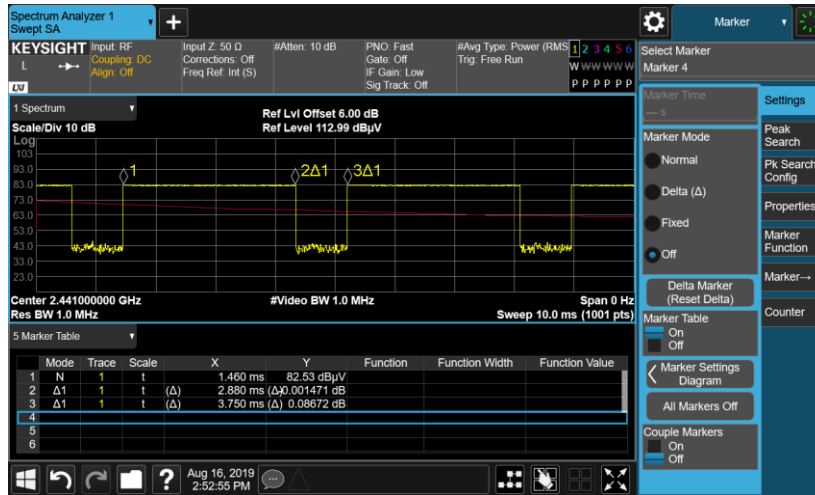

### DH5 on time (Count Pulses) Plot on Channel 39

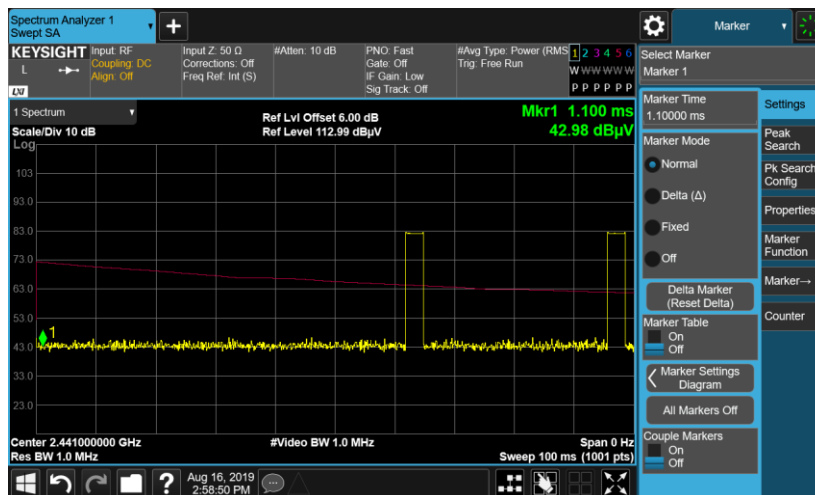

**Note:**

1. Worst case Duty cycle = on time/100 milliseconds =  $2 * 2.88 / 100 = 5.76 \%$
2. Worst case Duty cycle correction factor =  $20 * \log(\text{Duty cycle}) = -24.79 \text{ dB}$
3. DH5 has the highest duty cycle worst case and is reported.