



# FCC RF Test Report

**APPLICANT** : Motorola Mobility LLC  
**EQUIPMENT** : Mobile Phone  
**BRAND NAME** : Motorola  
**MODEL NAME** : XT2029-1  
**FCC ID** : IHDT56YM1  
**STANDARD** : FCC Part 15 Subpart C §15.247  
**CLASSIFICATION** : (DTS) Digital Transmission System

The product was received on Jul. 29, 2019 and testing was completed on Aug. 20, 2019. We, Sporton International (Kunshan) Inc., would like to declare that the tested sample has been evaluated in accordance with the test procedures and has been in compliance with the applicable technical standards.

The test results in this report apply exclusively to the tested model / sample. Without written approval of Sporton International (Kunshan) Inc., the test report shall not be reproduced except in full.

*Jason Jia*

Reviewed by: Jason Jia / Supervisor

*James Huang*

Approved by: James Huang / Manager



**Sporton International (Kunshan) Inc.**

**No. 1098, Pengxi North Road, Kunshan Economic Development Zone Jiangsu Province 215300  
People's Republic of China**



# TABLE OF CONTENTS

**REVISION HISTORY..... 3**

**SUMMARY OF TEST RESULT ..... 4**

**1 GENERAL DESCRIPTION ..... 5**

    1.1 Applicant ..... 5

    1.2 Manufacturer ..... 5

    1.3 Product Feature of Equipment Under Test..... 5

    1.4 Product Specification of Equipment Under Test..... 6

    1.5 Modification of EUT ..... 6

    1.6 Testing Location ..... 6

    1.7 Applicable Standards..... 7

    1.8 Specification of Accessory..... 7

**2 TEST CONFIGURATION OF EQUIPMENT UNDER TEST ..... 8**

    2.1 Carrier Frequency and Channel ..... 8

    2.2 Test Mode ..... 9

    2.3 Connection Diagram of Test System ..... 10

    2.4 Support Unit used in test configuration and system ..... 11

    2.5 EUT Operation Test Setup ..... 11

    2.6 Measurement Results Explanation Example..... 11

**3 TEST RESULT ..... 12**

    3.1 6dB and 99% Bandwidth Measurement ..... 12

    3.2 Output Power Measurement..... 14

    3.3 Power Spectral Density Measurement ..... 15

    3.4 Conducted Band Edges and Spurious Emission Measurement ..... 17

    3.5 Radiated Band Edges and Spurious Emission Measurement ..... 27

    3.6 AC Conducted Emission Measurement..... 31

    3.7 Antenna Requirements ..... 33

**4 LIST OF MEASURING EQUIPMENT ..... 34**

**5 UNCERTAINTY OF EVALUATION ..... 35**

**APPENDIX A. CONDUCTED TEST RESULTS**

**APPENDIX B. AC CONDUCTED EMISSION TEST RESULT**

**APPENDIX C. RADIATED SPURIOUS EMISSION**

**APPENDIX D. DUTY CYCLE PLOTS**

**APPENDIX E. SETUP PHOTOGRAPHS**



### REVISION HISTORY

REPORT NO.	VERSION	DESCRIPTION	ISSUED DATE
FR972911C	Rev. 01	Initial issue of report	Sep. 11, 2019



### SUMMARY OF TEST RESULT

Report Section	FCC Rule	Description	Limit	Result	Remark
3.1	15.247(a)(2)	6dB Bandwidth	≥ 0.5MHz	Pass	-
3.2	15.247(b)	Power Output Measurement	≤ 30dBm	Pass	-
3.3	15.247(e)	Power Spectral Density	≤ 8dBm/3kHz	Pass	-
3.4	15.247(d)	Conducted Band Edges	≤ 20dBc	Pass	-
		Conducted Spurious Emission		Pass	-
3.5	15.247(d)	Radiated Band Edges and Radiated Spurious Emission	15.209(a) & 15.247(d)	Pass	Under limit 4.46 dB at 2483.500 MHz
3.6	15.207	AC Conducted Emission	15.207(a)	Pass	Under limit 10.93 dB at 0.156 MHz
3.7	15.203 & 15.247(b)	Antenna Requirement	N/A	Pass	-

<b>Declaration of Conformity:</b>
The test results with all measurement uncertainty excluded are presented in accordance with the regulation limits or requirements declared by manufacturers.
<b>Comments and Explanations:</b>
The declared of product specification for EUT presented in the report are provided by the manufacturer, and the manufacturer takes all the responsibilities for the accuracy of product specification.



# 1 General Description

## 1.1 Applicant

Motorola Mobility LLC  
222 W, Merchandise Mart Plaza,Chicago,IL60654 USA

## 1.2 Manufacturer

Motorola Mobility LLC  
222 W, Merchandise Mart Plaza,Chicago,IL60654 USA

## 1.3 Product Feature of Equipment Under Test

Product Feature	
Equipment	Mobile Phone
Brand Name	Motorola
Model Name	XT2029-1
FCC ID	IHDT56YM1
EUT supports Radios application	GSM/WCDMA/LTE WLAN 2.4GHz 802.11b/g/n HT20 Bluetooth BR/EDR/LE FM Receiver and GNSS
IMEI Code	Conducted: 357245100006550 Conduction: 357245100002526 Radiation: 357245100002534
HW Version	M3901-P
SW Version	POA29.101
EUT Stage	Identical Prototype

**Remark:**

1. The above EUT's information was declared by manufacturer. Please refer to the specifications or user's manual for more detailed description.
2. There are two types of EUT, the differences could refer the product equality declaration exhibit submitted. According to the difference, we choose the sample 1 (Single SIM card) to full test



### 1.4 Product Specification of Equipment Under Test

Standards-related Product Specification	
<b>Tx/Rx Channel Frequency Range</b>	2412 MHz ~ 2462 MHz
<b>Maximum (Peak) Output Power to antenna</b>	802.11b : 20.79 dBm (0.1199 W) 802.11g : 24.27 dBm (0.2673 W) 802.11n HT20 : 24.23 dBm (0.2649 W)
<b>99% Occupied Bandwidth</b>	802.11b : 12.79MHz 802.11g : 17.73MHz 802.11n HT20 : 18.33MHz
<b>Antenna Type / Gain</b>	loop Antenna with gain -1.45 dBi
<b>Type of Modulation</b>	802.11b : DSSS (DBPSK / DQPSK / CCK) 802.11g/n : OFDM (BPSK / QPSK / 16QAM / 64QAM)

### 1.5 Modification of EUT

No modifications are made to the EUT during all test items.

### 1.6 Testing Location

Sporton International (Kunshan) Inc. is accredited to ISO/IEC 17025:2017 by American Association for Laboratory Accreditation with Certificate Number 5145.02.

<b>Test Firm</b>	Sporton International (Kunshan) Inc.		
<b>Test Site Location</b>	No. 1098, Pengxi North Road, Kunshan Economic Development Zone Jiangsu Province 215300 People's Republic of China TEL : +86-512-57900158 FAX : +86-512-57900958		
<b>Test Site No.</b>	<b>Sporton Site No.</b>	<b>FCC Designation No.</b>	<b>FCC Test Firm Registration No.</b>
	CO01-KS TH01-KS 03CH05-KS	CN1257	314309



## 1.7 Applicable Standards

According to the specifications of the manufacturer, the EUT must comply with the requirements of the following standards:

- ♦ 47 CFR Part 15 Subpart C §15.247
- ♦ FCC KDB 558074 D01 15.247 Meas Guidance v05r02
- ♦ ANSI C63.10-2013

**Remark:**

1. All test items were verified and recorded according to the standards and without any deviation during the test.
2. This EUT has also been tested and complied with the requirements of FCC Part 15, Subpart B, recorded in a separate test report.

## 1.8 Specification of Accessory

Specification of Accessory				
AC Adapter 1(US)	Brand Name	Motorola (Acbel)	Model Name	SC-61
	Power Rating	I/P: 100-240 Vac, 0.13A, 50/60Hz; O/P: 5Vdc,1A		
AC Adapter 1(AR)	Brand Name	Motorola (Acbel)	Model Name	SC-64
	Power Rating	I/P: 100-240 Vac, 0.13A, 50/60Hz; O/P: 5Vdc,1A		
AC Adapter 1(Chile)	Brand Name	Motorola (Acbel)	Model Name	SC-62
	Power Rating	I/P: 100-240 Vac, 0.13A, 50/60Hz; O/P: 5Vdc,1A		
AC Adapter 2(US)	Brand Name	Motorola (Chenyang)	Model Name	SC-61
	Power Rating	I/P: 100-240 Vac, 0.13A, 50/60Hz; O/P: 5Vdc,1A		
AC Adapter 2(AR)	Brand Name	Motorola (Chenyang)	Model Name	SC-64
	Power Rating	I/P: 100-240 Vac, 0.13A, 50/60Hz; O/P: 5Vdc,1A		
Battery 1	Brand Name	Motorola(ATL)	Model Name	KS40
	Power Rating	4.4Vdc,3000mAh	Type	Li-ion
Battery 2	Brand Name	Motorola(Sunwoda)	Model Name	KS40
	Power Rating	4.4Vdc,3000mAh	Type	Li-ion
Earphone	Brand Name	Juwei Electronctcs Co ., LTD	Model Name	JWEP1131-ZN01
	Signal Line Type	1.10 meter, non-shielded cable, without ferrite core		
USB Cable	Brand Name	Li Qi Electronics	Model Name	LQ048018
	Signal Line Type	1.0 meter, shielded cable, without ferrite core		



## 2 Test Configuration of Equipment Under Test

- a. The EUT has been associated with peripherals and configuration operated in a manner tended to maximize its emission characteristics in a typical application. Frequency range investigated: conduction emission (150 kHz to 30 MHz), radiation emission (9 kHz to the 10th harmonic of the highest fundamental frequency or to 40 GHz, whichever is lower). For radiated measurement, pre-scanned in three orthogonal panels, X, Y, Z. The worst cases (X plane) were recorded in this report.
- b. AC power line Conducted Emission was tested under maximum output power.

### 2.1 Carrier Frequency and Channel

Frequency Band	Channel	Freq. (MHz)	Channel	Freq. (MHz)
2400-2483.5 MHz	1	2412	7	2442
	2	2417	8	2447
	3	2422	9	2452
	4	2427	10	2457
	5	2432	11	2462
	6	2437		





## 2.2 Test Mode

Final test modes are considering the modulation and worse data rates as below table.

Modulation	Data Rate
802.11b	1 Mbps
802.11g	6 Mbps
802.11n HT20	MCS0

Test Cases	
AC Conducted Emission	Mode 1 :GSM 850 Idle + Bluetooth Link + WLAN Link (2.4G) + Earphone + USB Cable (Charging from Adapter 2)

## 2.3 Connection Diagram of Test System

For Radiation

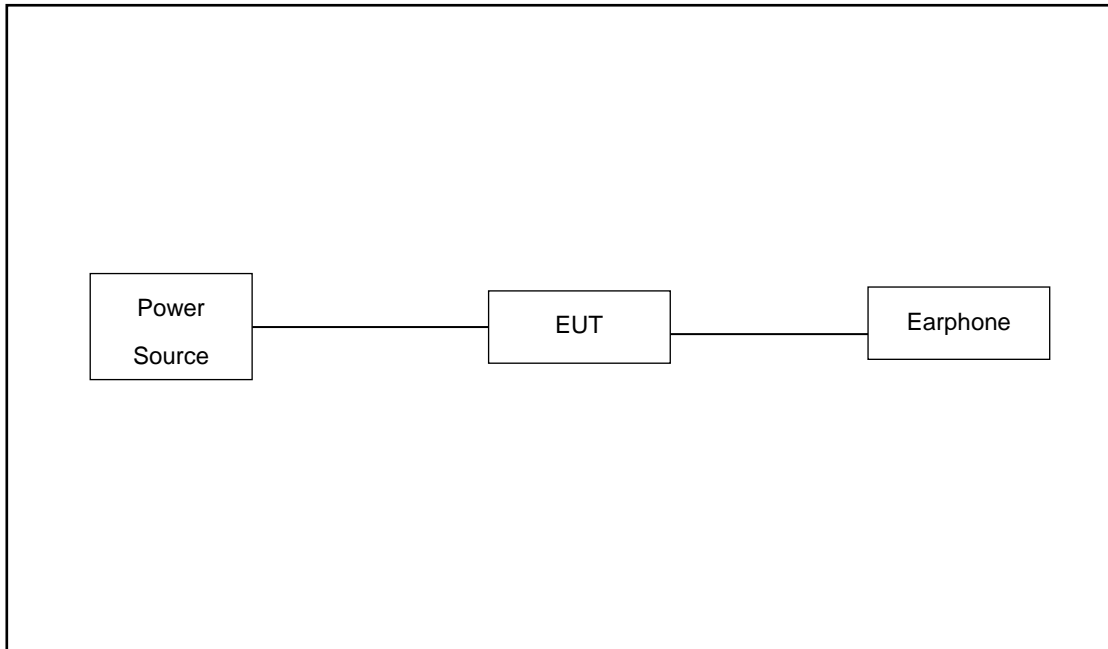

For Conducted Emission

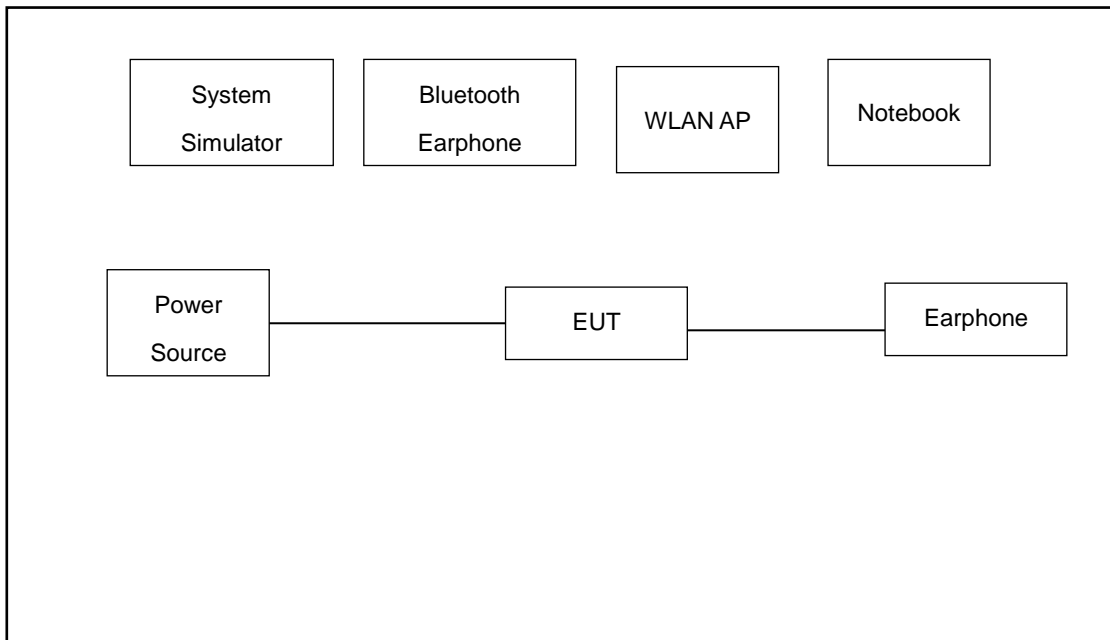



### 2.4 Support Unit used in test configuration and system

Item	Equipment	Trade Name	Model Name	FCC ID	Data Cable	Power Cord
1.	System Simulator	Anritsu	MT8820C	N/A	N/A	Unshielded, 1.8m
2.	WLAN AP	D-Link	DIR-655	KA21R655B1	N/A	Unshielded, 1.8m
3.	Notebook	Lenovo	G480	QDS-BRCM1050I	N/A	AC I/P: Unshielded, 1.8 m DC O/P: Shielded, 1.8 m
4.	Bluetooth Earphone	Lenovo	LBH308	N/A	N/A	N/A

### 2.5 EUT Operation Test Setup

For WLAN function, the engineering test program was provided and enabled to make EUT continuous transmit/receive.

For AC power line conducted emissions, the EUT was set to connect with the WLAN AP under large package sizes transmission.

### 2.6 Measurement Results Explanation Example

For all conducted test items:

The offset level is set in the spectrum analyzer to compensate the RF cable loss between EUT conducted output port and spectrum analyzer. With the offset compensation, the spectrum analyzer reading level is exactly the EUT RF output level.

Example :

The spectrum analyzer offset is derived from RF cable loss.

$$\text{Offset} = \text{RF cable loss.}$$

Following shows an offset computation example with cable loss 5.10 dB.

$$\begin{aligned} \text{Offset(dB)} &= \text{RF cable loss(dB)}. \\ &= 5.10 \text{ (dB)} \end{aligned}$$

### 3 Test Result

#### 3.1 6dB and 99% Bandwidth Measurement

##### 3.1.1 Limit of 6dB and 99% Bandwidth

The minimum 6 dB bandwidth shall be at least 500 kHz.

##### 3.1.2 Measuring Instruments

The measuring equipment is listed in the section 4 of this test report.

##### 3.1.3 Test Procedures

1. The testing follows ANSI C63.10-2013 clause 11.8
2. The RF output of EUT was connected to the spectrum analyzer by RF cable and attenuator. The path loss was compensated to the results for each measurement.
3. Set to the maximum power setting and enable the EUT transmit continuously.
4. Make the measurement with the spectrum analyzer's resolution bandwidth (RBW) = 100 kHz. Set the Video bandwidth (VBW) = 300 kHz. In order to make an accurate measurement. The 6 dB bandwidth must be greater than 500 kHz.
5. For 99% Bandwidth Measurement, the spectrum analyzer's resolution bandwidth (RBW) = 1MHz and set the Video bandwidth (VBW) = 3MHz.
6. Measure and record the results in the test report.

##### 3.1.4 Test Setup





### 3.1.5 Test Result of 6dB and 99% Occupied Bandwidth

Please refer to Appendix A.

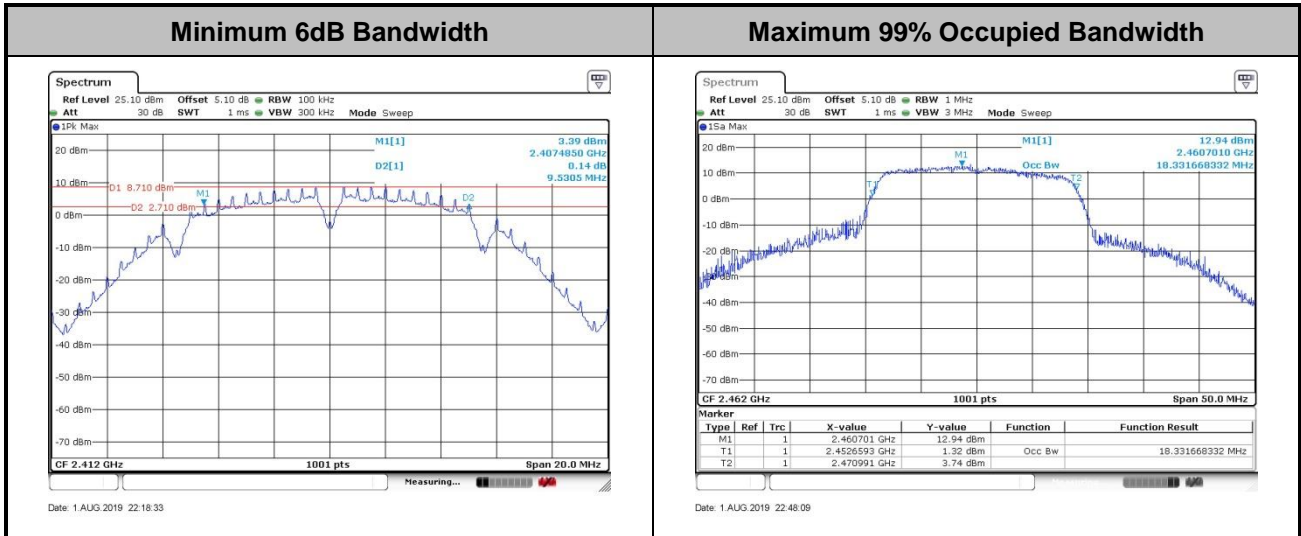

Note : The occupied channel bandwidth is maintained within the band of operation for all of the modulations.

## 3.2 Output Power Measurement

### 3.2.1 Limit of Output Power

For systems using digital modulation in the 2400-2483.5MHz, the limit for peak output power is 30dBm. If transmitting antenna with directional gain greater than 6dBi is used, the peak output power from the intentional radiator shall be reduced below the above stated value by the amount in dB that the directional gain of the antenna exceeds 6 dBi. In case of point-to-point operation, the limit has to be reduced by 1dB for every 3dB that the directional gain of the antenna exceeds 6dBi.

### 3.2.2 Measuring Instruments

The measuring equipment is listed in the section 4 of this test report.

### 3.2.3 Test Procedures

1. The testing follows the Measurement Procedure of ANSI C63.10-2013 clause 11.9.1.3 PKPM1 Peak power meter or ANSI C63.10-2013 clause 11.9.2.3.2 Method AVGPM-G method.
2. The RF output of EUT was connected to the power meter by RF cable and attenuator. The path loss was compensated to the results for each measurement.
3. Set to the maximum power setting and enable the EUT transmit continuously.
4. Measure the conducted output power and record the results in the test report.

### 3.2.4 Test Setup

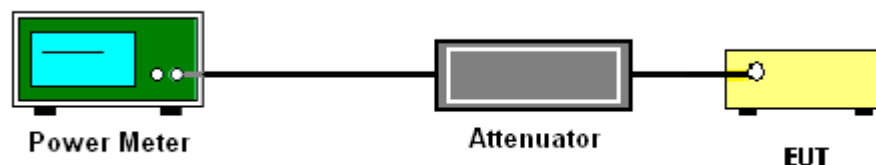

### 3.2.5 Test Result of Peak Output Power

Please refer to Appendix A.

### 3.2.6 Test Result of Average output Power (Reporting Only)

Please refer to Appendix A.



### **3.3 Power Spectral Density Measurement**

#### **3.3.1 Limit of Power Spectral Density**

The peak power spectral density shall not be greater than 8dBm in any 3kHz band at any time interval of continuous transmission.

#### **3.3.2 Measuring Instruments**

The measuring equipment is listed in the section 4 of this test report.

#### **3.3.3 Test Procedures**

1. The testing follows Measurement Procedure of ANSI C63.10-2013 clause 11.10.2 Method PKPSD.
2. The RF output of EUT was connected to the spectrum analyzer by RF cable and attenuator. The path loss was compensated to the results for each measurement.
3. Set to the maximum power setting and enable the EUT transmit continuously.
4. Make the measurement with the spectrum analyzer's resolution bandwidth (RBW) = 3 kHz. Video bandwidth VBW = 10 kHz In order to make an accurate measurement, set the span to 1.5 times DTS Channel Bandwidth. (6dB BW)
5. Detector = peak, Sweep time = auto couple, Trace mode = max hold, Allow trace to fully stabilize. Use the peak marker function to determine the maximum power level.
6. Measure and record the results in the test report.

### 3.3.4 Test Setup

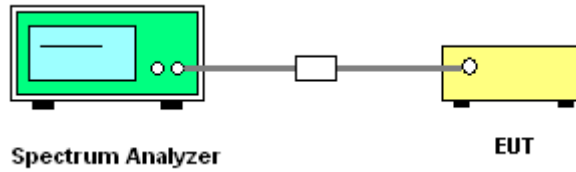

### 3.3.5 Test Result of Power Spectral Density

Please refer to Appendix A.

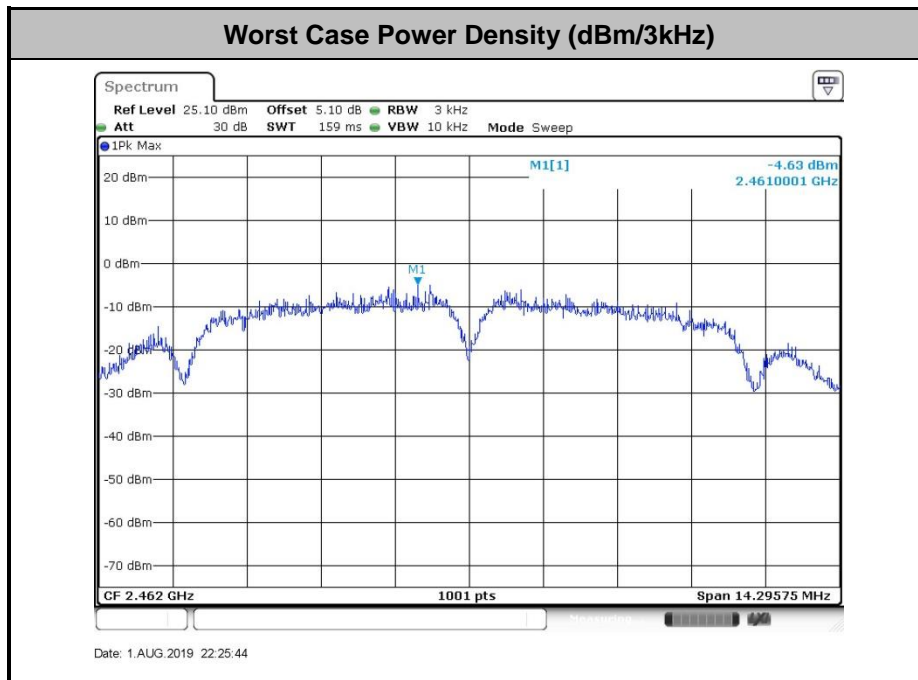



## 3.4 Conducted Band Edges and Spurious Emission Measurement

### 3.4.1 Limit of Conducted Band Edges and Spurious Emission Measurement

In any 100 kHz bandwidth outside of the authorized frequency band, the emissions which fall in the non-restricted bands shall be attenuated at least 20 dB / 30dB relative to the maximum PSD level in 100 kHz by RF conducted measurement.

### 3.4.2 Measuring Instruments

The measuring equipment is listed in the section 4 of this test report.

### 3.4.3 Test Procedures

1. The testing follows ANSI C63.10-2013 clause 11.13
2. The RF output of EUT was connected to the spectrum analyzer by RF cable and attenuator. The path loss was compensated to the results for each measurement.
3. Set to the maximum power setting and enable the EUT transmit continuously.
4. Set RBW = 100 kHz, VBW=300 kHz, Peak Detector. Unwanted Emissions measured in any 100 kHz bandwidth outside of the authorized frequency band shall be attenuated by at least 20 dB relative to the maximum in-band peak PSD level in 100 kHz when maximum peak conducted output power procedure is used. If the transmitter complies with the conducted power limits based on the use of RMS averaging over a time interval, the attenuation required under this paragraph shall be 30 dB instead of 20 dB per 15.247(d).
5. Measure and record the results in the test report.
6. The RF fundamental frequency should be excluded against the limit line in the operating frequency band.

### 3.4.4 Test Setup

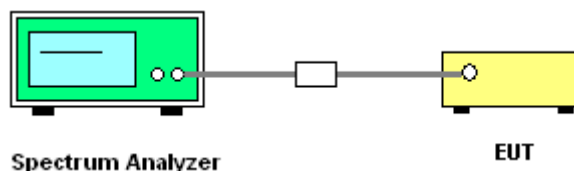



### 3.4.5 Test Result of Conducted Band Edges and Spurious Emission

Test Engineer : Aly Cao	Temperature :	21~25°C
	Relative Humidity :	51~54%

Test Mode :	802.11b	Test Channel :	01
-------------	---------	----------------	----

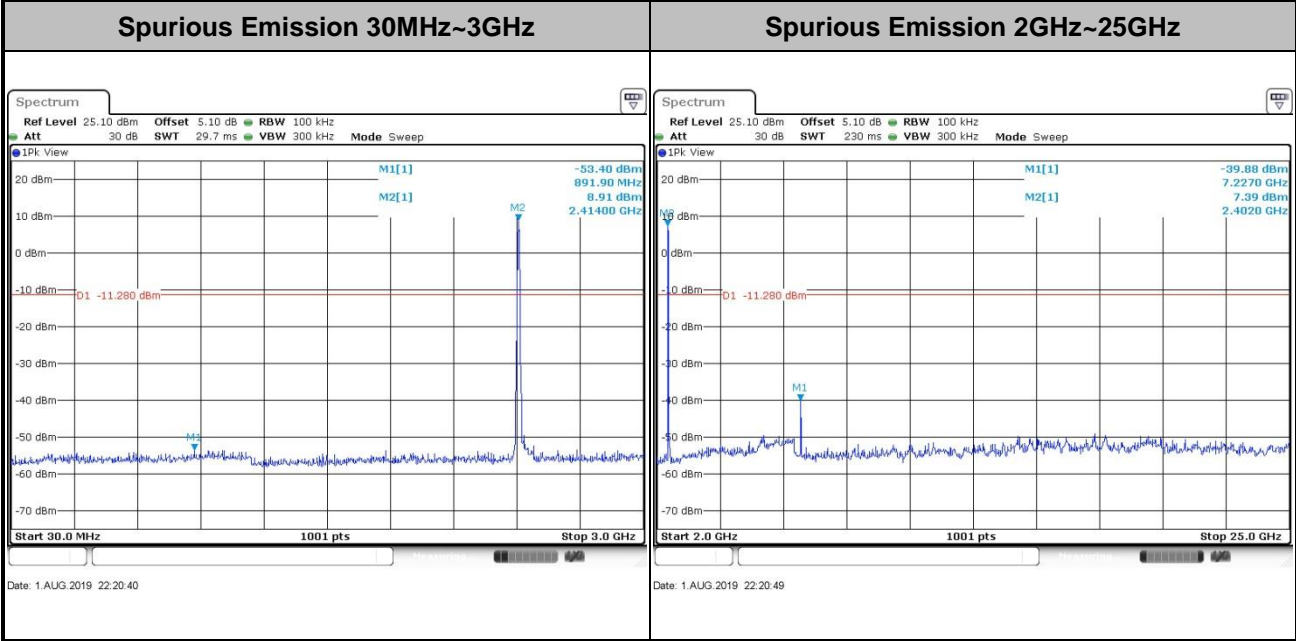
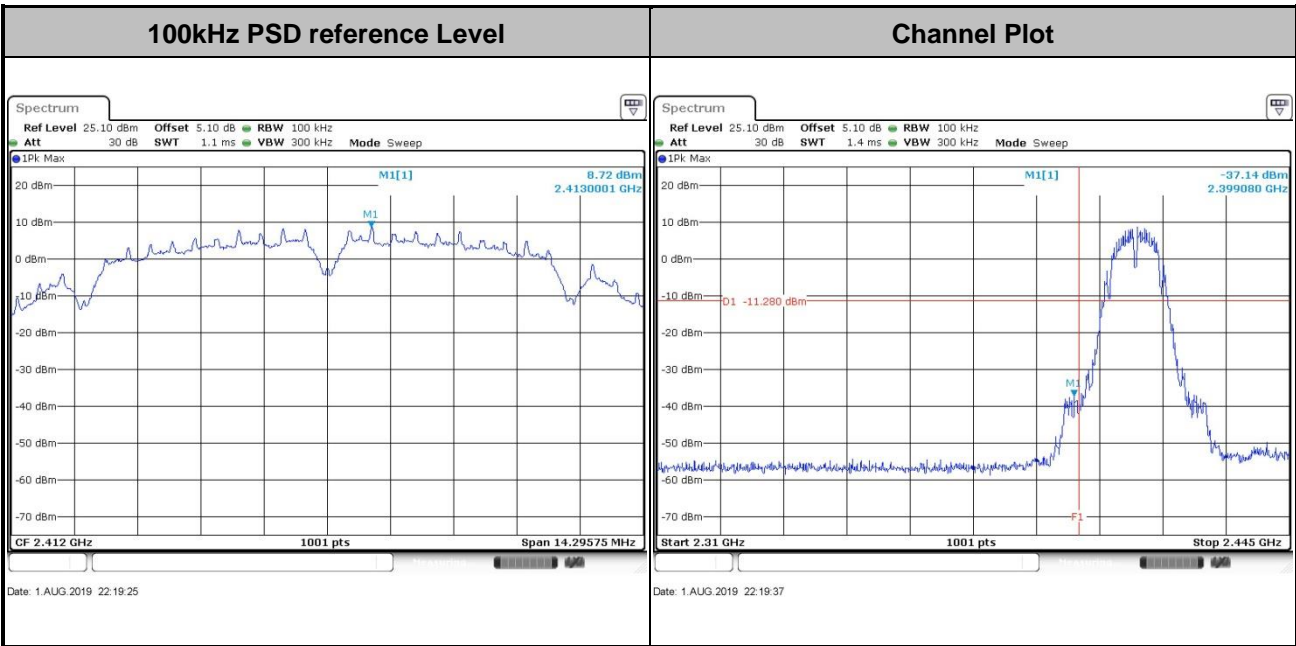



Test Mode :	802.11b	Test Channel :	06
-------------	---------	----------------	----

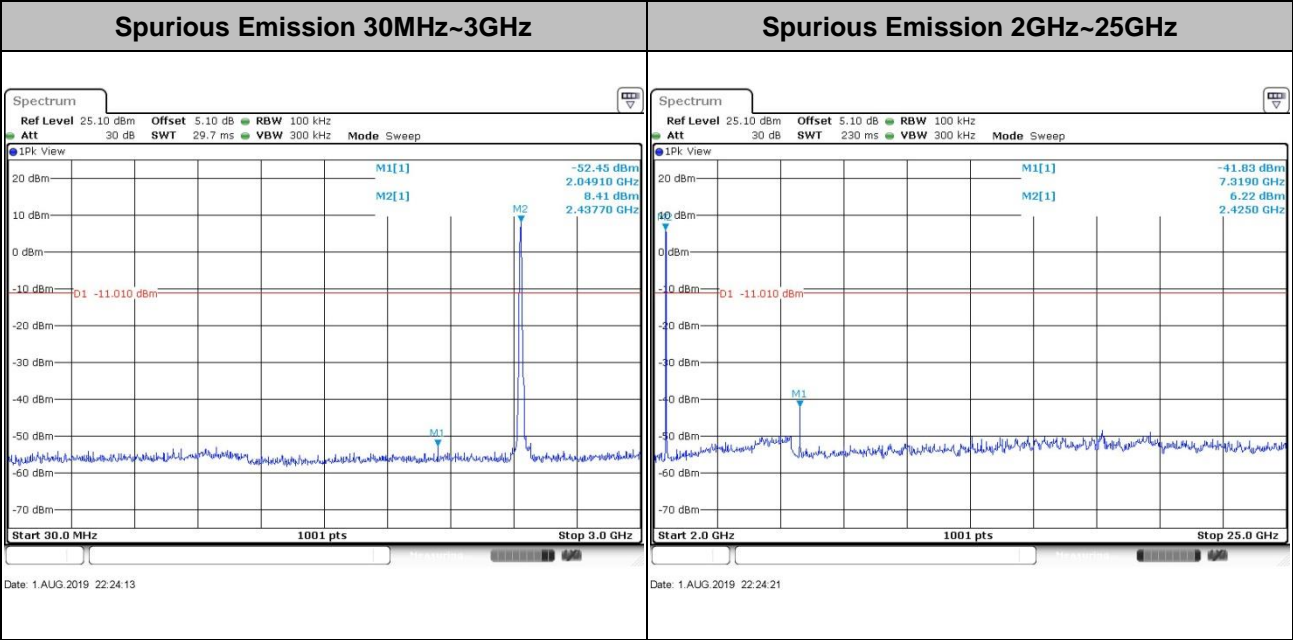
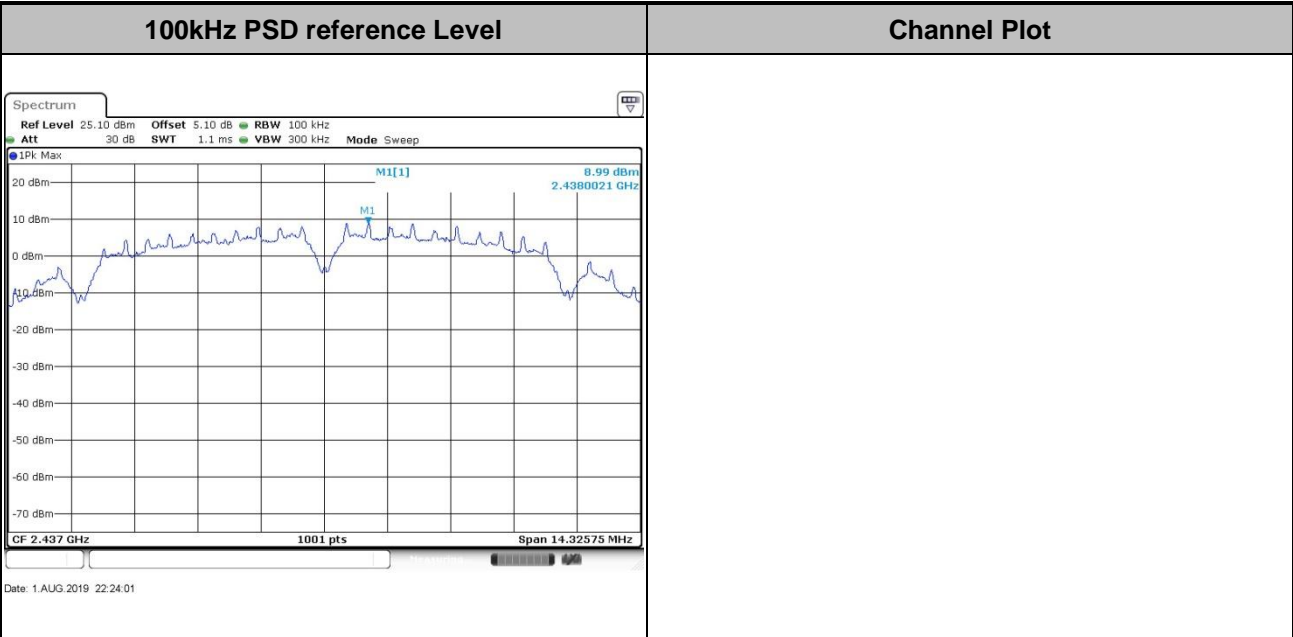



Test Mode :	802.11b	Test Channel :	11
-------------	---------	----------------	----

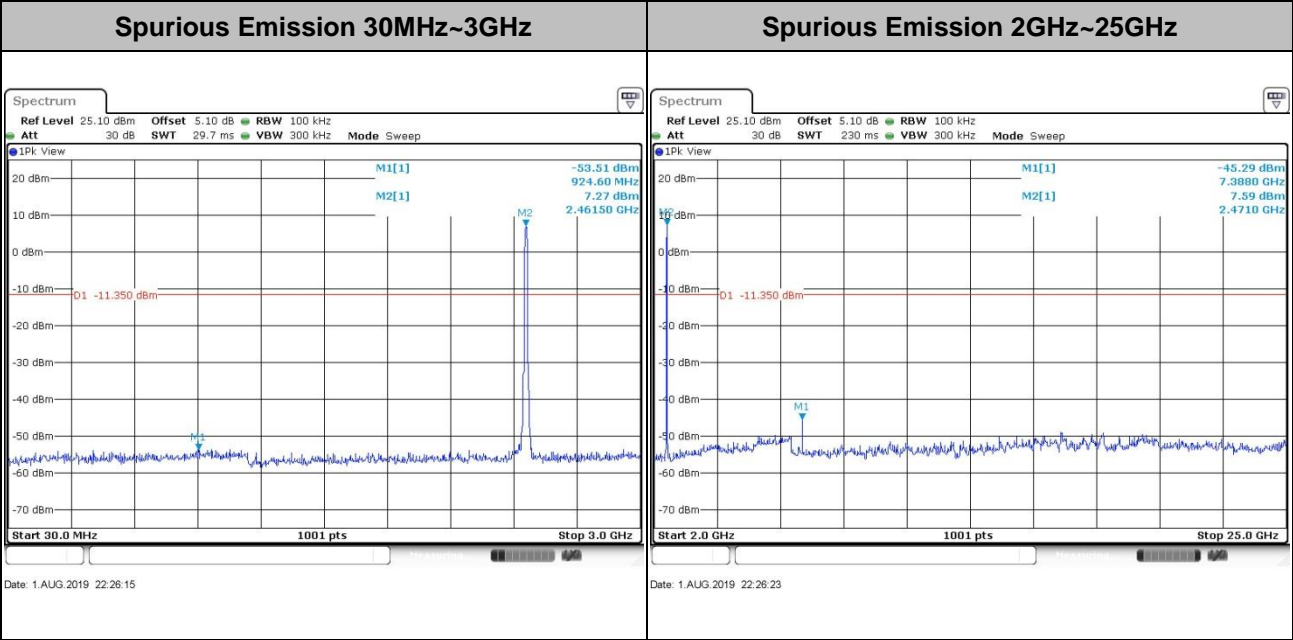
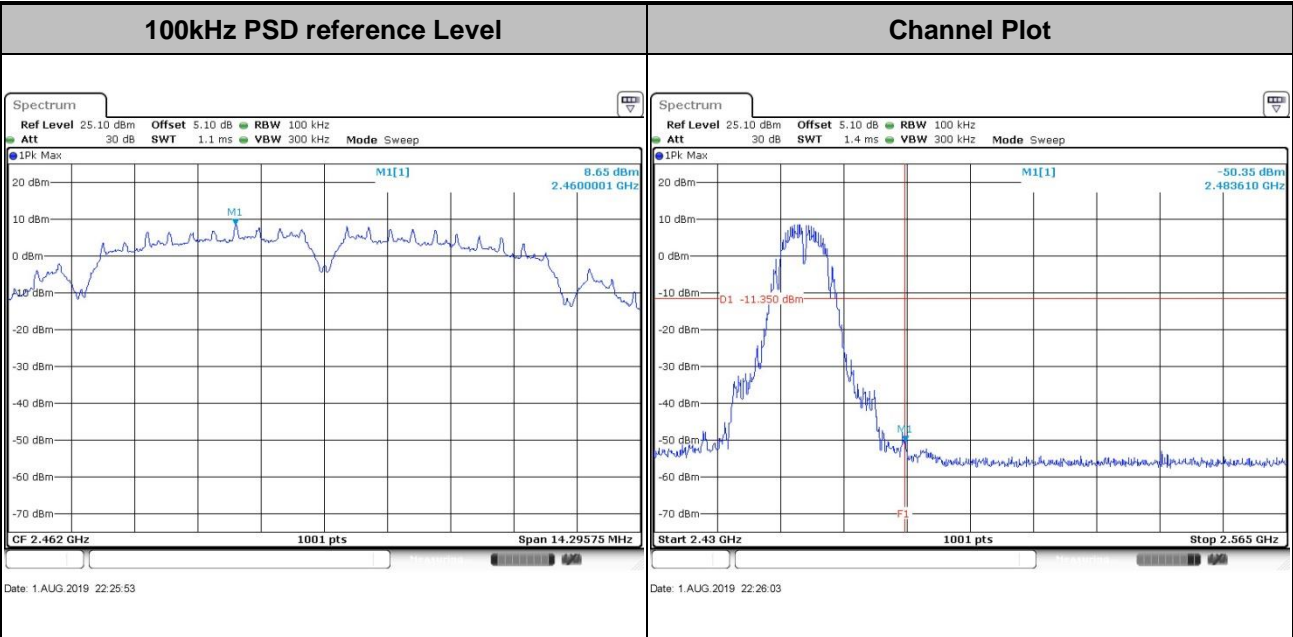



Test Mode : 802.11g Test Channel : 01

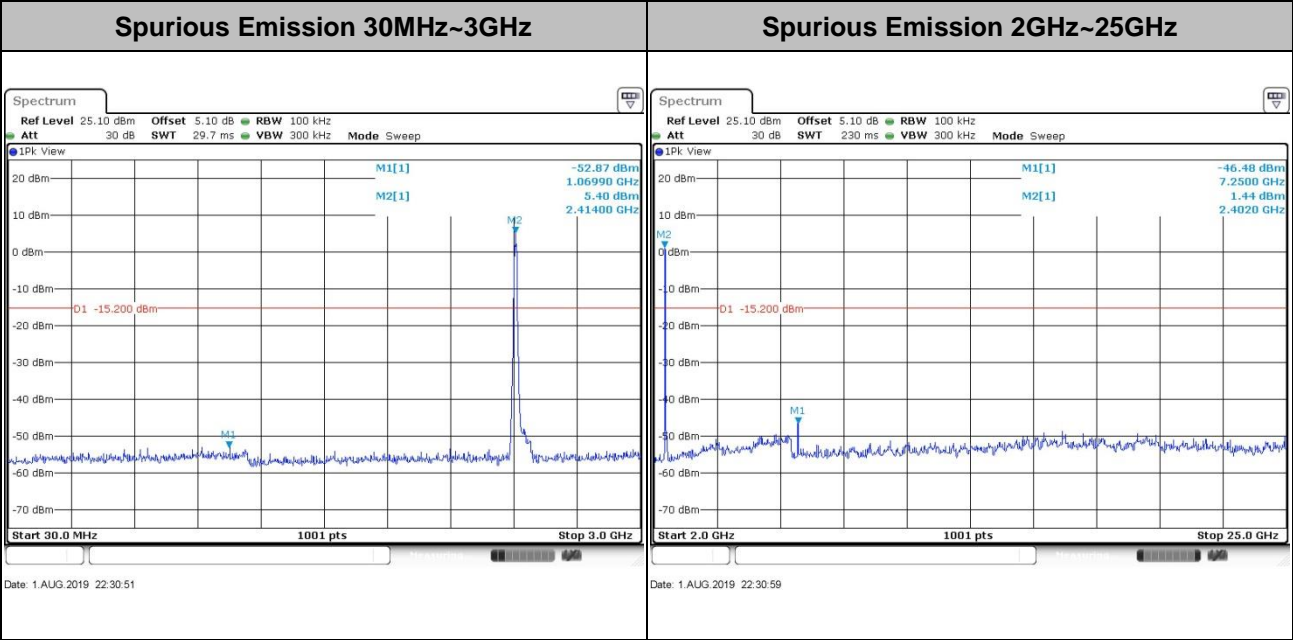
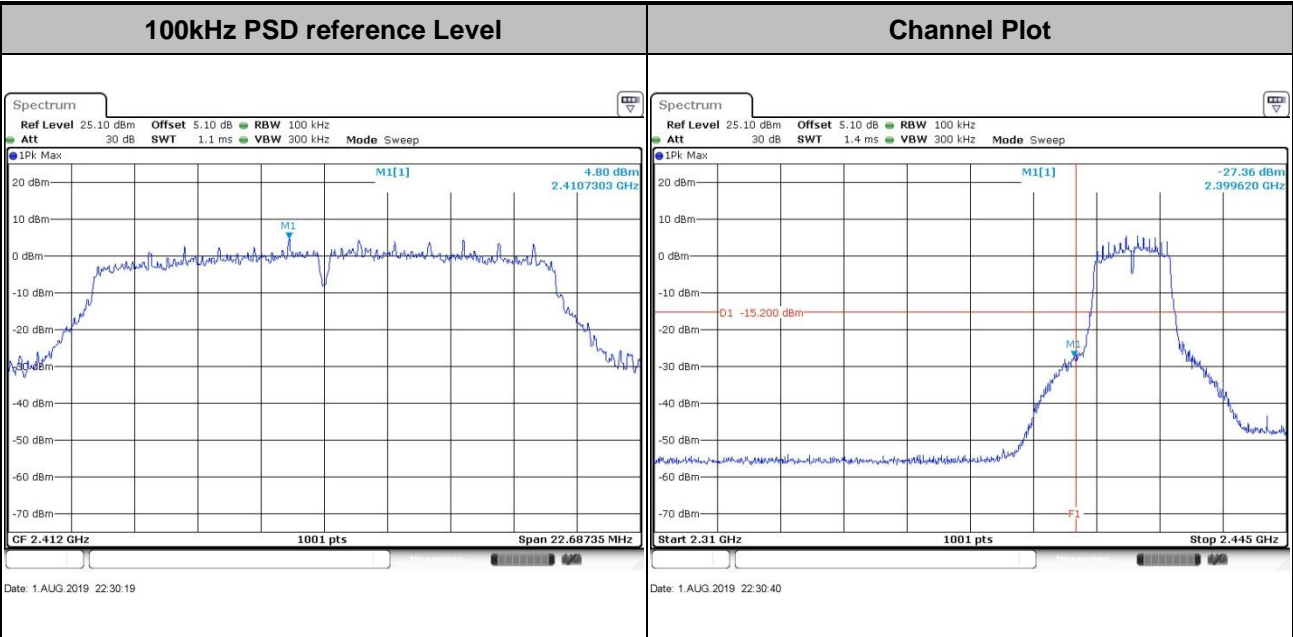



Test Mode :	802.11g	Test Channel :	06
-------------	---------	----------------	----

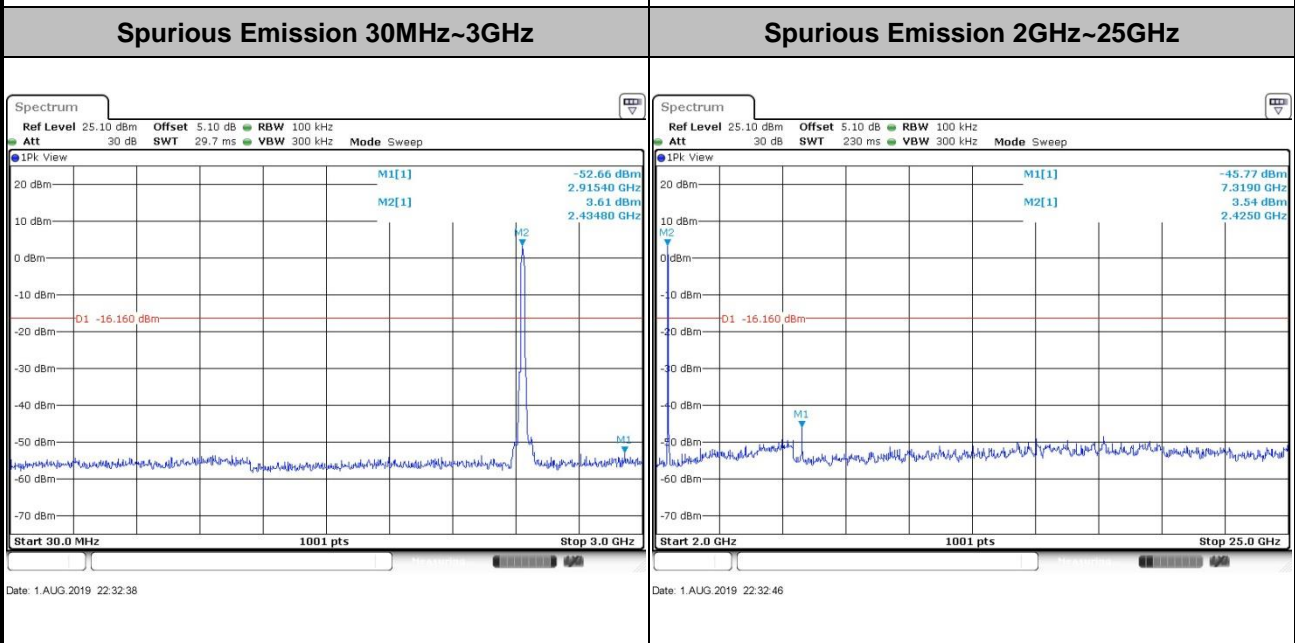
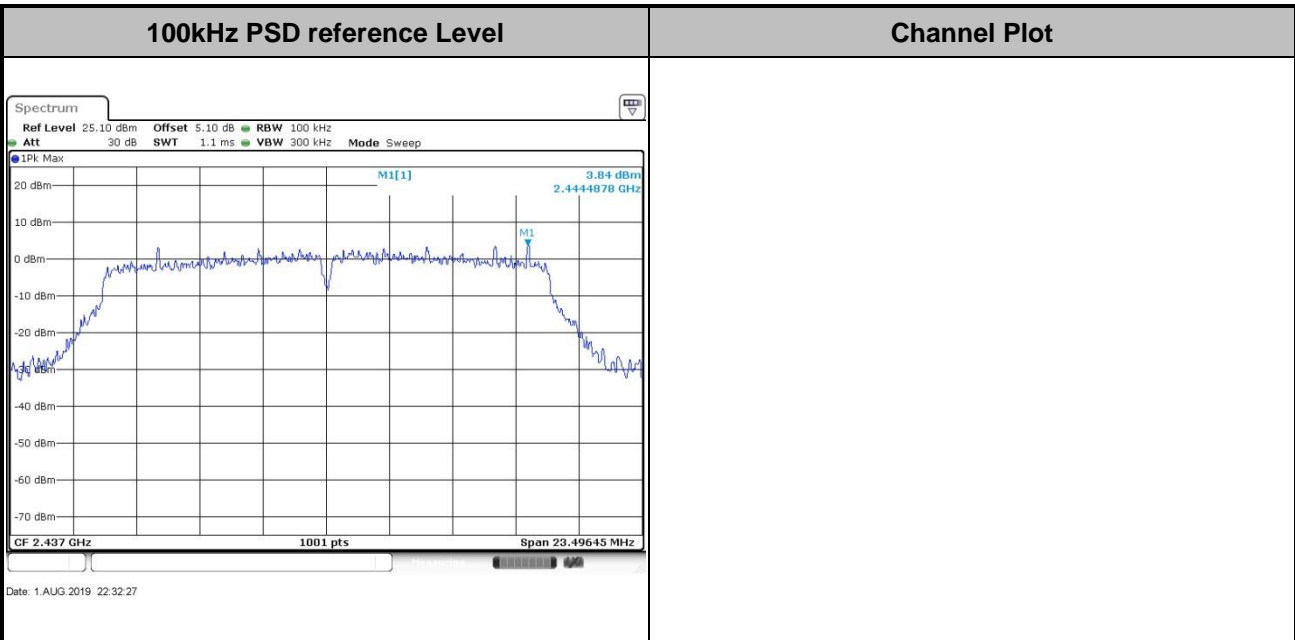



Test Mode :	802.11g	Test Channel :	11
-------------	---------	----------------	----

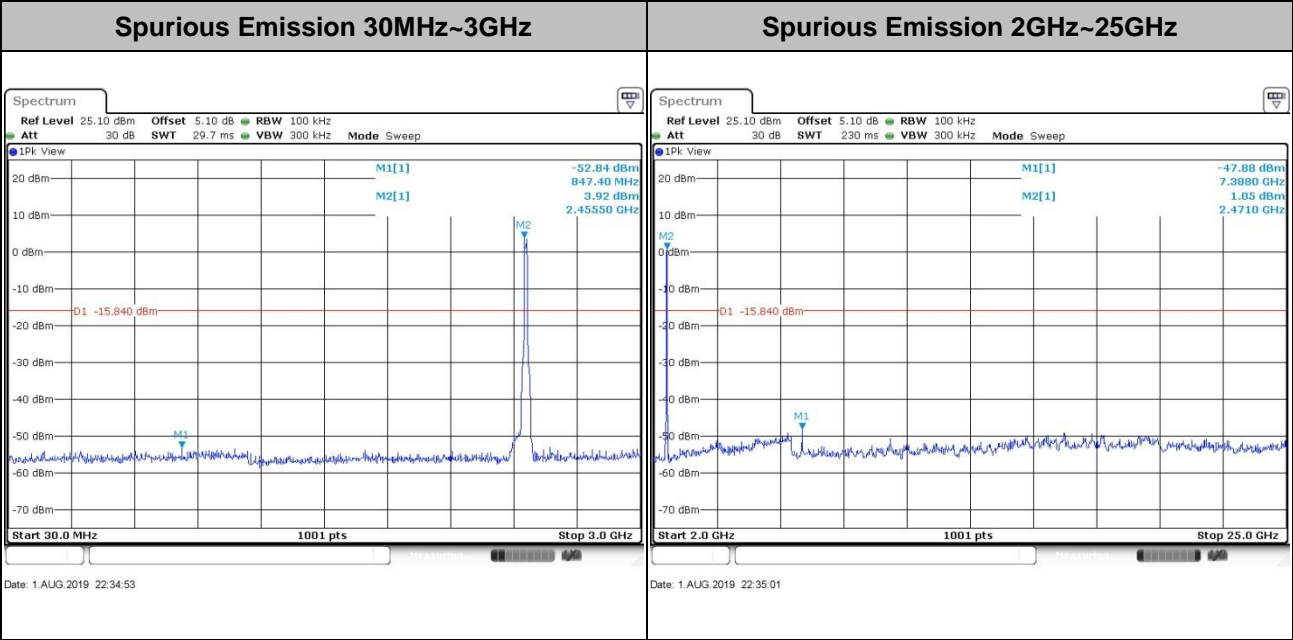
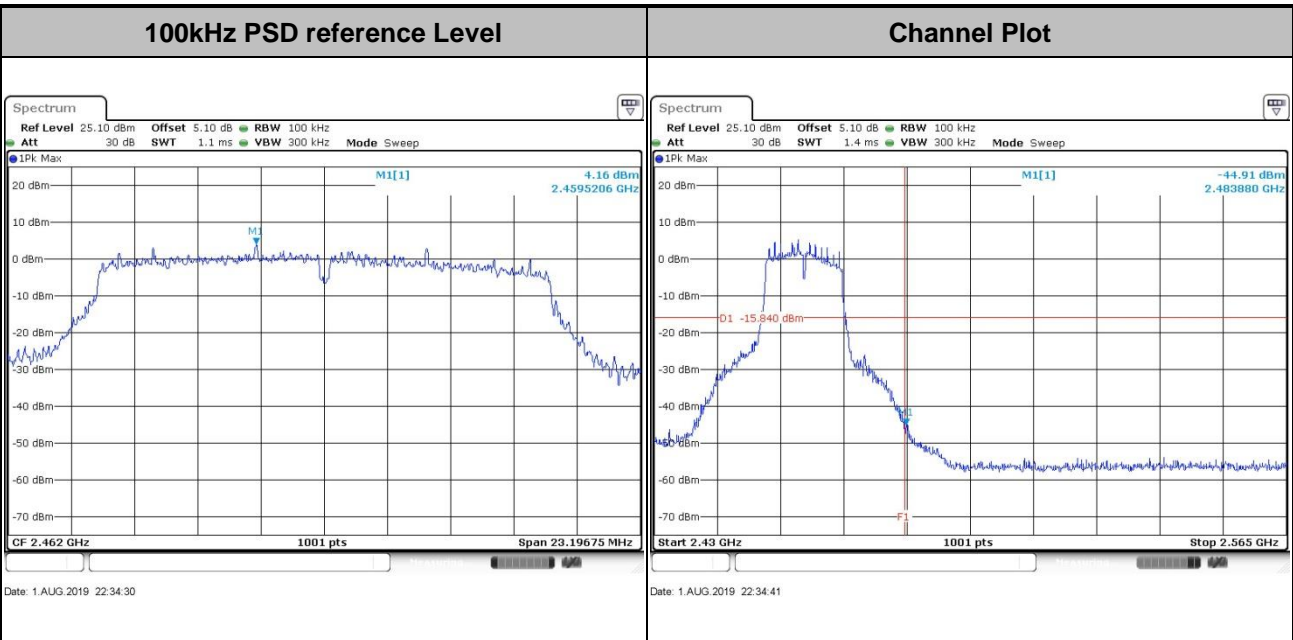



Test Mode : 802.11n HT20 Test Channel : 01

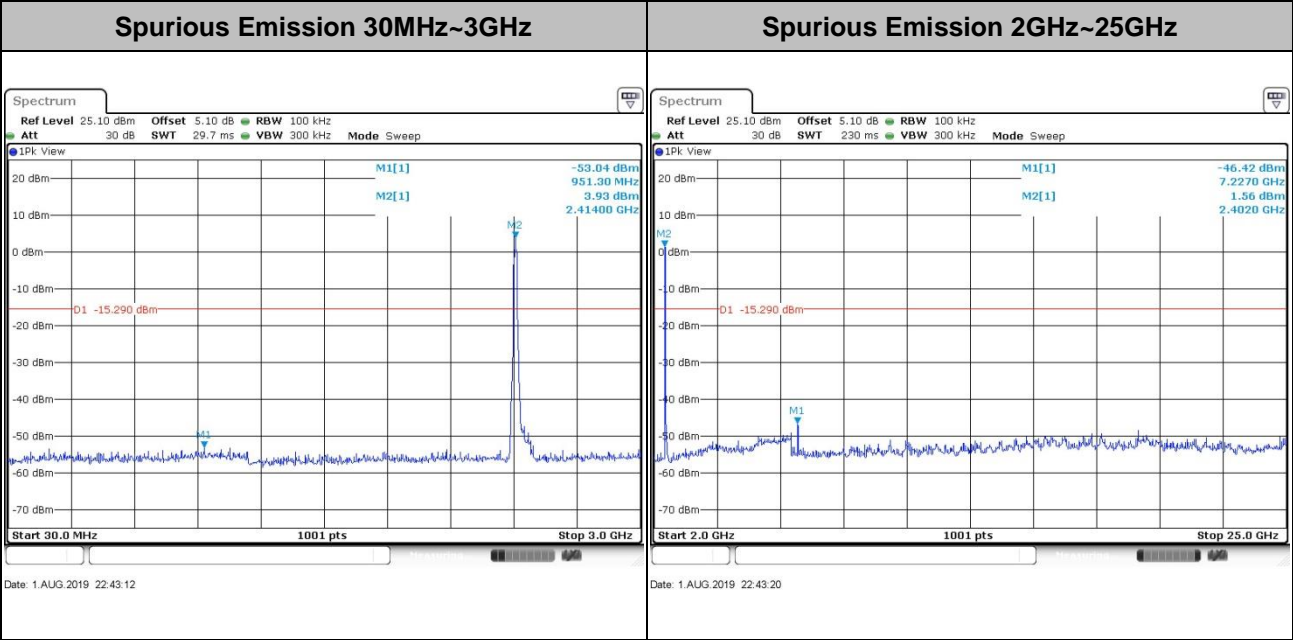
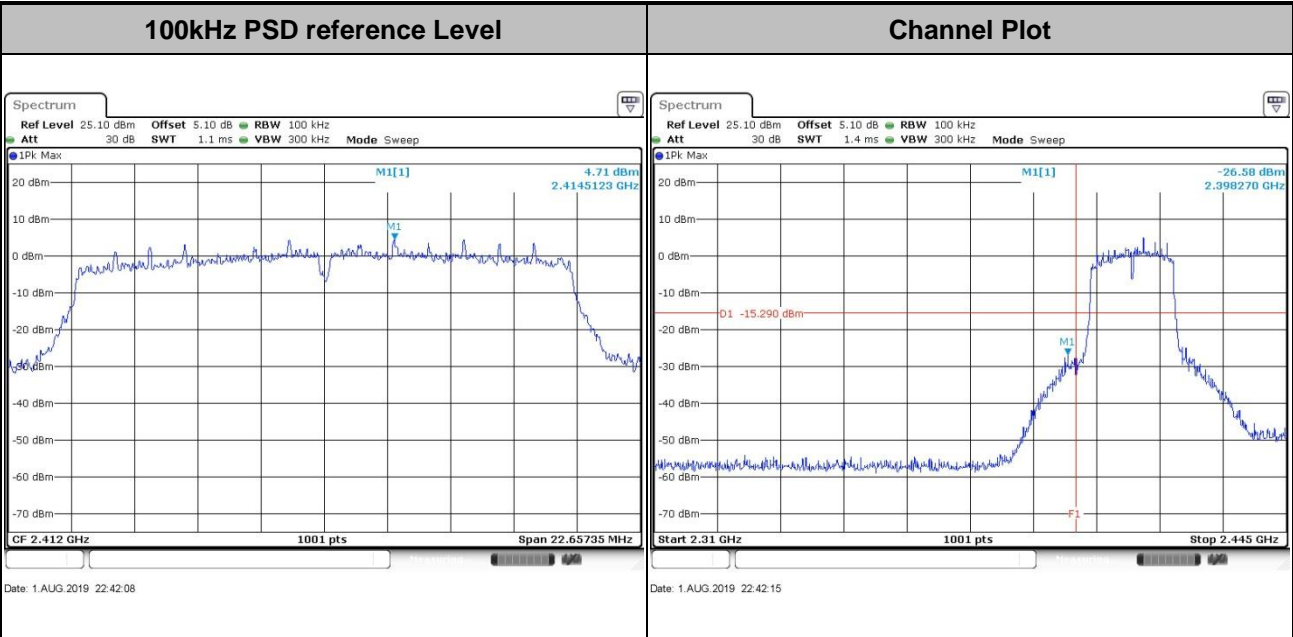





Test Mode :	802.11n HT20	Test Channel :	06
-------------	--------------	----------------	----

<b>100kHz PSD reference Level</b>	<b>Channel Plot</b>
-----------------------------------	---------------------

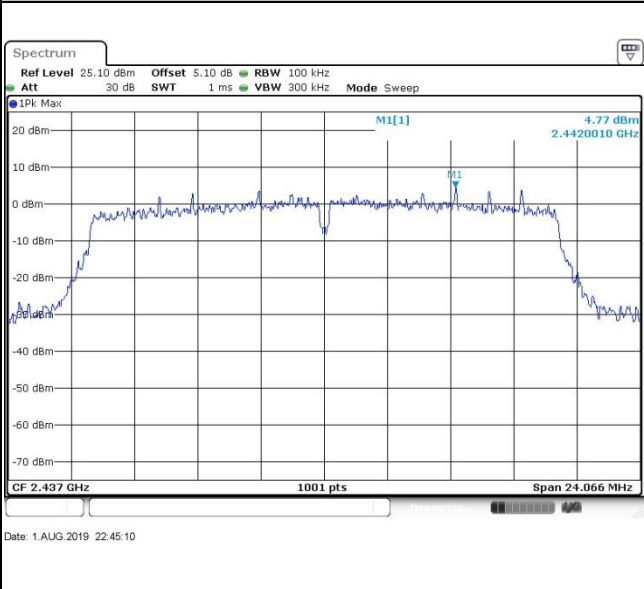

**Spurious Emission 30MHz~3GHz**

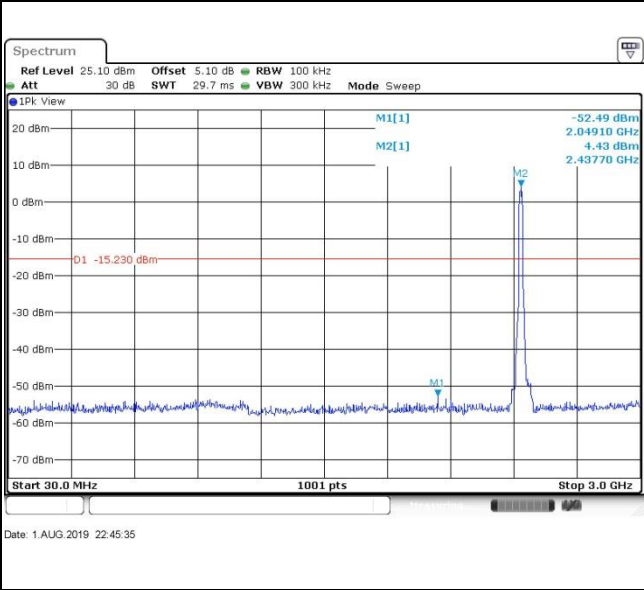

**Spurious Emission 2GHz~25GHz**

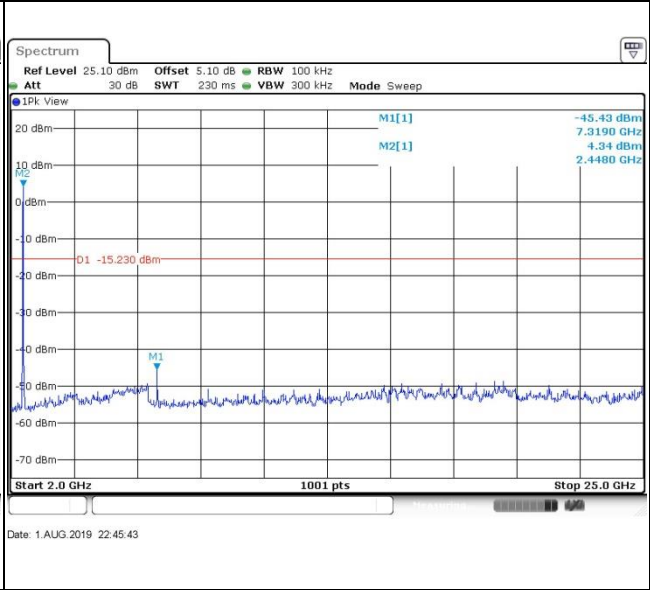



Test Mode :	802.11n HT20	Test Channel :	11
-------------	--------------	----------------	----

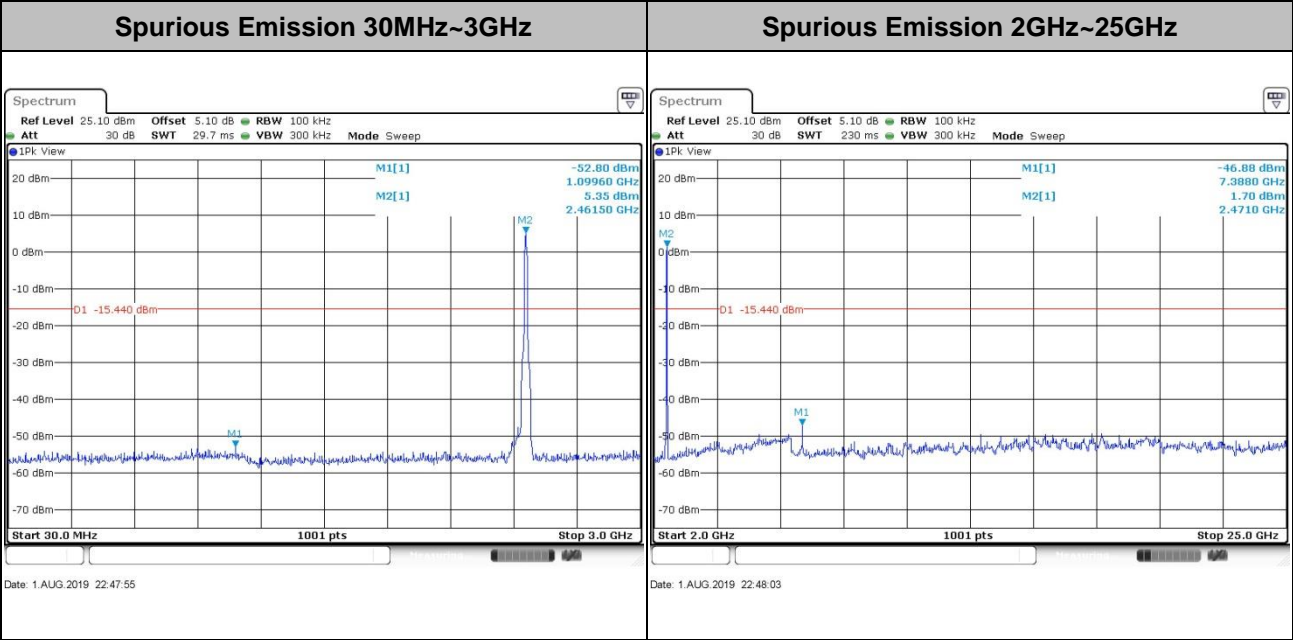
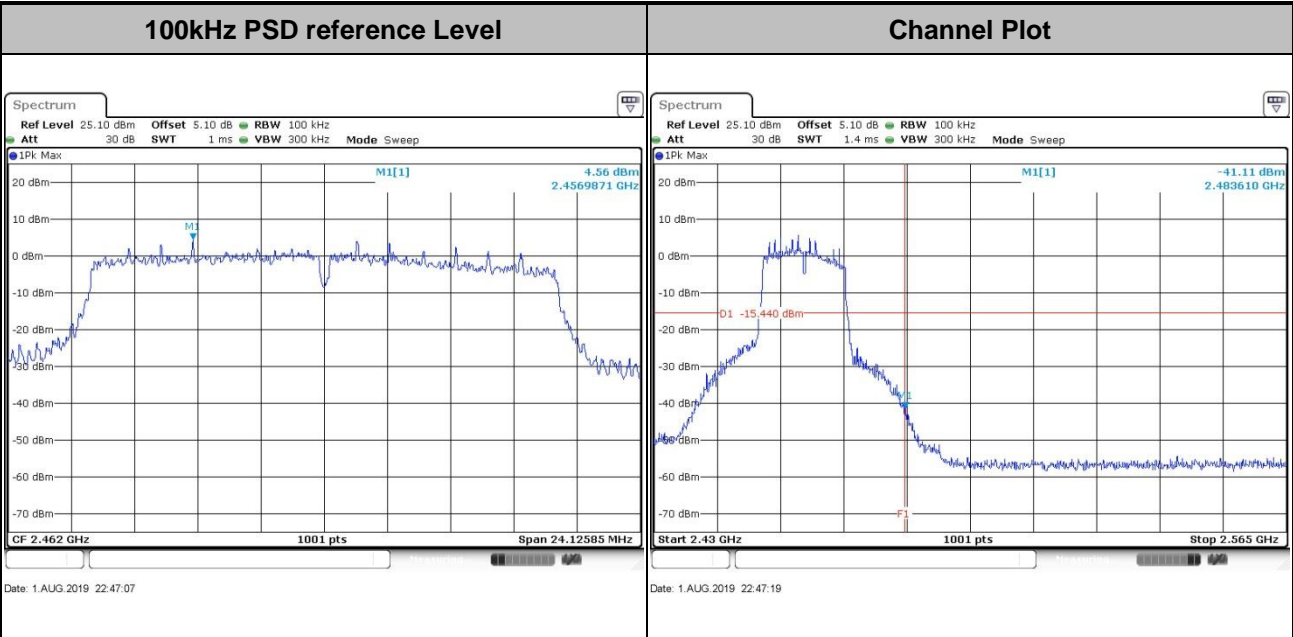



### 3.5 Radiated Band Edges and Spurious Emission Measurement

#### 3.5.1 Limit of Radiated band edge and Spurious Emission Measurement

In any 100 kHz bandwidth outside the intentional radiator frequency band, all harmonics/spurious must be at least 20 dB below the highest emission level within the authorized band. If the output power of this device was measured by spectrum analyzer, the attenuation under this paragraph shall be 30 dB instead of 20 dB. In addition, radiated emissions which fall in the restricted bands must also comply with the limits as below.

Frequency (MHz)	Field Strength (microvolts/meter)	Measurement Distance (meters)
0.009 – 0.490	2400/F(kHz)	300
0.490 – 1.705	24000/F(kHz)	30
1.705 – 30.0	30	30
30 – 88	100	3
88 – 216	150	3
216 - 960	200	3
Above 960	500	3

#### 3.5.2 Measuring Instruments

The measuring equipment is listed in the section 4 of this test report.



### 3.5.3 Test Procedures

1. The testing follows ANSI C63.10-2013 clause 11.11 & 11.12
2. The EUT was arranged to its worst case and then tune the antenna tower (from 1 m to 4 m) and turntable (from 0 degree to 360 degrees) to find the maximum reading. A pre-amp and a high pass filter are used for the test in order to get better signal level.
3. The EUT was placed on a turntable with 0.8 meter for frequency below 1GHz and 1.5 meter for frequency above 1GHz respectively above ground.
4. The EUT was set 3 meters from the interference receiving antenna, which was mounted on the top of a variable height antenna tower.
5. Corrected Reading: Antenna Factor + Cable Loss + Read Level - Preamp Factor = Level
6. For testing below 1GHz, if the emission level of the EUT in peak mode was 3 dB lower than the limit specified, then peak values of EUT will be reported, otherwise, the emissions will be repeated one by one using the CISPR quasi-peak method and reported.
7. For testing above 1GHz, the emission level of the EUT in peak mode was 20dB lower than average limit (that means the emission level in average mode also complies with the limit in average mode), then peak values of EUT will be reported, otherwise, the emissions will be measured in average mode again and reported.
8. Use the following spectrum analyzer settings:
  - (1) Span shall wide enough to fully capture the emission being measured;
  - (2) Set RBW=100 kHz for  $f < 1$  GHz; VBW  $\geq$  RBW; Sweep = auto; Detector function = peak; Trace = max hold;
  - (3) Set RBW = 1 MHz, VBW= 3MHz for  $f \geq 1$  GHz for peak measurement.  
For average measurement:
    - VBW = 10 Hz, when duty cycle is no less than 98 percent.
    - VBW  $\geq 1/T$ , when duty cycle is less than 98 percent where T is the minimum transmission duration over which the transmitter is on and is transmitting at its maximum power control level for the tested mode of operation.

### 3.5.4 Test Setup

For radiated emissions below 30MHz

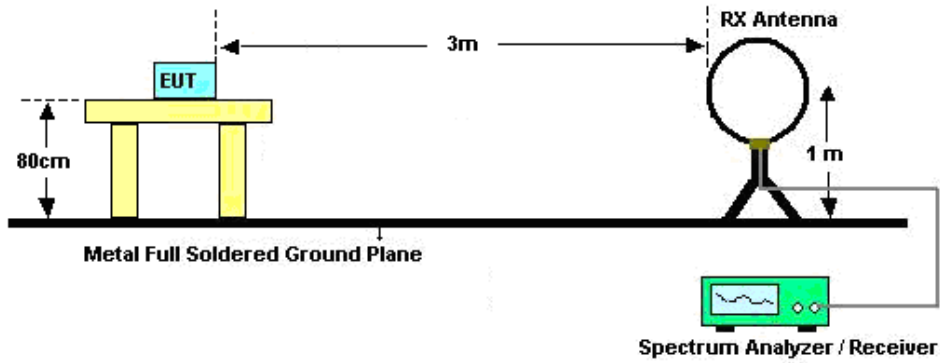

For radiated emissions from 30MHz to 1GHz

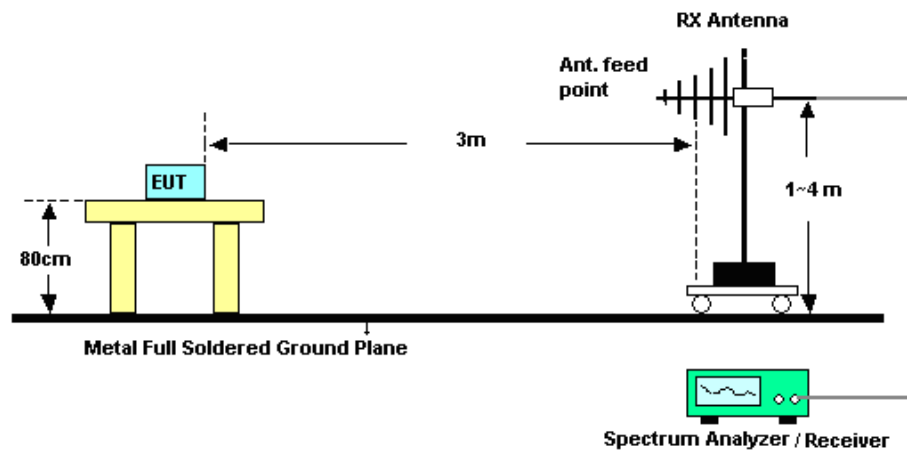

For radiated emissions above 1GHz

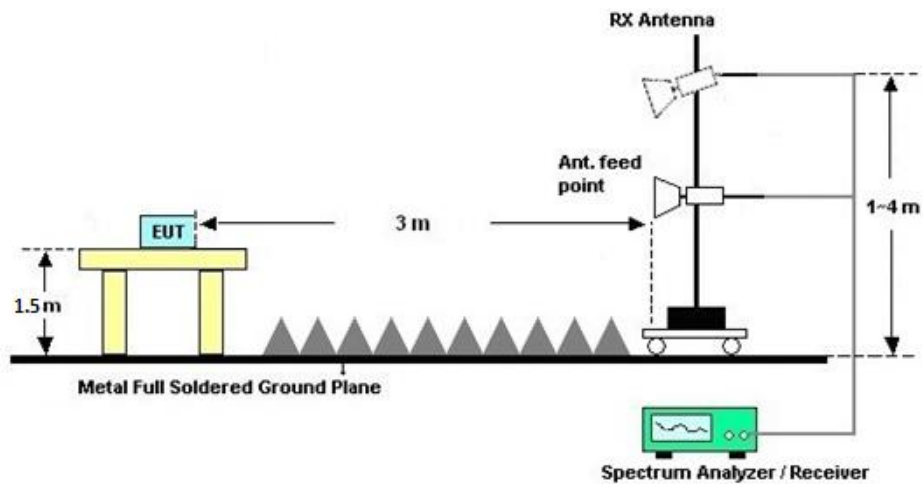



### **3.5.5 Test Results of Radiated Spurious Emissions (9kHz ~ 30MHz)**

The low frequency, which started from 9 kHz to 30MHz, was pre-scanned and the result which was 20dB lower than the limit line was not reported.

There is a comparison data of both open-field test site and semi-Anechoic chamber, and the result came out very similar.

### **3.5.6 Test Result of Radiated Spurious at Band Edges**

Please refer to Appendix C.

### **3.5.7 Duty Cycle**

Please refer to Appendix D.

### **3.5.8 Test Result of Radiated Spurious Emission (30MHz ~ 10<sup>th</sup> Harmonic)**

Please refer to Appendix C.



### 3.6 AC Conducted Emission Measurement

#### 3.6.1 Limit of AC Conducted Emission

For equipment that is designed to be connected to the public utility (AC) power line, the radio frequency voltage that is conducted back onto the AC power line on any frequency or frequencies within the band 150 kHz to 30 MHz shall not exceed the limits in the following table.

Frequency of Emission (MHz)	Conducted Limit (dBµV)	
	Quasi-Peak	Average
0.15-0.5	66 to 56*	56 to 46*
0.5-5	56	46
5-30	60	50

\*Decreases with the logarithm of the frequency.

#### 3.6.2 Measuring Instruments

The measuring equipment is listed in the section 4 of this test report.

#### 3.6.3 Test Procedures

1. The EUT was placed 0.4 meter from the conducting wall of the shielding room, and it was kept at least 80 centimeters from any other grounded conducting surface.
2. Connect EUT to the power mains through a line impedance stabilization network (LISN).
3. All the support units are connecting to the other LISN.
4. The LISN provides 50 ohm coupling impedance for the measuring instrument.
5. The FCC states that a 50 ohm, 50 microhenry LISN should be used.
6. Both sides of AC line were checked for maximum conducted interference.
7. The frequency range from 150 kHz to 30 MHz was searched.
8. Set the test-receiver system to Peak Detect Function and specified bandwidth (IF bandwidth = 9kHz) with Maximum Hold Mode.

### 3.6.4 Test Setup

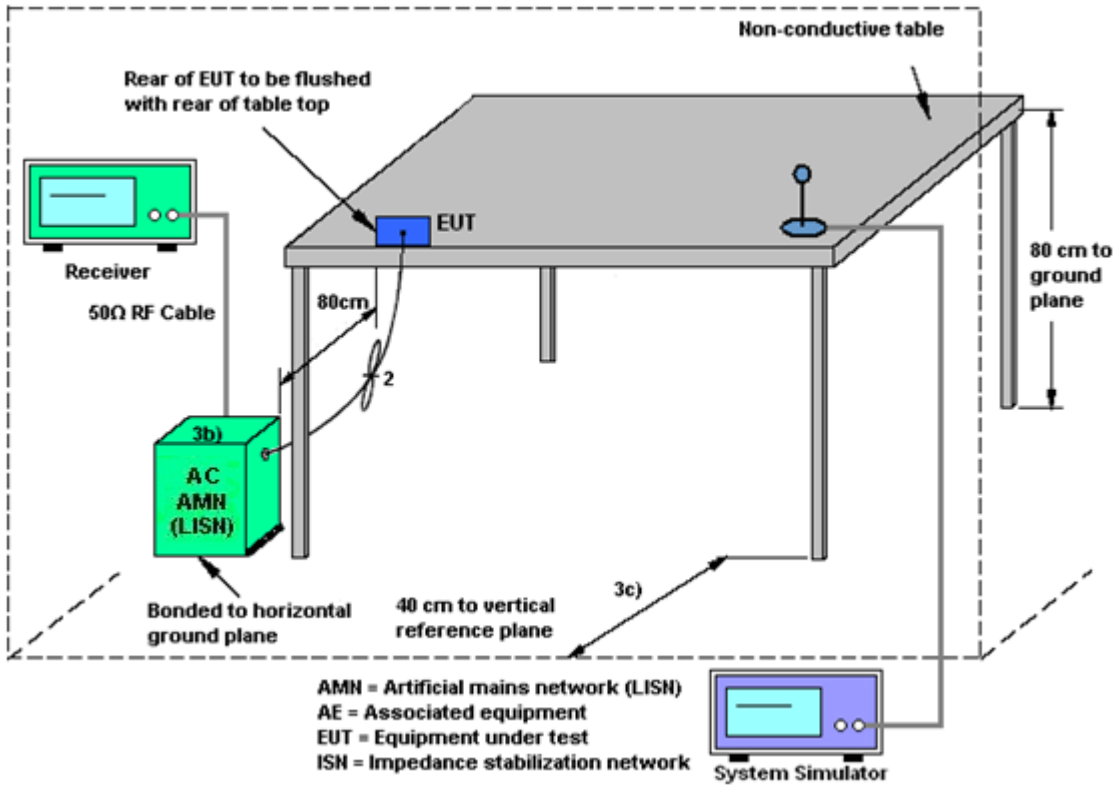

### 3.6.5 Test Result of AC Conducted Emission

Please refer to Appendix B.





## **3.7 Antenna Requirements**

### **3.7.1 Standard Applicable**

If directional gain of transmitting Antennas is greater than 6dBi, the power shall be reduced by the same level in dB comparing to gain minus 6dBi. The use of a permanently attached Antenna or of an Antenna that uses a unique coupling to the intentional radiator shall be considered sufficient to comply with the rule.

### **3.7.2 Antenna Anti-Replacement Construction**

An embedded-in antenna design is used.

### **3.7.3 Antenna Gain**

The antenna peak gain of EUT is less than 6 dBi. Therefore, it is not necessary to reduce maximum peak output power limit.



## 4 List of Measuring Equipment

Instrument	Manufacturer	Model No.	Serial No.	Characteristics	Calibration Date	Test Date	Due Date	Remark
Spectrum Analyzer	R&S	FSV30	101338	10Hz~30GHz	Apr. 16, 2019	Aug. 01, 2019	Apr. 15, 2020	Conducted (TH01-KS)
Pulse Power Sensor	Anritsu	MA2411B	0917070	300MHz~40GHz	Jan. 14, 2019	Aug. 01, 2019	Jan. 13, 2020	Conducted (TH01-KS)
Power Meter	Anritsu	ML2495A	1005002	50MHz Bandwidth	Jan. 14, 2019	Aug. 01, 2019	Jan. 13, 2020	Conducted (TH01-KS)
EMI Test Receiver	Keysight	N9038A	MY56400023	3Hz~8.5GHz; Max 30dBm	Oct. 12, 2018	Aug. 20, 2019	Oct. 11, 2019	Radiation (03CH05-KS)
EXA Spectrum Analyzer	Keysight	N9010A	MY55150208	10Hz~44GHz	Apr. 16, 2019	Aug. 20, 2019	Apr. 18, 2020	Radiation (03CH05-KS)
Loop Antenna	R&S	HFH2-Z2	100321	9kHz~30MHz	Oct. 19, 2018	Aug. 20, 2019	Oct. 18, 2019	Radiation (03CH05-KS)
Bilog Antenna	TeseQ	CBL6111D	44483	30MHz~1GHz	Dec. 28, 2018	Aug. 20, 2019	Dec. 27, 2019	Radiation (03CH05-KS)
Double Ridge Horn Antenna	ETS-Lindgren	3117	75957	1GHz~18GHz	Oct. 20, 2018	Aug. 20, 2019	Oct. 19, 2019	Radiation (03CH05-KS)
SHF-EHF Horn	Com-power	AH-840	101070	18GHz~40GHz	Jan. 05, 2019	Aug. 20, 2019	Jan. 04, 2020	Radiation (03CH05-KS)
Amplifier	SONOMA	310N	187289	9KHz ~1GHZ	Aug. 06, 2019	Aug. 20, 2019	Aug. 05, 2020	Radiation (03CH05-KS)
Amplifier	MITEQ	TTA1840-35-HG	2014749	18~40GHz	Jan. 14, 2019	Aug. 20, 2019	Jan. 13, 2020	Radiation (03CH05-KS)
high gain Amplifier	MITEQ	AMF-7D-0010 1800-30-10P	2025788	1Ghz-18Ghz	Apr. 17, 2019	Aug. 20, 2019	Apr. 16, 2020	Radiation (03CH05-KS)
Amplifier	Keysight	83017A	MY53270203	500MHz~26.5GHz	Apr. 15, 2019	Aug. 20, 2019	Apr. 14, 2020	Radiation (03CH05-KS)
AC Power Source	Chroma	61601	F104090004	N/A	NCR	Aug. 20, 2019	NCR	Radiation (03CH05-KS)
Turn Table	ChamPro	EM 1000-T	060762-T	0~360 degree	NCR	Aug. 20, 2019	NCR	Radiation (03CH05-KS)
Antenna Mast	ChamPro	EM 1000-A	060762-A	1 m~4 m	NCR	Aug. 20, 2019	NCR	Radiation (03CH05-KS)
EMI Receiver	R&S	ESCI7	100768	9kHz~7GHz;	Apr. 16, 2019	Aug. 16, 2019	Apr. 15, 2020	Conduction (CO01-KS)
AC LISN	MessTec	AN3016	060103	9kHz~30MHz	Oct. 12, 2018	Aug. 16, 2019	Oct. 11, 2019	Conduction (CO01-KS)
AC LISN (for auxiliary equipment)	MessTec	AN3016	060105	9kHz~30MHz	Nov. 19, 2018	Aug. 16, 2019	Nov. 18, 2019	Conduction (CO01-KS)
AC Power Source	Chroma	61602	ABP00000811	AC 0V~300V, 45Hz~1000Hz	Oct. 12, 2018	Aug. 16, 2019	Oct. 11, 2019	Conduction (CO01-KS)

NCR: No Calibration Required



## 5 Uncertainty of Evaluation

The measurement uncertainties shown below were calculated in accordance with the requirements of ANSI 63.10-2013. All the measurement uncertainty value were shown with a coverage K=2 to indicate 95% level of confidence. The measurement data show herein meets or exceeds the CISPR measurement uncertainty values specified in CISPR 16-4-2 and can be compared directly to specified limit to determine compliance.

### Uncertainty of Conducted Emission Measurement (150 kHz ~ 30 MHz)

Measuring Uncertainty for a Level of Confidence of 95% (U = 2Uc(y))	2.9dB
---	-------

### Uncertainty of Radiated Emission Measurement (30 MHz ~ 1000 MHz)

Measuring Uncertainty for a Level of Confidence of 95% (U = 2Uc(y))	5.0dB
---	-------

### Uncertainty of Radiated Emission Measurement (1000 MHz ~ 18000 MHz)

Measuring Uncertainty for a Level of Confidence of 95% (U = 2Uc(y))	5.0dB
---	-------

### Uncertainty of Radiated Emission Measurement (18000 MHz ~ 40000 MHz)

Measuring Uncertainty for a Level of Confidence of 95% (U = 2Uc(y))	5.0dB
---	-------



## Appendix A. Conducted Test Results

**A1 - DTS Part**

Test Engineer:	Aly Cao	Temperature:	21~25	°C
Test Date:	2019/8/1	Relative Humidity:	51~54	%

**TEST RESULTS DATA**  
**6dB and 99% Occupied Bandwidth**

2.4GHz Band								
Mod.	Data Rate	N <sub>TX</sub>	CH.	Freq. (MHz)	99% Occupied BW (MHz)	6dB BW (MHz)	6dB BW Limit (MHz)	Pass/Fail
11b	1Mbps	1	1	2412	12.59	9.53	0.50	Pass
11b	1Mbps	1	6	2437	12.79	9.55	0.50	Pass
11b	1Mbps	1	11	2462	12.79	9.53	0.50	Pass
11g	6Mbps	1	1	2412	17.43	15.12	0.50	Pass
11g	6Mbps	1	6	2437	17.68	15.66	0.50	Pass
11g	6Mbps	1	11	2462	17.73	15.46	0.50	Pass
HT20	MCS0	1	1	2412	18.18	15.10	0.50	Pass
HT20	MCS0	1	6	2437	18.18	16.04	0.50	Pass
HT20	MCS0	1	11	2462	18.33	16.08	0.50	Pass

**TEST RESULTS DATA**  
**Peak Power Table**

2.4GHz Band										
Mod.	Data Rate	NTX	CH.	Freq. (MHz)	Peak Conducted Power (dBm)	Conducted Power Limit (dBm)	DG (dBi)	EIRP Power (dBm)	EIRP Power Limit (dBm)	Pass /Fail
11b	1Mbps	1	1	2412	20.43	30.00	-1.45	18.98	36.00	Pass
11b	1Mbps	1	6	2437	20.79	30.00	-1.45	19.34	36.00	Pass
11b	1Mbps	1	11	2462	20.38	30.00	-1.45	18.93	36.00	Pass
11g	6Mbps	1	1	2412	24.09	30.00	-1.45	22.64	36.00	Pass
11g	6Mbps	1	6	2437	24.27	30.00	-1.45	22.82	36.00	Pass
11g	6Mbps	1	11	2462	23.63	30.00	-1.45	22.18	36.00	Pass
HT20	MCS0	1	1	2412	24.23	30.00	-1.45	22.78	36.00	Pass
HT20	MCS0	1	6	2437	24.12	30.00	-1.45	22.67	36.00	Pass
HT20	MCS0	1	11	2462	23.51	30.00	-1.45	22.06	36.00	Pass

**TEST RESULTS DATA**  
**Average Power Table**  
**(Reporting Only)**

2.4GHz Band						
Mod.	Data Rate	N <sub>TX</sub>	CH.	Freq. (MHz)	Duty Factor (dB)	Average Conducted Power (dBm)
11b	1Mbps	1	1	2412	0.00	17.42
11b	1Mbps	1	6	2437	0.00	17.85
11b	1Mbps	1	11	2462	0.00	17.50
11g	6Mbps	1	1	2412	0.11	16.06
11g	6Mbps	1	6	2437	0.11	16.11
11g	6Mbps	1	11	2462	0.11	15.84
HT20	MCS0	1	1	2412	0.12	16.05
HT20	MCS0	1	6	2437	0.12	16.14
HT20	MCS0	1	11	2462	0.12	15.93



**TEST RESULTS DATA**  
**Peak Power Density**

2.4GHz Band								
Mod.	Data Rate	N <sub>TX</sub>	CH.	Freq. (MHz)	Peak PSD (dBm /3kHz)	DG (dBi)	Peak PSD Limit (dBm /3kHz)	Pass/Fail
11b	1Mbps	1	1	2412	-5.17	-1.45	8.00	Pass
11b	1Mbps	1	6	2437	-5.27	-1.45	8.00	Pass
11b	1Mbps	1	11	2462	-4.63	-1.45	8.00	Pass
11g	6Mbps	1	1	2412	-8.70	-1.45	8.00	Pass
11g	6Mbps	1	6	2437	-9.42	-1.45	8.00	Pass
11g	6Mbps	1	11	2462	-9.12	-1.45	8.00	Pass
HT20	MCS0	1	1	2412	-9.27	-1.45	8.00	Pass
HT20	MCS0	1	6	2437	-10.29	-1.45	8.00	Pass
HT20	MCS0	1	11	2462	-9.17	-1.45	8.00	Pass



## Appendix B. AC Conducted Emission Test Results

Test Engineer :	Amos Zhang	Temperature :	25.3~26.2°C
		Relative Humidity :	38~40%
Test Voltage :	120Vac / 60Hz	Phase :	Line

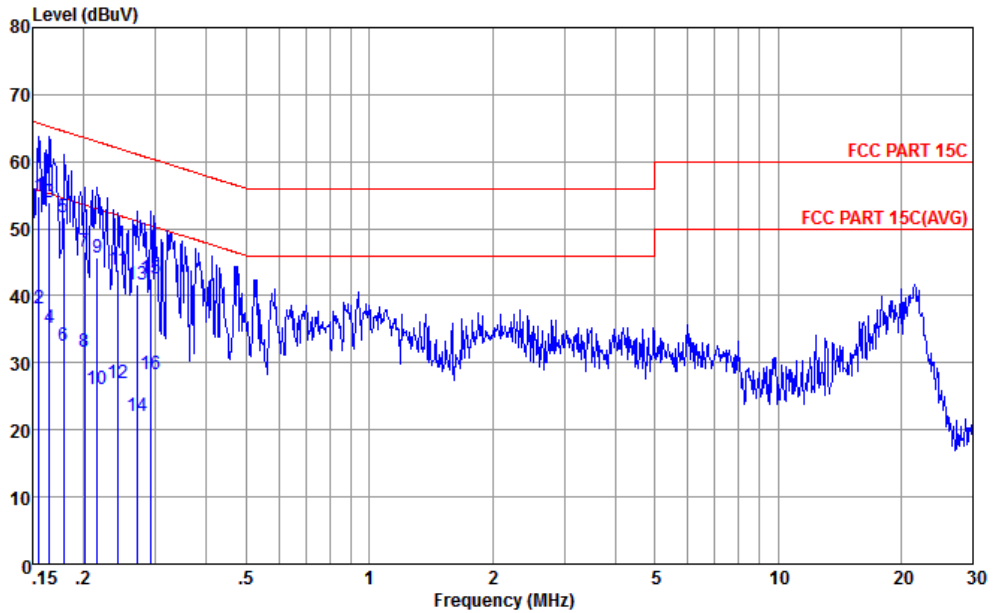

Site : CO01-KS  
 Condition : FCC PART 15C LISN-L-181119-060105 LINE  
 mode : Mode 1

	Freq	Level	Over	Limit	Read	LISN	Cable	Remark
	MHz	dBuV	Limit	Line	Level	Factor	Loss	
			dB	dBuV	dBuV	dB	dB	
1 *	0.156	54.76	-10.93	65.69	44.20	0.09	10.47	QP
2	0.156	38.16	-17.53	55.69	27.60	0.09	10.47	Average
3	0.165	53.84	-11.37	65.21	43.30	0.10	10.44	QP
4	0.165	35.14	-20.07	55.21	24.60	0.10	10.44	Average
5	0.179	51.62	-12.93	64.55	41.10	0.11	10.41	QP
6	0.179	32.62	-21.93	54.55	22.10	0.11	10.41	Average
7	0.201	46.68	-16.90	63.58	36.20	0.12	10.36	QP
8	0.201	31.68	-21.90	53.58	21.20	0.12	10.36	Average
9	0.216	45.58	-17.38	62.96	35.11	0.12	10.35	QP
10	0.216	25.98	-26.98	52.96	15.51	0.12	10.35	Average
11	0.243	43.97	-18.03	62.00	33.50	0.13	10.34	QP
12	0.243	27.07	-24.93	52.00	16.60	0.13	10.34	Average
13	0.270	41.66	-19.46	61.12	31.20	0.14	10.32	QP
14	0.270	22.06	-29.06	51.12	11.60	0.14	10.32	Average
15	0.291	42.65	-17.85	60.50	32.20	0.14	10.31	QP
16	0.291	28.35	-22.15	50.50	17.90	0.14	10.31	Average



Test Engineer :	Amos Zhang	Temperature :	25.3~26.2°C
		Relative Humidity :	38~40%
Test Voltage :	120Vac / 60Hz	Phase :	Neutral

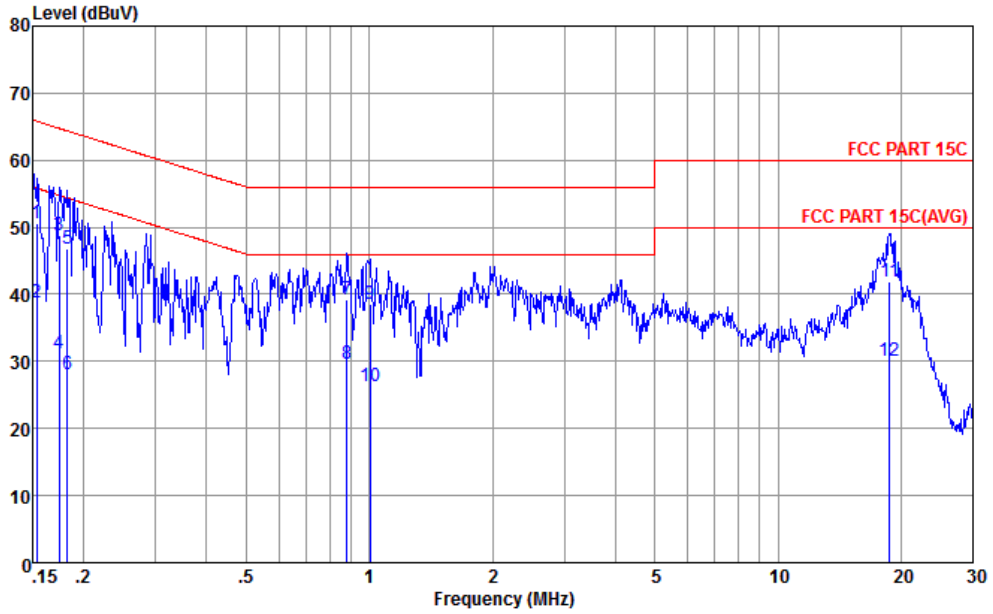

Site : CO01-KS  
 Condition : FCC PART 15C LISN-N-181119-060105 NEUTRAL  
 mode : Mode 1

	Freq	Level	Over	Limit	Read	LISN	Cable	Remark
	MHz	dBuV	Limit	Line	Level	Factor	Loss	
			dB	dBuV	dBuV	dB	dB	
1 *	0.153	50.55	-15.27	65.82	39.90	0.18	10.47	QP
2	0.153	38.85	-16.97	55.82	28.20	0.18	10.47	Average
3	0.174	48.80	-15.97	64.77	38.20	0.18	10.42	QP
4	0.174	31.10	-23.67	54.77	20.50	0.18	10.42	Average
5	0.182	46.78	-17.59	64.37	36.21	0.17	10.40	QP
6	0.182	28.18	-26.19	54.37	17.61	0.17	10.40	Average
7	0.880	39.27	-16.73	56.00	28.90	0.13	10.24	QP
8	0.880	29.67	-16.33	46.00	19.30	0.13	10.24	Average
9	1.005	38.56	-17.44	56.00	28.20	0.13	10.23	QP
10	1.005	26.26	-19.74	46.00	15.90	0.13	10.23	Average
11	18.721	41.78	-18.22	60.00	31.20	0.11	10.47	QP
12	18.721	30.18	-19.82	50.00	19.60	0.11	10.47	Average



## Appendix C. Radiated Spurious Emission

2.4GHz 2400~2483.5MHz

WIFI 802.11b (Band Edge @ 3m)

WIFI Ant.	Note	Frequency	Level	Over Limit	Limit Line	Read Level	Antenna Factor	Cable Loss	Preamp Factor	Ant Pos	Table Pos	Peak Avg.	Pol.
1		( MHz )	( dBμV/m )	( dB )	( dBμV/m )	( dBμV )	( dB/m )	( dB )	( dB )	( cm )	( deg )	(P/A)	(H/V)
802.11b CH 01 2412MHz		2380.07	51.88	-22.12	74	47.74	31.25	5.43	32.54	333	291	P	H
		2389.95	40.72	-13.28	54	36.48	31.3	5.48	32.54	333	291	A	H
	*	2414	98.6	-	-	94.29	31.36	5.48	32.53	333	291	P	H
	*	2414	94.01	-	-	89.7	31.36	5.48	32.53	333	291	A	H
		2359.27	51.9	-22.1	74	47.81	31.21	5.43	32.55	347	44	P	V
		2389.69	40.71	-13.29	54	36.47	31.3	5.48	32.54	347	44	A	V
	*	2414	100.68	-	-	96.37	31.36	5.48	32.53	347	44	P	V
	*	2414	97.36	-	-	93.05	31.36	5.48	32.53	347	44	A	V
802.11b CH 11 2462MHz	*	2462	104.89	-	-	100.22	31.53	5.51	32.37	158	343	P	H
	*	2462	101.45	-	-	96.78	31.53	5.51	32.37	158	343	A	H
		2486.56	52.77	-21.23	74	47.94	31.59	5.55	32.31	158	343	P	H
		2483.5	41.98	-12.02	54	37.15	31.59	5.55	32.31	158	343	A	H
	*	2462	104.01	-	-	99.34	31.53	5.51	32.37	382	46	P	V
	*	2464	100.18	-	-	95.47	31.53	5.55	32.37	382	46	A	V
		2487.88	52.96	-21.04	74	48.08	31.64	5.55	32.31	382	46	P	V
	2483.5	42.36	-11.64	54	37.53	31.59	5.55	32.31	382	46	A	V	
Remark	1. No other spurious found. 2. All results are PASS against Peak and Average limit line.												



2.4GHz 2400~2483.5MHz

WIFI 802.11b (Harmonic @ 3m)

WIFI Ant. 1	Note	Frequency ( MHz )	Level ( dBμV/m )	Over Limit ( dB )	Limit Line ( dBμV/m )	Read Level ( dBμV )	Antenna Factor ( dB/m )	Cable Loss ( dB )	Preamp Factor ( dB )	Ant Pos ( cm )	Table Pos ( deg )	Peak Avg. (P/A)	Pol. (H/V)
802.11b CH 01 2412MHz		4824	42.74	-31.26	74	61.87	34.89	8.1	62.12	100	360	P	H
		4824	42.03	-31.97	74	61.16	34.89	8.1	62.12	100	360	P	V
802.11b CH 06 2437MHz		4872	41.13	-32.87	74	60.23	34.92	8.09	62.11	100	360	P	H
		7308	43.07	-30.93	74	60.8	35.29	9.75	62.77	100	360	P	H
		4872	42.44	-31.56	74	61.54	34.92	8.09	62.11	100	360	P	V
		7308	45.46	-28.54	74	63.19	35.29	9.75	62.77	100	360	P	V
802.11b CH 11 2462MHz		4926	43.08	-30.92	74	62.16	34.95	8.06	62.09	100	360	P	H
		7386	45.54	-28.46	74	63.17	35.34	9.81	62.78	100	360	P	H
		4926	41.26	-32.74	74	60.34	34.95	8.06	62.09	100	360	P	V
		7386	47.52	-26.48	74	65.15	35.34	9.81	62.78	100	360	P	V
Remark	1. No other spurious found. 2. All results are PASS against Peak and Average limit line.												



2.4GHz 2400~2483.5MHz
WIFI 802.11g (Band Edge @ 3m)

Table with 14 columns: WIFI Ant. 1, Note, Frequency (MHz), Level (dBµV/m), Over Limit (dB), Limit Line (dBµV/m), Read Level (dBµV), Antenna Factor (dB/m), Cable Loss (dB), Preamp Factor (dB), Ant Pos (cm), Table Pos (deg), Peak Avg. (P/A), Pol. (H/V). Rows include data for 802.11g CH 01 (2412MHz) and 802.11g CH 11 (2462MHz).

Remark

- 1. No other spurious found.
2. All results are PASS against Peak and Average limit line.



2.4GHz 2400~2483.5MHz

WIFI 802.11g (Harmonic @ 3m)

WIFI Ant. 1	Note	Frequency ( MHz )	Level ( dBμV/m )	Over Limit ( dB )	Limit Line ( dBμV/m )	Read Level ( dBμV )	Antenna Factor ( dB/m )	Cable Loss ( dB )	Preamp Factor ( dB )	Ant Pos ( cm )	Table Pos ( deg )	Peak Avg. (P/A)	Pol. (H/V)
802.11g CH 01 2412MHz		4824	41.04	-32.96	74	60.17	34.89	8.1	62.12	100	360	P	H
		4824	41.81	-32.19	74	60.94	34.89	8.1	62.12	100	360	P	V
802.11g CH 06 2437MHz		4872	40.48	-33.52	74	59.58	34.92	8.09	62.11	100	360	P	H
		7308	41.93	-32.07	74	59.66	35.29	9.75	62.77	100	360	P	H
		4872	40.73	-33.27	74	59.83	34.92	8.09	62.11	100	360	P	V
		7308	43.55	-30.45	74	61.28	35.29	9.75	62.77	100	360	P	V
802.11g CH 11 2462MHz		4926	41.47	-32.53	74	60.55	34.95	8.06	62.09	100	360	P	H
		7386	41.25	-32.75	74	58.88	35.34	9.81	62.78	100	360	P	H
		4926	41.13	-32.87	74	60.21	34.95	8.06	62.09	100	360	P	V
		7386	43.34	-30.66	74	60.97	35.34	9.81	62.78	100	360	P	V
Remark	1. No other spurious found. 2. All results are PASS against Peak and Average limit line.												



2.4GHz 2400~2483.5MHz

WIFI 802.11n HT20 (Band Edge @ 3m)

WIFI Ant. 1	Note	Frequency ( MHz )	Level ( dBμV/m )	Over Limit ( dB )	Limit Line ( dBμV/m )	Read Level ( dBμV )	Antenna Factor ( dB/m )	Cable Loss ( dB )	Preamp Factor ( dB )	Ant Pos ( cm )	Table Pos ( deg )	Peak Avg. (P/A)	Pol. (H/V)
802.11n HT20 CH 01 2412MHz		2389.95	52.26	-21.74	74	48.02	31.3	5.48	32.54	343	325	P	H
		2389.95	41.72	-12.28	54	37.48	31.3	5.48	32.54	343	325	A	H
	*	2416	102.11	-	-	97.75	31.36	5.48	32.48	343	325	P	H
	*	2416	94.25	-	-	89.89	31.36	5.48	32.48	343	325	A	H
		2374.74	51.92	-22.08	74	47.79	31.25	5.43	32.55	353	47	P	V
		2389.95	42.06	-11.94	54	37.82	31.3	5.48	32.54	353	47	A	V
	*	2416	102.18	-	-	97.82	31.36	5.48	32.48	353	47	P	V
802.11n HT20 CH 11 2462MHz	*	2464	104.2	-	-	99.49	31.53	5.55	32.37	376	341	P	H
	*	2464	96.73	-	-	92.02	31.53	5.55	32.37	376	341	A	H
		2483.98	65.55	-8.45	74	60.72	31.59	5.55	32.31	376	341	P	H
		2483.5	49.54	-4.46	54	44.71	31.59	5.55	32.31	376	341	A	H
	*	2464	102.52	-	-	97.81	31.53	5.55	32.37	384	46	P	V
	*	2464	95.05	-	-	90.34	31.53	5.55	32.37	384	46	A	V
		2483.56	64.25	-9.75	74	59.42	31.59	5.55	32.31	384	46	P	V
	2483.5	48.7	-5.3	54	43.87	31.59	5.55	32.31	384	46	A	V	
Remark	1. No other spurious found. 2. All results are PASS against Peak and Average limit line.												





2.4GHz 2400~2483.5MHz

WIFI 802.11n HT20 (Harmonic @ 3m)

WIFI Ant. 1	Note	Frequency ( MHz )	Level ( dBμV/m )	Over Limit ( dB )	Limit Line ( dBμV/m )	Read Level ( dBμV )	Antenna Factor ( dB/m )	Cable Loss ( dB )	Preamp Factor ( dB )	Ant Pos ( cm )	Table Pos ( deg )	Peak Avg. (P/A)	Pol. (H/V)
802.11n HT20 CH 01 2412MHz		4824	41.86	-32.14	74	60.99	34.89	8.1	62.12	100	360	P	H
		4824	41.57	-32.43	74	60.7	34.89	8.1	62.12	100	360	P	V
802.11n HT20 CH 06 2437MHz		4872	40.69	-33.31	74	59.79	34.92	8.09	62.11	100	360	P	H
		7308	42.84	-31.16	74	60.57	35.29	9.75	62.77	100	360	P	H
		4872	41.31	-32.69	74	60.41	34.92	8.09	62.11	100	360	P	V
		7308	42.07	-31.93	74	59.8	35.29	9.75	62.77	100	360	P	V
802.11n HT20 CH 11 2462MHz		4926	41.24	-32.76	74	60.32	34.95	8.06	62.09	100	360	P	H
		7386	43.67	-30.33	74	61.3	35.34	9.81	62.78	100	360	P	H
		4926	41.34	-32.66	74	60.42	34.95	8.06	62.09	100	360	P	V
		7386	44.94	-29.06	74	62.57	35.34	9.81	62.78	100	360	P	V
Remark	1. No other spurious found. 2. All results are PASS against Peak and Average limit line.												



2.4GHz 2400~2483.5MHz

Emission below 1GHz

2.4GHz WIFI 802.11n HT20 (LF)

WIFI Ant.	Note	Frequency	Level	Over Limit	Limit Line	Read Level	Antenna Factor	Cable Loss	Preamp Factor	Ant Pos	Table Pos	Peak Avg.	Pol.
1		( MHz )	( dBμV/m )	( dB )	( dBμV/m )	( dBμV )	( dB/m )	( dB )	( dB )	( cm )	( deg )	( P/A )	( H/V )
2.4GHz 802.11n HT20 LF		45.52	21.68	-18.32	40	37.18	16.68	0.78	32.96	-	-	P	H
		88.2	33.21	-10.29	43.5	50.44	14.64	1.05	32.92	100	49	P	H
		184.23	31.11	-12.39	43.5	47.56	14.98	1.5	32.93	-	-	P	H
		224.97	24.94	-21.06	46	40.38	15.85	1.66	32.95	-	-	P	H
		302.57	24.62	-21.38	46	36.26	19.47	1.91	33.02	-	-	P	H
		588.72	26.52	-19.48	46	31.46	25.73	2.67	33.34	-	-	P	H
		45.52	33.84	-6.16	40	49.34	16.68	0.78	32.96	100	39	P	V
		88.2	32.69	-10.81	43.5	49.92	14.64	1.05	32.92	-	-	P	V
		108.57	23.3	-20.2	43.5	37.96	17.11	1.16	32.93	-	-	P	V
		206.54	28.64	-14.86	43.5	44.73	15.23	1.6	32.92	-	-	P	V
		294.81	24.64	-21.36	46	36.42	19.35	1.89	33.02	-	-	P	V
	741.01	29.84	-16.16	46	31.79	28.18	3.01	33.14	-	-	P	V	
Remark	1. No other spurious found. 2. All results are PASS against limit line.												



**Note symbol**

*	<b>Fundamental Frequency</b> which can be ignored. However, the level of any unwanted emissions shall not exceed the level of the fundamental frequency.
!	Test result is <b>over limit</b> line.
P/A	<b>Peak</b> or <b>Average</b>
H/V	<b>Horizontal</b> or <b>Vertical</b>



A calculation example for radiated spurious emission is shown as below:

WIFI	Note	Frequency	Level	Over	Limit	Read	Antenna	Cable	Preamp	Ant	Table	Peak	Pol.
Ant.				Limit	Line	Level	Factor	Loss	Factor	Pos	Pos	Avg.	
2		( MHz )	( dBμV/m )	( dB )	( dBμV/m )	( dBμV )	( dB/m )	( dB )	( dB )	( cm )	( deg )	( P/A )	( H/V )
802.11b		2390	55.45	-18.55	74	54.51	32.22	4.58	35.86	103	308	P	H
CH 01		2390	43.54	-10.46	54	42.6	32.22	4.58	35.86	103	308	A	H
2412MHz													

- Level(dBμV/m) =  
Antenna Factor(dB/m) + Cable Loss(dB) + Read Level(dBμV) - Preamp Factor(dB)
- Over Limit(dB) = Level(dBμV/m) – Limit Line(dBμV/m)

**For Peak Limit @ 2390MHz:**

- Level(dBμV/m)  
= Antenna Factor(dB/m) + Cable Loss(dB) + Read Level(dBμV) - Preamp Factor(dB)  
= 32.22(dB/m) + 4.58(dB) + 54.51(dBμV) – 35.86 (dB)  
= 55.45 (dBμV/m)
- Over Limit(dB)  
= Level(dBμV/m) – Limit Line(dBμV/m)  
= 55.45(dBμV/m) – 74(dBμV/m)  
= -18.55(dB)

**For Average Limit @ 2390MHz:**

- Level(dBμV/m)  
= Antenna Factor(dB/m) + Cable Loss(dB) + Read Level(dBμV) - Preamp Factor(dB)  
= 32.22(dB/m) + 4.58(dB) + 42.6(dBμV) – 35.86 (dB)  
= 43.54 (dBμV/m)
- Over Limit(dB)  
= Level(dBμV/m) – Limit Line(dBμV/m)  
= 43.54(dBμV/m) – 54(dBμV/m)  
= -10.46(dB)

Both peak and average measured complies with the limit line, so test result is “PASS”.



### Appendix D. Duty Cycle Plots

Band	Duty Cycle(%)	T(ms)	1/T(kHz)	VBW Setting
802.11b	100	-	-	10 Hz
802.11g	97.46	1.391	0.719	0.75KHz
802.11n HT20	97.28	1.297	0.771	0.82KHz

#### 802.11b

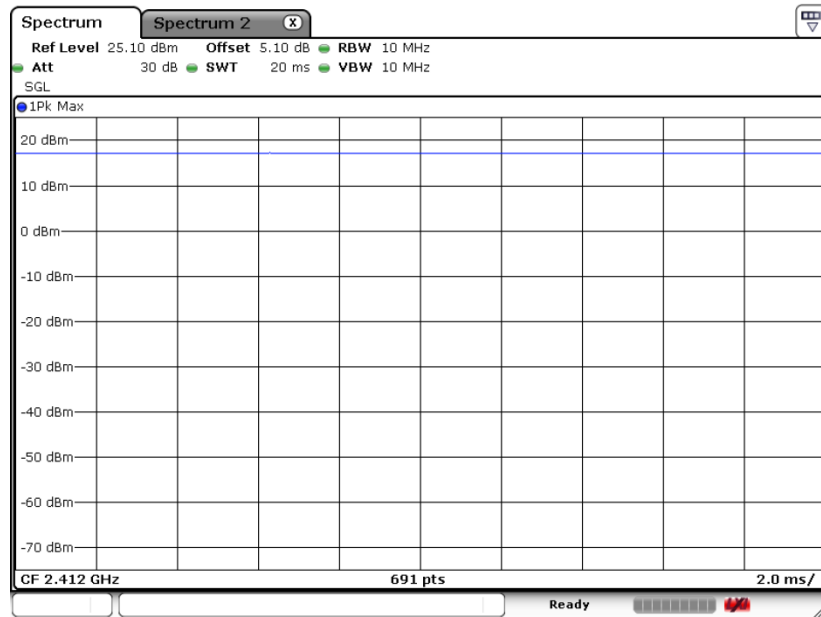



### 802.11g

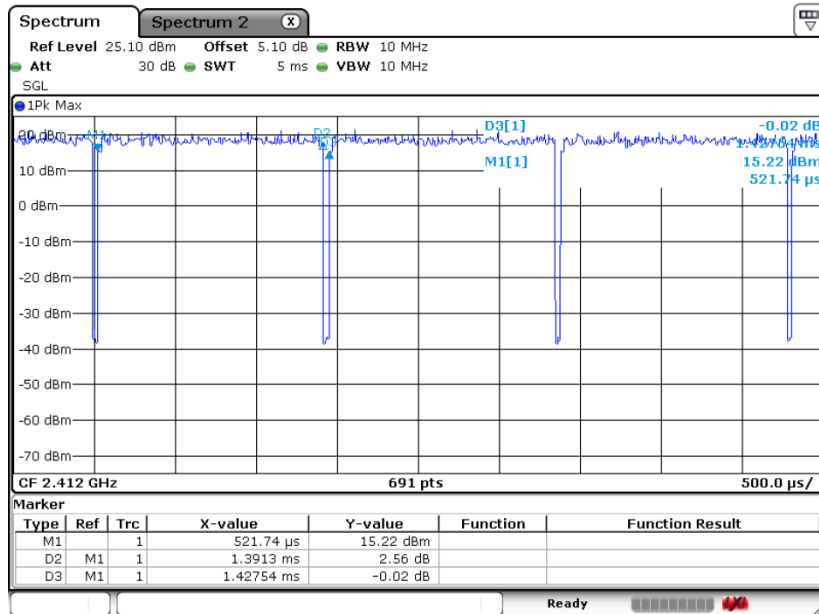

### 802.11n HT20

