



# FCC RF Test Report

**APPLICANT** : Motorola Mobility LLC  
**EQUIPMENT** : Mobile Cellular Phone  
**BRAND NAME** : Motorola  
**MODEL NAME** : XT2041-4, XT2041-6, XT2041-7, XT2041DL  
**FCC ID** : IHDT56YL1  
**STANDARD** : 47 CFR Part 2, 22(H), 24(E), 27(F), 27(H)  
**CLASSIFICATION** : PCS Licensed Transmitter Held to Ear (PCE)

The product was received on Sep. 19, 2019 and completely tested on Dec. 03, 2019. We, Sporton International (Kunshan) Inc., would like to declare that the tested sample has been evaluated in accordance with the procedures given in ANSI C63.26-2015 and shown compliance with the applicable technical standards.

The test results in this report apply exclusively to the tested model / sample. Without written approval of Sporton International (Kunshan) Inc., the test report shall not be reproduced except in full.

*Jason Jia*

Reviewed by: Jason Jia / Supervisor

*James Huang*

Approved by: James Huang / Manager



**Sporton International (Kunshan) Inc.**

**No. 1098, Pengxi North Road, Kunshan Economic Development Zone Jiangsu Province 215300  
People's Republic of China**



TABLE OF CONTENTS

REVISION HISTORY... 3
SUMMARY OF TEST RESULT ... 4
1 GENERAL DESCRIPTION ... 5
1.1 Applicant ... 5
1.2 Manufacturer ... 5
1.3 Product Feature of Equipment Under Test ... 5
1.4 Product Specification of Equipment Under Test ... 6
1.5 Modification of EUT ... 6
1.6 Maximum ERP/EIRP Power, Frequency Tolerance, and Emission Designator ... 7
1.7 Specification of Accessory ... 12
1.8 Testing Location ... 12
1.9 Test Software ... 12
1.10 Applicable Standards ... 13
2 TEST CONFIGURATION OF EQUIPMENT UNDER TEST ... 14
2.1 Test Mode ... 14
2.2 Connection Diagram of Test System ... 17
2.3 Support Unit used in test configuration and system ... 17
2.4 Measurement Results Explanation Example ... 17
2.5 Frequency List of Low/Middle/High Channels ... 18
3 CONDUCTED TEST ITEMS ... 22
3.1 Measuring Instruments ... 22
3.2 Test Setup ... 22
3.3 Test Result of Conducted Test ... 22
3.4 Conducted Output Power and ERP/EIRP ... 23
3.5 Peak-to-Average Ratio ... 24
3.6 Occupied Bandwidth ... 25
3.7 Conducted Band Edge ... 26
3.8 Conducted Spurious Emission ... 28
3.9 Frequency Stability ... 29
4 RADIATED TEST ITEMS ... 30
4.1 Measuring Instruments ... 30
4.2 Test Setup ... 30
4.3 Test Result of Radiated Test ... 30
4.4 Radiated Spurious Emission ... 31
5 LIST OF MEASURING EQUIPMENT ... 32
6 UNCERTAINTY OF EVALUATION ... 33
APPENDIX A. TEST RESULTS OF CONDUCTED TEST
APPENDIX B. TEST RESULTS OF RADIATED TEST
APPENDIX C. TEST SETUP PHOTOGRAPHS





## SUMMARY OF TEST RESULT

Report Section	FCC Rule	Description	Limit	Result	Remark
3.4	§2.1046	Conducted Output Power	Reporting Only	PASS	-
	§22.913(a)(5)	Effective Radiated Power (Band 5) (Band 26)	ERP < 7 Watt	PASS	-
	§27.50(b)(10) §27.50(c)(10)	Effective Radiated Power (Band 12) (Band 13) (Band 17)	ERP < 3 Watt	PASS	-
	§24.232(c)	Equivalent Isotropic Radiated Power (Band 2) (Band 25)	EIRP < 2Watt	PASS	-
3.5	§24.232(d)	Peak-to-Average Ratio	<13 dB	PASS	-
3.6	§2.1049	Occupied Bandwidth	Reporting Only	PASS	-
3.7	§2.1051 §22.917(a) §24.238(a) §27.53(c)(2)(4) §27.53(g)	Conducted Band Edge Measurement (Band 2) (Band 5) (Band 12) (Band 13) (Band 17) (Band 25) (Band 26)	< 43+10log <sub>10</sub> (P[Watts])	PASS	-
3.8	§2.1051 §22.917(a) §24.238(a) §27.53(c)(2) §27.53(g)	Conducted Spurious Emission (Band 2) (Band 5) (Band 12) (Band 13) (Band 17) (Band 25) (Band 26)	< 43+10log <sub>10</sub> (P[Watts])	PASS	-
3.9	§2.1055 §22.355	Frequency Stability Temperature & Voltage	< 2.5 ppm for Part 22	PASS	-
	§2.1055 §24.235 §27.54		Within Authorized Band		
4.4	§2.1053 §22.917(a) §24.238(a) §27.53(c)(2) §27.53(f) §27.53(g)	Radiated Spurious Emission (Band 2) (Band 5) (Band 12) (Band 13) (Band 17) (Band 25) (Band 26)	< 43+10log <sub>10</sub> (P[Watts])	PASS	Under limit 15.75 dB at 1560.00 MHz

**Declaration of Conformity:**

The test results with all measurement uncertainty excluded are presented in accordance with the regulation limits or requirements declared by manufacturers.

**Comments and Explanations:**

The declared of product specification for EUT presented in the report are provided by the manufacturer, and the manufacturer takes all the responsibilities for the accuracy of product specification.



# 1 General Description

## 1.1 Applicant

Motorola Mobility LLC  
222 W, Merchandise Mart Plaza, Chicago IL 60654 USA

## 1.2 Manufacturer

Motorola Mobility LLC  
222 W, Merchandise Mart Plaza, Chicago IL 60654 USA

## 1.3 Product Feature of Equipment Under Test

Product Feature	
Equipment	Mobile Cellular Phone
Brand Name	Motorola
Model Name	XT2041-4, XT2041-6, XT2041-7, XT2041DL
FCC ID	IHDT56YL1
EUT supports Radios application	CDMA/GSM/WCDMA/LTE WLAN 2.4GHz 802.11b/g/n HT20 WLAN 5GHz 802.11a/n HT20/HT40 WLAN 5GHz 802.11ac VHT20/VHT40/VHT80 Bluetooth BR/EDR/LE FM Receiver and GNSS
IMEI Code	Conducted: 357244100011546/357244100011501 Radiation: 357244100020935/357244100020901
HW Version	DVT2
SW Version	QPM30.55
EUT Stage	Identical Prototype

Remark: The different model names are for different market requirement



### 1.4 Product Specification of Equipment Under Test

Standards-related Product Specification	
<b>Tx Frequency</b>	LTE Band 2 : 1850.7 MHz ~ 1909.3 MHz LTE Band 5 : 824.7 MHz ~ 848.3 MHz LTE Band 12 : 699.7 MHz ~ 715.3 MHz LTE Band 13 : 779.5 MHz ~ 784.5 MHz LTE Band 17 : 706.5 MHz ~ 713.5 MHz LTE Band 25 : 1850.7MHz ~ 1914.3 MHz LTE Band 26 : 824.7MHz ~ 848.3 MHz
<b>Rx Frequency</b>	LTE Band 2 : 1930.7 MHz ~ 1989.3 MHz LTE Band 5 : 869.7 MHz ~ 893.3 MHz LTE Band 12 : 729.7 MHz ~ 745.3 MHz LTE Band 13 : 748.5 MHz ~ 753.5 MHz LTE Band 17 : 736.5 MHz ~ 743.5 MHz LTE Band 25 : 1930.7MHz ~ 1994.3 MHz LTE Band 26 : 869.7MHz ~ 893.3MHz
<b>Bandwidth</b>	LTE Band 2 : 1.4MHz / 3MHz / 5MHz / 10MHz / 15MHz / 20MHz LTE Band 5 : 1.4MHz / 3MHz / 5MHz / 10MHz LTE Band 12 : 1.4MHz / 3MHz / 5MHz / 10MHz LTE Band 13 : 5MHz / 10MHz LTE Band 17 : 5MHz / 10MHz LTE Band 25 : 1.4MHz / 3MHz / 5MHz / 10MHz / 15MHz / 20MHz LTE Band 26 : 1.4MHz / 3MHz / 5MHz / 10MHz / 15MHz
<b>Maximum Output Power to Antenna</b>	LTE Band 2 : 23.34 dBm LTE Band 5 : 23.26 dBm LTE Band 5B_CA: 23.45 dBm LTE Band 12 : 23.09 dBm LTE Band 13 : 22.91 dBm LTE Band 17 : 22.90 dBm LTE Band 25 : 23.35 dBm LTE Band 26 : 23.29 dBm
<b>Antenna Gain</b>	LTE Band 2 : -1.00 dBi LTE Band 5 : -3.00 dBi LTE Band 12 : -3.00 dBi LTE Band 13 : -3.00 dBi LTE Band 17 : -3.00 dBi LTE Band 25 : -1.00 dBi LTE Band 26 : -3.00 dBi
<b>Type of Modulation</b>	QPSK / 16QAM / 64QAM

### 1.5 Modification of EUT

No modifications are made to the EUT during all test items.



### 1.6 Maximum ERP/EIRP Power, Frequency Tolerance, and Emission Designator

LTE Band 2		QPSK			16QAM		
BW (MHz)	Frequency Range (MHz)	Emission Designator (99%OBW)	Frequency Tolerance (ppm)	Maximum EIRP(W)	Emission Designator (99%OBW)	Frequency Tolerance (ppm)	Maximum EIRP(W)
1.4	1850.7 ~ 1909.3	1M10G7D	-	0.1552	1M10W7D	-	0.1324
3	1851.5 ~ 1908.5	2M74G7D	-	0.1535	2M71W7D	-	0.1387
5	1852.5 ~ 1907.5	4M51G7D	-	0.1614	4M49W7D	-	0.1303
10	1855.0 ~ 1905.0	9M05G7D	0.0023	0.1675	9M01W7D	-	0.1374
15	1857.5 ~ 1902.5	13M4G7D	-	0.1600	13M5W7D	-	0.1452
20	1860.0 ~ 1900.0	18M3G7D	-	0.1718	18M4W7D	-	0.1452
LTE Band 2		64QAM					
BW (MHz)	Frequency Range (MHz)	Emission Designator (99%OBW)		Frequency Tolerance (ppm)		Maximum EIRP(W)	
1.4	1850.7 ~ 1909.3	1M09W7D		-		0.1047	
3	1851.5 ~ 1908.5	2M73W7D		-		0.1005	
5	1852.5 ~ 1907.5	4M52W7D		-		0.1052	
10	1855.0 ~ 1905.0	9M05W7D		-		0.1114	
15	1857.5 ~ 1902.5	13M4W7D		-		0.1164	
20	1860.0 ~ 1900.0	18M5W7D		-		0.1125	
LTE Band 25		QPSK			16QAM		
BW (MHz)	Frequency Range (MHz)	Emission Designator (99%OBW)	Frequency Tolerance (ppm)	Maximum EIRP(W)	Emission Designator (99%OBW)	Frequency Tolerance (ppm)	Maximum EIRP(W)
1.4	1850.7 ~ 1914.3	1M10G7D	-	0.1552	1M10W7D	-	0.1324
3	1851.5 ~ 1913.5	2M74G7D	-	0.1535	2M71W7D	-	0.1387
5	1852.5 ~ 1912.5	4M51G7D	-	0.1614	4M49W7D	-	0.1303
10	1855.0 ~ 1910.0	9M05G7D	0.0023	0.1675	9M01W7D	-	0.1374
15	1857.5 ~ 1907.5	13M4G7D	-	0.1600	13M5W7D	-	0.1452
20	1860.0 ~ 1905.0	18M3G7D	-	0.1718	18M4W7D	-	0.1452



LTE Band 25		64QAM		
BW (MHz)	Frequency Range (MHz)	Emission Designator (99%OBW)	Frequency Tolerance (ppm)	Maximum EIRP(W)
1.4	1850.7 ~ 1914.3	1M09W7D	-	0.1047
3	1851.5 ~ 1913.5	2M73W7D	-	0.1005
5	1852.5 ~ 1912.5	4M52W7D	-	0.1052
10	1855.0 ~ 1910.0	9M05W7D	-	0.1114
15	1857.5 ~ 1907.5	13M4W7D	-	0.1164
20	1860.0 ~ 1905.0	18M5W7D	-	0.1125

LTE Band 5		QPSK			16QAM		
BW (MHz)	Frequency Range (MHz)	Emission Designator (99%OBW)	Frequency Tolerance (ppm)	Maximum ERP(W)	Emission Designator (99%OBW)	Frequency Tolerance (ppm)	Maximum ERP(W)
1.4	824.7 ~ 848.3	1M09G7D	-	0.0635	1M09W7D	-	0.0553
3	825.5 ~ 847.5	2M73G7D	-	0.0624	2M73W7D	-	0.0528
5	826.5 ~ 846.5	4M51G7D	-	0.0640	4M52W7D	-	0.0552
10	829.0 ~ 844.0	9M03G7D	0.0083	0.0634	9M07W7D	-	0.0541

LTE Band 5		64QAM		
BW (MHz)	Frequency Range (MHz)	Emission Designator (99%OBW)	Frequency Tolerance (ppm)	Maximum ERP(W)
1.4	824.7 ~ 848.3	1M09W7D	-	0.0446
3	825.5 ~ 847.5	2M73W7D	-	0.0433
5	826.5 ~ 846.5	4M54W7D	-	0.0450
10	829.0 ~ 844.0	9M03W7D	-	0.0447

LTE Band 12		QPSK			16QAM		
BW (MHz)	Frequency Range (MHz)	Emission Designator (99%OBW)	Frequency Tolerance (ppm)	Maximum ERP(W)	Emission Designator (99%OBW)	Frequency Tolerance (ppm)	Maximum ERP(W)
1.4	699.7 ~ 715.3	1M09G7D	-	0.0617	1M09W7D	-	0.0533
3	700.5 ~ 714.5	2M72G7D	-	0.0601	2M73W7D	-	0.0526
5	701.5 ~ 713.5	4M49G7D	-	0.0621	4M51W7D	-	0.0492
10	704.0 ~ 711.0	9M03G7D	0.0105	0.0622	9M01W7D	-	0.0537





LTE Band 12		64QAM					
BW (MHz)	Frequency Range (MHz)	Emission Designator (99%OBW)		Frequency Tolerance (ppm)		Maximum ERP(W)	
1.4	699.7 ~ 715.3	1M09W7D		-		0.0394	
3	700.5 ~ 714.5	2M73W7D		-		0.0412	
5	701.5 ~ 713.5	4M52W7D		-		0.0390	
10	704.0 ~ 711.0	9M05W7D		-		0.0417	
LTE Band 13		QPSK			16QAM		
BW (MHz)	Frequency Range (MHz)	Emission Designator (99%OBW)	Frequency Tolerance (ppm)	Maximum ERP(W)	Emission Designator (99%OBW)	Frequency Tolerance (ppm)	Maximum ERP(W)
5	779.5 ~ 784.5	4M50G7D	-	0.0596	4M49W7D	-	0.0492
10	782.0	9M01G7D	0.0045	0.0597	9M03W7D	-	0.0470
LTE Band 13		64QAM					
BW (MHz)	Frequency Range (MHz)	Emission Designator (99%OBW)		Frequency Tolerance (ppm)		Maximum ERP(W)	
5	779.5 ~ 784.5	4M51W7D		-		0.0424	
10	782.0	9M01W7D		-		0.0428	
LTE Band 17		QPSK			16QAM		
BW (MHz)	Frequency Range (MHz)	Emission Designator (99%OBW)	Frequency Tolerance (ppm)	Maximum ERP(W)	Emission Designator (99%OBW)	Frequency Tolerance (ppm)	Maximum ERP(W)
5	706.5 ~ 713.5	4M49G7D	-	0.0621	4M51W7D	-	0.0492
10	709.0 ~ 711.0	9M03G7D	0.0105	0.0622	9M01W7D	-	0.0537
LTE Band 17		64QAM					
BW (MHz)	Frequency Range (MHz)	Emission Designator (99%OBW)		Frequency Tolerance (ppm)		Maximum ERP(W)	
5	706.5 ~ 713.5	4M52W7D		-		0.0390	
10	709.0 ~ 711.0	9M05W7D		-		0.0417	



LTE Band 26		QPSK			16QAM		
BW (MHz)	Frequency Range (MHz)	Emission Designator (99%OBW)	Frequency Tolerance (ppm)	Maximum ERP(W)	Emission Designator (99%OBW)	Frequency Tolerance (ppm)	Maximum ERP(W)
1.4	824.7 ~ 848.3	1M09G7D	-	0.0635	1M09W7D	-	0.0553
3	825.5 ~ 847.5	2M73G7D	-	0.0624	2M73W7D	-	0.0528
5	826.5 ~ 846.5	4M51G7D	-	0.0640	4M52W7D	-	0.0552
10	829.0 ~ 844.0	9M03G7D	0.0083	0.0634	9M07W7D	-	0.0541
15	831.5 ~ 841.5	13M4G7D	-	0.0652	13M4W7D	-	0.0547
CH26765	821.5	13M4G7D	-	0.0624	13M5W7D	-	0.0543
LTE Band 26		64QAM					
BW (MHz)	Frequency Range (MHz)	Emission Designator (99%OBW)		Frequency Tolerance (ppm)	Maximum ERP(W)		
1.4	824.7 ~ 848.3	1M09W7D		-	0.0446		
3	825.5 ~ 847.5	2M73W7D		-	0.0433		
5	826.5 ~ 846.5	4M54W7D		-	0.0450		
10	829.0 ~ 844.0	9M03W7D		-	0.0447		
15	831.5 ~ 841.5	13M5W7D		-	0.0436		
CH26765	821.5	13M4W7D		-	0.0436		



LTE Band 5B_CA		QPSK			16QAM		
BW (MHz)	Frequency Range (MHz)	Emission Designator (99%OBW)	Frequency Tolerance (ppm)	Maximum ERP(W)	Emission Designator (99%OBW)	Frequency Tolerance (ppm)	Maximum ERP(W)
5MHz+10MHz	826.8 ~ 844	13M9G7D	-	0.0659	13M8W7D	-	0.0571
10MHz+5MHz	829 ~ 846.2	13M9G7D	-	0.0646	13M9W7D	-	0.0552
10MHz+10MHz	829 ~ 844	18M8G7D	-	0.0644	18M8W7D	-	0.0638
LTE Band 5B_CA		64QAM					
BW (MHz)	Frequency Range (MHz)	Emission Designator (99%OBW)		Frequency Tolerance (ppm)		Maximum ERP(W)	
5MHz+10MHz	826.8 ~ 844	13M9W7D		-		0.0367	
10MHz+5MHz	829 ~ 846.2	13M9W7D		-		0.0378	
10MHz+10MHz	829 ~ 844	18M8W7D		-		0.0676	

Note:

1. LTE Band 26 overlaps the entire frequency range of LTE Band 5. Therefore, the test results provided in this report covers Band 5 and the portion of Band 26 subject to Part 22.
2. LTE Band 25 overlaps the entire frequency range of LTE Band 2. Therefore, the test results provided in this report covers Band 25 as well as Band 2.
3. LTE Band 12 overlaps the entire frequency range of LTE Band 17. Therefore, the test results provided in this report covers Band 12 as well as Band 17.



### 1.7 Specification of Accessory

Specification of Accessory				
AC Adapter 1	Brand Name	Motorola(Acbel)	Model Name	SC-41
	Power Rating	I/P: 100-240 Vac, 300mA, O/P: 5Vdc, 2000mA		
AC Adapter 2	Brand Name	Motorola(Chenyang)	Model Name	SC-41
	Power Rating	I/P: 100-240 Vac, 300mA, O/P: 5Vdc, 2000mA		
Battery	Brand Name	Motorola ( AmpereX )	Model Name	KZ50
	Power Rating	3.8Vdc, 4700mAh	Type	Li-ion polymer
USB Cable 1	Brand Name	Motorola (Saibao)	Model Name	SC18C24367
	Signal Line Type	1.0 meter, shielded cable, without ferrite core		
USB Cable 2	Brand Name	Motorola (Luxshare)	Model Name	SC18C24368
	Signal Line Type	1.0 meter, shielded cable, without ferrite core		

### 1.8 Testing Location

Sporton International (Kunshan) Inc. is accredited to ISO/IEC 17025:2017 by American Association for Laboratory Accreditation with Certificate Number 5145.02.

Test Firm	Sporton International (Kunshan) Inc.		
Test Site Location	No. 1098, Pengxi North Road, Kunshan Economic Development Zone Jiangsu Province 215300 People's Republic of China TEL : +86-512-57900158 FAX : +86-512-57900958		
Test Site No.	Sporton Site No.	FCC Designation No.	FCC Test Firm Registration No.
	TH01-KS 03CH06-KS	CN1257	314309

### 1.9 Test Software

Item	Site	Manufacture	Name	Version
1.	03CH06-KS	AUDIX	E3	6.2009-8-24al



## 1.10 Applicable Standards

According to the specifications of the manufacturer, the EUT must comply with the requirements of the following standards:

- ♦ 47 CFR Part 2, 22(H), 24(E), 27(F), 27(H)
- ♦ ANSI C63.26-2015
- ♦ FCC KDB 971168 D01 Power Meas License Digital Systems v03r01
- ♦ FCC KDB 412172 D01 Determining ERP and EIRP v01r01

### **Remark:**

1. All test items were verified and recorded according to the standards and without any deviation during the test.
2. This EUT has also been tested and complied with the requirements of FCC Part 15, Subpart B, recorded in a separate test report.



## 2 Test Configuration of Equipment Under Test

### 2.1 Test Mode

Antenna port conducted and radiated test items listed below are performed according to KDB 971168 D01 Power Meas License Digital Systems v03r01 with maximum output power.

Radiated measurements are performed by rotating the EUT in three different orthogonal test planes to find the maximum emission.

Test Items	Band	Bandwidth (MHz)						Modulation			RB #			Test Channel		
		1.4	3	5	10	15	20	QPSK	16QAM	64QAM	1	Half	Full	L	M	H
Max. Output Power	2	v	v	v	v	v	v	v	v	v	v	v	v	v	v	v
	5	v	v	v	v	-	-	v	v	v	v	v	v	v	v	v
	12	v	v	v	v	-	-	v	v	v	v	v	v	v	v	v
	13	-	-	v	v	-	-	v	v	v	v	v	v	v	v	v
	17	-	-	v	v	-	-	v	v	v	v	v	v	v	v	v
	25	v	v	v	v	v	v	v	v	v	v	v	v	v	v	v
	26	v	v	v	v	v	-	v	v	v	v	v	v	v	v	v
Peak-to-Average Ratio	12				v	-	-	v	v	v	v		v	v	v	v
	13	-	-		v	-	-	v	v	v	v		v	v	v	v
	25						v	v	v	v	v		v	v	v	v
	26					v	-	v	v	v	v		v	v	v	v
26dB and 99% Bandwidth	12	v	v	v	v	-	-	v	v	v			v	v	v	v
	13	-	-	v	v	-	-	v	v	v			v	v	v	v
	25	v	v	v	v	v	v	v	v	v			v	v	v	v
	26	v	v	v	v	v	-	v	v	v			v	v	v	v
Conducted Band Edge	12	v	v	v	v	-	-	v	v	v	v		v	v		v
	13	-	-	v	v	-	-	v	v	v	v		v	v		v
	25	v	v	v	v	v	v	v	v	v	v		v	v		v
	26	v	v	v	v	v	-	v	v	v	v		v	v		v



Test Items	Band	Bandwidth (MHz)						Modulation			RB #			Test Channel		
		1.4	3	5	10	15	20	QPSK	16QAM	64QAM	1	Half	Full	L	M	H
Conducted Spurious Emission	12	v	v	v	v	-	-	v	v	v	v			v	v	v
	13	-	-	v	v	-	-	v	v	v	v			v	v	v
	25	v	v	v	v	v	v	v	v	v	v			v	v	v
	26	v	v	v	v	v	-	v	v	v	v			v	v	v
Frequency Stability	12				v	-	-	v					v		v	
	13	-	-		v	-	-	v					v		v	
	25				v			v					v		v	
	26				v		-	v					v		v	
E.R.P / E.I.R.P	12	v	v	v	v	-	-	v	v	v	v			v	v	v
	13	-	-	v	v	-	-	v	v	v	v			v	v	v
	25	v	v	v	v	v	v	v	v	v	v			v	v	v
	26	v	v	v	v	v	-	v	v	v	v			v	v	v
Radiated Spurious Emission	12	Worst Case												v	v	v
	13	Worst Case												v	v	v
	25	Worst Case												v	v	v
	26	Worst Case												v	v	v
Note	<ol style="list-style-type: none"> <li>The mark "v " means that this configuration is chosen for testing</li> <li>The mark "- " means that this bandwidth is not supported.</li> <li>The device is investigated from 30MHz to 10 times of fundamental signal for radiated spurious emission test under different RB size/offset and modulations in exploratory test. Subsequently, only the worst case emissions are reported.</li> <li>LTE Band 26 overlaps the entire frequency range of LTE Band 5. Therefore, the test results provided in this report covers Band 5 and the portion of Band 26 subject to Part 22.</li> <li>LTE Band 25 overlaps the entire frequency range of LTE Band 2. Therefore, the test results provided in this report covers Band 25 as well as Band 2.</li> <li>LTE Band 12 overlaps the entire frequency range of LTE Band 17. Therefore, the test results provided in this report covers Band 12 as well as Band 17.</li> </ol>															



Test Items	Band	Bandwidth (MHz)			Modulation			RB #			Test Channel			
		10+10	10+5	5+10	QPSK	16QAM	64QAM	1	Half	Full	L	M	H	
Max. Output Power	5B_CA	v	v	v	v	v	v	v	v	v	v	v	v	v
26dB and 99% Bandwidth	5B_CA	v	v	v	v	v	v			v	v	v	v	v
Conducted Band Edge	5B_CA	v	v	v	v	v	v	v		v	v		v	v
Conducted Spurious Emission	5B_CA	v	v	v	v	v	v	v			v	v	v	v
E.R.P.	5B_CA	v	v	v	v	v	v	v			v	v	v	v
Radiated Spurious Emission	5B_CA	Worst Case									v	v	v	
Note	<ol style="list-style-type: none"> <li>The mark "v" means that this configuration is chosen for testing</li> <li>The mark "-" means that this bandwidth is not supported.</li> <li>The device is investigated from 30MHz to 10 times of fundamental signal for radiated spurious emission test under different RB size/offset and modulations in exploratory test. Subsequently, only the worst case emissions are reported.</li> </ol>													



## 2.2 Connection Diagram of Test System

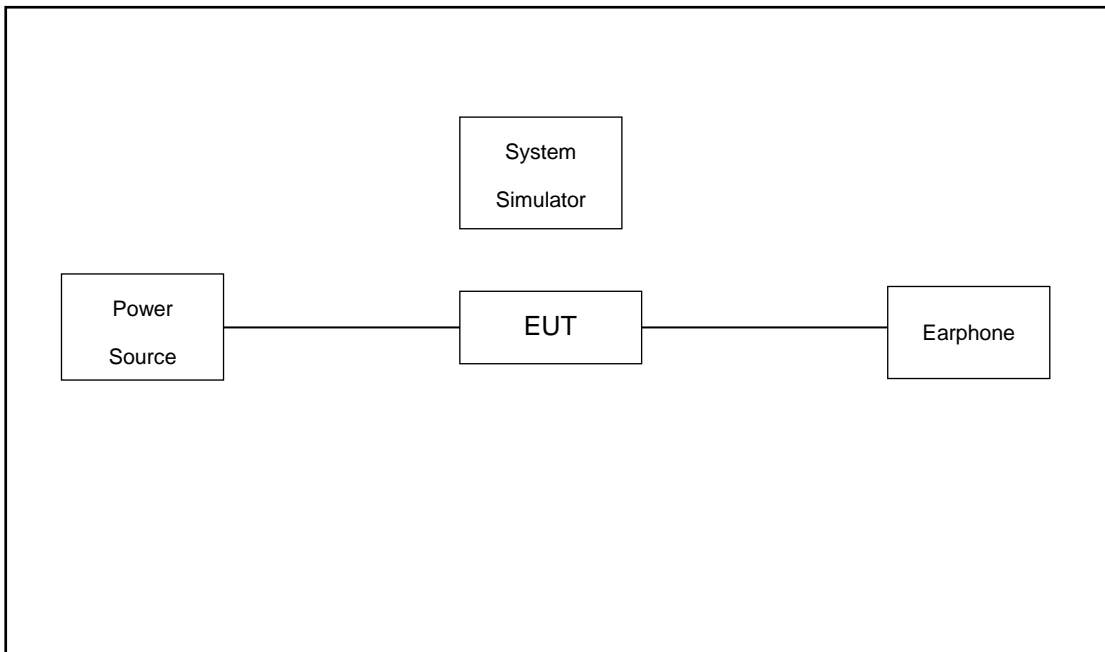

## 2.3 Support Unit used in test configuration and system

Item	Equipment	Trade Name	Model No.	FCC ID	Data Cable	Power Cord
1.	Power Supply	GWINSTEK	PSS-2002	N/A	N/A	Unshielded, 1.8 m
2.	LTE Base Station	Anritsu	MT8820C	N/A	N/A	Unshielded, 1.8 m
3.	Earphone	N/A	N/A	N/A	N/A	N/A

## 2.4 Measurement Results Explanation Example

### For all conducted test items:

The offset level is set in the spectrum analyzer to compensate the RF cable loss between EUT conducted output port and spectrum analyzer. With the offset compensation, the spectrum analyzer reading level is exactly the EUT RF output level.

The spectrum analyzer offset is derived from RF cable loss.

*Offset = RF cable loss.*

Following shows an offset computation example with cable loss 5.3 dB.

Example :

$$\begin{aligned}
 \text{Offset(dB)} &= \text{RF cable loss(dB)}. \\
 &= 5.3 \text{ (dB)}
 \end{aligned}$$



### 2.5 Frequency List of Low/Middle/High Channels

LTE Band 2 Channel and Frequency List				
BW [MHz]	Channel/Frequency(MHz)	Lowest	Middle	Highest
20	Channel	18700	18900	19100
	Frequency	1860	1880	1900
15	Channel	18675	18900	19125
	Frequency	1857.5	1880	1902.5
10	Channel	18650	18900	19150
	Frequency	1855	1880	1905
5	Channel	18625	18900	19175
	Frequency	1852.5	1880	1907.5
3	Channel	18615	18900	19185
	Frequency	1851.5	1880	1908.5
1.4	Channel	18607	18900	19193
	Frequency	1850.7	1880	1909.3

LTE Band 5 Channel and Frequency List				
BW [MHz]	Channel/Frequency(MHz)	Lowest	Middle	Highest
10	Channel	20450	20525	20600
	Frequency	829	836.5	844
5	Channel	20425	20525	20625
	Frequency	826.5	836.5	846.5
3	Channel	20415	20525	20635
	Frequency	825.5	836.5	847.5
1.4	Channel	20407	20525	20643
	Frequency	824.7	836.5	848.3



LTE Band 12 Channel and Frequency List				
BW [MHz]	Channel/Frequency(MHz)	Lowest	Middle	Highest
10	Channel	23060	23095	23130
	Frequency	704	707.5	711
5	Channel	23035	23095	23155
	Frequency	701.5	707.5	713.5
3	Channel	23025	23095	23165
	Frequency	700.5	707.5	714.5
1.4	Channel	23017	23095	23173
	Frequency	699.7	707.5	715.3

LTE Band 13 Channel and Frequency List				
BW [MHz]	Channel/Frequency(MHz)	Lowest	Middle	Highest
10	Channel	-	23230	-
	Frequency	-	782	-
5	Channel	23205	23230	23255
	Frequency	779.5	782	784.5

LTE Band 17 Channel and Frequency List				
BW [MHz]	Channel/Frequency(MHz)	Lowest	Middle	Highest
10	Channel	23780	23790	23800
	Frequency	709	710	711
5	Channel	23755	23790	23825
	Frequency	706.5	710	713.5



LTE Band 25 Channel and Frequency List				
BW [MHz]	Channel/Frequency(MHz)	Lowest	Middle	Highest
20	Channel	26140	26340	26590
	Frequency	1860	1880	1905
15	Channel	26115	26340	26615
	Frequency	1857.5	1880	1907.5
10	Channel	26090	26340	26640
	Frequency	1855	1880	1910
5	Channel	26065	26340	26665
	Frequency	1852.5	1880	1912.5
3	Channel	26055	26340	26675
	Frequency	1851.5	1880	1913.5
1.4	Channel	26047	26340	26683
	Frequency	1850.7	1880	1914.3

LTE Band 26 Channel and Frequency List				
BW [MHz]	Channel/Frequency(MHz)	Lowest	Middle	Highest
15	Channel	26865	26915	26965
	Frequency	831.5	836.5	841.5
10	Channel	26840	26915	26990
	Frequency	829	836.5	844
5	Channel	26815	26915	27015
	Frequency	826.5	836.5	846.5
3	Channel	26805	26915	27025
	Frequency	825.5	836.5	847.5
1.4	Channel	26797	26915	27033
	Frequency	824.7	836.5	848.3



LTE Band 5B_CA Channel and Frequency List					
BW [MHz]	Channel/Frequency(MHz)		Lowest	Middle	Highest
5 + 10	PCC	Channel	20428	20478	20528
		Frequency	826.8	831.8	836.8
	SCC	Channel	20500	20550	20600
		Frequency	834	839	844
10 + 5	PCC	Channel	20450	20500	20550
		Frequency	829	834	839
	SCC	Channel	20522	20572	20622
		Frequency	836.2	841.2	846.2
10 + 10	PCC	Channel	20450	20476	20501
		Frequency	829	831.6	834.1
	SCC	Channel	20549	20575	20600
		Frequency	838.9	841.5	844

### 3 Conducted Test Items

#### 3.1 Measuring Instruments

See list of measuring instruments of this test report.

#### 3.2 Test Setup

##### 3.2.1 Conducted Output Power



##### 3.2.2 Peak-to-Average Ratio, Occupied Bandwidth ,Conducted Band-Edge and Conducted Spurious Emission

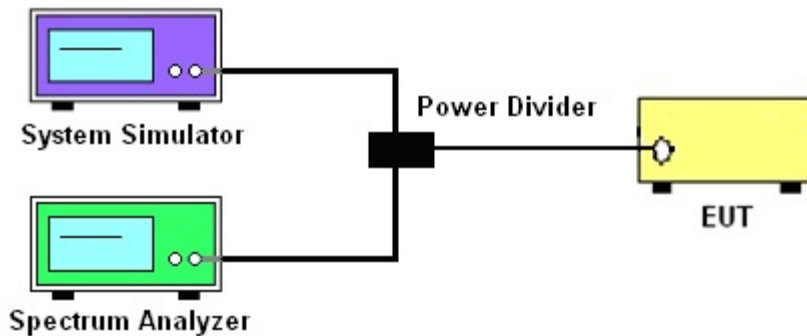

##### 3.2.3 Frequency Stability

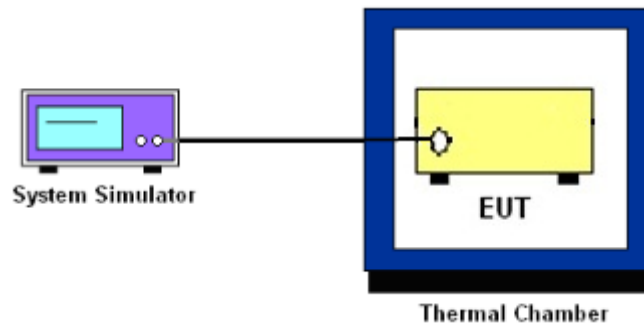

### 3.3 Test Result of Conducted Test

Please refer to Appendix A.



### 3.4 Conducted Output Power and ERP/EIRP

#### 3.4.1 Description of the Conducted Output Power Measurement and ERP/EIRP Measurement

A system simulator was used to establish communication with the EUT. Its parameters were set to force the EUT transmitting at maximum output power. The measured power in the radio frequency on the transmitter output terminals shall be reported.

The ERP of mobile transmitters must not exceed 7 Watts for LTE Band 5 and Band 26.

The ERP of mobile transmitters must not exceed 3 Watts for LTE Band 12, Band 13 and Band 17.

The EIRP of mobile transmitters must not exceed 2 Watts for LTE Band 2 and Band 25.

According to KDB 412172 D01 Power Approach,

$EIRP = P_T + G_T - L_C$ ,  $ERP = EIRP - 2.15$ , where

$P_T$  = transmitter output power in dBm

$G_T$  = gain of the transmitting antenna in dBi

$L_C$  = signal attenuation in the connecting cable between the transmitter and antenna in dB

#### 3.4.2 Test Procedures

1. The testing follows ANSI C63.26 Section 5.2
2. The transmitter output port was connected to the system simulator.
3. Set EUT at maximum power through the system simulator.
4. Select lowest, middle, and highest channels for each band and different modulation.
5. Measure and record the power level from the system simulator.



## **3.5 Peak-to-Average Ratio**

### **3.5.1 Description of the PAR Measurement**

Power Complementary Cumulative Distribution Function (CCDF) curves provide a means for characterizing the power peaks of a digitally modulated signal on a statistical basis. A CCDF curve depicts the probability of the peak signal amplitude exceeding the average power level. Most contemporary measurement instrumentation include the capability to produce CCDF curves for an input signal provided that the instrument's resolution bandwidth can be set wide enough to accommodate the entire input signal bandwidth. In measuring transmissions in this band using an average power technique, the peak-to-average ratio (PAR) of the transmission may not exceed 13 dB.

### **3.5.2 Test Procedures**

1. The testing follows ANSI C63.26 Section 5.2.3.4 (CCDF).
2. The EUT was connected to spectrum and system simulator via a power divider.
3. Set the CCDF (Complementary Cumulative Distribution Function) option in spectrum analyzer.
4. The highest RF powers were measured and recorded the maximum PAPR level associated with a probability of 0.1 %.
5. Record the deviation as Peak to Average Ratio.





### 3.6 Occupied Bandwidth

#### 3.6.1 Description of Occupied Bandwidth Measurement

The occupied bandwidth is the width of a frequency band such that, below the lower and above the upper frequency limits, the mean powers emitted are each equal to a specified percentage 0.5% of the total mean transmitted power.

The 26 dB emission bandwidth is defined as the frequency range between two points, one above and one below the carrier frequency, at which the spectral density of the emission is attenuated 26 dB below the maximum in-band spectral density of the modulated signal. Spectral density (power per unit bandwidth) is to be measured with a detector of resolution bandwidth equal to approximately 1.0% of the emission bandwidth.

#### 3.6.2 Test Procedures

1. The testing follows ANSI C63.26 Section 5.4
2. The EUT was connected to spectrum analyzer and system simulator via a power divider.
3. The spectrum analyzer center frequency is set to the nominal EUT channel center frequency. The span range for the spectrum analyzer shall be between two and five times the anticipated OBW.
4. The nominal resolution bandwidth (RBW) shall be in the range of 1 to 5 % of the anticipated OBW, and the VBW shall be at least 3 times the RBW.
5. Set the detection mode to peak, and the trace mode to max hold.
6. Determine the reference value: Set the EUT to transmit a modulated signal. Allow the trace to stabilize. Set the spectrum analyzer marker to the highest level of the displayed trace.  
(this is the reference value)
7. Determine the “-26 dB down amplitude” as equal to (Reference Value – X).
8. Place two markers, one at the lowest and the other at the highest frequency of the envelope of the spectral display such that each marker is at or slightly below the “-X dB down amplitude” determined in step 6. If a marker is below this “-X dB down amplitude” value it shall be placed as close as possible to this value. The OBW is the positive frequency difference between the two markers.
9. Use the 99 % power bandwidth function of the spectrum analyzer and report the measured bandwidth.



## 3.7 Conducted Band Edge

### 3.7.1 Description of Conducted Band Edge Measurement

22.917(a)

For operations in the 824 – 849 MHz band, the FCC limit is  $43 + 10\log_{10}(P[\text{Watts}])$  dB below the transmitter power  $P(\text{Watts})$  in a 100kHz bandwidth. However, in the 1MHz bands immediately outside and adjacent to the licensee's frequency block, a resolution bandwidth of at least one percent of the emission bandwidth of the fundamental emission of the transmitter may be employed.

24.238 (a)

For operations in the 1850-1910 and 1930-1990 MHz band, the FCC limit is  $43 + 10\log_{10}(P[\text{Watts}])$  dB below the transmitter power  $P(\text{Watts})$  in a 1MHz bandwidth. However, in the 1 MHz bands immediately outside and adjacent to the frequency block a resolution bandwidth of at least one percent of the emission bandwidth of the fundamental emission of the transmitter may be employed.

27.53 (c)

For operations in the 776-788 MHz band, the FCC limit is  $43 + 10\log_{10}(P[\text{Watts}])$  dB below the transmitter power  $P(\text{Watts})$  in a 100 kHz bandwidth. However, in the 100 kHz bands immediately outside and adjacent to the frequency block, a resolution bandwidth of at least 30 kHz may be employed. In addition, the power of any unwanted emissions in any 6.25 kHz bandwidth for all frequencies between 763-775 MHz and 793-806 MHz shall be attenuated below the transmitter power,  $P$  (dBW), by at least  $65 + 10 \log_{10} p(\text{watts})$ , dB, for mobile and portable equipment.

27.53 (g)

For operations in the 600MHz band and 698 -746 MHz band, the FCC limit is  $43 + 10\log_{10}(P[\text{Watts}])$  dB below the transmitter power  $P(\text{Watts})$  in a 100 kHz bandwidth. However, in the 100 kilohertz bands immediately outside and adjacent to a licensee's frequency block, a resolution bandwidth of at least 30 kHz may be employed.



### 3.7.2 Test Procedures

1. The testing follows ANSI C63.26 section 5.7
2. The EUT was connected to spectrum analyzer and system simulator via a power divider.
3. The band edges of low and high channels for the highest RF powers were measured.
4. Set RBW  $\geq$  1% EBW in the 1MHz band immediately outside and adjacent to the band edge.
5. Beyond the 1 MHz band from the band edge, RBW=1MHz was used.
6. Set spectrum analyzer with RMS detector.
7. The RF fundamental frequency should be excluded against the limit line in the operating frequency band.
8. Checked that all the results comply with the emission limit line.

Example:

The limit line is derived from  $43 + 10\log(P)$ dB below the transmitter power P(Watts)  
= P(W)- [43 + 10log(P)] (dB)  
= [30 + 10log(P)] (dBm) - [43 + 10log(P)] (dB) = -13dBm.



### 3.8 Conducted Spurious Emission

#### 3.8.1 Description of Conducted Spurious Emission Measurement

The power of any emission outside of the authorized operating frequency ranges must be lower than the transmitter power (P) by a factor of at least  $43 + 10 \log (P)$  dB.

It is measured by means of a calibrated spectrum analyzer and scanned from 30 MHz up to a frequency including its 10<sup>th</sup> harmonic.

#### 3.8.2 Test Procedures

1. The testing follows ANSI C63.26 section 5.7
2. The EUT was connected to spectrum analyzer and system simulator via a power divider.
3. The RF output of EUT was connected to the spectrum analyzer by RF cable and attenuator. The path loss was compensated to the results for each measurement.
4. The middle channel for the highest RF power within the transmitting frequency was measured.
5. The conducted spurious emission for the whole frequency range was taken.
6. Make the measurement with the spectrum analyzer's RBW = 1MHz, VBW = 3MHz.
7. Set spectrum analyzer with RMS detector.
8. Taking the record of maximum spurious emission.
9. The RF fundamental frequency should be excluded against the limit line in the operating frequency band.
10. The limit line is derived from  $43 + 10\log(P)$ dB below the transmitter power P(Watts)  
= P(W)- [43 + 10log(P)] (dB)  
= [30 + 10log(P)] (dBm) - [43 + 10log(P)] (dB)  
= -13dBm.



## 3.9 Frequency Stability

### 3.9.1 Description of Frequency Stability Measurement

The frequency stability shall be measured by variation of ambient temperature and variation of primary supply voltage to ensure that the fundamental emission stays within the authorized frequency block. The frequency stability of the transmitter shall be maintained within  $\pm 0.00025\%$  ( $\pm 2.5\text{ppm}$ ) of the center frequency.

### 3.9.2 Test Procedures for Temperature Variation

1. The testing follows ANSI C63.26 section 5.6.4
2. The EUT was set up in the thermal chamber and connected with the system simulator.
3. With power OFF, the temperature was decreased to  $-30^{\circ}\text{C}$  and the EUT was stabilized before testing. Power was applied and the maximum change in frequency was recorded within one minute.
4. With power OFF, the temperature was raised in  $10^{\circ}\text{C}$  step up to  $50^{\circ}\text{C}$ . The EUT was stabilized at each step for at least half an hour. Power was applied and the maximum frequency change was recorded within one minute.

### 3.9.3 Test Procedures for Voltage Variation

1. The testing follows ANSI C63.26 section 5.6.5
2. The EUT was placed in a temperature chamber at  $20\pm 5^{\circ}\text{C}$  and connected with the system simulator.
3. The power supply voltage to the EUT was varied from 85% to 115% of the nominal value for other than hand carried battery equipment.
4. For hand carried, battery powered equipment, reduce the primary ac or dc supply voltage to the battery operating end point, which shall be specified by the manufacturer.
5. The variation in frequency was measured for the worst case.

## 4 Radiated Test Items

### 4.1 Measuring Instruments

See list of measuring instruments of this test report.

### 4.2 Test Setup

#### 4.2.1 For radiated test from 30MHz to 1GHz

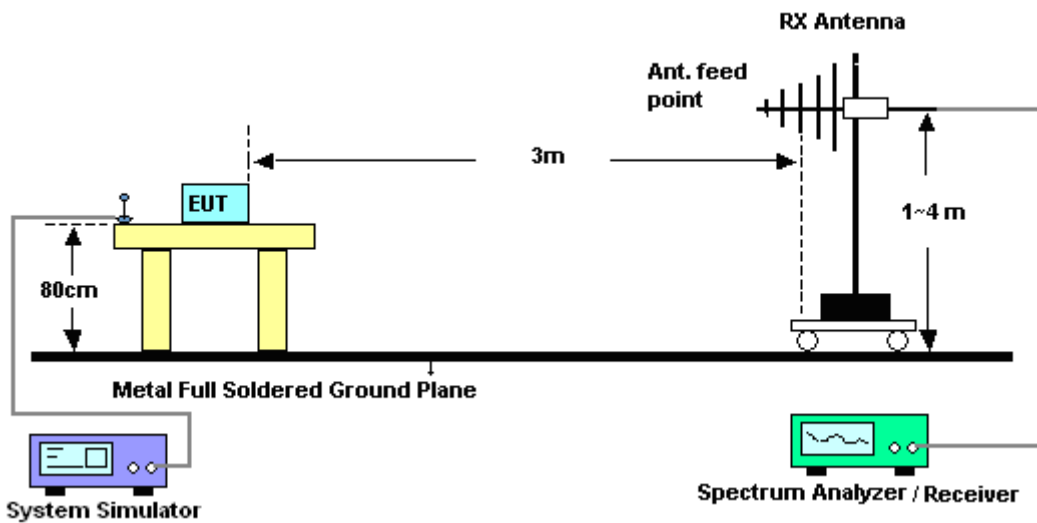

#### 4.2.2 For radiated test above 1GHz

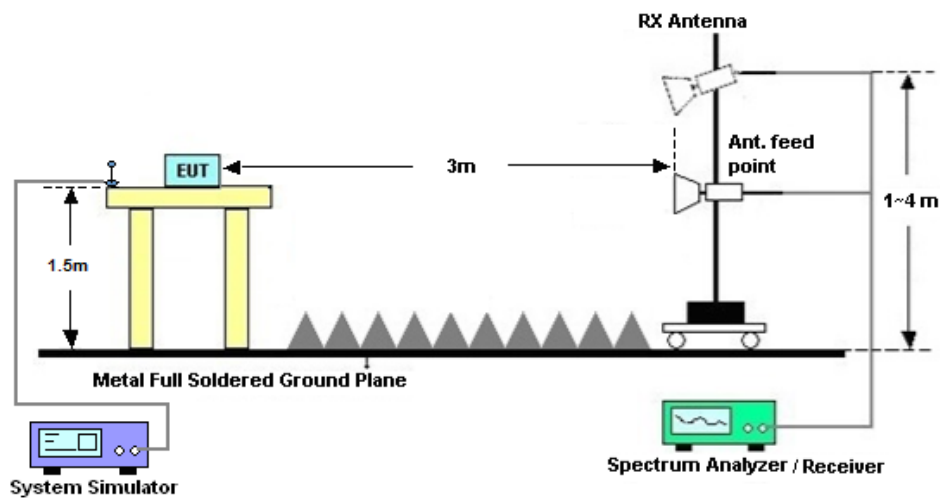

### 4.3 Test Result of Radiated Test

Please refer to Appendix B.



## 4.4 Radiated Spurious Emission

### 4.4.1 Description of Radiated Spurious Emission

The radiated spurious emission was measured by substitution method according to ANSI C63.26. The power of any emission outside of the authorized operating frequency ranges must be attenuated below the transmitter power (P) by a factor of at least  $43 + 10 \log (P)$  dB.

For LTE Band 13

For operations in the 746-758 MHz, 775-788 MHz, and 805-806 MHz bands, emissions in the band 1559-1610 MHz shall be limited to  $-70$  dBW/MHz equivalent isotropically radiated power (EIRP) for wideband signals, and  $-80$  dBW EIRP for discrete emissions of less than 700 Hz bandwidth.

The spectrum is scanned from 30 MHz up to a frequency including its 10th harmonic.

### 4.4.2 Test Procedures

1. The testing follows ANSI C63.26 Section 5.5
2. The EUT was placed on a turntable with 0.8 meter height for frequency below 1GHz and 1.5 meter height for frequency above 1GHz respectively above ground.
3. The EUT was set 3 meters from the receiving antenna mounted on the antenna tower.
4. The table was rotated 360 degrees to determine the position of the highest spurious emission.
5. The height of the receiving antenna is varied between 1m to 4m to search the maximum spurious emission for both horizontal and vertical polarizations.
6. During the measurement, the system simulator parameters were set to force the EUT transmitting at maximum output power.
7. Make the measurement with the spectrum analyzer's RBW = 1MHz, VBW = 3MHz, taking the record of maximum spurious emission.
8. A horn antenna was substituted in place of the EUT and was driven by a signal generator.
9. Tune the output power of signal generator to the same emission level with EUT maximum spurious emission.
10.  $EIRP \text{ (dBm)} = S.G. \text{ Power} - Tx \text{ Cable Loss} + Tx \text{ Antenna Gain}$
11.  $ERP \text{ (dBm)} = EIRP - 2.15$
12. The RF fundamental frequency should be excluded against the limit line in the operating frequency band.

The limit line is derived from  $43 + 10\log(P)$ dB below the transmitter power P(Watts)  
 $= P(W) - [43 + 10\log(P)] \text{ (dB)}$   
 $= [30 + 10\log(P)] \text{ (dBm)} - [43 + 10\log(P)] \text{ (dB)}$   
 $= -13\text{dBm}.$



## 5 List of Measuring Equipment

Instrument	Manufacturer	Model No.	Serial No.	Characteristics	Calibration Date	Test Date	Due Date	Remark
Spectrum Analyzer	R&S	FSV40	101040	10Hz~40GHz	Aug. 06, 2019	Oct. 09, 2019~ Dec. 02, 2019	Aug. 05, 2020	Conducted (TH01-KS)
Thermal Chamber	Ten Billion	TTC-B3S	TBN-960502	-40~+150°C	Nov. 19, 2018	Oct. 09, 2019~ Dec. 02, 2019	Nov. 18, 2019	Conducted (TH01-KS)
Thermal Chamber	Ten Billion	TTC-B3S	TBN-960502	-40~+150°C	Nov. 18, 2019		Nov. 17, 2020	Conducted (TH01-KS)
EXA Spectrum Analyzer	Keysight	N9010A	MY55150208	10Hz~44GHz	Apr. 16, 2019	Oct. 29, 2019~ Dec. 03, 2019	Apr. 15, 2020	Radiation (03CH06-KS)
Bilog Antenna	TeseQ	CBL6111D	44483	30MHz~1GHz	Dec. 28, 2018	Oct. 29, 2019~ Dec. 03, 2019	Dec. 27, 2019	Radiation (03CH06-KS)
Double Ridge Horn Antenna	ETS-Lindgren	3117	75959	1GHz~18GHz	Jan. 27, 2019	Oct. 29, 2019~ Dec. 03, 2019	Jan. 26, 2020	Radiation (03CH06-KS)
SHF-EHF Horn	Com-power	AH-840	101070	18GHz~40GHz	Jan. 05, 2019	Oct. 29, 2019~ Dec. 03, 2019	Jan. 04, 2020	Radiation (03CH06-KS)
Amplifier	SONOMA	310N	187289	9KHz ~1GHZ	Aug. 06, 2019	Oct. 29, 2019~ Dec. 03, 2019	Aug. 05, 2020	Radiation (03CH06-KS)
Amplifier	MITEQ	TTA1840-35-HG	2014749	18~40GHz	Jan. 14, 2019	Oct. 29, 2019~ Dec. 03, 2019	Jan. 13, 2020	Radiation (03CH06-KS)
high gain Amplifier	MITEQ	AMF-7D-00 101800-30-1 0P	2025788	1Ghz-18Ghz	Apr. 17, 2019	Oct. 29, 2019~ Dec. 03, 2019	Apr. 16, 2020	Radiation (03CH06-KS)
Amplifier	Keysight	83017A	MY53270203	500MHz~26.5GHz	Apr. 15, 2019	Oct. 29, 2019~ Dec. 03, 2019	Apr. 14, 2020	Radiation (03CH06-KS)
AC Power Source	Chroma	61601	F104090004	N/A	NCR	Oct. 29, 2019~ Dec. 03, 2019	NCR	Radiation (03CH06-KS)
Turn Table	ChamPro	EM 1000-T	060762-T	0~360 degree	NCR	Oct. 29, 2019~ Dec. 03, 2019	NCR	Radiation (03CH06-KS)
Antenna Mast	ChamPro	EM 1000-A	060762-A	1 m~4 m	NCR	Oct. 29, 2019~ Dec. 03, 2019	NCR	Radiation (03CH06-KS)

NCR: No Calibration Required





## 6 Uncertainty of Evaluation

The measurement uncertainties shown below were calculated in accordance with the requirements of ANSI 63.26-2015. All the measurement uncertainty value were shown with a coverage K=2 to indicate 95% level of confidence. The measurement data show herein meets or exceeds the CISPR measurement uncertainty values specified in CISPR 16-4-2 and can be compared directly to specified limit to determine compliance.

### Uncertainty of Radiated Emission Measurement (30 MHz ~ 1000 MHz)

Measuring Uncertainty for a Level of Confidence of 95% (U = 2Uc(y))	2.5dB
---	-------

### Uncertainty of Radiated Emission Measurement (1 GHz ~ 40 GHz)

Measuring Uncertainty for a Level of Confidence of 95% (U = 2Uc(y))	2.1dB
---	-------



### Appendix A. Test Results of Conducted Test

#### Conducted Output Power(Average power)

LTE Band 2 Maximum Average Power [dBm]						
BW [MHz]	RB Size	RB Offset	Mod	Lowest	Middle	Highest
20	1	0	QPSK	23.34	23.26	22.93
20	1	49		22.97	22.88	22.85
20	1	99		23.01	23.03	22.85
20	50	0		22.48	22.42	22.26
20	50	24		22.44	22.31	22.26
20	50	50		22.34	22.29	22.25
20	100	0		22.42	22.29	22.19
20	1	0	16-QAM	22.73	22.64	22.45
20	1	49		22.45	22.28	22.39
20	1	99		22.49	22.42	22.29
20	50	0		21.28	21.23	21.07
20	50	24		21.21	21.14	21.08
20	50	50		21.16	21.11	21.06
20	100	0		21.16	21.09	20.98
20	1	0	64QAM	21.42	21.33	20.98
20	1	49		21.12	21.10	20.96
20	1	99		21.11	21.10	20.98
20	50	0		20.00	19.94	19.76
20	50	24		19.86	19.84	19.77
20	50	50		19.81	19.70	19.78
20	100	0		19.99	19.87	19.74
15	1	0	QPSK	23.16	23.09	23.05
15	1	37		23.01	22.93	22.92
15	1	74		22.90	22.87	22.86
15	36	0		22.15	22.07	22.00
15	36	20		22.10	21.95	22.00
15	36	39		22.03	21.91	21.92
15	75	0		22.08	21.98	21.96
15	1	0	16-QAM	22.43	22.33	22.38



15	1	37		22.23	22.11	22.33
15	1	74		22.25	22.06	22.26
15	36	0		21.25	21.15	21.05
15	36	20		21.11	21.07	21.12
15	36	39		21.10	21.04	21.04
15	75	0		21.19	21.06	21.06
15	1	0	64QAM	21.05	20.90	21.01
15	1	37		20.83	20.72	20.79
15	1	74		20.79	20.68	20.71
15	36	0		20.00	19.85	19.89
15	36	20		19.91	19.81	19.85
15	36	39		19.79	19.78	19.78
15	75	0		19.94	19.81	19.81
15	75	0				



LTE Band 2 Maximum Average Power [dBm]						
BW [MHz]	RB Size	RB Offset	Mod	Lowest	Middle	Highest
10	1	0	QPSK	23.05	23.22	22.97
10	1	25		23.02	22.94	22.96
10	1	49		23.27	23.09	22.83
10	25	0		22.37	22.31	22.21
10	25	12		22.44	22.25	22.27
10	25	25		22.39	22.25	22.24
10	50	0		22.42	22.32	22.23
10	1	0	16-QAM	22.83	22.72	22.41
10	1	25		22.56	22.44	22.33
10	1	49		22.67	22.57	22.33
10	25	0		21.21	21.06	21.12
10	25	12		21.19	21.02	21.08
10	25	25		21.17	21.07	21.00
10	50	0		21.20	21.02	21.08
10	1	0	64QAM	21.43	21.37	21.12
10	1	25		21.20	21.10	21.08
10	1	49		21.27	21.17	20.98
10	25	0		20.33	20.13	20.18
10	25	12		20.30	20.14	20.18
10	25	25		20.22	20.04	20.16
10	50	0		20.29	20.11	20.10
5	1	0	QPSK	23.03	22.91	22.95
5	1	12		23.17	22.90	22.88
5	1	24		23.01	22.89	22.92
5	12	0		22.39	22.44	22.51
5	12	7		22.20	22.58	22.50
5	12	13		22.10	22.58	22.50
5	25	0		22.00	22.08	21.99
5	1	0	16-QAM	22.16	22.02	22.41
5	1	12		22.06	21.91	22.32
5	1	24		22.17	22.03	22.31
5	12	0		21.87	21.71	21.61
5	12	7		21.70	21.71	21.61



5	12	13		21.70	21.73	21.66
5	25	0		21.75	21.74	21.65
5	1	0	64QAM	21.31	21.18	21.18
5	1	12		21.22	21.22	21.18
5	1	24		21.22	21.28	21.23
5	12	0		20.30	20.18	20.13
5	12	7		20.20	20.28	20.13
5	12	13		20.41	20.19	20.13
5	25	0		20.20	20.19	20.13



LTE Band 2 Maximum Average Power [dBm]						
BW [MHz]	RB Size	RB Offset	Mod	Lowest	Middle	Highest
3	1	0	QPSK	23.05	22.84	22.70
3	1	8		22.94	22.88	22.82
3	1	14		22.97	22.81	22.83
3	8	0		22.11	21.95	21.9
3	8	4		22.12	22	21.9
3	8	7		22.11	21.9	21.86
3	15	0		22.12	21.91	21.88
3	1	0	16-QAM	22.34	22.13	22.14
3	1	8		22.25	22.11	22.49
3	1	14		22.19	22.15	22.04
3	8	0		21.26	21.12	21.07
3	8	4		21.25	21.07	21.13
3	8	7		21.27	21.09	21.13
3	15	0		21.09	21.03	21.19
3	1	0	64QAM	21.09	21.03	20.99
3	1	8		21.09	20.96	20.99
3	1	14		21.15	21.02	21.02
3	8	0		20.21	20.04	20.04
3	8	4		20.21	20.04	20.12
3	8	7		20.21	20.04	19.97
3	15	0		20.24	20.07	20.09
1.4	1	0	QPSK	22.97	22.84	22.74
1.4	1	3		23.14	22.99	22.90
1.4	1	5		22.95	22.82	22.74
1.4	3	0		23.03	22.90	22.86
1.4	3	1		23.07	22.92	22.84
1.4	3	3		23.04	22.89	22.79
1.4	6	0		22.30	22.16	22.12
1.4	1	0	16-QAM	22.46	22.34	22.31
1.4	1	3		22.68	22.55	22.42
1.4	1	5		22.39	22.36	22.35
1.4	3	0		22.10	22.04	21.92
1.4	3	1		22.15	22.01	22.00



1.4	3	3	64QAM	21.99	22.01	21.94
1.4	6	0		21.63	21.36	21.31
1.4	1	0		20.94	21.09	21.01
1.4	1	3		21.11	21.22	21.11
1.4	1	5		20.92	21.06	21.02
1.4	3	0		21.00	20.87	20.77
1.4	3	1		21.16	20.92	20.86
1.4	3	3		21.10	20.87	20.80
1.4	6	0		20.23	20.09	20.05



LTE Band 5 Maximum Average Power [dBm]						
BW [MHz]	RB Size	RB Offset	Mod	Lowest	Middle	Highest
10	1	0	QPSK	22.95	23.03	22.95
10	1	25		22.95	23.05	22.81
10	1	49		23.11	22.91	22.84
10	25	0		22.06	22.22	22.18
10	25	12		22.20	22.21	21.99
10	25	25		22.18	22.16	22.01
10	50	0		22.19	22.23	22.15
10	1	0	16-QAM	22.32	22.43	22.45
10	1	25		22.33	22.50	22.26
10	1	49		22.38	22.38	22.20
10	25	0		21.24	21.36	21.20
10	25	12		21.23	21.35	21.12
10	25	25		21.22	21.29	21.05
10	50	0		21.26	21.32	21.24
10	1	0	64QAM	21.56	21.43	21.35
10	1	25		21.57	21.37	21.24
10	1	49		21.58	21.33	21.24
10	25	0		20.52	20.67	20.54
10	25	12		20.66	20.67	20.46
10	25	25		20.55	20.62	20.38
10	50	0		20.63	20.61	20.52
5	1	0	QPSK	23.07	23.07	23.03
5	1	12		23.13	23.15	22.93
5	1	24		22.95	23.12	22.90
5	12	0		22.08	22.21	22.03
5	12	7		22.13	22.28	21.95
5	12	13		22.06	22.22	21.93
5	25	0		22.07	22.23	21.95
5	1	0	16-QAM	22.41	22.58	22.41
5	1	12		22.33	22.59	22.37
5	1	24		22.43	22.57	22.46
5	12	0		21.16	21.32	21.03
5	12	7		21.15	21.29	21.05





5	12	13	64QAM	21.08	21.19	21.03
5	25	0		21.08	21.23	21.03
5	1	0		21.70	21.76	21.60
5	1	12		21.64	21.79	21.54
5	1	24		21.59	21.82	21.51
5	12	0		20.48	20.69	20.41
5	12	7		20.53	20.66	20.43
5	12	13		20.46	20.60	20.40
5	25	0		20.46	20.59	20.39



LTE Band 5 Maximum Average Power [dBm]						
BW [MHz]	RB Size	RB Offset	Mod	Lowest	Middle	Highest
3	1	0	QPSK	22.84	23.13	22.76
3	1	8		22.95	22.92	22.80
3	1	14		22.98	23.07	22.78
3	8	0		21.98	22.15	21.89
3	8	4		22.10	22.17	21.89
3	8	7		22.05	22.17	21.82
3	15	0		22.08	22.16	21.80
3	1	0	16-QAM	22.34	22.50	22.25
3	1	8		22.22	22.46	22.13
3	1	14		22.23	22.31	22.19
3	8	0		21.04	21.22	20.95
3	8	4		21.18	21.22	20.95
3	8	7		21.02	21.15	20.89
3	15	0		21.13	21.23	20.98
3	1	0	64QAM	21.25	21.40	21.15
3	1	8		21.46	21.31	21.08
3	1	14		21.50	21.45	21.15
3	8	0		20.41	20.59	20.33
3	8	4		20.44	20.61	20.33
3	8	7		20.39	20.60	20.26
3	15	0		20.52	20.58	20.32
1.4	1	0	QPSK	23.01	23.23	22.87
1.4	1	3		23.09	23.17	22.93
1.4	1	5		22.99	23.12	22.86
1.4	3	0		23.08	23.22	22.97
1.4	3	1		23.11	23.26	22.91
1.4	3	3		23.14	23.23	22.89
1.4	6	0		22.15	22.25	21.94
1.4	1	0	16-QAM	22.16	22.26	22.09
1.4	1	3		22.27	22.33	22.09
1.4	1	5		22.16	22.27	22.02
1.4	3	0		22.08	22.11	21.84
1.4	3	1		22.10	22.15	21.89



1.4	3	3	64QAM	22.03	22.11	21.86
1.4	6	0		21.28	21.30	21.06
1.4	1	0		21.59	21.69	21.22
1.4	1	3		21.68	21.53	21.49
1.4	1	5		21.59	21.69	21.24
1.4	3	0		21.56	21.59	21.24
1.4	3	1		21.58	21.64	21.20
1.4	3	3		21.51	21.59	21.17
1.4	6	0		20.57	20.57	20.29



LTE Band 12 Maximum Average Power [dBm]						
BW [MHz]	RB Size	RB Offset	Mod	Lowest	Middle	Highest
10	1	0	QPSK	22.89	23.09	22.83
10	1	25		22.79	23.02	22.89
10	1	49		22.88	22.93	22.89
10	25	0		22.09	22.23	22.12
10	25	12		22.18	22.20	22.20
10	25	25		22.22	22.21	22.13
10	50	0		22.11	22.23	22.14
10	1	0	16-QAM	22.37	22.34	22.39
10	1	25		22.29	22.40	22.33
10	1	49		22.45	22.40	22.29
10	25	0		20.85	21.04	21.00
10	25	12		20.97	21.12	20.96
10	25	25		21.00	21.10	20.92
10	50	0		21.02	21.04	20.97
10	1	0	64QAM	21.22	21.30	21.24
10	1	25		21.24	21.35	21.32
10	1	49		21.32	21.35	21.24
10	25	0		19.91	19.95	20.06
10	25	12		20.02	20.06	20.02
10	25	25		20.05	20.05	19.97
10	50	0		20.03	20.05	19.98
5	1	0	QPSK	22.92	22.94	22.93
5	1	12		22.83	23.08	22.89
5	1	24		22.75	23.01	22.95
5	12	0		22.13	22.14	22.17
5	12	7		22.08	22.19	22.13
5	12	13		22.04	22.17	22.09
5	25	0		22.11	22.20	22.16
5	1	0	16-QAM	22.02	22.01	22.07
5	1	12		21.97	22.04	21.94
5	1	24		21.97	22.05	21.97
5	12	0		20.97	21.09	21.02
5	12	7		21.03	21.13	20.97



5	12	13		20.99	21.11	21.04
5	25	0		20.97	21.07	20.95
5	1	0	64QAM	21.03	21.03	21.02
5	1	12		20.99	21.06	21.06
5	1	24		20.99	20.98	20.99
5	12	0		20.12	20.25	20.17
5	12	7		20.17	20.18	20.12
5	12	13		20.13	20.17	20.08
5	25	0		20.18	20.28	20.16



LTE Band 12 Maximum Average Power [dBm]						
BW [MHz]	RB Size	RB Offset	Mod	Lowest	Middle	Highest
3	1	0	QPSK	22.84	22.82	22.78
3	1	8		22.84	22.86	22.75
3	1	14		22.80	22.94	22.81
3	8	0		22.07	22.13	22.07
3	8	4		22.08	22.20	22.01
3	8	7		22.03	22.13	22.00
3	15	0		22.05	22.09	22.07
3	1	0	16-QAM	22.18	22.36	22.32
3	1	8		22.15	22.22	22.32
3	1	14		22.24	22.34	22.25
3	8	0		20.96	20.96	20.95
3	8	4		20.95	21.13	21.02
3	8	7		20.90	21.11	20.90
3	15	0		20.79	21.04	20.90
3	1	0	64QAM	21.00	21.18	21.24
3	1	8		21.23	21.30	21.17
3	1	14		20.94	21.21	21.21
3	8	0		20.10	20.28	20.11
3	8	4		20.15	20.18	20.07
3	8	7		20.06	20.17	20.06
3	15	0		20.09	20.15	20.21
1.4	1	0	QPSK	22.81	22.90	22.86
1.4	1	3		22.89	22.94	22.84
1.4	1	5		22.81	22.85	22.85
1.4	3	0		22.86	22.99	22.80
1.4	3	1		23.05	23.03	22.89
1.4	3	3		22.98	22.98	22.98
1.4	6	0		21.86	22.00	21.90
1.4	1	0	16-QAM	22.06	22.03	22.31
1.4	1	3		22.13	22.09	22.42
1.4	1	5		21.96	22.30	22.28
1.4	3	0		22.03	21.98	21.88
1.4	3	1		22.03	22.12	21.97



1.4	3	3	64QAM	21.98	21.98	22.05
1.4	6	0		21.09	21.20	21.13
1.4	1	0		20.87	20.85	20.96
1.4	1	3		20.93	21.04	20.93
1.4	1	5		20.78	20.95	20.92
1.4	3	0		20.81	21.05	20.86
1.4	3	1		20.81	21.10	20.94
1.4	3	3		20.76	20.77	20.90
1.4	6	0		19.88	20.04	19.97



LTE Band 13 Maximum Average Power [dBm]						
BW [MHz]	RB Size	RB Offset	Mod	Lowest	Middle	Highest
10	1	0	QPSK		22.91	
10	1	25			22.82	
10	1	49			22.58	
10	25	0			21.91	
10	25	12			21.89	
10	25	25			21.81	
10	50	0			21.87	
10	1	0	16-QAM	-	21.79	-
10	1	25			21.87	
10	1	49			21.69	
10	25	0			21.14	
10	25	12			21.24	
10	25	25			21.16	
10	50	0			21.16	
10	1	0	64QAM		21.37	
10	1	25			21.46	
10	1	49			21.28	
10	25	0			20.25	
10	25	12			20.25	
10	25	25			20.27	
10	50	0			20.26	
5	1	0	QPSK	22.90	22.78	22.70
5	1	12		22.82	22.87	22.57
5	1	24		22.90	22.80	22.61
5	12	0		21.87	21.79	21.90
5	12	7		21.89	21.89	21.78
5	12	13		21.78	21.75	21.77
5	25	0		21.92	21.80	21.77
5	1	0	16-QAM	21.93	22.03	22.07
5	1	12		21.99	21.93	21.91
5	1	24		21.96	22.04	21.84
5	12	0		21.21	21.16	21.13
5	12	7		21.15	21.19	21.13





5	12	13	64QAM	21.19	21.14	21.02
5	25	0		21.20	21.17	21.09
5	1	0		21.38	21.25	21.20
5	1	12		21.42	21.35	21.05
5	1	24		21.39	21.17	20.99
5	12	0		20.27	20.24	20.20
5	12	7		20.30	20.24	20.20
5	12	13		20.33	20.27	20.08
5	25	0		20.31	20.23	20.22



LTE Band 17 Maximum Average Power [dBm]						
BW [MHz]	RB Size	RB Offset	Mod	Lowest	Middle	Highest
10	1	0	QPSK	22.88	22.90	22.80
10	1	25		22.81	22.78	22.78
10	1	49		22.84	22.77	22.76
10	25	0		21.95	21.94	21.89
10	25	12		21.95	21.86	21.93
10	25	25		21.95	21.85	21.88
10	50	0		21.93	21.97	21.91
10	1	0	16-QAM	22.46	22.37	22.35
10	1	25		22.30	22.35	22.27
10	1	49		22.34	22.28	22.26
10	25	0		21.05	21.04	21.05
10	25	12		21.03	21.04	21.00
10	25	25		21.04	21.03	20.96
10	50	0		21.09	20.95	20.97
10	1	0	64QAM	21.32	21.33	21.31
10	1	25		21.28	21.23	20.86
10	1	49		21.32	21.25	20.86
10	25	0		20.03	20.02	19.91
10	25	12		20.00	20.00	19.93
10	25	25		20.01	20.00	19.89
10	50	0		20.05	19.89	19.88
5	1	0	QPSK	22.86	22.72	22.68
5	1	12		22.81	22.66	22.69
5	1	24		22.71	22.76	22.65
5	12	0		21.93	21.95	21.81
5	12	7		22.01	21.88	21.87
5	12	13		21.92	21.92	21.82
5	25	0		21.92	21.81	21.80
5	1	0	16-QAM	22.09	21.96	22.07
5	1	12		22.08	21.99	22.01
5	1	24		22.08	22.08	21.95
5	12	0		21.07	20.91	20.77
5	12	7		21.03	20.84	20.82



5	12	13	64QAM	20.96	20.89	20.79
5	25	0		21.00	20.96	20.92
5	1	0		21.01	20.68	20.71
5	1	12		20.90	20.64	20.65
5	1	24		20.69	20.96	20.61
5	12	0		19.92	19.97	20.02
5	12	7		19.99	20.04	19.98
5	12	13		20.01	19.95	19.94
5	25	0		19.92	19.97	19.91



LTE Band 25 Maximum Average Power [dBm]						
BW [MHz]	RB Size	RB Offset	Mod	Lowest	Middle	Highest
20	1	0	QPSK	23.25	23.35	22.92
20	1	49		22.99	22.86	22.91
20	1	99		23.02	22.98	22.86
20	50	0		22.18	22.16	22.05
20	50	24		22.29	22.07	22.01
20	50	50		22.18	22.00	21.96
20	100	0		22.16	22.04	22.12
20	1	0	16-QAM	22.62	22.62	22.37
20	1	49		22.36	22.21	22.31
20	1	99		22.39	22.37	22.39
20	50	0		21.36	21.25	21.15
20	50	24		21.37	21.16	21.22
20	50	50		21.26	21.08	21.19
20	100	0		21.29	21.17	21.21
20	1	0	64QAM	21.50	21.51	21.43
20	1	49		21.35	21.20	21.43
20	1	99		21.29	21.50	21.39
20	50	0		20.32	20.32	20.21
20	50	24		20.43	20.23	20.18
20	50	50		20.33	20.16	20.25
20	100	0		20.33	20.32	20.29
15	1	0	QPSK	23.04	23.02	22.93
15	1	37		22.92	22.75	22.73
15	1	74		22.91	22.75	22.72
15	36	0		22.24	22.15	22.17
15	36	20		22.27	22.13	22.10
15	36	39		22.19	22.01	22.02
15	75	0		22.14	22.12	22.03
15	1	0	16-QAM	22.62	22.62	22.16
15	1	37		22.53	22.37	22.13
15	1	74		22.43	22.37	22.17
15	36	0		21.11	21.01	21.05
15	36	20		21.15	20.93	21.00



15	36	39	64QAM	21.08	20.90	20.93
15	75	0		21.03	20.91	20.99
15	1	0		21.66	21.27	21.25
15	1	37		21.53	21.21	21.18
15	1	74		21.51	21.36	21.17
15	36	0		20.20	20.11	20.01
15	36	20		20.25	20.01	20.04
15	36	39		20.17	19.98	19.97
15	75	0		20.12	19.96	19.96



LTE Band 25 Maximum Average Power [dBm]						
BW [MHz]	RB Size	RB Offset	Mod	Lowest	Middle	Highest
10	1	0	QPSK	23.23	23.24	22.75
10	1	25		23.08	22.76	22.91
10	1	49		23.21	22.96	22.90
10	25	0		22.03	21.88	21.79
10	25	12		22.10	21.82	21.82
10	25	25		22.06	21.87	21.79
10	50	0		21.88	21.85	21.81
10	1	0	16-QAM	22.35	22.38	22.07
10	1	25		22.12	22.01	21.93
10	1	49		22.30	22.16	21.97
10	25	0		21.10	21.06	20.89
10	25	12		21.23	20.94	20.92
10	25	25		21.12	20.89	20.91
10	50	0		21.02	20.90	20.98
10	1	0	64QAM	21.44	21.47	21.14
10	1	25		21.32	21.11	21.01
10	1	49		21.37	21.25	21.09
10	25	0		20.21	20.05	19.93
10	25	12		20.29	20.06	19.97
10	25	25		20.18	19.94	19.85
10	50	0		20.05	19.96	19.88
5	1	0	QPSK	22.95	22.90	22.77
5	1	12		23.08	22.79	22.82
5	1	24		23.02	22.78	22.74
5	12	0		22.13	22.01	21.92
5	12	7		22.19	22.04	21.95
5	12	13		22.11	21.96	21.98
5	25	0		22.15	22.02	22.00
5	1	0	16-QAM	22.15	22.13	21.86
5	1	12		22.09	21.82	21.94
5	1	24		22.14	21.90	21.95
5	12	0		21.02	20.91	20.91
5	12	7		21.00	20.86	20.85



5	12	13	64QAM	21.03	20.89	20.88
5	25	0		21.06	20.94	20.92
5	1	0		21.19	21.19	21.00
5	1	12		21.22	21.07	21.07
5	1	24		21.18	21.05	21.09
5	12	0		20.22	20.20	20.20
5	12	7		20.29	20.15	20.14
5	12	13		20.31	20.17	20.09
5	25	0		20.31	20.09	20.16



LTE Band 25 Maximum Average Power [dBm]						
BW [MHz]	RB Size	RB Offset	Mod	Lowest	Middle	Highest
3	1	0	QPSK	22.77	22.82	22.67
3	1	8		22.74	22.66	22.76
3	1	14		22.86	22.73	22.69
3	8	0		22.16	22.01	22.00
3	8	4		22.15	22.00	22.02
3	8	7		22.16	22.00	22.05
3	15	0		22.15	22.01	21.96
3	1	0	16-QAM	22.13	22.10	22.29
3	1	8		22.14	22.35	22.42
3	1	14		22.17	22.02	22.36
3	8	0		21.09	20.94	20.91
3	8	4		21.08	20.95	21.07
3	8	7		21.10	20.96	20.96
3	15	0		21.03	20.80	20.90
3	1	0	64QAM	20.98	20.97	20.95
3	1	8		20.96	20.82	21.02
3	1	14		21.00	20.86	21.02
3	8	0		20.01	19.93	19.87
3	8	4		20.03	19.89	20.03
3	8	7		20.02	19.90	20.05
3	15	0		20.05	19.92	19.93
1.4	1	0	QPSK	22.80	22.65	22.77
1.4	1	3		22.83	22.77	22.81
1.4	1	5		22.76	22.62	22.65
1.4	3	0		22.88	22.75	22.69
1.4	3	1		22.91	22.77	22.78
1.4	3	3		22.87	22.74	22.68
1.4	6	0		22.03	21.91	21.99
1.4	1	0	16-QAM	22.16	21.95	22.01
1.4	1	3		22.22	22.10	22.18
1.4	1	5		22.06	21.94	22.04
1.4	3	0		22.03	21.92	21.93
1.4	3	1		22.07	21.96	21.95





1.4	3	3	64QAM	22.02	21.91	21.93
1.4	6	0		21.01	20.89	20.94
1.4	1	0		21.11	20.90	20.93
1.4	1	3		21.14	21.02	20.97
1.4	1	5		21.01	20.89	20.79
1.4	3	0		21.17	21.07	21.06
1.4	3	1		21.20	21.09	20.97
1.4	3	3		21.13	21.03	20.95
1.4	6	0		19.99	19.88	19.97



LTE Band 26 Maximum Average Power [dBm]						
BW [MHz]	RB Size	RB Offset	Mod	Lowest	Middle	Highest
15	1	0	QPSK	23.10	23.29	23.13
15	1	37		23.04	23.11	23.12
15	1	74		23.02	23.12	23.05
15	36	0		22.16	22.27	22.17
15	36	20		22.20	22.26	22.25
15	36	39		22.17	22.17	22.20
15	75	0		22.20	22.23	22.09
15	1	0	16-QAM	22.50	22.39	22.39
15	1	37		22.23	22.51	22.45
15	1	74		22.09	22.53	22.40
15	36	0		21.20	21.29	21.22
15	36	20		21.35	21.33	21.32
15	36	39		21.25	21.33	21.24
15	75	0		21.25	21.28	21.21
15	1	0	64QAM	21.38	21.52	21.49
15	1	37		21.12	21.46	21.51
15	1	74		21.54	21.51	21.33
15	36	0		20.38	20.41	20.44
15	36	20		20.43	20.45	20.42
15	36	39		20.36	20.38	20.35
15	75	0		20.41	20.44	20.40



LTE Band 26 Maximum Average Power [dBm]						
BW [MHz]	RB Size	RB Offset	Mod	Lowest	Middle	Highest
10	1	0	QPSK	23.10	23.05	23.13
10	1	25		23.06	23.09	23.08
10	1	49		23.15	23.17	23.00
10	25	0		22.10	22.18	22.15
10	25	12		22.14	22.24	22.15
10	25	25		22.21	22.13	22.07
10	50	0		22.25	22.20	22.14
10	1	0	16-QAM	22.29	22.20	22.12
10	1	25		22.24	22.12	22.15
10	1	49		22.31	22.48	22.15
10	25	0		21.15	21.27	21.26
10	25	12		21.26	21.32	21.31
10	25	25		21.22	21.32	21.30
10	50	0		21.32	21.27	21.29
10	1	0	64QAM	21.60	21.65	21.51
10	1	25		21.18	21.53	21.46
10	1	49		21.49	21.21	21.31
10	25	0		20.30	20.36	20.43
10	25	12		20.38	20.52	20.43
10	25	25		20.42	20.44	20.34
10	50	0		20.43	20.43	20.40
5	1	0	QPSK	23.21	23.20	23.12
5	1	12		23.03	23.06	23.08
5	1	24		23.10	23.11	22.99
5	12	0		22.07	22.12	22.11
5	12	7		22.15	22.27	22.17
5	12	13		22.08	22.15	22.12
5	25	0		22.02	22.18	22.02
5	1	0	16-QAM	22.27	22.15	22.40
5	1	12		22.23	22.32	22.57
5	1	24		22.14	22.50	22.30
5	12	0		21.18	21.29	21.26
5	12	7		21.18	21.31	21.35



5	12	13	64QAM	21.17	21.26	21.19
5	25	0		21.16	21.25	21.20
5	1	0		21.47	21.68	21.27
5	1	12		21.38	21.19	21.67
5	1	24		21.67	21.49	21.38
5	12	0		20.36	20.41	20.40
5	12	7		20.46	20.54	20.46
5	12	13		20.16	20.41	20.29
5	25	0		20.33	20.37	20.25



LTE Band 26 Maximum Average Power [dBm]						
BW [MHz]	RB Size	RB Offset	Mod	Lowest	Middle	Highest
3	1	0	QPSK	23.03	23.10	22.91
3	1	8		23.02	23.10	23.07
3	1	14		22.97	23.09	22.93
3	8	0		22.41	22.40	22.27
3	8	4		22.39	22.49	22.38
3	8	7		22.34	22.37	22.21
3	15	0		22.35	22.46	22.27
3	1	0	16-QAM	22.33	22.38	22.25
3	1	8		22.35	22.38	22.32
3	1	14		22.34	22.35	22.25
3	8	0		21.29	21.36	21.23
3	8	4		21.28	21.36	21.34
3	8	7		21.22	21.34	21.26
3	15	0		21.30	21.30	21.09
3	1	0	64QAM	21.44	21.44	21.41
3	1	8		21.33	21.42	21.44
3	1	14		21.34	21.51	21.31
3	8	0		20.45	20.52	20.37
3	8	4		20.43	20.51	20.37
3	8	7		20.38	20.50	20.33
3	15	0		20.30	20.40	20.29
1.4	1	0	QPSK	23.15	23.09	22.99
1.4	1	3		23.18	23.05	23.09
1.4	1	5		23.15	23.04	22.98
1.4	3	0		23.07	23.15	22.94
1.4	3	1		23.17	23.18	23.08
1.4	3	3		23.11	23.14	23.06
1.4	6	0		22.26	22.37	22.26
1.4	1	0	16-QAM	22.51	22.50	22.39
1.4	1	3		22.54	22.58	22.50
1.4	1	5		22.42	22.52	22.44
1.4	3	0		22.21	22.18	22.13
1.4	3	1		22.18	22.22	22.09



1.4	3	3	64QAM	22.15	22.15	22.05
1.4	6	0		21.39	21.39	21.32
1.4	1	0		21.43	21.39	21.37
1.4	1	3		21.16	21.58	21.48
1.4	1	5		21.38	21.48	21.28
1.4	3	0		21.53	21.50	21.45
1.4	3	1		21.59	21.64	21.51
1.4	3	3		21.46	21.57	21.46
1.4	6	0		20.31	20.39	20.32



**CA Power**

CA_5B								
Combination 10MHz+10MHz (50RB+50RB)								
PCC Channel	SCC Channel	Modulation	PCC		SCC		Total RB Size	Measured Power (dBm)
			RB Size	RB offset	RB Size	RB offset		
20450	20549	QPSK	0	0	1	49	1	23.14
			1	0	0	0	1	23.19
			50	0	0	0	50	22.27
			50	0	50	0	100	21.26
			1	0	1	49	2	12.8
			1	0	1	0	2	12.81
			1	49	1	0	2	23.24
			50	0	1	49	51	18.82
		16QAM	0	0	1	49	1	23.14
			1	0	0	0	1	22.87
			50	0	0	0	50	21.25
			50	0	50	0	100	20.32
			1	0	1	49	2	13.11
			1	0	1	0	2	13.22
			1	49	1	0	2	22.71
			50	0	1	49	51	18.89
		64QAM	0	0	1	49	1	23.11
			1	0	0	0	1	22.54
			50	0	0	0	50	21.27
			50	0	50	0	100	20.33
			1	0	1	49	2	13.01
			1	0	1	0	2	13.01
			1	49	1	0	2	22.58
			50	0	1	49	51	18.87



20476	20575	QPSK	0	0	1	49	1	23.15
			1	0	0	0	1	23.23
			50	0	0	0	50	22.26
			50	0	50	0	100	21.23
			1	0	1	49	2	12.76
			1	0	1	0	2	12.83
			1	49	1	0	2	23.17
			50	0	1	49	51	18.79
		16QAM	0	0	1	49	1	23.14
			1	0	0	0	1	22.74
			50	0	0	0	50	21.28
			50	0	50	0	100	20.32
			1	0	1	49	2	13.15
			1	0	1	0	2	13.31
			1	49	1	0	2	22.63
			50	0	1	49	51	18.88
		64QAM	0	0	1	49	1	23.45
			1	0	0	0	1	22.55
			50	0	0	0	50	21.25
			50	0	50	0	100	20.3
			1	0	1	49	2	12.94
			1	0	1	0	2	13.03
			1	49	1	0	2	22.44
			50	0	1	49	51	18.82





20501	20600	QPSK	0	0	1	49	1	23.17
			1	0	0	0	1	23.14
			50	0	0	0	50	22.23
			50	0	50	0	100	21.24
			1	0	1	49	2	12.72
			1	0	1	0	2	12.82
			1	49	1	0	2	23.23
			50	0	1	49	51	18.74
		16QAM	0	0	1	49	1	23.2
			1	0	0	0	1	22.68
			50	0	0	0	50	21.23
			50	0	50	0	100	20.3
			1	0	1	49	2	13.02
			1	0	1	0	2	13.29
			1	49	1	0	2	22.82
			50	0	1	49	51	18.83
		64QAM	0	0	1	49	1	23.1
			1	0	0	0	1	22.42
			50	0	0	0	50	21.16
			50	0	50	0	100	20.29
			1	0	1	49	2	12.88
			1	0	1	0	2	12.97
			1	49	1	0	2	22.55
			50	0	1	49	51	18.83



CA_5B								
Combination 10MHz+5MHz (50RB+25RB)								
PCC Channel	SCC Channel	Modulation	PCC		SCC		Total RB Size	Measured Power (dBm)
			RB Size	RB offset	RB Size	RB offset		
20450	20522	QPSK	50	0	25	0	75	21.14
		QPSK	1	0	1	24	2	12.69
		QPSK	1	49	1	0	2	23.25
		16QAM	50	0	25	0	75	20.12
		16QAM	1	0	1	24	2	13.2
		16QAM	1	49	1	0	2	22.57
		64QAM	50	0	25	0	75	20.61
		64QAM	1	0	1	24	2	12.91
		64QAM	1	49	1	0	2	20.89
20500	20572	QPSK	50	0	25	0	75	21.11
		QPSK	1	0	1	24	2	12.59
		QPSK	1	49	1	0	2	23.15
		16QAM	50	0	25	0	75	20.07
		16QAM	1	0	1	24	2	13.12
		16QAM	1	49	1	0	2	22.54
		64QAM	50	0	25	0	75	20.56
		64QAM	1	0	1	24	2	12.92
		64QAM	1	49	1	0	2	20.92
20550	20622	QPSK	50	0	25	0	75	21.03
		QPSK	1	0	1	24	2	12.61
		QPSK	1	49	1	0	2	23.14
		16QAM	50	0	25	0	75	20.02
		16QAM	1	0	1	24	2	13.07
		16QAM	1	49	1	0	2	21.51
		64QAM	50	0	25	0	75	20.5
		64QAM	1	0	1	24	2	12.93
		64QAM	1	49	1	0	2	20.61



Combination 5MHz+10MHz (25RB+50RB)								
PCC Channel	SCC Channel	Modulation	PCC		SCC		Total RB Size	Measured Power (dBm)
			RB Size	RB offset	RB Size	RB offset		
20428	20500	QPSK	25	0	50	0	75	21.17
		QPSK	1	0	1	49	2	12.7
		QPSK	1	24	1	0	2	23.14
		16QAM	25	0	50	0	75	20.09
		16QAM	1	0	1	49	2	13.09
		16QAM	1	24	1	0	2	22.72
		64QAM	25	0	50	0	75	20.61
		64QAM	1	0	1	49	2	13.01
		64QAM	1	24	1	0	2	20.8
20478	20550	QPSK	25	0	50	0	75	21.12
		QPSK	1	0	1	49	2	12.61
		QPSK	1	24	1	0	2	20.55
		16QAM	25	0	50	0	75	20.13
		16QAM	1	0	1	49	2	13.02
		16QAM	1	24	1	0	2	20.77
		64QAM	25	0	50	0	75	20.6
		64QAM	1	0	1	49	2	12.9
		64QAM	1	24	1	0	2	20.78
20528	20600	QPSK	25	0	50	0	75	21.06
		QPSK	1	0	1	49	2	12.64
		QPSK	1	24	1	0	2	23.34
		16QAM	25	0	50	0	75	20.05
		16QAM	1	0	1	49	2	13.15
		16QAM	1	24	1	0	2	22.7
		64QAM	25	0	50	0	75	20.57
		64QAM	1	0	1	49	2	12.98
		64QAM	1	24	1	0	2	20.79



**ERP/EIRP**

LTE Band 12 (GT - LC = -3.00 dB) QPSK									
Bandwidth	1.4M			3M			5M		
Channel	23017	23095	23173	23025	23095	23165	23035	23095	23155
	(Low)	(Mid)	(High)	(Low)	(Mid)	(High)	(Low)	(Mid)	(High)
Frequency (MHz)	699.7	707.5	715.3	700.5	707.5	714.5	701.5	707.5	713.5
Conducted Power (dBm)	23.05	23.03	22.89	22.80	22.94	22.81	22.83	23.08	22.89
Conducted Power (Watts)	0.2018	0.2009	0.1945	0.1905	0.1968	0.1910	0.1919	0.2032	0.1945
ERP(dBm)	17.90	17.88	17.74	17.65	17.79	17.66	17.68	17.93	17.74
ERP(Watts)	0.0617	0.0614	0.0594	0.0582	0.0601	0.0583	0.0586	0.0621	0.0594

LTE Band 12 (GT - LC = -3.00 dB) QPSK			
Bandwidth	10M		
Channel	23060	23095	23130
	(Low)	(Mid)	(High)
Frequency (MHz)	704	707.5	711
Conducted Power (dBm)	22.89	23.09	22.83
Conducted Power (Watts)	0.1945	0.2037	0.1919
ERP(dBm)	17.74	17.94	17.68
ERP(Watts)	0.0594	0.0622	0.0586



LTE Band 12 (GT - LC = -3.00 dB) 16QAM									
Bandwidth	1.4M			3M			5M		
Channel	23017	23095	23173	23025	23095	23165	23035	23095	23155
	(Low)	(Mid)	(High)	(Low)	(Mid)	(High)	(Low)	(Mid)	(High)
Frequency (MHz)	699.7	707.5	715.3	700.5	707.5	714.5	701.5	707.5	713.5
Conducted Power (dBm)	22.13	22.09	22.42	22.18	22.36	22.32	22.02	22.01	22.07
Conducted Power (Watts)	0.1633	0.1618	0.1746	0.1652	0.1722	0.1706	0.1592	0.1589	0.1611
ERP(dBm)	16.98	16.94	17.27	17.03	17.21	17.17	16.87	16.86	16.92
ERP(Watts)	0.0499	0.0494	0.0533	0.0505	0.0526	0.0521	0.0486	0.0485	0.0492

LTE Band 12 (GT - LC = -3.00 dB) 16QAM			
Bandwidth	10M		
Channel	23060	23095	23130
	(Low)	(Mid)	(High)
Frequency (MHz)	704	707.5	711
Conducted Power (dBm)	22.45	22.40	22.29
Conducted Power (Watts)	0.1758	0.1738	0.1694
ERP(dBm)	17.30	17.25	17.14
ERP(Watts)	0.0537	0.0531	0.0518



LTE Band 12 (GT - LC = -3.00 dB) 64QAM									
Bandwidth	1.4M			3M			5M		
Channel	23017	23095	23173	23025	23095	23165	23035	23095	23155
	(Low)	(Mid)	(High)	(Low)	(Mid)	(High)	(Low)	(Mid)	(High)
Frequency (MHz)	699.7	707.5	715.3	700.5	707.5	714.5	701.5	707.5	713.5
Conducted Power (dBm)	20.81	21.10	20.94	21.23	21.30	21.17	20.99	21.06	21.06
Conducted Power (Watts)	0.1205	0.1288	0.1242	0.1327	0.1349	0.1309	0.1256	0.1276	0.1276
ERP(dBm)	15.66	15.95	15.79	16.08	16.15	16.02	15.84	15.91	15.91
ERP(Watts)	0.0368	0.0394	0.0379	0.0406	0.0412	0.0400	0.0384	0.0390	0.0390

LTE Band 12 (GT - LC = -3.00 dB) 64QAM			
Bandwidth	10M		
Channel	23060	23095	23130
	(Low)	(Mid)	(High)
Frequency (MHz)	704	707.5	711
Conducted Power (dBm)	21.24	21.35	21.32
Conducted Power (Watts)	0.1330	0.1365	0.1355
ERP(dBm)	16.09	16.20	16.17
ERP(Watts)	0.0406	0.0417	0.0414



LTE Band 13 (GT - LC = -3.00 dB) QPSK						
Bandwidth	5M			10M		
Channel	23205	23230	23255	23230		
	(Low)	(Mid)	(High)	-	(Mid)	-
Frequency	779.5	782	784.5	-	782	-
(MHz)						
Conducted Power (dBm)	22.90	22.80	22.61	-	22.91	-
Conducted Power (Watts)	0.1950	0.1905	0.1824	-	0.1954	-
ERP(dBm)	17.75	17.65	17.46	-	17.76	-
ERP(Watts)	0.0596	0.0582	0.0557	-	0.0597	-

LTE Band 13 (GT - LC = -3.00 dB) 16QAM						
Bandwidth	5M			10M		
Channel	23205	23230	23255	23230		
	(Low)	(Mid)	(High)	-	(Mid)	-
Frequency	779.5	782	784.5	-	782	-
(MHz)						
Conducted Power (dBm)	21.93	22.03	22.07	-	21.87	-
Conducted Power (Watts)	0.1560	0.1596	0.1611	-	0.1538	-
ERP(dBm)	16.78	16.88	16.92	-	16.72	-
ERP(Watts)	0.0476	0.0488	0.0492	-	0.0470	-

LTE Band 13 (GT - LC = -3.00 dB) 64QAM						
Bandwidth	5M			10M		
Channel	23205	23230	23255	23230		
	(Low)	(Mid)	(High)	-	(Mid)	-
Frequency	779.5	782	784.5	-	782	-
(MHz)						
Conducted Power (dBm)	21.42	21.35	21.05	-	21.46	-
Conducted Power (Watts)	0.1387	0.1365	0.1274	-	0.1400	-
ERP(dBm)	16.27	16.20	15.90	-	16.31	-
ERP(Watts)	0.0424	0.0417	0.0389	-	0.0428	-



LTE Band 25 (GT - LC = -1.00 dB) QPSK									
Bandwidth	1.4M			3M			5M		
Channel	26407	26340	26683	26055	26340	26675	26065	26340	26665
	(Low)	(Mid)	(High)	(Low)	(Mid)	(High)	(Low)	(Mid)	(High)
Frequency (MHz)	1850.7	1880	1914.3	1851.5	1880	1913.5	1852.5	1880	1912.5
Conducted Power (dBm)	22.91	22.77	22.78	22.86	22.73	22.69	23.08	22.79	22.82
Conducted Power (Watts)	0.1954	0.1892	0.1897	0.1932	0.1875	0.1858	0.2032	0.1901	0.1914
EIRP(dBm)	21.91	21.77	21.78	21.86	21.73	21.69	22.08	21.79	21.82
EIRP(Watts)	0.1552	0.1503	0.1507	0.1535	0.1489	0.1476	0.1614	0.1510	0.1521

LTE Band 25 (GT - LC = -1.00 dB) QPSK									
Bandwidth	10M			15M			20M		
Channel	26090	26340	26640	26115	26340	26615	26140	26340	26590
	(Low)	(Mid)	(High)	(Low)	(Mid)	(High)	(Low)	(Mid)	(High)
Frequency (MHz)	1855	1880	1910	1857.5	1880	1907.5	1860	1880	1905
Conducted Power (dBm)	23.23	23.24	22.75	23.04	23.02	22.93	23.25	23.35	22.92
Conducted Power (Watts)	0.2104	0.2109	0.1884	0.2014	0.2004	0.1963	0.2113	0.2163	0.1959
EIRP(dBm)	22.23	22.24	21.75	22.04	22.02	21.93	22.25	22.35	21.92
EIRP(Watts)	0.1671	0.1675	0.1496	0.1600	0.1592	0.1560	0.1679	0.1718	0.1556





LTE Band 25 (GT - LC = -1.00 dB) 16QAM									
Bandwidth	1.4M			3M			5M		
Channel	26407	26340	26683	26055	26340	26675	26065	26340	26665
	(Low)	(Mid)	(High)	(Low)	(Mid)	(High)	(Low)	(Mid)	(High)
Frequency (MHz)	1850.7	1880	1914.3	1851.5	1880	1913.5	1852.5	1880	1912.5
Conducted Power (dBm)	22.22	22.10	22.18	22.14	22.35	22.42	22.15	22.13	21.86
Conducted Power (Watts)	0.1667	0.1622	0.1652	0.1637	0.1718	0.1746	0.1641	0.1633	0.1535
EIRP(dBm)	21.22	21.10	21.18	21.14	21.35	21.42	21.15	21.13	20.86
EIRP(Watts)	0.1324	0.1288	0.1312	0.1300	0.1365	0.1387	0.1303	0.1297	0.1219

LTE Band 25 (GT - LC = -1.00 dB) 16QAM									
Bandwidth	10M			15M			20M		
Channel	26090	26340	26640	26115	26340	26615	26140	26340	26590
	(Low)	(Mid)	(High)	(Low)	(Mid)	(High)	(Low)	(Mid)	(High)
Frequency (MHz)	1855	1880	1910	1857.5	1880	1907.5	1860	1880	1905
Conducted Power (dBm)	22.35	22.38	22.07	22.62	22.62	22.16	22.62	22.62	22.37
Conducted Power (Watts)	0.1718	0.1730	0.1611	0.1828	0.1828	0.1644	0.1828	0.1828	0.1726
EIRP(dBm)	21.35	21.38	21.07	21.62	21.62	21.16	21.62	21.62	21.37
EIRP(Watts)	0.1365	0.1374	0.1279	0.1452	0.1452	0.1306	0.1452	0.1452	0.1371



LTE Band 25 (GT - LC = -1.00 dB) 64QAM									
Bandwidth	1.4M			3M			5M		
Channel	26407	26340	26683	26055	26340	26675	26065	26340	26665
	(Low)	(Mid)	(High)	(Low)	(Mid)	(High)	(Low)	(Mid)	(High)
Frequency (MHz)	1850.7	1880	1914.3	1851.5	1880	1913.5	1852.5	1880	1912.5
Conducted Power (dBm)	21.20	21.09	20.97	20.96	20.82	21.02	21.22	21.07	21.07
Conducted Power (Watts)	0.1318	0.1285	0.1250	0.1247	0.1208	0.1265	0.1324	0.1279	0.1279
EIRP(dBm)	20.20	20.09	19.97	19.96	19.82	20.02	20.22	20.07	20.07
EIRP(Watts)	0.1047	0.1021	0.0993	0.0991	0.0959	0.1005	0.1052	0.1016	0.1016

LTE Band 25 (GT - LC = -1.00 dB) 64QAM									
Bandwidth	10M			15M			20M		
Channel	26090	26340	26640	26115	26340	26615	26140	26340	26590
	(Low)	(Mid)	(High)	(Low)	(Mid)	(High)	(Low)	(Mid)	(High)
Frequency (MHz)	1855	1880	1910	1857.5	1880	1907.5	1860	1880	1905
Conducted Power (dBm)	21.44	21.47	21.14	21.66	21.27	21.25	21.50	21.51	21.43
Conducted Power (Watts)	0.1393	0.1403	0.1300	0.1466	0.1340	0.1334	0.1413	0.1416	0.1390
EIRP(dBm)	20.44	20.47	20.14	20.66	20.27	20.25	20.50	20.51	20.43
EIRP(Watts)	0.1107	0.1114	0.1033	0.1164	0.1064	0.1059	0.1122	0.1125	0.1104



LTE Band 26 (GT - LC = -3.00 dB) QPSK									
Bandwidth	1.4M			3M			5M		
Channel	26797	26915	27033	26805	26915	27025	26815	26915	27015
	(Low)	(Mid)	(High)	(Low)	(Mid)	(High)	(Low)	(Mid)	(High)
Frequency	824.7	836.5	848.3	825.5	836.5	847.5	826.5	836.5	846.5
(MHz)									
Conducted Power (dBm)	23.18	23.05	23.09	23.02	23.10	23.07	23.21	23.20	23.12
Conducted Power (Watts)	0.2080	0.2018	0.2037	0.2004	0.2042	0.2028	0.2094	0.2089	0.2051
ERP(dBm)	18.03	17.90	17.94	17.87	17.95	17.92	18.06	18.05	17.97
ERP(Watts)	0.0635	0.0617	0.0622	0.0612	0.0624	0.0619	0.0640	0.0638	0.0627

LTE Band 26 (GT - LC = -3.00 dB) QPSK							
Bandwidth	10M			15M			15M
Channel	26840	26915	26990	26865	26915	26965	26765
	(Low)	(Mid)	(High)	(Low)	(Mid)	(High)	(Low)
Frequency	829	836.5	844	831.5	836.5	841.5	821.5
(MHz)							
Conducted Power (dBm)	23.15	23.17	23.00	23.10	23.29	23.13	23.10
Conducted Power (Watts)	0.2065	0.2075	0.1995	0.2042	0.2133	0.2056	0.2042
ERP(dBm)	18.00	18.02	17.85	17.95	18.14	17.98	17.95
ERP(Watts)	0.0631	0.0634	0.0610	0.0624	0.0652	0.0628	0.0624



LTE Band 26 (GT - LC = -3.00 dB) 16QAM									
Bandwidth	1.4M			3M			5M		
Channel	26797	26915	27033	26805	26915	27025	26815	26915	27015
	(Low)	(Mid)	(High)	(Low)	(Mid)	(High)	(Low)	(Mid)	(High)
Frequency	824.7	836.5	848.3	825.5	836.5	847.5	826.5	836.5	846.5
(MHz)									
Conducted Power (dBm)	22.54	22.58	22.50	22.35	22.38	22.32	22.23	22.32	22.57
Conducted Power (Watts)	0.1795	0.1811	0.1778	0.1718	0.1730	0.1706	0.1671	0.1706	0.1807
ERP(dBm)	17.39	17.43	17.35	17.20	17.23	17.17	17.08	17.17	17.42
ERP(Watts)	0.0548	0.0553	0.0543	0.0525	0.0528	0.0521	0.0511	0.0521	0.0552

LTE Band 26 (GT - LC = -3.00 dB) 16QAM							
Bandwidth	10M			15M			15M
Channel	26840	26915	26990	26865	26915	26965	26765
	(Low)	(Mid)	(High)	(Low)	(Mid)	(High)	(Low)
Frequency	829	836.5	844	831.5	836.5	841.5	821.5
(MHz)							
Conducted Power (dBm)	22.31	22.48	22.15	22.09	22.53	22.40	22.50
Conducted Power (Watts)	0.1702	0.1770	0.1641	0.1618	0.1791	0.1738	0.1778
ERP(dBm)	17.16	17.33	17.00	16.94	17.38	17.25	17.35
ERP(Watts)	0.0520	0.0541	0.0501	0.0494	0.0547	0.0531	0.0543



LTE Band 26 (GT - LC = -3.00 dB) 64QAM									
Bandwidth	1.4M			3M			5M		
Channel	26797	26915	27033	26805	26915	27025	26815	26915	27015
	(Low)	(Mid)	(High)	(Low)	(Mid)	(High)	(Low)	(Mid)	(High)
Frequency	824.7	836.5	848.3	825.5	836.5	847.5	826.5	836.5	846.5
(MHz)									
Conducted Power (dBm)	21.59	21.64	21.51	21.34	21.51	21.31	21.47	21.68	21.27
Conducted Power (Watts)	0.1442	0.1459	0.1416	0.1361	0.1416	0.1352	0.1403	0.1472	0.1340
ERP(dBm)	16.44	16.49	16.36	16.19	16.36	16.16	16.32	16.53	16.12
ERP(Watts)	0.0441	0.0446	0.0433	0.0416	0.0433	0.0413	0.0429	0.0450	0.0409

LTE Band 26 (GT - LC = -3.00 dB) 64QAM							
Bandwidth	10M			15M			15M
Channel	26840	26915	26990	26865	26915	26965	26765
	(Low)	(Mid)	(High)	(Low)	(Mid)	(High)	(Low)
Frequency	829	836.5	844	831.5	836.5	841.5	821.5
(MHz)							
Conducted Power (dBm)	21.60	21.65	21.51	21.54	21.51	21.33	21.54
Conducted Power (Watts)	0.1445	0.1462	0.1416	0.1426	0.1416	0.1358	0.1426
ERP(dBm)	16.45	16.50	16.36	16.39	16.36	16.18	16.39
ERP(Watts)	0.0442	0.0447	0.0433	0.0436	0.0433	0.0415	0.0436



**CA ERP**

LTE Band 5B_CA (GT - LC = -3.00 dB) QPSK									
Bandwidth	10M + 10M			5M + 10M			10M+5M		
Channel PCC	20450	20476	20501	20428	20478	20528	20450	20500	20550
	(Low)	(Mid)	(High)	(Low)	(Mid)	(High)	(Low)	(Mid)	(High)
Channel SCC	20549	20575	20600	20500	20550	20600	20522	20572	20622
	(Low)	(Mid)	(High)	(Low)	(Mid)	(High)	(Low)	(Mid)	(High)
Conducted Power (dBm)	23.24	23.23	23.23	23.14	21.12	23.34	23.25	23.15	23.14
Conducted Power (Watts)	0.2109	0.2104	0.2104	0.2061	0.1294	0.2158	0.2113	0.2065	0.2061
ERP(dBm)	18.09	18.08	18.08	17.99	15.97	18.19	18.10	18.00	17.99
ERP(Watts)	0.0644	0.0643	0.0643	0.0630	0.0395	0.0659	0.0646	0.0631	0.0630

LTE Band 5B_CA (GT - LC = -3.00 dB) 16QAM									
Bandwidth	10M + 10M			5M + 10M			10M+5M		
Channel PCC	20450	20476	20501	20428	20478	20528	20450	20500	20550
	(Low)	(Mid)	(High)	(Low)	(Mid)	(High)	(Low)	(Mid)	(High)
Channel SCC	20549	20575	20600	20500	20550	20600	20522	20572	20622
	(Low)	(Mid)	(High)	(Low)	(Mid)	(High)	(Low)	(Mid)	(High)
Conducted Power (dBm)	23.14	23.14	23.2	22.72	20.77	22.7	22.57	22.54	21.51
Conducted Power (Watts)	0.2061	0.2061	0.2089	0.1871	0.1194	0.1862	0.1807	0.1795	0.1416
ERP(dBm)	17.99	17.99	18.05	17.57	15.62	17.55	17.42	17.39	16.36
ERP(Watts)	0.0630	0.0630	0.0638	0.0571	0.0365	0.0569	0.0552	0.0548	0.0433



LTE Band 5B_CA (GT - LC = -3.00 dB) 64QAM									
Bandwidth	10M + 10M			5M + 10M			10M+5M		
Channel PCC	20450	20476	20501	20428	20478	20528	20450	20500	20550
	(Low)	(Mid)	(High)	(Low)	(Mid)	(High)	(Low)	(Mid)	(High)
Channel SCC	20549	20575	20600	20500	20550	20600	20522	20572	20622
	(Low)	(Mid)	(High)	(Low)	(Mid)	(High)	(Low)	(Mid)	(High)
Conducted Power (dBm)	23.11	23.45	23.1	20.80	20.78	20.79	20.89	20.92	20.61
Conducted Power (Watts)	0.2046	0.2213	0.2042	0.1202	0.1197	0.1199	0.1227	0.1236	0.1151
ERP(dBm)	17.96	18.30	17.95	15.65	15.63	15.64	15.74	15.77	15.46
ERP(Watts)	0.0625	0.0676	0.0624	0.0367	0.0366	0.0366	0.0375	0.0378	0.0352



# LTE Band 12

## Peak-to-Average Ratio

Mode	LTE Band 12 / 10MHz				
Mod.	QPSK		16QAM		Limit: 13dB
RB Size	1RB	Full RB	1RB	Full RB	Result
Lowest CH	3.45	4.58	4.90	5.86	<b>PASS</b>
Middle CH	3.51	4.52	5.30	5.80	
Highest CH	3.51	4.46	5.30	5.65	
Mod.	64QAM		Limit: 13dB		
RB Size	1RB	Full RB	Result		
Lowest CH	6.46	6.38	<b>PASS</b>		
Middle CH	5.97	6.38			
Highest CH	6.46	6.20			





LTE Band 12 / 10MHz / QPSK

Lowest Channel / 1RB

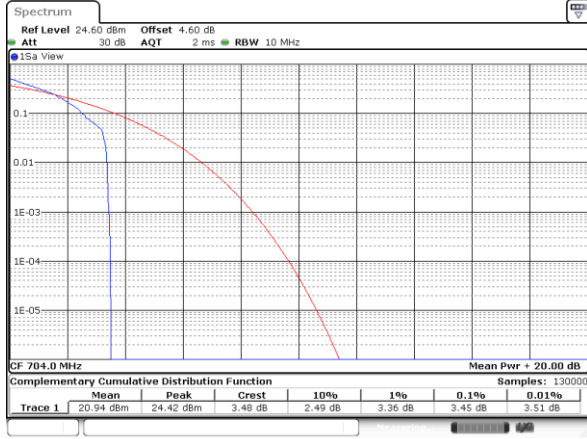

Lowest Channel / Full RB

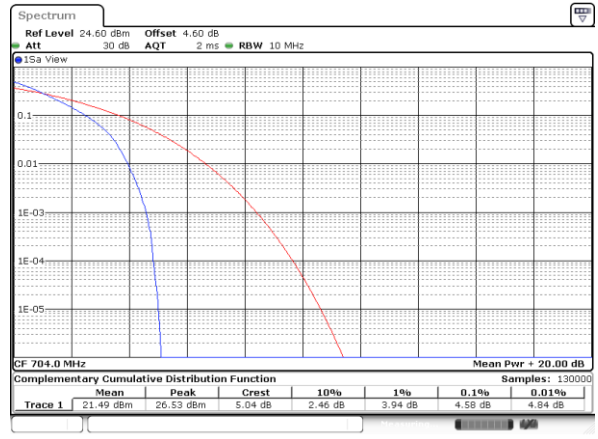

Middle Channel / 1RB

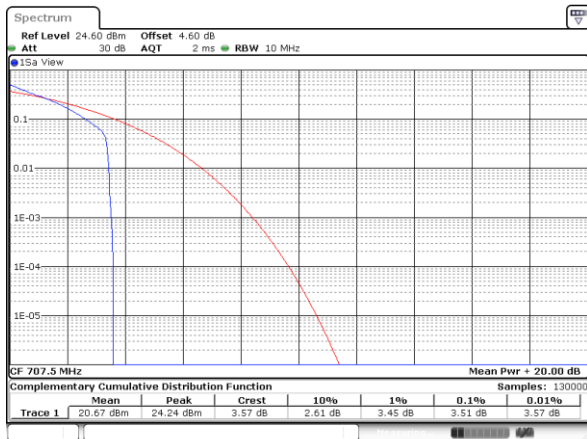

Middle Channel / Full RB

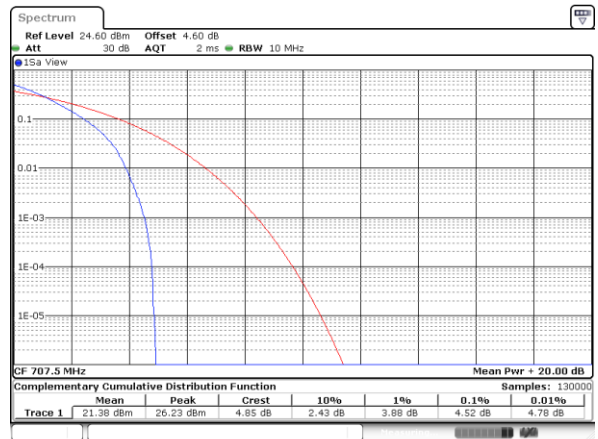

Highest Channel / 1RB

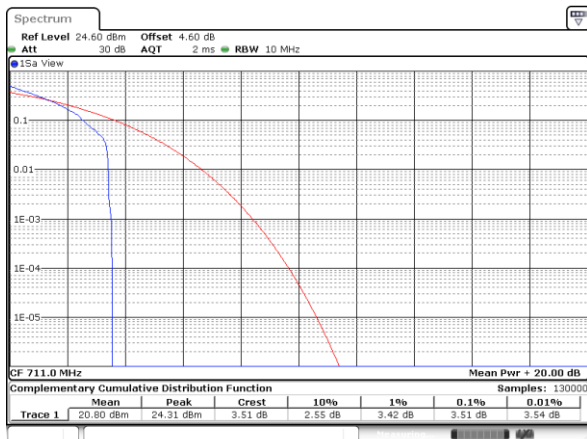

Highest Channel / Full RB

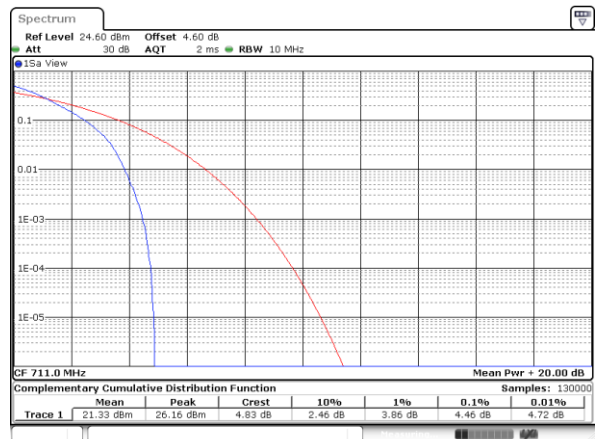



LTE Band 12 / 10MHz / 16QAM

Lowest Channel / 1RB

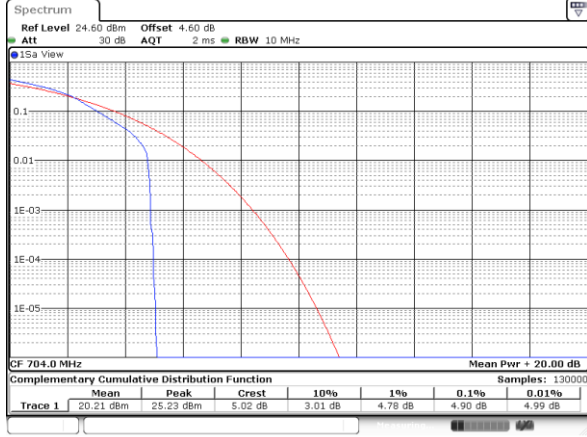

Lowest Channel / Full RB

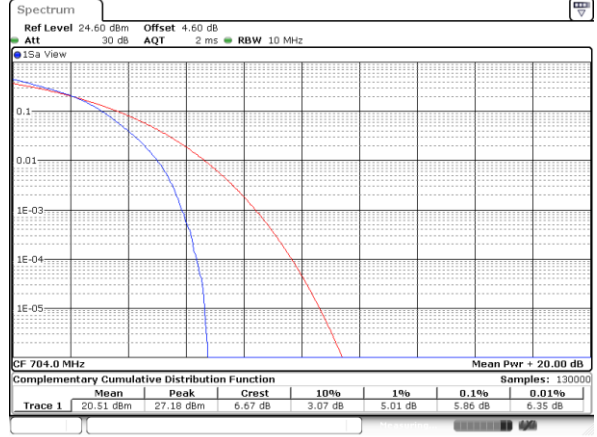

Middle Channel / 1RB

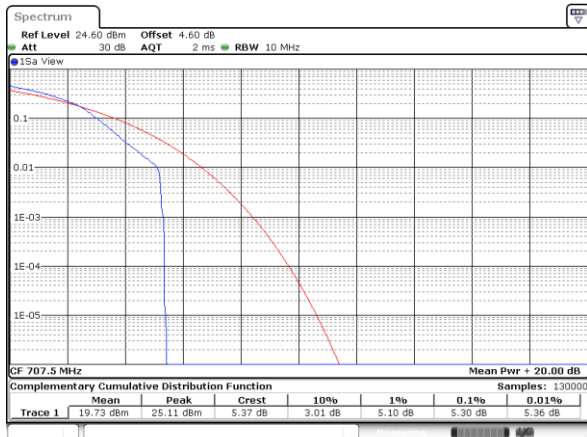

Middle Channel / Full RB

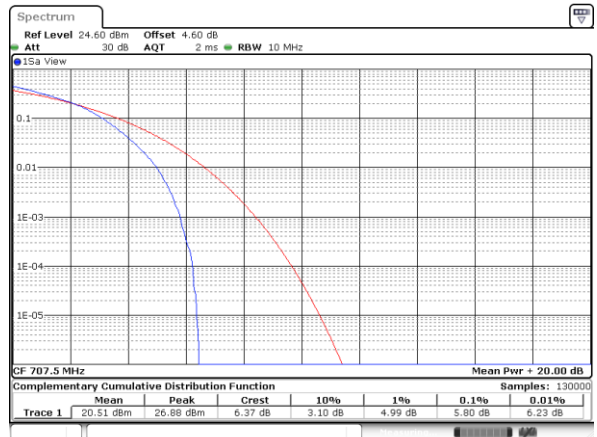

Highest Channel / 1RB

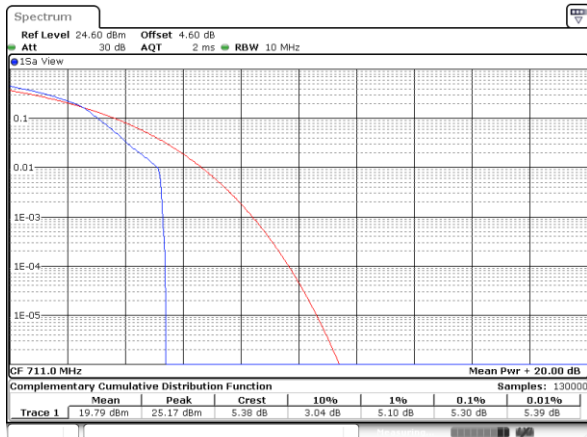

Highest Channel / Full RB

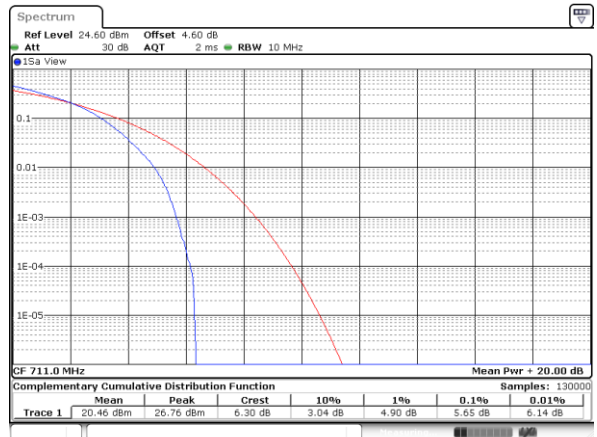



LTE Band 12 / 10MHz / 64QAM

Lowest Channel / 1RB

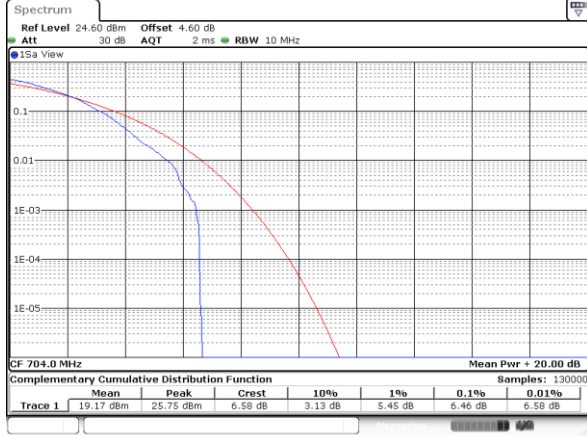

Lowest Channel / Full RB

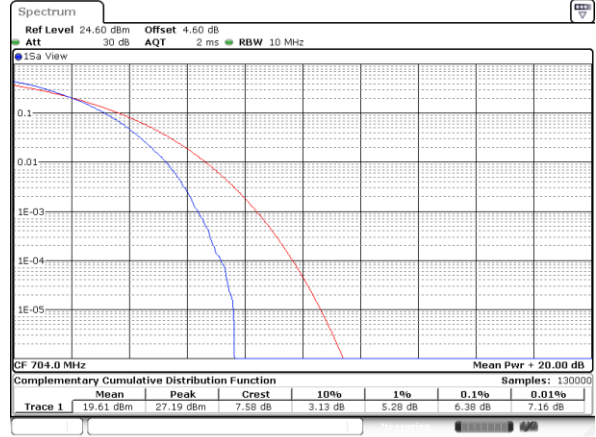

Middle Channel / 1RB

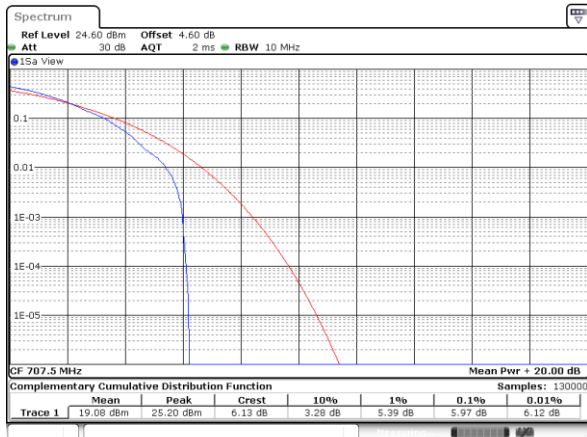

Middle Channel / Full RB

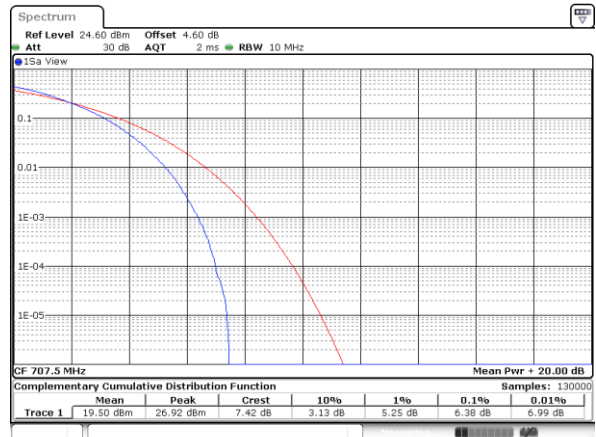

Highest Channel / 1RB

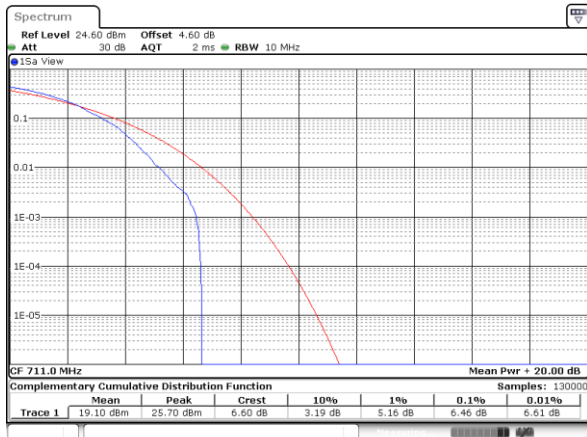

Highest Channel / Full RB

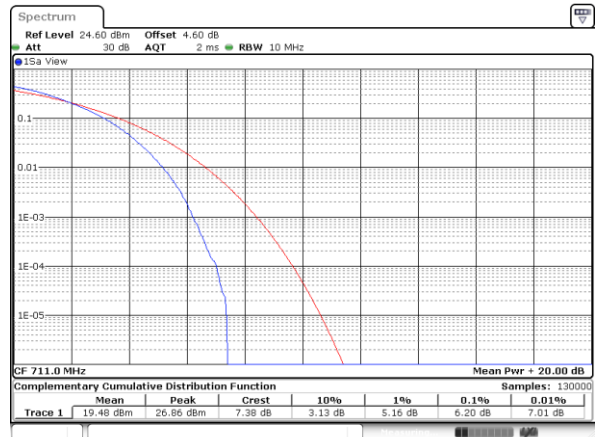



**26dB Bandwidth**

Mode	LTE Band 12 : 26dB BW(MHz)											
	1.4MHz		3MHz		5MHz		10MHz		1.4MHz	3MHz	5MHz	10MHz
BW	QPSK	16QAM	QPSK	16QAM	QPSK	16QAM	QPSK	16QAM	64QAM	64QAM	64QAM	64QAM
Mod.	QPSK	16QAM	QPSK	16QAM	QPSK	16QAM	QPSK	16QAM	64QAM	64QAM	64QAM	64QAM
Lowest CH	1.2168	1.242	3.021	2.9431	4.765	4.925	9.81	9.75	1.2168	3.033	4.975	9.85
Middle CH	1.2168	1.228	3.033	3.0629	4.865	4.935	9.77	9.71	1.228	2.985	4.945	9.83
Highest CH	1.2308	1.2308	2.979	3.009	4.975	4.875	9.73	9.71	1.2112	2.997	4.875	9.83



LTE Band 12

Lowest Channel / 1.4MHz / QPSK

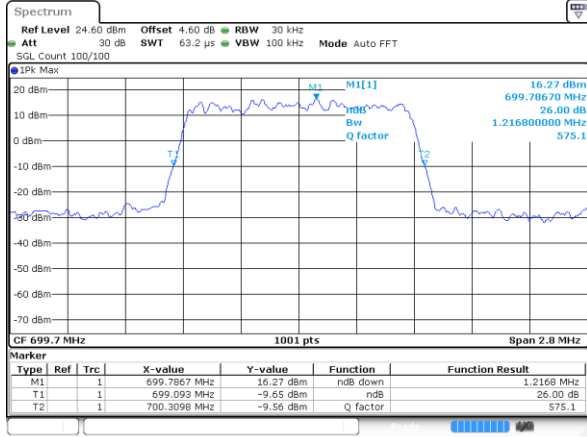

Lowest Channel / 1.4MHz / 16QAM

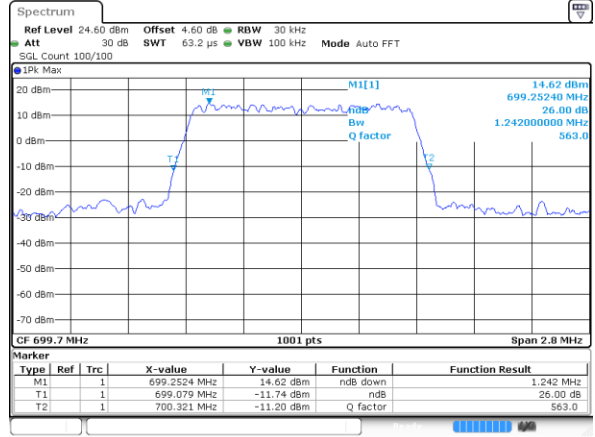

Middle Channel / 1.4MHz / QPSK

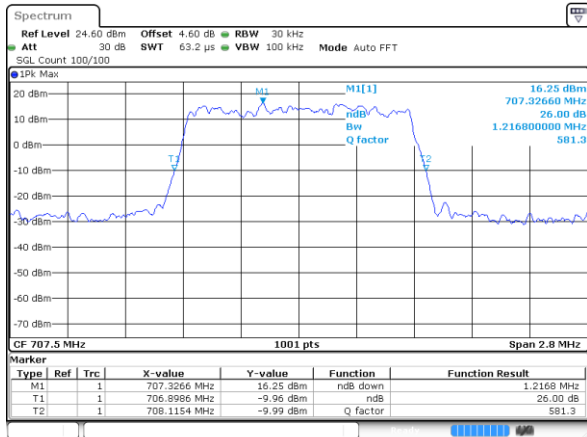

Middle Channel / 1.4MHz / 16QAM

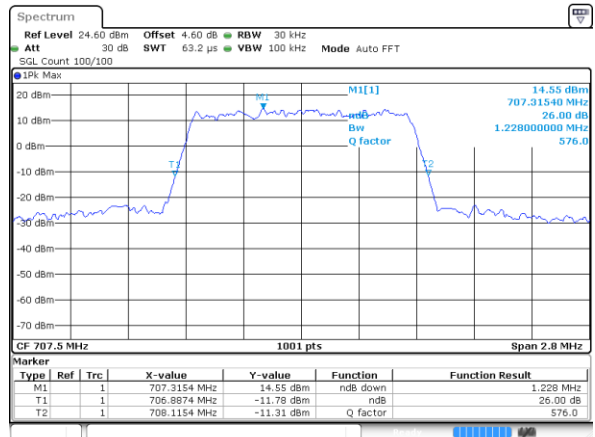

Highest Channel / 1.4MHz / QPSK

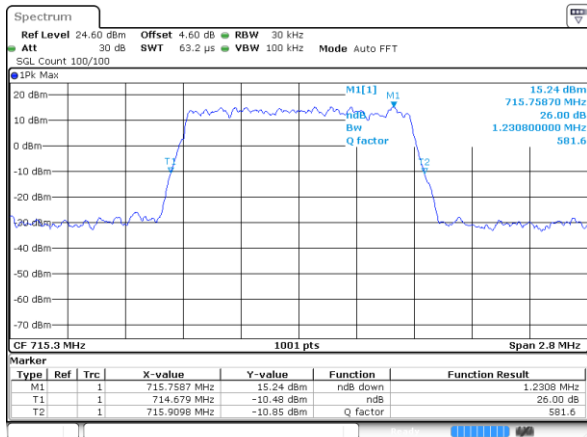

Highest Channel / 1.4MHz / 16QAM

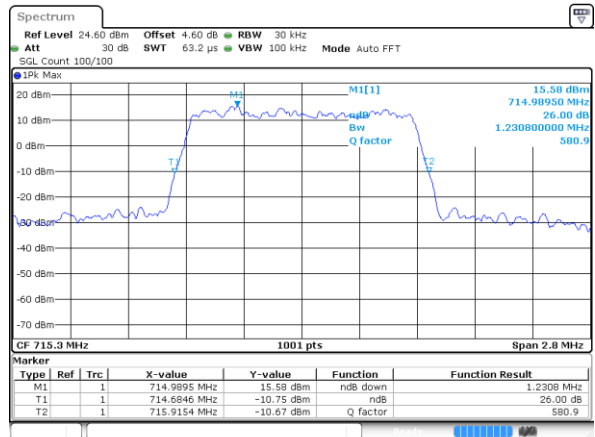



LTE Band 12

Lowest Channel / 3MHz / QPSK

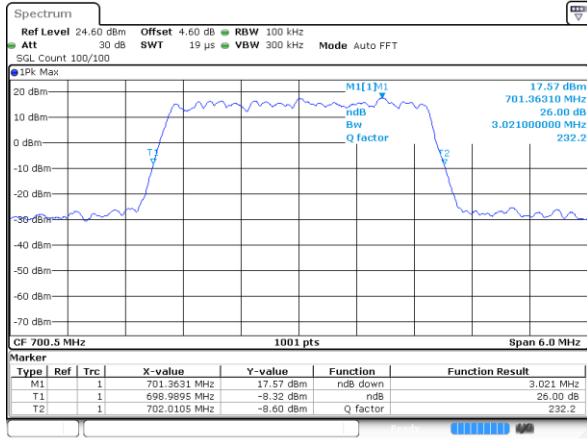

Lowest Channel / 3MHz / 16QAM

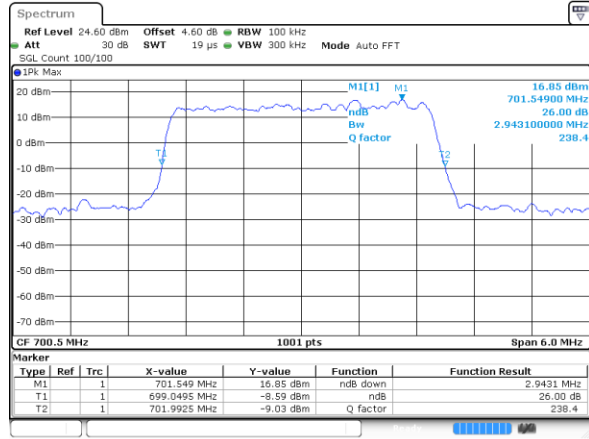

Middle Channel / 3MHz / QPSK

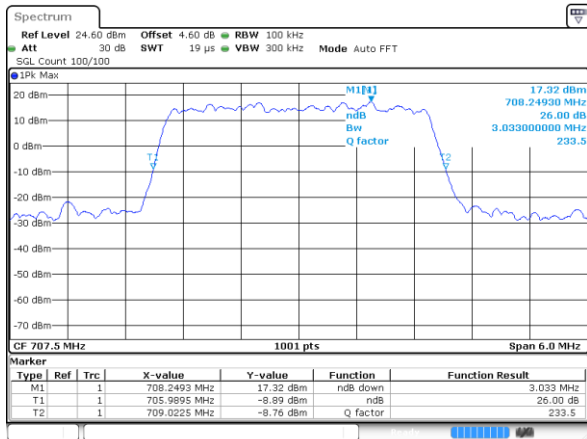

Middle Channel / 3MHz / 16QAM

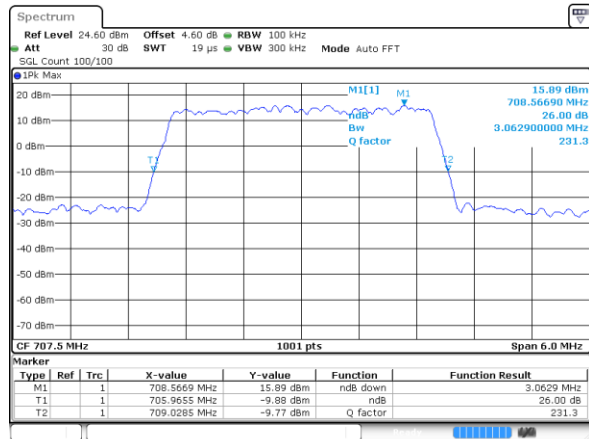

Highest Channel / 3MHz / QPSK

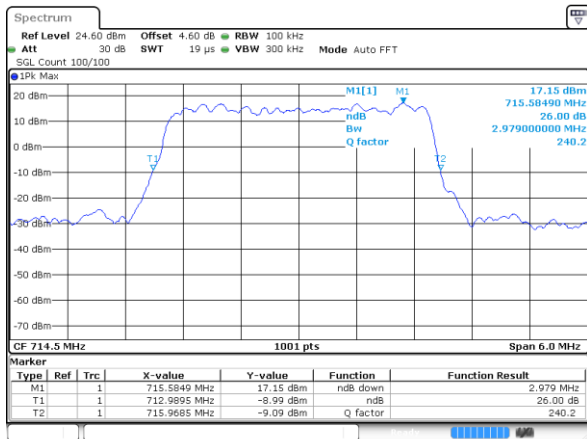

Highest Channel / 3MHz / 16QAM

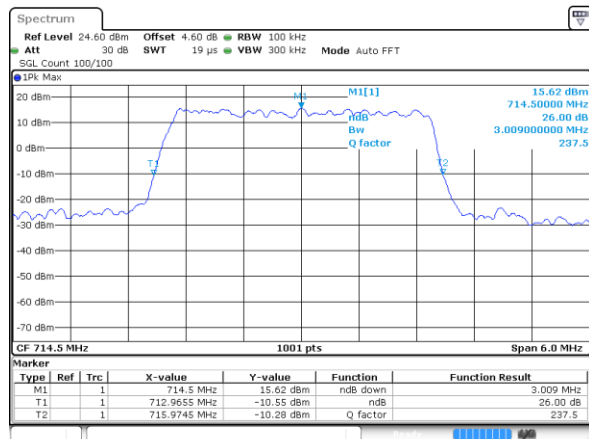



LTE Band 12

Lowest Channel / 5MHz / QPSK

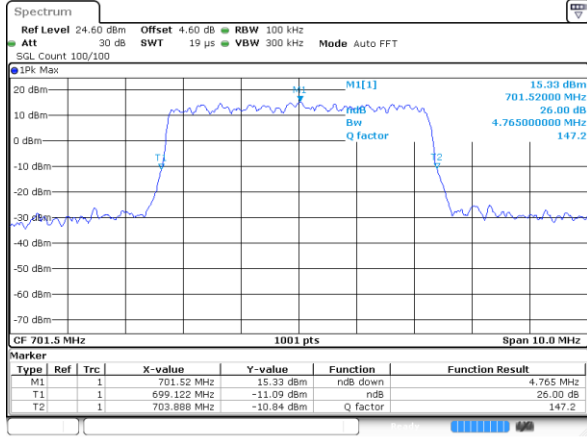

Lowest Channel / 5MHz / 16QAM

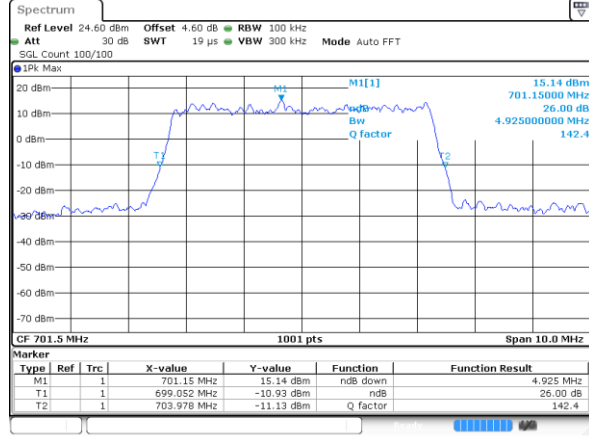

Middle Channel / 5MHz / QPSK

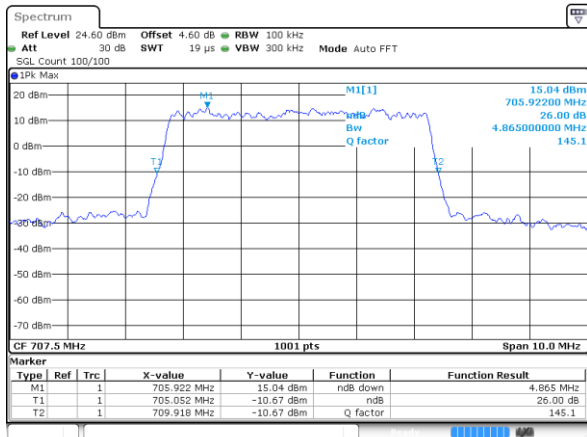

Middle Channel / 5MHz / 16QAM

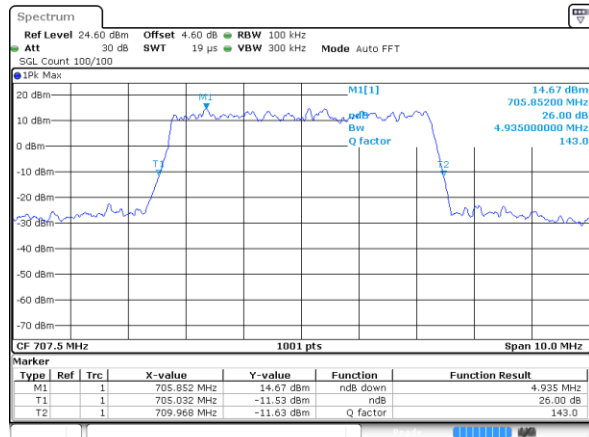

Highest Channel / 5MHz / QPSK

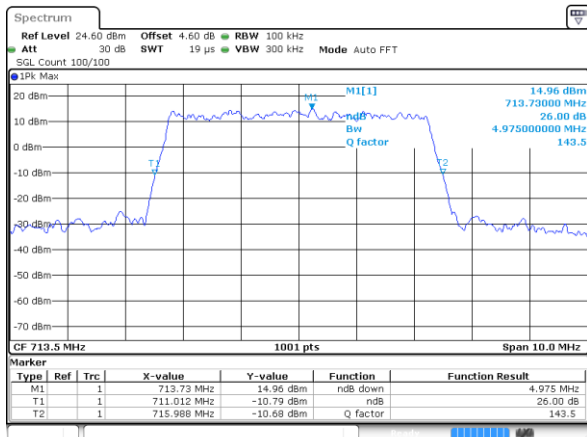

Highest Channel / 5MHz / 16QAM

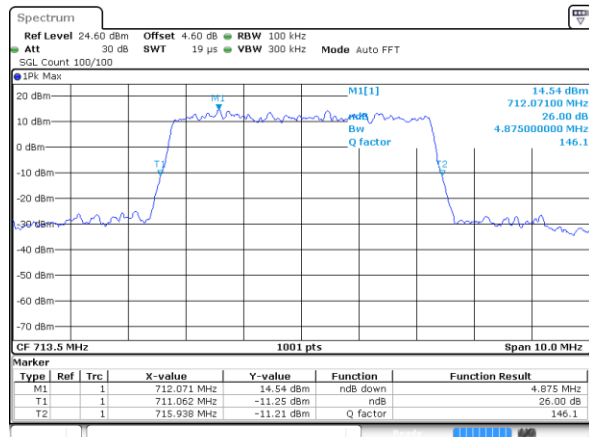



LTE Band 12

Lowest Channel / 10MHz / QPSK

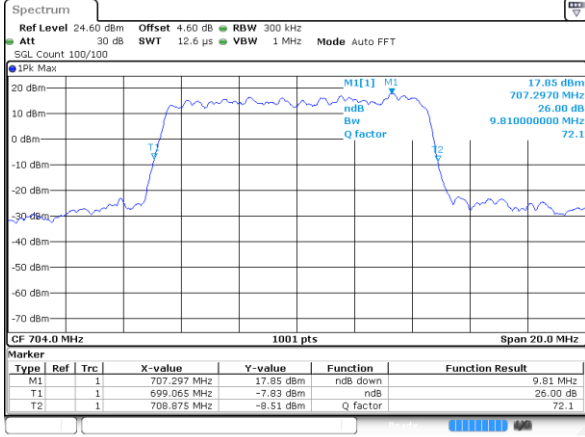

Lowest Channel / 10MHz / 16QAM

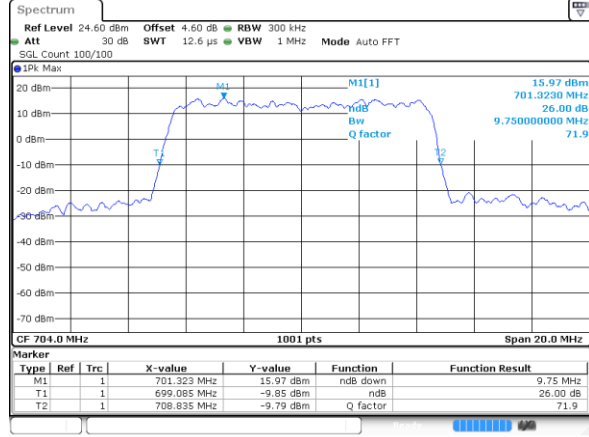

Middle Channel / 10MHz / QPSK

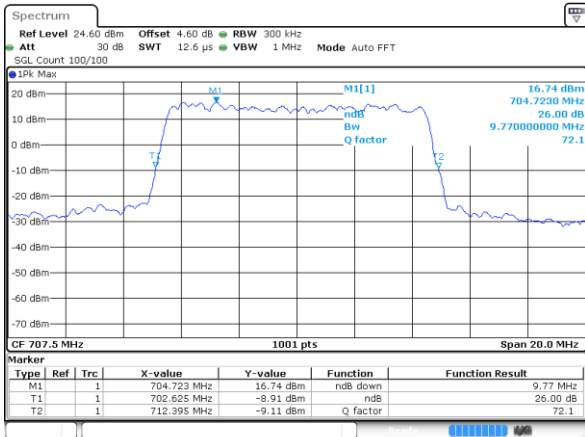

Middle Channel / 10MHz / 16QAM

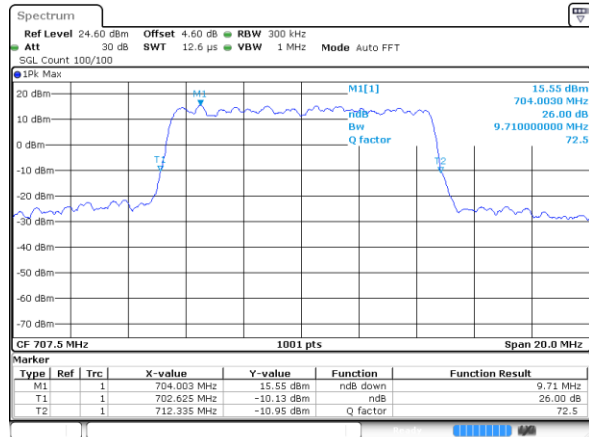

Highest Channel / 10MHz / QPSK

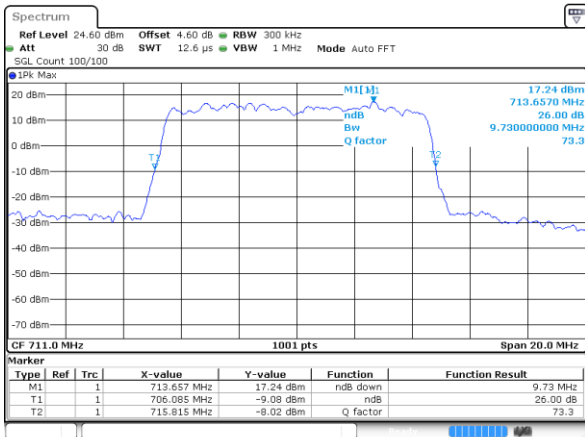

Highest Channel / 10MHz / 16QAM

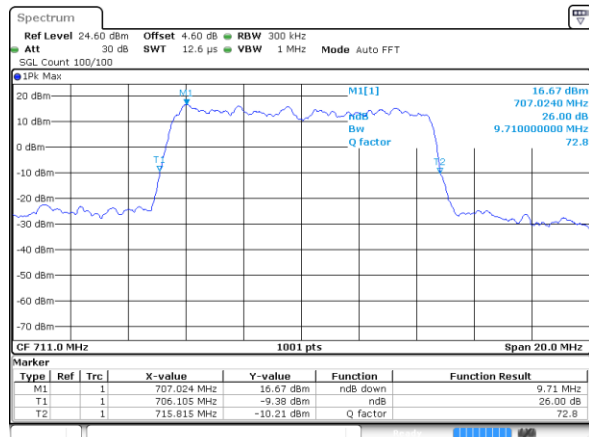





LTE Band 12

Lowest Channel / 1.4MHz / 64QAM

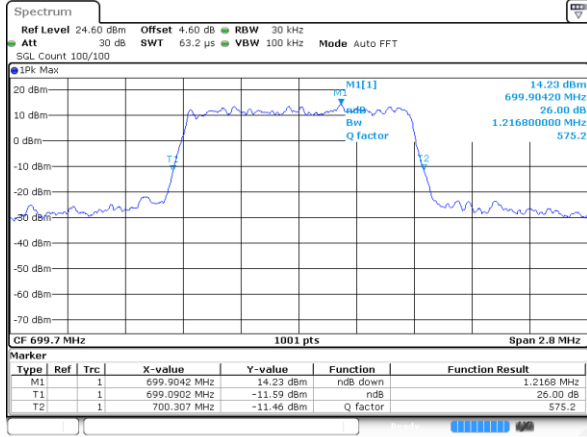

Lowest Channel / 3MHz / 64QAM

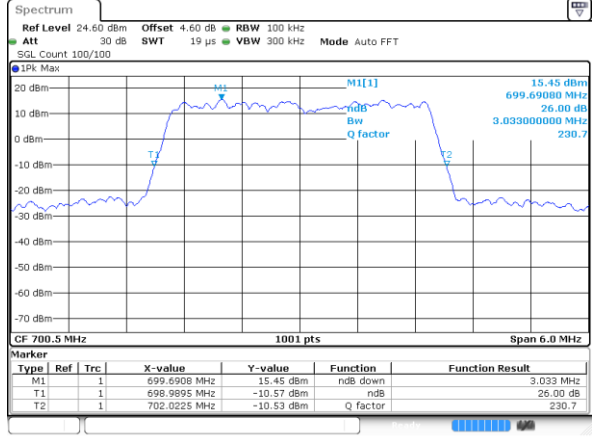

Middle Channel / 1.4MHz / 64QAM

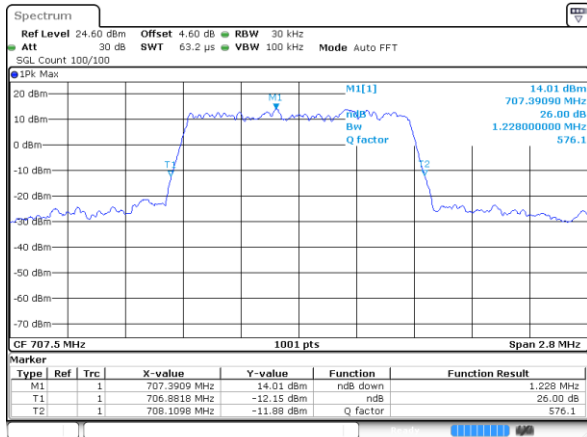

Middle Channel / 3MHz / 64QAM

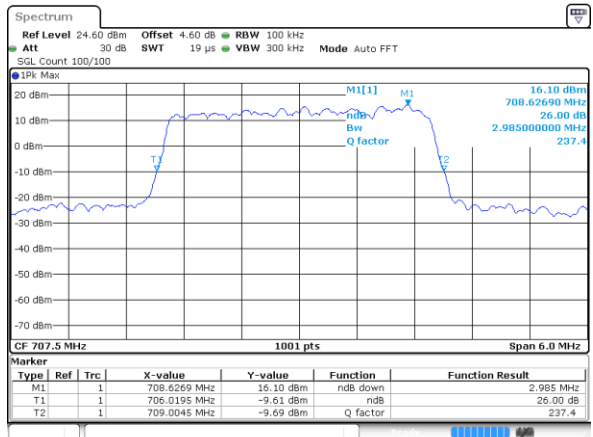

Highest Channel / 1.4MHz / 64QAM

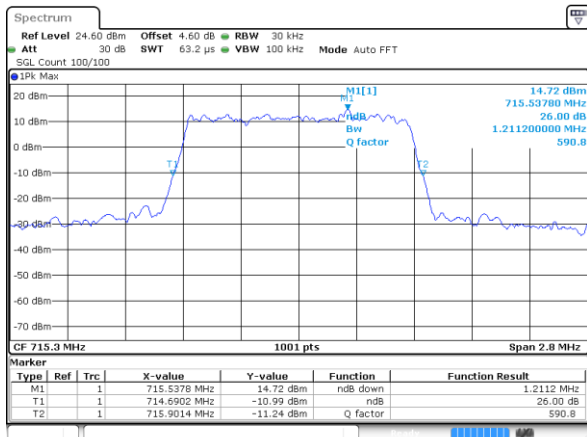

Highest Channel / 3MHz / 64QAM

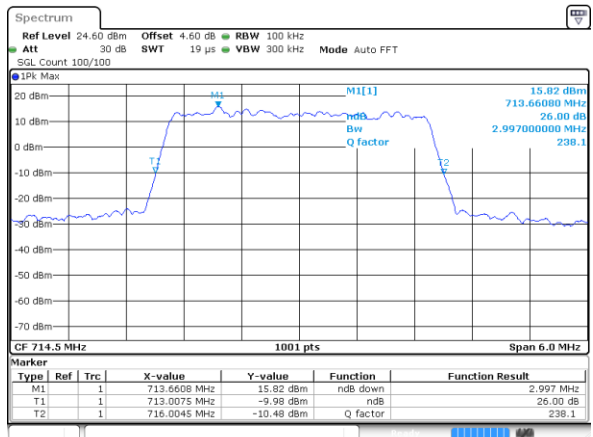



LTE Band 12

Lowest Channel / 5MHz / 64QAM

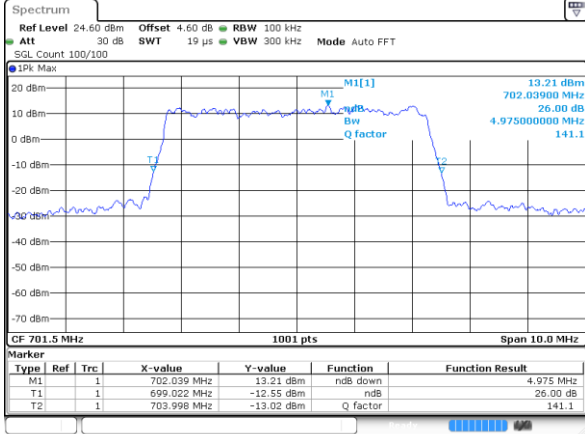

Lowest Channel / 10MHz / 64QAM

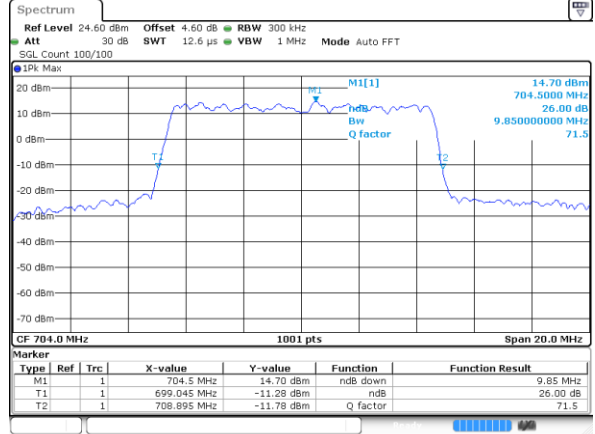

Middle Channel / 5MHz / 64QAM

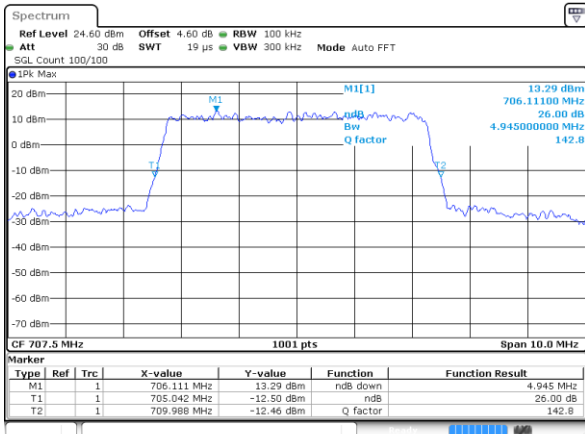

Middle Channel / 10MHz / 64QAM

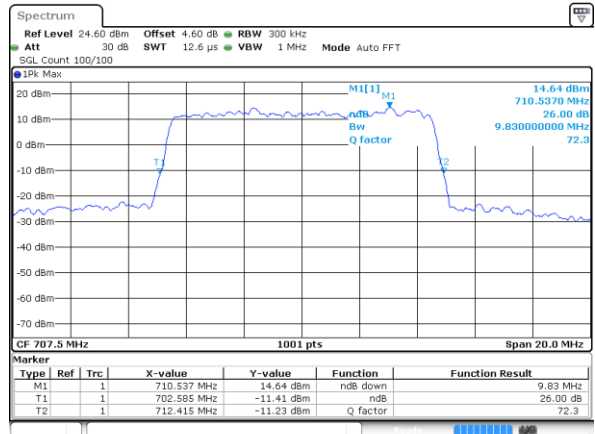

Highest Channel / 5MHz / 64QAM

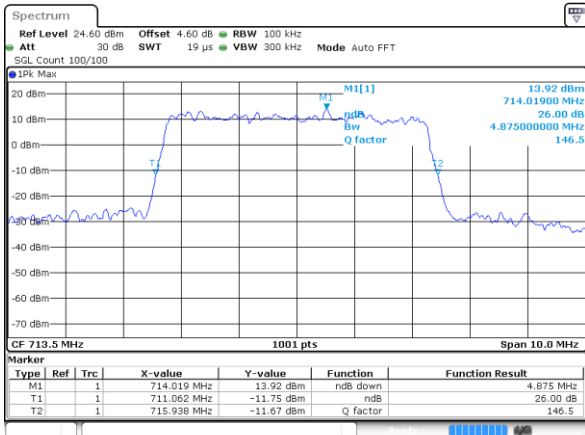

Highest Channel / 10MHz / 64QAM

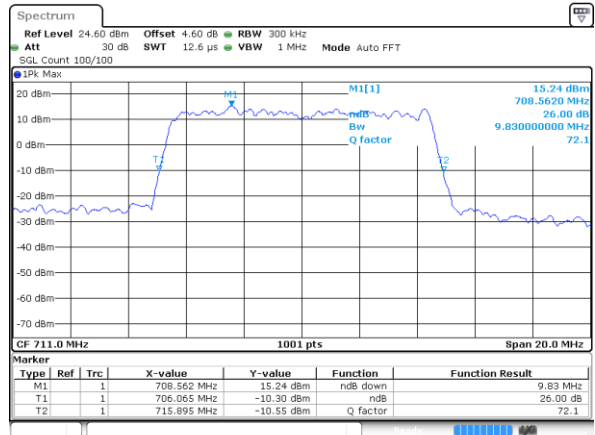



### Occupied Bandwidth

Mode	LTE Band 12 : 99%OBW(MHz)											
	1.4MHz		3MHz		5MHz		10MHz		1.4MHz	3MHz	5MHz	10MHz
BW	QPSK	16QAM	QPSK	16QAM	QPSK	16QAM	QPSK	16QAM	64QAM	64QAM	64QAM	64QAM
Lowest CH	1.09	1.09	2.71	2.73	4.49	4.50	9.01	8.99	1.09	2.73	4.50	9.01
Middle CH	1.09	1.09	2.72	2.72	4.49	4.50	9.03	8.99	1.09	2.73	4.51	8.95
Highest CH	1.09	1.09	2.71	2.71	4.49	4.51	8.95	9.01	1.09	2.73	4.52	9.05



LTE Band 12

Lowest Channel / 1.4MHz / QPSK

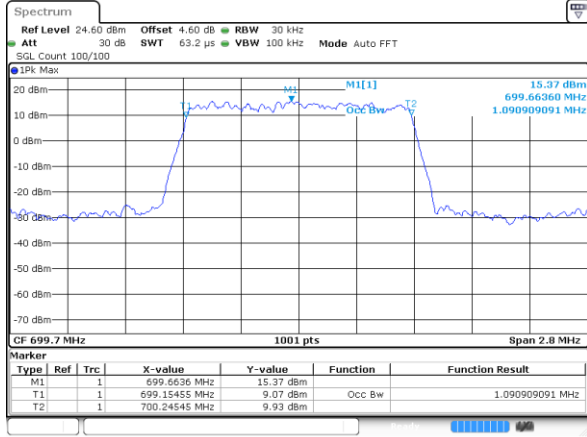

Lowest Channel / 1.4MHz / 16QAM

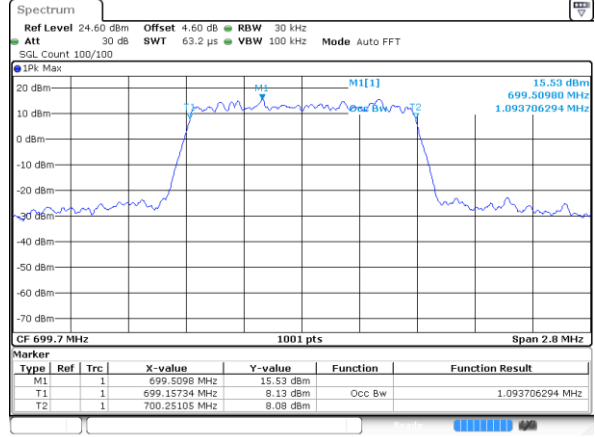

Middle Channel / 1.4MHz / QPSK

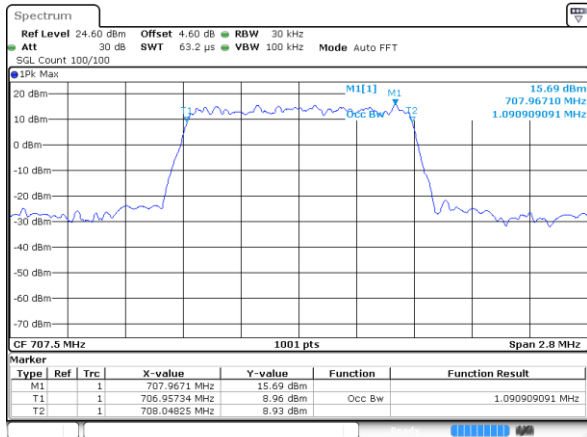

Middle Channel / 1.4MHz / 16QAM

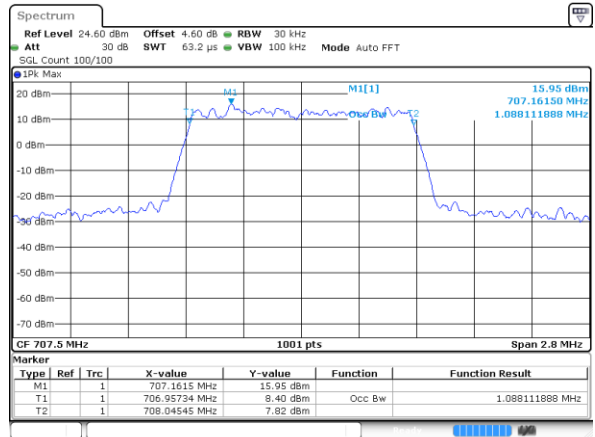

Highest Channel / 1.4MHz / QPSK

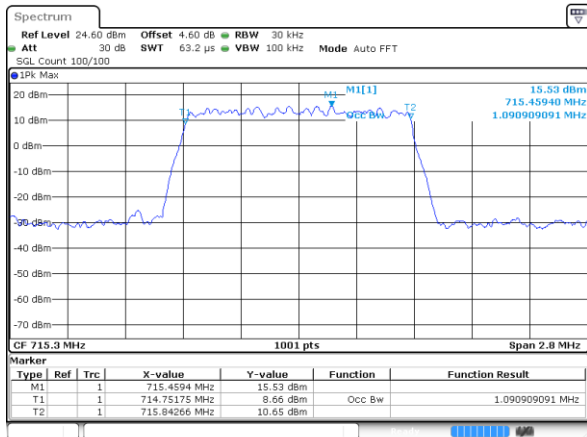

Highest Channel / 1.4MHz / 16QAM

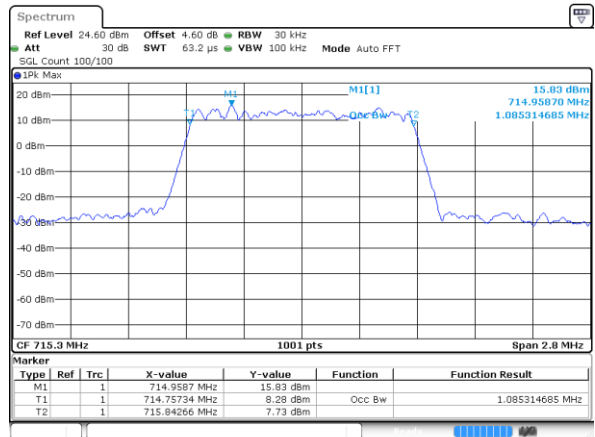



LTE Band 12

Lowest Channel / 3MHz / QPSK

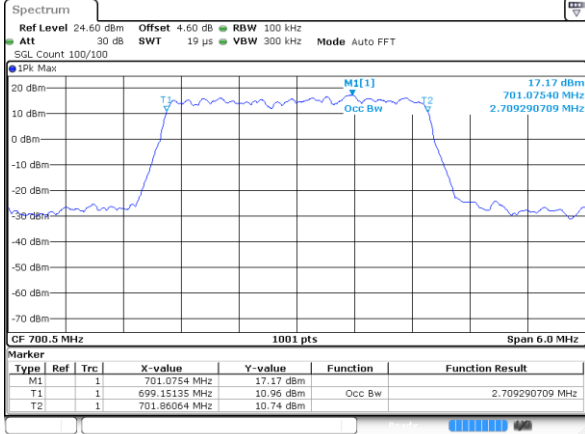

Lowest Channel / 3MHz / 16QAM

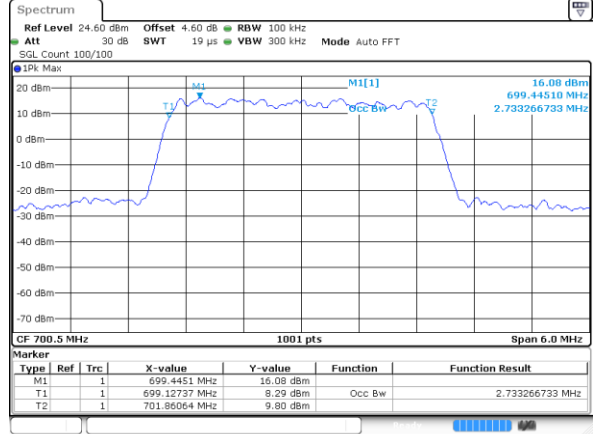

Middle Channel / 3MHz / QPSK

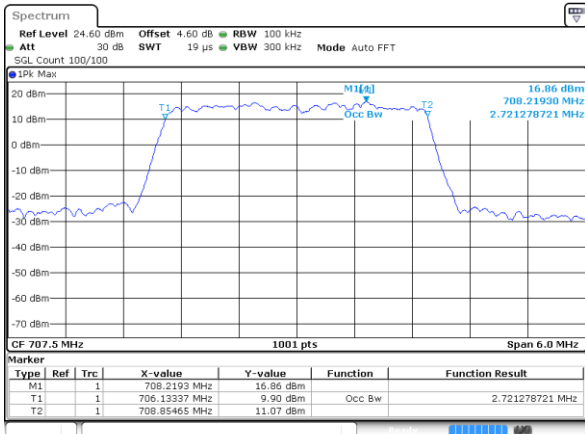

Middle Channel / 3MHz / 16QAM

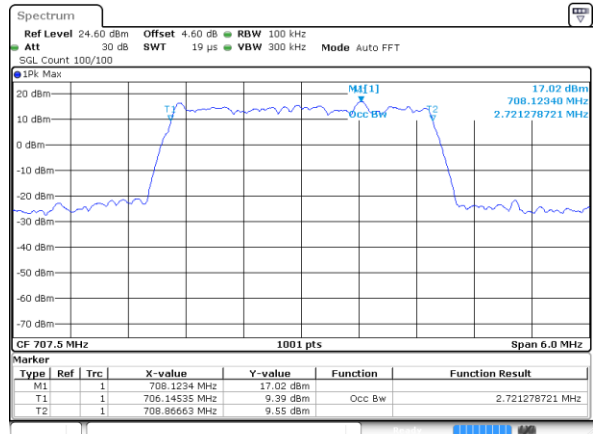

Highest Channel / 3MHz / QPSK

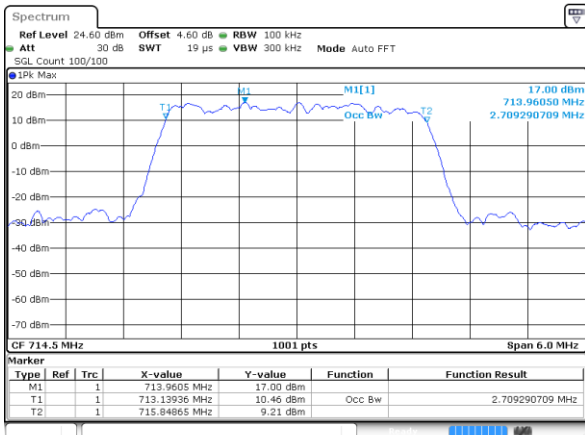

Highest Channel / 3MHz / 16QAM

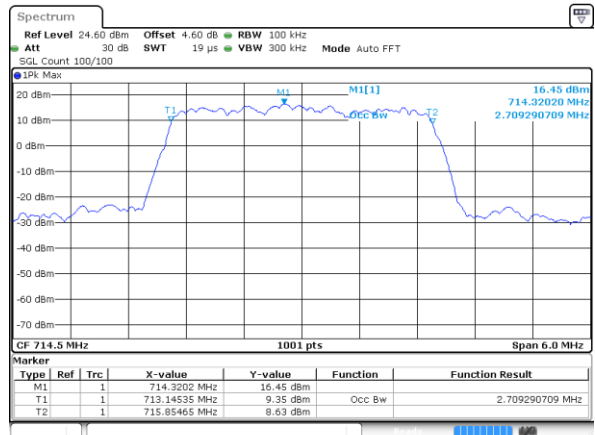



LTE Band 12

Lowest Channel / 5MHz / QPSK

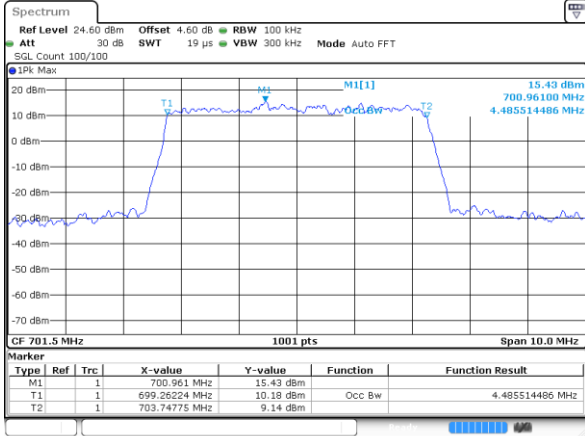

Lowest Channel / 5MHz / 16QAM

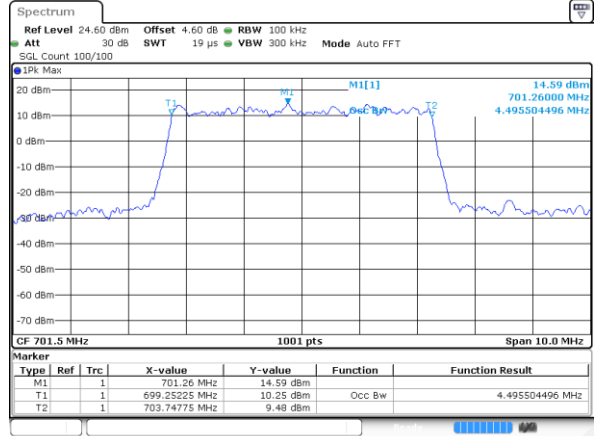

Middle Channel / 5MHz / QPSK

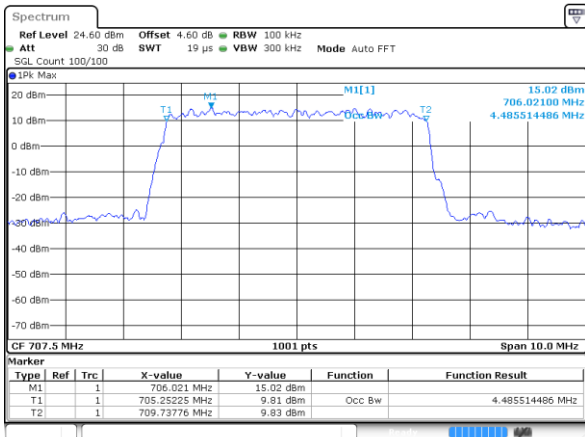

Middle Channel / 5MHz / 16QAM

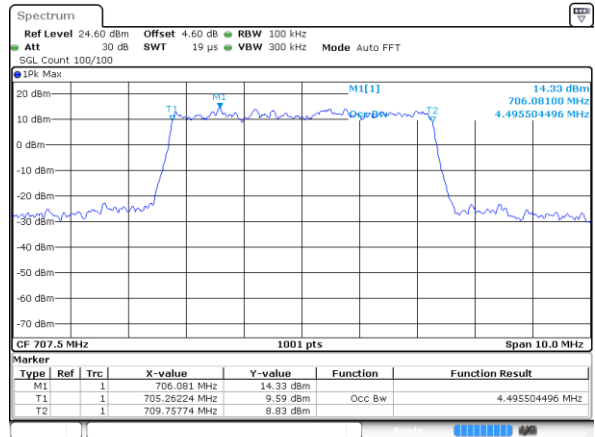

Highest Channel / 5MHz / QPSK

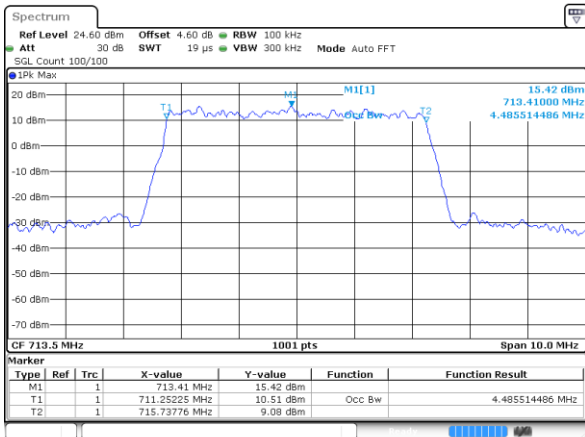

Highest Channel / 5MHz / 16QAM

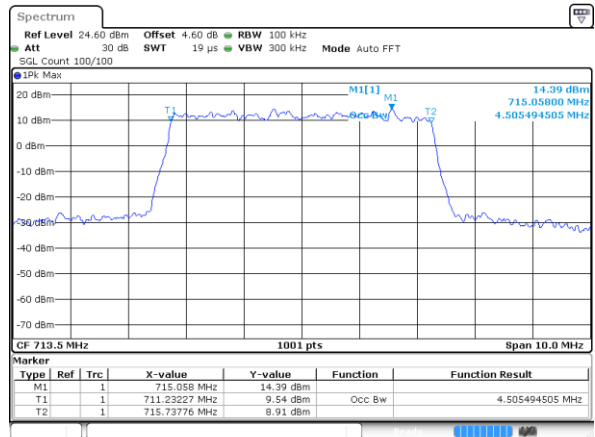



LTE Band 12

Lowest Channel / 10MHz / QPSK

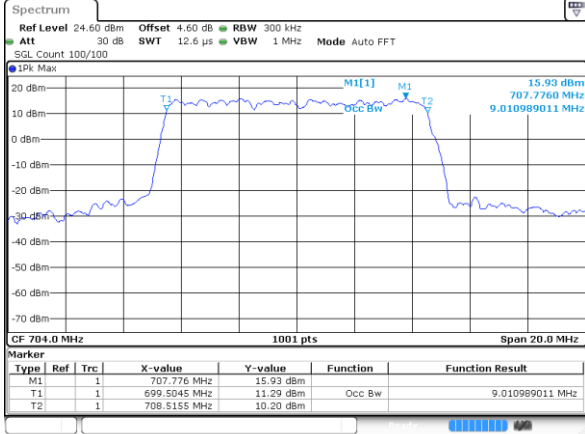

Lowest Channel / 10MHz / 16QAM

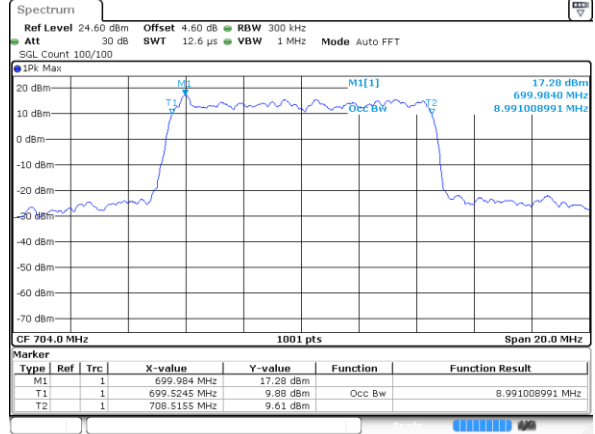

Middle Channel / 10MHz / QPSK

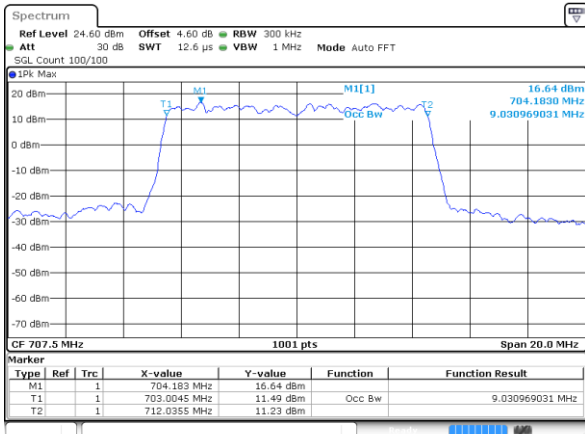

Middle Channel / 10MHz / 16QAM

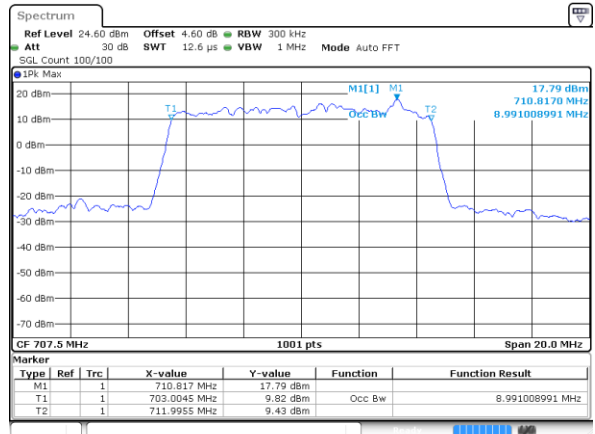

Highest Channel / 10MHz / QPSK

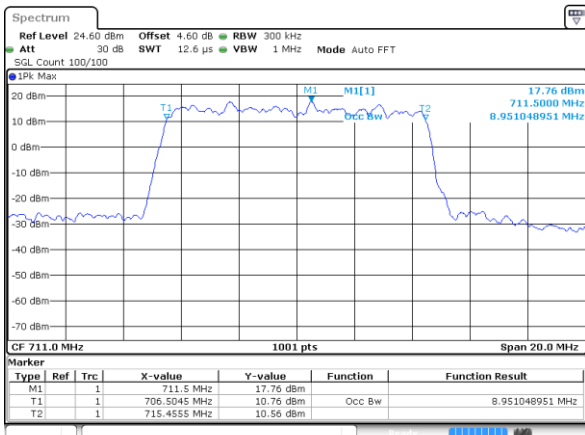

Highest Channel / 10MHz / 16QAM

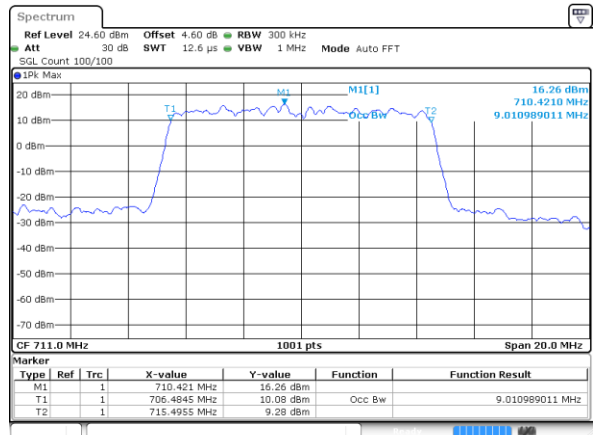



LTE Band 12

Lowest Channel / 1.4MHz / 64QAM

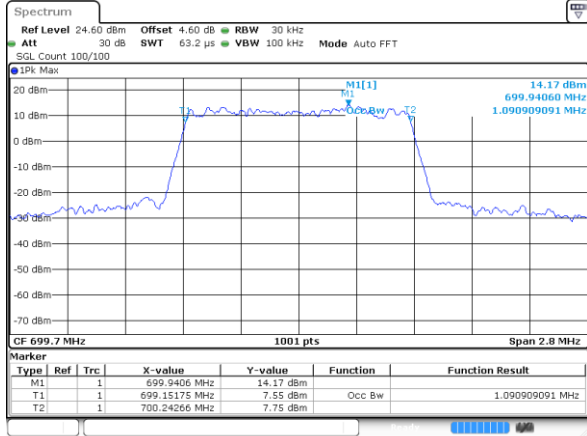

Lowest Channel / 3MHz / 64QAM

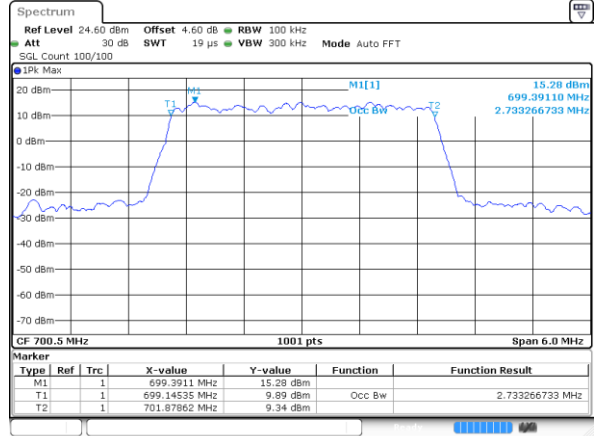

Middle Channel / 1.4MHz / 64QAM

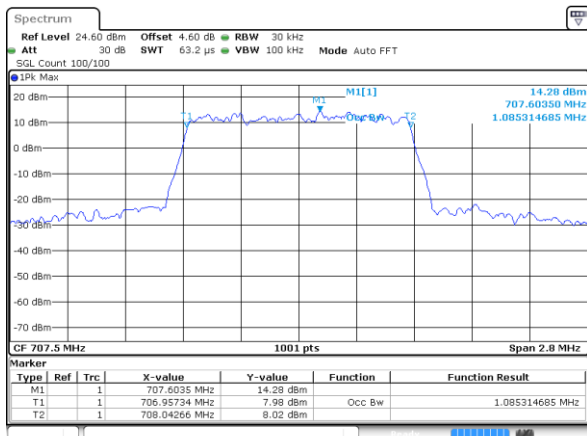

Middle Channel / 3MHz / 64QAM

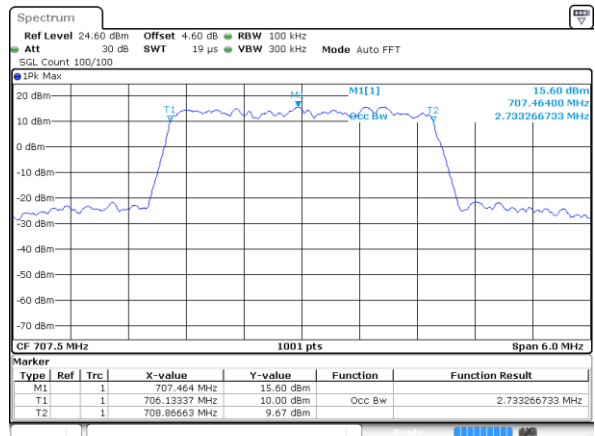

Highest Channel / 1.4MHz / 64QAM

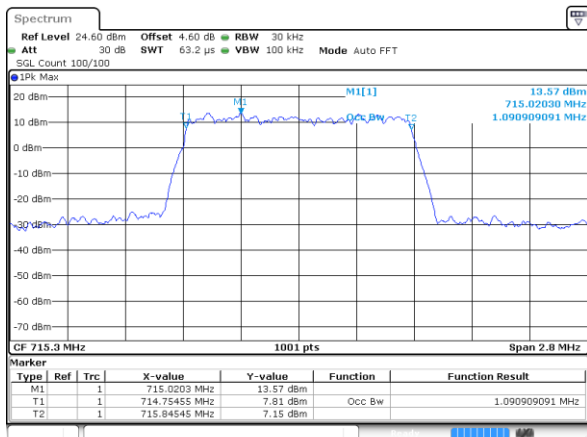

Highest Channel / 3MHz / 64QAM

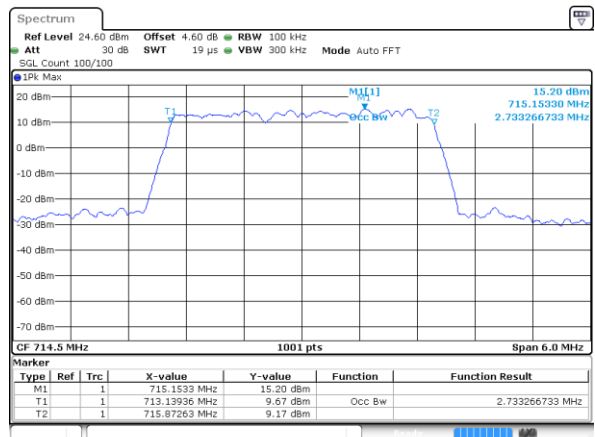





LTE Band 12

Lowest Channel / 5MHz / 64QAM

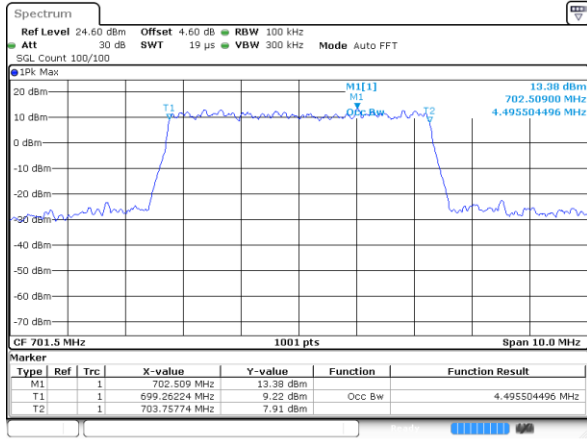

Lowest Channel / 10MHz / 64QAM

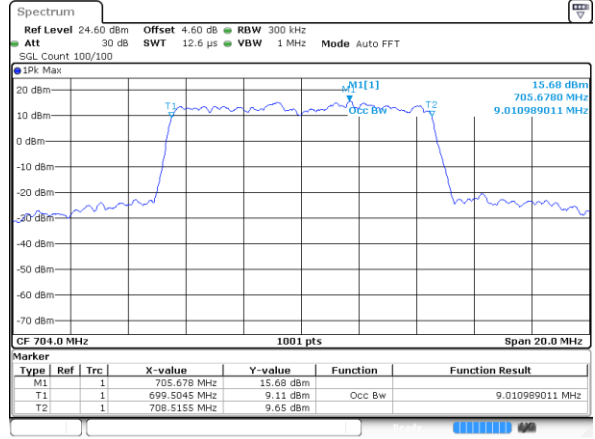

Middle Channel / 5MHz / 64QAM

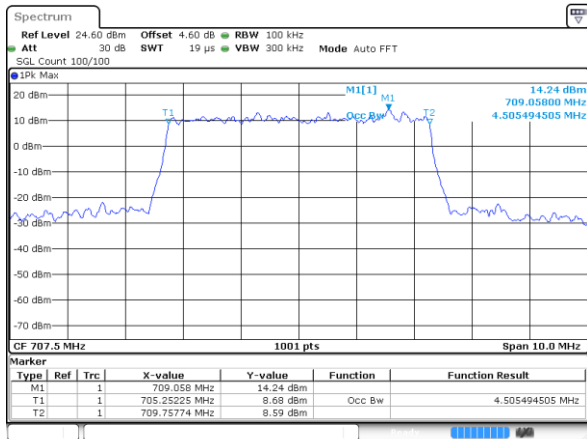

Middle Channel / 10MHz / 64QAM

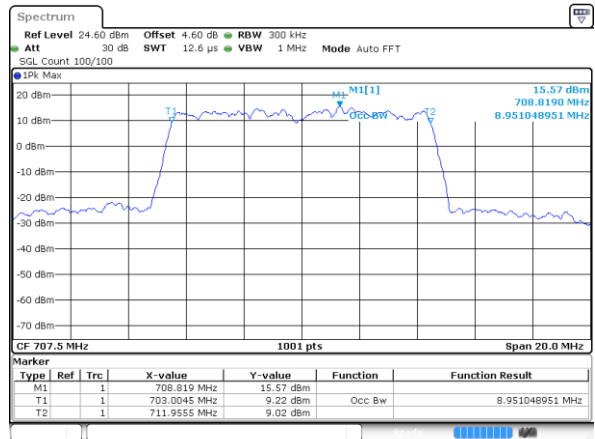

Highest Channel / 5MHz / 64QAM

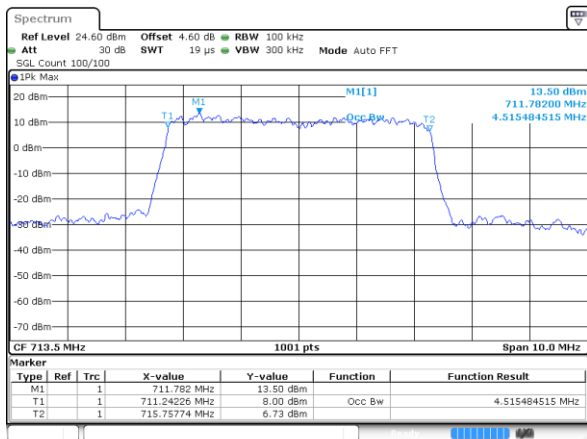

Highest Channel / 10MHz / 64QAM

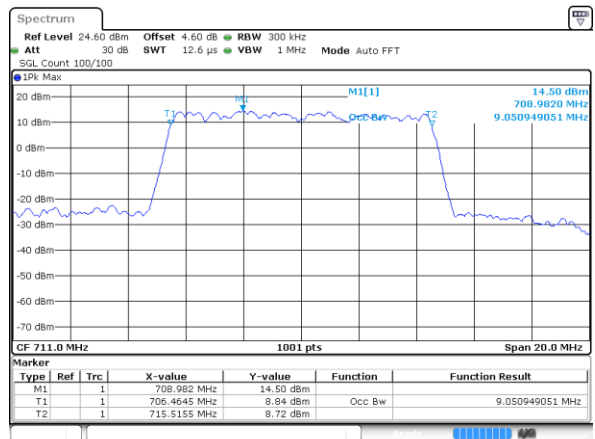



# Conducted Band Edge

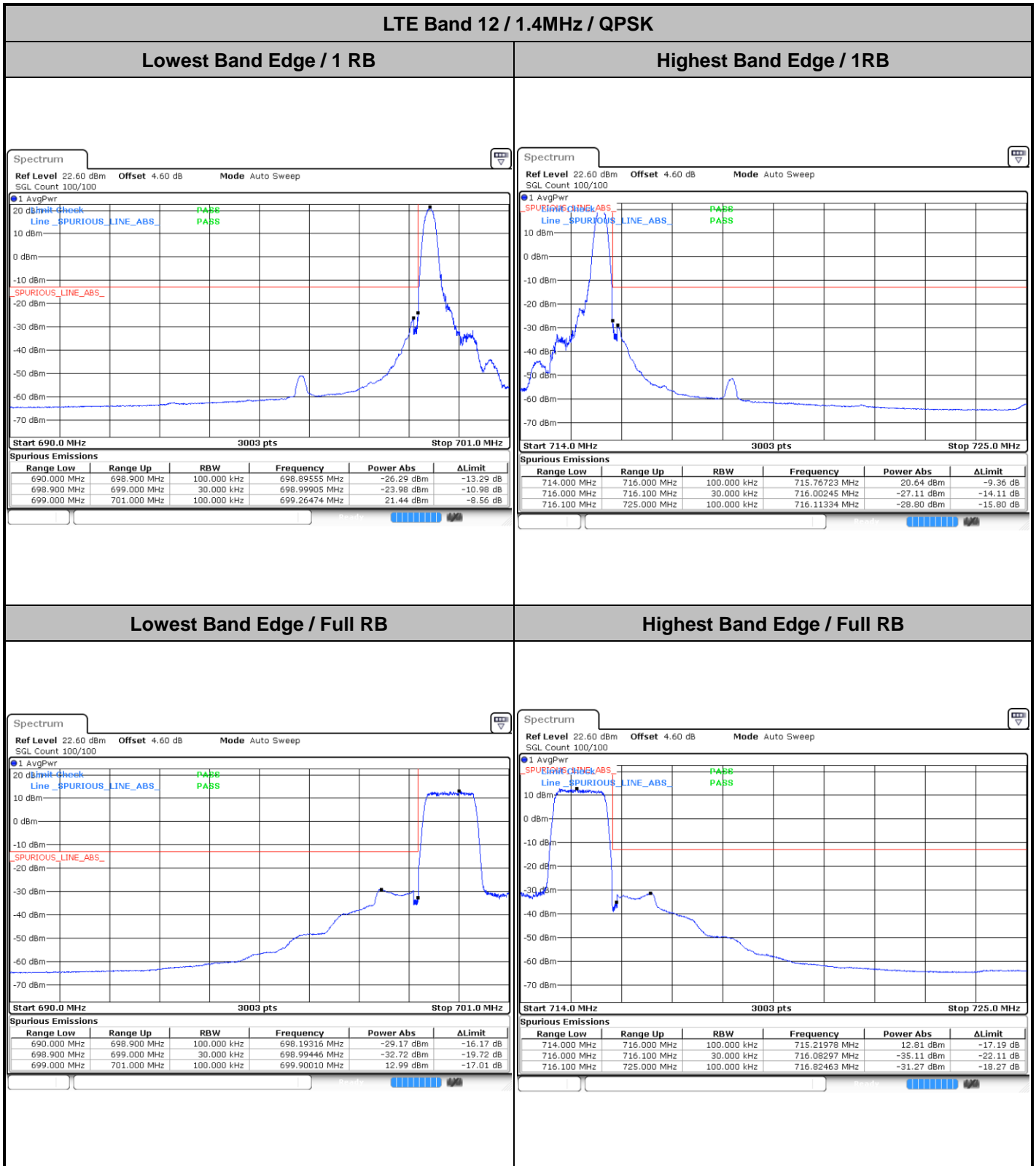

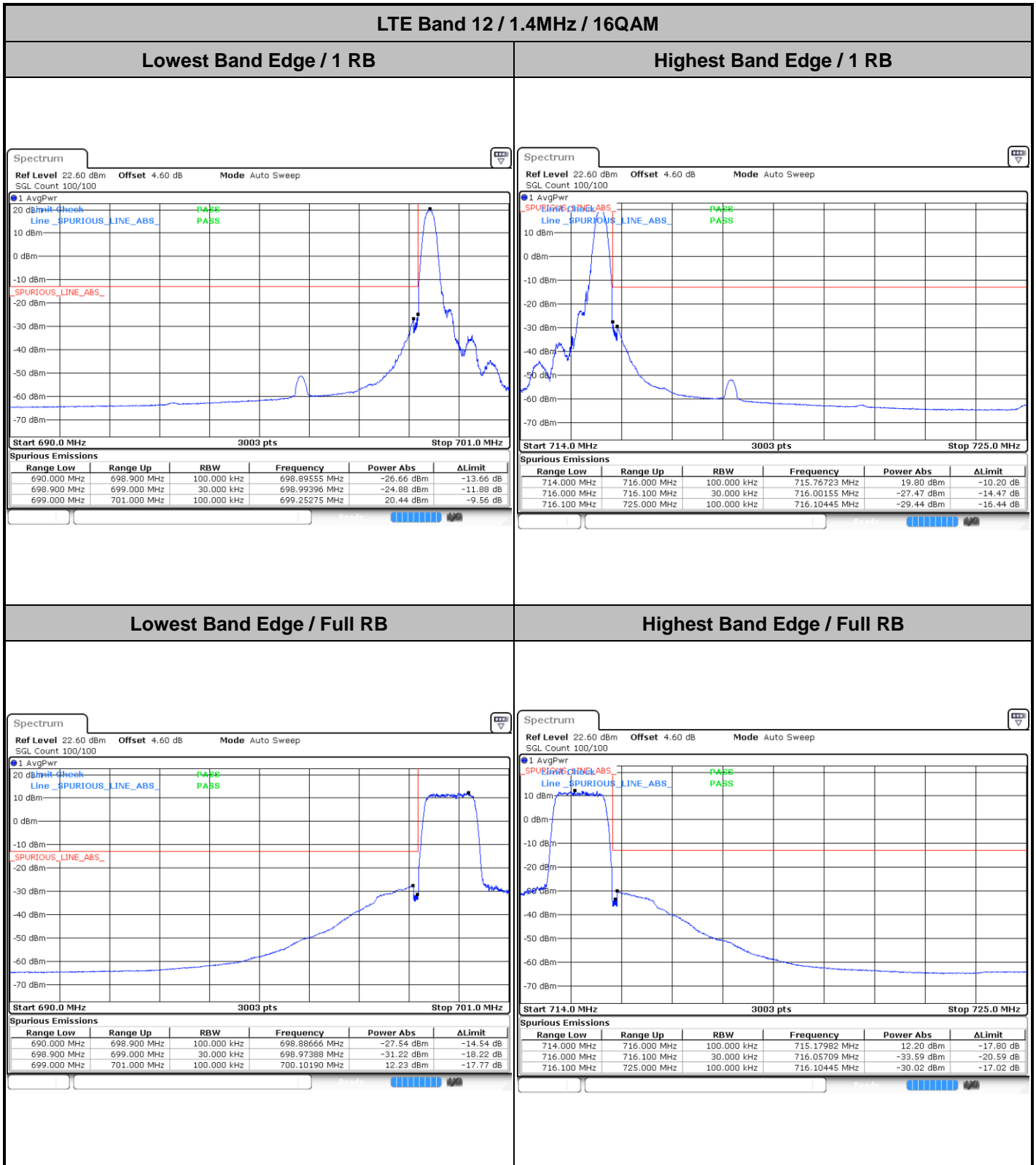



LTE Band 12 / 1.4MHz / 64QAM

Lowest Band Edge / 1 RB

Highest Band Edge / 1 RB

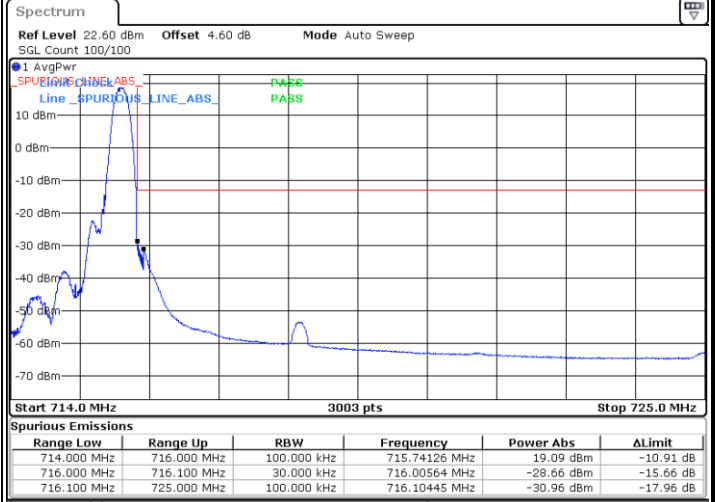
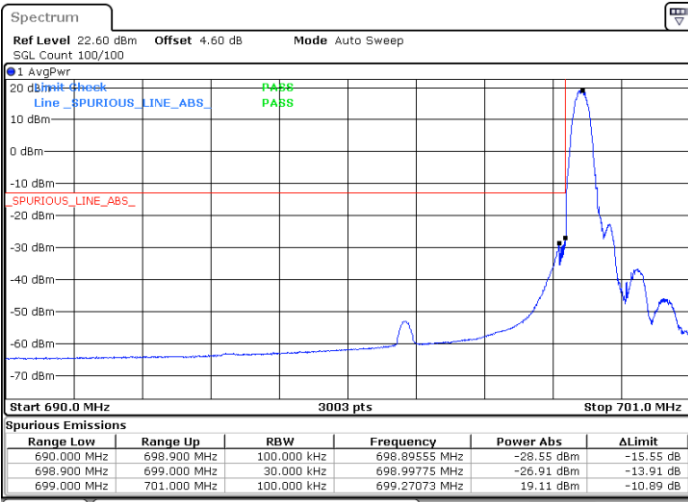

Lowest Band Edge / Full RB

Highest Band Edge / Full RB

