



FCC RF Test Report

APPLICANT : Motorola Mobility LLC
EQUIPMENT : Mobile Cellular Phone
BRAND NAME : Motorola
MODEL NAME : XT2045-1
FCC ID : IHDT56YK2
STANDARD : FCC Part 15 Subpart C §15.247
CLASSIFICATION : (DSS) Spread Spectrum Transmitter

The product was received on Oct. 21, 2019 and testing was completed on Nov. 07, 2019. We, Sporton International (Kunshan) Inc., would like to declare that the tested sample has been evaluated in accordance with the test procedures and has been in compliance with the applicable technical standards.

The test results in this report apply exclusively to the tested model / sample. Without written approval of Sporton International (Kunshan) Inc., the test report shall not be reproduced except in full.

Jason Jia

Reviewed by: Jason Jia / Supervisor

James Huang

Approved by: James Huang / Manager



Sporton International (Kunshan) Inc.

**No. 1098, Pengxi North Road, Kunshan Economic Development Zone Jiangsu Province 215300
People's Republic of China**



TABLE OF CONTENTS

REVISION HISTORY..... 3

SUMMARY OF TEST RESULT 4

1 GENERAL DESCRIPTION..... 5

 1.1. Applicant 5

 1.2. Manufacturer 5

 1.3. Product Feature of Equipment Under Test..... 5

 1.4. Product Specification of Equipment Under Test..... 6

 1.5. Specification of Accessory 6

 1.6. Modification of EUT 7

 1.7. Testing Location 7

 1.8. Test Software..... 7

 1.9. Applicable Standards 8

2 TEST CONFIGURATION OF EQUIPMENT UNDER TEST..... 9

 2.1. Carrier Frequency Channel 9

 2.2. Test Mode 10

 2.3. Connection Diagram of Test System 11

 2.4. Support Unit used in test configuration and system 12

 2.5. EUT Operation Test Setup 12

 2.6. Measurement Results Explanation Example 12

3 TEST RESULT 13

 3.1. Number of Channel Measurement 13

 3.2. Hopping Channel Separation Measurement 15

 3.3. Dwell Time Measurement 21

 3.4. 20dB Bandwidth Measurement 23

 3.5. Output Power Measurement..... 29

 3.6. Conducted Band Edges Measurement..... 30

 3.7. Conducted Spurious Emission Measurement 37

 3.8. Radiated Band Edges and Spurious Emission Measurement 47

 3.9. AC Conducted Emission Measurement..... 51

 3.10. Antenna Requirements 53

4 LIST OF MEASURING EQUIPMENT 54

5 UNCERTAINTY OF EVALUATION..... 55

APPENDIX A. CONDUCTED TEST RESULTS

APPENDIX B. AC CONDUCTED EMISSION TEST RESULT

APPENDIX C. RADIATED SPURIOUS EMISSION

APPENDIX D. DUTY CYCLE PLOTS

APPENDIX E. SETUP PHOTOGRAPHS



REVISION HISTORY

REPORT NO.	VERSION	DESCRIPTION	ISSUED DATE
FR902103A	Rev. 01	Initial issue of report	Dec. 06, 2019



SUMMARY OF TEST RESULT

Report Section	FCC Rule	Description	Limit	Result	Remark
3.1	15.247(a)(1)	Number of Channels	≥ 15Chs	Pass	-
3.2	15.247(a)(1)	Hopping Channel Separation	≥ 2/3 of 20dB BW	Pass	-
3.3	15.247(a)(1)	Dwell Time of Each Channel	≤ 0.4sec in 31.6sec period	Pass	-
3.4	15.247(a)(1)	20dB Bandwidth	NA	Pass	-
3.5	15.247(b)(1)	Peak Output Power	≤ 125 mW	Pass	-
3.6	15.247(d)	Conducted Band Edges	≤ 20dBc	Pass	-
3.7	15.247(d)	Conducted Spurious Emission	≤ 20dBc	Pass	-
3.8	15.247(d)	Radiated Band Edges and Radiated Spurious Emission	15.209(a) & 15.247(d)	Pass	Under limit 14.88 dB at 2483.56 MHz
3.9	15.207	AC Conducted Emission	15.207(a)	Pass	Under limit 9.18 dB at 0.180 MHz
3.10	15.203 & 15.247(b)	Antenna Requirement	N/A	Pass	-

Declaration of Conformity:

The test results with all measurement uncertainty excluded are presented in accordance with the regulation limits or requirements declared by manufacturers.

Comments and Explanations:

The declared of product specification for EUT presented in the report are provided by the manufacturer, and the manufacturer takes all the responsibilities for the accuracy of product specification.



1 General Description

1.1. Applicant

Motorola Mobility LLC
222 W, Merchandise Mart Plaza, Chicago IL 60654 USA

1.2. Manufacturer

Motorola Mobility LLC
222 W, Merchandise Mart Plaza, Chicago IL 60654 USA

1.3. Product Feature of Equipment Under Test

Product Feature	
Equipment	Mobile Cellular Phone
Brand Name	Motorola
Model Name	XT2045-1
FCC ID	IHDT56YK2
EUT supports Radios application	GSM/WCDMA/LTE WLAN 2.4GHz 802.11b/g/n HT20 Bluetooth BR/EDR/LE GNSS/FM Receiver
IMEI Code	Conducted: N/A Conduction: 359107100039759/359107100039767 Radiation: N/A
HW Version	DVT2
SW Version	QPJ30.36
EUT Stage	Identical Prototype

Remark:

1. The above EUT's information was declared by manufacturer. Please refer to the specifications or user's manual for more detailed description.
2. There are two types of EUT, the sample 1 is dual SIM slot, sample 2 is single SIM slot. According to the difference, we choose sample 1 to perform full test.

1.4. Product Specification of Equipment Under Test

Standards-related Product Specification	
Tx/Rx Frequency Range	2402 MHz ~ 2480 MHz
Number of Channels	79
Carrier Frequency of Each Channel	2402+n*1 MHz; n=0~78
Maximum Output Power to Antenna	Bluetooth BR(1Mbps) : 7.12 dBm (0.0052 W) Bluetooth EDR (2Mbps) : 7.47 dBm (0.0056 W) Bluetooth EDR (3Mbps) : 7.71 dBm (0.0059 W)
Antenna Type / Gain	PIFA Antenna type with gain -5.0 dBi
Type of Modulation	Bluetooth BR (1Mbps) : GFSK Bluetooth EDR (2Mbps) : π /4-DQPSK Bluetooth EDR (3Mbps) : 8-DPSK

1.5. Specification of Accessory

Specification of Accessory				
AC Adapter 1(US)	Brand Name	Motorola (Acbel)	Model Name	SC-41
	Power Rating	I/P: 100-240 Vac, 300mA ,50/60HZ O/P: 5Vdc, 2000mA		
AC Adapter 1(EU)	Brand Name	Motorola (Acbel)	Model Name	SC-42
	Power Rating	I/P: 100-240 Vac, 300mA ,50/60HZ O/P: 5Vdc, 2000mA		
AC Adapter 1(UK)	Brand Name	Motorola (Acbel)	Model Name	SC-43
	Power Rating	I/P: 100-240 Vac, 300mA ,50/60HZ O/P: 5Vdc, 2000mA		
AC Adapter 1(AU)	Brand Name	Motorola (Acbel)	Model Name	SC-45
	Power Rating	I/P: 100-240 Vac, 300mA ,50/60HZ O/P: 5Vdc, 2000mA		
AC Adapter 1(AR)	Brand Name	Motorola (Acbel)	Model Name	SC-46
	Power Rating	I/P: 100-240 Vac, 300mA ,50/60HZ O/P: 5Vdc, 2000mA		
AC Adapter 2(US)	Brand Name	Motorola(Chenyang)	Model Name	SC-41
	Power Rating	I/P: 100-240 Vac, 300mA ,50/60HZ O/P: 5Vdc, 2000mA		
AC Adapter 2(EU)	Brand Name	Motorola(Chenyang)	Model Name	SC-42
	Power Rating	I/P: 100-240 Vac, 300mA ,50/60HZ O/P: 5Vdc, 2000mA		
AC Adapter 2(AR)	Brand Name	Motorola(Chenyang)	Model Name	SC-46
	Power Rating	I/P: 100-240 Vac, 300mA ,50/60HZ O/P: 5Vdc, 2000mA		
AC Adapter 3 (Chile)	Brand Name	Motorola (Salom)	Model Name	SC-42
	Power Rating	I/P: 100-240 Vac, 300mA ,50/60HZ O/P: 5Vdc, 2000mA		
AC Adapter 3(BR)	Brand Name	Motorola(Salom)	Model Name	SC-47
	Power Rating	I/P: 100-240 Vac, 300mA ,50/60HZ O/P: 5Vdc, 2000mA		
AC Adapter 3(BR)	Brand Name	Motorola(Salom/Flex)	Model Name	SC-47
	Power Rating	I/P: 100-240 Vac, 300mA ,50/60HZ O/P: 5Vdc, 2000mA		
AC Adapter 4(BR)	Brand Name	Motorola(Cliptech/Tenpao)	Model Name	SC-47
	Power Rating	I/P: 100-240 Vac, 300mA ,50/60HZ O/P: 5Vdc, 2000mA		
Battery	Brand Name	Motorola (ATL)	Model Name	KG40
	Power Rating	3.8Vdc, 4000mAh	Type	Li-ion, Polymer



Earphone 1	Brand Name	Motorola(Lianyun)	Model Name	LYM500B-36C-001
	Signal Line Type	1.1 meter, non-shielded cable, without ferrite core		
Earphone 2	Brand Name	Motorola(Lianyun)	Model Name	SH38C37773
	Signal Line Type	1.1 meter, non-shielded cable, without ferrite core		
Earphone 3	Brand Name	Motorola(Cosonic)	Model Name	SH38C44959
	Signal Line Type	1.1 meter, non-shielded cable, without ferrite core		
USB Cable 1	Brand Name	Motorola (LiQi)	Model Name	L52B-053000100
	Signal Line Type	1.0 meter, shielded cable, without ferrite core		
USB Cable 2	Brand Name	Motorola (SaiBao)	Model Name	S52B-053000100
	Signal Line Type	1.0 meter, shielded cable, without ferrite core		
USB Cable 3	Brand Name	Motorola (I SHENG)	Model Name	SC18C28955
	Signal Line Type	1.0 meter, shielded cable, without ferrite core		

1.6. Modification of EUT

No modifications are made to the EUT during all test items.

1.7. Testing Location

Sporton International (Kunshan) Inc. is accredited to ISO/IEC 17025:2017 by American Association for Laboratory Accreditation with Certificate Number 5145.02.

Test Firm	Sporton International (Kunshan) Inc.		
Test Site Location	No. 1098, Pengxi North Road, Kunshan Economic Development Zone Jiangsu Province 215300 People's Republic of China TEL : +86-512-57900158 FAX : +86-512-57900958		
Test Site No.	Sporton Site No.	FCC Designation No.	FCC Test Firm Registration No.
	CO01-KS 03CH02-KS TH01-KS	CN1257	314309

1.8. Test Software

Item	Site	Manufacture	Name	Version
1.	03CH02-KS	AUDIX	E3	6.2009-8-24a
2.	CO01-KS	AUDIX	E3	6.2009-8-24



1.9. Applicable Standards

According to the specifications of the manufacturer, the EUT must comply with the requirements of the following standards:

- ♦ 47 CFR Part 15 Subpart C §15.247
- ♦ FCC KDB 558074 D01 15.247 Meas Guidance v05r02
- ♦ ANSI C63.10-2013

Remark:

1. All test items were verified and recorded according to the standards and without any deviation during the test.
2. This EUT has also been tested and complied with the requirements of FCC Part 15, Subpart B, recorded in a separate test report.



2 Test Configuration of Equipment Under Test

2.1. Carrier Frequency Channel

Frequency Band	Channel	Freq. (MHz)	Channel	Freq. (MHz)	Channel	Freq. (MHz)
2400-2483.5 MHz	0	2402	27	2429	54	2456
	1	2403	28	2430	55	2457
	2	2404	29	2431	56	2458
	3	2405	30	2432	57	2459
	4	2406	31	2433	58	2460
	5	2407	32	2434	59	2461
	6	2408	33	2435	60	2462
	7	2409	34	2436	61	2463
	8	2410	35	2437	62	2464
	9	2411	36	2438	63	2465
	10	2412	37	2439	64	2466
	11	2413	38	2440	65	2467
	12	2414	39	2441	66	2468
	13	2415	40	2442	67	2469
	14	2416	41	2443	68	2470
	15	2417	42	2444	69	2471
	16	2418	43	2445	70	2472
	17	2419	44	2446	71	2473
	18	2420	45	2447	72	2474
	19	2421	46	2448	73	2475
	20	2422	47	2449	74	2476
	21	2423	48	2450	75	2477
	22	2424	49	2451	76	2478
	23	2425	50	2452	77	2479
	24	2426	51	2453	78	2480
	25	2427	52	2454	-	-
	26	2428	53	2455	-	-



2.2. Test Mode

- a. The EUT has been associated with peripherals and configuration operated in a manner tended to maximize its emission characteristics in a typical application. Frequency range investigated: conduction emission (150 kHz to 30 MHz), radiation emission (9 kHz to the 10th harmonic of the highest fundamental frequency or to 40 GHz, whichever is lower). For radiated measurement, pre-scanned in three orthogonal panels, X, Y, Z. The worst cases (X plane) were recorded in this report, and the worst mode of radiated spurious emissions is Bluetooth 3Mbps mode, and recorded in this report.
- b. AC power line Conducted Emission was tested under maximum output power.

The following summary table is showing all test modes to demonstrate in compliance with the standard.

Summary table of Test Cases			
Test Item	Data Rate / Modulation		
	Bluetooth BR 1Mbps GFSK	Bluetooth EDR 2Mbps $\pi/4$ -DQPSK	Bluetooth EDR 3Mbps 8-DPSK
Conducted Test Cases	Mode 1: CH00_2402 MHz	Mode 4: CH00_2402 MHz	Mode 7: CH00_2402 MHz
	Mode 2: CH39_2441 MHz	Mode 5: CH39_2441 MHz	Mode 8: CH39_2441 MHz
	Mode 3: CH78_2480 MHz	Mode 6: CH78_2480 MHz	Mode 9: CH78_2480 MHz
Radiated Test Cases	Bluetooth EDR 3Mbps 8-DPSK		
	Mode 1: CH00_2402 MHz		
	Mode 2: CH39_2441 MHz		
Mode 3: CH78_2480 MHz			
AC Conducted Emission	Mode 1 : GSM 850 Idle + Bluetooth Link + WLAN Link (2.4G) + USB Cable 2(Charging from Adapter 4) + Earphone 2		
Remark: 1. For radiated test cases, the worst mode data rate 3Mbps was reported only, because this data rate has the highest RF output power at preliminary tests, and no other significantly frequencies found in conducted spurious emission..			

2.3. Connection Diagram of Test System

For Radiation

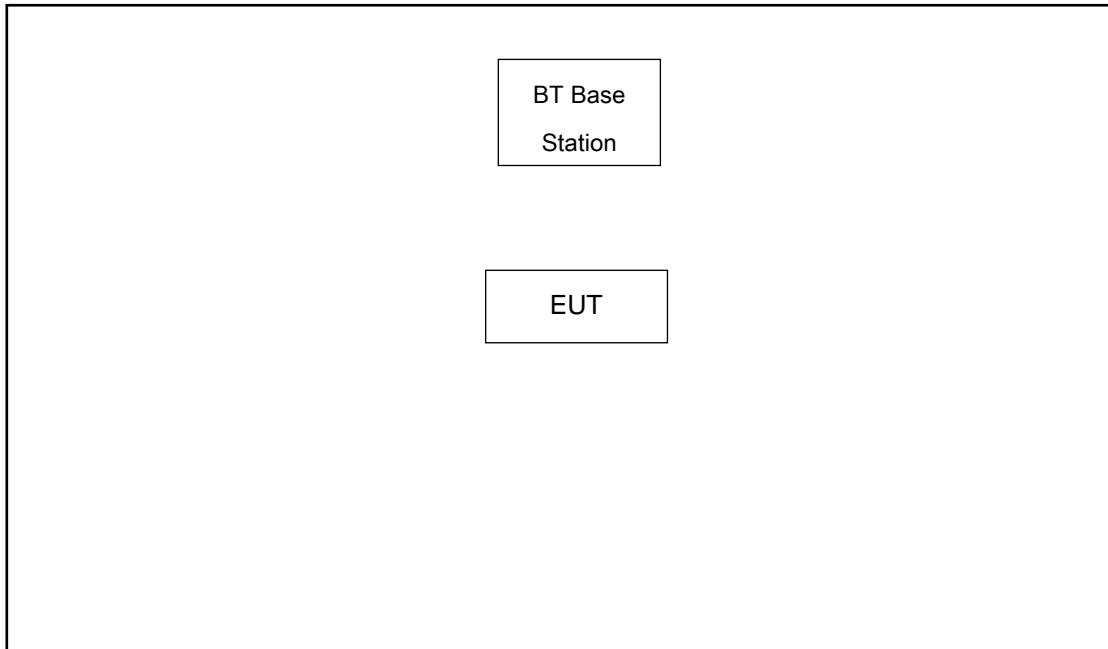

For Conducted Emission

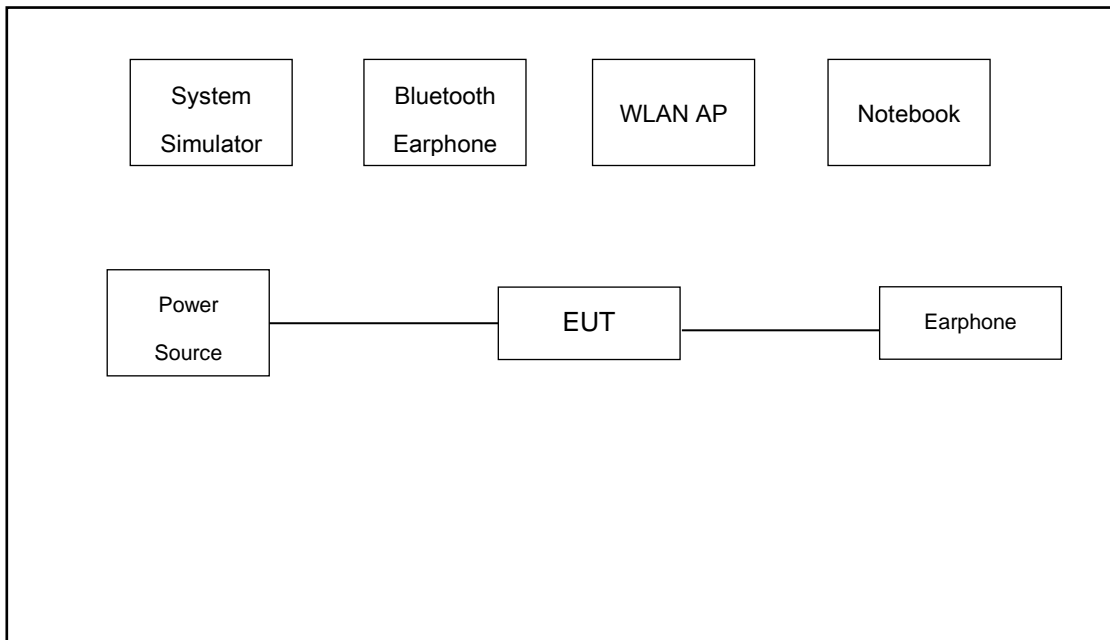

2.4. Support Unit used in test configuration and system

Item	Equipment	Trade Name	Model Name	FCC ID	Data Cable	Power Cord
1.	System Simulator	Anritsu	MT8820C	N/A	N/A	Unshielded, 1.8m
2.	BT Base Station	R&S	CBT	N/A	N/A	Unshielded, 1.8 m
3.	WLAN AP	D-link	DIR-655	KA21R655B1	N/A	Unshielded, 1.8m
4.	Bluetooth Earphone	Lenovo	LBH308	N/A	N/A	N/A
5.	Notebook	Lenovo	G480	QDS-BRCM1050I	N/A	AC I/P: Unshielded, 1.8 m DC O/P: Shielded, 1.8 m
6.	SD Card	Kingston	8GB	N/A	N/A	N/A

2.5. EUT Operation Test Setup

For Bluetooth function, the engineering test program was provided and enabled to make EUT connect with Bluetooth base station to continuous transmit/receive.

For AC power line conducted emissions, the EUT was set to connect with the WLAN AP under large package sizes transmission.

2.6. Measurement Results Explanation Example

For all conducted test items:

The offset level is set in the spectrum analyzer to compensate the RF cable loss and attenuator factor between EUT conducted output port and spectrum analyzer. With the offset compensation, the spectrum analyzer reading level is exactly the EUT RF output level.

Example:

The spectrum analyzer offset is derived from RF cable loss and attenuator factor.

Offset = RF cable loss + attenuator factor.

Following shows an offset computation example with cable loss 6.4 dB.

$$\begin{aligned} \text{Offset(dB)} &= \text{RF cable loss(dB)} . \\ &= 6.4 \text{ (dB)} \end{aligned}$$

3 Test Result

3.1. Number of Channel Measurement

3.1.1 Limits of Number of Hopping Frequency

Frequency hopping systems in the 2400-2483.5 MHz band shall use at least 15 channels.

3.1.2 Measuring Instruments

The measuring equipment is listed in the section 4 of this test report.

3.1.3 Test Procedure

1. The testing follows ANSI C63.10-2013 clause 7.8.3.
2. The RF output of EUT was connected to the spectrum analyzer by RF cable and attenuator. The path loss was compensated to the results for each measurement.
3. Set to the maximum power setting and enable the EUT transmit continuously.
4. Enable the EUT hopping function.
5. Use the following spectrum analyzer settings: Span = the frequency band of operation; RBW = 300kHz; VBW \geq RBW; Sweep = auto; Detector function = peak; Trace = max hold.
6. The number of hopping frequency used is defined as the number of total channel.
7. Record the measurement data derived from spectrum analyzer.

3.1.4 Test Setup

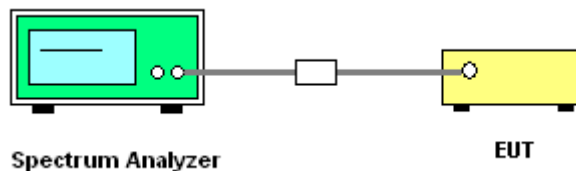



3.1.5 Test Result of Number of Hopping Frequency

Please refer to Appendix A.

Number of Hopping Channel Plot on Channel 00 - 78

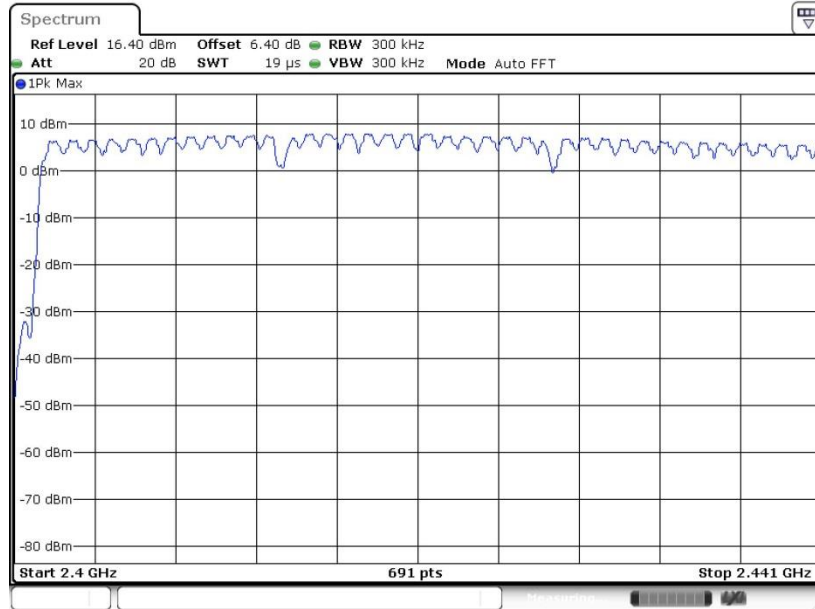

Date: 4.NOV.2019 17:07:34

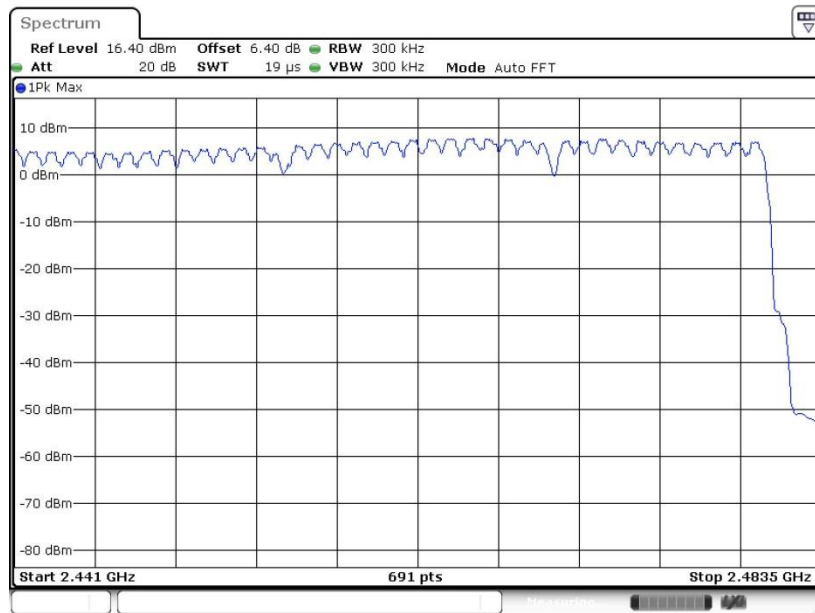

Date: 4.NOV.2019 17:09:02

3.2. Hopping Channel Separation Measurement

3.2.1 Limit of Hopping Channel Separation

Frequency hopping systems operating in the 2400-2483.5 MHz band may have hopping channel carrier frequencies that are separated by 25 kHz or two-thirds of the 20 dB bandwidth of the hopping channel, whichever is greater.

3.2.2 Measuring Instruments

The measuring equipment is listed in the section 4 of this test report.

3.2.3 Test Procedures

1. The testing follows ANSI C63.10-2013 clause 7.8.2.
2. The RF output of EUT was connected to the spectrum analyzer by RF cable and attenuator. The path loss was compensated to the results for each measurement.
3. Set to the maximum power setting and enable the EUT transmit continuously.
4. Enable the EUT hopping function.
5. Use the following spectrum analyzer settings:
Span = wide enough to capture the peaks of two adjacent channels;
RBW = 300kHz; VBW \geq RBW; Sweep = auto; Detector function = peak; Trace = max hold.
6. Measure and record the results in the test report.

3.2.4 Test Setup





3.2.5 Test Result of Hopping Channel Separation

Please refer to Appendix A.

<1Mbps>

Channel Separation Plot on Channel 00 - 01

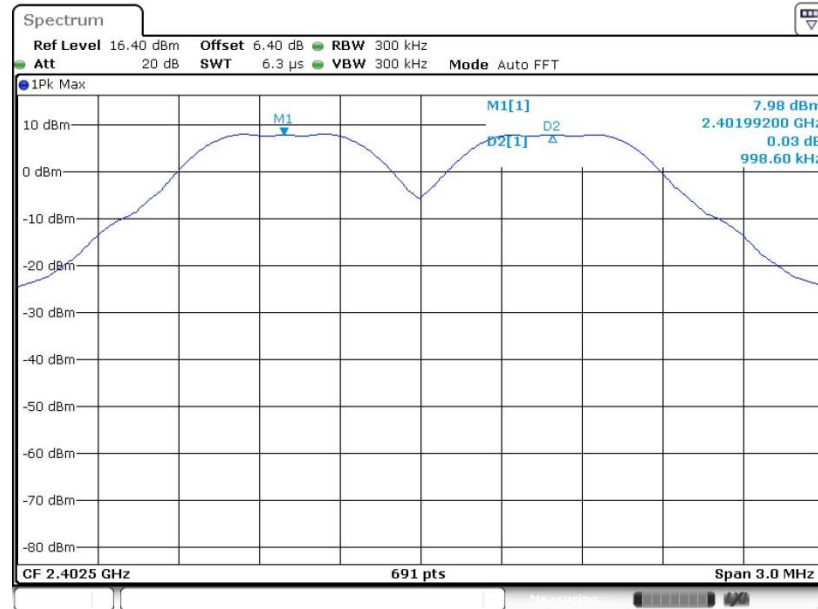

Date: 4.NOV.2019 16:26:38

Channel Separation Plot on Channel 39 - 40

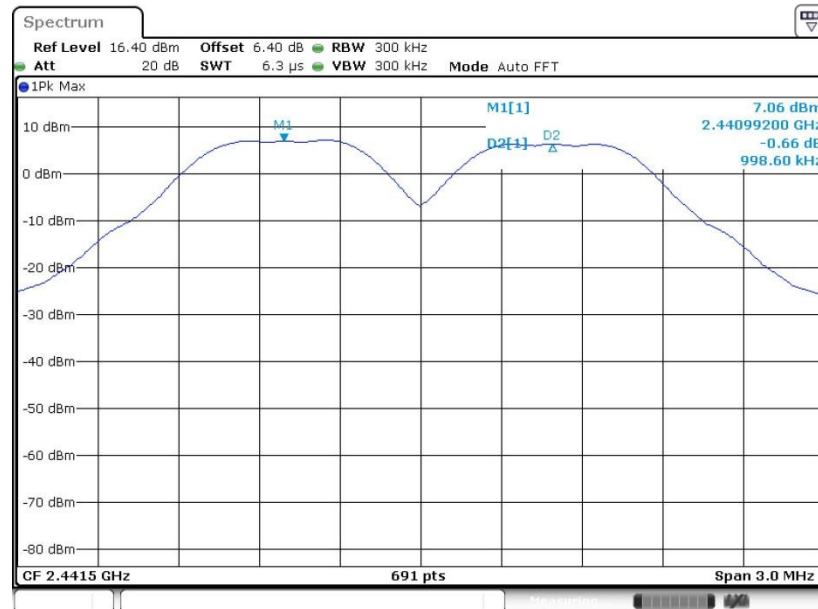

Date: 4.NOV.2019 16:32:58



Channel Separation Plot on Channel 77 - 78

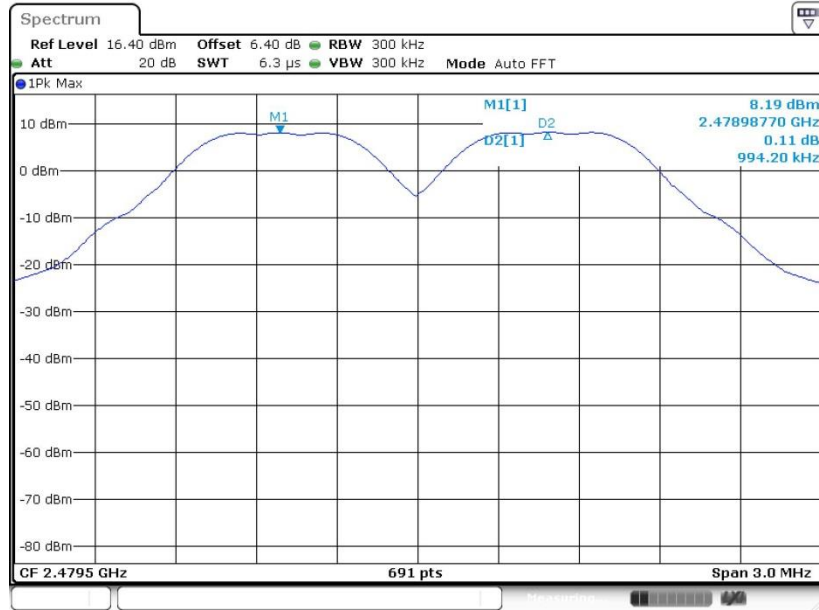

Date: 4.NOV.2019 16:37:27

<2Mbps>

Channel Separation Plot on Channel 00 - 01

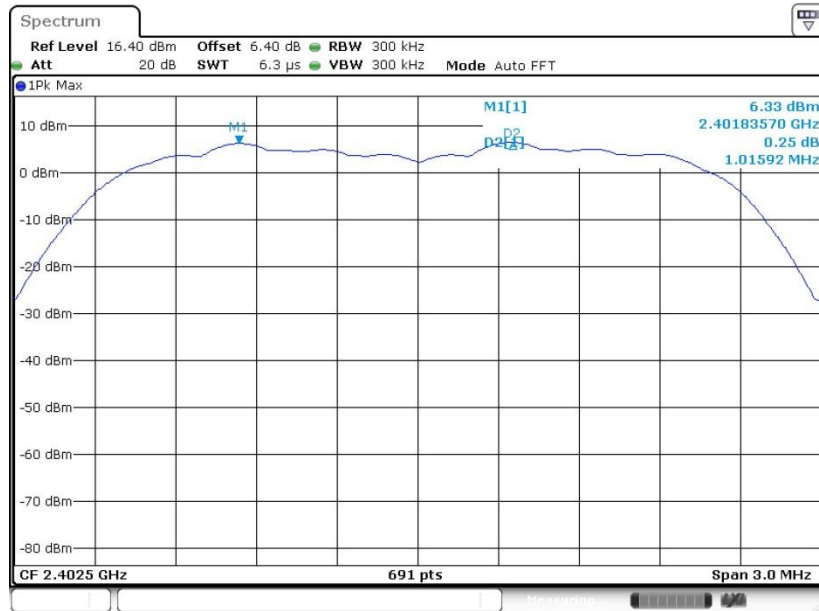

Date: 7.NOV.2019 09:08:37



Channel Separation Plot on Channel 39 - 40

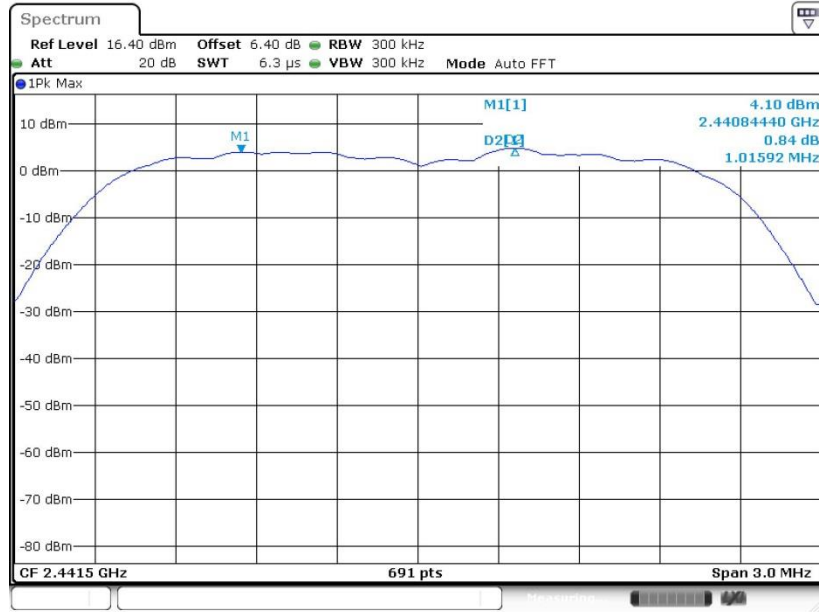

Date: 7.NOV.2019 09:07:01

Channel Separation Plot on Channel 77 - 78

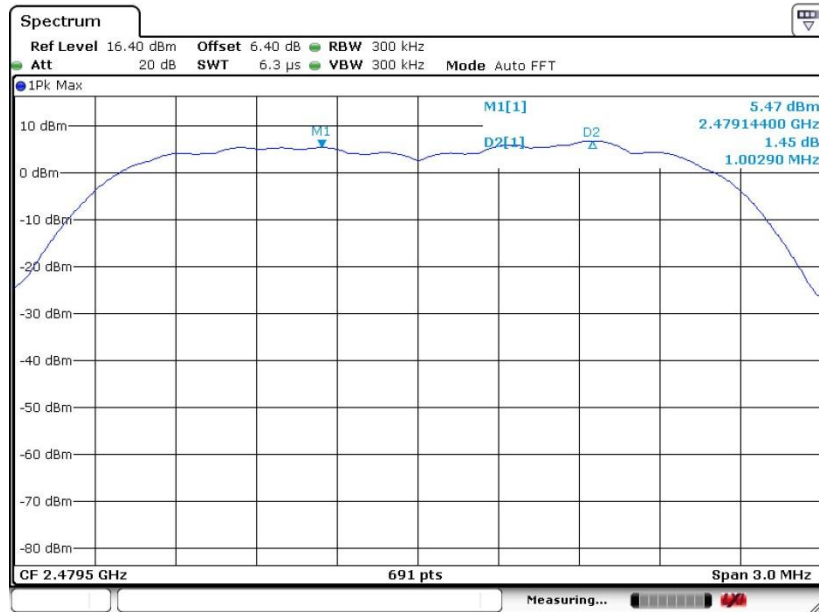

Date: 7.NOV.2019 09:11:55



<3Mbps>

Channel Separation Plot on Channel 00 - 01

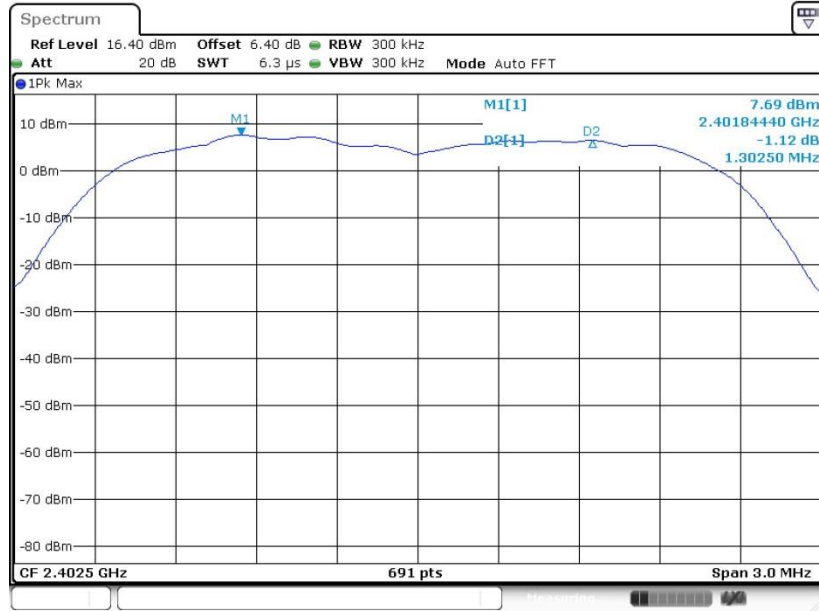

Date: 4.NOV.2019 17:01:41

Channel Separation Plot on Channel 39 - 40

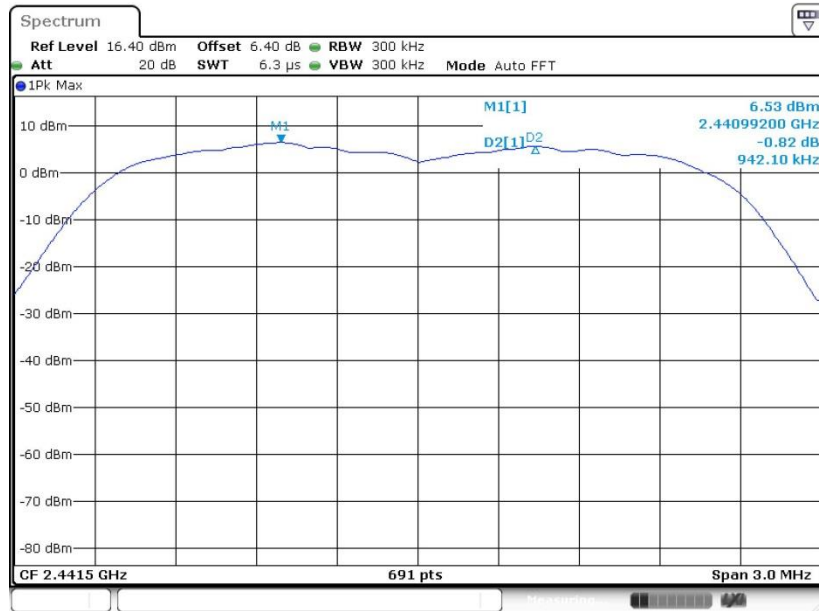

Date: 4.NOV.2019 17:10:06



Channel Separation Plot on Channel 77 - 78

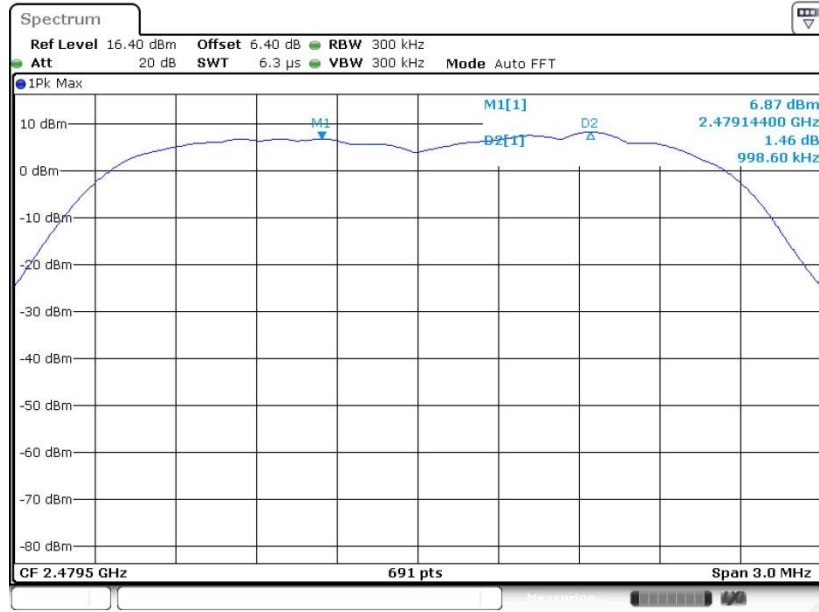

Date: 4.NOV.2019 17:14:12

3.3. Dwell Time Measurement

3.3.1 Limit of Dwell Time

The average time of occupancy on any channel shall not be greater than 0.4 seconds within a period of 0.4 seconds multiplied by the number of hopping channels employed.

3.3.2 Measuring Instruments

The measuring equipment is listed in the section 4 of this test report.

3.3.3 Test Procedures

1. The testing follows ANSI C63.10-2013 clause 7.8.4.
2. The RF output of EUT was connected to the spectrum analyzer by RF cable and attenuator. The path loss was compensated to the results for each measurement.
3. Set to the maximum power setting and enable the EUT transmit continuously.
4. Enable the EUT hopping function.
5. Use the following spectrum analyzer settings: Span = zero span, centered on a hopping channel; RBW = 1 MHz; VBW \geq RBW; Sweep = as necessary to capture the entire dwell time per hopping channel; Detector function = peak; Trace = max hold.
6. Measure and record the results in the test report.

3.3.4 Test Setup



3.3.5 Test Result of Dwell Time

Please refer to Appendix A.

Package Transfer Time Plot

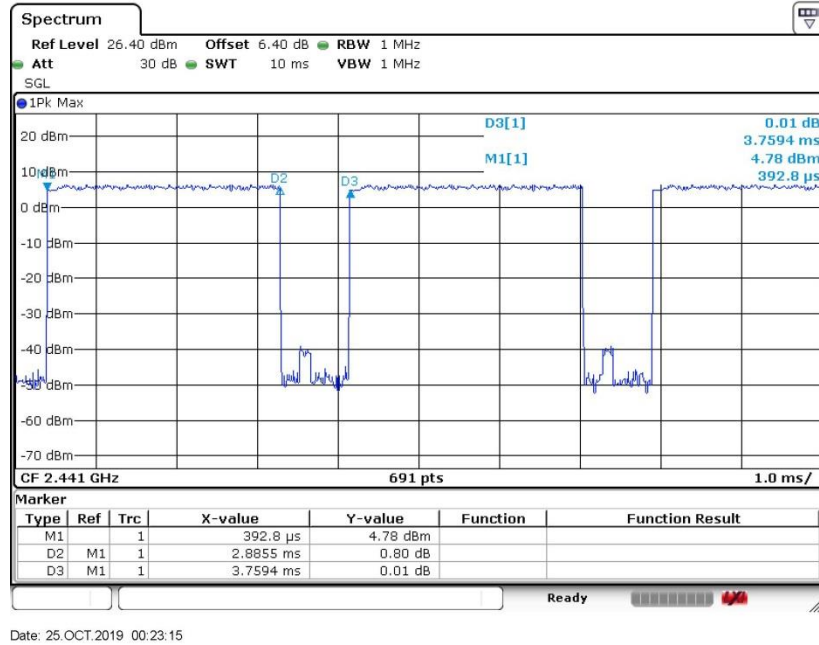

Remark:

1. In normal mode, hopping rate is 1600 hops/s with 6 slots (5 Transmit and 1 Receive slot) in 79 hopping channels.
 With channel hopping rate (1600 / 6 / 79) in Occupancy Time Limit (0.4 x 79) (s),
 Hops Over Occupancy Time comes to (1600 / 6 / 79) x (0.4 x 79) = 106.67 hops.
2. In AFH mode, hopping rate is 800 hops/s with 6 slots in 20 hopping channels.
 With channel hopping rate (800 / 6 / 20) in Occupancy Time Limit (0.4 x 20) (s),
 Hops Over Occupancy Time comes to (800 / 6 / 20) x (0.4 x 20) = 53.33 hops.
3. Dwell Time(s) = Hops Over Occupancy Time (hops) x Package Transfer Time

3.4. 20dB Bandwidth Measurement

3.4.1 Limit of 20dB Bandwidth

Reporting only

3.4.2 Measuring Instruments

The measuring equipment is listed in the section 4 of this test report.

3.4.3 Test Procedures

1. The testing follows ANSI C63.10-2013 clause 6.9.2 and 6.9.3.
2. The RF output of EUT was connected to the spectrum analyzer by RF cable and attenuator. The path loss was compensated to the results for each measurement.
3. Set to the maximum power setting and enable the EUT transmit continuously.
4. Use the following spectrum analyzer settings for 20dB Bandwidth measurement.
Span = approximately 2 to 5 times the 20 dB bandwidth, centered on a hopping channel;
RBW \geq 1% of the 20 dB bandwidth; VBW \geq RBW; Sweep = auto; Detector function = peak;
Trace = max hold.
5. Measure and record the results in the test report.

3.4.4 Test Setup

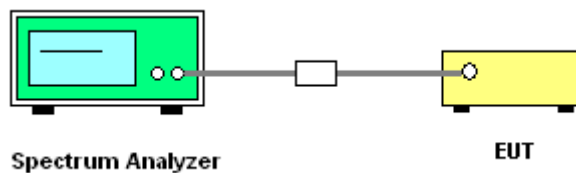



3.4.5 Test Result of 20dB Bandwidth

Please refer to Appendix A.

<1Mbps>

20 dB Bandwidth Plot on Channel 00

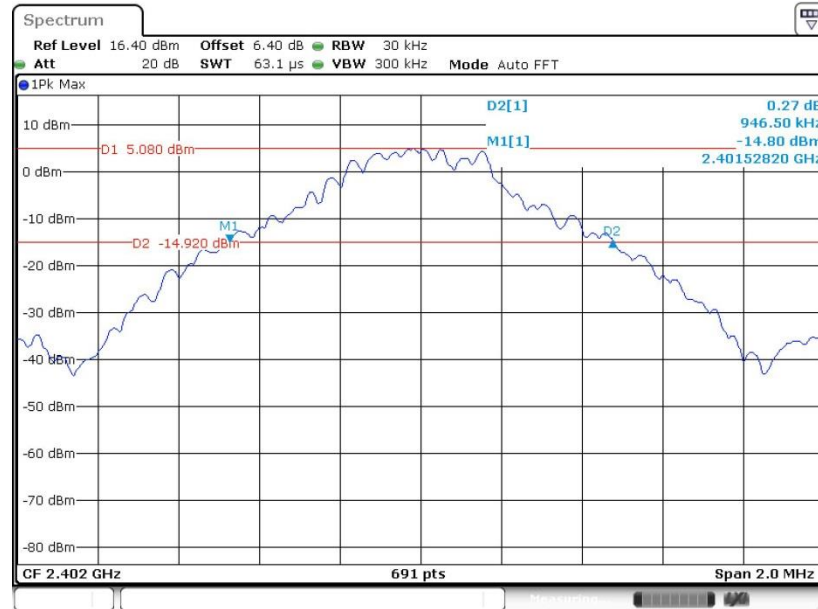

Date: 4.NOV.2019 16:28:02

20 dB Bandwidth Plot on Channel 39

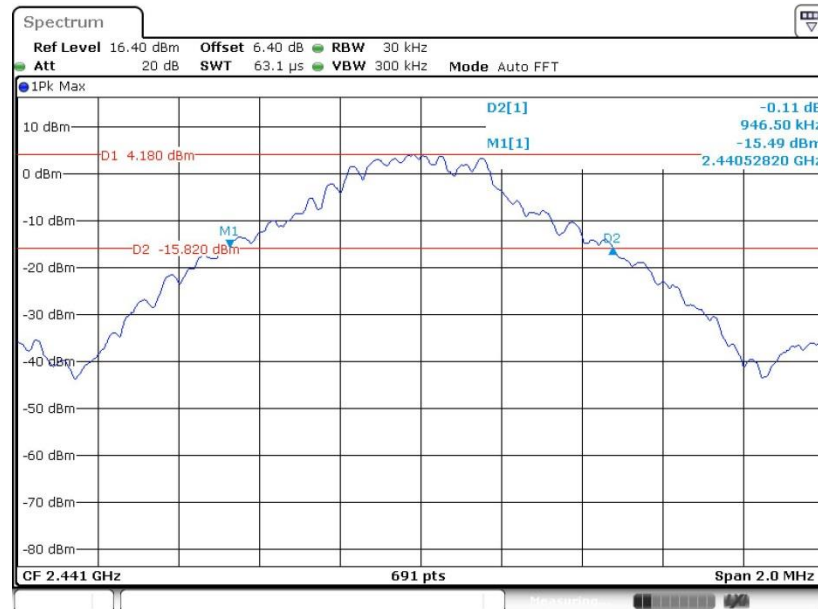

Date: 4.NOV.2019 16:33:48



20 dB Bandwidth Plot on Channel 78



Date: 4.NOV.2019 16:38:36

<2Mbps>

20 dB Bandwidth Plot on Channel 00

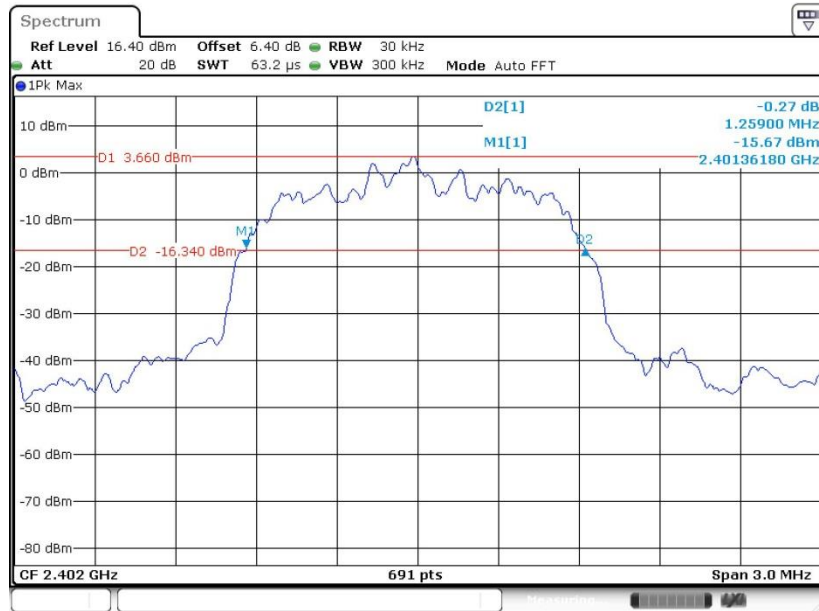

Date: 4.NOV.2019 16:44:44



20 dB Bandwidth Plot on Channel 39

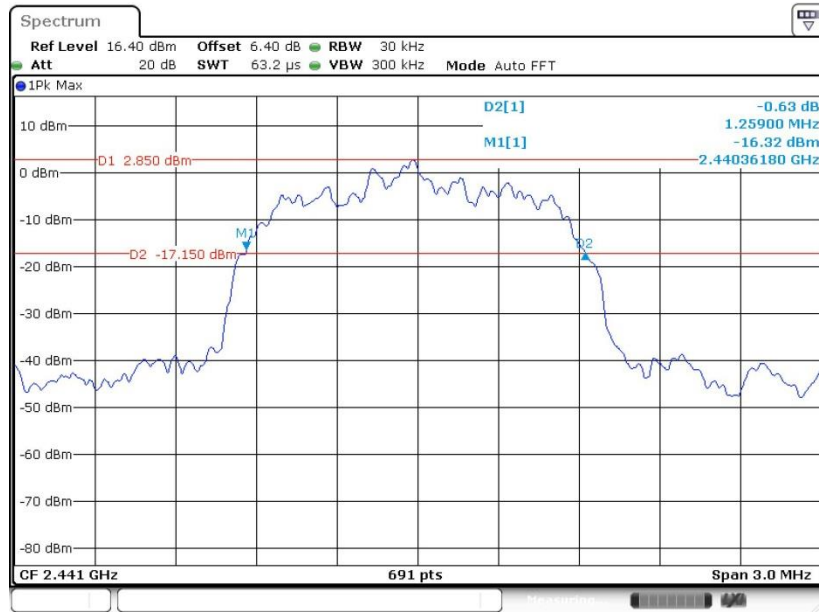

Date: 4.NOV.2019 16:52:19

20 dB Bandwidth Plot on Channel 78

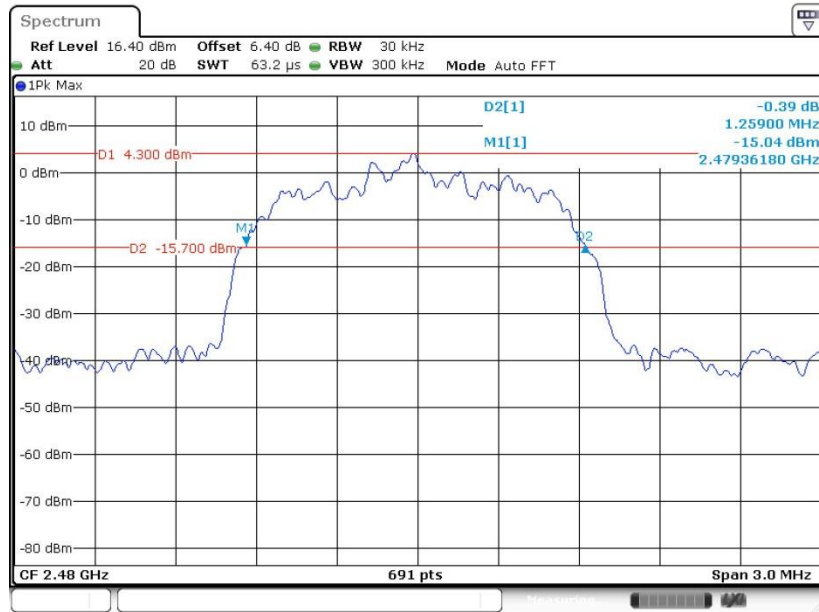

Date: 4.NOV.2019 16:56:59



<3Mbps>

20 dB Bandwidth Plot on Channel 00

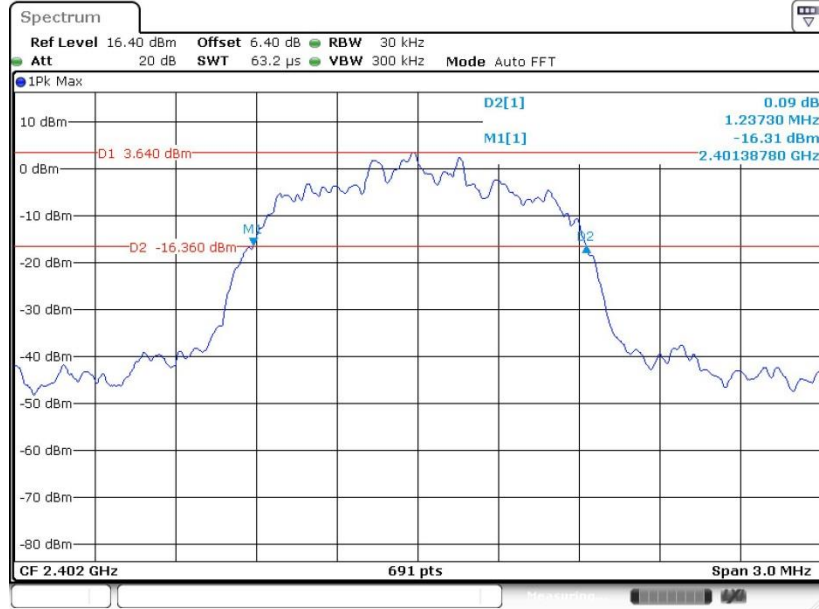

Date: 4.NOV.2019 17:02:39

20 dB Bandwidth Plot on Channel 39

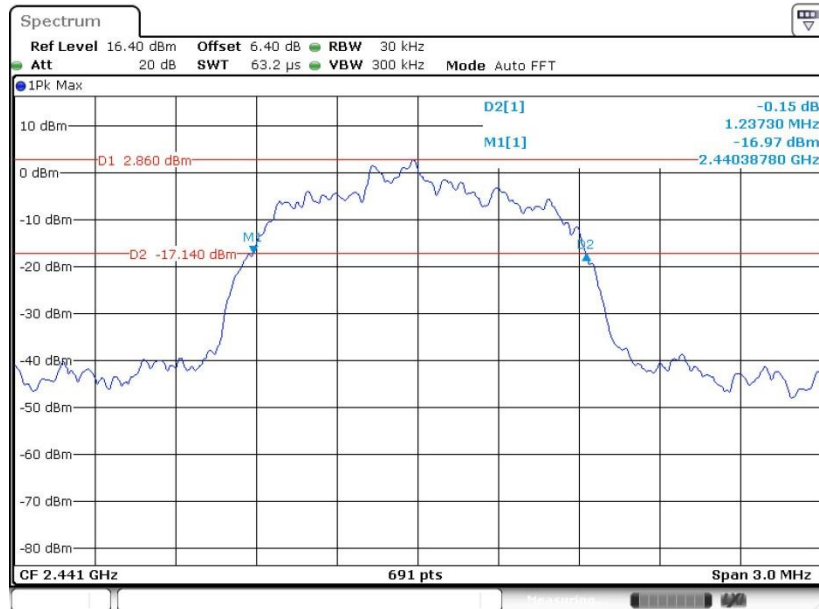

Date: 4.NOV.2019 17:11:23



20 dB Bandwidth Plot on Channel 78

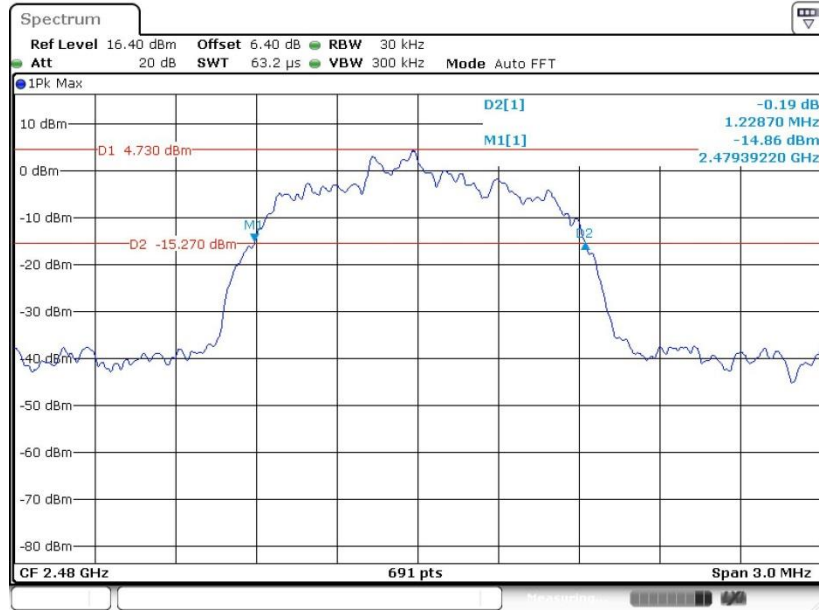

Date: 4 NOV.2019 17:14:57

3.5. Output Power Measurement

3.5.1 Limit of Output Power

The maximum peak conducted output power of the intentional radiator shall not exceed the following:
(1) For frequency hopping systems operating in the 2400-2483.5 MHz band employing at least 75 non-overlapping hopping channels, and all frequency hopping systems in the 5725-5850 MHz band: 1 watt. For all other frequency hopping systems in the 2400-2483.5 MHz band 0.125 watts. The power limit for 1Mbps, 2Mbps, 3Mbps and AFH modes are 0.125 watts.

3.5.2 Measuring Instruments

The measuring equipment is listed in the section 4 of this test report.

3.5.3 Test Procedures

1. The testing follows ANSI C63.10-2013 clause 7.8.5.
2. The RF output of EUT was connected to the power meter by RF cable and attenuator. The path loss was compensated to the results for each measurement.
3. Set to the maximum power setting and enable the EUT transmit continuously.
4. Measure the conducted output power with cable loss and record the results in the test report.
5. Measure and record the results in the test report.

3.5.4 Test Setup

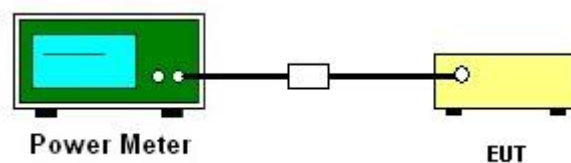

3.5.5 Test Result of Peak Output Power

Please refer to Appendix A.

3.5.6 Test Result of Average Output Power (Reporting Only)

Please refer to Appendix A.

3.6. Conducted Band Edges Measurement

3.6.1 Limit of Band Edges

In any 100 kHz bandwidth outside the intentional radiation frequency band, the radio frequency power shall be at least 20 dB below the highest level of the radiated power. In addition, radiated emissions which fall in the restricted bands must also comply with the radiated emission limits.

3.6.2 Measuring Instruments

The measuring equipment is listed in the section 4 of this test report.

3.6.3 Test Procedures

1. The testing follows ANSI C63.10-2013 clause 7.8.6.
2. Set to the maximum power setting and enable the EUT transmit continuously.
3. Set RBW = 100kHz, VBW = 300kHz. Band edge emissions must be at least 20 dB down from the highest emission level within the authorized band as measured with a 100kHz RBW. The attenuation shall be 30 dB instead of 20 dB when RMS conducted output power procedure is used.
4. Enable hopping function of the EUT and then repeat step 2. and 3.
5. Measure and record the results in the test report.

3.6.4 Test Setup





3.6.5 Test Result of Conducted Band Edges

<1Mbps>

Low Band Edge Plot on Channel 00

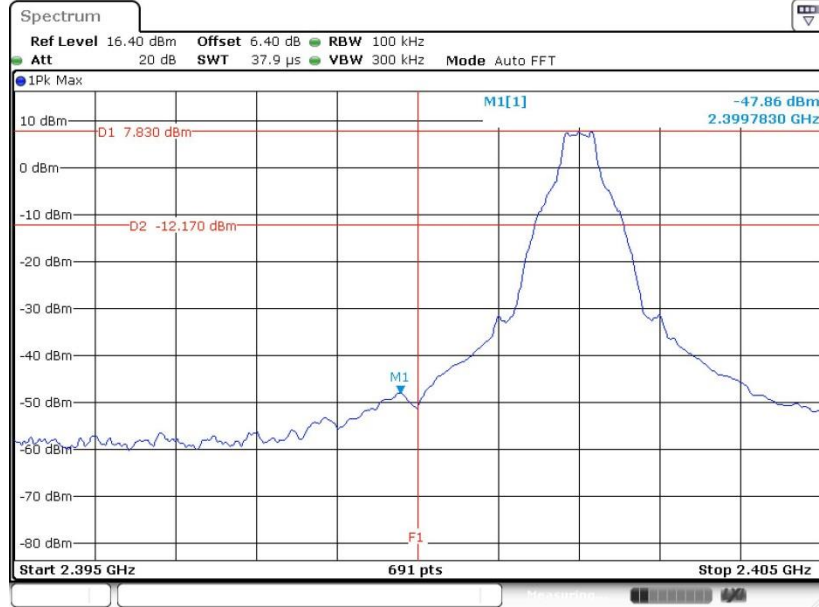

Date: 7.NOV.2019 08:58:23

High Band Edge Plot on Channel 78

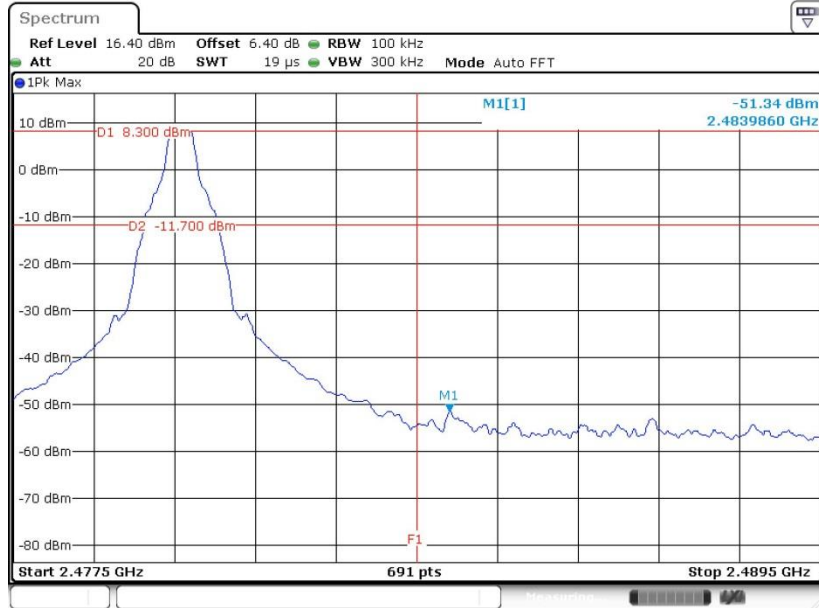

Date: 4.NOV.2019 16:39:00



<2Mbps>

Low Band Edge Plot on Channel 00

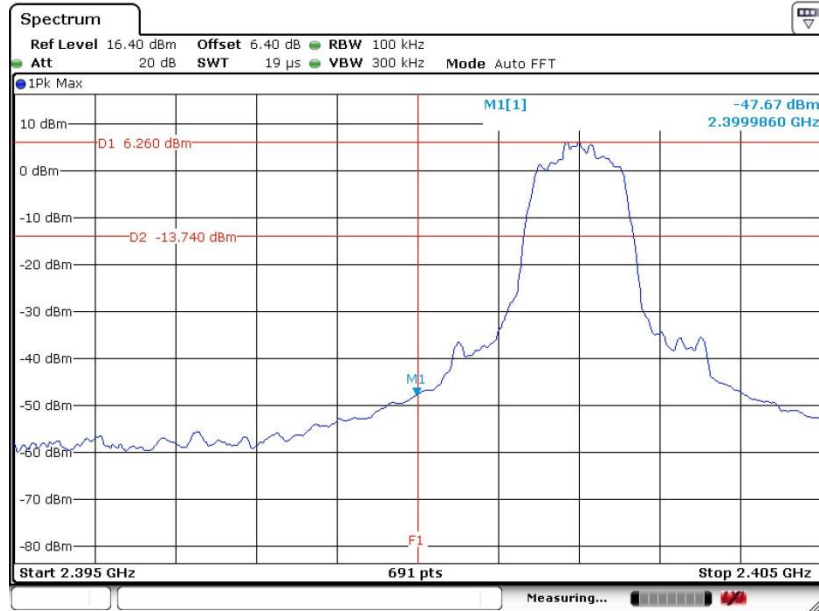

Date: 4.NOV.2019 16:47:45

High Band Edge Plot on Channel 78

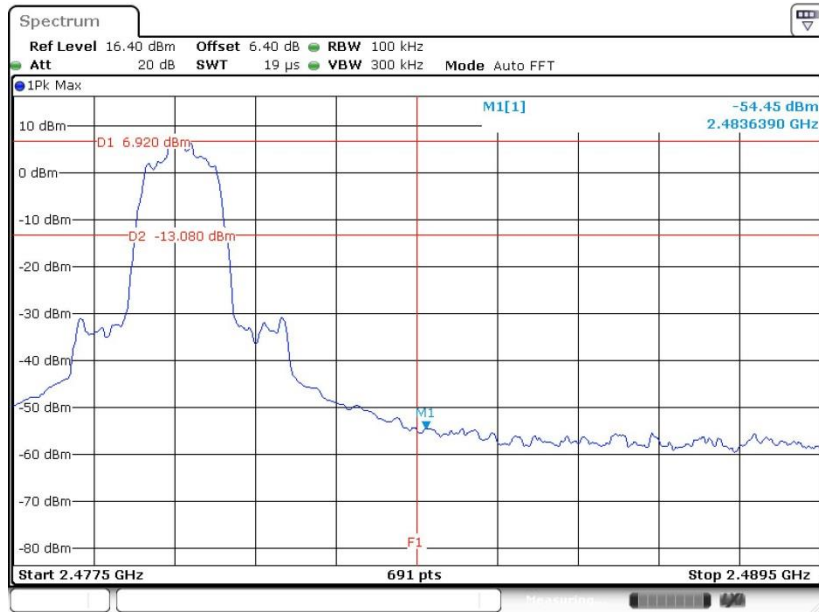

Date: 4.NOV.2019 16:57:23



<3Mbps>

Low Band Edge Plot on Channel 00

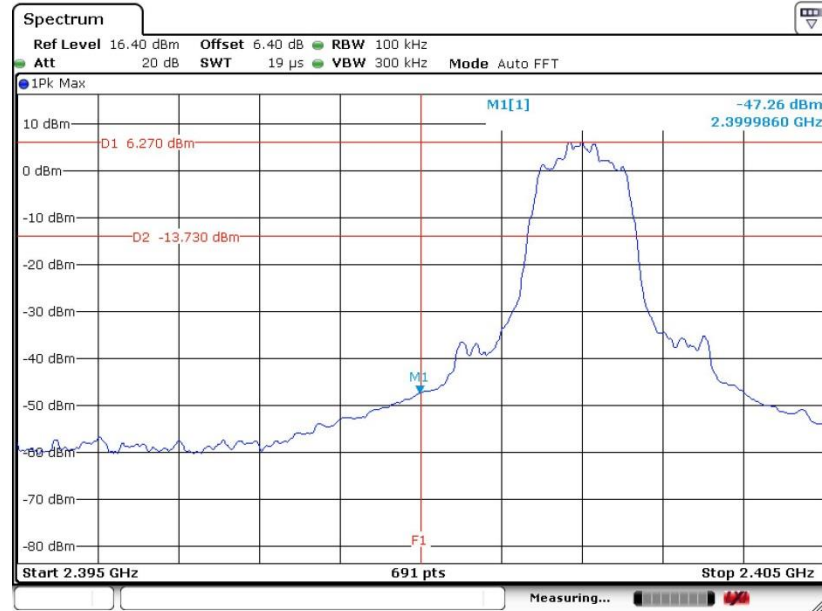

Date: 4.NOV.2019 17:03:16

High Band Edge Plot on Channel 78

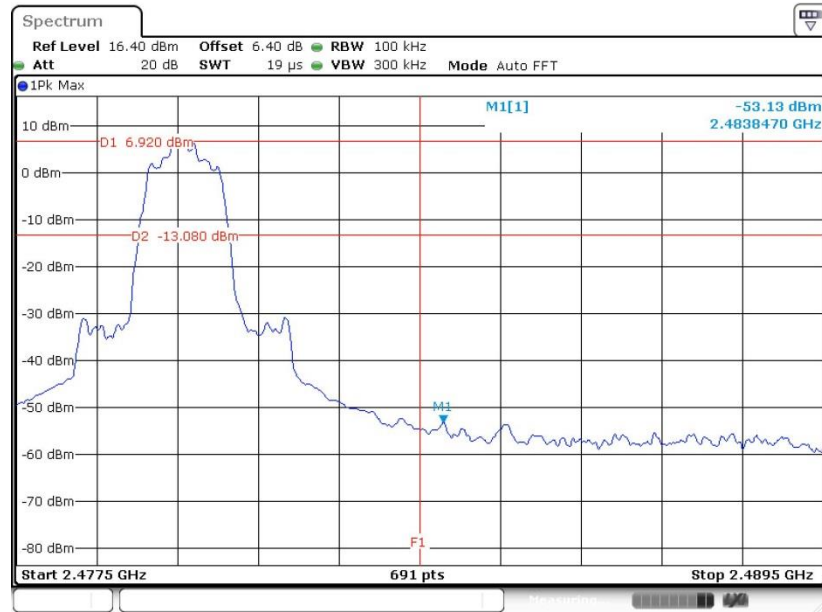

Date: 4.NOV.2019 17:15:17



3.6.6 Test Result of Conducted Hopping Mode Band Edges

<1Mbps>

Hopping Mode Low Band Edge Plot

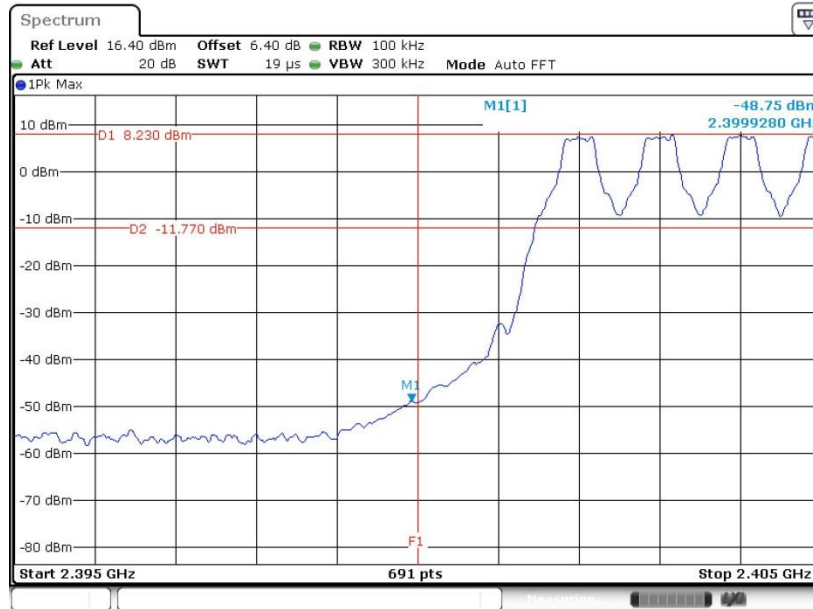

Date: 4.NOV.2019 16:31:26

Hopping Mode High Band Edge Plot

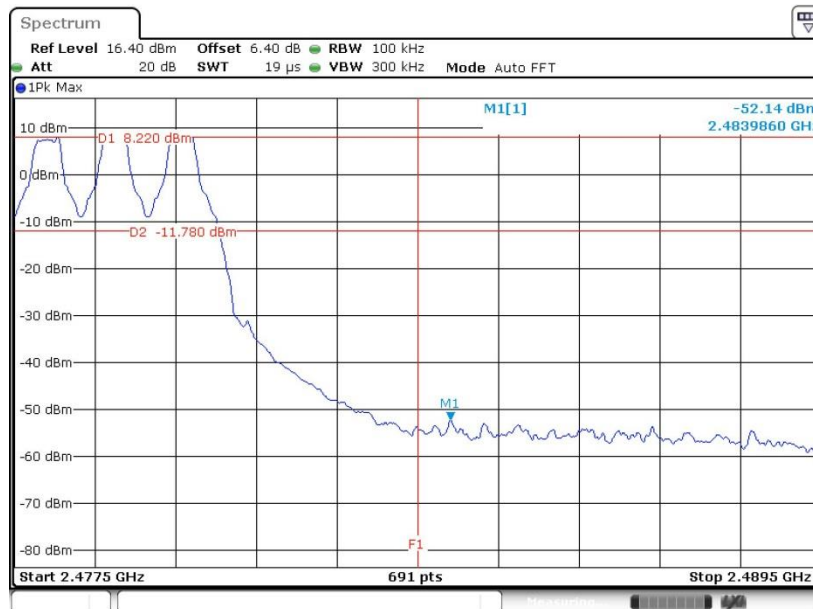

Date: 4.NOV.2019 16:42:12



<2Mbps>

Hopping Mode Low Band Edge Plot

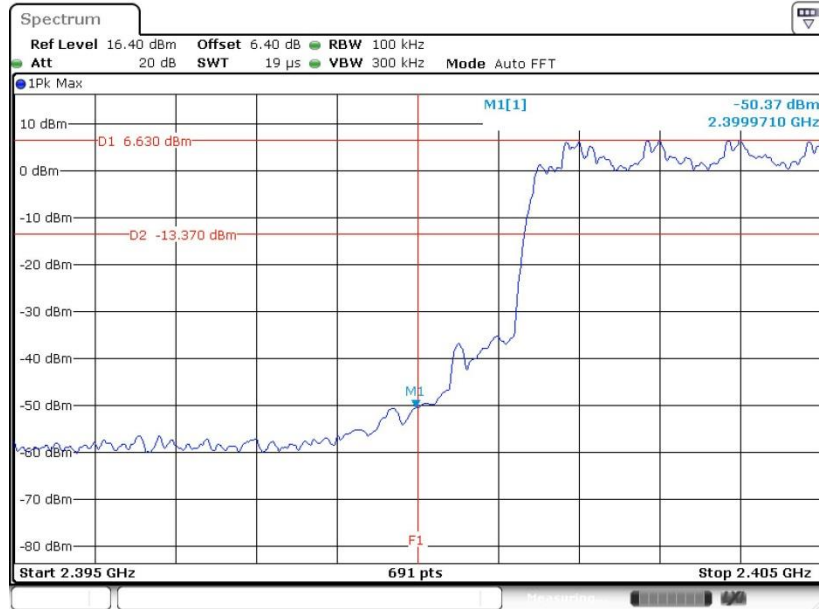

Date: 4.NOV.2019 16:49:52

Hopping Mode High Band Edge Plot

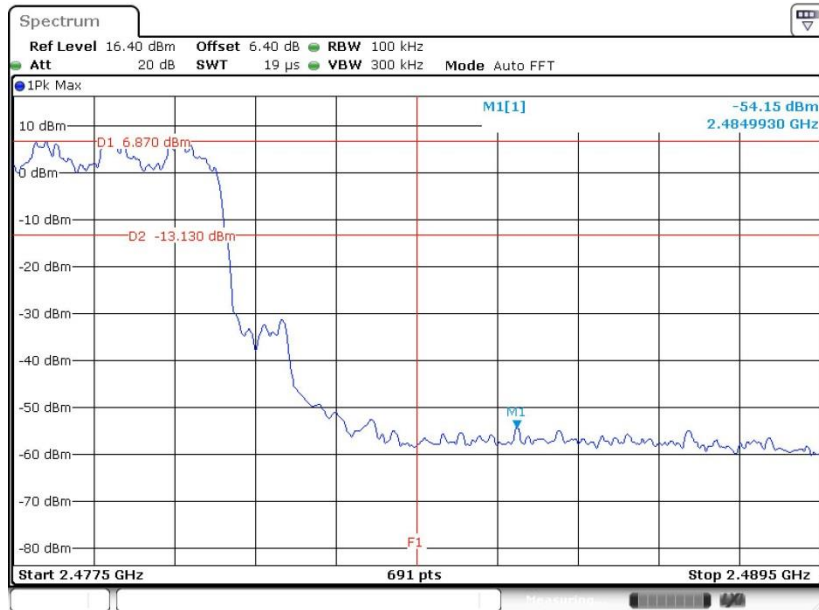

Date: 4.NOV.2019 16:59:27



<3Mbps>

Hopping Mode Low Band Edge Plot

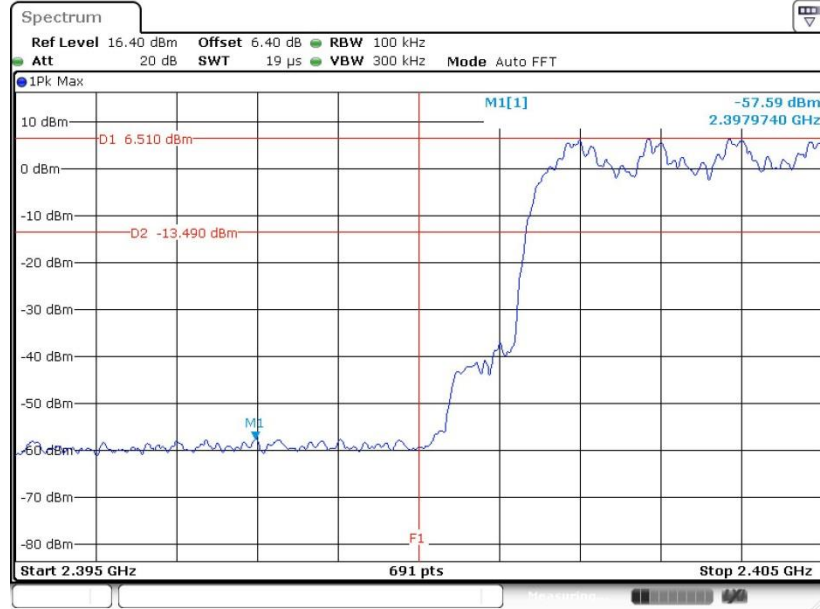

Date: 4.NOV.2019 17:06:09

Hopping Mode High Band Edge Plot

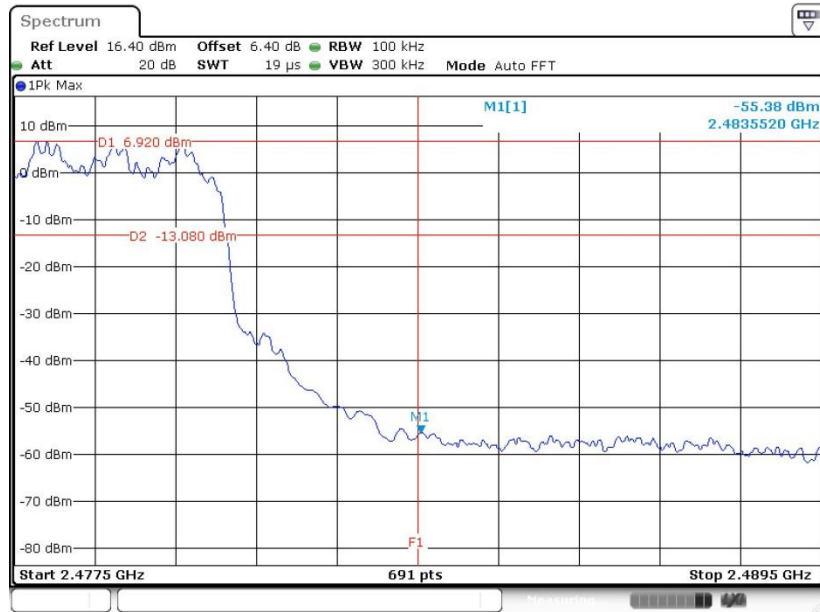

Date: 4.NOV.2019 17:17:25

3.7. Conducted Spurious Emission Measurement

3.7.1 Limit of Spurious Emission Measurement

In any 100 kHz bandwidth outside the intentional radiation frequency band, the radio frequency power shall be at least 20 dB below the highest level of the radiated power. In addition, radiated emissions which fall in the restricted bands must also comply with the radiated emission limits.

3.7.2 Measuring Instruments

The measuring equipment is listed in the section 4 of this test report.

3.7.3 Test Procedure

1. The testing follows ANSI C63.10-2013 clause 7.8.8.
2. The RF output of EUT was connected to the spectrum analyzer by RF cable and attenuator. The path loss was compensated to the results for each measurement.
3. Set to the maximum power setting and enable the EUT transmit continuously.
4. Set RBW = 100 kHz, VBW = 300kHz, scan up through 10th harmonic. All harmonics / spurs must be at least 20 dB down from the highest emission level within the authorized band as measured with a 100 kHz RBW.
5. Measure and record the results in the test report.
6. The RF fundamental frequency should be excluded against the limit line in the operating frequency band.

3.7.4 Test Setup





3.7.5 Test Result of Conducted Spurious Emission

<1Mbps>

CSE Plot on Ch 00 between 30MHz ~ 3 GHz

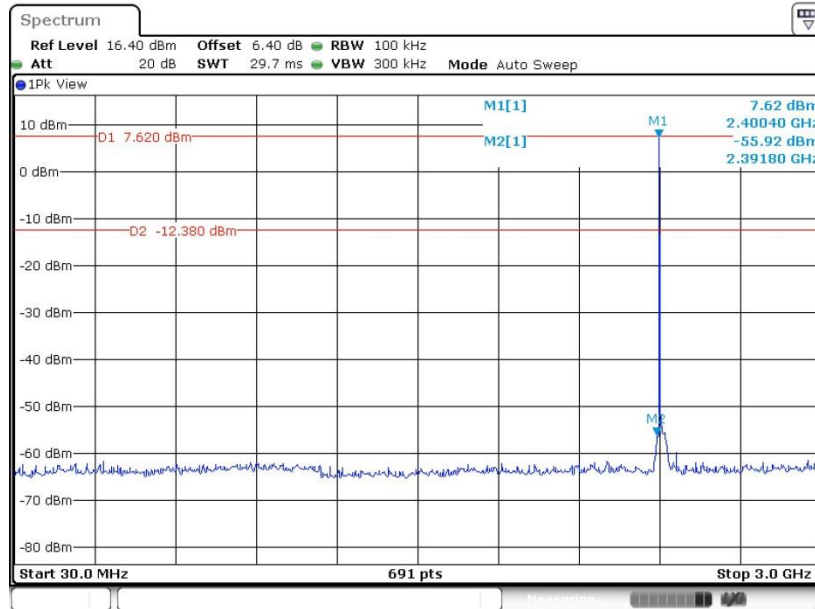

Date: 4.NOV.2019 16:30:26

1Mbps CSE Plot on Ch 00 between 2 GHz ~ 25 GHz

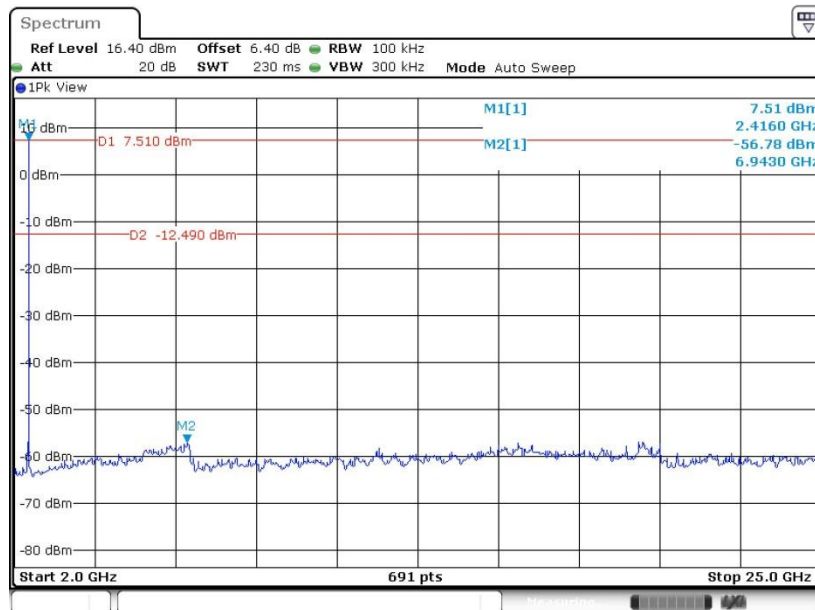

Date: 4.NOV.2019 16:30:53



CSE Plot on Ch 39 between 30MHz ~ 3 GHz

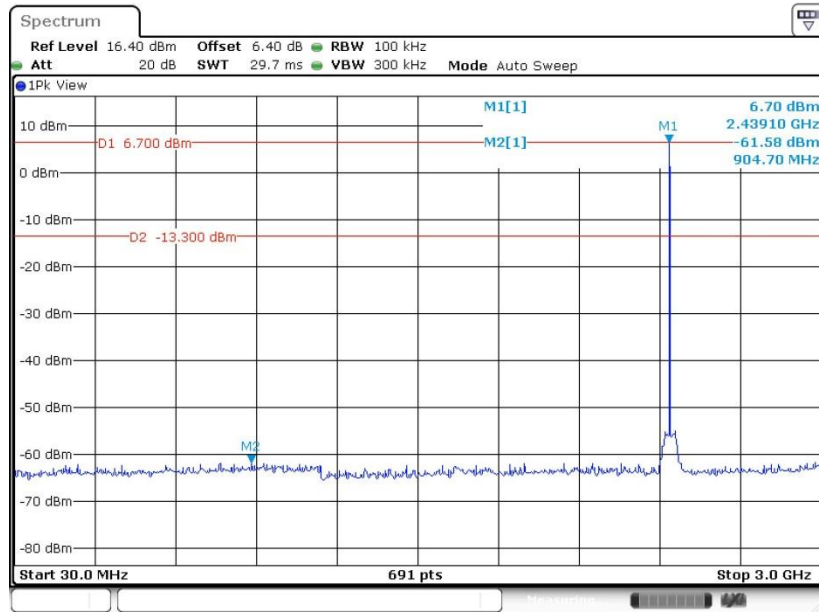

Date: 4.NOV.2019 16:35:44

CSE Plot on Ch 39 between 2 GHz ~ 25 GHz

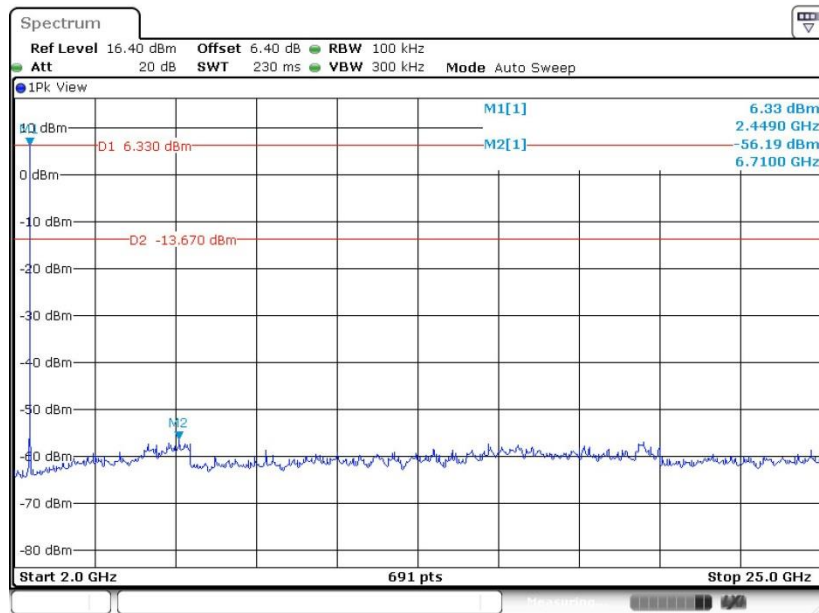

Date: 4.NOV.2019 16:36:13



CSE Plot on Ch 78 between 30MHz ~ 3 GHz

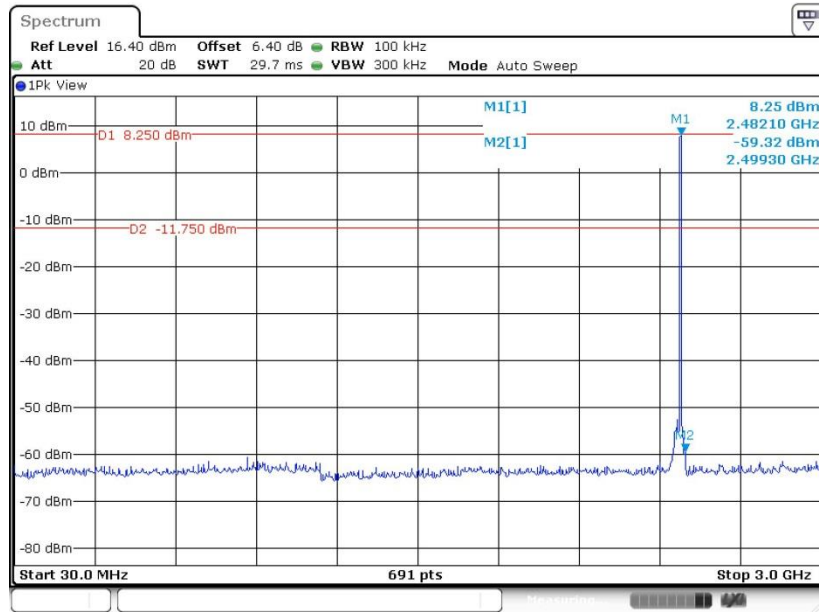

Date: 4.NOV.2019 16:40:28

CSE Plot on Ch 78 between 2 GHz ~ 25 GHz

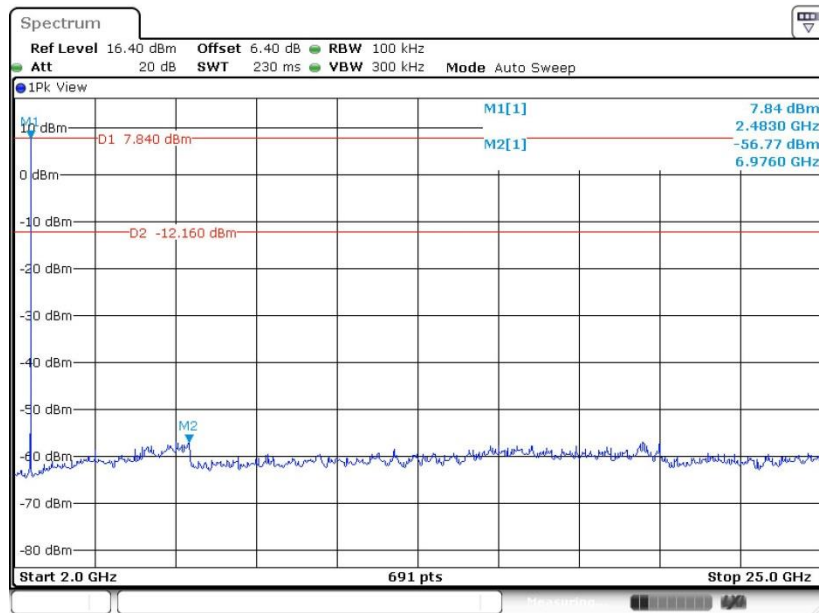

Date: 4.NOV.2019 16:40:59



<2Mbps>

CSE Plot on Ch 00 between 30MHz ~ 3 GHz

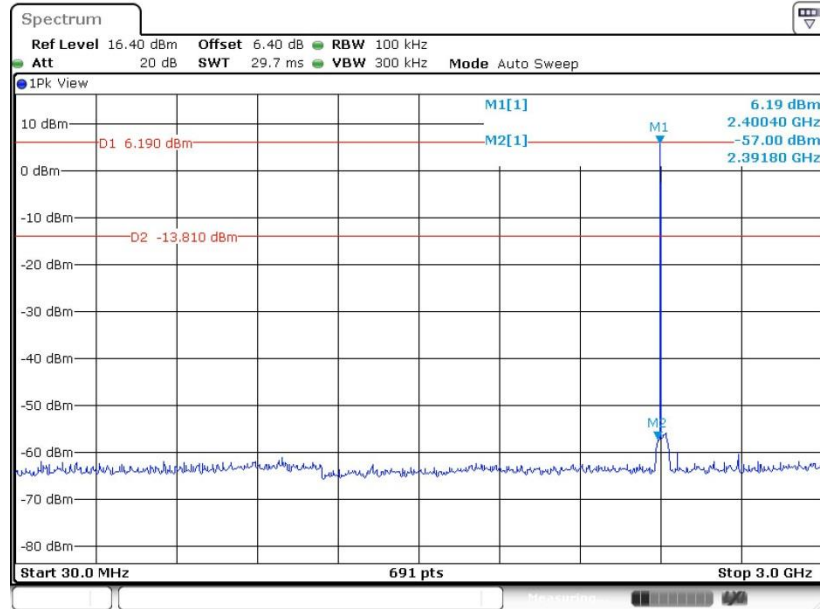

Date: 4.NOV.2019 16:49:05

CSE Plot on Ch 00 between 2 GHz ~ 25 GHz

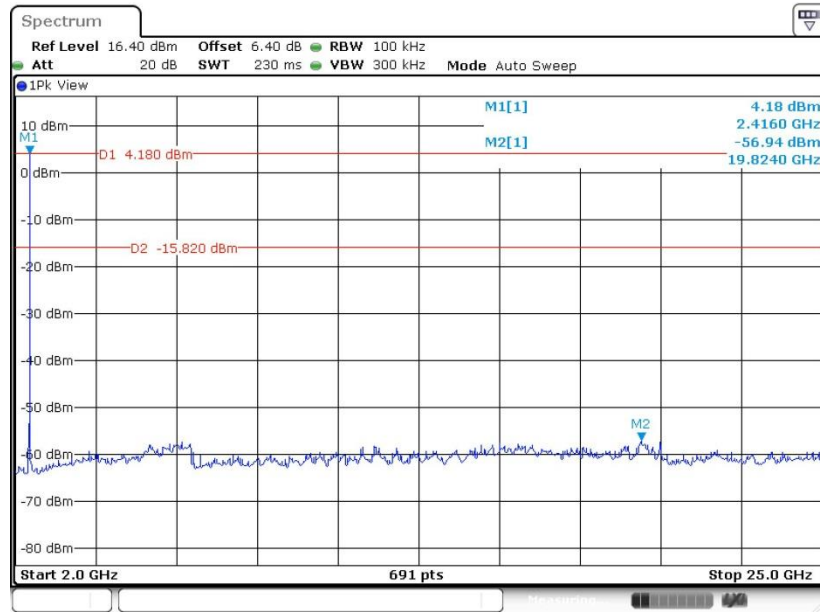

Date: 4.NOV.2019 16:49:32



CSE Plot on Ch 39 between 30MHz ~ 3 GHz

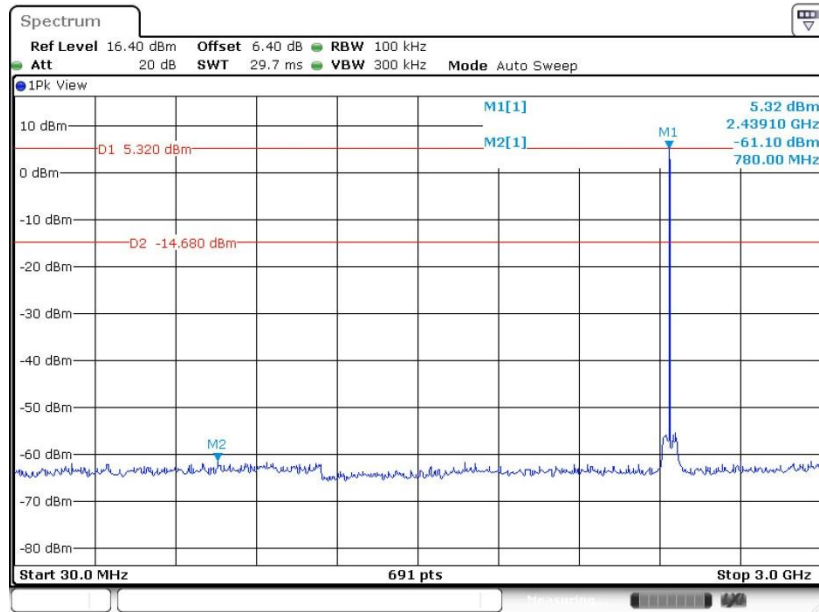

Date: 4.NOV.2019 16:53:51

CSE Plot on Ch 39 between 2 GHz ~ 25 GHz

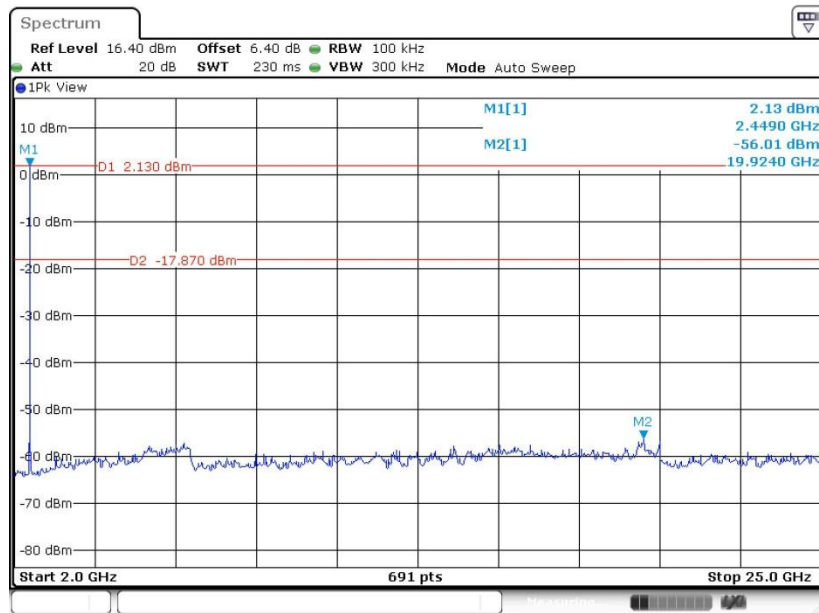

Date: 4.NOV.2019 16:54:23



CSE Plot on Ch 78 between 30MHz ~ 3 GHz

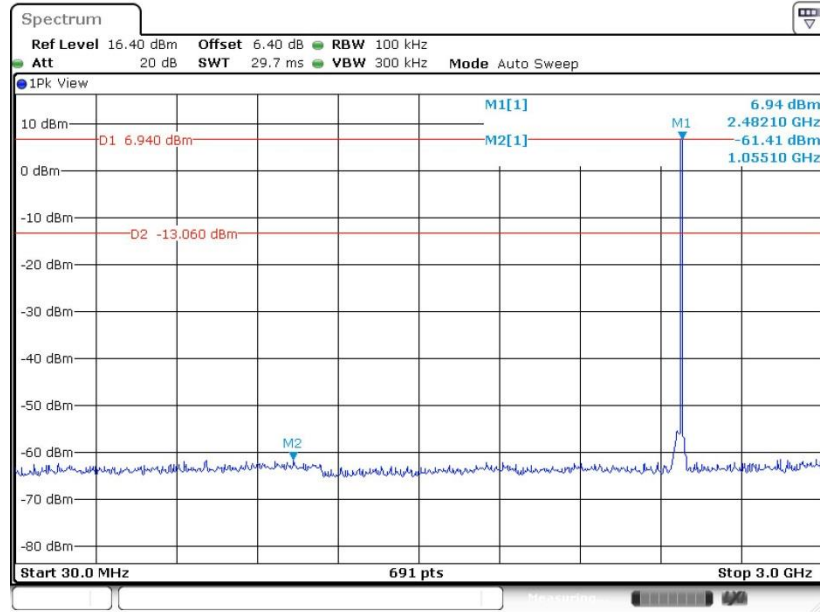

Date: 4.NOV.2019 16:58:36

CSE Plot on Ch 78 between 2 GHz ~ 25 GHz

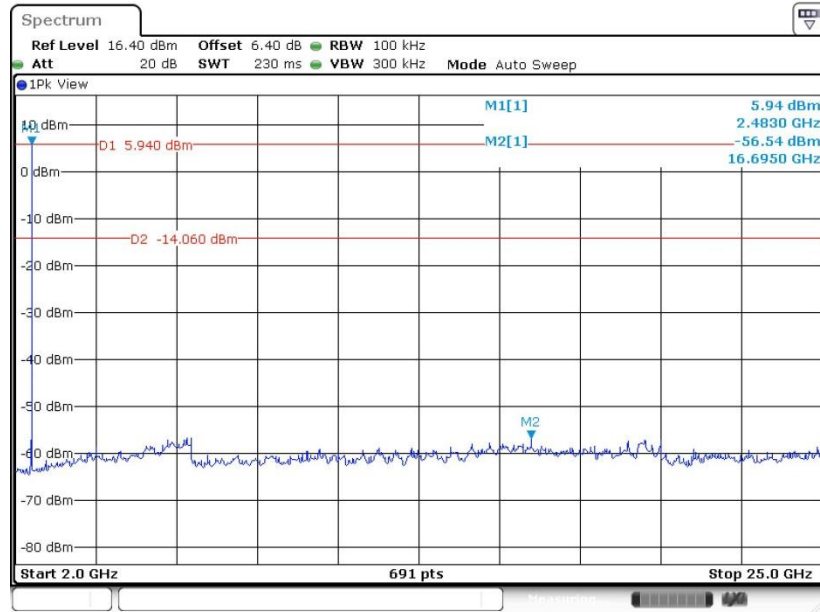

Date: 4.NOV.2019 16:59:02



<3Mbps>

CSE Plot on Ch 00 between 30MHz ~ 3 GHz

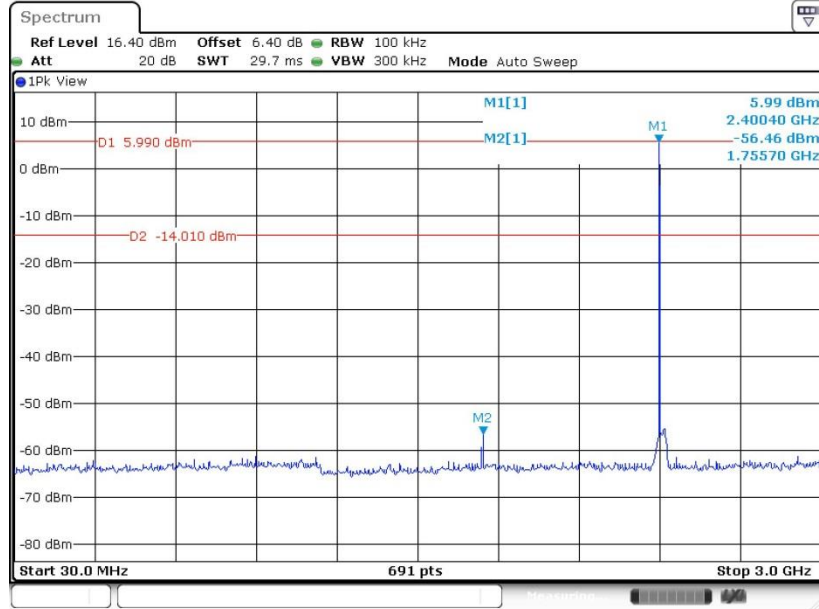

Date: 4.NOV.2019 17:04:55

CSE Plot on Ch 00 between 2 GHz ~ 25 GHz

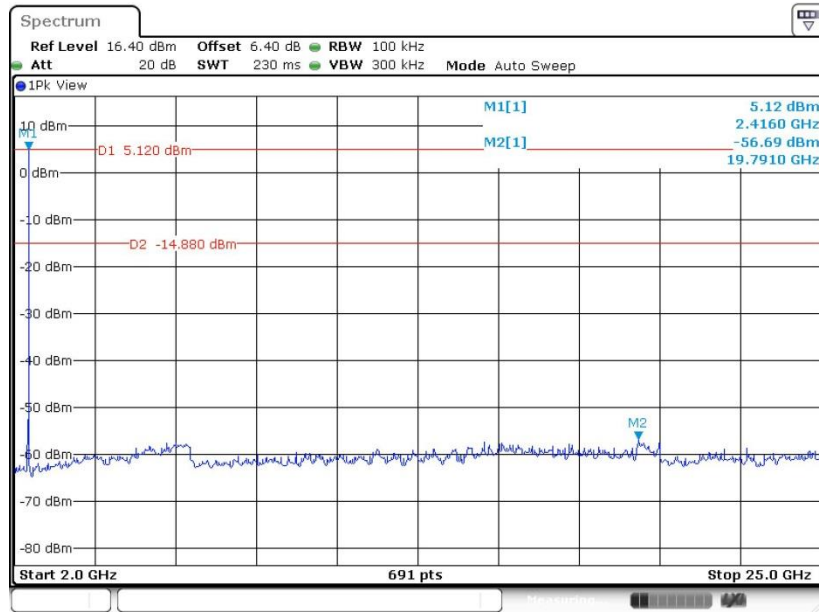

Date: 4.NOV.2019 17:05:24



CSE Plot on Ch 39 between 30MHz ~ 3 GHz

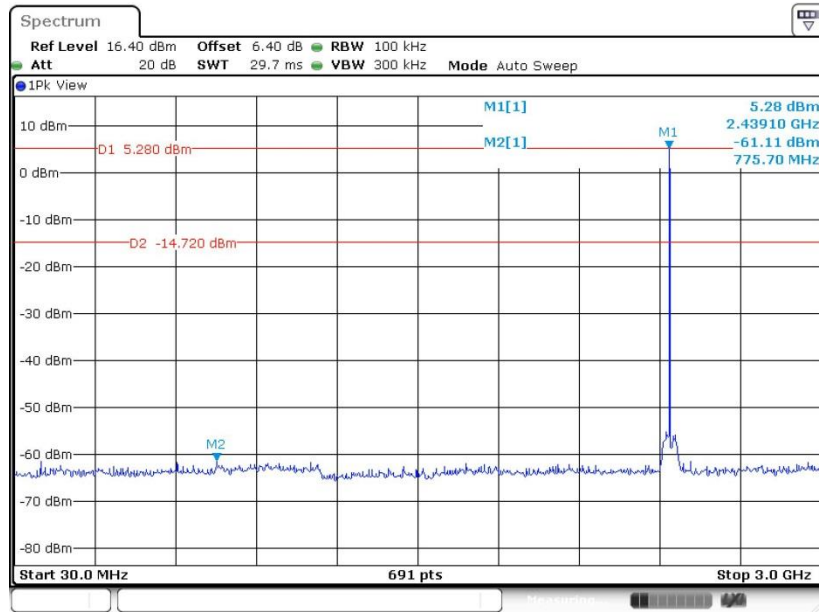

Date: 4.NOV.2019 17:12:41

CSE Plot on Ch 39 between 2 GHz ~ 25 GHz

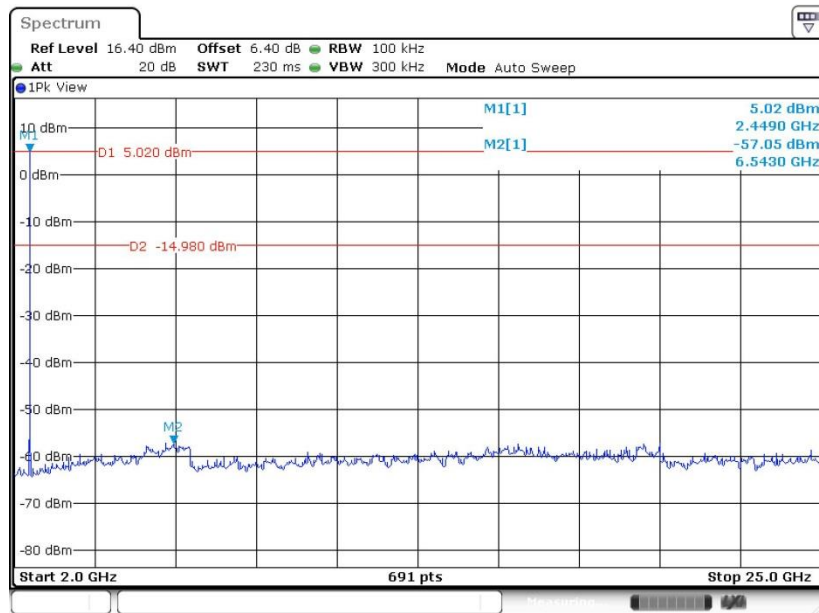

Date: 4.NOV.2019 17:13:16



CSE Plot on Ch 78 between 30MHz ~ 3 GHz

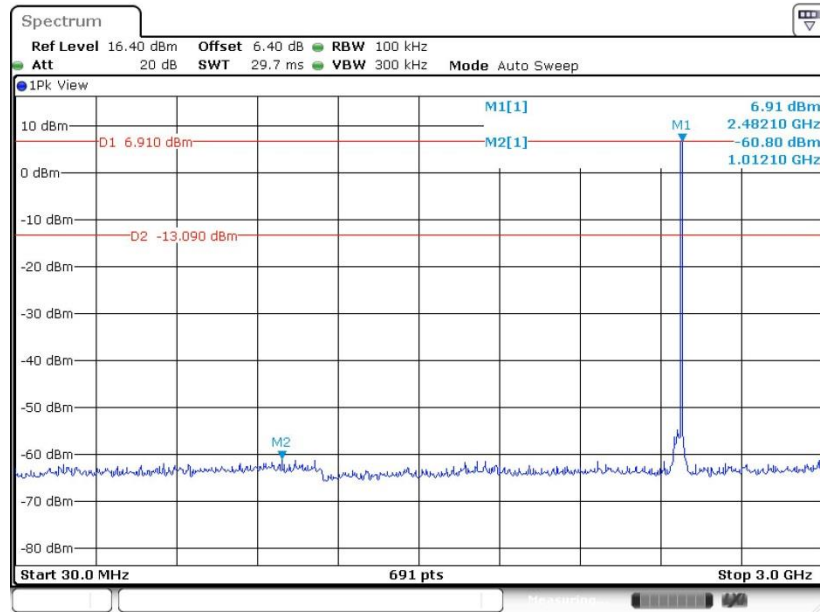

Date: 4.NOV.2019 17:16:32

CSE Plot on Ch 78 between 2 GHz ~ 25 GHz

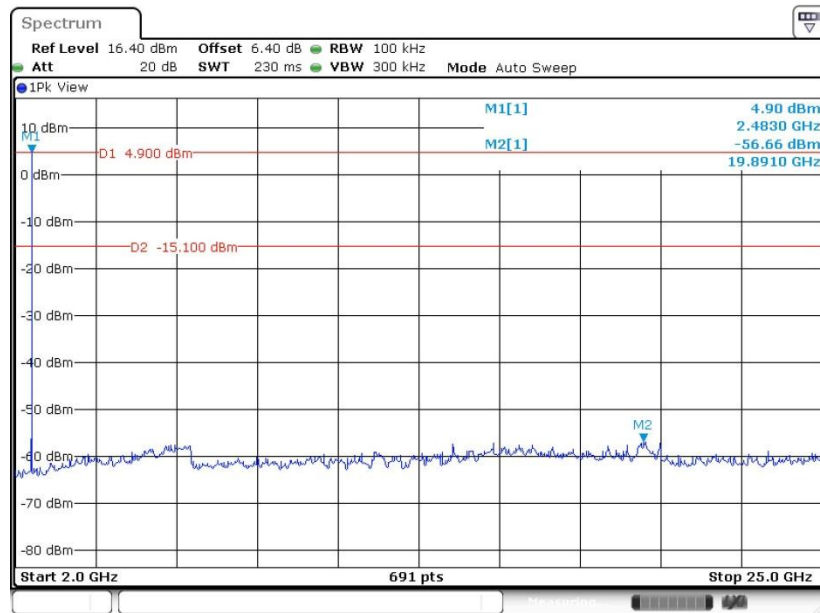

Date: 4.NOV.2019 17:17:00



3.8. Radiated Band Edges and Spurious Emission Measurement

3.8.1 Limit of Radiated Band Edges and Spurious Emission

In any 100 kHz bandwidth outside the intentional radiator frequency band, all harmonics/spurious must be at least 20 dB below the highest emission level within the authorized band. In addition, radiated emissions which fall in the restricted bands must also comply with the limits as below.

Frequency (MHz)	Field Strength (microvolts/meter)	Measurement Distance (meters)
0.009 – 0.490	2400/F(kHz)	300
0.490 – 1.705	24000/F(kHz)	30
1.705 – 30.0	30	30
30 – 88	100	3
88 – 216	150	3
216 - 960	200	3
Above 960	500	3

3.8.2 Measuring Instruments

The measuring equipment is listed in the section 4 of this test report.



3.8.3 Test Procedures

1. The EUT was placed on a turntable with 0.8 meter for frequency below 1GHz and 1.5 meter for frequency above 1GHz respectively above ground.
2. The EUT was set 3 meters from the interference receiving antenna, which was mounted on the top of a variable height antenna tower.
3. For each suspected emission, the EUT was arranged to its worst case and then tune the Antenna tower (from 1 m to 4 m) and turntable (from 0 degree to 360 degrees) to find the maximum reading. A pre-amp and a high pass filter are used for the test in order to get better signal level to comply with the guidelines.
4. Set to the maximum power setting and enable the EUT transmit continuously.
5. Use the following spectrum analyzer settings:
 - (1) Span shall wide enough to fully capture the emission being measured;
 - (2) Set RBW=100 kHz for $f < 1 \text{ GHz}$, RBW=1MHz for $f > 1\text{GHz}$; VBW \geq RBW; Sweep = auto; Detector function = peak; Trace = max hold for peak
 - (3) For average measurement: use duty cycle correction factor method per 15.35(c).
Duty cycle = On time/100 milliseconds
On time = $N_1 * L_1 + N_2 * L_2 + \dots + N_{n-1} * L_{n-1} + N_n * L_n$
Where N_1 is number of type 1 pulses, L_1 is length of type 1 pulses, etc.
Average Emission Level = Peak Emission Level + $20 * \log(\text{Duty cycle})$
6. Corrected Reading: Antenna Factor + Cable Loss + Read Level - Preamp Factor = Level
7. For testing below 1GHz, if the emission level of the EUT in peak mode was 3 dB lower than the limit specified, then peak values of EUT will be reported, otherwise, the emissions will be repeated one by one using the CISPR quasi-peak method and reported.
8. For testing above 1GHz, the emission level of the EUT in peak mode was 20dB lower than average limit (that means the emission level in average mode also complies with the limit in average mode), then peak values of EUT will be reported, otherwise, the emissions will be measured in average mode again and reported.

Note: The average levels were calculated from the peak level corrected with duty cycle correction factor (-24.76dB) derived from $20 \log(\text{dwell time}/100\text{ms})$. This correction is only for signals that hop with the fundamental signal, such as band-edge and harmonic. Other spurious signals that are independent of the hopping signal would not use this correction.

3.8.4 Test Setup

For radiated emissions below 30MHz

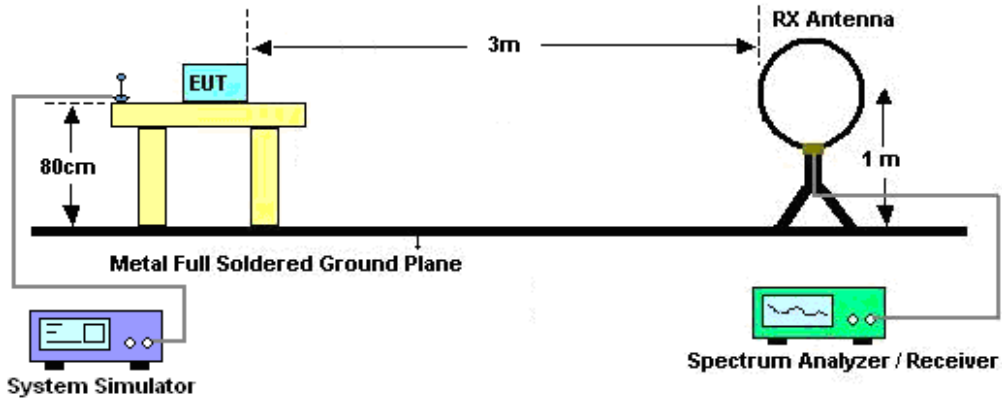

For radiated emissions from 30MHz to 1GHz

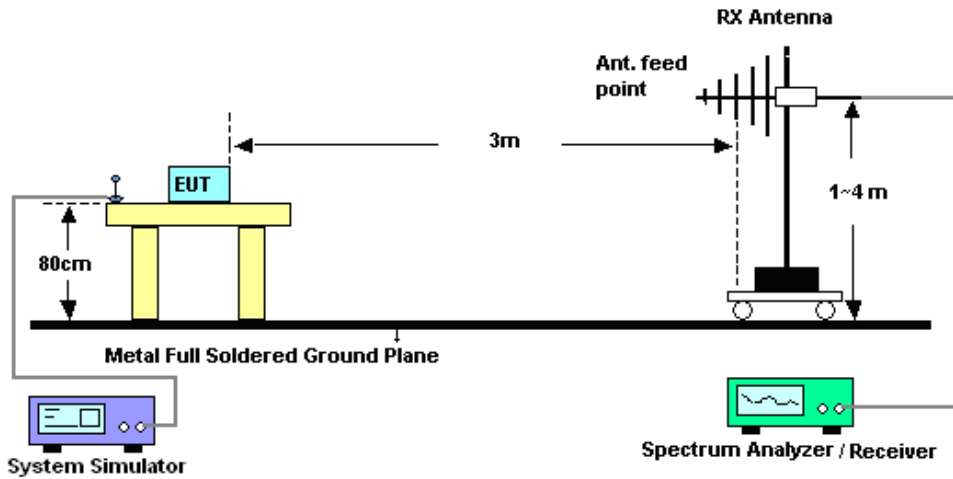

For radiated emissions above 1GHz

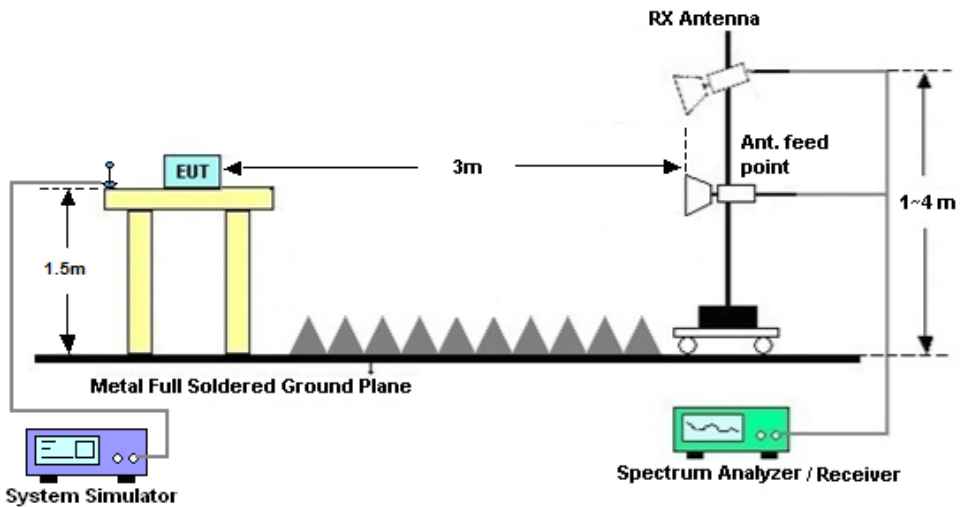



3.8.5 Test Results of Radiated Spurious Emissions (9 kHz ~ 30 MHz)

The low frequency, which started from 9 kHz to 30MHz, was pre-scanned and the result which was 20dB lower than the limit line was not reported.

There is a comparison data of both open-field test site and semi-Anechoic chamber, and the result came out very similar.

3.8.6 Test Result of Radiated Spurious at Band Edges

Please refer to Appendix C.

3.8.7 Test Result of Radiated Spurious Emission (30MHz ~ 10th Harmonic)

Please refer to Appendix C.

3.8.8 Duty cycle correction factor for average measurement

Please refer to Appendix D.



3.9. AC Conducted Emission Measurement

3.9.1 Limit of AC Conducted Emission

For equipment that is designed to be connected to the public utility (AC) power line, the radio frequency voltage that is conducted back onto the AC power line on any frequency or frequencies within the band 150 kHz to 30 MHz shall not exceed the limits in the following table.

Frequency of emission (MHz)	Conducted limit (dBµV)	
	Quasi-peak	Average
0.15-0.5	66 to 56*	56 to 46*
0.5-5	56	46
5-30	60	50

*Decreases with the logarithm of the frequency.

3.9.2 Measuring Instruments

The measuring equipment is listed in the section 4 of this test report.

3.9.3 Test Procedures

1. The EUT was placed 0.4 meter from the conducting wall of the shielding room was kept at least 80 centimeters from any other grounded conducting surface.
2. Connect EUT to the power mains through a line impedance stabilization network (LISN).
3. All the support units are connecting to the other LISN.
4. The LISN provides 50 ohm coupling impedance for the measuring instrument.
5. The FCC states that a 50 ohm, 50 microhenry LISN should be used.
6. Both sides of AC line were checked for maximum conducted interference.
7. The frequency range from 150 kHz to 30 MHz was searched.
8. Set the test-receiver system to Peak Detect Function and specified bandwidth (IF Bandwidth = 9kHz) with Maximum Hold Mode. Then measurement is also conducted by Average Detector and Quasi-Peak Detector Function respectively.

3.9.4 Test Setup

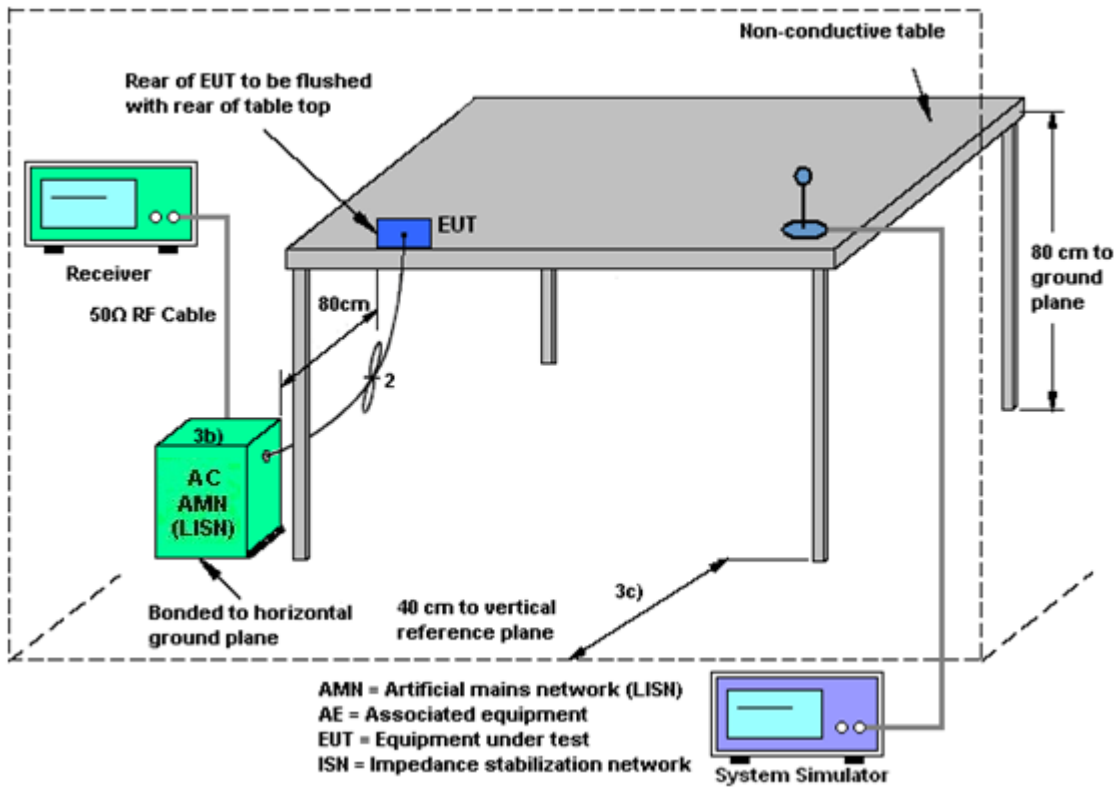

3.9.5 Test Result of AC Conducted Emission

Please refer to Appendix B.



3.10. Antenna Requirements

3.10.1 Standard Applicable

If directional gain of transmitting antennas is greater than 6dBi, the power shall be reduced by the same level in dB comparing to gain minus 6dBi. The use of a permanently attached antenna or of an antenna that uses a unique coupling to the intentional radiator shall be considered sufficient to comply with the rule.

3.10.2 Antenna Anti-Replacement Construction

An embedded-in antenna design is used.

3.10.3 Antenna Gain

The antenna peak gain of EUT is less than 6 dBi. Therefore, it is not necessary to reduce maximum peak output power limit.



4 List of Measuring Equipment

Instrument	Manufacturer	Model No.	Serial No.	Characteristics	Calibration Date	Test Date	Due Date	Remark
Spectrum Analyzer	R&S	FSV30	101338	10Hz~30GHz	Apr. 16, 2019	Oct. 25, 2019~Nov. 07, 2019	Apr. 15, 2020	Conducted (TH01-KS)
Pulse Power Sensor	Anritsu	MA2411B	0917070	300MHz~40GHz	Jan. 14, 2019	Oct. 25, 2019~Nov. 07, 2019	Jan. 13, 2020	Conducted (TH01-KS)
Power Meter	Anritsu	ML2495A	1005002	50MHz Bandwidth	Jan. 14, 2019	Oct. 25, 2019~Nov. 07, 2019	Jan. 13, 2020	Conducted (TH01-KS)
EMI Receiver	R&S	ESCI7	100768	9kHz~7GHz;	Apr. 16, 2019	Nov. 02, 2019	Apr. 15, 2020	Conduction (CO01-KS)
AC LISN	MessTec	AN3016	060103	9kHz~30MHz	Oct. 11, 2019	Nov. 02, 2019	Oct. 10, 2020	Conduction (CO01-KS)
AC LISN (for auxiliary equipment)	MessTec	AN3016	060105	9kHz~30MHz	Nov. 19, 2018	Nov. 02, 2019	Nov. 18, 2019	Conduction (CO01-KS)
AC Power Source	Chroma	61602	ABP00000811	AC 0V~300V, 45Hz~1000Hz	Oct. 11, 2019	Nov. 02, 2019	Oct. 10, 2020	Conduction (CO01-KS)
EMI Test Receiver	R&S	ESR7	101403	9kHz~7GHz;Max 30dBm	Oct. 26, 2019	Nov. 06, 2019	Oct. 25, 2020	Radiation (03CH02-KS)
EXA Spectrum Analyzer	Keysight	N9010A	MY55150244	10Hz~44G,MAX 30dB	Apr. 15, 2019	Nov. 06, 2019	Apr. 16, 2020	Radiation (03CH02-KS)
Loop Antenna	R&S	HFH2-Z2	100321	9kHz~30MHz	Oct. 18, 2019	Nov. 06, 2019	Oct. 17, 2020	Radiation (03CH02-KS)
Bilog Antenna	TeseQ	CBL6111D	49922	30MHz~1GHz	May 30, 2019	Nov. 06, 2019	May 29, 2020	Radiation (03CH02-KS)
Double Ridge Horn Antenna	ETS-Lindgren	3117	75959	1GHz~18GHz	Jan. 27, 2019	Nov. 06, 2019	Jan. 26, 2020	Radiation (03CH02-KS)
high gain Amplifier	MITEQ	AMF-7D-00101800-30-10P	2025788	100MHz~18GHz	Aug. 14, 2019	Nov. 06, 2019	Aug. 13, 2020	Radiation (03CH02-KS)
SHF-EHF Horn	Com-power	AH-840	101070	18GHz~40GHz	Jan. 05, 2019	Nov. 06, 2019	Jan. 04, 2020	Radiation (03CH02-KS)
Amplifier	SONOMA	310N	187289	9KHz~1GHz	Aug. 06, 2019	Nov. 06, 2019	Aug. 05, 2020	Radiation (03CH02-KS)
Amplifier	Keysight	83017A	MY57280106	500MHz~26.5GHz	Apr. 15, 2019	Nov. 06, 2019	Apr. 14, 2020	Radiation (03CH02-KS)
Amplifier	MITEQ	TTA1840-35-HG	1887435	18~40GHz	Jan. 14, 2019	Nov. 06, 2019	Jan. 13, 2020	Radiation (03CH02-KS)
AC Power Source	Chroma	61601	616010002473	N/A	NCR	Nov. 06, 2019	NCR	Radiation (03CH02-KS)
Turn Table	MF	MF7802	N/A	0~360 degree	NCR	Nov. 06, 2019	NCR	Radiation (03CH02-KS)
Antenna Mast	MF	MF7802	N/A	1 m~4 m	NCR	Nov. 06, 2019	NCR	Radiation (03CH02-KS)

NCR: No Calibration Required.



5 Uncertainty of Evaluation

The measurement uncertainties shown below were calculated in accordance with the requirements of ANSI 63.10-2013. All the measurement uncertainty value were shown with a coverage K=2 to indicate 95% level of confidence. The measurement data show herein meets or exceeds the CISPR measurement uncertainty values specified in CISPR 16-4-2 and can be compared directly to specified limit to determine compliance.

Uncertainty of Conducted Emission Measurement (150 kHz ~ 30 MHz)

Measuring Uncertainty for a Level of Confidence of 95% (U = 2Uc(y))	2.9dB
---	-------

Uncertainty of Radiated Emission Measurement (30 MHz ~ 1000 MHz)

Measuring Uncertainty for a Level of Confidence of 95% (U = 2Uc(y))	4.9dB
---	-------

Uncertainty of Radiated Emission Measurement (1000 MHz ~ 18000 MHz)

Measuring Uncertainty for a Level of Confidence of 95% (U = 2Uc(y))	5.0dB
---	-------

Uncertainty of Radiated Emission Measurement (18000 MHz ~ 40000 MHz)

Measuring Uncertainty for a Level of Confidence of 95% (U = 2Uc(y))	5.1dB
---	-------



Appendix A. Conducted Test Results

Bluetooth

Test Engineer:	Lex Wu	Temperature:	20~26	°C
Test Date:	2019/10/25~2019/11/7	Relative Humidity:	40~51	%

TEST RESULTS DATA**20dB and 99% Occupied Bandwidth and Hopping Channel Separation**

Mod.	Data Rate	NTX	CH.	Freq. (MHz)	20db BW (MHz)	99% Bandwidth (MHz)	Hopping Channel Separation Measurement (MHz)	Hopping Channel Separation Measurement Limit (MHz)	Pass/Fail
DH	1Mbps	1	0	2402	0.947	0.865	998.600	0.6310	Pass
DH	1Mbps	1	39	2441	0.947	0.865	998.600	0.6310	Pass
DH	1Mbps	1	78	2480	0.947	0.863	994.200	0.6310	Pass
2DH	2Mbps	1	0	2402	1.259	1.166	1015.920	0.8393	Pass
2DH	2Mbps	1	39	2441	1.259	1.164	1015.920	0.8393	Pass
2DH	2Mbps	1	78	2480	1.259	1.166	1002.900	0.8393	Pass
3DH	3Mbps	1	0	2402	1.237	1.152	1302.500	0.8249	Pass
3DH	3Mbps	1	39	2441	1.237	1.152	942.100	0.8249	Pass
3DH	3Mbps	1	78	2480	1.229	1.152	998.600	0.8191	Pass

TEST RESULTS DATA**Dwell Time**

Mod.	Hopping Channel Number Rate	Hops Over Occupancy Time(hops)	Package Transfer Time (msec) (MHz)	Dwell Time (sec)	Limits (sec)	Pass/Fail
Nomal	79	106.67	2.90	0.31	0.4	Pass
AFH	20	53.33	2.90	0.15	0.4	Pass

TEST RESULTS DATA**Peak Power Table**

DH	CH.	NTX	Peak Power (dBm)	Power Limit (dBm)	Test Result
DH1	0	1	6.63	20.97	Pass
	39	1	5.69	20.97	Pass
	78	1	7.12	20.97	Pass
2DH	CH.	NTX	Peak Power (dBm)	Power Limit (dBm)	Test Result
2DH1	0	1	7.14	20.97	Pass
	39	1	6.17	20.97	Pass
	78	1	7.47	20.97	Pass
3DH	CH.	NTX	Peak Power (dBm)	Power Limit (dBm)	Test Result
3DH1	0	1	7.25	20.97	Pass
	39	1	6.38	20.97	Pass
	78	1	7.71	20.97	Pass

TEST RESULTS DATA**Number of Hopping Frequency**

Number of Hopping (Channel)	Adaptive Frequency Hopping (Channel)	Limits (Channel)	Pass/Fail
79	79	> 15	Pass



Appendix B. AC Conducted Emission Test Results

Test Engineer :	Amos Zhang	Temperature :	25.3~26.2°C
		Relative Humidity :	38~40%
Test Voltage :	120Vac / 60Hz	Phase :	Line

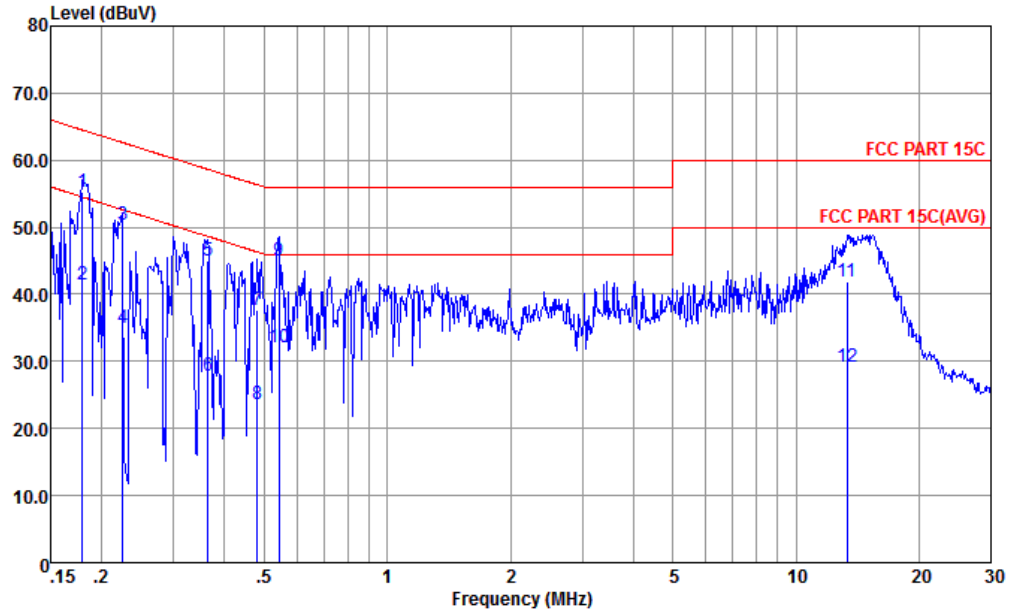

Site : CO01-KS
 Condition : FCC PART 15C LISN-L-181119-060105 LINE

mode : Mode 1
 : 359107100039759/359107100039767 #8

	Freq	Level	Over	Limit	Read	LISN	Cable	Remark
	MHz	dBuV	Limit	Line	Level	Factor	Loss	
		dBuV	dB	dBuV	dBuV	dB	dB	
1 *	0.180	55.32	-9.18	64.50	44.80	0.11	10.41	QP
2	0.180	41.42	-13.08	54.50	30.90	0.11	10.41	Average
3	0.226	50.27	-12.34	62.61	39.79	0.13	10.35	QP
4	0.226	35.07	-17.54	52.61	24.59	0.13	10.35	Average
5	0.363	44.93	-13.72	58.65	34.50	0.15	10.28	QP
6	0.363	27.93	-20.72	48.65	17.50	0.15	10.28	Average
7	0.481	37.61	-18.71	56.32	27.20	0.17	10.24	QP
8	0.481	23.71	-22.61	46.32	13.30	0.17	10.24	Average
9	0.544	45.01	-10.99	56.00	34.59	0.18	10.24	QP
10	0.544	32.01	-13.99	46.00	21.59	0.18	10.24	Average
11	13.337	41.81	-18.19	60.00	31.20	0.23	10.38	QP
12	13.337	29.13	-20.87	50.00	18.52	0.23	10.38	Average



Test Engineer :	Amos Zhang	Temperature :	25.3~26.2°C
		Relative Humidity :	38~40%
Test Voltage :	120Vac / 60Hz	Phase :	Neutral

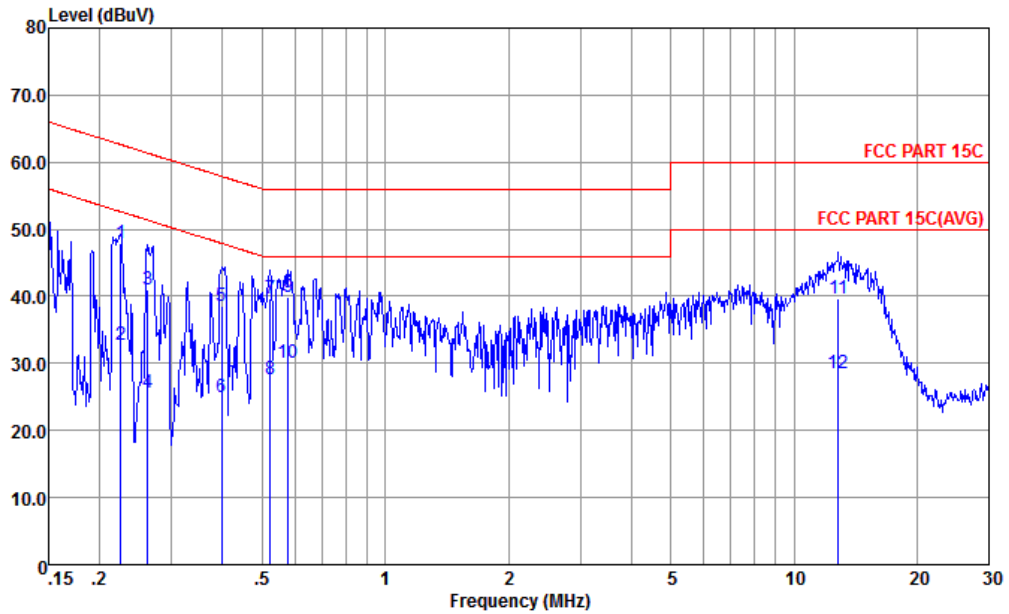

Site : CO01-KS
 Condition : FCC PART 15C LISN-N-181119-060105 NEUTRAL

mode : Mode 1
 : 359107100039759/359107100039767 #8

	Freq	Level	Over	Limit	Read	LISN	Cable	Remark
	MHz	dBuV	Limit	Line	Level	Factor	Loss	
			dB	dBuV	dBuV	dB	dB	
1 *	0.226	47.82	-14.79	62.61	37.30	0.17	10.35	QP
2	0.226	32.82	-19.79	52.61	22.30	0.17	10.35	Average
3	0.262	41.09	-20.29	61.38	30.59	0.17	10.33	QP
4	0.262	25.69	-25.69	51.38	15.19	0.17	10.33	Average
5	0.398	38.62	-19.28	57.90	28.20	0.15	10.27	QP
6	0.398	25.02	-22.88	47.90	14.60	0.15	10.27	Average
7	0.524	39.58	-16.42	56.00	29.19	0.15	10.24	QP
8	0.524	27.58	-18.42	46.00	17.19	0.15	10.24	Average
9	0.579	39.98	-16.02	56.00	29.60	0.14	10.24	QP
10	0.579	29.98	-16.02	46.00	19.60	0.14	10.24	Average
11	12.852	39.61	-20.39	60.00	29.10	0.14	10.37	QP
12	12.852	28.61	-21.39	50.00	18.10	0.14	10.37	Average

Note:

1. Level(dBμV) = Read Level(dBμV) + LISN Factor(dB) + Cable Loss(dB)
2. Over Limit(dB) = Level(dBμV) – Limit Line(dBμV)



Appendix C. Radiated Spurious Emission

2.4GHz 2400~2483.5MHz

BT (Band Edge @ 3m)

BT	Note	Frequency	Level	Over Limit	Limit Line	Read Level	Antenna Factor	Cable Loss	Preamp Factor	Ant Pos	Table Pos	Peak Avg.	Pol.	
		(MHz)	(dBμV/m)	(dB)	(dBμV/m)	(dBμV)	(dB/m)	(dB)	(dB)	(cm)	(deg)	(P/A)	(H/V)	
BT CH00 2402MHz		2387.61	51.59	-22.41	74	47.35	31.3	5.48	32.54	100	118	P	H	
	*	2387.61	26.83	-27.17	54	-	-	-	-	-	-	A	H	
		2402	104.28	-	-	100.03	31.3	5.48	32.53	100	118	P	H	
		2402	79.52	-	-	-	-	-	-	-	-	A	H	
		2381.11	51.76	-22.24	74	47.62	31.25	5.43	32.54	387	68	P	V	
	*	2381.11	27.00	-27.00	54	-	-	-	-	-	-	-	A	V
		2402	99.36	-	-	95.11	31.3	5.48	32.53	387	68	P	V	
		2402	74.60	-	-	-	-	-	-	-	-	-	A	V
BT CH 78 2480MHz	*	2480	104.30	-	-	99.47	31.59	5.55	32.31	100	119	P	H	
		2480	79.54	-	-	-	-	-	-	-	-	A	H	
		2483.56	59.12	-14.88	74	54.29	31.59	5.55	32.31	100	119	P	H	
		2483.56	34.36	-19.64	54	-	-	-	-	-	-	A	H	
	*	2480	99.50	-	-	94.67	31.59	5.55	32.31	364	92	P	V	
		2480	74.74	-	-	-	-	-	-	-	-	A	V	
		2483.62	55.55	-18.45	74	50.72	31.59	5.55	32.31	364	92	P	V	
		2483.62	30.79	-23.21	54	-	-	-	-	-	-	-	A	V
Remark	1. No other spurious found. 2. All results are PASS against Peak and Average limit line.													



2.4GHz 2400~2483.5MHz

BT (Harmonic @ 3m)

BT	Note	Frequency (MHz)	Level (dBμV/m)	Over Limit (dB)	Limit Line (dBμV/m)	Read Level (dBμV)	Antenna Factor (dB/m)	Cable Loss (dB)	Preamp Factor (dB)	Ant Pos (cm)	Table Pos (deg)	Peak Avg. (P/A)	Pol. (H/V)
BT CH 00 2402MHz		4806	40.93	-33.07	74	60.08	34.88	8.1	62.13	100	360	P	H
		4806	41.24	-32.76	74	60.39	34.88	8.1	62.13	100	360	P	V
BT CH 39 2441MHz		4884	40.27	-33.73	74	59.39	34.92	8.07	62.11	100	360	P	H
		7320	40.9	-33.1	74	58.62	35.3	9.75	62.77	100	360	P	H
		4884	41.22	-32.78	74	60.34	34.92	8.07	62.11	100	360	P	V
BT CH 78 2480MHz		7320	41.36	-32.64	74	59.08	35.3	9.75	62.77	100	360	P	V
		4962	39.37	-34.63	74	58.43	34.97	8.05	62.08	150	360	P	H
		7440	40.13	-33.87	74	57.7	35.37	9.84	62.78	150	360	P	H
		4962	39.51	-34.49	74	58.57	34.97	8.05	62.08	150	360	P	V
		7440	39.66	-34.34	74	57.23	35.37	9.84	62.78	150	360	P	V
Remark	1. No other spurious found. 2. All results are PASS against Peak and Average limit line.												



Emission below 1GHz

2.4GHz BT (LF)

BT	Note	Frequency	Level	Over	Limit	Read	Antenna	Cable	Preamp	Ant	Table	Peak	Pol.
		(MHz)	(dBμV/m)	(dB)	(dBμV/m)	(dBμV)	(dB/m)	(dB)	(dB)	(cm)	(deg)	(P/A)	(H/V)
2.4GHz BT LF		36.79	17.01	-22.99	40	27.11	21.14	0.72	31.96	-	-	P	H
		128.94	17.36	-26.14	43.5	31.24	16.78	1.28	31.94	-	-	P	H
		646.92	25.56	-20.44	46	28.46	26.56	2.9	32.36	-	-	P	H
		741.98	27.19	-18.81	46	28.12	28.22	3.12	32.27	-	-	P	H
		862.26	29.08	-16.92	46	28.14	29.27	3.38	31.71	-	-	P	H
		952.47	29.46	-16.54	46	25.99	30.88	3.55	30.96	100	0	P	H
		36.79	23.06	-16.94	40	33.16	21.14	0.72	31.96	-	-	P	V
		63.95	18.58	-21.42	40	37.34	12.22	0.95	31.93	-	-	P	V
		88.2	16.99	-26.51	43.5	33.06	14.76	1.09	31.92	-	-	P	V
		850.62	28.24	-17.76	46	27.37	29.3	3.35	31.78	-	-	P	V
		924.34	29.16	-16.84	46	26.86	30.03	3.5	31.23	100	0	P	V
		984.48	30.57	-23.43	54	27.03	30.62	3.58	30.66	-	-	P	V
Remark	1. No other spurious found. 2. All results are PASS against limit line.												



Note symbol

*	Fundamental Frequency which can be ignored. However, the level of any unwanted emissions shall not exceed the level of the fundamental frequency.
!	Test result is over limit line.
P/A	Peak or Average
H/V	Horizontal or Vertical



A calculation example for radiated spurious emission is shown as below:

WIFI	Note	Frequency	Level	Over	Limit	Read	Antenna	Cable	Preamp	Ant	Table	Peak	Pol.
Ant.				Limit	Line	Level	Factor	Loss	Factor	Pos	Pos	Avg.	
1+2		(MHz)	(dBμV/m)	(dB)	(dBμV/m)	(dBμV)	(dB/m)	(dB)	(dB)	(cm)	(deg)	(P/A)	(H/V)
802.11b		2390	55.45	-18.55	74	54.51	32.22	4.58	35.86	103	308	P	H
CH 01													
2412MHz		2390	43.54	-10.46	54	42.6	32.22	4.58	35.86	103	308	A	H

- Level(dBμV/m) =
Antenna Factor(dB/m) + Cable Loss(dB) + Read Level(dBμV) - Preamp Factor(dB)
- Over Limit(dB) = Level(dBμV/m) – Limit Line(dBμV/m)

For Peak Limit @ 2390MHz:

- Level(dBμV/m)
= Antenna Factor(dB/m) + Cable Loss(dB) + Read Level(dBμV) - Preamp Factor(dB)
= 32.22(dB/m) + 4.58(dB) + 54.51(dBμV) – 35.86 (dB)
= 55.45 (dBμV/m)
- Over Limit(dB)
= Level(dBμV/m) – Limit Line(dBμV/m)
= 55.45(dBμV/m) – 74(dBμV/m)
= -18.55(dB)

For Average Limit @ 2390MHz:

- Level(dBμV/m)
= Antenna Factor(dB/m) + Cable Loss(dB) + Read Level(dBμV) - Preamp Factor(dB)
= 32.22(dB/m) + 4.58(dB) + 42.6(dBμV) – 35.86 (dB)
= 43.54 (dBμV/m)
- Over Limit(dB)
= Level(dBμV/m) – Limit Line(dBμV/m)
= 43.54(dBμV/m) – 54(dBμV/m)
= -10.46(dB)

Both peak and average measured complies with the limit line, so test result is “PASS”.

Appendix D. Duty Cycle Plots

3DH5 on time (One Pulse) Plot on Channel 39

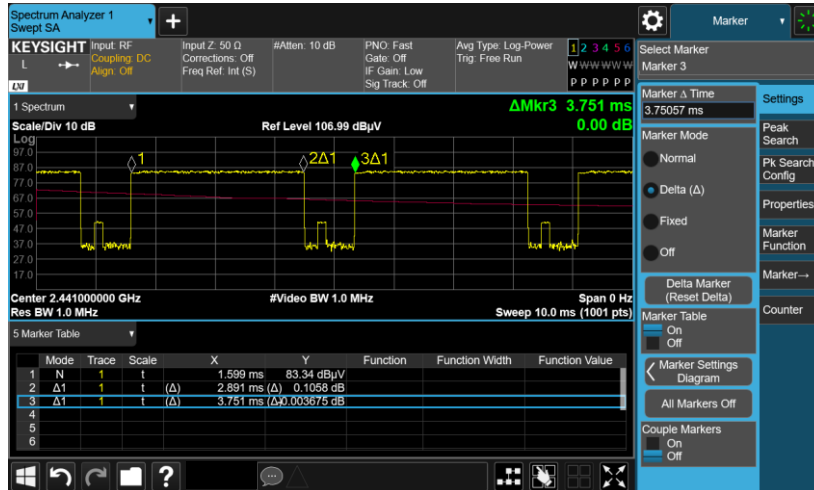

3DH5 on time (Count Pulses) Plot on Channel 39

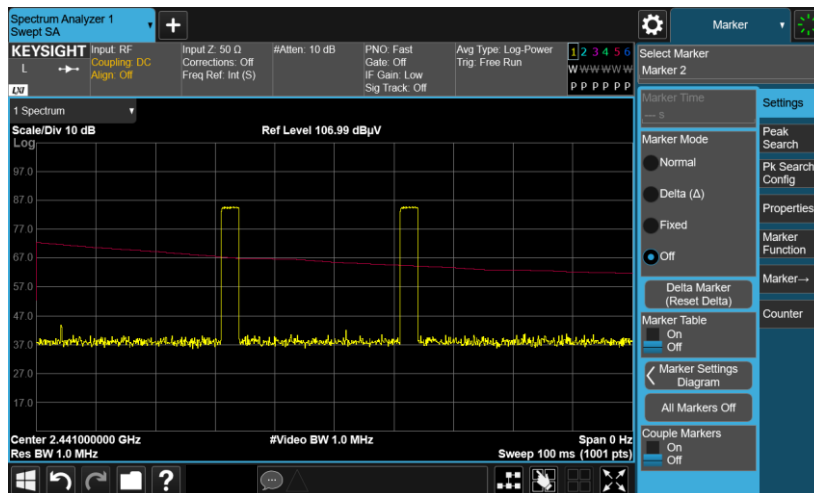

Note:

1. Worst case Duty cycle = on time/100 milliseconds = $2 * 2.89 / 100 = 5.78 \%$
2. Worst case Duty cycle correction factor = $20 * \log(\text{Duty cycle}) = -24.76 \text{ dB}$
3. 3DH5 has the highest duty cycle worst case and is reported.