



FCC RF Test Report

APPLICANT : Motorola Mobility LLC
EQUIPMENT : Mobile Cellular Phone
BRAND NAME : Motorola
MODEL NAME : XT2045-3
FCC ID : IHDT56YK1
STANDARD : FCC Part 15 Subpart E §15.407
CLASSIFICATION : (NII) Unlicensed National Information Infrastructure

The product was received on Jan. 04, 2020 and testing was completed on Mar. 11, 2020. We, Sporton International (Kunshan) Inc., would like to declare that the tested sample has been evaluated in accordance with the test procedures and has been in compliance with the applicable technical standards.

The test results in this report apply exclusively to the tested model / sample. Without written approval of Sporton International (Kunshan) Inc., the test report shall not be reproduced except in full.

Jason Jia

Reviewed by: Jason Jia / Supervisor

James Huang

Approved by: James Huang / Manager



Sporton International (Kunshan) Inc.

**No. 1098, Pengxi North Road, Kunshan Economic Development Zone Jiangsu Province 215300
People's Republic of China**



TABLE OF CONTENTS

REVISION HISTORY..... 3

SUMMARY OF TEST RESULT 4

1 GENERAL DESCRIPTION 5

 1.1 Applicant 5

 1.2 Manufacturer 5

 1.3 Product Feature of Equipment Under Test 5

 1.4 Product Specification of Equipment Under Test 6

 1.5 Modification of EUT 7

 1.6 Specification of Accessory 7

 1.7 Testing Location 7

 1.8 Test Software 7

 1.9 Applicable Standards 8

2 TEST CONFIGURATION OF EQUIPMENT UNDER TEST 9

 2.1 Carrier Frequency and Channel 9

 2.2 Test Mode 11

 2.3 Connection Diagram of Test System 13

 2.4 Support Unit used in test configuration and system 14

 2.5 EUT Operation Test Setup 14

 2.6 Measurement Results Explanation Example 14

3 TEST RESULT 15

 3.1 26dB & 99% Occupied Bandwidth Measurement 15

 3.2 Maximum Conducted Output Power Measurement 17

 3.3 Power Spectral Density Measurement 19

 3.4 Unwanted Emissions Measurement 22

 3.5 AC Conducted Emission Measurement 28

 3.6 Automatically Discontinue Transmission 30

 3.7 Antenna Requirements 31

4 LIST OF MEASURING EQUIPMENT 32

5 UNCERTAINTY OF EVALUATION 33

APPENDIX A. CONDUCTED TEST RESULTS

APPENDIX B. AC CONDUCTED EMISSION TEST RESULT

APPENDIX C. RADIATED SPURIOUS EMISSION

APPENDIX D. DUTY CYCLE PLOTS

APPENDIX E. SETUP PHOTOGRAPHS



REVISION HISTORY

REPORT NO.	VERSION	DESCRIPTION	ISSUED DATE
FR010402D	Rev. 01	Initial issue of report	Mar. 20, 2020



SUMMARY OF TEST RESULT

Report Section	FCC Rule	Description	Limit	Result	Remark
3.1	2.1049 & 15.403(i)	26dB & 99% Bandwidth	-	Pass	-
3.2	15.407(a)	Maximum Conducted Output Power	≤ 24 dBm	Pass	-
3.3	15.407(a)	Power Spectral Density	≤ 11 dBm	Pass	-
3.4	15.407(b)	Unwanted Emissions	15.407(b) & 15.209(a)	Pass	Under limit 3.88 dB at 5350.000 MHz
3.5	15.207	AC Conducted Emission	15.207(a)	Pass	Under limit 10.50 dB at 0.552 MHz
3.6	15.407(c)	Automatically Discontinue Transmission	Discontinue Transmission	Pass	-
3.7	15.203 & 15.407(a)	Antenna Requirement	N/A	Pass	-

Declaration of Conformity:
The test results with all measurement uncertainty excluded are presented in accordance with the regulation limits or requirements declared by manufacturers.
Comments and Explanations:
The declared of product specification for EUT presented in the report are provided by the manufacturer, and the manufacturer takes all the responsibilities for the accuracy of product specification.



1 General Description

1.1 Applicant

Motorola Mobility LLC
222 W,Merchandise Mart Plaza, Chicago IL 60654 USA

1.2 Manufacturer

Motorola Mobility LLC
222 W,Merchandise Mart Plaza, Chicago IL 60654 USA

1.3 Product Feature of Equipment Under Test

Product Feature	
Equipment	Mobile Cellular Phone
Brand Name	Motorola
Model Name	XT2045-3
FCC ID	IHDT56YK1
EUT supports Radios application	CDMA/GSM/WCDMA/LTE WLAN 2.4GHz 802.11b/g/n HT20 WLAN 5GHz 802.11a/n HT20/HT40 WLAN 5GHz 802.11ac VHT20/VHT40/VHT80 Bluetooth BR/EDR/LE FM Receiver and GNSS
IMEI Code	Conducted: N/A Conduction: 359109100024666 Radiation: 359109100035506
HW Version	DVT2
SW Version	QPJ30.85
EUT Stage	Identical Prototype

Remark: The above EUT's information was declared by manufacturer. Please refer to the specifications or user's manual for more detailed description.



1.4 Product Specification of Equipment Under Test

Standards-related Product Specification	
Tx/Rx Frequency Range	5180 MHz ~ 5240 MHz 5260 MHz ~ 5320 MHz 5500 MHz ~ 5700 MHz
Maximum Output Power to Antenna	<p><5180 MHz ~ 5240 MHz> 802.11a : 18.30 dBm / 0.0676 W 802.11n HT20 : 18.29 dBm / 0.0675 W 802.11n HT40 : 16.36 dBm / 0.0433 W 802.11ac VHT20 : 18.18 dBm / 0.0658 W 802.11ac VHT40 : 16.35 dBm / 0.0432 W 802.11ac VHT80 : 17.97 dBm / 0.0627 W</p> <p><5260 MHz ~ 5320 MHz> 802.11a : 18.27 dBm / 0.0671 W 802.11n HT20 : 18.28 dBm / 0.0673 W 802.11n HT40 : 16.40 dBm / 0.0437 W 802.11ac VHT20 : 18.18 dBm / 0.0658 W 802.11ac VHT40 : 16.37 dBm / 0.0434 W 802.11ac VHT80 : 17.89 dBm / 0.0615 W</p> <p><5500 MHz ~ 5700 MHz > 802.11a : 18.56 dBm / 0.0718 W 802.11n HT20 : 18.38 dBm / 0.0689 W 802.11n HT40 : 16.72 dBm / 0.0470 W 802.11ac VHT20 : 18.17 dBm / 0.0656 W 802.11ac VHT40 : 16.56 dBm / 0.0453 W 802.11ac VHT80 : 17.54 dBm / 0.0568 W</p>
99% Occupied Bandwidth	<p><5180 MHz ~ 5240 MHz> 802.11a : 17.88 MHz 802.11n HT20 : 18.68 MHz 802.11n HT40 : 36.56 MHz 802.11ac VHT80 : 75.76 MHz</p> <p><5260 MHz ~ 5320 MHz> 802.11a : 17.68 MHz 802.11n HT20 : 18.73 MHz 802.11n HT40 : 36.46 MHz 802.11ac VHT80 : 75.64 MHz</p> <p><5500 MHz ~ 5700 MHz > 802.11a : 17.93 MHz 802.11n HT20 : 18.78 MHz 802.11n HT40 : 36.66 MHz 802.11ac VHT80 : 75.64 MHz</p>
Antenna Type / Gain	<p><5180 MHz ~ 5240 MHz> PIFA Antenna with gain -1.50 dBi</p> <p><5260 MHz ~ 5320 MHz> PIFA Antenna with gain -1.50 dBi</p> <p><5500 MHz ~ 5700 MHz> PIFA Antenna with gain -1.50 dBi</p>
Type of Modulation	802.11a/n/ac : OFDM (BPSK / QPSK / 16QAM / 64QAM / 256QAM)

Note: For 802.11n HT20 / ac VHT20 and 802.11n HT40 / ac VHT40 mode, the whole testing have assessed only 802.11n HT20 / HT40 by referring to their maximum conducted power.



1.5 Modification of EUT

No modifications are made to the EUT during all test items.

1.6 Specification of Accessory

Specification of Accessory				
AC Adapter 1	Brand Name	Motorola (Acbel)	Model Name	SC-41
	Power Rating	I/P: 100-240 Vac, 300mA ,50/60HZ O/P: 5Vdc, 2000mA		
AC Adapter 2	Brand Name	Motorola (Chenyang)	Model Name	SC-41
	Power Rating	I/P: 100-240 Vac, 300mA ,50/60HZ O/P: 5Vdc, 2000mA		
Battery	Brand Name	Motorola (ATL)	Model Name	KG40
	Power Rating	3.8Vdc, 3760/4000mAh	Type	Li-ion, Polymer
USB Cable 1	Brand Name	Motorola (LiQi)	Model Name	L52B-053000100
	Signal Line Type	1.0 meter, shielded cable, without ferrite core		
USB Cable 2	Brand Name	Motorola (SaiBao)	Model Name	S52B-053000100
	Signal Line Type	1.0 meter, shielded cable, without ferrite core		

1.7 Testing Location

Sporton International (Kunshan) Inc. is accredited to ISO/IEC 17025:2017 by American Association for Laboratory Accreditation with Certificate Number 5145.02.

Test Firm	Sporton International (Kunshan) Inc.		
Test Site Location	No. 1098, Pengxi North Road, Kunshan Economic Development Zone Jiangsu Province 215300 People's Republic of China TEL : +86-512-57900158 FAX : +86-512-57900958		
Test Site No.	Sporton Site No.	FCC Designation No.	FCC Test Firm Registration No.
	CO01-KS 03CH06-KS TH01-KS	CN1257	314309

1.8 Test Software

Item	Site	Manufacture	Name	Version
1.	03CH06-KS	AUDIX	E3	6.2009-8-24al
2.	CO01-KS	AUDIX	E3	6.2009-8-24



1.9 Applicable Standards

According to the specifications of the manufacturer, the EUT must comply with the requirements of the following standards:

- ♦ 47 CFR Part 15 Subpart E
- ♦ FCC KDB 789033 D02 General UNII Test Procedures New Rules v02r01.
- ♦ ANSI C63.10-2013

Remark:

1. All test items were verified and recorded according to the standards and without any deviation during the test.
2. This EUT has also been tested and complied with the requirements of FCC Part 15, Subpart B, recorded in a separate test report.



2 Test Configuration of Equipment Under Test

- a. The EUT has been associated with peripherals and configuration operated in a manner tended to maximize its emission characteristics in a typical application. Frequency range investigated: conduction emission (150 kHz to 30 MHz), radiation emission (9 kHz to the 10th harmonic of the highest fundamental frequency or to 40 GHz, whichever is lower). For radiated measurement, pre-scanned in three orthogonal panels, X, Y, Z. The worst cases (Z plane) were recorded in this report.
- b. AC power line Conducted Emission was tested under maximum output power.

2.1 Carrier Frequency and Channel

Frequency Band	Channel	Freq. (MHz)	Channel	Freq. (MHz)
5180-5240 MHz Band 1 (U-NII-1)	36	5180	44	5220
	38*	5190	46*	5230
	40	5200	48	5240
	42 [#]	5210		

Frequency Band	Channel	Freq. (MHz)	Channel	Freq. (MHz)
5260-5320 MHz Band 2 (U-NII-2A)	52	5260	60	5300
	54*	5270	62*	5310
	56	5280	64	5320
	58 [#]	5290		

Frequency Band	Channel	Freq. (MHz)	Channel	Freq. (MHz)
5500-5700 MHz Band 3 (U-NII-2C)	100	5500	112	5560
	102*	5510	116	5580
	104	5520	132	5660
	106 [#]	5530	134*	5670
	108	5540	136	5680
	110*	5550	140	5700



Frequency Band	Channel	Freq. (MHz)	Channel	Freq. (MHz)
TDWR Channel	118*	5590	124	5620
	120	5600	126*	5630
	122 [#]	5610	128	5640

Note:

1. The above Frequency and Channel in "*" were 802.11n HT40 and 802.11ac VHT40.
2. The above Frequency and Channel in "[#]" were 802.11ac VHT80.



2.2 Test Mode

Final test modes are considering the modulation and worse data rates as below table.

Modulation	Data Rate
802.11a	6 Mbps
802.11n HT20	MCS0
802.11n HT40	MCS0
802.11ac VHT80	MCS0

Test Cases	
AC Conducted Emission	Mode 1 : GSM 850 Idle + Bluetooth Link + WLAN Link(5G) + Earphone + USB Cable 1(Charging from Adapter 1)



Ch. #		Band I : 5180-5240 MHz	Band II : 5260-5320 MHz	Band III : 5500-5700MHz
		802.11a	802.11a	802.11a
L	Low	36	52	100
M	Middle	44	60	116
H	High	48	64	140

Ch. #		Band I : 5180-5240 MHz	Band II : 5260-5320 MHz	Band III : 5500-5700MHz
		802.11n HT20	802.11n HT20	802.11n HT20
L	Low	36	52	100
M	Middle	44	60	116
H	High	48	64	140

Ch. #		Band I : 5180-5240 MHz	Band II : 5260-5320 MHz	Band III : 5500-5700MHz
		802.11n HT40	802.11n HT40	802.11n HT40
L	Low	38	54	102
M	Middle	-	-	110
H	High	46	62	134

Ch. #		Band I : 5180-5240 MHz	Band II : 5260-5320 MHz	Band III : 5500-5700MHz
		802.11ac VHT80	802.11ac VHT80	802.11ac VHT80
L	Low	-	-	106
M	Middle	42	58	-
H	High	-	-	122

2.3 Connection Diagram of Test System

For Radiation

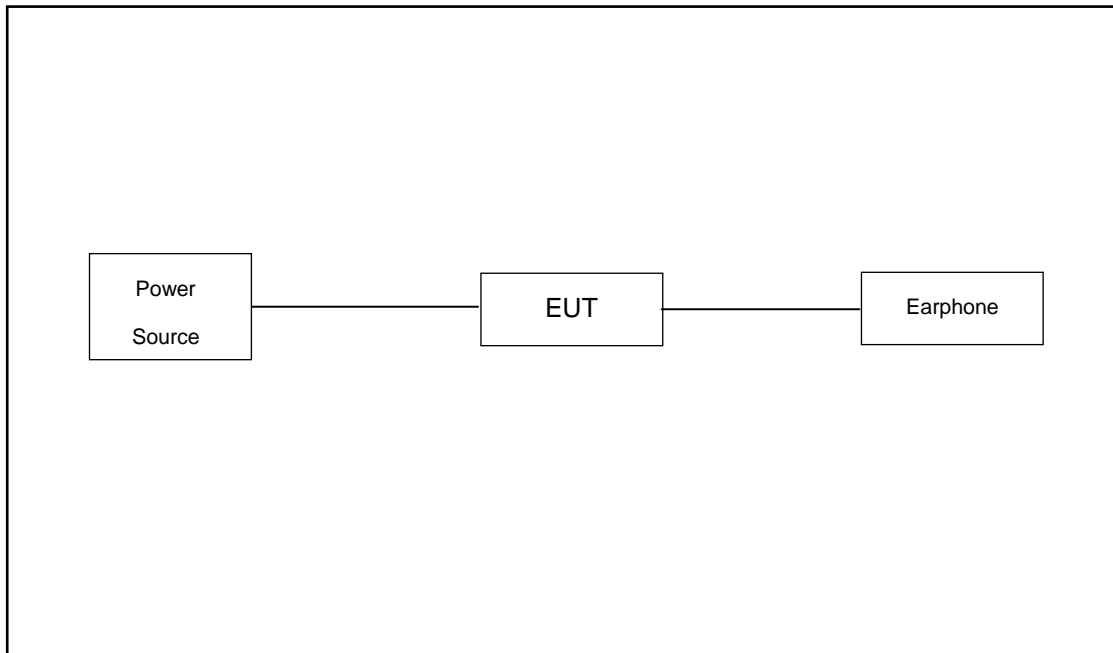

For Conducted Emission

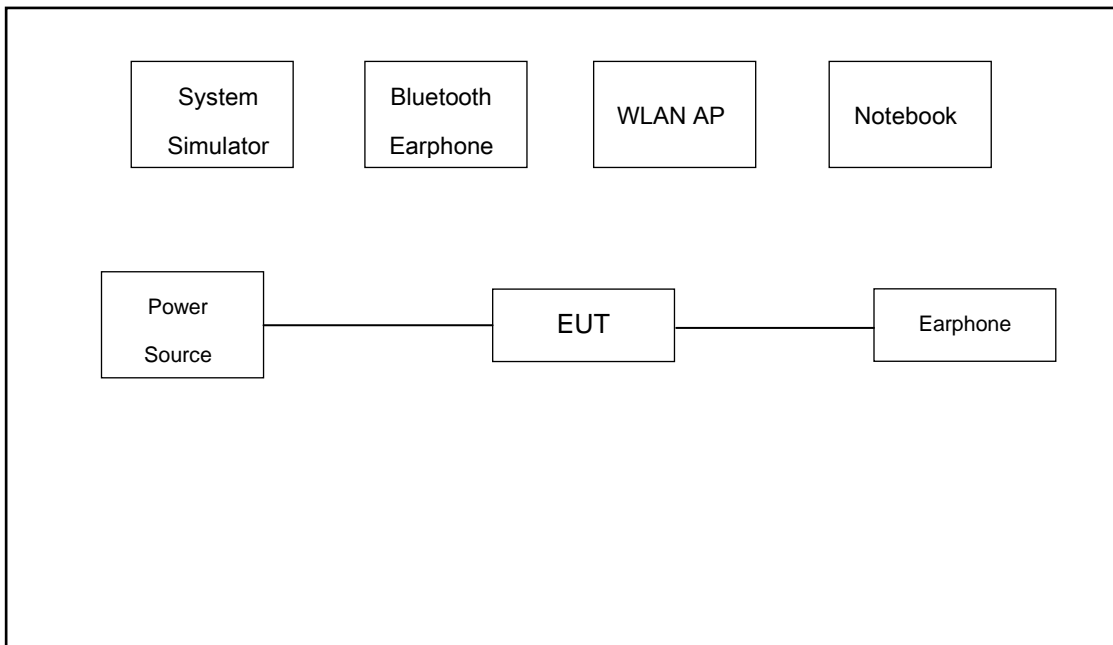



2.4 Support Unit used in test configuration and system

Item	Equipment	Trade Name	Model Name	FCC ID	Data Cable	Power Cord
1.	Base Station	Anritsu	MT8820C	N/A	N/A	Unshielded,1.8m
2.	Bluetooth Earphone	Lenovo	LBH308	N/A	N/A	N/A
3.	Notebook	Lenovo	G480	QDS-BRCM1050I	N/A	shielded cable DC O/P 1.8m , Unshielded AC I/P cable 1.8m
4.	WLAN AP	D-Link	DIR-655	KA21R655B1	N/A	Unshielded,1.8m
5.	Earphone	Moto	SH38C16618	N/A	Unshielded,1.2m	N/A

2.5 EUT Operation Test Setup

For WLAN RF test items, an engineering test program was provided and enabled to make EUT continuously transmit/receive.

For AC power line conducted emissions, the EUT was set to connect with the WLAN AP under large package sizes transmission.

2.6 Measurement Results Explanation Example

For all conducted test items:

The offset level is set in the spectrum analyzer to compensate the RF cable loss between EUT conducted output port and spectrum analyzer. With the offset compensation, the spectrum analyzer reading level is exactly the EUT RF output level.

Example :

The spectrum analyzer offset is derived from RF cable loss.

$$\text{Offset} = \text{RF cable loss}$$

Following shows an offset computation example with cable loss 7.20 dB.

$$\begin{aligned} \text{Offset}(dB) &= \text{RF cable loss}(dB). \\ &= 7.20 \text{ (dB)} \end{aligned}$$

3 Test Result

3.1 26dB & 99% Occupied Bandwidth Measurement

3.1.1 Description of 26dB & 99% Occupied Bandwidth

This section is for reporting purpose only.

There is no restriction limits for bandwidth.

3.1.2 Measuring Instruments

The measuring equipment is listed in the section 4 of this test report.

3.1.3 Test Procedures

1. The testing follows FCC KDB 789033 D02 General UNII Test Procedures New Rules v02r01. Section C) Emission bandwidth
2. Set RBW = approximately 1% of the emission bandwidth.
3. Set the VBW > RBW.
4. Detector = Peak.
5. Trace mode = max hold
6. Measure the maximum width of the emission that is 26 dB down from the peak of the emission. Compare this with the RBW setting of the analyzer. Readjust RBW and repeat measurement as needed until the RBW/EBW ratio is approximately 1%.
7. For 99% Bandwidth Measurement, the spectrum analyzer's resolution bandwidth (RBW) is set 1MHz and set the Video bandwidth (VBW) $\geq 3 * RBW$.
8. Measure and record the results in the test report.

3.1.4 Test Setup

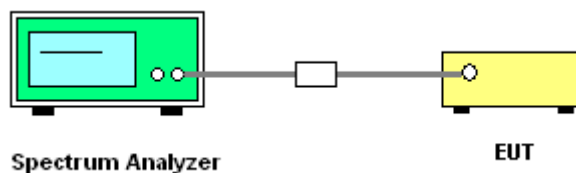

3.1.5 Test Result of 26dB & 99% Occupied Bandwidth

Please refer to Appendix A.

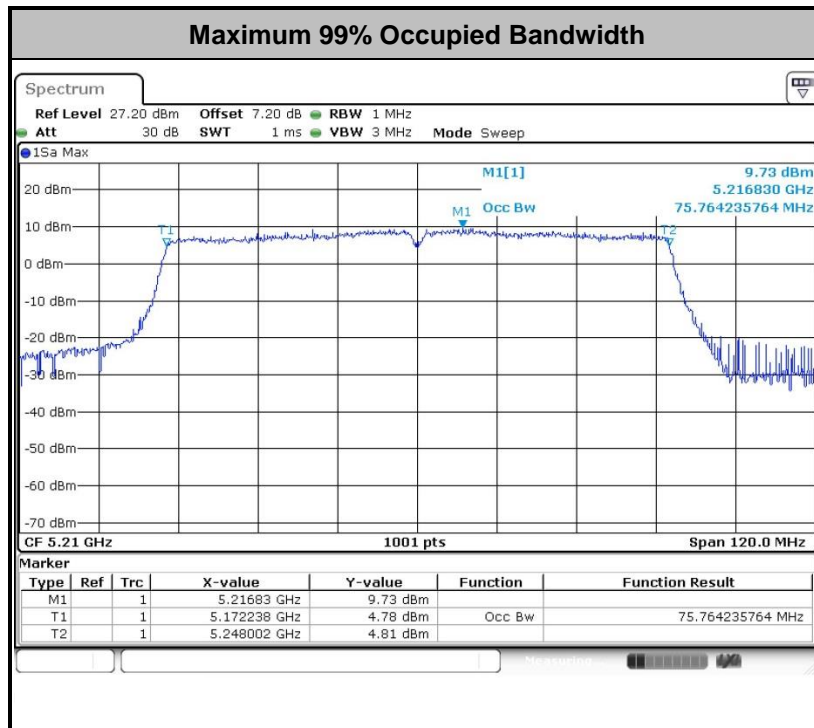
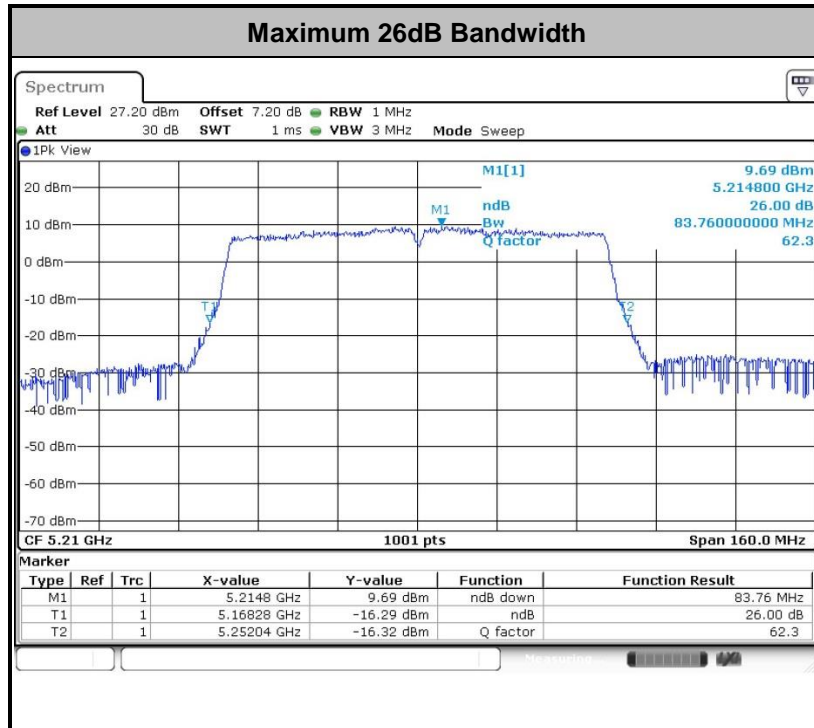

Note: The occupied channel bandwidth is maintained within the band of operation for all of the modulations.



3.2 Maximum Conducted Output Power Measurement

3.2.1 Limit of Maximum Conducted Output Power

<FCC 14-30 CFR 15.407>

For mobile and portable client devices in the 5.15–5.25 GHz band, the maximum conducted output power over the frequency band of operation shall not exceed 250 mW.

For the 5.25–5.725 GHz bands, the maximum conducted output power over the frequency bands of operation shall not exceed the lesser of 250 mW or $11 \text{ dBm} + 10 \log B$, where B is the 26 dB emission bandwidth in megahertz.

If transmitting antennas of directional gain greater than 6 dBi are used, the peak output power shall be reduced by the amount in dB that the directional gain of the antenna exceeds 6 dBi.

Note that U-NII-2 band, devices with a maximum e.i.r.p. greater than 500 mW shall implement TPC in order to have the capability to operate at least 6 dB below the maximum permitted e.i.r.p. of 1 W.

3.2.2 Measuring Instruments

The measuring equipment is listed in the section 4 of this test report.

3.2.3 Test Procedures

The testing follows Method PM of FCC KDB 789033 D02 General UNII Test Procedures New Rules v02r01.

Method PM (Measurement using an RF average power meter):

1. Measurement is performed using a wideband RF power meter.
2. The EUT is configured to transmit continuously with a consistent duty cycle at its maximum power control level.
3. Measure the average power of the transmitter, and the average power is corrected with duty factor, $10 \log(1/x)$, where x is the duty cycle.

3.2.4 Test Setup

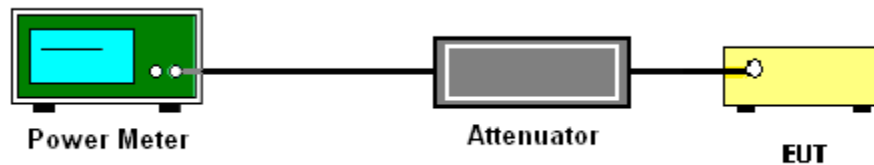

3.2.5 Test Result of Maximum Conducted Output Power

Please refer to Appendix A.



3.3 Power Spectral Density Measurement

3.3.1 Limit of Power Spectral Density

<FCC 14-30 CFR 15.407>

For mobile and portable client devices in the 5.15–5.25 GHz band, the maximum power spectral density shall not exceed 11dBm in any 1 megahertz band.

For the 5.25–5.725 GHz bands, the maximum power spectral density shall not exceed 11 dBm in any 1 megahertz band.

If transmitting antennas of directional gain greater than 6 dBi are used, the peak output power shall be reduced by the amount in dB that the directional gain of the antenna exceeds 6 dBi.

3.3.2 Measuring Instruments

The measuring equipment is listed in the section 4 of this test report.

3.3.3 Test Procedures

The testing follows FCC KDB 789033 D02 General UNII Test Procedures New Rules v02r01.
Section F) Maximum power spectral density.

Method SA-2

(trace averaging across on and off times of the EUT transmissions, followed by duty cycle correction).

- Measure the duty cycle.
 - Set span to encompass the entire emission bandwidth (EBW) of the signal.
 - Set RBW = 1 MHz.
 - Set VBW \geq 3 MHz.
 - Number of points in sweep \geq 2 Span / RBW.
 - Sweep time = auto.
 - Detector = RMS
 - Trace average at least 100 traces in power averaging mode.
 - Add $10 \log(1/x)$, where x is the duty cycle, to the measured power in order to compute the average power during the actual transmission times. For example, add $10 \log(1/0.25) = 6$ dB if the duty cycle is 25 percent.
1. The RF output of EUT was connected to the spectrum analyzer by a low loss cable.
 2. Each plot has already offset with cable loss, and attenuator loss. Measure the PPSD and record it.

3.3.4 Test Setup

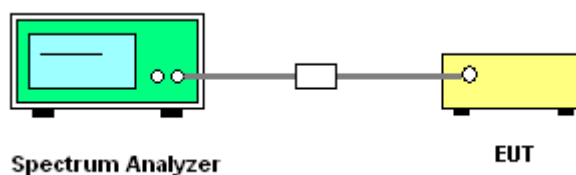

3.3.5 Test Result of Power Spectral Density

Please refer to Appendix A.

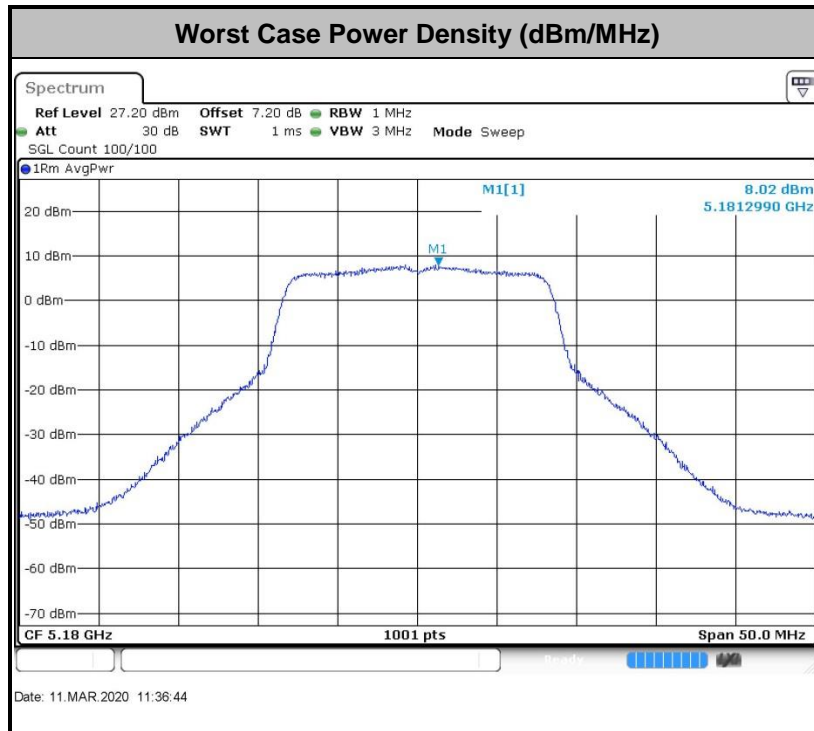

Note: Average Power Density (dB) = Measured value+ Duty Factor



3.4 Unwanted Emissions Measurement

This section is to measure unwanted emissions through radiated measurement for band edge spurious emissions and out of band emissions measurement.

3.4.1 Limit of Unwanted Emissions

- (1) For transmitters operating in the 5150-5250 MHz band: all emissions outside of the 5150-5350 MHz band shall not exceed an EIRP of -27dBm/MHz.

For transmitters operating in the 5250-5350 MHz band: all emissions outside of the 5150-5350 MHz band shall not exceed an EIRP of -27 dBm/MHz. Devices operating in the 5250-5350 MHz band that generate emissions in the 5150-5250 MHz band must meet all applicable technical requirements for operation in the 5150-5250 MHz band (including indoor use) or alternatively meet an out-of-band emission EIRP limit of -27 dBm/MHz in the 5150-5250 MHz band.

For transmitters operating in the 5470-5600 MHz and 5650-5725MHz band: all emissions outside of the 5470-5600 MHz and 5650-5725MHz band shall not exceed an EIRP of -27 dBm/MHz.

- (2) Unwanted spurious emissions fallen in restricted bands shall comply with the general field strength limits as below table,

Frequency (MHz)	Field Strength (microvolts/meter)	Measurement Distance (meters)
0.009 – 0.490	2400/F(kHz)	300
0.490 – 1.705	24000/F(kHz)	30
1.705 – 30.0	30	30
30 – 88	100	3
88 – 216	150	3
216 - 960	200	3
Above 960	500	3



EIRP (dBm)	Field Strength at 3m (dBμV/m)
- 27	68.3

Note: The following formula is used to convert the EIRP to field strength.

$$EIRP = E_{Meas} + 20\log (d_{Meas}) - 104.7$$

where

EIRP is the equivalent isotropically radiated power, in dBm

E_{Meas} is the field strength of the emission at the measurement distance, in dBμV/m

d_{Meas} is the measurement distance, in m

3.4.2 Measuring Instruments

The measuring equipment is listed in the section 4 of this test report.



3.4.3 Test Procedures

1. The testing follows FCC KDB 789033 D02 General UNII Test Procedures New Rules v02r01. Section G) Unwanted emissions measurement.
 - (1) Procedure for Unwanted Emissions Measurements Below 1000MHz
 - RBW = 120 kHz
 - VBW = 300 kHz
 - Detector = Peak
 - Trace mode = max hold
 - (2) Procedure for Peak Unwanted Emissions Measurements Above 1000 MHz
 - RBW = 1 MHz
 - VBW \geq 3 MHz
 - Detector = Peak
 - Sweep time = auto
 - Trace mode = max hold
 - (3) Procedures for Average Unwanted Emissions Measurements Above 1000MHz
 - RBW = 1 MHz
 - VBW = 10 Hz, when duty cycle is no less than 98 percent.
 - VBW \geq 1/T, when duty cycle is less than 98 percent where T is the minimum transmission duration over which the transmitter is on and is transmitting at its maximum power control level for the tested mode of operation.
2. The EUT was placed on a turntable with 0.8 meter for frequency below 1GHz and 1.5 meter for frequency above 1GHz respectively above ground.
3. The EUT was set 3 meters from the interference receiving antenna which was mounted on the top of a variable height antenna tower.
4. The antenna is a broadband antenna and its height is adjusted between one meter and four meters above ground to find the maximum value of the field strength for both horizontal polarization and vertical polarization of the antenna.
5. For each suspected emission, the EUT was arranged to its worst case and then adjust the antenna tower (from 1 m to 4 m) and turntable (from 0 degree to 360 degrees) to find the maximum reading.
6. For testing below 1GHz, if the emission level of the EUT in peak mode was 3 dB lower than the limit specified, then peak values of EUT will be reported, otherwise, the emissions will be repeated one by one using the CISPR quasi-peak method and reported.
7. For testing above 1GHz, the emission level of the EUT in peak mode was 20dB lower than average limit (that means the emission level in average mode also complies with the limit in average mode), then peak values of EUT will be reported, otherwise, the emissions will be measured in average mode again and reported.

3.4.4 Test Setup

For radiated emissions below 30MHz

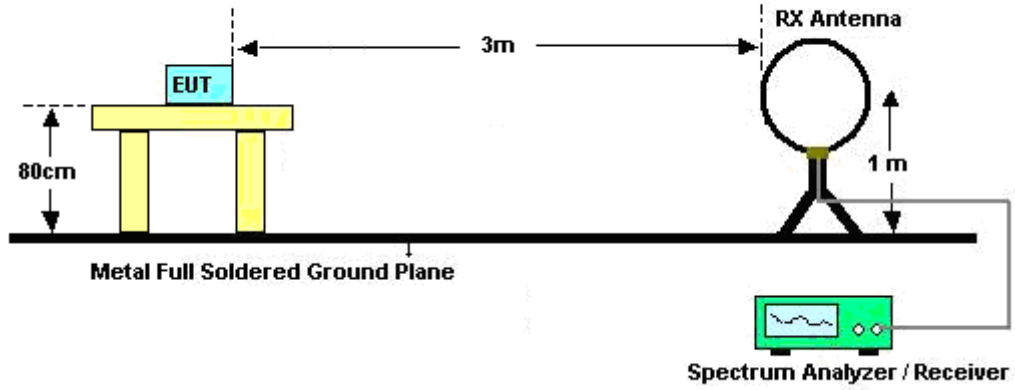

For radiated emissions from 30MHz to 1GHz

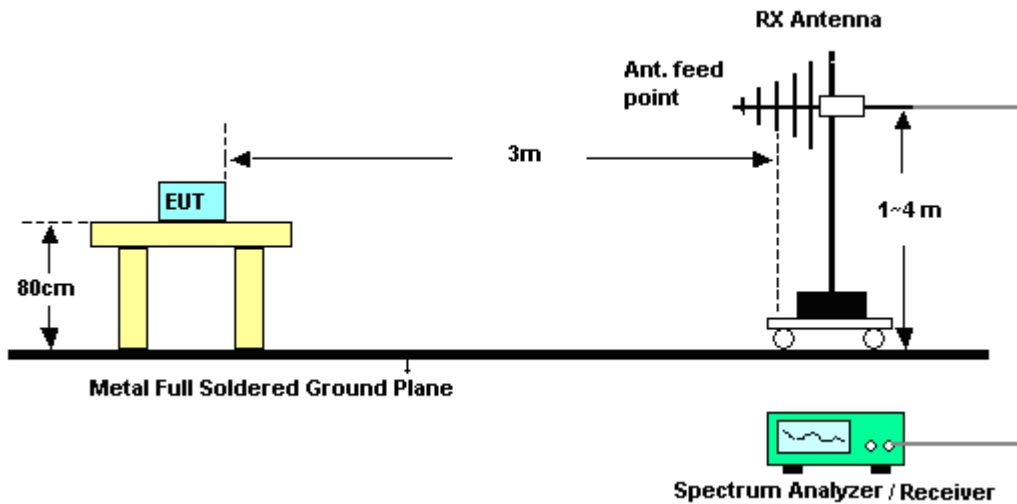

For radiated emissions above 1GHz

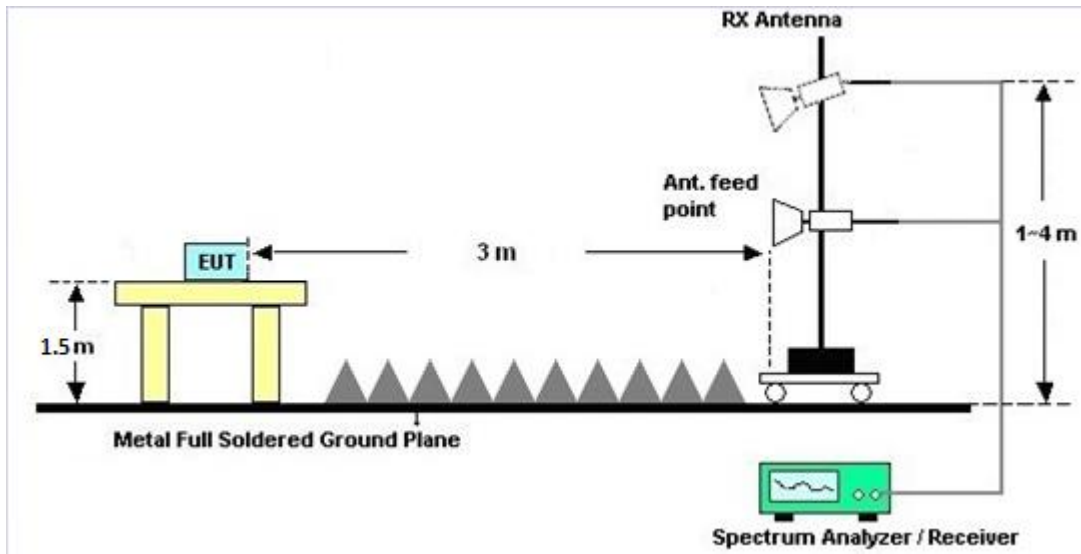



3.4.5 Test Results of Radiated Spurious Emissions (9 kHz ~ 30 MHz)

The low frequency, which started from 9 kHz to 30MHz, was pre-scanned and the result which was 20dB lower than the limit line was not reported.

There is a comparison data of both open-field test site and semi-Anechoic chamber, and the result came out very similar.

3.4.6 Test Result of Radiated Spurious at Band Edges

Please refer to Appendix C.

3.4.7 Duty Cycle

Please refer to Appendix D.

3.4.8 Test Result of Radiated Spurious Emissions (30MHz ~ 10th Harmonic)

Please refer to Appendix C.



3.5 AC Conducted Emission Measurement

3.5.1 Limit of AC Conducted Emission

For equipment that is designed to be connected to the public utility (AC) power line, the radio frequency voltage that is conducted back onto the AC power line on any frequency or frequencies within the band 150 kHz to 30 MHz shall not exceed the limits in the following table.

Frequency of emission (MHz)	Conducted limit (dBµV)	
	Quasi-peak	Average
0.15-0.5	66 to 56*	56 to 46*
0.5-5	56	46
5-30	60	50

*Decreases with the logarithm of the frequency.

3.5.2 Measuring Instruments

The measuring equipment is listed in the section 4 of this test report.

3.5.3 Test Procedures

1. The EUT was placed 0.4 meter from the conducting wall of the shielding room was kept at least 80 centimeters from any other grounded conducting surface.
2. Connect EUT to the power mains through a line impedance stabilization network (LISN).
3. All the support units are connecting to the other LISN.
4. The LISN provides 50 ohm coupling impedance for the measuring instrument.
5. The FCC states that a 50 ohm, 50 microhenry LISN should be used.
6. Both sides of AC line were checked for maximum conducted interference.
7. The frequency range from 150 kHz to 30 MHz was searched.
8. Set the test-receiver system to Peak Detect Function and specified bandwidth with Maximum Hold Mode.

3.5.4 Test Setup



3.5.5 Test Result of AC Conducted Emission

Please refer to Appendix B.



3.6 Automatically Discontinue Transmission

3.6.1 Limit of Automatically Discontinue Transmission

The device shall automatically discontinue transmission in case of either absence of information to transmit or operational failure. These provisions are not intended to preclude the transmission of control or signaling information or the use of repetitive codes used by certain digital technologies to complete frame or burst intervals. Applicants shall include in their application for equipment authorization to describe how this requirement is met.

3.6.2 Measuring Instruments

The measuring equipment is listed in the section 4 of this test report.

3.6.3 Test Result of Automatically Discontinue Transmission

While the EUT is not transmitting any information, the EUT can automatically discontinue transmission and become standby mode for power saving. The EUT can detect the controlling signal of ACK message transmitting from remote device and verify whether it shall resend or discontinue transmission.



3.7 Antenna Requirements

3.7.1 Standard Applicable

If transmitting antenna directional gain is greater than 6 dBi, both the peak transmit power and the peak power spectral density shall be reduced by the amount in dB that the directional gain of the antenna exceeds 6 dBi.

3.7.2 Antenna Anti-Replacement Construction

An embedded-in antenna design is used.

3.7.3 Antenna Gain

The antenna peak gain of EUT is less than 6 dBi. Therefore, it is not necessary to reduce maximum peak output power limit.



4 List of Measuring Equipment

Instrument	Manufacturer	Model No.	Serial No.	Characteristics	Calibration Date	Test Date	Due Date	Remark
Spectrum Analyzer	R&S	FSV40	101040	10Hz~40GHz	Nov. 02, 2019	Mar. 11, 2020	Nov. 01, 2020	Conducted (TH01-KS)
Pulse Power Sensor	Anritsu	MA2411B	0917070	300MHz~40GHz	Jan. 08, 2020	Mar. 11, 2020	Jan. 07, 2021	Conducted (TH01-KS)
Power Meter	Anritsu	ML2495A	1005002	50MHz Bandwidth	Jan. 08, 2020	Mar. 11, 2020	Jan. 07, 2021	Conducted (TH01-KS)
EMI Test Receiver	Keysight	N9038A	MY57290157	3Hz~8.5GHz;Max 30dBm	Jul. 18, 2019	Mar. 06, 2020	Jul. 17, 2020	Radiation (03CH06-KS)
EXA Spectrum Analyzer	Keysight	N9010A	MY55150208	10Hz~44GHz	Apr. 16, 2019	Mar. 06, 2020	Apr. 15, 2020	Radiation (03CH06-KS)
Loop Antenna	R&S	HFH2-Z2	100321	9kHz~30MHz	Nov. 10, 2019	Mar. 06, 2020	Nov. 09, 2020	Radiation (03CH06-KS)
Bilog Antenna	TeseQ	CBL6111D	49921	30MHz~1GHz	May 30, 2019	Mar. 06, 2020	May 29, 2020	Radiation (03CH06-KS)
Double Ridge Horn Antenna	ETS-Lindgren	3117	00218652	1GHz~18GHz	Apr. 27, 2019	Mar. 06, 2020	Apr. 26, 2020	Radiation (03CH06-KS)
SHF-EHF Horn	Com-power	AH-840	101115	18GHz~40GHz	Nov. 10, 2019	Mar. 06, 2020	Nov. 09, 2020	Radiation (03CH06-KS)
Amplifier	SONOMA	310N	187289	9KHz ~1GHZ	Aug. 06, 2019	Mar. 06, 2020	Aug. 05, 2020	Radiation (03CH06-KS)
Amplifier	MITEQ	EM18G40GGA	060728	18~40GHz	Jan. 08, 2020	Mar. 06, 2020	Jan. 07, 2021	Radiation (03CH06-KS)
high gain Amplifier	MITEQ	AMF-7D-00101800-30-10P	2025788	1Ghz-18Ghz	Aug. 16, 2019	Mar. 06, 2020	Aug. 15, 2020	Radiation (03CH06-KS)
Amplifier	Keysight	83017A	MY53270203	500MHz~26.5GHz	Apr. 15, 2019	Mar. 06, 2020	Apr. 14, 2020	Radiation (03CH06-KS)
AC Power Source	Chroma	61601	F104090004	N/A	NCR	Mar. 06, 2020	NCR	Radiation (03CH06-KS)
Turn Table	ChamPro	EM 1000-T	060762-T	0~360 degree	NCR	Mar. 06, 2020	NCR	Radiation (03CH06-KS)
Antenna Mast	ChamPro	EM 1000-A	060762-A	1 m~4 m	NCR	Mar. 06, 2020	NCR	Radiation (03CH06-KS)
EMI Receiver	R&S	ESCI7	100768	9kHz~7GHz;	Apr. 16, 2019	Jan. 18, 2020	Apr. 15, 2020	Conduction (CO01-KS)
AC LISN (for auxiliary equipment)	MessTec	AN3016	060103	9kHz~30MHz	Oct. 18, 2019	Jan. 18, 2020	Oct. 17, 2020	Conduction (CO01-KS)
AC LISN	MessTec	AN3016	060105	9kHz~30MHz	Oct. 28, 2019	Jan. 18, 2020	Oct. 27, 2020	Conduction (CO01-KS)
AC Power Source	Chroma	61602	ABP00000811	AC 0V~300V, 45Hz~1000Hz	Oct. 18, 2019	Jan. 18, 2020	Oct. 17, 2020	Conduction (CO01-KS)

NCR: No Calibration Required



5 Uncertainty of Evaluation

The measurement uncertainties shown below were calculated in accordance with the requirements of ANSI 63.10-2013. All the measurement uncertainty value were shown with a coverage K=2 to indicate 95% level of confidence. The measurement data show herein meets or exceeds the CISPR measurement uncertainty values specified in CISPR 16-4-2 and can be compared directly to specified limit to determine compliance.

Uncertainty of Conducted Emission Measurement (150kHz ~ 30MHz)

Measuring Uncertainty for a Level of Confidence of 95% (U = 2Uc(y))	2.9dB
---	-------

Uncertainty of Radiated Emission Measurement (30 MHz ~ 1000 MHz)

Measuring Uncertainty for a Level of Confidence of 95% (U = 2Uc(y))	5.0dB
---	-------

Uncertainty of Radiated Emission Measurement (1000 MHz ~ 18000 MHz)

Measuring Uncertainty for a Level of Confidence of 95% (U = 2Uc(y))	5.0dB
---	-------

Uncertainty of Radiated Emission Measurement (18000 MHz ~ 40000 MHz)

Measuring Uncertainty for a Level of Confidence of 95% (U = 2Uc(y))	5.0dB
---	-------



Appendix A. Conducted Test Results

Test Engineer:	weller liu	Temperature:	21~25	°C
Test Date:	2020/3/11	Relative Humidity:	51~54	%

TEST RESULTS DATA
26dB and 99% OBW

Band I										
Mod.	Data Rate	NTX	CH.	Freq. (MHz)	99% Bandwidth (MHz)	26 dB Bandwidth (MHz)	IC 99% Bandwidth Power Limit (dBm)	IC 99% Bandwidth EIRP Limit (dBm)		
11a	6Mbps	1	36	5180	17.53	23.53	-	22.44		
11a	6Mbps	1	44	5220	17.88	23.73	-	22.52		
11a	6Mbps	1	48	5240	17.63	24.03	-	22.46		
HT20	MCS0	1	36	5180	18.68	24.33	-	22.71		
HT20	MCS0	1	44	5220	18.68	24.43	-	22.71		
HT20	MCS0	1	48	5240	18.68	24.18	-	22.71		
HT40	MCS0	1	38	5190	36.56	41.90	-	23.01		
HT40	MCS0	1	46	5230	36.36	41.99	-	23.01		
VHT80	MCS0	1	42	5210	75.76	83.76	-	23.01		

TEST RESULTS DATA
Average Power Table

FCC Band I										
Mod.	Data Rate	NTX	CH.	Freq. (MHz)	Duty Factor (dB)	Average Conducted Power (dBm)	FCC Conducted Power Limit (dBm)	DG (dBi)		Pass/Fail
11a	6Mbps	1	36	5180	0.11	18.30	24.00	-1.50		Pass
11a	6Mbps	1	44	5220	0.11	18.28	24.00	-1.50		Pass
11a	6Mbps	1	48	5240	0.11	18.21	24.00	-1.50		Pass
HT20	MCS0	1	36	5180	0.12	18.29	24.00	-1.50		Pass
HT20	MCS0	1	44	5220	0.12	18.17	24.00	-1.50		Pass
HT20	MCS0	1	48	5240	0.12	18.10	24.00	-1.50		Pass
HT40	MCS0	1	38	5190	0.24	16.32	24.00	-1.50		Pass
HT40	MCS0	1	46	5230	0.24	16.36	24.00	-1.50		Pass
VHT20	MCS0	1	36	5180	0.12	18.18	24.00	-1.50		Pass
VHT20	MCS0	1	44	5220	0.12	18.08	24.00	-1.50		Pass
VHT20	MCS0	1	48	5240	0.12	18.01	24.00	-1.50		Pass
VHT40	MCS0	1	38	5190	0.23	16.30	24.00	-1.50		Pass
VHT40	MCS0	1	46	5230	0.23	16.35	24.00	-1.50		Pass
VHT80	MCS0	1	42	5210	0.46	17.97	24.00	-1.50		Pass

TEST RESULTS DATA
Power Spectral Density

FCC Band I										
Mod.	Data Rate	N _{TX}	CH.	Freq. (MHz)	Duty Factor (dB)	Average Power Density (dBm/MHz)	Average PSD Limit (dBm/MHz)	DG (dBi)	-	Pass/Fail
11a	6Mbps	1	36	5180	0.11	8.13	11.00	-1.50		Pass
11a	6Mbps	1	44	5220	0.11	7.98	11.00	-1.50		Pass
11a	6Mbps	1	48	5240	0.11	8.06	11.00	-1.50		Pass
HT20	MCS0	1	36	5180	0.12	7.67	11.00	-1.50		Pass
HT20	MCS0	1	44	5220	0.12	7.74	11.00	-1.50		Pass
HT20	MCS0	1	48	5240	0.12	7.60	11.00	-1.50		Pass
HT40	MCS0	1	38	5190	0.24	3.02	11.00	-1.50		Pass
HT40	MCS0	1	46	5230	0.24	3.25	11.00	-1.50		Pass
VHT80	MCS0	1	42	5210	0.46	1.22	11.00	-1.50		Pass

TEST RESULTS DATA
26dB and 99% OBW

Band II										
Mod.	Data Rate	N _{TX}	CH.	Freq. (MHz)	99% Bandwidth (MHz)	26 dB Bandwidth (MHz)	IC 99% Bandwidth Power Limit (dBm)	IC 99% Bandwidth EIRP Limit (dBm)	FCC 26dB Bandwidth Power Limit (dBm)	Note
11a	6M bps	1	52	5260	17.68	23.38	23.48	29.48	23.98	
11a	6M bps	1	60	5300	17.63	24.13	23.46	29.46	23.98	
11a	6M bps	1	64	5320	17.63	23.13	23.46	29.46	23.98	
HT20	MCS 0	1	52	5260	18.73	24.58	23.73	29.73	23.98	
HT20	MCS 0	1	60	5300	18.63	24.73	23.70	29.70	23.98	
HT20	MCS 0	1	64	5320	18.63	24.28	23.70	29.70	23.98	
HT40	MCS 0	1	54	5270	36.46	41.90	23.98	30.00	23.98	
HT40	MCS 0	1	62	5310	36.46	41.81	23.98	30.00	23.98	
VHT80	MCS 0	1	58	5290	75.64	83.12	23.98	30.00	23.98	

TEST RESULTS DATA
Average Power Table

FCC Band II										
Mod.	Data Rate	N _{TX}	CH.	Freq. (MHz)	Duty Factor (dB)	Average Conducted Power (dBm)	FCC Conducted Power Limit (dBm)	DG (dBi)	EIRP Power Limit (dBm)	Pass/Fail
11a	6M bps	1	52	5260	0.11	18.27	23.98	-1.50	26.99	Pass
11a	6M bps	1	60	5300	0.11	18.03	23.98	-1.50	26.99	Pass
11a	6M bps	1	64	5320	0.11	18.13	23.98	-1.50	26.99	Pass
HT20	MCS 0	1	52	5260	0.12	18.28	23.98	-1.50	26.99	Pass
HT20	MCS 0	1	60	5300	0.12	18.13	23.98	-1.50	26.99	Pass
HT20	MCS 0	1	64	5320	0.12	18.06	23.98	-1.50	26.99	Pass
HT40	MCS 0	1	54	5270	0.24	16.40	23.98	-1.50	26.99	Pass
HT40	MCS 0	1	62	5310	0.24	16.27	23.98	-1.50	26.99	Pass
VHT20	MCS 0	1	52	5260	0.12	18.18	23.98	-1.50	26.99	Pass
VHT20	MCS 0	1	60	5300	0.12	18.01	23.98	-1.50	26.99	Pass
VHT20	MCS 0	1	64	5320	0.12	17.84	23.98	-1.50	26.99	Pass
VHT40	MCS 0	1	54	5270	0.23	16.37	23.98	-1.50	26.99	Pass
VHT40	MCS 0	1	62	5310	0.23	16.16	23.98	-1.50	26.99	Pass
VHT80	MCS 0	1	58	5290	0.46	17.89	23.98	-1.50	26.99	Pass

TEST RESULTS DATA
Power Spectral Density

Band II										
Mod.	Data Rate	N _{TX}	CH.	Freq. (MHz)	Duty Factor (dB)	Average Power Density (dBm/MHz)	Average PSD Limit (dBm/MHz)	DG (dBi)		Pass/Fail
11a	6M bps	1	52	5260	0.11	7.82	11.00	-1.50		Pass
11a	6M bps	1	60	5300	0.11	7.82	11.00	-1.50		Pass
11a	6M bps	1	64	5320	0.11	7.82	11.00	-1.50		Pass
HT20	MCS 0	1	52	5260	0.12	7.51	11.00	-1.50		Pass
HT20	MCS 0	1	60	5300	0.12	7.51	11.00	-1.50		Pass
HT20	MCS 0	1	64	5320	0.12	7.61	11.00	-1.50		Pass
HT40	MCS 0	1	54	5270	0.24	3.34	11.00	-1.50		Pass
HT40	MCS 0	1	62	5310	0.24	2.99	11.00	-1.50		Pass
VHT80	MCS 0	1	58	5290	0.46	1.18	11.00	-1.50		Pass

TEST RESULTS DATA
26dB and 99% OBW

Band III										
Mod.	Data Rate	N _{TX}	CH.	Freq. (MHz)	99% Bandwidth (MHz)	26 dB Bandwidth (MHz)	IC 99% Bandwidth Power Limit (dBm)	IC 99% Bandwidth EIRP Limit (dBm)	FCC 26dB Bandwidth Power Limit (dBm)	Note
11a	6M bps	1	100	5500	17.83	23.88	23.51	29.51	23.98	
11a	6M bps	1	116	5580	17.93	23.98	23.54	29.54	23.98	
11a	6M bps	1	140	5700	17.78	24.18	23.50	29.50	23.98	
HT20	MCS 0	1	100	5500	18.73	24.63	23.73	29.73	23.98	
HT20	MCS 0	1	116	5580	18.78	24.73	23.74	29.74	23.98	
HT20	MCS 0	1	140	5700	18.68	24.83	23.71	29.71	23.98	
HT40	MCS 0	1	102	5510	36.56	42.26	23.98	30.00	23.98	
HT40	MCS 0	1	110	5550	36.46	41.90	23.98	30.00	23.98	
HT40	MCS 0	1	134	5670	36.66	42.35	23.98	30.00	23.98	
VHT80	MCS 0	1	106	5530	75.64	83.28	23.98	30.00	23.98	
VHT80	MCS 0	1	122	5610	75.52	83.44	23.98	30.00	23.98	

TEST RESULTS DATA
Average Power Table

FCC Band III										
Mod.	Data Rate	N _{TX}	CH.	Freq. (MHz)	Duty Factor (dB)	Average Conducted Power (dBm)	FCC Conducted Power Limit (dBm)	DG (dBi)	EIRP Power Limit (dBm)	Pass/Fail
11a	6M bps	1	100	5500	0.11	17.76	23.98	-1.50	26.99	Pass
11a	6M bps	1	116	5580	0.11	17.27	23.98	-1.50	26.99	Pass
11a	6M bps	1	140	5700	0.11	18.56	23.98	-1.50	26.99	Pass
HT20	MCS 0	1	100	5500	0.12	17.65	23.98	-1.50	26.99	Pass
HT20	MCS 0	1	116	5580	0.12	17.58	23.98	-1.50	26.99	Pass
HT20	MCS 0	1	140	5700	0.12	18.38	23.98	-1.50	26.99	Pass
HT40	MCS 0	1	102	5510	0.24	16.72	23.98	-1.50	26.99	Pass
HT40	MCS 0	1	110	5550	0.24	16.21	23.98	-1.50	26.99	Pass
HT40	MCS 0	1	134	5670	0.24	16.66	23.98	-1.50	26.99	Pass
VHT20	MCS 0	1	100	5500	0.12	17.35	23.98	-1.50	26.99	Pass
VHT20	MCS 0	1	116	5580	0.12	17.08	23.98	-1.50	26.99	Pass
VHT20	MCS 0	1	140	5700	0.12	18.17	23.98	-1.50	26.99	Pass
VHT40	MCS 0	1	102	5510	0.23	16.56	23.98	-1.50	26.99	Pass
VHT40	MCS 0	1	110	5550	0.23	16.19	23.98	-1.50	26.99	Pass
VHT40	MCS 0	1	134	5670	0.23	16.36	23.98	-1.50	26.99	Pass
VHT80	MCS 0	1	106	5530	0.46	17.33	23.98	-1.50	26.99	Pass
VHT80	MCS 0	1	122	5610	0.46	17.54	23.98	-1.50	26.99	Pass

TEST RESULTS DATA
Power Spectral Density

Band III										
Mod.	Data Rate	N _{TX}	CH.	Freq. (MHz)	Duty Factor (dB)	Average Power Density (dBm/MHz)	Average PSD Limit (dBm/MHz)	DG (dBi)		Pass/Fail
11a	6M bps	1	100	5500	0.11	7.38	11.00	-1.50		Pass
11a	6M bps	1	116	5580	0.11	6.71	11.00	-1.50		Pass
11a	6M bps	1	140	5700	0.11	8.01	11.00	-1.50		Pass
HT20	MCS 0	1	100	5500	0.12	6.95	11.00	-1.50		Pass
HT20	MCS 0	1	116	5580	0.12	6.36	11.00	-1.50		Pass
HT20	MCS 0	1	140	5700	0.12	7.57	11.00	-1.50		Pass
HT40	MCS 0	1	102	5510	0.24	3.46	11.00	-1.50		Pass
HT40	MCS 0	1	110	5550	0.24	3.47	11.00	-1.50		Pass
HT40	MCS 0	1	134	5670	0.24	2.87	11.00	-1.50		Pass
VHT80	MCS 0	1	106	5530	0.46	0.19	11.00	-1.50		Pass
VHT80	MCS 0	1	122	5610	0.46	0.56	11.00	-1.50		Pass



Appendix B. AC Conducted Emission Test Results

Test Engineer :	Amos Zhang	Temperature :	25.3~26.2°C
		Relative Humidity :	38~40%
Test Voltage :	120Vac / 60Hz	Phase :	Line
Remark :	All emissions not reported here are more than 10 dB below the prescribed limit.		

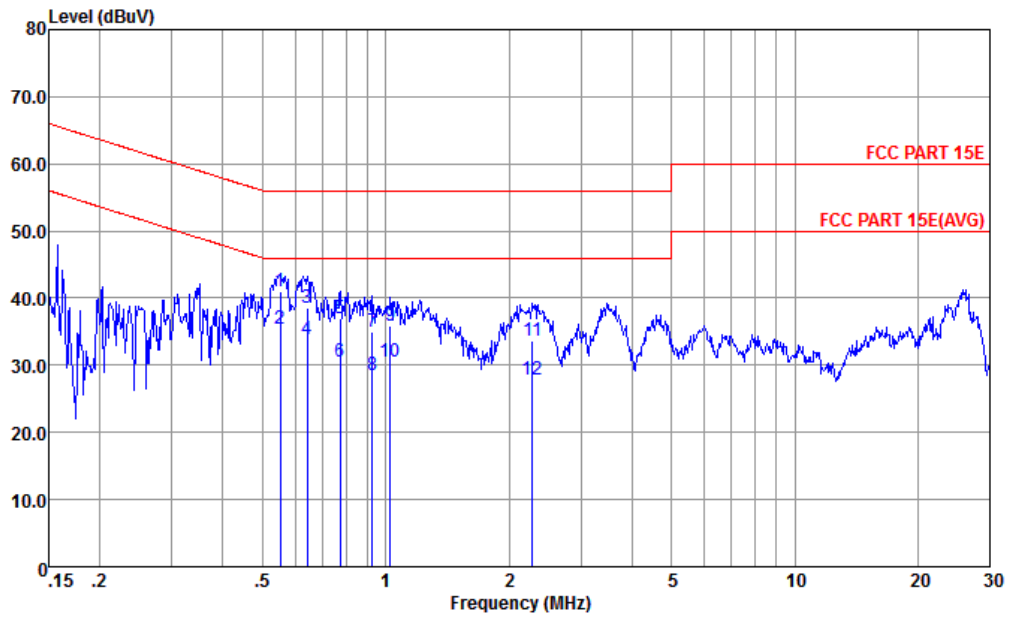

Site : CO01-KS
 Condition : FCC PART 15E LISN-L-191028-060105 LINE

	Freq	Level	Over	Limit	Read	LISN	Cable	
	MHz	dBuV	Limit	Line	Level	Factor	Loss	Remark
			dB	dBuV	dBuV	dB	dB	
1	0.552	40.90	-15.10	56.00	30.60	0.06	10.24	QP
2 *	0.552	35.50	-10.50	46.00	25.20	0.06	10.24	Average
3	0.644	38.50	-17.50	56.00	28.19	0.07	10.24	QP
4	0.644	33.90	-12.10	46.00	23.59	0.07	10.24	Average
5	0.775	36.91	-19.09	56.00	26.60	0.07	10.24	QP
6	0.775	30.61	-15.39	46.00	20.30	0.07	10.24	Average
7	0.928	34.91	-21.09	56.00	24.59	0.08	10.24	QP
8	0.928	28.51	-17.49	46.00	18.19	0.08	10.24	Average
9	1.027	35.91	-20.09	56.00	25.60	0.08	10.23	QP
10	1.027	30.51	-15.49	46.00	20.20	0.08	10.23	Average
11	2.285	33.65	-22.35	56.00	23.31	0.11	10.23	QP
12	2.285	27.85	-18.15	46.00	17.51	0.11	10.23	Average



Test Engineer :	Amos Zhang	Temperature :	25.3~26.2°C
		Relative Humidity :	38~40%
Test Voltage :	120Vac / 60Hz	Phase :	Neutral
Remark :	All emissions not reported here are more than 10 dB below the prescribed limit.		

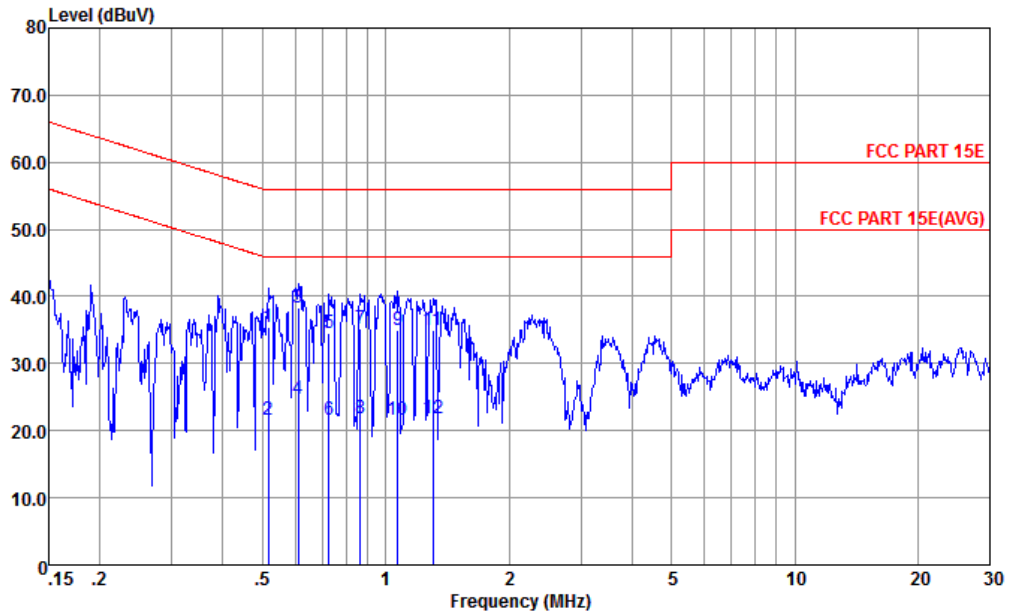

Site : CO01-KS
 Condition : FCC PART 15E LISN-N-191028-060105 NEUTRAL

	Freq	Level	Over	Limit	Read	LISN	Cable	Remark
	MHz	dBuV	Limit	Line	Level	Factor	Loss	
			dB	dBuV	dBuV	dB	dB	
1	0.516	35.44	-20.56	56.00	25.10	0.10	10.24	QP
2	0.516	21.64	-24.36	46.00	11.30	0.10	10.24	Average
3 *	0.611	38.44	-17.56	56.00	28.10	0.10	10.24	QP
4	0.611	24.84	-21.16	46.00	14.50	0.10	10.24	Average
5	0.727	34.64	-21.36	56.00	24.30	0.10	10.24	QP
6	0.727	21.64	-24.36	46.00	11.30	0.10	10.24	Average
7	0.866	35.24	-20.76	56.00	24.89	0.11	10.24	QP
8	0.866	21.94	-24.06	46.00	11.59	0.11	10.24	Average
9	1.071	34.95	-21.05	56.00	24.61	0.11	10.23	QP
10	1.071	21.65	-24.35	46.00	11.31	0.11	10.23	Average
11	1.303	34.95	-21.05	56.00	24.60	0.12	10.23	QP
12	1.303	21.95	-24.05	46.00	11.60	0.12	10.23	Average

Note:

1. Level(dBμV) = Read Level(dBμV) + LISN Factor(dB) + Cable Loss(dB)
2. Over Limit(dB) = Level(dBμV) – Limit Line(dBμV)



Appendix C. Radiated Spurious Emission

Band 1 - 5150~5250MHz WIFI 802.11a (Band Edge @ 3m)

WIFI Ant.	Note	Frequency (MHz)	Level (dBμV/m)	Over Limit (dB)	Limit Line (dBμV/m)	Read Level (dBμV)	Antenna Factor (dB/m)	Cable Loss (dB)	Preamp Factor (dB)	Ant Pos (cm)	Table Pos (deg)	Peak Avg. (P/A)	Pol. (H/V)
802.11a CH 36 5180MHz		5142.72	56.74	-17.26	74	43.49	34.07	10.43	31.25	100	117	P	H
		5148.48	46.09	-7.91	54	32.84	34.07	10.43	31.25	100	117	A	H
	*	5182	108.27	-	-	94.93	34.12	10.48	31.26	100	117	P	H
		5182	100.68	-	-	87.34	34.12	10.48	31.26	100	117	A	H
		5116.48	55.94	-18.06	74	42.78	34.03	10.38	31.25	282	198	P	V
		5125.44	45.25	-8.75	54	32.05	34.05	10.4	31.25	282	198	A	V
	*	5182	102.21	-	-	88.87	34.12	10.48	31.26	282	198	P	V
		5182	95.11	-	-	81.77	34.12	10.48	31.26	282	198	A	V
Remark	1. No other spurious found. 2. All results are PASS against Peak and Average limit line.												



Band 1 5150~5250MHz

WIFI 802.11a (Harmonic @ 3m)

WIFI Ant. 1	Note	Frequency (MHz)	Level (dBμV/m)	Over Limit (dB)	Limit Line (dBμV/m)	Read Level (dBμV)	Antenna Factor (dB/m)	Cable Loss (dB)	Preamp Factor (dB)	Ant Pos (cm)	Table Pos (deg)	Peak Avg. (P/A)	Pol. (H/V)
802.11a CH 36 5180MHz		10360	40.31	-27.99	68.3	52.79	37.02	15.27	64.77	100	360	P	H
		10360	41.42	-26.88	68.3	53.9	37.02	15.27	64.77	100	360	P	V
802.11a CH 44 5220MHz		10440	40.45	-27.85	68.3	52.84	37.06	15.32	64.77	100	360	P	H
		10440	40.68	-27.62	68.3	53.07	37.06	15.32	64.77	100	360	P	V
802.11a CH 48 5240MHz		10480	41.46	-26.84	68.3	53.78	37.09	15.36	64.77	100	360	P	H
		10480	41.62	-26.68	68.3	53.94	37.09	15.36	64.77	100	360	P	V
Remark	1. No other spurious found. 2. All results are PASS against Peak and Average limit line.												



Band 1 5150~5250MHz
WIFI 802.11n HT20 (Band Edge @ 3m)

Table with 14 columns: WIFI Ant. 1, Note, Frequency (MHz), Level (dBµV/m), Over Limit (dB), Limit Line (dBµV/m), Read Level (dBµV), Antenna Factor (dB/m), Cable Loss (dB), Preamp Factor (dB), Ant Pos (cm), Table Pos (deg), Peak Avg. (P/A), Pol. (H/V). Rows include test results for 802.11n HT20 CH 36 5180MHz and a Remark section.



Band 1 5150~5250MHz
WIFI 802.11n HT20 (Harmonic @ 3m)

Table with 14 columns: WIFI Ant. 1, Note, Frequency (MHz), Level (dBµV/m), Over Limit (dB), Limit Line (dBµV/m), Read Level (dBµV), Antenna Factor (dB/m), Cable Loss (dB), Preamp Factor (dB), Ant Pos (cm), Table Pos (deg), Peak Avg. (P/A), Pol. (H/V). Rows include data for 802.11n HT20 CH 36 (5180MHz), CH 44 (5220MHz), and CH 48 (5240MHz). A Remark section at the bottom states: 1. No other spurious found. 2. All results are PASS against Peak and Average limit line.



Band 1 5150~5250MHz
WIFI 802.11n HT40 (Band Edge @ 3m)

WIFI Ant. 1	Note	Frequency (MHz)	Level (dBμV/m)	Over Limit (dB)	Limit Line (dBμV/m)	Read Level (dBμV)	Antenna Factor (dB/m)	Cable Loss (dB)	Preamp Factor (dB)	Ant Pos (cm)	Table Pos (deg)	Peak Avg. (P/A)	Pol. (H/V)
802.11n HT40 CH 38 5190MHz		5116.16	55.74	-18.26	74	42.58	34.03	10.38	31.25	107	117	P	H
		5144.32	45.84	-8.16	54	32.59	34.07	10.43	31.25	107	117	A	H
	*	5194	101.7	-	-	88.31	34.14	10.51	31.26	107	117	P	H
		5194	94.53	-	-	81.14	34.14	10.51	31.26	107	117	A	H
		5361.48	52.95	-21.05	74	39.15	34.35	10.73	31.28	107	117	P	H
		5372.46	44.04	-9.96	54	30.24	34.35	10.73	31.28	107	117	A	H
		5111.84	55.17	-18.83	74	42.01	34.03	10.38	31.25	136	351	P	V
		5128.64	45.64	-8.36	54	32.44	34.05	10.4	31.25	136	351	A	V
	*	5182	95.11	-	-	81.77	34.12	10.48	31.26	136	351	P	V
		5182	87.82	-	-	74.48	34.12	10.48	31.26	136	351	A	V
		5350.5	52.93	-21.07	74	39.17	34.33	10.71	31.28	136	351	P	V
		5376.24	43.9	-10.1	54	30.1	34.35	10.73	31.28	136	351	A	V
Remark	1. No other spurious found. 2. All results are PASS against Peak and Average limit line.												



Band 1 5150~5250MHz
WIFI 802.11n HT40 (Harmonic @ 3m)

Table with 14 columns: WIFI Ant. 1, Note, Frequency (MHz), Level (dBµV/m), Over Limit (dB), Limit Line (dBµV/m), Read Level (dBµV), Antenna Factor (dB/m), Cable Loss (dB), Preamp Factor (dB), Ant Pos (cm), Table Pos (deg), Peak Avg. (P/A), Pol. (H/V). Rows include data for 802.11n HT40 CH 38 5190MHz and CH 46 5230MHz, and a Remark section.



Band 1 5150~5250MHz
WIFI 802.11ac VHT80 (Band Edge @ 3m)

Table with 14 columns: WIFI Ant. 1, Note, Frequency (MHz), Level (dBµV/m), Over Limit (dB), Limit Line (dBµV/m), Read Level (dBµV), Antenna Factor (dB/m), Cable Loss (dB), Preamp Factor (dB), Ant Pos (cm), Table Pos (deg), Peak Avg. (P/A), Pol. (H/V). Rows include test data for 802.11ac VHT80 CH 42 5210MHz and a Remark section.



Band 1 5150~5250MHz

WIFI 802.11ac VHT80 (Harmonic @ 3m)

WIFI Ant. 1	Note	Frequency (MHz)	Level (dBμV/m)	Over Limit (dB)	Limit Line (dBμV/m)	Read Level (dBμV)	Antenna Factor (dB/m)	Cable Loss (dB)	Preamp Factor (dB)	Ant Pos (cm)	Table Pos (deg)	Peak Avg. (P/A)	Pol. (H/V)
802.11ac VHT80		10420	40.8	-27.5	68.3	53.21	37.05	15.31	64.77	100	360	P	H
CH 42 5210MHz		10420	40.02	-28.28	68.3	52.43	37.05	15.31	64.77	100	83	P	V
Remark	1. No other spurious found. 2. All results are PASS against Peak and Average limit line.												



Band 2 - 5250~5350MHz
WIFI 802.11a (Band Edge @ 3m)

Table with 14 columns: WIFI, Note, Frequency, Level, Over, Limit, Read, Antenna, Cable, Preamp, Ant, Table, Peak, Pol. It contains 8 rows of test data for 802.11a CH 64 at 5320MHz and a Remark section at the bottom.



Band 2 5250~5350MHz

WIFI 802.11a (Harmonic @ 3m)

WIFI Ant. 1	Note	Frequency (MHz)	Level (dBμV/m)	Over Limit (dB)	Limit Line (dBμV/m)	Read Level (dBμV)	Antenna Factor (dB/m)	Cable Loss (dB)	Preamp Factor (dB)	Ant Pos (cm)	Table Pos (deg)	Peak Avg. (P/A)	Pol. (H/V)
802.11a CH 52		10520	41.45	-26.85	68.3	53.72	37.11	15.39	64.77	100	360	P	H
5260MHz		10520	40.76	-27.54	68.3	53.03	37.11	15.39	64.77	100	360	P	V
802.11a CH 60		10600	41.89	-32.11	74	54.05	37.16	15.45	64.77	100	360	P	H
5300MHz		10600	42.36	-31.64	74	54.52	37.16	15.45	64.77	100	360	P	V
802.11a CH 64		10640	41.13	-32.87	74	53.24	37.18	15.48	64.77	100	360	P	H
5320MHz		10640	41.34	-32.66	74	53.45	37.18	15.48	64.77	100	360	P	V
Remark	1. No other spurious found. 2. All results are PASS against Peak and Average limit line.												



Band 2 5250~5350MHz
WIFI 802.11n HT20 (Band Edge @ 3m)

Table with 14 columns: WIFI Ant. 1, Note, Frequency (MHz), Level (dBµV/m), Over Limit (dB), Limit Line (dBµV/m), Read Level (dBµV), Antenna Factor (dB/m), Cable Loss (dB), Preamp Factor (dB), Ant Pos (cm), Table Pos (deg), Peak Avg. (P/A), Pol. (H/V). Rows include test data for 802.11n HT20 CH 64 5320MHz and a Remark section.



Band 2 5250~5350MHz
WIFI 802.11n HT20 (Harmonic @ 3m)

WIFI Ant. 1	Note	Frequency (MHz)	Level (dBμV/m)	Over Limit (dB)	Limit Line (dBμV/m)	Read Level (dBμV)	Antenna Factor (dB/m)	Cable Loss (dB)	Preamp Factor (dB)	Ant Pos (cm)	Table Pos (deg)	Peak Avg. (P/A)	Pol. (H/V)
802.11n HT20		10520	41.33	-26.97	68.3	53.6	37.11	15.39	64.77	100	360	P	H
CH 52		10520	40.8	-27.5	68.3	53.07	37.11	15.39	64.77	100	360	P	V
5260MHz													
802.11n HT20		10600	40.96	-33.04	74	53.12	37.16	15.45	64.77	100	360	P	H
CH 60		10600	41.63	-32.37	74	53.79	37.16	15.45	64.77	100	360	P	V
5300MHz													
802.11n HT20		10640	41.74	-32.26	74	53.85	37.18	15.48	64.77	100	360	P	H
CH 64		10640	42.02	-31.98	74	54.13	37.18	15.48	64.77	100	360	P	V
5320MHz													
Remark	1. No other spurious found. 2. All results are PASS against Peak and Average limit line.												



Band 2 5250~5350MHz
WIFI 802.11n HT40 (Band Edge @ 3m)

Table with 14 columns: WIFI Ant. 1, Note, Frequency (MHz), Level (dBµV/m), Over Limit (dB), Limit Line (dBµV/m), Read Level (dBµV), Antenna Factor (dB/m), Cable Loss (dB), Preamp Factor (dB), Ant Pos (cm), Table Pos (deg), Peak Avg. (P/A), Pol. (H/V). Rows include test results for 802.11n HT40 CH 62 5310MHz and a Remark section.



Band 2 5250~5350MHz
WIFI 802.11n HT40 (Harmonic @ 3m)

Table with 14 columns: WIFI Ant. 1, Note, Frequency (MHz), Level (dBµV/m), Over Limit (dB), Limit Line (dBµV/m), Read Level (dBµV), Antenna Factor (dB/m), Cable Loss (dB), Preamp Factor (dB), Ant Pos (cm), Table Pos (deg), Peak Avg. (P/A), Pol. (H/V). Rows include data for 802.11n HT40 CH 54 at 10540MHz and CH 62 at 10620MHz.



Band 2 5250~5350MHz
WIFI 802.11ac VHT80 (Band Edge @ 3m)

Table with 14 columns: WIFI Ant. 1, Note, Frequency (MHz), Level (dBµV/m), Over Limit (dB), Limit Line (dBµV/m), Read Level (dBµV), Antenna Factor (dB/m), Cable Loss (dB), Preamp Factor (dB), Ant Pos (cm), Table Pos (deg), Peak Avg. (P/A), Pol. (H/V). Rows include frequencies like 5150.08, 5130.72, 5302, 5353.1, 5350, 5104.48, 5118.08, 5284, 5284, 5352.5, 5352.3.



Band 2 5250~5350MHz

WIFI 802.11ac VHT80 (Harmonic @ 3m)

WIFI Ant. 1	Note	Frequency (MHz)	Level (dBμV/m)	Over Limit (dB)	Limit Line (dBμV/m)	Read Level (dBμV)	Antenna Factor (dB/m)	Cable Loss (dB)	Preamp Factor (dB)	Ant Pos (cm)	Table Pos (deg)	Peak Avg. (P/A)	Pol. (H/V)
802.11ac VHT80		10580	41.22	-27.08	68.3	53.4	37.15	15.44	64.77	100	0	P	H
CH 58 5290MHz		10580	43.04	-25.26	68.3	55.22	37.15	15.44	64.77	100	0	P	V
Remark	1. No other spurious found. 2. All results are PASS against Peak and Average limit line.												



Band 3 - 5470~5725MHz
WIFI 802.11a (Band Edge @ 3m)

WIFI	Note	Frequency	Level	Over	Limit	Read	Antenna	Cable	Preamp	Ant	Table	Peak	Pol.
Ant.				Limit	Line	Level	Factor	Loss	Factor	Pos	Pos	Avg.	
1		(MHz)	(dBμV/m)	(dB)	(dBμV/m)	(dBμV)	(dB/m)	(dB)	(dB)	(cm)	(deg)	(P/A)	(H/V)
802.11a CH 100 5500MHz		5443.44	54.7	-19.3	74	40.78	34.44	10.77	31.29	100	116	P	H
		5469.36	54.95	-13.35	68.3	40.99	34.48	10.77	31.29	100	116	P	H
		5457.36	45.26	-8.74	54	31.32	34.46	10.77	31.29	100	116	A	H
	*	5500	107.91	-	-	93.9	34.53	10.77	31.29	100	116	P	H
		5500	100.53	-	-	86.52	34.53	10.77	31.29	100	116	A	H
		5382.16	53.42	-20.58	74	39.57	34.38	10.75	31.28	212	200	P	V
		5467.28	52.76	-15.54	68.3	38.8	34.48	10.77	31.29	212	200	P	V
		5454	44.09	-9.91	54	30.15	34.46	10.77	31.29	212	200	A	V
	*	5494	100.97	-	-	86.98	34.51	10.77	31.29	212	200	P	V
		5494	93.34	-	-	79.35	34.51	10.77	31.29	212	200	A	V
802.11a CH 140 5700MHz		5729.88	58.6	-9.7	68.3	44.94	34.78	10.8	31.92	100	109	P	H
	*	5704	110.07	-	-	96.28	34.76	10.8	31.77	100	109	P	H
		5704	103.06	-	-	89.27	34.76	10.8	31.77	100	109	A	H
		5751	55.03	-13.27	68.3	41.5	34.79	10.81	32.07	317	210	P	V
	*	5704	104.13	-	-	90.34	34.76	10.8	31.77	317	210	P	V
	5704	97.18	-	-	83.39	34.76	10.8	31.77	317	210	A	V	
Remark	1. No other spurious found. 2. All results are PASS against Peak and Average limit line.												



Band 3 - 5470~5725MHz
WIFI 802.11a (Harmonic @ 3m)

Table with 14 columns: WIFI Ant. 1, Note, Frequency (MHz), Level (dBµV/m), Over Limit (dB), Limit Line (dBµV/m), Read Level (dBµV), Antenna Factor (dB/m), Cable Loss (dB), Preamp Factor (dB), Ant Pos (cm), Table Pos (deg), Peak Avg. (P/A), Pol. (H/V). Rows include data for channels 100, 116, and 140 at various frequencies.

Remark
1. No other spurious found.
2. All results are PASS against Peak and Average limit line.



Band 3 - 5470~5725MHz
WIFI 802.11n HT20 (Band Edge @ 3m)

WIFI Ant. 1	Note	Frequency (MHz)	Level (dBμV/m)	Over Limit (dB)	Limit Line (dBμV/m)	Read Level (dBμV)	Antenna Factor (dB/m)	Cable Loss (dB)	Preamp Factor (dB)	Ant Pos (cm)	Table Pos (deg)	Peak Avg. (P/A)	Pol. (H/V)
802.11n HT20 CH 100 5500MHz		5375.92	54.1	-19.9	74	40.3	34.35	10.73	31.28	100	116	P	H
		5466.32	55.72	-12.58	68.3	41.76	34.48	10.77	31.29	100	116	P	H
		5456.72	45.6	-8.4	54	31.66	34.46	10.77	31.29	100	116	A	H
	*	5500	108.93	-	-	94.92	34.53	10.77	31.29	100	116	P	H
		5500	101.23	-	-	87.22	34.53	10.77	31.29	100	116	A	H
		5412.72	54.23	-19.77	74	40.32	34.42	10.77	31.28	297	185	P	V
		5468.72	52.19	-16.11	68.3	38.23	34.48	10.77	31.29	297	185	P	V
		5458.64	44.23	-9.77	54	30.29	34.46	10.77	31.29	297	185	A	V
	*	5500	100.68	-	-	86.67	34.53	10.77	31.29	297	185	P	V
	5500	93.85	-	-	79.84	34.53	10.77	31.29	297	185	A	V	
802.11n HT20 CH 140 5700MHz		5730.2	61.23	-7.07	68.3	47.57	34.78	10.8	31.92	100	115	P	H
	*	5704	111.83	-	-	98.04	34.76	10.8	31.77	100	115	P	H
		5704	104.04	-	-	90.25	34.76	10.8	31.77	100	115	A	H
		5743.24	55.35	-12.95	68.3	41.82	34.79	10.81	32.07	102	323	P	V
	*	5704	104.52	-	-	90.73	34.76	10.8	31.77	102	323	P	V
	5704	96.51	-	-	82.72	34.76	10.8	31.77	102	323	A	V	
Remark	1. No other spurious found. 2. All results are PASS against Peak and Average limit line.												



Band 3 - 5470~5725MHz
WIFI 802.11n HT20 (Harmonic @ 3m)

Table with 14 columns: WIFI Ant. 1, Note, Frequency (MHz), Level (dBµV/m), Over Limit (dB), Limit Line (dBµV/m), Read Level (dBµV), Antenna Factor (dB/m), Cable Loss (dB), Preamp Factor (dB), Ant Pos (cm), Table Pos (deg), Peak Avg. (P/A), Pol. (H/V). Rows include data for channels 100, 116, and 140 at 5500MHz, 5580MHz, and 5700MHz respectively. A Remark section at the bottom states: 1. No other spurious found. 2. All results are PASS against Peak and Average limit line.



Band 3 - 5470~5725MHz
WIFI 802.11n HT40 (Band Edge @ 3m)

WIFI Ant. 1	Note	Frequency (MHz)	Level (dBμV/m)	Over Limit (dB)	Limit Line (dBμV/m)	Read Level (dBμV)	Antenna Factor (dB/m)	Cable Loss (dB)	Preamp Factor (dB)	Ant Pos (cm)	Table Pos (deg)	Peak Avg. (P/A)	Pol. (H/V)
802.11n HT40 CH 102 5510MHz		5408.88	54.13	-19.87	74	40.24	34.4	10.77	31.28	104	115	P	H
		5470	54.17	-14.13	68.3	40.21	34.48	10.77	31.29	104	115	P	H
		5459.92	45.29	-8.71	54	31.35	34.46	10.77	31.29	104	115	A	H
	*	5512	102.11	-	-	88.1	34.53	10.77	31.29	104	115	P	H
		5512	95.19	-	-	81.18	34.53	10.77	31.29	104	115	A	H
		5732.28	57.08	-11.22	68.3	43.42	34.78	10.8	31.92	104	115	P	H
		5427.92	54.01	-19.99	74	40.11	34.42	10.77	31.29	109	327	P	V
		5467.6	52.45	-15.85	68.3	38.49	34.48	10.77	31.29	109	327	P	V
		5458	44.52	-9.48	54	30.58	34.46	10.77	31.29	109	327	A	V
	*	5506	94.5	-	-	80.49	34.53	10.77	31.29	109	327	P	V
		5506	87.18	-	-	73.17	34.53	10.77	31.29	109	327	A	V
		5754.92	54.42	-13.88	68.3	40.87	34.81	10.81	32.07	109	327	P	V
802.11n HT40 CH 134 5670MHz		5368.88	54.84	-19.16	74	41.04	34.35	10.73	31.28	111	115	P	H
		5461.68	51.86	-16.44	68.3	37.92	34.46	10.77	31.29	111	115	P	H
		5446.64	45.49	-8.51	54	31.55	34.46	10.77	31.29	111	115	A	H
	*	5674	105.47	-	-	91.41	34.73	10.79	31.46	111	115	P	H
		5674	97.74	-	-	83.68	34.73	10.79	31.46	111	115	A	H
		5725.88	56.44	-11.86	68.3	42.78	34.78	10.8	31.92	111	115	P	H
		5356.4	53.37	-20.63	74	39.61	34.33	10.71	31.28	123	0	P	V
		5466	52.53	-15.77	68.3	38.57	34.48	10.77	31.29	123	0	P	V
		5444.4	44.12	-9.88	54	30.2	34.44	10.77	31.29	123	0	A	V
	*	5674	97.06	-	-	83	34.73	10.79	31.46	123	0	P	V
	5674	89.9	-	-	75.84	34.73	10.79	31.46	123	0	A	V	
	5747.72	53.97	-14.33	68.3	40.44	34.79	10.81	32.07	123	0	P	V	
Remark	1. No other spurious found. 2. All results are PASS against Peak and Average limit line.												



Band 3 - 5470~5725MHz
WIFI 802.11n HT40 (Harmonic @ 3m)

Table with 14 columns: WIFI Ant. 1, Note, Frequency (MHz), Level (dBµV/m), Over Limit (dB), Limit Line (dBµV/m), Read Level (dBµV), Antenna Factor (dB/m), Cable Loss (dB), Preamp Factor (dB), Ant Pos (cm), Table Pos (deg), Peak Avg. (P/A), Pol. (H/V). Rows include data for channels 102, 110, and 134 at various frequencies.



Band 3 - 5470~5725MHz
WIFI 802.11ac VHT80 (Band Edge @ 3m)

WIFI Ant. 1	Note	Frequency (MHz)	Level (dBμV/m)	Over Limit (dB)	Limit Line (dBμV/m)	Read Level (dBμV)	Antenna Factor (dB/m)	Cable Loss (dB)	Preamp Factor (dB)	Ant Pos (cm)	Table Pos (deg)	Peak Avg. (P/A)	Pol. (H/V)
802.11ac VHT80 CH 106 5530MHz		5455.28	58.09	-15.91	74	44.15	34.46	10.77	31.29	307	66	P	H
		5465.68	58.79	-9.51	68.3	44.83	34.48	10.77	31.29	307	66	P	H
		5454.96	46.71	-7.29	54	32.77	34.46	10.77	31.29	307	66	A	H
	*	5536	98.49	-	-	84.45	34.57	10.77	31.3	307	66	P	H
		5536	90.92	-	-	76.88	34.57	10.77	31.3	307	66	A	H
		5736.04	54.9	-13.4	68.3	41.37	34.79	10.81	32.07	307	66	P	H
		5457.04	59.93	-14.07	74	45.99	34.46	10.77	31.29	293	16	P	V
		5470	62.33	-5.97	68.3	48.37	34.48	10.77	31.29	293	16	P	V
		5454.96	46.27	-7.73	54	32.33	34.46	10.77	31.29	293	16	A	V
	*	5536	96.24	-	-	82.2	34.57	10.77	31.3	293	16	P	V
		5536	89.44	-	-	75.4	34.57	10.77	31.3	293	16	A	V
		5743.56	54.75	-13.55	68.3	41.22	34.79	10.81	32.07	293	16	P	V
802.11ac VHT80 CH 122 5610MHz		5401.2	53.93	-20.07	74	40.04	34.4	10.77	31.28	102	52	P	H
		5462.96	52.63	-15.67	68.3	38.67	34.48	10.77	31.29	102	52	P	H
		5442.96	45.14	-8.86	54	31.22	34.44	10.77	31.29	102	52	A	H
	*	5620	98.41	-	-	84.27	34.68	10.77	31.31	102	52	P	H
		5620	91.33	-	-	77.19	34.68	10.77	31.31	102	52	A	H
		5747.8	55.3	-13	68.3	41.77	34.79	10.81	32.07	102	52	P	H
		5356.88	54.12	-19.88	74	40.36	34.33	10.71	31.28	393	18	P	V
		5468.08	52.39	-15.91	68.3	38.43	34.48	10.77	31.29	393	18	P	V
		5457.2	44.99	-9.01	54	31.05	34.46	10.77	31.29	393	18	A	V
	*	5614	97.66	-	-	83.54	34.66	10.77	31.31	393	18	P	V
	5614	90.32	-	-	76.2	34.66	10.77	31.31	393	18	A	V	
	5750.28	55.01	-13.29	68.3	41.48	34.79	10.81	32.07	393	18	P	V	
Remark	1. No other spurious found. 2. All results are PASS against Peak and Average limit line.												



Band 3 5470~5725MHz

WIFI 802.11ac VHT80 (Harmonic @ 3m)

WIFI Ant. 1	Note	Frequency (MHz)	Level (dBμV/m)	Over Limit (dB)	Limit Line (dBμV/m)	Read Level (dBμV)	Antenna Factor (dB/m)	Cable Loss (dB)	Preamp Factor (dB)	Ant Pos (cm)	Table Pos (deg)	Peak Avg. (P/A)	Pol. (H/V)
802.11ac VHT80		11060	40.74	-33.26	74	52.26	37.44	15.81	64.77	100	360	P	H
CH 106 5530MHz		11060	40.27	-33.73	74	51.79	37.44	15.81	64.77	100	0	P	V
802.11ac VHT80		11220	40.66	-33.34	74	51.98	37.53	15.92	64.77	100	0	P	H
CH 122 5610MHz		11220	40.62	-33.38	74	51.94	37.53	15.92	64.77	100	360	P	V
Remark	1. No other spurious found. 2. All results are PASS against Peak and Average limit line.												



Emission below 1GHz

WIFI 802.11ac VHT80 (LF @ 3m)

WIFI	Note	Frequency	Level	Over	Limit	Read	Antenna	Cable	Preamp	Ant	Table	Peak	Pol.
Ant.				Limit	Line	Level	Factor	Loss	Factor	Pos	Pos	Avg.	
1		(MHz)	(dBμV/m)	(dB)	(dBμV/m)	(dBμV)	(dB/m)	(dB)	(dB)	(cm)	(deg)	(P/A)	(H/V)
802.11ac VHT80 LF		30	21.89	-18.11	40	28.66	25.7	0.63	33.1	100	0	P	H
		101.78	21.61	-21.89	43.5	35.8	17.79	1.12	33.1	-	-	P	H
		273.47	25.05	-20.95	46	36.15	19.83	1.82	32.75	-	-	P	H
		425.76	21.16	-24.84	46	28.02	23.12	2.27	32.25	-	-	P	H
		705.12	26.11	-19.89	46	29.91	25.78	2.93	32.51	-	-	P	H
		973.81	28.15	-25.85	54	28.76	27.99	3.45	32.05	-	-	P	H
		30	30.79	-9.21	40	39.06	24.2	0.63	33.1	100	0	P	V
		59.1	28.91	-11.09	40	48.59	12.57	0.87	33.12	-	-	P	V
		103.72	22.63	-20.87	43.5	37.66	16.93	1.13	33.09	-	-	P	V
		174.53	19.78	-23.72	43.5	35.87	15.4	1.46	32.95	-	-	P	V
		271.53	22.37	-23.63	46	33.91	19.41	1.81	32.76	-	-	P	V
		705.12	24.83	-21.17	46	29.45	24.96	2.93	32.51	-	-	P	V
Remark	1. No other spurious found. 2. All results are PASS against limit line.												



Note symbol

*	Fundamental Frequency which can be ignored. However, the level of any unwanted emissions shall not exceed the level of the fundamental frequency.
!	Test result is over limit line.
P/A	Peak or Average
H/V	Horizontal or Vertical



A calculation example for radiated spurious emission is shown as below:

WIFI	Note	Frequency	Level	Over	Limit	Read	Antenna	Cable	Preamp	Ant	Table	Peak	Pol.
Ant.				Limit	Line	Level	Factor	Loss	Factor	Pos	Pos	Avg.	
1		(MHz)	(dBμV/m)	(dB)	(dBμV/m)	(dBμV)	(dB/m)	(dB)	(dB)	(cm)	(deg)	(P/A)	(H/V)
802.11b		2390	55.45	-18.55	74	54.51	32.22	4.58	35.86	103	308	P	H
CH 01													
2412MHz		2390	43.54	-10.46	54	42.6	32.22	4.58	35.86	103	308	A	H

- Level(dBμV/m) =
Antenna Factor(dB/m) + Cable Loss(dB) + Read Level(dBμV) - Preamp Factor(dB)
- Over Limit(dB) = Level(dBμV/m) – Limit Line(dBμV/m)

For Peak Limit @ 2390MHz:

- Level(dBμV/m)
= Antenna Factor(dB/m) + Cable Loss(dB) + Read Level(dBμV) - Preamp Factor(dB)
= 32.22(dB/m) + 4.58(dB) + 54.51(dBμV) – 35.86 (dB)
= 55.45 (dBμV/m)
- Over Limit(dB)
= Level(dBμV/m) – Limit Line(dBμV/m)
= 55.45(dBμV/m) – 74(dBμV/m)
= -18.55(dB)

For Average Limit @ 2390MHz:

- Level(dBμV/m)
= Antenna Factor(dB/m) + Cable Loss(dB) + Read Level(dBμV) - Preamp Factor(dB)
= 32.22(dB/m) + 4.58(dB) + 42.6(dBμV) – 35.86 (dB)
= 43.54 (dBμV/m)
- Over Limit(dB)
= Level(dBμV/m) – Limit Line(dBμV/m)
= 43.54(dBμV/m) – 54(dBμV/m)
= -10.46(dB)

Both peak and average measured complies with the limit line, so test result is “PASS”.



Appendix D. Duty Cycle Plots

Band	Duty Cycle(%)	T(ms)	1/T(kHz)	VBW Setting
802.11a	97.46	1.391	0.719	0.75kHz
802.11n HT20	97.30	1.304	0.767	0.82kHz
802.11n HT40	94.68	0.645	1.551	1.6kHz
802.11ac VHT80	89.92	0.323	3.094	3.3kHz

802.11a

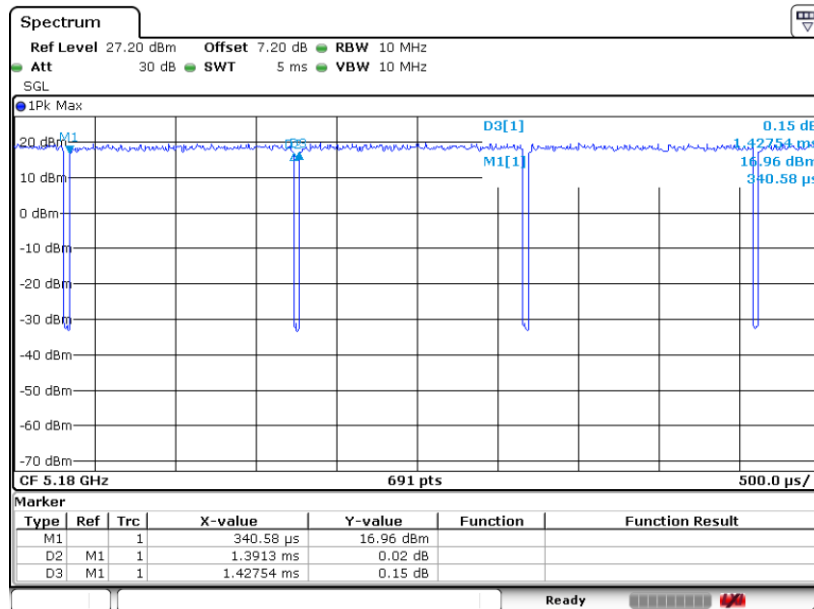



802.11n HT20

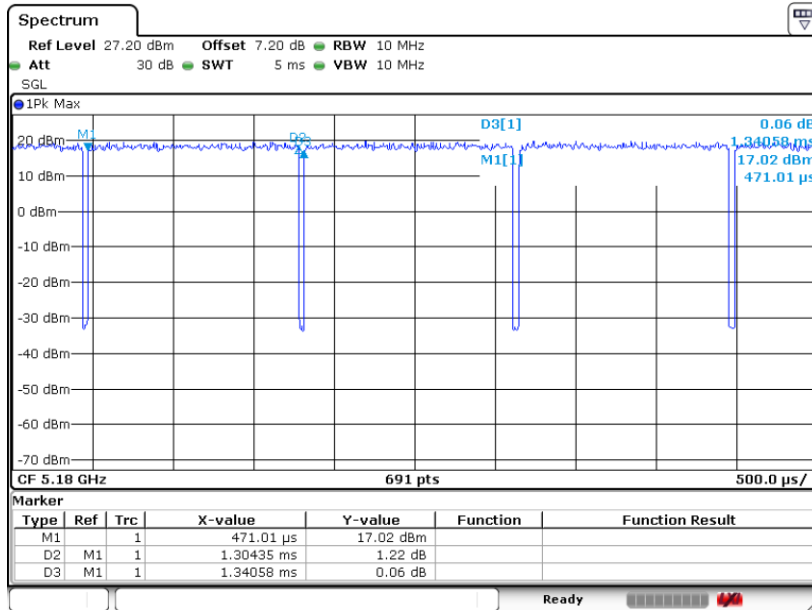

802.11n HT40

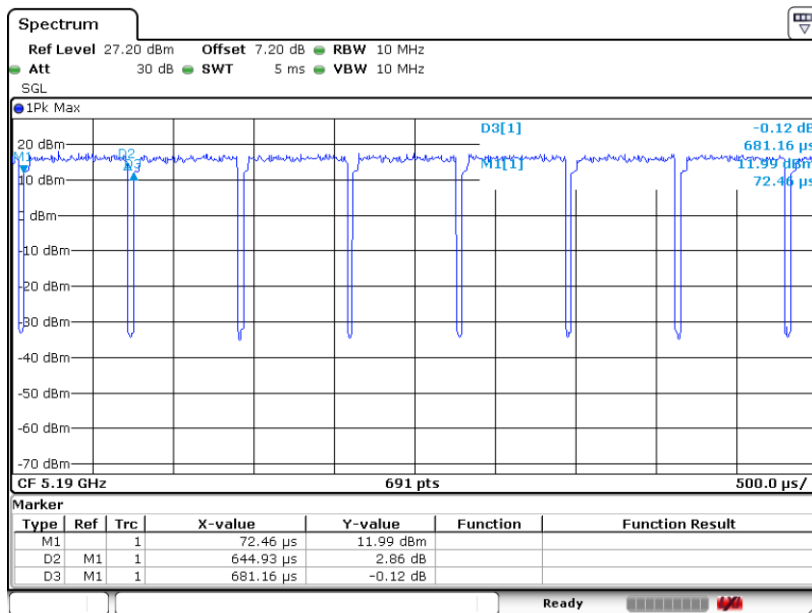



802.11ac VHT80

