



FCC RADIO TEST REPORT

FCC ID : IHDT56YJ2
Equipment : Mobile Cellular Phone
Brand Name : Motorola
Model Name : XT2061-3
Applicant : Motorola Mobility, LLC
222 W Merchandise Mart Plaza, Suite
1800, Chicago, IL 60654, United States
Manufacturer : Motorola Mobility, LLC
222 W Merchandise Mart Plaza, Suite
1800, Chicago, IL 60654, United States
Standard : FCC Part 15 Subpart E §15.407

The product was received on Dec. 06, 2019 and testing was started from Feb. 13, 2020 and completed on Feb. 27, 2020. We, SPORTON INTERNATIONAL INC., EMC & Wireless Communications Laboratory, would like to declare that the tested sample has been evaluated in accordance with the test procedures and has been in compliance with the applicable technical standards.

The report must not be used by the client to claim product certification, approval, or endorsement by TAF or any agency of government.

The test results in this variant report apply exclusively to the tested model / sample. Without written approval of SPORTON INTERNATIONAL INC. EMC & Wireless Communications Laboratory, the test report shall not be reproduced except in full.

Louis Wu

Approved by: Louis Wu

SPORTON INTERNATIONAL INC. EMC & Wireless Communications Laboratory

No. 52, Huaya 1st Rd., Guishan Dist., Taoyuan City, Taiwan (R.O.C.)



Table of Contents

History of this test report.....3

Summary of Test Result.....4

1 General Description5

 1.1 Product Feature of Equipment Under Test.....5

 1.2 Product Specification of Equipment Under Test.....6

 1.3 Modification of EUT7

 1.4 Testing Location8

 1.5 Applicable Standards.....8

2 Test Configuration of Equipment Under Test9

 2.1 Carrier Frequency and Channel9

 2.2 Test Mode.....10

 2.3 Connection Diagram of Test System.....11

 2.4 Support Unit used in test configuration11

 2.5 EUT Operation Test Setup11

3 Test Result12

 3.1 Maximum Conducted Output Power Measurement12

 3.2 Unwanted Emissions Measurement.....13

 3.3 Antenna Requirements.....18

4 List of Measuring Equipment.....20

5 Uncertainty of Evaluation.....22

Appendix A. Conducted Test Results

Appendix B. Radiated Spurious Emission

Appendix C. Radiated Spurious Emission Plots

Appendix D. Duty Cycle Plots



Summary of Test Result

Report Clause	Ref Std. Clause	Test Items	Result (PASS/FAIL)	Remark
-	15.403 (i)	6dB & 26dB Bandwidth	Not Required	-
-	2.1049	99% Occupied Bandwidth	Not Required	-
3.1	15.407 (a)	Maximum Conducted Output Power	Pass	-
-	15.407 (a)	Power Spectral Density	Not Required	-
3.2	15.407(b)	Unwanted Emissions	Pass	Under limit 3.26 dB at 5648.800 MHz
-	15.207	AC Conducted Emission	Not Required	-
-	15.407 (c)	Automatically Discontinue Transmission	Not Required	-
3.3	15.203 & 15.407 (a)	Antenna Requirement	Pass	-

Remark:

1. Not required means after assessing, test items are not necessary to carry out.
2. This is a variant report which can be referred Product Equality Declaration. All the test cases were performed on original report which can be referred to Sporton Report Number FR9D0635F. Based on the original report, only worst case was verified.

Declaration of Conformity:
The test results with all measurement uncertainty excluded are presented in accordance with the regulation limits or requirements declared by manufacturers.
Comments and Explanations:
The declared of product specification for EUT presented in the report are provided by the manufacturer, and the manufacturer takes all the responsibilities for the accuracy of product specification.

Reviewed by: Wui Chang

Report Producer: Fiona Wu



1 General Description

1.1 Product Feature of Equipment Under Test

Product Feature	
Equipment	Mobile Cellular Phone
Brand Name	Motorola
Model Name	XT2061-3
FCC ID	IHDT56YJ2
IMEI Code	Conducted : IMEI: 359124100005862 Radiation : IMEI: 359124100005433
EUT supports Radios application	CDMA/EV-DO/GSM/EGPRS/WCDMA/HSPA/LTE/5G NR/ GNSS/NFC/WPC WLAN 11b/g/n HT20 WLAN 11a/n HT20/HT40 WLAN 11ac VHT20/VHT40/VHT80 WLAN 11ax HE20/HE40/HE80 Bluetooth BR/EDR/LE
HW Version	DVT2
EUT Stage	Identical Prototype

Remark: The above EUT's information was declared by manufacturer.

Accessory List	
AC Adapter 1	Brand Name : Motorola
	Model Name : SC-51 (SA18C30116)
	Manufacturer : Chenyang
AC Adapter 2	Brand Name : Motorola
	Model Name : SC-51 (SA18C62985)
	Manufacturer : Acbel
Battery	Brand Name : ATL
	Model Name : LW50
USB Cable 1	Brand Name : Motorola
	Model Name : SC18C24367
	Manufacturer : Saibao
USB Cable 2	Brand Name : Motorola
	Model Name : SC18C24368
	Manufacturer : Luxshare



1.2 Product Specification of Equipment Under Test

Standards-related Product Specification	
Tx/Rx Frequency Range	5745 MHz ~ 5825 MHz
Maximum Output Power to Antenna <CDD Modes>	<p><5745 MHz ~ 5825 MHz></p> <p><Ant. 1> 802.11a : 16.80 dBm / 0.0479 W 802.11n HT20 : 16.90 dBm / 0.0490 W 802.11n HT40 : 16.60 dBm / 0.0457 W 802.11ac VHT20: 17.10 dBm / 0.0513 W 802.11ac VHT40: 16.90 dBm / 0.0490 W 802.11ac VHT80: 16.70 dBm / 0.0468 W 802.11ax HE20 : 17.00 dBm / 0.0501 W 802.11ax HE40 : 17.10 dBm / 0.0513 W 802.11ax HE80 : 16.60 dBm / 0.0457 W</p> <p><Ant. 2> 802.11a : 16.90 dBm / 0.0490 W 802.11n HT20 : 16.90 dBm / 0.0490 W 802.11n HT40 : 16.60 dBm / 0.0457 W 802.11ac VHT20: 17.20 dBm / 0.0525 W 802.11ac VHT40: 16.90 dBm / 0.0490 W 802.11ac VHT80: 16.70 dBm / 0.0468 W 802.11ax HE20 : 17.00 dBm / 0.0501 W 802.11ax HE40 : 17.10 dBm / 0.0513 W 802.11ax HE80 : 16.60 dBm / 0.0457 W</p> <p>MIMO <Ant. 1 + 2> 802.11a : 20.01 dBm / 0.1002 W 802.11n HT20 : 19.98 dBm / 0.0995 W 802.11n HT40 : 19.86 dBm / 0.0968 W 802.11ac VHT20: 20.24 dBm / 0.1057 W 802.11ac VHT40: 20.01 dBm / 0.1002 W 802.11ac VHT80: 19.76 dBm / 0.0946 W 802.11ax HE20 : 20.03 dBm / 0.1007 W 802.11ax HE40 : 20.27 dBm / 0.1064 W 802.11ax HE80 : 20.01 dBm / 0.1002 W</p>
Maximum Output Power to Antenna <TXBF Modes>	<p>MIMO <Ant. 1 + 2> 802.11ac VHT20: 18.26 dBm / 0.0670 W 802.11ac VHT40: 18.42 dBm / 0.0695 W 802.11ac VHT80: 18.41 dBm / 0.0693 W 802.11ax HE20 : 18.37 dBm / 0.0687 W 802.11ax HE40 : 18.11 dBm / 0.0647 W 802.11ax HE80 : 17.96 dBm / 0.0625 W</p>

Standards-related Product Specification			
Type of Modulation	802.11a/n : OFDM (BPSK / QPSK / 16QAM / 64QAM) 802.11ac : OFDM (BPSK / QPSK / 16QAM / 64QAM / 256QAM) 802.11ax: OFDM (BPSK / QPSK / 16QAM / 64QAM / 256QAM / 1024QAM)		
Antenna Gain / Gain	<Ant. 1> : ILA Antenna with gain 1.50 dBi <Ant. 2> : ILA Antenna with gain 1.30 dBi		
Antenna Function Description		Ant. 1	Ant. 2
	802.11 a/n/ac/ax	V	V
	802.11 a/n/ac/ax MIMO	V	V
	802.11 ac/ax TXBF	V	V

Note: MIMO Ant. 1+2 is a calculated result from sum of the power MIMO Ant. 1 and MIMO Ant. 2.

1.3 Modification of EUT

No modifications are made to the EUT during all test items.



1.4 Testing Location

Test Site	SPORTON INTERNATIONAL INC. EMC & Wireless Communications Laboratory
Test Site Location	No.52, Huaya 1st Rd., Guishan Dist., Taoyuan City, Taiwan (R.O.C.) TEL: +886-3-327-3456 FAX: +886-3-328-4978
Test Site No.	Sporton Site No.
	TH05-HY

Note: The test site complies with ANSI C63.4 2014 requirement.

Test Site	SPORTON INTERNATIONAL INC. EMC & Wireless Communications Laboratory
Test Site Location	No.58, Aly. 75, Ln. 564, Wenhua 3rd, Rd., Guishan Dist., Taoyuan City, Taiwan (R.O.C.) TEL: +886-3-327-0868 FAX: +886-3-327-0855
Test Site No.	Sporton Site No.
	03CH13-HY

Note: The test site complies with ANSI C63.4 2014 requirement.

FCC designation No.: TW1190 and TW0007

1.5 Applicable Standards

According to the specifications of the manufacturer, the EUT must comply with the requirements of the following standards:

- ♦ FCC Part 15 Subpart E
- ♦ FCC KDB 789033 D02 General UNII Test Procedures New Rules v02r01.
- ♦ FCC KDB 414788 D01 Radiated Test Site v01r01.
- ♦ FCC KDB 662911 D01 Multiple Transmitter Output v02r01.
- ♦ ANSI C63.10-2013

Remark:

1. All test items were verified and recorded according to the standards and without any deviation during the test.
2. This EUT has also been tested and complied with the requirements of FCC Part 15, Subpart B, recorded in a separate test report.



2 Test Configuration of Equipment Under Test

- a. The EUT has been associated with peripherals and configuration operated in a manner tended to maximize its emission characteristics in a typical application. Frequency range investigated: radiation emission (9 kHz to the 10th harmonic of the highest fundamental frequency or to 40 GHz, whichever is lower). For radiated measurement, pre-scanned in three orthogonal panels, X, Y, Z. The worst cases (X plane) were recorded in this report.

2.1 Carrier Frequency and Channel

Frequency Band	Channel	Freq. (MHz)	Channel	Freq. (MHz)
5725-5850 MHz Band 4 (U-NII-3)	149	5745	157	5785
	151*	5755	159*	5795
	153	5765	161	5805
	155 [#]	5775	165	5825

Note:

- 1. The above Frequency and Channel in "*" were 802.11n HT40 and 802.11ac VHT40.
- 2. The above Frequency and Channel in "[#]" were 802.11ac VHT80.



2.2 Test Mode

Final test modes are considering the modulation and worse data rates as below table.

Modulation	Data Rate
802.11a	6 Mbps
802.11n HT20	MCS0
802.11n HT40	MCS0
802.11ac VHT20	MCS0
802.11ac VHT40	MCS0
802.11ac VHT80	MCS0
802.11ax HE20	MCS0
802.11ax HE40	MCS0
802.11ax HE80	MCS0

TXBF Mode

Modulation	Data Rate
802.11ac VHT20	MCS0
802.11ac VHT40	MCS0
802.11ac VHT80	MCS0
802.11ax HE20	MCS0
802.11ax HE40	MCS0
802.11ax HE80	MCS0

Ch. #		Band IV : 5725-5850 MHz	
		802.11ac VHT80	802.11ax HE80
L	Low	-	-
M	Middle	155	155
H	High	-	-

Remark:

1. For radiation spurious emission, the final modulation and the worst data rate was reference the max RF conducted power.
2. For Radiated Test Cases, the tests were performed with Adapter 1 and USB Cable 1.

2.3 Connection Diagram of Test System

<WLAN Tx Mode>

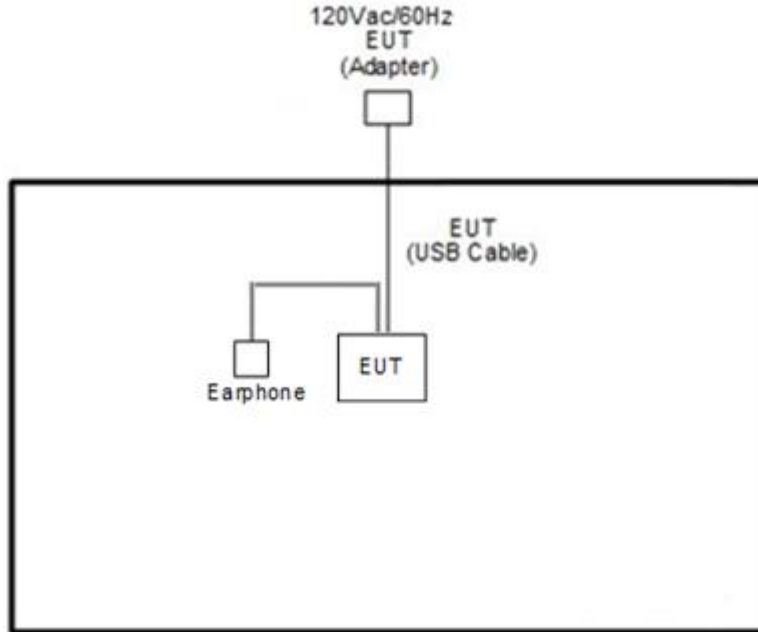

2.4 Support Unit used in test configuration

Item	Equipment	Trade Name	Model Name	FCC ID	Data Cable	Power Cord
1.	Earphone	Moto	NASH38C16618	N/A	Unshielded, 1.0 m	N/A

2.5 EUT Operation Test Setup

The RF test items, utility "QRCT v4.0.00142.0" was installed in Notebook which was programmed in order to make the EUT get into the engineering modes to provide channel selection, power level, data rate and the application type and for continuous transmitting signals.

For TXBF mode, the modulation modes and data rates manipulated by the command lines in the engineering program made the EUT link to another EUT by power under the normal operation. The "QRCT V4.0.00142.0" software tool was used to enable the EUT to transmit signals continuously.

3 Test Result

3.1 Maximum Conducted Output Power Measurement

3.1.1 Limit of Maximum Conducted Output Power

For the band 5.725–5.85 GHz, the maximum conducted output power over the frequency band of operation shall not exceed 1 W.

If transmitting antennas of directional gain greater than 6 dBi are used, the peak output power shall be reduced by the amount in dB that the directional gain of the antenna exceeds 6 dBi.

3.1.2 Measuring Instruments

See list of measuring equipment of this test report.

3.1.3 Test Procedures

The testing follows Method PM-G of FCC KDB 789033 D02 General UNII Test Procedures New Rules v02r01 for TXBF modes.

Method PM-G (Measurement using a gated RF average power meter):

1. Measurement is performed using a wideband RF power meter.
2. The EUT is configured to transmit at its maximum power control level.
3. Measure the average power of the transmitter
4. Since the measurement is made only during the ON time of the transmitter, no duty cycle correction factor is required.

3.1.4 Test Setup

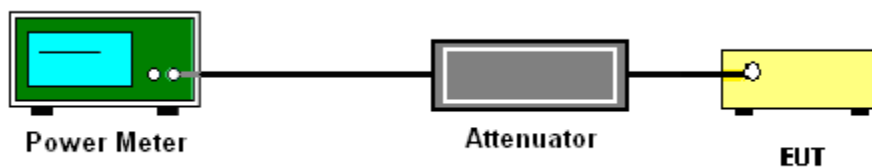

3.1.5 Test Result of Maximum Conducted Output Power

Please refer to Appendix A.



3.2 Unwanted Emissions Measurement

This section is to measure unwanted emissions through radiated measurement for band edge spurious emissions and out of band emissions measurement.

3.2.1 Limit of Unwanted Emissions

- (1) For transmitters operating in the 5.725-5.85 GHz band:
 15.407(b)(4)(i) All emissions shall be limited to a level of -27 dBm/MHz at 75 MHz or more above or below the band edge increasing linearly to 10 dBm/MHz at 25 MHz above or below the band edge, and from 25 MHz above or below the band edge increasing linearly to a level of 15.6 dBm/MHz at 5 MHz above or below the band edge, and from 5 MHz above or below the band edge increasing linearly to a level of 27 dBm/MHz at the band edge.
- (2) Unwanted spurious emissions fallen in restricted bands shall comply with the general field strength limits as below table,

Frequency (MHz)	Field Strength (microvolts/meter)	Measurement Distance (meters)
0.009 – 0.490	2400/F(kHz)	300
0.490 – 1.705	24000/F(kHz)	30
1.705 – 30.0	30	30
30 – 88	100	3
88 – 216	150	3
216 - 960	200	3
Above 960	500	3

Note: The following formula is used to convert the EIRP to field strength.

$$E = \frac{1000000\sqrt{30P}}{3} \text{ } \mu\text{V/m, where P is the eirp (Watts)}$$



EIRP (dBm)	Field Strength at 3m (dBμV/m)
- 27	68.3

(3) KDB789033 D02 v02r01 G)2)c)

- (i) Sections 15.407(b)(1-3) specifies the unwanted emissions limit for the U-NII-1 and U-NII-2 bands. As specified, emissions above 1000 MHz that are outside of the restricted bands are subject to a peak emission limit of -27 dBm/MHz.
- (ii) Section 15.407(b)(4) specifies the unwanted emissions limit for the U-NII-3 band. A band emissions mask is specified in Section 15.407(b)(4)(i). The emission limits are based on the use of a peak detector.

3.2.2 Measuring Instruments

See list of measuring equipment of this test report.

3.2.3 Test Procedures

1. The testing follows FCC KDB 789033 D02 General UNII Test Procedures New Rules v02r01. Section G) Unwanted emissions measurement.

(1) Procedure for Unwanted Emissions Measurements Below 1000MHz

- RBW = 120 kHz
- VBW = 300 kHz
- Detector = Peak
- Trace mode = max hold

(2) Procedure for Peak Unwanted Emissions Measurements Above 1000 MHz

- RBW = 1 MHz
- VBW ≥ 3 MHz
- Detector = Peak
- Sweep time = auto
- Trace mode = max hold

(3) Procedures for Average Unwanted Emissions Measurements Above 1000MHz

- RBW = 1 MHz
- VBW = 10 Hz, when duty cycle is no less than 98 percent.
- VBW ≥ 1/T, when duty cycle is less than 98 percent where T is the minimum transmission duration over which the transmitter is on and is transmitting at its maximum power control level for the tested mode of operation.



2. The EUT was placed on a turntable with 0.8 meter for frequency below 1GHz and 1.5 meter for frequency above 1GHz respectively above ground.
3. The EUT was set 3 meters from the interference receiving antenna which was mounted on the top of a variable height antenna tower.
4. The antenna is a broadband antenna and its height is adjusted between one meter and four meters above ground to find the maximum value of the field strength for both horizontal polarization and vertical polarization of the antenna.
5. For each suspected emission, the EUT was arranged to its worst case and then adjust the antenna tower (from 1 m to 4 m) and turntable (from 0 degree to 360 degrees) to find the maximum reading.
6. For testing below 1GHz, if the emission level of the EUT in peak mode was 3 dB lower than the limit specified, then peak values of EUT will be reported, otherwise, the emissions will be repeated one by one using the CISPR quasi-peak method and reported.
7. For testing above 1GHz, the emission level of the EUT in peak mode was 20dB lower than average limit (that means the emission level in average mode also complies with the limit in average mode), then peak values of EUT will be reported, otherwise, the emissions will be measured in average mode again and reported.

3.2.4 Test Setup

For radiated emissions below 30MHz

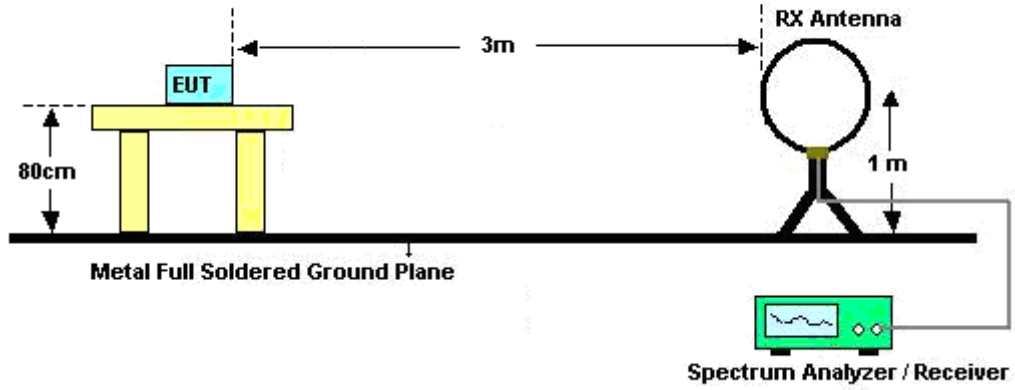

For radiated emissions from 30MHz to 1GHz

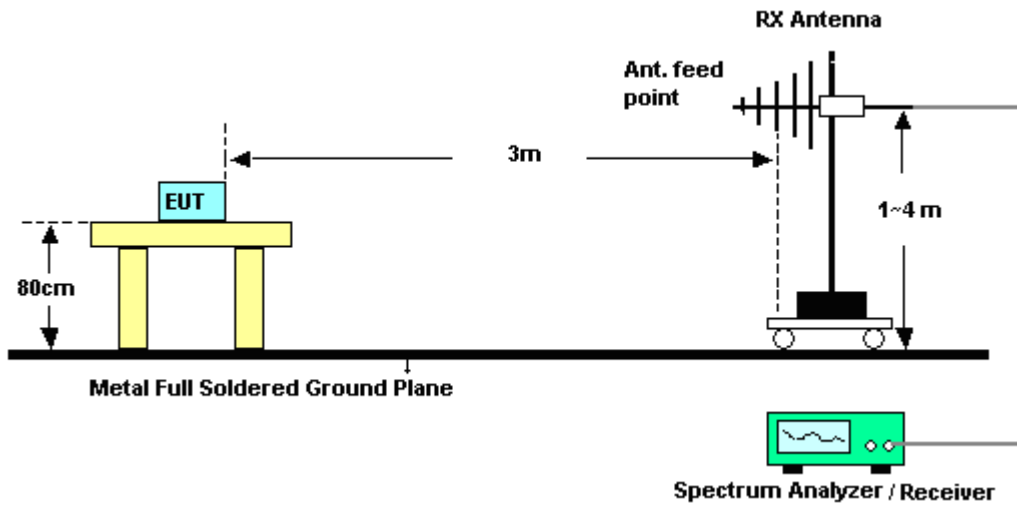

For radiated emissions above 1GHz

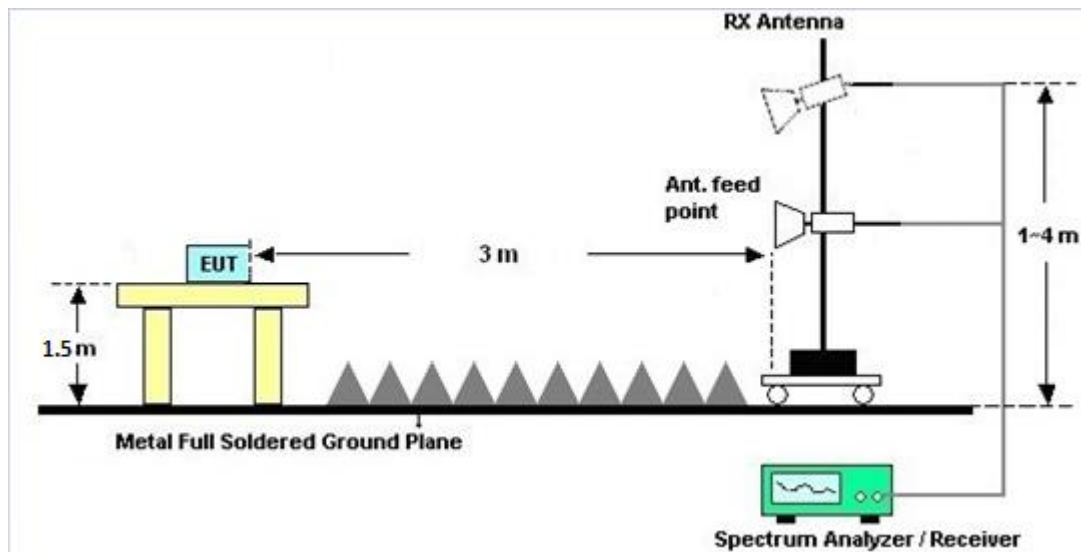

3.2.5 Test Results of Radiated Emissions (9 kHz ~ 30 MHz)

The low frequency, which started from 9 kHz to 30MHz, was pre-scanned and the result which was 20dB lower than the limit line was not reported.

There is a comparison data of both open-field test site and alternative test site - semi-Anechoic chamber according to 414788 D01 Radiated Test Site v01r01, and the result came out very similar.

3.2.6 Test Result of Radiated Band Edges

Please refer to Appendix B and C.

3.2.7 Duty Cycle

Please refer to Appendix D.

3.2.8 Test Result of Unwanted Radiated Emission (30MHz ~ 10th Harmonic)

Please refer to Appendix B and C.



3.3 Antenna Requirements

3.3.1 Standard Applicable

If transmitting antenna directional gain is greater than 6 dBi, both the peak transmit power and the peak power spectral density shall be reduced by the amount in dB that the directional gain of the antenna exceeds 6 dBi.

3.3.2 Antenna Anti-Replacement Construction

An embedded-in antenna design is used.

3.3.3 Antenna Gain

<CDD Modes >

FCC KDB 662911 D01 Multiple Transmitter Output v02r01

For CDD transmissions, directional gain is calculated as

Directional gain = GANT + Array Gain, where Array Gain is as follows.

For power spectral density (PSD) measurements on all devices,

Array Gain = 10 log(NANT/NSS=1) dB.

For power measurements on IEEE 802.11 devices,

Array Gain = 0 dB (i.e., no array gain) for NANT ≤ 4.

Directional gain may be calculated by using the formulas applicable to equal gain antennas with GANT set equal to the gain of the antenna having the highest gain;

The EUT supports CDD mode.

For power, the directional gain GANT is set equal to the antenna having the highest gain, i.e., F)2)f)i).

For PSD, the directional gain calculation is following F)2)f)ii) of KDB 662911 D01 v02r01.

The power and PSD limit should be modified if the directional gain of EUT is over 6 dBi,

The directional gain “DG” is calculated as following table.

<CDD Modes>						
			DG	DG	Power	PSD
			for	for	Limit	Limit
	Ant. 1	Ant. 2	Power	PSD	Reduction	Reduction
	(dBi)	(dBi)	(dBi)	(dBi)	(dB)	(dB)
Band IV	1.50	1.30	1.50	4.41	0.00	0.00

Power Limit Reduction = DG(Power) – 6dBi, (min = 0)

PSD Limit Reduction = DG(PSD) – 6dBi, (min = 0)

TXBF modes

FCC KDB 662911 D01 Multiple Transmitter Output v02r01

For CDD transmissions, directional gain is calculated as

$$DirectionalGain = 10 \cdot \log \left[\frac{\sum_{j=1}^{N_{SS}} \left\{ \sum_{k=1}^{N_{ANT}} g_{j,k} \right\}^2}{N_{ANT}} \right]$$

where

Each antenna is driven by no more than one spatial stream;

N_{SS} = the number of independent spatial streams of data;

N_{ANT} = the total number of antennas

$g_{j,k} = 10^{G_k / 20}$ if the k th antenna is being fed by spatial stream j , or zero if it is not;
 G_k is the gain in dBi of the k th antenna.

The EUT supports beamforming for 802.11ac modes.

The directional gain calculation is following F)2)e)ii) of KDB 662911 D01 v02r01.

The power and PSD limit should be modified if the directional gain of EUT is over 6 dBi,

The directional gain “DG” is calculated as following table.

			DG	DG	Power	PSD
			for	for	Limit	Limit
	Ant 1	Ant 2	Power	PSD	Reduction	Reduction
	(dBi)	(dBi)	(dBi)	(dBi)	(dB)	(dB)
Band IV	1.50	1.30	4.41	4.41	0.00	0.00

$Power\ Limit\ Reduction = DG(Power) - 6dBi, (min = 0)$

$PSD\ Limit\ Reduction = DG(PSD) - 6dBi, (min = 0)$



4 List of Measuring Equipment

Instrument	Manufacturer	Model No.	Serial No.	Characteristics	Calibration Date	Test Date	Due Date	Remark
Loop Antenna	Rohde & Schwarz	HFH2-Z2	100488	9 kHz~30 MHz	Jan. 09, 2020	Feb. 23, 2020~ Feb. 25, 2020	Jan. 08, 2021	Radiation (03CH13-HY)
Horn Antenna	SCHWARZBECK	BBHA 9120 D	9120D-124 1	1GHz ~ 18GHz	Jul. 02, 2019	Feb. 23, 2020~ Feb. 25, 2020	Jul. 01, 2020	Radiation (03CH13-HY)
Bilog Antenna	TESEQ	CBL 6111D&00800 N1D01N-06	40103 & 07	30MHz~1GHz	Apr. 30, 2019	Feb. 23, 2020~ Feb. 25, 2020	Apr. 29, 2020	Radiation (03CH13-HY)
SHF-EHF Horn Antenna	SCHWARZBECK	BBHA 9170	BBHA9170 576	18GHz- 40GHz	May 14,2019	Feb. 23, 2020~ Feb. 25, 2020	May 13,2020	Radiation (03CH13-HY)
Preamplifier	Keysight	83017A	MY532701 47	1GHz~26.5GHz	Mar. 15, 2019	Feb. 23, 2020~ Feb. 25, 2020	Mar. 14, 2020	Radiation (03CH13-HY)
Preamplifier	MITEQ	AMF-7D-0010 1800-30-10P	1590074	1GHz~18GHz	May 20, 2019	Feb. 23, 2020~ Feb. 25, 2020	May 19, 2020	Radiation (03CH13-HY)
Amplifier	Sonoma-Instrument	310 N	187282	9KHz~1GHz	Dec. 17, 2019	Feb. 23, 2020~ Feb. 25, 2020	Dec. 16, 2020	Radiation (03CH13-HY)
Preamplifier	EMEC	EM18G40G	060715	18GHz ~ 40GHz	Dec. 13, 2019	Feb. 23, 2020~ Feb. 25, 2020	Dec. 12, 2020	Radiation (03CH13-HY)
Hygrometer	TECPEL	DTM-303B	TP150115	N/A	Nov. 08, 2019	Feb. 23, 2020~ Feb. 25, 2020	Nov. 07, 2020	Radiation (03CH13-HY)
RF Cable	HUBER + SUHNER	SUCOFLEX 126E	0030/126E	30M-18G	Feb. 12, 2020	Feb. 23, 2020~ Feb. 25, 2020	Feb. 11, 2021	Radiation (03CH13-HY)
RF Cable	HUBER + SUHNER	SUCOFLEX 104	804793/4	30M-18G	Feb. 12, 2020	Feb. 23, 2020~ Feb. 25, 2020	Feb. 11, 2021	Radiation (03CH13-HY)
RF Cable	HUBER + SUHNER	SUCOFLEX 104	MY24961/ 4	30M-18G	Feb. 12, 2020	Feb. 23, 2020~ Feb. 25, 2020	Feb. 11, 2021	Radiation (03CH13-HY)
RF Cable	HUBER + SUHNER	SUCOFLEX 102	MY2859/2	30M~40GHz	Mar. 13, 2019	Feb. 23, 2020~ Feb. 25, 2020	Mar. 12, 2020	Radiation (03CH13-HY)
RF Cable	HUBER + SUHNER	SUCOFLEX 102	MY4274/2	30M~40GHz	Mar. 13, 2019	Feb. 23, 2020~ Feb. 25, 2020	Mar. 12, 2020	Radiation (03CH13-HY)
Spectrum Analyzer	Keysight	N9010A	MY553705 26	10Hz~44GHz	Mar. 19, 2019	Feb. 23, 2020~ Feb. 25, 2020	Mar. 18, 2020	Radiation (03CH13-HY)
Controller	EMEC	EM1000	N/A	Control Turn table & Ant Mast	N/A	Feb. 23, 2020~ Feb. 25, 2020	N/A	Radiation (03CH13-HY)
Antenna Mast	EMEC	AM-BS-4500- B	N/A	1m~4m	N/A	Feb. 23, 2020~ Feb. 25, 2020	N/A	Radiation (03CH13-HY)
Turn Table	EMEC	TT2000	N/A	0~360 Degree	N/A	Feb. 23, 2020~ Feb. 25, 2020	N/A	Radiation (03CH13-HY)
Software	AUDIX	E3 6.2009-8-24c	RK-001124	N/A	N/A	Feb. 23, 2020~ Feb. 25, 2020	N/A	Radiation (03CH13-HY)
EMI Test Receiver	Keysight	N9038A(MXE)	MY541300 85	20Hz ~ 8.4GHz	Nov. 01, 2019	Feb. 23, 2020~ Feb. 25, 2020	Oct. 31, 2020	Radiation (03CH13-HY)
Filter	Wainwright	WHKX12-270 0-3000-18000 -60SS	SN2	3GHz High Pass Filter	Jul. 14, 2019	Feb. 23, 2020~ Feb. 25, 2020	Jul. 13, 2020	Radiation (03CH13-HY)
Filter	Wainwright	WLK4-1000-1 530-8000-40S S	SN12	1.53GHz Low Pass Filter	Sep. 16, 2019	Feb. 23, 2020~ Feb. 25, 2020	Sep. 15, 2020	Radiation (03CH13-HY)
Filter	Wainwright	WHKX8-5872. 5-6750-18000 -40ST	SN5	6.75GHz High Pass Filter	Mar. 13, 2019	Feb. 23, 2020~ Feb. 25, 2020	Mar. 12, 2020	Radiation (03CH13-HY)



Instrument	Manufacturer	Model No.	Serial No.	Characteristics	Calibration Date	Test Date	Due Date	Remark
Hygrometer	Testo	608-H2	41410069	N/A	Jun. 17, 2019	Feb. 13, 2020~ Feb. 27, 2020	Jun. 16, 2020	Conducted (TH05-HY)
Power Sensor	DARE	RPR3006W	16I00054S NO10	10MHz~6GHz	Dec. 23, 2019	Feb. 13, 2020~ Feb. 27, 2020	Dec. 22, 2020	Conducted (TH05-HY)
Signal Analyzer	Rohde & Schwarz	FSV40	101566	10Hz~40GHz	Jul. 15, 2019	Feb. 13, 2020~ Feb. 27, 2020	Jul. 14, 2020	Conducted (TH05-HY)
Power Supply	GW Instek	SPS-606	GES84293 1	NA	Aug. 19, 2019	Feb. 13, 2020~ Feb. 27, 2020	Aug. 18, 2020	Conducted (TH05-HY)
Switch Box & RF Cable	Burgeon	ETF-058	EC120838 2	N/A	Mar. 27, 2019	Feb. 13, 2020~ Feb. 27, 2020	Mar. 26, 2020	Conducted (TH05-HY)



5 Uncertainty of Evaluation

Uncertainty of Radiated Emission Measurement (30 MHz ~ 1000 MHz)

Measuring Uncertainty for a Level of Confidence of 95% ($U = 2Uc(y)$)	4.4
---	-----

Uncertainty of Radiated Emission Measurement (1000 MHz ~ 18000 MHz)

Measuring Uncertainty for a Level of Confidence of 95% ($U = 2Uc(y)$)	5.5
---	-----

Uncertainty of Radiated Emission Measurement (18000 MHz ~ 40000 MHz)

Measuring Uncertainty for a Level of Confidence of 95% ($U = 2Uc(y)$)	4.8
---	-----

Appendix A. Test Result of Conducted Test Items**<CDD Mode>**

Test Engineer:	Kathy Chen	Temperature:	21~25	°C
Test Date:	2020/2/13 ~2/14	Relative Humidity:	51~54	%

TEST RESULTS DATA
Average Power Table

Band IV single antenna												
Mod.	Data Rate	NTX	CH.	Freq. (MHz)	Average Conducted Power (dBm)			FCC Conducted Power Limit (dBm)		DG (dBi)		Pass/Fail
					Ant 1	Ant 2	SUM	Ant 1	Ant 2	Ant 1	Ant 2	
11a	6Mbps	1	149	5745	16.80	16.90		30.00	30.00	1.50	1.30	Pass
11a	6Mbps	1	157	5785	16.60	16.50		30.00	30.00	1.50	1.30	Pass
11a	6Mbps	1	165	5825	16.70	16.80		30.00	30.00	1.50	1.30	Pass
HT20	MCS0	1	149	5745	16.70	16.90		30.00	30.00	1.50	1.30	Pass
HT20	MCS0	1	157	5785	16.80	16.80		30.00	30.00	1.50	1.30	Pass
HT20	MCS0	1	165	5825	16.90	16.70		30.00	30.00	1.50	1.30	Pass
HT40	MCS0	1	151	5755	16.60	16.60		30.00	30.00	1.50	1.30	Pass
HT40	MCS0	1	159	5795	16.50	16.50		30.00	30.00	1.50	1.30	Pass
VHT20	MCS0	1	149	5745	17.10	17.20		30.00	30.00	1.50	1.30	Pass
VHT20	MCS0	1	157	5785	16.90	16.90		30.00	30.00	1.50	1.30	Pass
VHT20	MCS0	1	165	5825	17.00	16.90		30.00	30.00	1.50	1.30	Pass
VHT40	MCS0	1	151	5755	16.90	16.90		30.00	30.00	1.50	1.30	Pass
VHT40	MCS0	1	159	5795	16.80	16.80		30.00	30.00	1.50	1.30	Pass
VHT80	MCS0	1	155	5775	16.70	16.70		30.00	30.00	1.50	1.30	Pass

Band IV MIMO												
Mod.	Data Rate	NTX	CH.	Freq. (MHz)	Average Conducted Power (dBm)			FCC Conducted Power Limit (dBm)		DG (dBi)		Pass/Fail
					Ant 1	Ant 2	SUM	Ant 1	Ant 2	Ant 1	Ant 2	
11a	6Mbps	2	149	5745	17.20	16.80	20.01	30.00		1.50		Pass
11a	6Mbps	2	157	5785	16.70	16.50	19.61	30.00		1.50		Pass
11a	6Mbps	2	165	5825	17.00	16.70	19.86	30.00		1.50		Pass
HT20	MCS0	2	149	5745	17.40	16.50	19.98	30.00		1.50		Pass
HT20	MCS0	2	157	5785	16.90	16.70	19.81	30.00		1.50		Pass
HT20	MCS0	2	165	5825	17.10	16.70	19.91	30.00		1.50		Pass
HT40	MCS0	2	151	5755	16.70	16.50	19.61	30.00		1.50		Pass
HT40	MCS0	2	159	5795	17.00	16.70	19.86	30.00		1.50		Pass
VHT20	MCS0	2	149	5745	17.70	16.70	20.24	30.00		1.50		Pass
VHT20	MCS0	2	157	5785	17.00	16.80	19.91	30.00		1.50		Pass
VHT20	MCS0	2	165	5825	17.20	16.80	20.01	30.00		1.50		Pass
VHT40	MCS0	2	151	5755	17.10	16.70	19.91	30.00		1.50		Pass
VHT40	MCS0	2	159	5795	17.10	16.90	20.01	30.00		1.50		Pass
VHT80	MCS0	2	155	5775	16.80	16.70	19.76	30.00		1.50		Pass

TEST RESULTS DATA
Average Power Table

Band IV single antenna													
Mod.	Data Rate	NTX	CH.	Freq. (MHz)	RU Config	Average Conducted Power (dBm)			FCC Conducted Power Limit (dBm)		DG (dBi)		Pass/Fail
						Ant 1	Ant 2	SUM	Ant 1	Ant 2	Ant 1	Ant 2	
HE20	MCS0	1	149	5745	Full	16.90	16.90		30.00	30.00	1.50	1.30	Pass
HE20	MCS0	1	149	5745	26/0	16.90	16.80		30.00	30.00	1.50	1.30	Pass
HE20	MCS0	1	149	5745	52/37	16.80	16.80		30.00	30.00	1.50	1.30	Pass
HE20	MCS0	1	149	5745	106/53	16.90	16.80		30.00	30.00	1.50	1.30	Pass
HE20	MCS0	1	157	5785	Full	16.80	16.80		30.00	30.00	1.50	1.30	Pass
HE20	MCS0	1	165	5825	Full	17.00	17.00		30.00	30.00	1.50	1.30	Pass
HE20	MCS0	1	165	5825	26/8	16.90	16.90		30.00	30.00	1.50	1.30	Pass
HE20	MCS0	1	165	5825	52/40	16.80	16.90		30.00	30.00	1.50	1.30	Pass
HE20	MCS0	1	165	5825	106/54	16.80	16.90		30.00	30.00	1.50	1.30	Pass
HE40	MCS0	1	151	5755	Full	17.10	17.10		30.00	30.00	1.50	1.30	Pass
HE40	MCS0	1	151	5755	242/61	16.60	16.70		30.00	30.00	1.50	1.30	Pass
HE40	MCS0	1	159	5795	Full	16.70	16.70		30.00	30.00	1.50	1.30	Pass
HE40	MCS0	1	159	5795	242/62	16.40	16.40		30.00	30.00	1.50	1.30	Pass
HE80	MCS0	1	155	5775	Full	16.60	16.60		30.00	30.00	1.50	1.30	Pass
HE80	MCS0	1	155	5775	484/65	16.50	16.50		30.00	30.00	1.50	1.30	Pass
HE80	MCS0	1	155	5775	484/66	16.50	16.50		30.00	30.00	1.50	1.30	Pass

Band IV MIMO													
Mod.	Data Rate	NTX	CH.	Freq. (MHz)	RU Config	Average Conducted Power (dBm)			FCC Conducted Power Limit (dBm)		DG (dBi)		Pass/Fail
						Ant 1	Ant 2	SUM	Ant 1	Ant 2	Ant 1	Ant 2	
HE20	MCS0	1	149	5745	Full	17.40	16.60	20.03	30.00	30.00	1.50	1.50	Pass
HE20	MCS0	1	149	5745	26/0	17.30	16.50	19.93	30.00	30.00	1.50	1.50	Pass
HE20	MCS0	1	149	5745	52/37	17.30	16.50	19.93	30.00	30.00	1.50	1.50	Pass
HE20	MCS0	1	149	5745	106/53	17.30	16.50	19.93	30.00	30.00	1.50	1.50	Pass
HE20	MCS0	1	157	5785	Full	17.10	16.50	19.82	30.00	30.00	1.50	1.50	Pass
HE20	MCS0	1	165	5825	Full	17.30	16.70	20.02	30.00	30.00	1.50	1.50	Pass
HE20	MCS0	1	165	5825	26/8	17.20	16.60	19.92	30.00	30.00	1.50	1.50	Pass
HE20	MCS0	1	165	5825	52/40	17.20	16.60	19.92	30.00	30.00	1.50	1.50	Pass
HE20	MCS0	1	165	5825	106/54	17.20	16.60	19.92	30.00	30.00	1.50	1.50	Pass
HE40	MCS0	1	151	5755	Full	17.50	17.00	20.27	30.00	30.00	1.50	1.50	Pass
HE40	MCS0	1	151	5755	242/61	16.90	16.60	19.76	30.00	30.00	1.50	1.50	Pass
HE40	MCS0	1	159	5795	Full	16.90	16.70	19.81	30.00	30.00	1.50	1.50	Pass
HE40	MCS0	1	159	5795	242/62	16.80	16.60	19.71	30.00	30.00	1.50	1.50	Pass
HE80	MCS0	1	155	5775	Full	17.10	16.90	20.01	30.00	30.00	1.50	1.50	Pass
HE80	MCS0	1	155	5775	484/65	16.70	16.50	19.61	30.00	30.00	1.50	1.50	Pass
HE80	MCS0	1	155	5775	484/66	16.80	16.50	19.66	30.00	30.00	1.50	1.50	Pass

<TXBF Mode>

Test Engineer:	Richard Qiu	Temperature:	21~25	°C
Test Date:	2020/2/21	Relative Humidity:	51~54	%

TEST RESULTS DATA
Average Power Table

Band IV MIMO												
Mod.	Data Rate	NTX	CH.	Freq. (MHz)	Average Conducted Power (dBm)			FCC Conducted Power Limit (dBm)		DG (dBi)		Pass/Fail
					Ant 1	Ant 2	SUM	Ant 1	Ant 2	Ant 1	Ant 2	
VHT20	MCS0	2	149	5745	14.60	15.00	17.81	30.00		4.41		Pass
VHT20	MCS0	2	157	5785	15.40	15.10	18.26	30.00		4.41		Pass
VHT20	MCS0	2	165	5825	14.80	15.10	17.96	30.00		4.41		Pass
VHT40	MCS0	2	151	5755	15.20	14.80	18.01	30.00		4.41		Pass
VHT40	MCS0	2	159	5795	15.70	15.10	18.42	30.00		4.41		Pass
VHT80	MCS0	2	155	5775	15.60	15.20	18.41	30.00		4.41		Pass

TEST RESULTS DATA
Average Power Table

Band IV MIMO													
Mod.	Data Rate	NTX	CH.	Freq. (MHz)	RU Config	Average Conducted Power (dBm)			FCC Conducted Power Limit (dBm)		DG (dBi)		Pass/Fail
						Ant 1	Ant 2	SUM	Ant 1	Ant 2	Ant 1	Ant 2	
HE20	MCS0	1	149	5745	Full	14.70	15.20	17.97	30.00		4.41		Pass
HE20	MCS0	1	157	5785	Full	15.60	15.10	18.37	30.00		4.41		Pass
HE20	MCS0	1	165	5825	Full	15.10	15.40	18.26	30.00		4.41		Pass
HE40	MCS0	1	151	5755	Full	14.90	15.00	17.96	30.00		4.41		Pass
HE40	MCS0	1	159	5795	Full	15.20	15.00	18.11	30.00		4.41		Pass
HE80	MCS0	1	155	5775	Full	14.90	15.00	17.96	30.00		4.41		Pass



Appendix B. Radiated Spurious Emission

Test Engineer :	Jimmy Chung, Karl Hou, Wilson Wu, and Chuan Wei	Temperature :	21.5~23.5°C
		Relative Humidity :	49.5~55.5%

<CDD Mode>

Band 4 - 5725~5850MHz

WIFI 802.11ac VHT80 (Band Edge @ 3m)

WIFI Ant. 1+2	Note	Frequency (MHz)	Level (dBμV/m)	Over Limit (dB)	Limit Line (dBμV/m)	Read Level (dBμV)	Antenna Factor (dB/m)	Path Loss (dB)	Preamp Factor (dB)	Ant Pos (cm)	Table Pos (deg)	Peak Avg. (P/A)	Pol. (H/V)
802.11ac VHT80 CH 155 5775MHz		5643.8	60.51	-7.69	68.2	49.18	31.8	6.35	26.82	100	165	P	H
		5698.4	79.6	-24.42	104.02	68.05	31.99	6.42	26.86	100	165	P	H
		5718.2	82.06	-28.24	110.3	70.43	32.07	6.44	26.88	100	165	P	H
		5722.6	83.49	-33.24	116.73	71.84	32.09	6.45	26.89	100	165	P	H
	*	5775	103	-	-	91.17	32.25	6.51	26.93	100	165	P	H
	*	5775	94.32	-	-	82.49	32.25	6.51	26.93	100	165	A	H
		5850.4	78.57	-42.72	121.29	66.63	32.4	6.54	27	100	165	P	H
		5855.8	76.64	-33.94	110.58	64.68	32.42	6.54	27	100	165	P	H
		5875	69.05	-36.15	105.2	57.03	32.5	6.54	27.02	100	165	P	H
		5935.4	56.59	-11.61	68.2	44.45	32.67	6.54	27.07	100	165	P	H
		5646.8	61.38	-6.82	68.2	50.04	31.8	6.36	26.82	226	183	P	V
		5694.8	78.78	-22.59	101.37	67.25	31.98	6.41	26.86	226	183	P	V
		5720	82.8	-28	110.8	71.16	32.08	6.44	26.88	226	183	P	V
		5723.6	83	-36.01	119.01	71.35	32.09	6.45	26.89	226	183	P	V
	*	5775	104.45	-	-	92.62	32.25	6.51	26.93	226	183	P	V
	*	5775	95.78	-	-	83.95	32.25	6.51	26.93	226	183	A	V
		5854.6	73.42	-38.29	111.71	61.46	32.42	6.54	27	226	183	P	V
		5856.2	72.98	-37.48	110.46	61.02	32.42	6.54	27	226	183	P	V
	5876.8	65.36	-38.5	103.86	53.33	32.51	6.54	27.02	226	183	P	V	
	5927	53.96	-14.24	68.2	41.84	32.65	6.54	27.07	226	183	P	V	
Remark	1. No other spurious found. 2. All results are PASS against Peak and Average limit line.												



**Band 4 5725~5850MHz
WIFI 802.11ac VHT80 (Harmonic @ 3m)**

WIFI Ant. 1+2	Note	Frequency (MHz)	Level (dBμV/m)	Over Limit (dB)	Limit Line (dBμV/m)	Read Level (dBμV)	Antenna Factor (dB/m)	Path Loss (dB)	Preamp Factor (dB)	Ant Pos (cm)	Table Pos (deg)	Peak Avg. (P/A)	Pol. (H/V)	
802.11ac VHT80 CH 155 5775MHz		11550	45.54	-28.46	74	51.52	39.85	10.47	56.3	100	0	P	H	
		17325	46.63	-21.57	68.2	50.09	40.15	13.14	56.75	100	0	P	H	
													H	
													H	
			11550	47.01	-26.99	74	52.99	39.85	10.47	56.3	100	0	P	V
			17325	46.88	-21.32	68.2	50.34	40.15	13.14	56.75	100	0	P	V
														V
														V
Remark	1. No other spurious found. 2. All results are PASS against Peak and Average limit line.													



Band 4 - 5725~5850MHz

WIFI 802.11ax HE80 (Band Edge @ 3m)

WIFI	Note	Frequency	Level	Over	Limit	Read	Antenna	Path	Preamp	Ant	Table	Peak	Pol.	
Ant.				Limit	Line	Level	Factor	Loss	Factor	Pos	Pos	Avg.		
1+2		(MHz)	(dBμV/m)	(dB)	(dBμV/m)	(dBμV)	(dB/m)	(dB)	(dB)	(cm)	(deg)	(P/A)	(H/V)	
802.11ax HE80 CH 155 5775MHz		5648.8	64.94	-3.26	68.2	53.6	31.8	6.36	26.82	100	270	P	H	
		5688.2	81.13	-15.37	96.5	69.63	31.95	6.41	26.86	100	270	P	H	
		5717.8	88.24	-21.94	110.18	76.61	32.07	6.44	26.88	100	270	P	H	
		5723.8	90.16	-29.3	119.46	78.5	32.1	6.45	26.89	100	270	P	H	
	*	5775	109.27	-	-	97.44	32.25	6.51	26.93	100	270	P	H	
	*	5775	97.76	-	-	85.93	32.25	6.51	26.93	100	270	A	H	
		5851.6	79.49	-39.06	118.55	67.54	32.41	6.54	27	100	270	P	H	
		5867.6	75.65	-31.62	107.27	63.65	32.47	6.54	27.01	100	270	P	H	
		5882.2	68.47	-31.38	99.85	56.43	32.53	6.54	27.03	100	270	P	H	
		5931.2	60.31	-7.89	68.2	48.18	32.66	6.54	27.07	100	270	P	H	
														H
														H
			5624.4	59.21	-8.99	68.2	47.88	31.8	6.33	26.8	100	174	P	V
			5690.8	77.67	-20.75	98.42	66.16	31.96	6.41	26.86	100	174	P	V
			5718.2	84.1	-26.2	110.3	72.47	32.07	6.44	26.88	100	174	P	V
			5724.6	84.68	-36.61	121.29	73.02	32.1	6.45	26.89	100	174	P	V
	*		5775	109.15	-	-	97.32	32.25	6.51	26.93	100	174	P	V
	*		5775	98.75	-	-	86.92	32.25	6.51	26.93	100	174	A	V
			5852	74.98	-42.66	117.64	63.03	32.41	6.54	27	100	174	P	V
			5870.8	72.92	-33.45	106.37	60.92	32.48	6.54	27.02	100	174	P	V
		5875	65.84	-39.36	105.2	53.82	32.5	6.54	27.02	100	174	P	V	
		5931.4	56.93	-11.27	68.2	44.8	32.66	6.54	27.07	100	174	P	V	
													V	
													V	
Remark	<ol style="list-style-type: none"> No other spurious found. All results are PASS against Peak and Average limit line. 													



Band 4 5725~5850MHz

WIFI 802.11ax HE80 (Harmonic @ 3m)

WIFI Ant. 1+2	Note	Frequency (MHz)	Level (dBμV/m)	Over Limit (dB)	Limit Line (dBμV/m)	Read Level (dBμV)	Antenna Factor (dB/m)	Path Loss (dB)	Preamp Factor (dB)	Ant Pos (cm)	Table Pos (deg)	Peak Avg. (P/A)	Pol. (H/V)
802.11ax HE80		11550	46.7	-27.3	74	52.68	39.85	10.47	56.3	100	0	P	H
		17325	46.33	-21.87	68.2	49.79	40.15	13.14	56.75	100	0	P	H
													H
													H
CH 155 5775MHz		11550	46.15	-27.85	74	52.13	39.85	10.47	56.3	100	0	P	V
		17325	47.29	-20.91	68.2	50.75	40.15	13.14	56.75	100	0	P	V
													V
													V
Remark	1. No other spurious found. 2. All results are PASS against Peak and Average limit line.												



Emission below 1GHz

WIFI 802.11ax HE80 (Partial RU 484/65) (LF @ 3m)

WIFI	Note	Frequency	Level	Over	Limit	Read	Antenna	Path	Preamp	Ant	Table	Peak	Pol.	
Ant.				Limit	Line	Level	Factor	Loss	Factor	Pos	Pos	Avg.		
1+2		(MHz)	(dBμV/m)	(dB)	(dBμV/m)	(dBμV)	(dB/m)	(dB)	(dB)	(cm)	(deg)	(P/A)	(H/V)	
802.11ax HE80 484/65 RU LF		31.94	23.26	-16.74	40	31.64	23.36	0.49	32.23	-	-	P	H	
		139.61	18.59	-24.91	43.5	32.43	17.32	1.03	32.19	-	-	P	H	
		758.47	30.71	-15.29	46	32.1	28.06	2.37	31.82	-	-	P	H	
		842.86	31.12	-14.88	46	31.61	28.84	2.48	31.81	-	-	P	H	
		921.43	31.84	-14.16	46	31.07	29.44	2.69	31.36	-	-	P	H	
		947.62	33.61	-12.39	46	31.46	30.49	2.69	31.03	100	0	P	H	
													H	
													H	
													H	
													H	
													H	
													H	
													H	
													H	
													H	
													H	
			31.94	27.2	-12.8	40	35.58	23.36	0.49	32.23	100	0	P	V
			140.58	17.91	-25.59	43.5	31.77	17.3	1.03	32.19	-	-	P	V
		750.71	30.5	-15.5	46	31.89	28.05	2.35	31.79	-	-	P	V	
		851.59	31.99	-14.01	46	32.28	29	2.49	31.78	-	-	P	V	
		920.46	32.52	-13.48	46	31.77	29.43	2.69	31.37	-	-	P	V	
		951.5	33.15	-12.85	46	30.79	30.65	2.69	30.98	-	-	P	V	
													V	
													V	
													V	
													V	
													V	
													V	
													V	
Remark	1. No other spurious found. 2. All results are PASS against limit line.													



Note symbol

*	Fundamental Frequency which can be ignored. However, the level of any unwanted emissions shall not exceed the level of the fundamental frequency.
!	Test result is over limit line.
P/A	Peak or Average
H/V	Horizontal or Vertical



A calculation example for radiated spurious emission is shown as below:

WIFI	Note	Frequency	Level	Over	Limit	Read	Antenna	Path	Preamp	Ant	Table	Peak	Pol.
Ant.				Limit	Line	Level	Factor	Loss	Factor	Pos	Pos	Avg.	
1+2		(MHz)	(dBμV/m)	(dB)	(dBμV/m)	(dBμV)	(dB/m)	(dB)	(dB)	(cm)	(deg)	(P/A)	(H/V)
802.11b		2390	55.45	-18.55	74	54.51	32.22	4.58	35.86	103	308	P	H
CH 01													
2412MHz		2390	43.54	-10.46	54	42.6	32.22	4.58	35.86	103	308	A	H

1. Path Loss(dB) = Cable loss(dB) + Filter loss(dB) + Attenuator loss(dB)
2. Level(dBμV/m) = Antenna Factor(dB/m) + Path Loss(dB) + Read Level(dBμV) - Preamp Factor(dB)
3. Over Limit(dB) = Level(dBμV/m) – Limit Line(dBμV/m)

For Peak Limit @ 2390MHz:

1. Level(dBμV/m)
= Antenna Factor(dB/m) + Path Loss(dB) + Read Level(dBμV) - Preamp Factor(dB)
= 32.22(dB/m) + 4.58(dB) + 54.51(dBμV) – 35.86 (dB)
= 55.45 (dBμV/m)
2. Over Limit(dB)
= Level(dBμV/m) – Limit Line(dBμV/m)
= 55.45(dBμV/m) – 74(dBμV/m)
= -18.55(dB)

For Average Limit @ 2390MHz:

1. Level(dBμV/m)
= Antenna Factor(dB/m) + Path Loss(dB) + Read Level(dBμV) - Preamp Factor(dB)
= 32.22(dB/m) + 4.58(dB) + 42.6(dBμV) – 35.86 (dB)
= 43.54 (dBμV/m)
2. Over Limit(dB) = Level(dBμV/m) – Limit Line(dBμV/m)
= 43.54(dBμV/m) – 54(dBμV/m)
= -10.46(dB)

Both peak and average measured complies with the limit line, so test result is “PASS”.



Appendix C. Radiated Spurious Emission Plots

Test Engineer :	Jimmy Chung, Karl Hou, Wilson Wu, and Chuan Wei	Temperature :	21.5~23.5°C
		Relative Humidity :	49.5~55.5%

Note symbol

-L	Low channel location
-R	High channel location



<CDD Mode>

Band 4 - 5725~5850MHz
WIFI 802.11ac VHT80 (Band Edge @ 3m)

WIFI	Band 4 5725~5850MHz Band Edge @ 3m	
ANT	802.11ac VHT80 CH155 5775MHz	
1+2	Horizontal	Fundamental
Peak	<p>Site : 03CH13-HY Condition : PEAK_BE(B4)_16-24 3m HORN_91200_1241 HORIZONTAL Detector : Peak Project : 9D0635-01 Setting : Z1</p>	<p>Site : 03CH13-HY Condition : PEAK(UNIT) 3m HORN_91200_1241 HORIZONTAL Detector : Peak Project : 9D0635-01 Setting : Z1</p>
Peak	<p>Site : 03CH13-HY Condition : PEAK_BE(B4)_16-24 3m HORN_91200_1241 HORIZONTAL Detector : Peak Project : 9D0635-01 Setting : Z1</p>	Left blank

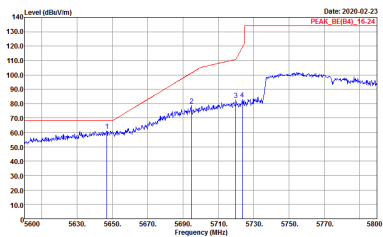
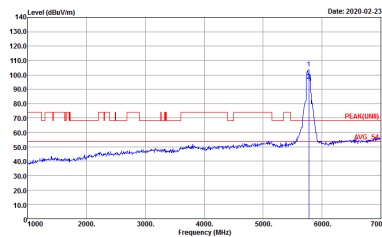
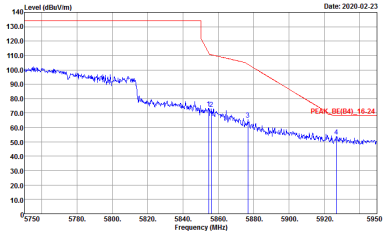

WIFI	Band 4 5725~5850MHz Band Edge @ 3m	
ANT	802.11ac VHT80 CH155 5775MHz	
1+2	Vertical	Fundamental
Peak	 <p>Date: 2020-02-23 PEAK_BE(B4)_16-24</p> <p>Site : 03CH13-HY Condition : PEAK_BE(B4)_16-24 3m HORN_91200_1241 VERTICAL RBW:1000.000KHz VBW:3000.000KHz SWT:Auto Detector : Peak Project : 9D0635-01 Setting : Z1</p>	 <p>Date: 2020-02-23 PEAKUNB 205.96</p> <p>Site : 03CH13-HY Condition : PEAKUNB1 3m HORN_91200_1241 VERTICAL RBW:1000.000KHz VBW:3000.000KHz SWT:Auto Detector : Peak Project : 9D0635-01 Setting : Z1</p>
Peak	 <p>Date: 2020-02-23 PEAK_BE(B4)_16-24</p> <p>Site : 03CH13-HY Condition : PEAK_BE(B4)_16-24 3m HORN_91200_1241 VERTICAL RBW:1000.000KHz VBW:3000.000KHz SWT:Auto Detector : Peak Project : 9D0635-01 Setting : Z1</p>	Left blank



Band 4 - 5725~5850MHz
WIFI 802.11ac VHT80 (Harmonic @ 3m)

Table with 2 columns: Horizontal and Vertical. Each column contains a spectral plot of Level (dBV/m) vs Frequency (MHz) with peak and average markers. Includes metadata like Site, Condition, Detector, Project, Mode, and Setting.



Band 4 - 5725~5850MHz
WIFI 802.11ax HE80 (Band Edge @ 3m)

WIFI	Band 4 5725~5850MHz Band Edge @ 3m	
ANT	802.11ax HE80 CH155 5775MHz	
1+2	Horizontal	Fundamental
Peak	<p>Site : 03CH13-HY Condition : PEAK_BE(B4)_16-24 3m HORN_91200_1241 HORIZONTAL RBW:1000.000KHz VBW:3000.000KHz SWT:Auto Detector : Peak Project : 900635-01 Mode : 9 Setting : 22.5</p>	<p>Site : 03CH13-HY Condition : PEAK(LINE) 3m HORN_91200_1241 HORIZONTAL RBW:1000.000KHz VBW:3000.000KHz SWT:Auto Detector : Peak Project : 900635-01 Mode : 9 Setting : 22.5</p>
Peak	<p>Site : 03CH13-HY Condition : PEAK_BE(B4)_16-24 3m HORN_91200_1241 HORIZONTAL RBW:1000.000KHz VBW:3000.000KHz SWT:Auto Detector : Peak Project : 900635-01 Mode : 9 Setting : 22.5</p>	Left blank



WIFI	Band 4 5725~5850MHz Band Edge @ 3m	
ANT	802.11ax HE80 CH155 5775MHz	
1+2	Vertical	Fundamental
<p>Peak</p>	<p>Date: 2020-02-25 PEAK_BE(B4)_16-24</p> <p>Site : 03CH13-HY Condition : PEAK_BE(B4)_16-24 3m HORN_91200_1241 VERTICAL RBW:1000.000KHz VBW:3000.000KHz SWT:Auto Detector : Peak Project : 900635-01 Mode : 9 Setting : 22.5</p>	<p>Date: 2020-02-25 PEAK(LNB) 5775.24</p> <p>Site : 03CH13-HY Condition : PEAK(LNB) 3m HORN_91200_1241 VERTICAL RBW:1000.000KHz VBW:3000.000KHz SWT:Auto Detector : Peak Project : 900635-01 Mode : 9 Setting : 22.5</p>
<p>Peak</p>	<p>Date: 2020-02-25 PEAK_BE(B4)_16-24</p> <p>Site : 03CH13-HY Condition : PEAK_BE(B4)_16-24 3m HORN_91200_1241 VERTICAL RBW:1000.000KHz VBW:3000.000KHz SWT:Auto Detector : Peak Project : 900635-01 Mode : 9 Setting : 22.5</p>	<p>Left blank</p>



Band 4 - 5725~5850MHz
WIFI 802.11ax HE80 (Harmonic @ 3m)

WIFI	Band 4 5725~5850MHz Harmonic @ 3m	
ANT	802.11ax HE80 CH155 5775MHz	
1+2	Horizontal	Vertical
Peak Avg.	<p>Site : 03CH13-HY Condition : PEAR(LINE1) 3m HORN_91200_1241 HORIZONTAL Detector : Peak Project : 9D0635-01 Mode : 19 Setting : 22.5</p>	<p>Site : 03CH13-HY Condition : PEAR(LINE1) 3m HORN_91200_1241 VERTICAL Detector : Peak Project : 9D0635-01 Mode : 19 Setting : 22.5</p>



Emission below 1GHz

5GHz WIFI 802.11ax HE80 (Partial RU 484/65) (LF)

WIFI	5GHz WIFI	
ANT	802.11ax HE80 LF	
1+2	Horizontal	Vertical
QP / Peak	<p>Site : 03CH13-HY Condition : QP 3m BTL06_37059A01 HORIZONTAL Detector : Peak Project : 9D0635-01 Setting : 225</p>	<p>Site : 03CH13-HY Condition : QP 3m BTL06_37059A01 VERTICAL Detector : Peak Project : 9D0635-01 Setting : 225</p>



Appendix E. Duty Cycle Plots

Antenna	Band	Duty Cycle(%)	T(us)	1/T(kHz)	VBW Setting	Duty Factor(dB)
1+2	5GHz 802.11ac VHT80 for Ant 1	100.00	-	-	10Hz	0.00
1+2	5GHz 802.11ac VHT80 for Ant 2	100.00	-	-	10Hz	0.00
1+2	5GHz 802.11ax HE80 for Ant 1	100.00	-	-	10Hz	0.00
1+2	5GHz 802.11ax HE80 for Ant 2	100.00	-	-	10Hz	0.00



MIMO <Ant. 1>

802.11ac VHT80

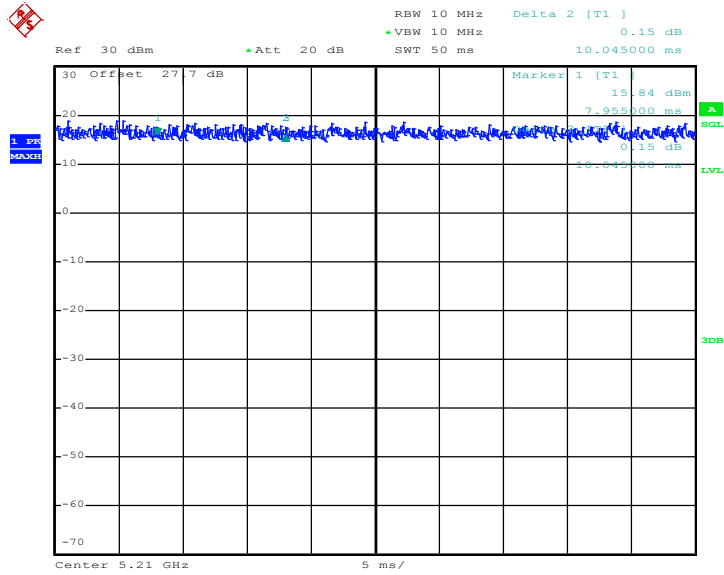

Date: 13.FEB.2020 16:52:34

802.11ax HE80

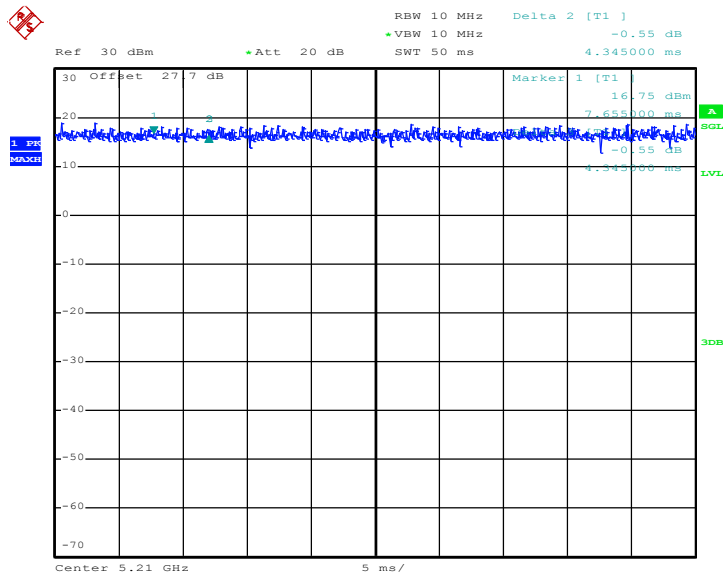

Date: 13.FEB.2020 17:08:19



MIMO <Ant. 2>

802.11ac VHT80

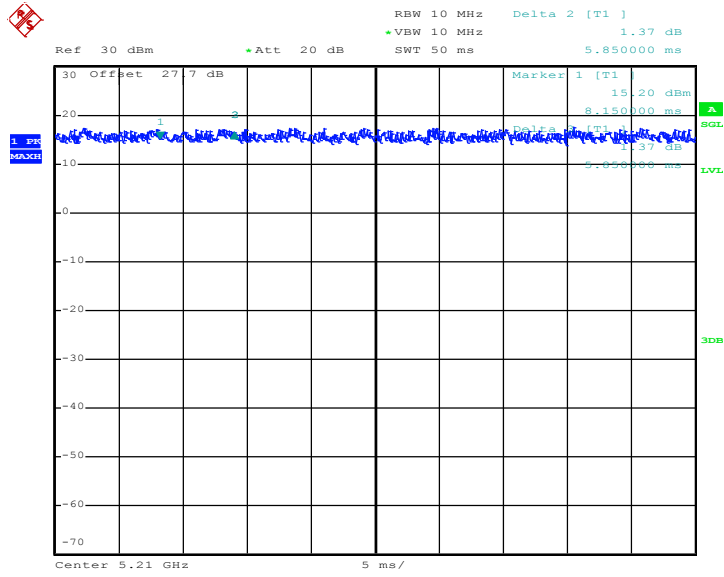

Date: 13.FEB.2020 16:53:21

802.11ax HE80

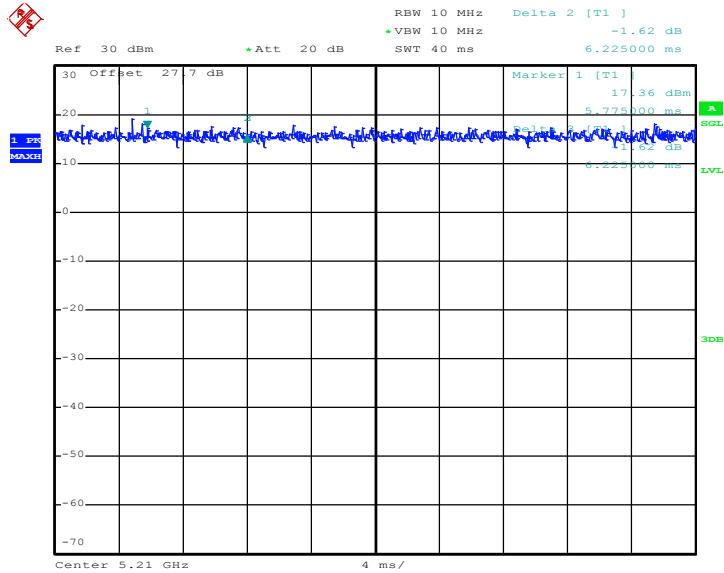

Date: 13.FEB.2020 17:09:18

—THE END—