



# FCC RADIO TEST REPORT

**FCC ID** : IHDT56YJ2  
**Equipment** : Mobile Cellular Phone  
**Brand Name** : Motorola  
**Model Name** : XT2061-3  
**Applicant** : Motorola Mobility, LLC  
222 W Merchandise Mart Plaza, Suite  
1800, Chicago, IL 60654, United States  
**Manufacturer** : Motorola Mobility, LLC  
222 W Merchandise Mart Plaza, Suite  
1800, Chicago, IL 60654, United States  
**Standard** : FCC Part 15 Subpart E §15.407

The product was received on Dec. 06, 2019 and testing was started from Jan. 31, 2020 and completed on Feb. 27, 2020. We, SPORTON INTERNATIONAL INC., EMC & Wireless Communications Laboratory, would like to declare that the tested sample has been evaluated in accordance with the test procedures and has been in compliance with the applicable technical standards.

The report must not be used by the client to claim product certification, approval, or endorsement by TAF or any agency of government.

The test results in this variant report apply exclusively to the tested model / sample. Without written approval of SPORTON INTERNATIONAL INC. EMC & Wireless Communications Laboratory, the test report shall not be reproduced except in full.

*Louis Wu*

Approved by: Louis Wu

**SPORTON INTERNATIONAL INC. EMC & Wireless Communications Laboratory**

No. 52, Huaya 1st Rd., Guishan Dist., Taoyuan City, Taiwan (R.O.C.)



## Table of Contents

History of this test report.....	3
Summary of Test Result.....	4
<b>1 General Description .....</b>	<b>5</b>
1.1 Product Feature of Equipment Under Test.....	5
1.2 Product Specification of Equipment Under Test.....	6
1.3 Modification of EUT .....	9
1.4 Testing Location .....	10
1.5 Applicable Standards.....	10
<b>2 Test Configuration of Equipment Under Test .....</b>	<b>11</b>
2.1 Carrier Frequency and Channel .....	11
2.2 Test Mode.....	12
2.3 Connection Diagram of Test System.....	14
2.4 Support Unit used in test configuration .....	14
2.5 EUT Operation Test Setup .....	14
<b>3 Test Result .....</b>	<b>15</b>
3.1 Maximum Conducted Output Power Measurement .....	15
3.2 Unwanted Emissions Measurement.....	17
3.3 Antenna Requirements.....	22
<b>4 List of Measuring Equipment.....</b>	<b>24</b>
<b>5 Uncertainty of Evaluation .....</b>	<b>27</b>
<b>Appendix A. Conducted Test Results</b>	
<b>Appendix B. Radiated Spurious Emission</b>	
<b>Appendix C. Radiated Spurious Emission Plots</b>	
<b>Appendix D. Duty Cycle Plots</b>	



### History of this test report

Report No.	Version	Description	Issued Date
FR9D0635-01E	01	Initial issue of report	Mar. 02, 2020



### Summary of Test Result

Report Clause	Ref Std. Clause	Test Items	Result (PASS/FAIL)	Remark
-	15.403(i)	26dB Bandwidth	Not Required	-
-	2.1049	99% Occupied Bandwidth	Not Required	-
3.1	15.407(a)	Maximum Conducted Output Power	Pass	-
-	15.407(a)	Power Spectral Density	Not Required	-
3.2	15.407(b)	Unwanted Emissions	Pass	Under limit 3.09 dB at 5350.080 MHz
-	15.207	AC Conducted Emission	Not Required	-
-	15.407(c)	Automatically Discontinue Transmission	Pass	-
3.3	15.203 15.407(a)	Antenna Requirement	Pass	-

**Remark:**

1. Not required means after assessing, test items are not necessary to carry out.
2. This is a variant report which can be referred Product Equality Declaration. All the test cases were performed on original report which can be referred to Sporton Report Number FR9D0635E. Based on the original report, only worst case was verified.

<b>Declaration of Conformity:</b>
The test results with all measurement uncertainty excluded are presented in accordance with the regulation limits or requirements declared by manufacturers.
<b>Comments and Explanations:</b>
The declared of product specification for EUT presented in the report are provided by the manufacturer, and the manufacturer takes all the responsibilities for the accuracy of product specification.

Reviewed by: Wii Chang

Report Producer: Fiona Wu



# 1 General Description

## 1.1 Product Feature of Equipment Under Test

Product Feature	
Equipment	Mobile Cellular Phone
Brand Name	Motorola
Model Name	XT2061-3
FCC ID	IHDT56YJ2
IMEI Code	<b>Conducted :</b> IMEI: 359124100005862 <b>Radiation :</b> IMEI: 359124100005433
EUT supports Radios application	CDMA/EV-DO/GSM/EGPRS/WCDMA/HSPA/LTE/5G NR/ GNSS/NFC/WPC WLAN 11b/g/n HT20 WLAN 11a/n HT20/HT40 WLAN 11ac VHT20/VHT40/VHT80 WLAN 11ax HE20/HE40/HE80 Bluetooth BR/EDR/LE
HW Version	DVT2
EUT Stage	Identical Prototype

Remark: The above EUT's information was declared by manufacturer.

Accessory List	
AC Adapter 1	Brand Name : Motorola
	Model Name : SC-51 (SA18C30116)
	Manufacturer : Chenyang
AC Adapter 2	Brand Name : Motorola
	Model Name : SC-51 (SA18C62985)
	Manufacturer : Acbel
Battery	Brand Name : ATL
	Model Name : LW50
USB Cable 1	Brand Name : Motorola
	Model Name : SC18C24367
	Manufacturer : Saibao
USB Cable 2	Brand Name : Motorola
	Model Name : SC18C24368
	Manufacturer : Luxshare



### 1.2 Product Specification of Equipment Under Test

Standards-related Product Specification	
<b>Tx/Rx Frequency Range</b>	5180 MHz ~ 5240 MHz 5260 MHz ~ 5320 MHz 5500 MHz ~ 5720 MHz
<b>Maximum Output Power to Antenna &lt;CDD Modes&gt;</b>	<p><b>&lt;5180 MHz ~ 5240 MHz&gt;</b></p> <p><b>&lt;Ant. 1&gt;</b>  802.11a : 16.60 dBm / 0.0457 W  802.11n HT20 : 16.40 dBm / 0.0437 W  802.11n HT40 : 16.20 dBm / 0.0417 W  802.11ac VHT20: 16.60 dBm / 0.0457 W  802.11ac VHT40: 16.30 dBm / 0.0427 W  802.11ac VHT80: 14.40 dBm / 0.0275 W  802.11ax HE20 : 16.20 dBm / 0.0417 W  802.11ax HE40 : 16.30 dBm / 0.0427 W  802.11ax HE80 : 14.00 dBm / 0.0251 W</p> <p><b>&lt;Ant. 2&gt;</b>  802.11a : 16.60 dBm / 0.0457 W  802.11n HT20 : 16.30 dBm / 0.0427 W  802.11n HT40 : 16.20 dBm / 0.0417 W  802.11ac VHT20: 16.50 dBm / 0.0447 W  802.11ac VHT40: 16.30 dBm / 0.0427 W  802.11ac VHT80: 14.70 dBm / 0.0295 W  802.11ax HE20 : 16.20 dBm / 0.0417 W  802.11ax HE40 : 16.30 dBm / 0.0427 W  802.11ax HE80 : 14.00 dBm / 0.0251 W</p> <p><b>MIMO &lt;Ant. 1 + 2&gt;</b>  802.11a : 19.66 dBm / 0.0925 W  802.11n HT20 : 19.58 dBm / 0.0908 W  802.11n HT40 : 19.21 dBm / 0.0834 W  802.11ac VHT20: 19.68 dBm / 0.0929 W  802.11ac VHT40: 19.31 dBm / 0.0853 W  802.11ac VHT80: 17.86 dBm / 0.0611 W  802.11ax HE20 : 19.48 dBm / 0.0887 W  802.11ax HE40 : 19.53 dBm / 0.0897 W  802.11ax HE80 : 17.47 dBm / 0.0558 W</p>



Standards-related Product Specification	
<b>Maximum Output Power to Antenna &lt;CDD Modes&gt;</b>	<b>&lt;5260 MHz ~ 5320 MHz&gt;</b>
	<b>&lt;Ant. 1&gt;</b>
	802.11a : 17.00 dBm / 0.0501 W
	802.11n HT20 : 16.30 dBm / 0.0427 W
	802.11n HT40 : 16.50 dBm / 0.0447 W
	802.11ac VHT20: 16.70 dBm / 0.0468 W
	802.11ac VHT40: 16.50 dBm / 0.0447 W
	802.11ac VHT80: 14.40 dBm / 0.0275 W
	802.11ax HE20 : 16.70 dBm / 0.0468 W
	802.11ax HE40 : 16.50 dBm / 0.0447 W
	802.11ax HE80 : 14.40 dBm / 0.0275 W
	<b>&lt;Ant. 2&gt;</b>
	802.11a : 17.00 dBm / 0.0501 W
	802.11n HT20 : 16.40 dBm / 0.0437 W
	802.11n HT40 : 16.50 dBm / 0.0447 W
	802.11ac VHT20: 16.70 dBm / 0.0468 W
	802.11ac VHT40: 16.50 dBm / 0.0447 W
	802.11ac VHT80: 15.00 dBm / 0.0316 W
	802.11ax HE20 : 16.70 dBm / 0.0468 W
	802.11ax HE40 : 16.30 dBm / 0.0427 W
802.11ax HE80 : 14.40 dBm / 0.0275 W	
<b>MIMO &lt;Ant. 1 + 2&gt;</b>	
802.11a : 20.16 dBm / 0.1038 W	
802.11n HT20 : 19.70 dBm / 0.0933 W	
802.11n HT40 : 19.70 dBm / 0.0933 W	
802.11ac VHT20: 19.80 dBm / 0.0955 W	
802.11ac VHT40: 19.80 dBm / 0.0955 W	
802.11ac VHT80: 18.07 dBm / 0.0641 W	
802.11ax HE20 : 19.74 dBm / 0.0942 W	
802.11ax HE40 : 19.37 dBm / 0.0865 W	
802.11ax HE80 : 17.41 dBm / 0.0551 W	



Standards-related Product Specification	
<p><b>Maximum Output Power to Antenna &lt;CDD Modes&gt;</b></p>	<p><b>&lt;5500 MHz ~ 5700 MHz&gt;</b>  <b>&lt;Ant. 1&gt;</b>            802.11a : 16.80 dBm / 0.0479 W            802.11n HT20 : 16.80 dBm / 0.0479 W            802.11n HT40 : 16.30 dBm / 0.0427 W            802.11ac VHT20: 16.90 dBm / 0.0490 W            802.11ac VHT40: 16.40 dBm / 0.0437 W            802.11ac VHT80: 16.50 dBm / 0.0447 W            802.11ax HE20 : 16.60 dBm / 0.0457 W            802.11ax HE40 : 16.50 dBm / 0.0447 W            802.11ax HE80 : 16.40 dBm / 0.0437 W  <b>&lt;Ant. 2&gt;</b>            802.11a : 16.80 dBm / 0.0479 W            802.11n HT20 : 16.40 dBm / 0.0437 W            802.11n HT40 : 16.20 dBm / 0.0417 W            802.11ac VHT20: 16.90 dBm / 0.0490 W            802.11ac VHT40: 16.40 dBm / 0.0437 W            802.11ac VHT80: 16.70 dBm / 0.0468 W            802.11ax HE20 : 16.60 dBm / 0.0457 W            802.11ax HE40 : 16.50 dBm / 0.0447 W            802.11ax HE80 : 16.40 dBm / 0.0437 W  <b>MIMO &lt;Ant. 1 + 2&gt;</b>            802.11a : 19.93 dBm / 0.0984 W            802.11n HT20 : 19.81 dBm / 0.0957 W            802.11n HT40 : 19.54 dBm / 0.0899 W            802.11ac VHT20: 20.01 dBm / 0.1002 W            802.11ac VHT40: 19.64 dBm / 0.0920 W            802.11ac VHT80: 19.83 dBm / 0.0962 W            802.11ax HE20 : 19.65 dBm / 0.0923 W            802.11ax HE40 : 19.65 dBm / 0.0923 W            802.11ax HE80 : 19.51 dBm / 0.0893 W</p>
<p><b>Maximum Output Power to Antenna &lt;TXBF Modes&gt;</b></p>	<p><b>&lt;5180 MHz ~ 5240 MHz&gt;</b>  <b>MIMO &lt;Ant. 1 + 2&gt;</b>            802.11ac VHT20: 19.11 dBm / 0.0815 W            802.11ac VHT40: 18.91 dBm / 0.0778 W            802.11ac VHT80: 19.26 dBm / 0.0843 W            802.11ax HE20 : 19.11 dBm / 0.0815 W            802.11ax HE40 : 18.96 dBm / 0.0787 W            802.11ax HE80 : 18.96 dBm / 0.0787 W</p>
<p><b>Type of Modulation</b></p>	<p>802.11a/n : OFDM (BPSK / QPSK / 16QAM / 64QAM)            802.11ac : OFDM (BPSK / QPSK / 16QAM / 64QAM / 256QAM)            802.11ax: OFDM (BPSK / QPSK / 16QAM / 64QAM / 256QAM / 1024QAM)</p>





Standards-related Product Specification														
<b>Antenna Type / Gain</b>	<5180 MHz ~ 5240 MHz> <b>Ant. 1</b> : ILA Antenna with gain 1.50 dBi <b>Ant. 2</b> : ILA Antenna with gain 1.30 dBi <5260 MHz ~ 5320 MHz> <b>Ant. 1</b> : ILA Antenna with gain 1.50 dBi <b>Ant. 2</b> : ILA Antenna with gain 1.30 dBi <5500 MHz ~ 5700 MHz > <b>Ant. 1</b> : ILA Antenna with gain 1.50 dBi <b>Ant. 2</b> : ILA Antenna with gain 1.30 dBi													
<b>Antenna Function Description</b>	<table border="1"><thead><tr><th></th><th>Ant. 1</th><th>Ant. 2</th></tr></thead><tbody><tr><td>802.11 a/n/ac/ax</td><td>V</td><td>V</td></tr><tr><td>802.11 a/n/ac/ax MIMO</td><td>V</td><td>V</td></tr><tr><td>802.11 ac/ax TXBF</td><td>V</td><td>V</td></tr></tbody></table>			Ant. 1	Ant. 2	802.11 a/n/ac/ax	V	V	802.11 a/n/ac/ax MIMO	V	V	802.11 ac/ax TXBF	V	V
	Ant. 1	Ant. 2												
802.11 a/n/ac/ax	V	V												
802.11 a/n/ac/ax MIMO	V	V												
802.11 ac/ax TXBF	V	V												

**Note:** MIMO Ant. 1+2 is a calculated result from sum of the power MIMO Ant. 1 and MIMO Ant. 2.

### 1.3 Modification of EUT

No modifications are made to the EUT during all test items.



### 1.4 Testing Location

<b>Test Site</b>	SPORTON INTERNATIONAL INC. EMC & Wireless Communications Laboratory	
<b>Test Site Location</b>	No.52, Huaya 1st Rd., Guishan Dist., Taoyuan City, Taiwan (R.O.C.) TEL: +886-3-327-3456 FAX: +886-3-328-4978	
<b>Test Site No.</b>	<b>Sporton Site No.</b>	
	TH05-HY	

**Note:** The test site complies with ANSI C63.4 2014 requirement.

<b>Test Site</b>	SPORTON INTERNATIONAL INC. EMC & Wireless Communications Laboratory	
<b>Test Site Location</b>	No.58, Aly. 75, Ln. 564, Wenhua 3rd, Rd., Guishan Dist., Taoyuan City, Taiwan (R.O.C.) TEL: +886-3-327-0868 FAX: +886-3-327-0855	
<b>Test Site No.</b>	<b>Sporton Site No.</b>	
	03CH11-HY	03CH13-HY

**Note:** The test site complies with ANSI C63.4 2014 requirement.

FCC designation No.: TW1190 and TW0007

### 1.5 Applicable Standards

According to the specifications of the manufacturer, the EUT must comply with the requirements of the following standards:

- ♦ FCC Part 15 Subpart E
- ♦ FCC KDB 789033 D02 General UNII Test Procedures New Rules v02r01.
- ♦ FCC KDB 414788 D01 Radiated Test Site v01r01.
- ♦ FCC KDB 662911 D01 Multiple Transmitter Output v02r01.
- ♦ ANSI C63.10-2013

**Remark:**

1. All test items were verified and recorded according to the standards and without any deviation during the test.
2. This EUT has also been tested and complied with the requirements of FCC Part 15, Subpart B, recorded in a separate test report.



## 2 Test Configuration of Equipment Under Test

The EUT has been associated with peripherals and configuration operated in a manner tended to maximize its emission characteristics in a typical application. Frequency range investigated: radiation emission (9 kHz to the 10th harmonic of the highest fundamental frequency or to 40 GHz, whichever is lower). For radiated measurement, pre-scanned in three orthogonal panels, X, Y, Z. The worst cases (Y plane for 802.11ac Mode; Z Plane for 802.11ax Mode ) were recorded in this report.

### 2.1 Carrier Frequency and Channel

Frequency Band	Channel	Freq. (MHz)	Channel	Freq. (MHz)
5150-5250 MHz Band 1 (U-NII-1)	36	5180	44	5220
	38*	5190	46*	5230
	40	5200	48	5240
	42 <sup>#</sup>	5210		

Frequency Band	Channel	Freq. (MHz)	Channel	Freq. (MHz)
5250-5350 MHz Band 2 (U-NII-2A)	52	5260	60	5300
	54*	5270	62*	5310
	56	5280	64	5320
	58 <sup>#</sup>	5290		

Frequency Band	Channel	Freq. (MHz)	Channel	Freq. (MHz)
5470-5725 MHz Band 3 (U-NII-2C)	100	5500	112	5560
	102*	5510	116	5580
	104	5520	132	5660
	106 <sup>#</sup>	5530	134*	5670
	108	5540	136	5680
	110*	5550	140	5700

Frequency Band	Channel	Freq. (MHz)	Channel	Freq. (MHz)
TDWR Channel	118*	5590	124	5620
	120	5600	126*	5630
	122 <sup>#</sup>	5610	128	5640

**Note:**

1. The above Frequency and Channel in "\*" were 802.11n HT40 and 802.11ac VHT40.
2. The above Frequency and Channel in "<sup>#</sup>" were 802.11ac VHT80.



## 2.2 Test Mode

Final test modes are considering the modulation and worse data rates as below table.

Modulation	Data Rate
802.11a	6 Mbps
802.11n HT20	MCS0
802.11n HT40	MCS0
802.11ac VHT20	MCS0
802.11ac VHT40	MCS0
802.11ac VHT80	MCS0
802.11ax HE20	MCS0
802.11ax HE40	MCS0
802.11ax HE80	MCS0

### TXBF Mode

Modulation	Data Rate
802.11ac VHT20	MCS0
802.11ac VHT40	MCS0
802.11ac VHT80	MCS0
802.11ax HE20	MCS0
802.11ax HE40	MCS0
802.11ax HE80	MCS0



Ch. #		Band I : 5150-5250 MHz	Band II : 5250-5350 MHz	Band III : 5470-5725MHz
		802.11ac VHT20	802.11ac VHT20	802.11ac VHT20
L	Low	-	-	-
M	Middle	-	-	-
H	High	-	-	140

Ch. #		Band I : 5150-5250 MHz	Band II : 5250-5350 MHz	Band III : 5470-5725MHz
		802.11ac VHT40	802.11ac VHT40	802.11ac VHT40
L	Low	-	54	-
M	Middle	-	-	-
H	High	-	-	-

Ch. #		Band I : 5150-5250 MHz	Band II : 5250-5350 MHz	Band III : 5470-5725MHz
		802.11ac VHT80	802.11ac VHT80	802.11ac VHT80
L	Low	-	-	-
M	Middle	42	-	-
H	High	-	-	-

Ch. #		Band I : 5150-5250 MHz	Band II : 5250-5350 MHz	Band III : 5470-5725MHz
		802.11ax HE40	802.11ax HE40	802.11ax HE40
L	Low	-	-	-
M	Middle	-	-	-
H	High	-	-	134

Ch. #		Band I : 5150-5250 MHz	Band II : 5250-5350 MHz	Band III : 5470-5725MHz
		802.11ax HE80	802.11ax HE80	802.11ax HE80
L	Low	-	-	-
M	Middle	-	58	-
H	High	-	-	-

Remark:

1. For radiation spurious emission, the final modulation and the worst data rate was reference the max RF conducted power.
2. For Radiated Test Cases, the tests were performed with Adapter 1 and USB Cable 1.

## 2.3 Connection Diagram of Test System

<WLAN Tx Mode>

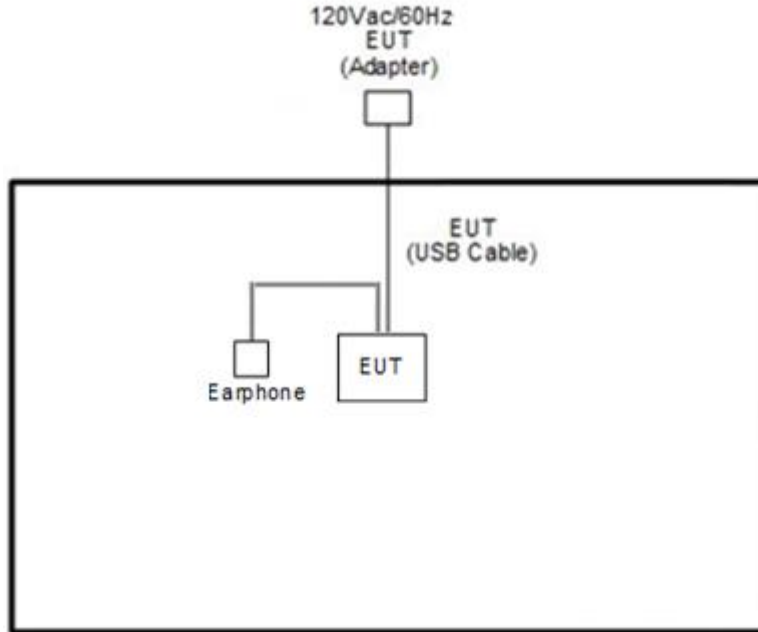

## 2.4 Support Unit used in test configuration

Item	Equipment	Trade Name	Model Name	FCC ID	Data Cable	Power Cord
1.	Earphone	Moto	NASH38C16618	N/A	Unshielded, 1.0 m	N/A

## 2.5 EUT Operation Test Setup

The RF test items, utility "QRCT v4.0.00142.0" was installed in Notebook which was programmed in order to make the EUT get into the engineering modes to provide channel selection, power level, data rate and the application type and for continuous transmitting signals.

For TXBF mode, the modulation modes and data rates manipulated by the command lines in the engineering program made the EUT link to another EUT by power under the normal operation. The "QRCT V4.0.00142.0" software tool was used to enable the EUT to transmit signals continuously.

Following shows an offset computation example with cable loss 4.2 dB and 10dB attenuator.



### 3 Test Result

#### 3.1 Maximum Conducted Output Power Measurement

##### 3.1.1 Limit of Maximum Conducted Output Power

<FCC 14-30 CFR 15.407>

**For the 5.15–5.25 GHz bands:**

- For mobile and portable client devices in the 5.15–5.25 GHz band, the maximum conducted output power over the frequency band of operation shall not exceed 250 mW. For an indoor access point operating in the band 5.15-5.25 GHz, the maximum conducted output power over the frequency band of operation shall not exceed 1 W.

**For the 5.25–5.725 GHz bands:**

- The maximum conducted output power over the frequency bands of operation shall not exceed the lesser of 250 mW or  $11 \text{ dBm} + 10 \log B$ , where B is the 26 dB emission bandwidth in megahertz.

For Straddle Channel, according to KDB 789033 D02 General UNII Test Procedures New Rules v02r01, if the power and PSD of the devices are uniform and comply with the lower limits specified for the U-NII-2 bands, a single measurement over the entire emission bandwidth can be performed to show compliance.

If transmitting antennas of directional gain greater than 6 dBi are used, the peak output power shall be reduced by the amount in dB that the directional gain of the antenna exceeds 6 dBi.

Note that U-NII-2 band, devices with a maximum e.i.r.p. greater than 500 mW shall implement TPC in order to have the capability to operate at least 6 dB below the maximum permitted e.i.r.p. of 1 W.

##### 3.1.2 Measuring Instruments

See list of measuring equipment of this test report.

### 3.1.3 Test Procedures

The testing follows Method PM-G of FCC KDB 789033 D02 General UNII Test Procedures New Rules v02r01.

Method PM-G (Measurement using an RF average power meter):

1. Measurement is performed using a wideband RF power meter.
2. The EUT is configured to transmit at its maximum power control level.
3. Measure the average power of the transmitter
4. Since the measurement is made only during the ON time of the transmitter, no duty cycle correction factor is required.

### 3.1.4 Test Setup

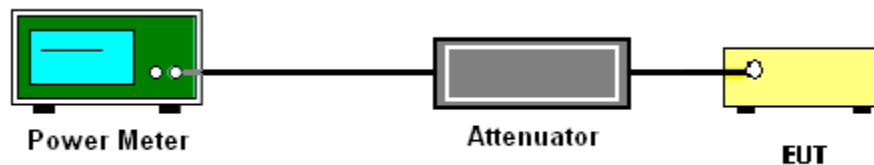

### 3.1.5 Test Result of Maximum Conducted Output Power

Please refer to Appendix A.





### 3.2 Unwanted Emissions Measurement

This section is to measure unwanted emissions through radiated measurement for band edge spurious emissions and out of band emissions measurement.

#### 3.2.1 Limit of Unwanted Emissions

- (1) For transmitters operating in the 5150-5250 MHz band: all emissions outside of the 5150-5350 MHz band shall not exceed an EIRP of -27dBm/MHz.

For transmitters operating in the 5250-5350 MHz band: all emissions outside of the 5150-5350 MHz band shall not exceed an EIRP of -27 dBm/MHz. Devices operating in the 5250-5350 MHz band that generate emissions in the 5150-5250 MHz band must meet all applicable technical requirements for operation in the 5150-5250 MHz band (including indoor use) or alternatively meet an out-of-band emission EIRP limit of -27 dBm/MHz in the 5150-5250 MHz band.

For transmitters operating in the 5470-5600 MHz and 5650-5725MHz band: all emissions outside of the 5470-5600 MHz and 5650-5725MHz band shall not exceed an EIRP of -27 dBm/MHz.

- (2) Unwanted spurious emissions fallen in restricted bands shall comply with the general field strength limits as below table:

Frequency (MHz)	Field Strength (microvolts/meter)	Measurement Distance (meters)
0.009 – 0.490	2400/F(kHz)	300
0.490 – 1.705	24000/F(kHz)	30
1.705 – 30.0	30	30
30 – 88	100	3
88 – 216	150	3
216 - 960	200	3
Above 960	500	3

**Note:** The following formula is used to convert the EIRP to field strength.

$$E = \frac{1000000\sqrt{30P}}{3} \mu\text{V/m, where P is the eirp (Watts)}$$



EIRP (dBm)	Field Strength at 3m (dB $\mu$ V/m)
- 27	68.3

(3) KDB789033 D02 v02r01 G)2)c)

- (i) Sections 15.407(b)(1-3) specifies the unwanted emissions limit for the U-NII-1 and U-NII-2 bands. As specified, emissions above 1000 MHz that are outside of the restricted bands are subject to a peak emission limit of -27 dBm/MHz.
- (ii) Section 15.407(b)(4) specifies the unwanted emissions limit for the U-NII-3 band. A band emissions mask is specified in Section 15.407(b)(4)(i). The emission limits are based on the use of a peak detector.

### 3.2.2 Measuring Instruments

See list of measuring equipment of this test report.

### 3.2.3 Test Procedures

1. The testing follows FCC KDB 789033 D02 General UNII Test Procedures New Rules v02r01. Section G) Unwanted emissions measurement.

(1) Procedure for Unwanted Emissions Measurements Below 1000MHz

- RBW = 120 kHz
- VBW = 300 kHz
- Detector = Peak
- Trace mode = max hold

(2) Procedure for Peak Unwanted Emissions Measurements Above 1000 MHz

- RBW = 1 MHz
- VBW  $\geq$  3 MHz
- Detector = Peak
- Sweep time = auto
- Trace mode = max hold



(3) Procedures for Average Unwanted Emissions Measurements Above 1000MHz

- RBW = 1 MHz
  - VBW = 10 Hz, when duty cycle is no less than 98 percent.
  - $VBW \geq 1/T$ , when duty cycle is less than 98 percent where T is the minimum transmission duration over which the transmitter is on and is transmitting at its maximum power control level for the tested mode of operation.
2. The EUT was placed on a turntable with 0.8 meter for frequency below 1GHz and 1.5 meter for frequency above 1GHz respectively above ground.
  3. The EUT was set 3 meters from the interference receiving antenna which was mounted on the top of a variable height antenna tower.
  4. The antenna is a broadband antenna and its height is adjusted between one meter and four meters above ground to find the maximum value of the field strength for both horizontal polarization and vertical polarization of the antenna.
  5. For each suspected emission, the EUT was arranged to its worst case and then adjust the antenna tower (from 1 m to 4 m) and turntable (from 0 degree to 360 degrees) to find the maximum reading.
  6. For testing below 1GHz, if the emission level of the EUT in peak mode was 3 dB lower than the limit specified, then peak values of EUT will be reported, otherwise, the emissions will be repeated one by one using the CISPR quasi-peak method and reported.
  7. For testing above 1GHz, the emission level of the EUT in peak mode was 20dB lower than average limit (that means the emission level in average mode also complies with the limit in average mode), then peak values of EUT will be reported, otherwise, the emissions will be measured in average mode again and reported.

### 3.2.4 Test Setup

For radiated emissions below 30MHz

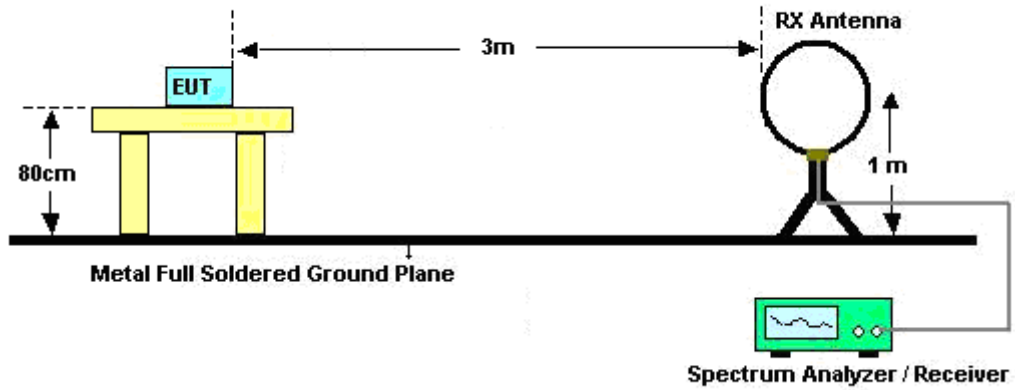

For radiated emissions from 30MHz to 1GHz

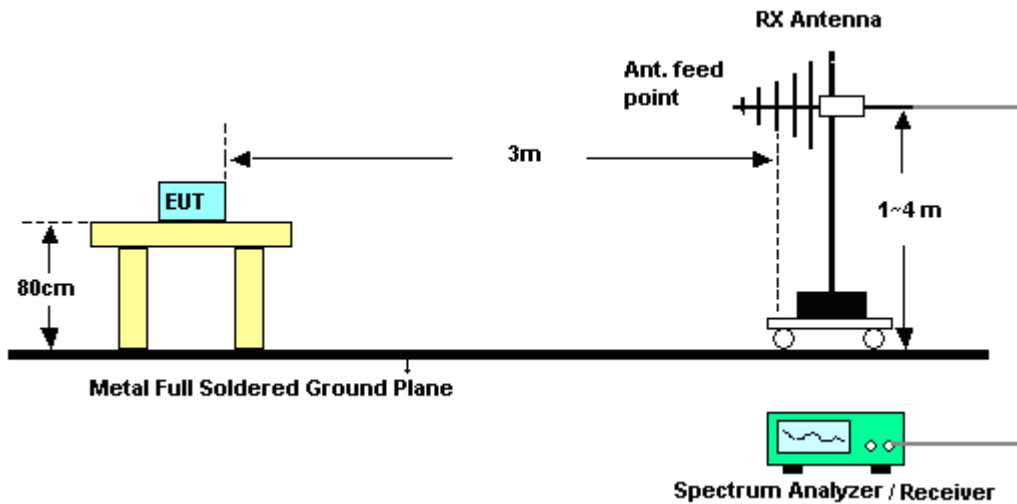

For radiated emissions above 1GHz

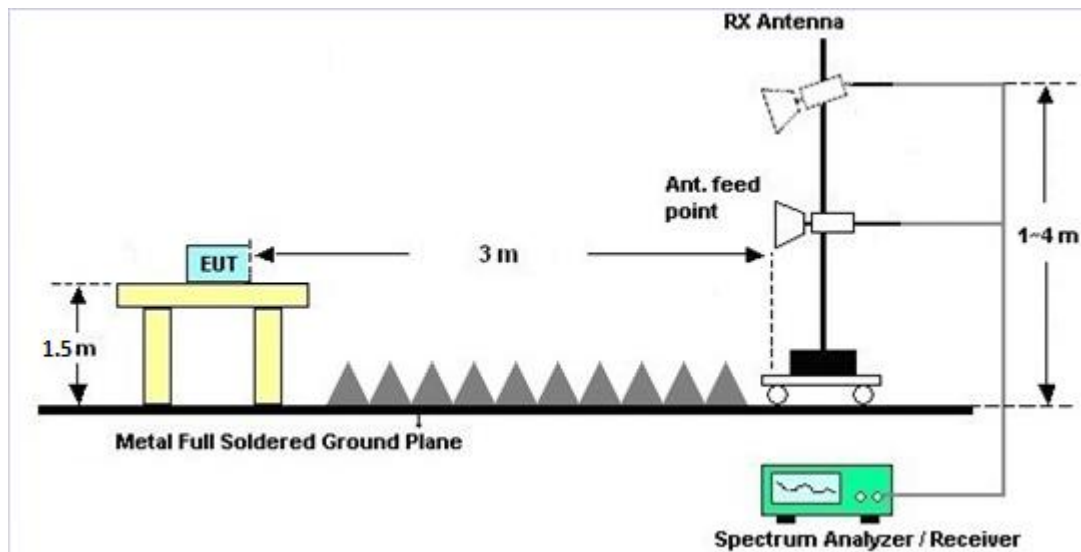

### 3.2.5 Test Results of Radiated Spurious Emissions (9 kHz ~ 30 MHz)

The low frequency, which started from 9 kHz to 30MHz, was pre-scanned and the result which was 20dB lower than the limit line was not reported.

There is a comparison data of both open-field test site and alternative test site - semi-Anechoic chamber according to 414788 D01 Radiated Test Site v01r01, and the result came out very similar.

### 3.2.6 Test Result of Radiated Spurious at Band Edges

Please refer to Appendix B and C.

### 3.2.7 Duty Cycle

Please refer to Appendix D.

### 3.2.8 Test Result of Radiated Spurious Emissions (30MHz ~ 10th Harmonic)

Please refer to Appendix B and C.



### 3.3 Antenna Requirements

#### 3.3.1 Standard Applicable

If transmitting antenna directional gain is greater than 6 dBi, both the peak transmit power and the peak power spectral density shall be reduced by the amount in dB that the directional gain of the antenna exceeds 6 dBi.

#### 3.3.2 Antenna Anti-Replacement Construction

An embedded-in antenna design is used.

#### 3.3.3 Antenna Gain

<CDD Modes >

FCC KDB 662911 D01 Multiple Transmitter Output v02r01

For CDD transmissions, directional gain is calculated as

Directional gain = GANT + Array Gain, where Array Gain is as follows.

For power spectral density (PSD) measurements on all devices,

Array Gain = 10 log(NANT/NSS=1) dB.

For power measurements on IEEE 802.11 devices,

Array Gain = 0 dB (i.e., no array gain) for NANT ≤ 4.

Directional gain may be calculated by using the formulas applicable to equal gain antennas with GANT set equal to the gain of the antenna having the highest gain;

The EUT supports CDD mode.

For power, the directional gain GANT is set equal to the antenna having the highest gain, i.e., F)2)f)i).

For PSD, the directional gain calculation is following F)2)f)ii) of KDB 662911 D01 v02r01.

The power and PSD limit should be modified if the directional gain of EUT is over 6 dBi,

The directional gain "DG" is calculated as following table.

<CDD Modes>						
			DG	DG	Power	PSD
			for	for	Limit	Limit
	Ant. 1	Ant. 2	Power	PSD	Reduction	Reduction
	(dBi)	(dBi)	(dBi)	(dBi)	(dB)	(dB)
Band I	1.50	1.30	1.50	4.41	0.00	0.00
Band II	1.50	1.30	1.50	4.41	0.00	0.00
Band III	1.50	1.30	1.50	4.41	0.00	0.00

Power limit reduction = Composite gain – 6dBi, ( min = 0 )

PSD limit reduction = Composite gain + PSD Array gain – 6dBi, ( min = 0 )

**TXBF modes**

FCC KDB 662911 D01 Multiple Transmitter Output v02r01

For CDD transmissions, directional gain is calculated as

$$DirectionalGain = 10 \cdot \log \left[ \frac{\sum_{j=1}^{N_{SS}} \left\{ \sum_{k=1}^{N_{ANT}} g_{j,k} \right\}^2}{N_{ANT}} \right]$$

where

Each antenna is driven by no more than one spatial stream;

$N_{SS}$  = the number of independent spatial streams of data;

$N_{ANT}$  = the total number of antennas

$g_{j,k} = 10^{G_k / 20}$  if the  $k$ th antenna is being fed by spatial stream  $j$ , or zero if it is not;  
 $G_k$  is the gain in dBi of the  $k$ th antenna.

The EUT supports beamforming for 802.11ac modes.

The directional gain calculation is following F)2)e)ii) of KDB 662911 D01 v02r01.

The power and PSD limit should be modified if the directional gain of EUT is over 6 dBi,

The directional gain “DG” is calculated as following table.

			DG	DG	Power	PSD
			for	for	Limit	Limit
	Ant 1	Ant 2	Power	PSD	Reduction	Reduction
	(dBi)	(dBi)	(dBi)	(dBi)	(dB)	(dB)
<b>Band I</b>	1.50	1.30	4.41	4.41	0.00	0.00
<b>Band II</b>	1.50	1.30	4.41	4.41	0.00	0.00
<b>Band III</b>	1.50	1.30	4.41	4.41	0.00	0.00

$Power\ Limit\ Reduction = DG(Power) - 6dBi, (min = 0)$

$PSD\ Limit\ Reduction = DG(PSD) - 6dBi, (min = 0)$



## 4 List of Measuring Equipment

Instrument	Manufacturer	Model No.	Serial No.	Characteristics	Calibration Date	Test Date	Due Date	Remark
Preamplifier	EMCE	EMC184045B	980192	18GHz ~ 40GHz	Aug. 01, 2019	Jan. 31, 2020~ Feb. 01, 2020	Jul. 31, 2020	Radiation (03CH11-HY)
Amplifier	SONOMA	310N	187312	9kHz~1GHz	Dec. 03, 2019	Jan. 31, 2020~ Feb. 01, 2020	Dec. 02, 2020	Radiation (03CH11-HY)
Bilog Antenna	TESEQ	CBL 6111D & N-6-06	35414 & AT-N0602	30MHz~1GHz	Oct. 12, 2019	Jan. 31, 2020~ Feb. 01, 2020	Oct. 11, 2020	Radiation (03CH11-HY)
Horn Antenna	SCHWARZBE CK	BBHA 9120 D	9120D-132 6	1GHz ~ 18GHz	Nov. 04, 2019	Jan. 31, 2020~ Feb. 01, 2020	Nov. 03, 2020	Radiation (03CH11-HY)
Loop Antenna	Rohde & Schwarz	HFH2-Z2	100488	9 kHz~30 MHz	Jan. 09, 2020	Jan. 31, 2020~ Feb. 01, 2020	Jan. 08, 2021	Radiation (03CH11-HY)
Preamplifier	Keysight	83017A	MY532700 80	1GHz~26.5GHz	Nov. 13, 2019	Jan. 31, 2020~ Feb. 01, 2020	Nov. 12, 2020	Radiation (03CH11-HY)
Spectrum Analyzer	Keysight	N9010A	MY542004 86	10Hz ~ 44GHz	Oct. 28, 2019	Jan. 31, 2020~ Feb. 01, 2020	Oct. 27, 2020	Radiation (03CH11-HY)
Controller	EMEC	EM 1000	N/A	Control Turn table & Ant Mast	N/A	Jan. 31, 2020~ Feb. 01, 2020	N/A	Radiation (03CH11-HY)
Antenna Mast	EMEC	AM-BS-4500- B	N/A	1~4m	N/A	Jan. 31, 2020~ Feb. 01, 2020	N/A	Radiation (03CH11-HY)
Turn Table	EMEC	TT 2000	N/A	0~360 Degree	N/A	Jan. 31, 2020~ Feb. 01, 2020	N/A	Radiation (03CH11-HY)
Preamplifier	Jet-Power	JPA00101800 -30-10P	160118000 2	1GHz~18GHz	Aug. 01, 2019	Jan. 31, 2020~ Feb. 01, 2020	Jul. 31, 2020	Radiation (03CH11-HY)
Preamplifier	Jet-Power	JAP00101800 -30-10P	160118550 004	1GHz~18GHz	Apr. 16, 2019	Jan. 31, 2020~ Feb. 01, 2020	Apr. 15, 2020	Radiation (03CH11-HY)
SHF-EHF Horn Antenna	SCHWARZBE CK	BBHA 9170	BBHA9170 576	18GHz- 40GHz	May 14, 2019	Jan. 31, 2020~ Feb. 01, 2020	May 13, 2020	Radiation (03CH11-HY)
EMI Test Receiver	Keysight	N9038A(MXE )	MY554201 70	20MHz~8.4GHz	Mar. 08, 2019	Jan. 31, 2020~ Feb. 01, 2020	Mar. 07, 2020	Radiation (03CH11-HY)
Software	Audix	E3 6.2009-8-24	RK-00105 3	N/A	N/A	Jan. 31, 2020~ Feb. 01, 2020	N/A	Radiation (03CH11-HY)
RF Cable	HUBER + SUHNER	SUCOFLEX 104	MY9837/4 PE	9kHz-30MHz	Mar. 13, 2019	Jan. 31, 2020~ Feb. 01, 2020	Mar. 12, 2020	Radiation (03CH11-HY)
RF Cable	HUBER + SUHNER	SUCOFLEX 102	MY2859/2	30MHz-40GHz	Mar. 13, 2019	Jan. 31, 2020~ Feb. 01, 2020	Mar. 12, 2020	Radiation (03CH11-HY)
RF Cable	HUBER + SUHNER	SUCOFLEX 104	MY9837/4 PE	30M-18G	Mar. 13, 2019	Jan. 31, 2020~ Feb. 01, 2020	Mar. 12, 2020	Radiation (03CH11-HY)
RF Cable	HUBER + SUHNER	SUCOFLEX 102	MY4274/2	30MHz-40GHz	Mar. 13, 2019	Jan. 31, 2020~ Feb. 01, 2020	Mar. 12, 2020	Radiation (03CH11-HY)
Filter	Wainwright	WLK4-1000-1 530-8000-40S S	SN11	1.53G Low Pass	Sep. 15, 2019	Jan. 31, 2020~ Feb. 01, 2020	Sep. 14, 2020	Radiation (03CH11-HY)
Filter	Wainwright	WHKX8-5872. 5-6750-18000 -40SS	SN3	6.75GHz High Pass	Sep. 16, 2019	Jan. 31, 2020~ Feb. 01, 2020	Sep. 15, 2020	Radiation (03CH11-HY)
Hygrometer	TECPEL	DTN-303B	TP140325	N/A	Nov. 07, 2019	Jan. 31, 2020~ Feb. 01, 2020	Nov. 06, 2020	Radiation (03CH11-HY)





Instrument	Manufacturer	Model No.	Serial No.	Characteristics	Calibration Date	Test Date	Due Date	Remark
Loop Antenna	Rohde & Schwarz	HFH2-Z2	100488	9 kHz~30 MHz	Jan. 09, 2020	Feb. 23, 2020~ Feb. 25, 2020	Jan. 08, 2021	Radiation (03CH13-HY)
Horn Antenna	SCHWARZBECK	BBHA 9120 D	9120D-124 1	1GHz ~ 18GHz	Jul. 02, 2019	Feb. 23, 2020~ Feb. 25, 2020	Jul. 01, 2020	Radiation (03CH13-HY)
Bilog Antenna	TESEQ	CBL 6111D&00800 N1D01N-06	40103 & 07	30MHz~1GHz	Apr. 30, 2019	Feb. 23, 2020~ Feb. 25, 2020	Apr. 29, 2020	Radiation (03CH13-HY)
SHF-EHF Horn Antenna	SCHWARZBECK	BBHA 9170	BBHA9170 576	18GHz- 40GHz	May 14, 2019	Feb. 23, 2020~ Feb. 25, 2020	May 13, 2020	Radiation (03CH13-HY)
Preamplifier	Keysight	83017A	MY532701 47	1GHz~26.5GHz	Mar. 15, 2019	Feb. 23, 2020~ Feb. 25, 2020	Mar. 14, 2020	Radiation (03CH13-HY)
Preamplifier	MITEQ	AMF-7D-0010 1800-30-10P	1590074	1GHz~18GHz	May 20, 2019	Feb. 23, 2020~ Feb. 25, 2020	May 19, 2020	Radiation (03CH13-HY)
Amplifier	Sonoma-Instrument	310 N	187282	9KHz~1GHz	Dec. 17, 2019	Feb. 23, 2020~ Feb. 25, 2020	Dec. 16, 2020	Radiation (03CH13-HY)
Preamplifier	EMEC	EM18G40G	060715	18GHz ~ 40GHz	Dec. 13, 2019	Feb. 23, 2020~ Feb. 25, 2020	Dec. 12, 2020	Radiation (03CH13-HY)
Hygrometer	TECPEL	DTM-303B	TP150115	N/A	Nov. 08, 2019	Feb. 23, 2020~ Feb. 25, 2020	Nov. 07, 2020	Radiation (03CH13-HY)
RF Cable	HUBER + SUHNER	SUCOFLEX 126E	0030/126E	30M-18G	Feb. 12, 2020	Feb. 23, 2020~ Feb. 25, 2020	Feb. 11, 2021	Radiation (03CH13-HY)
RF Cable	HUBER + SUHNER	SUCOFLEX 104	804793/4	30M-18G	Feb. 12, 2020	Feb. 23, 2020~ Feb. 25, 2020	Feb. 11, 2021	Radiation (03CH13-HY)
RF Cable	HUBER + SUHNER	SUCOFLEX 104	MY24961/ 4	30M-18G	Feb. 12, 2020	Feb. 23, 2020~ Feb. 25, 2020	Feb. 11, 2021	Radiation (03CH13-HY)
RF Cable	HUBER + SUHNER	SUCOFLEX 102	MY2859/2	30M~40GHz	Mar. 13, 2019	Feb. 23, 2020~ Feb. 25, 2020	Mar. 12, 2020	Radiation (03CH13-HY)
RF Cable	HUBER + SUHNER	SUCOFLEX 102	MY4274/2	30M~40GHz	Mar. 13, 2019	Feb. 23, 2020~ Feb. 25, 2020	Mar. 12, 2020	Radiation (03CH13-HY)
Spectrum Analyzer	Keysight	N9010A	MY553705 26	10Hz~44GHz	Mar. 19, 2019	Feb. 23, 2020~ Feb. 25, 2020	Mar. 18, 2020	Radiation (03CH13-HY)
Controller	EMEC	EM1000	N/A	Control Turn table & Ant Mast	N/A	Feb. 23, 2020~ Feb. 25, 2020	N/A	Radiation (03CH13-HY)
Antenna Mast	EMEC	AM-BS-4500- B	N/A	1m~4m	N/A	Feb. 23, 2020~ Feb. 25, 2020	N/A	Radiation (03CH13-HY)
Turn Table	EMEC	TT2000	N/A	0~360 Degree	N/A	Feb. 23, 2020~ Feb. 25, 2020	N/A	Radiation (03CH13-HY)
Software	AUDIX	E3 6.2009-8-24c	RK-001124	N/A	N/A	Feb. 23, 2020~ Feb. 25, 2020	N/A	Radiation (03CH13-HY)
EMI Test Receiver	Keysight	N9038A(MXE )	MY541300 85	20Hz ~ 8.4GHz	Nov. 01, 2019	Feb. 23, 2020~ Feb. 25, 2020	Oct. 31, 2020	Radiation (03CH13-HY)
Filter	Wainwright	WHKX12-270 0-3000-18000 -60SS	SN2	3GHz High Pass Filter	Jul. 14, 2019	Feb. 23, 2020~ Feb. 25, 2020	Jul. 13, 2020	Radiation (03CH13-HY)



Instrument	Manufacturer	Model No.	Serial No.	Characteristics	Calibration Date	Test Date	Due Date	Remark
Filter	Wainwright	WLK4-1000-1530-8000-40S S	SN12	1.53GHz Low Pass Filter	Sep. 16, 2019	Feb. 23, 2020~ Feb. 25, 2020	Sep. 15, 2020	Radiation (03CH13-HY)
Filter	Wainwright	WHKX8-5872.5-6750-18000-40ST	SN5	6.75GHz High Pass Filter	Mar. 13, 2019	Feb. 23, 2020~ Feb. 25, 2020	Mar. 12, 2020	Radiation (03CH13-HY)
Hygrometer	Testo	608-H2	41410069	N/A	Jun. 17, 2019	Feb. 13, 2020~ Feb. 27, 2020	Jun. 16, 2020	Conducted (TH05-HY)
Power Sensor	DARE	RPR3006W	16I00054S NO10	10MHz~6GHz	Dec. 23, 2019	Feb. 13, 2020~ Feb. 27, 2020	Dec. 22, 2020	Conducted (TH05-HY)
Signal Analyzer	Rohde & Schwarz	FSV40	101566	10Hz~40GHz	Jul. 15, 2019	Feb. 13, 2020~ Feb. 27, 2020	Jul. 14, 2020	Conducted (TH05-HY)
Power Supply	GW Instek	SPS-606	GES84293 1	NA	Aug. 19, 2019	Feb. 13, 2020~ Feb. 27, 2020	Aug. 18, 2020	Conducted (TH05-HY)
Switch Box & RF Cable	Burgeon	ETF-058	EC120838 2	N/A	Mar. 27, 2019	Feb. 13, 2020~ Feb. 27, 2020	Mar. 26, 2020	Conducted (TH05-HY)



## 5 Uncertainty of Evaluation

<For 03CH11-HY>

### Uncertainty of Radiated Emission Measurement (30 MHz ~ 1000 MHz)

Measuring Uncertainty for a Level of Confidence of 95% (U = 2Uc(y))	5.20
---	------

### Uncertainty of Radiated Emission Measurement (1000 MHz ~ 18000 MHz)

Measuring Uncertainty for a Level of Confidence of 95% (U = 2Uc(y))	5.20
---	------

### Uncertainty of Radiated Emission Measurement (18000 MHz ~ 40000 MHz)

Measuring Uncertainty for a Level of Confidence of 95% (U = 2Uc(y))	3.12
---	------

<For 03CH13-HY>

### Uncertainty of Radiated Emission Measurement (30 MHz ~ 1000 MHz)

Measuring Uncertainty for a Level of Confidence of 95% (U = 2Uc(y))	4.40
---	------

### Uncertainty of Radiated Emission Measurement (1000 MHz ~ 18000 MHz)

Measuring Uncertainty for a Level of Confidence of 95% (U = 2Uc(y))	5.50
---	------

### Uncertainty of Radiated Emission Measurement (18000 MHz ~ 40000 MHz)

Measuring Uncertainty for a Level of Confidence of 95% (U = 2Uc(y))	4.80
---	------

**Appendix A. Test Result of Conducted Test Items****<CDD Mode>**

Test Engineer:	Kathy Chen	Temperature:	21~25	°C
Test Date:	2020/2/13 ~2/14	Relative Humidity:	51~54	%

**TEST RESULTS DATA**  
**Average Power Table**

FCC Band I single antenna													
Mod.	Data Rate	NTX	CH.	Freq. (MHz)	Average Conducted Power (dBm)			FCC Conducted Power Limit (dBm)		DG (dBi)			Pass/Fail
					Ant 1	Ant 2	SUM	Ant 1	Ant 2	Ant 1	Ant 2		
11a	6Mbps	1	36	5180	16.60	16.60		24.00	24.00	1.50	1.30		Pass
11a	6Mbps	1	44	5220	16.60	16.60		24.00	24.00	1.50	1.30		Pass
11a	6Mbps	1	48	5240	16.60	16.60		24.00	24.00	1.50	1.30		Pass
HT20	MCS0	1	36	5180	16.20	16.30		24.00	24.00	1.50	1.30		Pass
HT20	MCS0	1	44	5220	16.40	16.30		24.00	24.00	1.50	1.30		Pass
HT20	MCS0	1	48	5240	16.20	16.10		24.00	24.00	1.50	1.30		Pass
HT40	MCS0	1	38	5190	15.00	14.90		24.00	24.00	1.50	1.30		Pass
HT40	MCS0	1	46	5230	16.20	16.20		24.00	24.00	1.50	1.30		Pass
VHT20	MCS0	1	36	5180	16.60	16.50		24.00	24.00	1.50	1.30		Pass
VHT20	MCS0	1	44	5220	16.60	16.50		24.00	24.00	1.50	1.30		Pass
VHT20	MCS0	1	48	5240	16.30	16.30		24.00	24.00	1.50	1.30		Pass
VHT40	MCS0	1	38	5190	15.10	15.00		24.00	24.00	1.50	1.30		Pass
VHT40	MCS0	1	46	5230	16.30	16.30		24.00	24.00	1.50	1.30		Pass
VHT80	MCS0	1	42	5210	14.40	14.70		24.00	24.00	1.50	1.30		Pass

FCC Band I MIMO													
Mod.	Data Rate	NTX	CH.	Freq. (MHz)	Average Conducted Power (dBm)			FCC Conducted Power Limit (dBm)		DG (dBi)			Pass/Fail
					Ant 1	Ant 2	SUM	Ant 1	Ant 2	Ant 1	Ant 2		
11a	6Mbps	2	36	5180	16.50	16.80	19.66	24.00		1.50			Pass
11a	6Mbps	2	44	5220	16.70	16.60	19.66	24.00		1.50			Pass
11a	6Mbps	2	48	5240	16.70	16.60	19.66	24.00		1.50			Pass
HT20	MCS0	2	36	5180	16.40	16.40	19.41	24.00		1.50			Pass
HT20	MCS0	2	44	5220	17.00	16.10	19.58	24.00		1.50			Pass
HT20	MCS0	2	48	5240	16.80	15.90	19.38	24.00		1.50			Pass
HT40	MCS0	2	38	5190	15.70	15.30	18.51	24.00		1.50			Pass
HT40	MCS0	2	46	5230	16.40	16.00	19.21	24.00		1.50			Pass
VHT20	MCS0	2	36	5180	16.80	16.50	19.66	24.00		1.50			Pass
VHT20	MCS0	2	44	5220	17.10	16.20	19.68	24.00		1.50			Pass
VHT20	MCS0	2	48	5240	16.90	16.00	19.48	24.00		1.50			Pass
VHT40	MCS0	2	38	5190	15.70	15.30	18.51	24.00		1.50			Pass
VHT40	MCS0	2	46	5230	16.50	16.10	19.31	24.00		1.50			Pass
VHT80	MCS0	2	42	5210	14.90	14.80	17.86	24.00		1.50			Pass

**TEST RESULTS DATA**  
**Average Power Table**

FCC Band II single antenna													
Mod.	Data Rate	NTX	CH.	Freq. (MHz)	Average Conducted Power (dBm)			FCC Conducted Power Limit (dBm)		DG (dBi)		EIRP Power Limit (dBm)	Pass/Fail
					Ant 1	Ant 2	SUM	Ant 1	Ant 2	Ant 1	Ant 2		
11a	6Mbps	1	52	5260	16.80	16.80		23.98	23.98	1.50	1.30	30	Pass
11a	6Mbps	1	60	5300	17.00	17.00		23.98	23.98	1.50	1.30	30	Pass
11a	6Mbps	1	64	5320	17.00	17.00		23.98	23.98	1.50	1.30	30	Pass
HT20	MCS0	1	52	5260	16.20	16.40		23.98	23.98	1.50	1.30	30	Pass
HT20	MCS0	1	60	5300	16.30	16.40		23.98	23.98	1.50	1.30	30	Pass
HT20	MCS0	1	64	5320	16.30	16.40		23.98	23.98	1.50	1.30	30	Pass
HT40	MCS0	1	54	5270	16.30	16.50		23.98	23.98	1.50	1.30	30	Pass
HT40	MCS0	1	62	5310	16.50	16.50		23.98	23.98	1.50	1.30	30	Pass
VHT20	MCS0	1	52	5260	16.50	16.50		23.98	23.98	1.50	1.30	30	Pass
VHT20	MCS0	1	60	5300	16.60	16.70		23.98	23.98	1.50	1.30	30	Pass
VHT20	MCS0	1	64	5320	16.70	16.70		23.98	23.98	1.50	1.30	30	Pass
VHT40	MCS0	1	54	5270	16.40	16.60		23.98	23.98	1.50	1.30	30	Pass
VHT40	MCS0	1	62	5310	16.50	16.50		23.98	23.98	1.50	1.30	30	Pass
VHT80	MCS0	1	58	5290	14.40	15.00		23.98	23.98	1.50	1.30	30	Pass

FCC Band II MIMO													
Mod.	Data Rate	NTX	CH.	Freq. (MHz)	Average Conducted Power (dBm)			FCC Conducted Power Limit (dBm)		DG (dBi)		EIRP Power Limit (dBm)	Pass/Fail
					Ant 1	Ant 2	SUM	Ant 1	Ant 2	Ant 1	Ant 2		
11a	6Mbps	2	52	5260	16.80	16.80	19.81	23.98		1.50		30	Pass
11a	6Mbps	2	60	5300	17.20	17.10	20.16	23.98		1.50		30	Pass
11a	6Mbps	2	64	5320	17.30	17.00	20.16	23.98		1.50		30	Pass
HT20	MCS0	2	52	5260	17.00	16.10	19.58	23.98		1.50		30	Pass
HT20	MCS0	2	60	5300	17.20	16.10	19.70	23.98		1.50		30	Pass
HT20	MCS0	2	64	5320	17.20	16.10	19.70	23.98		1.50		30	Pass
HT40	MCS0	2	54	5270	17.20	16.10	19.70	23.98		1.50		30	Pass
HT40	MCS0	2	62	5310	16.40	15.60	19.03	23.98		1.50		30	Pass
VHT20	MCS0	2	52	5260	17.10	16.20	19.68	23.98		1.50		30	Pass
VHT20	MCS0	2	60	5300	17.30	16.20	19.80	23.98		1.50		30	Pass
VHT20	MCS0	2	64	5320	17.30	16.20	19.80	23.98		1.50		30	Pass
VHT40	MCS0	2	54	5270	17.30	16.20	19.80	23.98		1.50		30	Pass
VHT40	MCS0	2	62	5310	16.50	15.70	19.13	23.98		1.50		30	Pass
VHT80	MCS0	2	58	5290	15.30	14.80	18.07	23.98		1.50		30	Pass

**TEST RESULTS DATA**  
**Average Power Table**

FCC Band III single antenna													
Mod.	Data Rate	NTX	CH.	Freq. (MHz)	Average Conducted Power (dBm)			FCC Conducted Power Limit (dBm)		DG (dBi)		EIRP Power Limit (dBm)	Pass/Fail
					Ant 1	Ant 2	SUM	Ant 1	Ant 2	Ant 1	Ant 2		
11a	6Mbps	1	100	5500	16.70	16.80		23.98	23.98	1.50	1.30	30	Pass
11a	6Mbps	1	116	5580	16.80	16.80		23.98	23.98	1.50	1.30	30	Pass
11a	6Mbps	1	140	5700	15.60	15.60		23.98	23.98	1.50	1.30	30	Pass
HT20	MCS0	1	100	5500	16.30	16.30		23.98	23.98	1.50	1.30	30	Pass
HT20	MCS0	1	116	5580	16.40	16.20		23.98	23.98	1.50	1.30	30	Pass
HT20	MCS0	1	140	5700	16.80	16.40		23.98	23.98	1.50	1.30	30	Pass
HT40	MCS0	1	102	5510	16.10	16.20		23.98	23.98	1.50	1.30	30	Pass
HT40	MCS0	1	110	5550	16.30	16.20		23.98	23.98	1.50	1.30	30	Pass
HT40	MCS0	1	134	5670	16.00	16.20		23.98	23.98	1.50	1.30	30	Pass
VHT20	MCS0	1	100	5500	16.60	16.60		23.98	23.98	1.50	1.30	30	Pass
VHT20	MCS0	1	116	5580	16.70	16.60		23.98	23.98	1.50	1.30	30	Pass
VHT20	MCS0	1	140	5700	16.90	16.90		23.98	23.98	1.50	1.30	30	Pass
VHT40	MCS0	1	102	5510	16.20	16.30		23.98	23.98	1.50	1.30	30	Pass
VHT40	MCS0	1	110	5550	16.40	16.30		23.98	23.98	1.50	1.30	30	Pass
VHT40	MCS0	1	134	5670	16.10	16.40		23.98	23.98	1.50	1.30	30	Pass
VHT80	MCS0	1	106	5530	15.90	15.90		23.98	23.98	1.50	1.30	30	Pass
VHT80	MCS0	1	122	5610	16.50	16.70		23.98	23.98	1.50	1.30	30	Pass

FCC Band III MIMO													
Mod.	Data Rate	NTX	CH.	Freq. (MHz)	Average Conducted Power (dBm)			FCC Conducted Power Limit (dBm)		DG (dBi)		EIRP Power Limit (dBm)	Pass/Fail
					Ant 1	Ant 2	SUM	Ant 1	Ant 2	Ant 1	Ant 2		
11a	6Mbps	2	100	5500	17.00	16.80	19.91	23.98		1.50		30	Pass
11a	6Mbps	2	116	5580	17.30	16.50	19.93	23.98		1.50		30	Pass
11a	6Mbps	2	140	5700	15.80	15.50	18.66	23.98		1.50		30	Pass
HT20	MCS0	2	100	5500	17.00	16.00	19.54	23.98		1.50		30	Pass
HT20	MCS0	2	116	5580	17.20	15.90	19.61	23.98		1.50		30	Pass
HT20	MCS0	2	140	5700	17.40	16.10	19.81	23.98		1.50		30	Pass
HT40	MCS0	2	102	5510	16.90	16.10	19.53	23.98		1.50		30	Pass
HT40	MCS0	2	110	5550	17.00	16.00	19.54	23.98		1.50		30	Pass
HT40	MCS0	2	134	5670	16.90	15.70	19.35	23.98		1.50		30	Pass
VHT20	MCS0	2	100	5500	17.20	16.20	19.74	23.98		1.50		30	Pass
VHT20	MCS0	2	116	5580	17.40	16.10	19.81	23.98		1.50		30	Pass
VHT20	MCS0	2	140	5700	17.60	16.30	20.01	23.98		1.50		30	Pass
VHT40	MCS0	2	102	5510	17.00	16.20	19.63	23.98		1.50		30	Pass
VHT40	MCS0	2	110	5550	17.10	16.10	19.64	23.98		1.50		30	Pass
VHT40	MCS0	2	134	5670	17.00	15.80	19.45	23.98		1.50		30	Pass
VHT80	MCS0	2	106	5530	16.00	15.80	18.91	23.98		1.50		30	Pass
VHT80	MCS0	2	122	5610	17.20	16.40	19.83	23.98		1.50		30	Pass

**TEST RESULTS DATA**  
**Average Power Table**

FCC Band I single antenna													
Mod.	Data Rate	NTX	CH.	Freq. (MHz)	RU Config	Average Conducted Power (dBm)			FCC Conducted Power Limit (dBm)		DG (dBi)		Pass/Fail
						Ant 1	Ant 2	SUM	Ant 1	Ant 2	Ant 1	Ant 2	
HE20	MCS0	1	36	5180	Full	15.80	15.80		24.00	24.00	1.50	1.30	Pass
HE20	MCS0	1	36	5180	26/0	9.10	9.10		24.00	24.00	1.50	1.30	Pass
HE20	MCS0	1	36	5180	52/37	10.90	10.70		24.00	24.00	1.50	1.30	Pass
HE20	MCS0	1	36	5180	106/53	14.50	14.40		24.00	24.00	1.50	1.30	Pass
HE20	MCS0	1	44	5220	Full	16.00	16.00		24.00	24.00	1.50	1.30	Pass
HE20	MCS0	1	48	5240	Full	16.20	16.20		24.00	24.00	1.50	1.30	Pass
HE40	MCS0	1	38	5190	Full	14.40	14.40		24.00	24.00	1.50	1.30	Pass
HE40	MCS0	1	38	5190	242/61	14.40	14.30		24.00	24.00	1.50	1.30	Pass
HE40	MCS0	1	46	5230	Full	16.30	16.30		24.00	24.00	1.50	1.30	Pass
HE80	MCS0	1	42	5210	Full	14.00	14.00		24.00	24.00	1.50	1.30	Pass
HE80	MCS0	1	42	5210	484/65	13.70	13.70		24.00	24.00	1.50	1.30	Pass

FCC Band I MIMO													
Mod.	Data Rate	NTX	CH.	Freq. (MHz)	RU Config	Average Conducted Power (dBm)			FCC Conducted Power Limit (dBm)		DG (dBi)		Pass/Fail
						Ant 1	Ant 2	SUM	Ant 1	Ant 2	Ant 1	Ant 2	
HE20	MCS0	2	36	5180	Full	16.40	15.70	19.07	24.00	24.00	1.50	1.50	Pass
HE20	MCS0	2	36	5180	26/0	10.10	9.70	12.91	24.00	24.00	1.50	1.50	Pass
HE20	MCS0	2	36	5180	52/37	11.60	11.50	14.56	24.00	24.00	1.50	1.50	Pass
HE20	MCS0	2	36	5180	106/53	15.20	15.60	18.41	24.00	24.00	1.50	1.50	Pass
HE20	MCS0	2	44	5220	Full	16.90	16.00	19.48	24.00	24.00	1.50	1.50	Pass
HE20	MCS0	2	48	5240	Full	16.70	15.80	19.28	24.00	24.00	1.50	1.50	Pass
HE40	MCS0	2	38	5190	Full	15.40	14.60	18.03	24.00	24.00	1.50	1.50	Pass
HE40	MCS0	2	38	5190	242/61	15.40	14.60	18.03	24.00	24.00	1.50	1.50	Pass
HE40	MCS0	2	46	5230	Full	16.90	16.10	19.53	24.00	24.00	1.50	1.50	Pass
HE80	MCS0	2	42	5210	Full	14.70	14.20	17.47	24.00	24.00	1.50	1.50	Pass
HE80	MCS0	2	42	5210	484/65	14.40	14.30	17.36	24.00	24.00	1.50	1.50	Pass



**TEST RESULTS DATA**  
**Average Power Table**

FCC Band II single antenna														
Mod.	Data Rate	NTX	CH.	Freq. (MHz)	RU Config	Average Conducted Power (dBm)			FCC Conducted Power Limit (dBm)		DG (dBi)		EIRP Power Limit (dBm)	Pass/Fail
						Ant 1	Ant 2	SUM	Ant 1	Ant 2	Ant 1	Ant 2		
HE20	MCS0	1	52	5260	Full	16.40	16.40		23.98	23.98	1.50	1.30	30	Pass
HE20	MCS0	1	60	5300	Full	16.70	16.70		23.98	23.98	1.50	1.30	30	Pass
HE20	MCS0	1	64	5320	Full	16.40	16.40		23.98	23.98	1.50	1.30	30	Pass
HE20	MCS0	1	64	5320	26/8	9.40	9.40		23.98	23.98	1.50	1.30	30	Pass
HE20	MCS0	1	64	5320	52/40	11.40	11.40		23.98	23.98	1.50	1.30	30	Pass
HE20	MCS0	1	64	5320	106/54	14.40	14.40		23.98	23.98	1.50	1.30	30	Pass
HE40	MCS0	1	54	5270	Full	16.30	16.30		23.98	23.98	1.50	1.30	30	Pass
HE40	MCS0	1	54	5270	242/62	16.20	16.20		23.98	23.98	1.50	1.30	30	Pass
HE40	MCS0	1	62	5310	Full	15.10	15.10		23.98	23.98	1.50	1.30	30	Pass
HE40	MCS0	1	62	5310	242/62	16.50	16.10		23.98	23.98	1.50	1.30	30	Pass
HE80	MCS0	1	58	5290	Full	14.40	14.40		23.98	23.98	1.50	1.30	30	Pass
HE80	MCS0	1	58	5290	484/66	14.20	14.20		23.98	23.98	1.50	1.30	30	Pass

FCC Band II MIMO														
Mod.	Data Rate	NTX	CH.	Freq. (MHz)	RU Config	Average Conducted Power (dBm)			FCC Conducted Power Limit (dBm)		DG (dBi)		EIRP Power Limit (dBm)	Pass/Fail
						Ant 1	Ant 2	SUM	Ant 1	Ant 2	Ant 1	Ant 2		
HE20	MCS0	2	52	5260	Full	16.80	16.00	19.43	23.98		1.50		30	Pass
HE20	MCS0	2	60	5300	Full	17.20	16.20	19.74	23.98		1.50		30	Pass
HE20	MCS0	2	64	5320	Full	17.00	15.80	19.45	23.98		1.50		30	Pass
HE20	MCS0	2	64	5320	26/8	9.90	9.20	12.57	23.98		1.50		30	Pass
HE20	MCS0	2	64	5320	52/40	12.00	11.30	14.67	23.98		1.50		30	Pass
HE20	MCS0	2	64	5320	106/54	15.20	14.20	17.74	23.98		1.50		30	Pass
HE40	MCS0	2	54	5270	Full	16.60	16.10	19.37	23.98		1.50		30	Pass
HE40	MCS0	2	54	5270	242/62	16.50	16.00	19.27	23.98		1.50		30	Pass
HE40	MCS0	2	62	5310	Full	15.50	14.70	18.13	23.98		1.50		30	Pass
HE40	MCS0	2	62	5310	242/62	15.50	14.60	18.08	23.98		1.50		30	Pass
HE80	MCS0	2	58	5290	Full	14.30	14.50	17.41	23.98		1.50		30	Pass
HE80	MCS0	2	58	5290	484/66	14.30	14.10	17.21	23.98		1.50		30	Pass

**TEST RESULTS DATA**  
**Average Power Table**

FCC Band III single antenna														
Mod.	Data Rate	NTX	CH.	Freq. (MHz)	RU Config	Average Conducted Power (dBm)			FCC Conducted Power Limit (dBm)		DG (dBi)		EIRP Power Limit (dBm)	Pass/Fail
						Ant 1	Ant 2	SUM	Ant 1	Ant 2	Ant 1	Ant 2		
HE20	MCS0	1	100	5500	Full	16.60	16.50		23.98	23.98	1.50	1.30	30	Pass
HE20	MCS0	1	100	5500	26/0	9.00	9.00		23.98	23.98	1.50	1.30	30	Pass
HE20	MCS0	1	100	5500	52/37	11.30	11.40		23.98	23.98	1.50	1.30	30	Pass
HE20	MCS0	1	100	5500	106/53	14.40	14.40		23.98	23.98	1.50	1.30	30	Pass
HE20	MCS0	1	116	5580	Full	16.60	16.60		23.98	23.98	1.50	1.30	30	Pass
HE20	MCS0	1	140	5700	Full	16.00	16.00		23.98	23.98	1.50	1.30	30	Pass
HE20	MCS0	1	140	5700	26/8	9.30	8.80		23.98	23.98	1.50	1.30	30	Pass
HE20	MCS0	1	140	5700	52/40	11.80	11.60		23.98	23.98	1.50	1.30	30	Pass
HE20	MCS0	1	140	5700	106/54	14.10	14.10		23.98	23.98	1.50	1.30	30	Pass
HE40	MCS0	1	102	5510	Full	15.80	15.80		23.98	23.98	1.50	1.30	30	Pass
HE40	MCS0	1	102	5510	242/61	16.20	16.30		23.98	23.98	1.50	1.30	30	Pass
HE40	MCS0	1	110	5550	Full	16.20	16.20		23.98	23.98	1.50	1.30	30	Pass
HE40	MCS0	1	134	5670	Full	16.50	16.50		23.98	23.98	1.50	1.30	30	Pass
HE40	MCS0	1	134	5670	242/62	16.40	16.40		23.98	23.98	1.50	1.30	30	Pass
HE80	MCS0	1	106	5530	Full	16.00	16.00		23.98	23.98	1.50	1.30	30	Pass
HE80	MCS0	1	106	5530	484/65	15.90	15.90		23.98	23.98	1.50	1.30	30	Pass
HE80	MCS0	1	122	5610	Full	16.40	16.40		23.98	23.98	1.50	1.30	30	Pass
HE80	MCS0	1	122	5610	484/66	16.20	16.20		23.98	23.98	1.50	1.30	30	Pass

FCC Band III MIMO														
Mod.	Data Rate	NTX	CH.	Freq. (MHz)	RU Config	Average Conducted Power (dBm)			FCC Conducted Power Limit (dBm)		DG (dBi)		EIRP Power Limit (dBm)	Pass/Fail
						Ant 1	Ant 2	SUM	Ant 1	Ant 2	Ant 1	Ant 2		
HE20	MCS0	2	100	5500	Full	17.20	16.00	19.65	23.98		1.50		30	Pass
HE20	MCS0	2	100	5500	26/0	9.80	9.20	12.52	23.98		1.50		30	Pass
HE20	MCS0	2	100	5500	52/37	12.00	11.60	14.81	23.98		1.50		30	Pass
HE20	MCS0	2	100	5500	106/53	15.30	14.20	17.80	23.98		1.50		30	Pass
HE20	MCS0	2	116	5580	Full	17.30	15.80	19.62	23.98		1.50		30	Pass
HE20	MCS0	2	140	5700	Full	16.50	15.50	19.04	23.98		1.50		30	Pass
HE20	MCS0	2	140	5700	26/8	9.90	9.20	12.57	23.98		1.50		30	Pass
HE20	MCS0	2	140	5700	52/40	12.40	11.50	14.98	23.98		1.50		30	Pass
HE20	MCS0	2	140	5700	106/54	15.00	13.70	17.41	23.98		1.50		30	Pass
HE40	MCS0	2	102	5510	Full	16.30	15.40	18.88	23.98		1.50		30	Pass
HE40	MCS0	2	102	5510	242/61	17.00	16.00	19.54	23.98		1.50		30	Pass
HE40	MCS0	2	110	5550	Full	17.20	16.00	19.65	23.98		1.50		30	Pass
HE40	MCS0	2	134	5670	Full	17.00	16.10	19.58	23.98		1.50		30	Pass
HE40	MCS0	2	134	5670	242/62	17.00	16.00	19.54	23.98		1.50		30	Pass
HE80	MCS0	2	106	5530	Full	16.10	15.90	19.01	23.98		1.50		30	Pass
HE80	MCS0	2	106	5530	484/65	16.10	15.80	18.96	23.98		1.50		30	Pass
HE80	MCS0	2	122	5610	Full	16.70	16.30	19.51	23.98		1.50		30	Pass
HE80	MCS0	2	122	5610	484/66	16.70	16.10	19.42	23.98		1.50		30	Pass

## &lt;TXBF Mode&gt;

Test Engineer:	Richard Qiu	Temperature:	21~25	°C
Test Date:	2020/2/21	Relative Humidity:	51~54	%

**TEST RESULTS DATA**  
**Average Power Table**

FCC Band I MIMO												
Mod.	Data Rate	NTX	CH.	Freq. (MHz)	Average Conducted Power (dBm)			FCC Conducted Power Limit (dBm)		DG (dBi)		Pass/Fail
					Ant 1	Ant 2	SUM	Ant 1	Ant 2	Ant 1	Ant 2	
VHT20	MCS0	2	36	5180	15.60	16.20	18.92	24.00		4.41		Pass
VHT20	MCS0	2	44	5220	15.70	16.20	18.97	24.00		4.41		Pass
VHT20	MCS0	2	48	5240	16.10	16.10	19.11	24.00		4.41		Pass
VHT40	MCS0	2	38	5190	15.60	15.80	18.71	24.00		4.41		Pass
VHT40	MCS0	2	46	5230	16.00	15.80	18.91	24.00		4.41		Pass
VHT80	MCS0	2	42	5210	16.20	16.30	19.26	24.00		4.41		Pass

**TEST RESULTS DATA**  
**Average Power Table**

FCC Band I MIMO													
Mod.	Data Rate	NTX	CH.	Freq. (MHz)	RU Config	Average Conducted Power (dBm)			FCC Conducted Power Limit (dBm)		DG (dBi)		Pass/Fail
						Ant 1	Ant 2	SUM	Ant 1	Ant 2	Ant 1	Ant 2	
HE20	MCS0	2	36	5180	Full	15.50	16.30	18.93	24.00	24.00	4.41	4.41	Pass
HE20	MCS0	2	44	5220	Full	16.00	15.80	18.91	24.00	24.00	4.41	4.41	Pass
HE20	MCS0	2	48	5240	Full	16.20	16.00	19.11	24.00	24.00	4.41	4.41	Pass
HE40	MCS0	2	38	5190	Full	16.10	15.80	18.96	24.00	24.00	4.41	4.41	Pass
HE40	MCS0	2	46	5230	Full	16.10	15.80	18.96	24.00	24.00	4.41	4.41	Pass
HE80	MCS0	2	42	5210	Full	16.10	15.80	18.96	24.00	24.00	4.41	4.41	Pass



## Appendix B. Radiated Spurious Emission

Test Engineer :	Jimmy Chung, Karl Hou, Wilson Wu, and Chuan Wei	Temperature :	21.5~23.5°C
		Relative Humidity :	49.5~55.5%

<CDD Mode>

### Band 1 - 5150~5250MHz

#### WIFI 802.11ac VHT80 (Band Edge @ 3m)

WIFI Ant.	Note	Frequency ( MHz )	Level ( dBμV/m )	Over Limit ( dB )	Limit Line ( dBμV/m )	Read Level ( dBμV )	Antenna Factor ( dB/m )	Path Loss ( dB )	Preamp Factor ( dB )	Ant Pos ( cm )	Table Pos ( deg )	Peak Avg. ( P/A )	Pol. ( H/V )
802.11ac VHT80 CH 42 5210MHz		5148.46	60.81	-13.19	74	49.45	32	6.06	26.7	100	245	P	H
		5149.5	49.62	-4.38	54	38.26	32	6.06	26.7	100	245	A	H
	*	5210	99.54	31.34	68.2	88.52	31.64	6.08	26.7	100	245	P	H
	*	5210	91.35	37.35	54	80.33	31.64	6.08	26.7	100	245	A	H
		5405.96	51.05	-22.95	74	39.88	31.62	6.24	26.69	100	245	P	H
		5458.6	41.46	-12.54	54	30.07	31.82	6.26	26.69	100	245	A	H
		5146.9	60.46	-13.54	74	49.1	32	6.06	26.7	217	336	P	V
		5150	49.1	-4.9	54	37.73	32	6.07	26.7	217	336	A	V
	*	5210	100.96	32.76	68.2	89.94	31.64	6.08	26.7	217	336	P	V
	*	5210	92.63	38.63	54	81.61	31.64	6.08	26.7	217	336	A	V
	5418	50.81	-23.19	74	39.58	31.67	6.25	26.69	217	336	P	V	
	5460	41.42	-12.58	54	30.03	31.82	6.26	26.69	217	336	A	V	
Remark	1. No other spurious found. 2. All results are PASS against Peak and Average limit line.												



**Band 1 5150~5250MHz  
WIFI 802.11ac VHT80 (Harmonic @ 3m)**

WIFI Ant. 1+2	Note	Frequency ( MHz )	Level ( dBμV/m )	Over Limit ( dB )	Limit Line ( dBμV/m )	Read Level (dBμV)	Antenna Factor ( dB/m )	Path Loss ( dB )	Preamp Factor ( dB )	Ant Pos ( cm )	Table Pos ( deg )	Peak Avg. (P/A)	Pol. (H/V)	
802.11ac VHT80 CH 42 5210MHz		10420	46.04	-22.16	68.2	53.14	39.92	9.91	56.93	100	0	P	H	
		15630	43.79	-30.21	74	49.52	38.31	12.5	56.54	100	0	P	H	
													H	
													H	
			10420	46.62	-21.58	68.2	53.72	39.92	9.91	56.93	100	0	P	V
			15630	44.31	-29.69	74	50.04	38.31	12.5	56.54	100	0	P	V
														V
														V
<b>Remark</b>	1. No other spurious found. 2. All results are PASS against Peak and Average limit line.													



Emission below 1GHz  
WIFI 802.11ac VHT80 (LF @ 3m)

WIFI	Note	Frequency	Level	Over	Limit	Read	Antenna	Path	Preamp	Ant	Table	Peak	Pol.	
Ant.				Limit	Line	Level	Factor	Loss	Factor	Pos	Pos	Avg.		
1+2		( MHz )	( dBμV/m )	( dB )	( dBμV/m )	( dBμV )	( dB/m )	( dB )	( dB )	( cm )	( deg )	( P/A )	( H/V )	
802.11ac VHT80 LF		30	23.88	-16.12	40	31.31	24.31	0.48	32.22	-	-	P	H	
		143.49	18.91	-24.59	43.5	32.94	17.13	1.04	32.2	-	-	P	H	
		844.8	31.15	-14.85	46	31.6	28.88	2.48	31.81	-	-	P	H	
		895.24	34.01	-11.99	46	33.99	29.01	2.66	31.65	-	-	P	H	
		903.97	36.16	-9.84	46	36.02	29.04	2.68	31.58	100	0	P	H	
		955.38	33.64	-12.36	46	31.08	30.79	2.7	30.93	-	-	P	H	
														H
														H
														H
														H
														H
														H
			31.94	26.42	-13.58	40	34.8	23.36	0.49	32.23	-	-	P	V
			127	17.83	-25.67	43.5	31.63	17.37	0.99	32.16	-	-	P	V
			741.98	29.92	-16.08	46	31.33	28	2.35	31.76	-	-	P	V
			798.24	31.73	-14.27	46	33.32	27.9	2.45	31.94	-	-	P	V
			901.06	35.75	-10.25	46	35.7	28.99	2.68	31.62	100	0	P	V
			952.47	33.37	-12.63	46	30.95	30.69	2.7	30.97	-	-	P	V
														V
														V
													V	
													V	
													V	
													V	
Remark	1. No other spurious found. 2. All results are PASS against limit line.													





<b>Test Engineer :</b>	Cookie Ku, Fu Chen, Troye Hsieh	<b>Temperature :</b>	16.7~24.1°C
		<b>Relative Humidity :</b>	29.2~67.7%

**<CDD Mode>**

**Band 2 - 5250~5350MHz**

**WIFI 802.11ac VHT40 (Band Edge @ 3m)**

WIFI	Note	Frequency	Level	Over	Limit	Read	Antenna	Path	Preamp	Ant	Table	Peak	Pol.
Ant.				Limit	Line	Level	Factor	Loss	Factor	Pos	Pos	Avg.	
1+2		( MHz )	( dBμV/m )	( dB )	( dBμV/m )	( dBμV )	( dB/m )	( dB )	( dB )	( cm )	( deg )	( P/A )	( H/V )
<b>802.11ac VHT40 CH 54 5270MHz</b>		5148.24	57.26	-16.74	74	48.25	31.8	10.03	32.82	157	15	P	H
		5149.26	47.5	-6.5	54	38.48	31.8	10.03	32.81	157	15	A	H
	*	5270	107.38	-	-	98.61	31.4	10.11	32.74	157	15	P	H
	*	5270	98.79	-	-	90.02	31.4	10.11	32.74	157	15	A	H
		5352.48	63.37	-10.63	74	54.6	31.31	10.14	32.68	157	15	P	H
		5350.08	50.78	-3.22	54	42.03	31.3	10.14	32.69	157	15	A	H
		5149.6	56.68	-17.32	74	47.66	31.8	10.03	32.81	100	17	P	V
		5149.26	47.41	-6.59	54	38.39	31.8	10.03	32.81	100	17	A	V
	*	5270	106.67	-	-	97.9	31.4	10.11	32.74	100	17	P	V
	*	5270	98.97	-	-	90.2	31.4	10.11	32.74	100	17	A	V
	5353.68	63.11	-10.89	74	54.33	31.32	10.14	32.68	100	17	P	V	
	5358.72	50.56	-3.44	54	41.75	31.35	10.14	32.68	100	17	A	V	
<b>Remark</b>	1. No other spurious found. 2. All results are PASS against Peak and Average limit line.												



**Band 2 5250~5350MHz  
WIFI 802.11ac VHT40 (Harmonic @ 3m)**

WIFI Ant. 1+2	Note	Frequency ( MHz )	Level ( dBμV/m )	Over Limit ( dB )	Limit Line ( dBμV/m )	Read Level (dBμV)	Antenna Factor ( dB/m )	Path Loss ( dB )	Preamp Factor ( dB )	Ant Pos ( cm )	Table Pos ( deg )	Peak Avg. (P/A)	Pol. (H/V)	
802.11ac VHT40 CH 54 5270MHz		10540	48.27	-19.93	68.2	55.58	39.9	16.47	63.68	100	0	P	H	
		15810	45	-29	74	49.29	37.17	20.56	62.02	100	0	P	H	
													H	
													H	
			10540	46.49	-21.71	68.2	53.8	39.9	16.47	63.68	100	0	P	V
			15810	44.44	-29.56	74	48.73	37.17	20.56	62.02	100	0	P	V
														V
														V
<b>Remark</b>	1. No other spurious found. 2. All results are PASS against Peak and Average limit line.													



**Band 3 - 5470~5725MHz**

**WIFI 802.11ac VHT20 (Band Edge @ 3m)**

WIFI	Note	Frequency	Level	Over	Limit	Read	Antenna	Path	Preamp	Ant	Table	Peak	Pol.
Ant.				Limit	Line	Level	Factor	Loss	Factor	Pos	Pos	Avg.	
1+2		( MHz )	( dBμV/m )	( dB )	( dBμV/m )	(dBμV)	( dB/m )	( dB )	( dB )	( cm )	( deg )	(P/A)	(H/V)
<b>802.11ac VHT20 CH 140 5700MHz</b>	*	5700	112.1	-	-	102.02	32.1	10.51	32.53	100	16	P	H
	*	5700	103.08	-	-	93	32.1	10.51	32.53	100	16	A	H
		5725.24	64.99	-3.21	68.2	54.84	32.15	10.53	32.53	100	16	P	H
													H
													H
													H
	*	5700	110.29	-	-	100.21	32.1	10.51	32.53	100	19	P	V
	*	5700	102.12	-	-	92.04	32.1	10.51	32.53	100	19	A	V
		5728.44	63.67	-4.53	68.2	53.51	32.16	10.53	32.53	100	19	P	V
													V
<b>Remark</b>	1. No other spurious found. 2. All results are PASS against Peak and Average limit line.												



**Band 3 - 5470~5725MHz  
WIFI 802.11ac VHT20 (Harmonic @ 3m)**

WIFI Ant. 1+2	Note	Frequency ( MHz )	Level ( dBμV/m )	Over Limit ( dB )	Limit Line ( dBμV/m )	Read Level (dBμV)	Antenna Factor ( dB/m )	Path Loss ( dB )	Preamp Factor ( dB )	Ant Pos ( cm )	Table Pos ( deg )	Peak Avg. (P/A)	Pol. (H/V)	
802.11ac VHT20 CH 140 5700MHz		11400	46.66	-27.34	74	53.1	39.7	17.34	63.48	100	0	P	H	
		17100	48.25	-19.95	68.2	48.46	39.7	21.95	61.86	100	0	P	H	
													H	
													H	
			11400	46.53	-27.47	74	52.97	39.7	17.34	63.48	100	0	P	V
			17100	47.43	-20.77	68.2	47.64	39.7	21.95	61.86	100	0	P	V
														V
														V
<b>Remark</b>	1. No other spurious found. 2. All results are PASS against Peak and Average limit line.													



**Band 2 - 5250~5350MHz**

**WIFI 802.11ax HE80 (Full RU) (Band Edge @ 3m)**

WIFI	Note	Frequency	Level	Over	Limit	Read	Antenna	Path	Preamp	Ant	Table	Peak	Pol.
Ant.				Limit	Line	Level	Factor	Loss	Factor	Pos	Pos	Avg.	
1+2		( MHz )	( dBμV/m )	( dB )	( dBμV/m )	( dBμV )	( dB/m )	( dB )	( dB )	( cm )	( deg )	( P/A )	( H/V )
802.11ax HE80 (Full RU) CH 58 5290MHz		5084.9	50.37	-23.63	74	41.56	31.71	9.96	32.86	109	8	P	H
		5150	40.69	-13.31	54	31.67	31.8	10.03	32.81	109	8	A	H
	*	5290	103.49	-	-	94.69	31.4	10.12	32.72	109	8	P	H
	*	5290	93.82	-	-	85.02	31.4	10.12	32.72	109	8	A	H
		5353.92	63.44	-10.56	74	54.66	31.32	10.14	32.68	109	8	P	H
		5350.08	50.91	-3.09	54	42.16	31.3	10.14	32.69	109	8	A	H
		5136.2	51.39	-22.61	74	42.39	31.8	10.02	32.82	261	358	P	V
		5150	40.55	-13.45	54	31.53	31.8	10.03	32.81	261	358	A	V
	*	5290	101.85	-	-	93.05	31.4	10.12	32.72	261	358	P	V
	*	5290	91.75	-	-	82.95	31.4	10.12	32.72	261	358	A	V
		5356.56	64.26	-9.74	74	55.46	31.34	10.14	32.68	261	358	P	V
		5350.08	50.88	-3.12	54	42.13	31.3	10.14	32.69	261	358	A	V
Remark	1. No other spurious found. 2. All results are PASS against Peak and Average limit line.												



**Band 2 5250~5350MHz**

**WIFI 802.11ax HE80 (Full RU) (Harmonic @ 3m)**

WIFI Ant. 1+2	Note	Frequency ( MHz )	Level ( dBμV/m )	Over Limit ( dB )	Limit Line ( dBμV/m )	Read Level (dBμV)	Antenna Factor ( dB/m )	Path Loss ( dB )	Preamp Factor ( dB )	Ant Pos ( cm )	Table Pos ( deg )	Peak Avg. (P/A)	Pol. (H/V)	
802.11ax HE80 (Full RU) CH 58 5290MHz		10580	46.55	-21.65	68.2	53.8	39.9	16.5	63.65	100	0	P	H	
		15870	44.83	-29.17	74	49.34	36.99	20.55	62.05	100	0	P	H	
													H	
													H	
			10580	45.76	-22.44	68.2	53.01	39.9	16.5	63.65	100	0	P	V
			15870	42.84	-31.16	74	47.35	36.99	20.55	62.05	100	0	P	V
														V
														V
Remark	1. No other spurious found. 2. All results are PASS against Peak and Average limit line.													



**Band 3 - 5470~5725MHz**

**WIFI 802.11ax HE40 (Partial 242 62RU) (Band Edge @ 3m)**

WIFI	Note	Frequency	Level	Over	Limit	Read	Antenna	Path	Preamp	Ant	Table	Peak	Pol.
Ant.				Limit	Line	Level	Factor	Loss	Factor	Pos	Pos	Avg.	
1+2		( MHz )	( dBμV/m )	( dB )	( dBμV/m )	( dBμV )	( dB/m )	( dB )	( dB )	( cm )	( deg )	(P/A)	(H/V)
<b>802.11ax HE40 CH 134 5670MHz</b>		5456.05	50.05	-23.95	74	40.71	31.72	10.24	32.62	291	24	P	H
		5466.9	50.46	-17.74	68.2	41.05	31.77	10.25	32.61	291	24	P	H
		5455.7	39.78	-14.22	54	30.44	31.72	10.24	32.62	291	24	A	H
	*	5670	114.27	-	-	104.39	31.92	10.5	32.54	291	24	P	H
	*	5670	104.42	-	-	94.54	31.92	10.5	32.54	291	24	A	H
		5726.675	64.98	-3.22	68.2	54.83	32.15	10.53	32.53	291	24	P	H
		5446.25	51.62	-22.38	74	42.33	31.69	10.22	32.62	172	17	P	V
		5460.6	49	-19.2	68.2	39.64	31.74	10.24	32.62	172	17	P	V
		5459.2	39.7	-14.3	54	30.34	31.74	10.24	32.62	172	17	A	V
	*	5670	116.75	-	-	106.87	31.92	10.5	32.54	172	17	P	V
	*	5670	105.9	-	-	96.02	31.92	10.5	32.54	172	17	A	V
		5726.15	64.7	-3.5	68.2	54.55	32.15	10.53	32.53	172	17	P	V
<b>Remark</b>	1. No other spurious found. 2. All results are PASS against Peak and Average limit line.												



**Band 3 5470~5725MHz**

**WIFI 802.11ax HE40 (Partial 242 62 RU) (Harmonic @ 3m)**

WIFI Ant. 1+2	Note	Frequency ( MHz )	Level ( dBμV/m )	Over Limit ( dB )	Limit Line ( dBμV/m )	Read Level (dBμV)	Antenna Factor ( dB/m )	Path Loss ( dB )	Preamp Factor ( dB )	Ant Pos ( cm )	Table Pos ( deg )	Peak Avg. (P/A)	Pol. (H/V)	
802.11ax HE40 (Partial 242 62 RU) CH 134 5670MHz		11340	47.54	-26.46	74	54.23	39.52	17.26	63.47	100	0	P	H	
		17010	47.48	-20.72	68.2	47.9	39.7	21.87	61.99	100	0	P	H	
													H	
													H	
			11340	47.66	-26.34	74	54.35	39.52	17.73	63.47	100	0	P	V
			17010	45.85	-22.35	68.2	46.27	39.7	22.37	61.99	100	0	P	V
														V
														V
Remark	1. No other spurious found. 2. All results are PASS against Peak and Average limit line.													





Emission below 1GHz

WIFI 802.11ax HE80 (Full RU) (LF @ 3m)

WIFI	Note	Frequency	Level	Over	Limit	Read	Antenna	Path	Preamp	Ant	Table	Peak	Pol.	
Ant.				Limit	Line	Level	Factor	Loss	Factor	Pos	Pos	Avg.		
1+2		( MHz )	( dBμV/m )	( dB )	( dBμV/m )	( dBμV )	( dB/m )	( dB )	( dB )	( cm )	( deg )	( P/A )	( H/V )	
802.11ax HE80 (Full RU) LF		62.98	26.03	-13.97	40	45.64	11.8	1.09	32.5			P	H	
		98.87	21.03	-22.47	43.5	36.26	15.79	1.36	32.38			P	H	
		213.33	23.67	-19.83	43.5	39.19	15	2.02	32.54			P	H	
		271.53	30.11	-15.89	46	41.22	18.94	2.27	32.32			P	H	
		298.69	38.64	-7.36	46	49.2	19.27	2.38	32.21	100	0	P	H	
		325.85	34.21	-11.79	46	44.23	19.63	2.48	32.13			P	H	
													H	
													H	
													H	
													H	
													H	
													H	
			33.88	26.95	-13.05	40	35.33	23.25	0.81	32.44			P	V
			40.67	26.38	-13.62	40	38.6	19.4	0.86	32.48			P	V
			106.63	20.74	-22.76	43.5	35.04	16.7	1.39	32.39			P	V
			298.69	33.72	-12.28	46	44.28	19.27	2.38	32.21			P	V
			947.62	33.96	-12.04	46	29.96	30.76	4.34	31.1			P	V
			959.26	34.17	-11.83	46	29.58	31.17	4.37	30.95	100	0	P	V
													V	
													V	
													V	
													V	
													V	
													V	
Remark	1. No other spurious found. 2. All results are PASS against limit line.													



**Note symbol**

*	<b>Fundamental Frequency</b> which can be ignored. However, the level of any unwanted emissions shall not exceed the level of the fundamental frequency.
!	Test result is <b>over limit</b> line.
P/A	<b>Peak</b> or <b>Average</b>
H/V	<b>Horizontal</b> or <b>Vertical</b>



A calculation example for radiated spurious emission is shown as below:

WIFI	Note	Frequency	Level	Over	Limit	Read	Antenna	Path	Preamp	Ant	Table	Peak	Pol.
Ant.				Limit	Line	Level	Factor	Loss	Factor	Pos	Pos	Avg.	
1+2		( MHz )	( dBμV/m )	( dB )	( dBμV/m )	( dBμV )	( dB/m )	( dB )	( dB )	( cm )	( deg )	( P/A )	( H/V )
802.11b		2390	55.45	-18.55	74	54.51	32.22	4.58	35.86	103	308	P	H
CH 01													
2412MHz		2390	43.54	-10.46	54	42.6	32.22	4.58	35.86	103	308	A	H

1. Path Loss(dB) = Cable loss(dB) + Filter loss(dB) + Attenuator loss(dB)
2. Level(dBμV/m) = Antenna Factor(dB/m) + Path Loss(dB) + Read Level(dBμV) - Preamp Factor(dB)
3. Over Limit(dB) = Level(dBμV/m) – Limit Line(dBμV/m)

**For Peak Limit @ 2390MHz:**

1. Level(dBμV/m)  
= Antenna Factor(dB/m) + Path Loss(dB) + Read Level(dBμV) - Preamp Factor(dB)  
= 32.22(dB/m) + 4.58(dB) + 54.51(dBμV) – 35.86 (dB)  
= 55.45 (dBμV/m)
2. Over Limit(dB)  
= Level(dBμV/m) – Limit Line(dBμV/m)  
= 55.45(dBμV/m) – 74(dBμV/m)  
= -18.55(dB)

**For Average Limit @ 2390MHz:**

1. Level(dBμV/m)  
= Antenna Factor(dB/m) + Path Loss(dB) + Read Level(dBμV) - Preamp Factor(dB)  
= 32.22(dB/m) + 4.58(dB) + 42.6(dBμV) – 35.86 (dB)  
= 43.54 (dBμV/m)
2. Over Limit(dB) = Level(dBμV/m) – Limit Line(dBμV/m)  
= 43.54(dBμV/m) – 54(dBμV/m)  
= -10.46(dB)

**Both peak and average measured complies with the limit line, so test result is “PASS”.**



### Appendix C. Radiated Spurious Emission

Test Engineer :	Jimmy Chung, Karl Hou, Wilson Wu, and Chuan Wei	Temperature :	21.5~23.5°C
		Relative Humidity :	49.5~55.5%

#### Note symbol

-L	Low channel location
-R	High channel location



<CDD Mode>

Band 1 - 5150~5250MHz

WIFI 802.11ac VHT80 (Band Edge @ 3m)

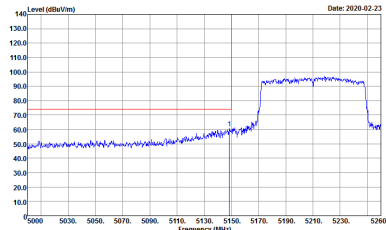
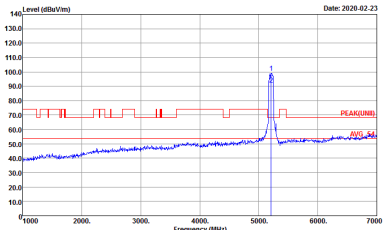
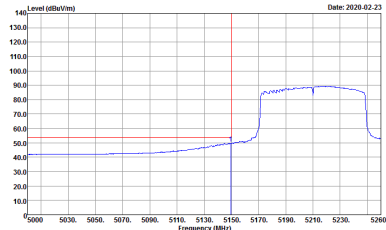
WIFI	Band 1 5150~5250MHz Band Edge @ 3m	
ANT	802.11ac VHT80 CH42 5210MHz - L	
1+2	Horizontal	Fundamental
Peak	 <p>Site : 03CH13-HY            Condition : PEAK_BE_74 3m HORN_9120D_1241 HORIZONTAL            RBW:1000.000kHz VBW:3000.000kHz SWT:Auto            Detector : Peak            Project : 9D0635-01</p>	 <p>Site : 03CH13-HY            Condition : PEAK(UNII) 3m HORN_9120D_1241 HORIZONTAL            RBW:1000.000kHz VBW:3000.000kHz SWT:Auto            Detector : Peak            Project : 9D0635-01</p>
Avg.	 <p>Site : 03CH13-HY            Condition : AVG_BE_54 3m HORN_9120D_1241 HORIZONTAL            RBW:1000.000kHz VBW:0.010kHz SWT:Auto            Detector : Peak            Project : 9D0635-01</p>	Left blank

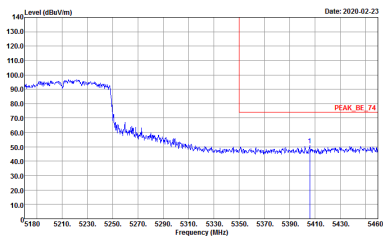
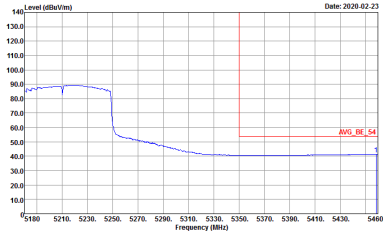

WIFI	Band 1 5150~5250MHz Band Edge @ 3m	
ANT	802.11ac VHT80 CH42 5210MHz - R	
1+2	Horizontal	Fundamental
<p><b>Peak</b></p>	 <p>Site : 03CH13-HY            Condition : PEAK_BE_74 3m HORN_9120D_1241 HORIZONTAL            Detector : Peak            Project : 9D0635-01</p>	<p>Left blank</p>
<p><b>Avg.</b></p>	 <p>Site : 03CH13-HY            Condition : AVG_BE_54 3m HORN_9120D_1241 HORIZONTAL            Detector : Peak            Project : 9D0635-01</p>	<p>Left blank</p>

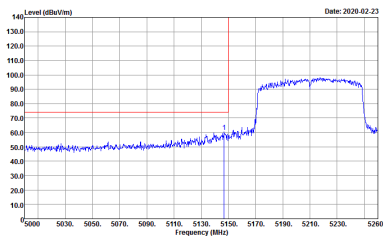
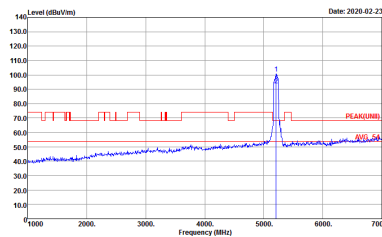
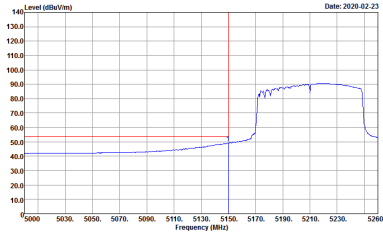

WIFI	Band 1 5150~5250MHz Band Edge @ 3m	
ANT	802.11ac VHT80 CH42 5210MHz - L	
1+2	Vertical	Fundamental
<p><b>Peak</b></p>	 <p>Site : 03CH13-HY            Condition : PEAK_BE_74 3m HORN_9120D_1241 VERTICAL            Detector : Peak            Project : 9D0635-01</p>	 <p>Site : 03CH13-HY            Condition : PEAKUNII 3m HORN_9120D_1241 VERTICAL            Detector : Peak            Project : 9D0635-01</p>
<p><b>Avg.</b></p>	 <p>Site : 03CH13-HY            Condition : AVG_BE_54 3m HORN_9120D_1241 VERTICAL            Detector : Peak            Project : 9D0635-01</p>	<p><b>Left blank</b></p>

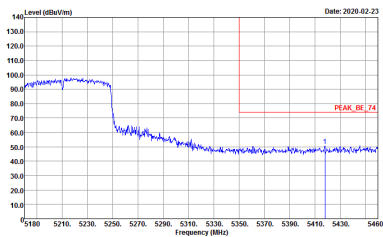
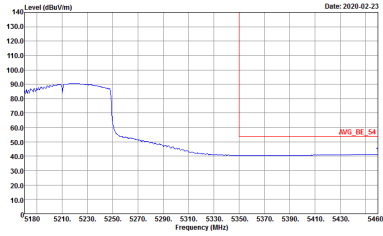

WIFI	Band 1 5150~5250MHz Band Edge @ 3m	
ANT	802.11ac VHT80 CH42 5210MHz - R	
1+2	Vertical	Fundamental
<p><b>Peak</b></p>	 <p>Site : 03CH13-HY            Condition : PEAK_BE_74 3m HORN_9120D_1241 VERTICAL            Detector : Peak            Project : 9D0635-01</p>	<p>Left blank</p>
<p><b>Avg.</b></p>	 <p>Site : 03CH13-HY            Condition : AVG_BE_54 3m HORN_9120D_1241 VERTICAL            Detector : Peak            Project : 9D0635-01</p>	<p>Left blank</p>





**Band 1 - 5150~5250MHz**  
**WIFI 802.11ac VHT80 (Harmonic @ 3m)**

<b>WIFI</b>	<b>Band 1 5150~5250MHz Harmonic @ 3m</b>	
<b>ANT</b>	<b>802.11ac VHT80 CH42 5210MHz</b>	
<b>1+2</b>	<b>Horizontal</b>	<b>Vertical</b>
<b>Peak</b> <b>Avg.</b>	<p>Site : 03CH13-HY          Condition : PEAR(UNIT) 3m HORN_91200_1241 HORIZONTAL          Detector : Peak          Project : 9D0635-01          Mode : 1          Setting : 17</p>	<p>Site : 03CH13-HY          Condition : PEAR(UNIT) 3m HORN_91200_1241 VERTICAL          Detector : Peak          Project : 9D0635-01          Mode : 1          Setting : 17</p>



Emission below 1GHz  
5GHz WIFI 802.11ac VHT80 (LF)

WIFI	5GHz WIFI	
ANT	802.11ac VHT80 LF	
1+2	Horizontal	Vertical
QP / Peak	<p>Site : 03CH13-HY Condition : QP 3m BIL06_37059401 HORIZONTAL Detector : Peak Project : 9D0635-01 Setting : 17</p>	<p>Site : 03CH13-HY Condition : QP 3m BIL06_37059401 VERTICAL Detector : Peak Project : 9D0635-01 Setting : 17</p>



Test Engineer :	Cookie Ku, Fu Chen, Troye Hsieh	Temperature :	16.7~24.1°C
		Relative Humidity :	29.2~67.7%

<CDD Mode>

**Band 2 - 5250~5350MHz  
WIFI 802.11ac VHT40 (Band Edge @ 3m)**

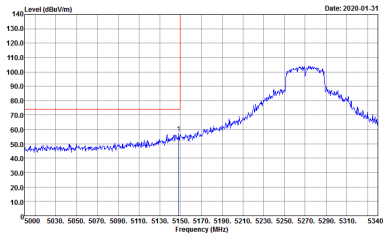
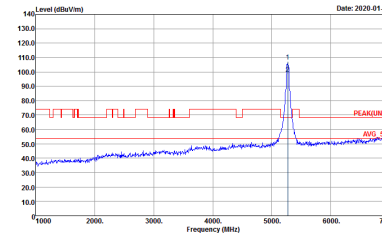
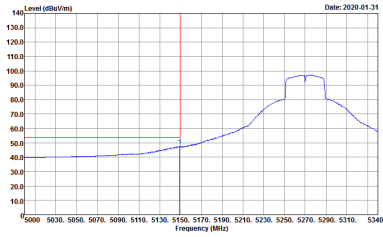
WIFI	Band 2 5250~5350MHz Band Edge @ 3m	
ANT	802.11ac VHT40 CH54 5270MHz - L	
1+2	Horizontal	Fundamental
<b>Peak</b>	 <p>Site : 03CH11-HY Condition : PEAK_BE_74 3m HORN 91200-HF HORIZONTAL Detector : Peak Project : 9D0635-01</p>	 <p>Site : 03CH11-HY Condition : PEAK(UNIT) 3m HORN 91200-HF HORIZONTAL Detector : Peak Project : 9D0635-01</p>
<b>Avg.</b>	 <p>Site : 03CH11-HY Condition : AVG_BE_54 3m HORN 91200-HF HORIZONTAL Detector : Peak Project : 9D0635-01</p>	Left blank

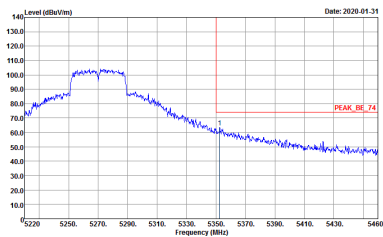
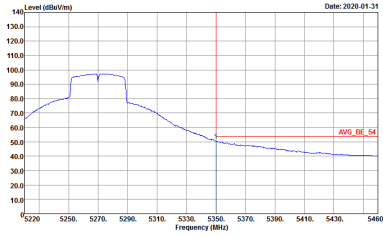

WIFI	Band 2 5250~5350MHz Band Edge @ 3m	
ANT	802.11ac VHT40 CH54 5270MHz - R	
1+2	Horizontal	Fundamental
<p><b>Peak</b></p>	 <p>Site : 03CH11-HY            Condition : PEAK_BE_74 3m HORN 91200-HF HORIZONTAL            Detector : Peak            Project : 9D0635-01</p>	<p>Left blank</p>
<p><b>Avg.</b></p>	 <p>Site : 03CH11-HY            Condition : AVG_BE_54 3m HORN 91200-HF HORIZONTAL            Detector : Peak            Project : 9D0635-01</p>	<p>Left blank</p>



WIFI	Band 2 5250~5350MHz Band Edge @ 3m	
ANT	802.11ac VHT40 CH54 5270MHz - L	
1+2	Vertical	Fundamental
<p><b>Peak</b></p>		
<p><b>Avg.</b></p>		<p><b>Left blank</b></p>



WIFI	Band 2 5250~5350MHz Band Edge @ 3m	
ANT	802.11ac VHT40 CH54 5270MHz - R	
1+2	Vertical	Fundamental
<p><b>Peak</b></p>		<p>Left blank</p>
<p><b>Avg.</b></p>		<p>Left blank</p>



**Band 2 - 5250~5350MHz**  
**WIFI 802.11ac VHT40 (Harmonic @ 3m)**

<b>WIFI</b>	<b>Band 2 5250~5350MHz Harmonic @ 3m</b>	
<b>ANT</b>	<b>802.11ac VHT40 CH54 5270MHz</b>	
<b>1+2</b>	<b>Horizontal</b>	<b>Vertical</b>
<b>Peak</b> <b>Avg.</b>	<p>Site : 03CH11-HY          Condition : PEAR(LINE) 3m HORN 9120D-HF HORIZONTAL          Detector : Peak          Project : 9D0635-01</p>	<p>Site : 03CH11-HY          Condition : PEAR(LINE) 3m HORN 9120D-HF VERTICAL          Detector : Peak          Project : 9D0635-01</p>



**Band 3 - 5470~5725MHz**  
**WIFI 802.11ac VHT20 (Band Edge @ 3m)**

<b>WIFI</b>	<b>Band 3 5470~5725MHz Band Edge @ 3m</b>	
<b>ANT</b>	<b>802.11ac VHT20 CH140 5700MHz</b>	
<b>1+2</b>	<b>Horizontal</b>	<b>Fundamental</b>
<b>Peak</b>	<p>Site : 03CH11-HY          Condition : PEAK_BE(UNIT)_B3 3m HORN 9120D-HF HORIZONTAL          RBW:1000.000kHz VBW:3000.000kHz SWT:Auto          Detector : Peak          Project : 9D0635-01</p>	<p>Site : 03CH11-HY          Condition : PEAK(FUND) 3m HORN 9120D-HF HORIZONTAL          RBW:1000.000kHz VBW:3000.000kHz SWT:Auto          Detector : Peak          Project : 9D0635-01</p>



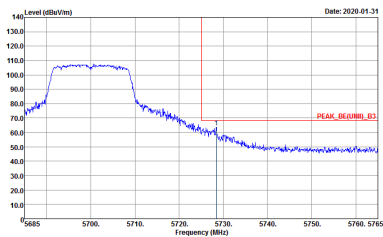
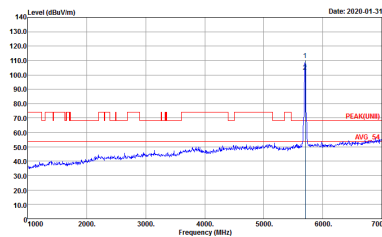

WIFI	Band 3 5470~5725MHz Band Edge @ 3m	
ANT	802.11ac VHT20 CH140 5700MHz	
1+2	Vertical	Fundamental
Peak	 <p>Site : 03CH1144Y          Condition : PEAK_BE(UMI)_B3 3m HORN 9120D-HF VERTICAL          RBW:1000.000KHz VBW:3000.000KHz SWT:Auto          Detector : Peak          Project : 900635-01</p>	 <p>Site : 03CH1144Y          Condition : PEAK(UMI)_B3 3m HORN 9120D-HF VERTICAL          RBW:1000.000KHz VBW:3000.000KHz SWT:Auto          Detector : Peak          Project : 900635-01</p>



**Band 3 - 5470~5725MHz**  
**WIFI 802.11ac VHT20 (Harmonic @ 3m)**

<b>WIFI</b>	<b>Band 3 5470~5725MHz Harmonic @ 3m</b>	
<b>ANT</b>	<b>802.11ac VHT20 CH140 5700MHz</b>	
<b>1+2</b>	<b>Horizontal</b>	<b>Vertical</b>
<b>Peak</b> <b>Avg.</b>	<p>Site : 03CH11-HY          Condition : PEAR(UNIT) 3m HORN 9120D-HF HORIZONTAL          Detector : Peak          Project : 9D0635-01</p>	<p>Site : 03CH11-HY          Condition : PEAR(UNIT) 3m HORN 9120D-HF VERTICAL          Detector : Peak          Project : 9D0635-01</p>



Band 2 - 5250~5350MHz

WIFI 802.11ax HE80 (Full RU) (Band Edge @ 3m)

WIFI	Band 2 5250~5350MHz Band Edge @ 3m	
ANT	802.11ax HE80(Full RU) CH58 5290MHz - L	
1+2	Horizontal	Fundamental
Peak	<p>Site : 03CH11-HY Condition : PEAK_BE_74 3m HORN 9120D-HF HORIZONTAL Detector : Peak Project : 9D0635-01</p>	<p>Site : 03CH11-HY Condition : PEAK(LINE) 3m HORN 9120D-HF HORIZONTAL Detector : Peak Project : 9D0635-01</p>
Avg.	<p>Site : 03CH11-HY Condition : AVG_BE_54 3m HORN 9120D-HF HORIZONTAL Detector : Peak Project : 9D0635-01</p>	Left blank

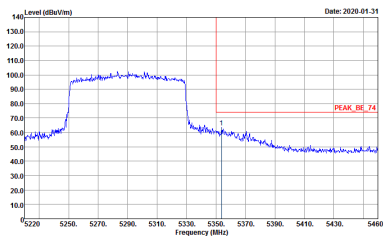
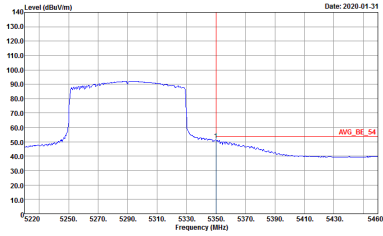

WIFI	Band 2 5250~5350MHz Band Edge @ 3m	
ANT	802.11ax HE80(Full RU) 5290MHz - R	
1+2	Horizontal	Fundamental
<p><b>Peak</b></p>	 <p>Site : 03CH11-HY            Condition : PEAK_BE_74 3m HORN 91200-HF HORIZONTAL            Detector : Peak            Project : 9D0635-01</p>	<p>Left blank</p>
<p><b>Avg.</b></p>	 <p>Site : 03CH11-HY            Condition : AVG_BE_54 3m HORN 91200-HF HORIZONTAL            Detector : Peak            Project : 9D0635-01</p>	<p>Left blank</p>

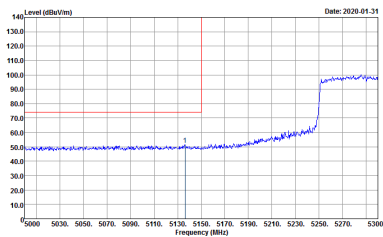
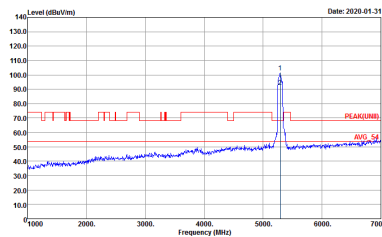
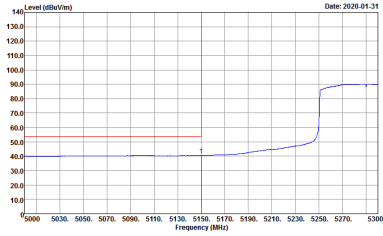

WIFI	Band 2 5250~5350MHz Band Edge @ 3m	
ANT	802.11ax HE80(Full RU) CH58 5290MHz - L	
1+2	Vertical	Fundamental
Peak	 <p>Site : 03CH11-HY Condition : PEAK_BE_74 3m HORN 9120D-HF VERTICAL Detector : Peak Project : 9D0635-01</p>	 <p>Site : 03CH11-HY Condition : PEAK(UNII) 3m HORN 9120D-HF VERTICAL Detector : Peak Project : 9D0635-01</p>
Avg.	 <p>Site : 03CH11-HY Condition : AVG_BE_54 3m HORN 9120D-HF VERTICAL Detector : Peak Project : 9D0635-01</p>	Left blank

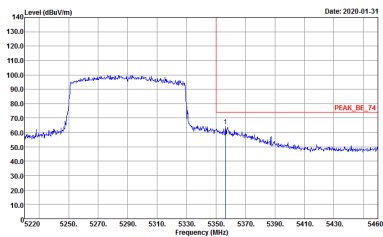
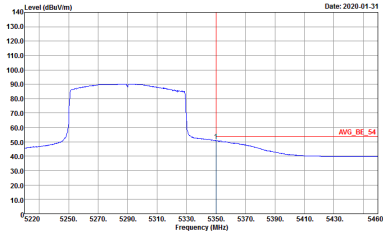

WIFI	Band 2 5250~5350MHz Band Edge @ 3m	
ANT	802.11ax HE80(Full RU) 5290MHz - R	
1+2	Vertical	Fundamental
<p><b>Peak</b></p>	 <p>Site : 03CH11-HY            Condition : PEAK_BE_74 3m HORN 91200-HF VERTICAL            Detector : Peak            Project : 9D0635-01</p>	<p>Left blank</p>
<p><b>Avg.</b></p>	 <p>Site : 03CH11-HY            Condition : AVG_BE_54 3m HORN 91200-HF VERTICAL            Detector : Peak            Project : 9D0635-01</p>	<p>Left blank</p>



**Band 2 - 5250~5350MHz**

**WIFI 802.11ax HE80 (Full RU) (Harmonic @ 3m)**

<b>WIFI</b>	<b>Band 2 5250~5350MHz Harmonic @ 3m</b>	
<b>ANT</b>	<b>802.11ax HE80(Full RU) CH58 5290MHz</b>	
<b>1+2</b>	<b>Horizontal</b>	<b>Vertical</b>
<b>Peak</b> <b>Avg.</b>	<p>Site : 03CH11-HY          Condition : PEAK(UNIT) 3m HORN 9120D-1HF HORIZONTAL          Detector : Peak          Project : 9D0635-01</p>	<p>Site : 03CH11-HY          Condition : PEAK(UNIT) 3m HORN 9120D-1HF VERTICAL          Detector : Peak          Project : 9D0635-01</p>



Band 3 - 5470~5725MHz

WIFI 802.11ax HE40 (Partial 242 62RU) (Band Edge @ 3m)

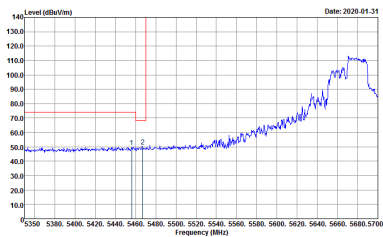
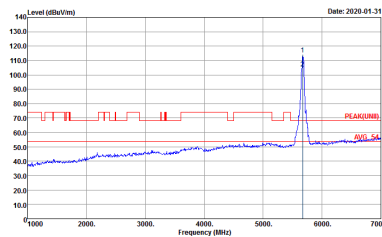
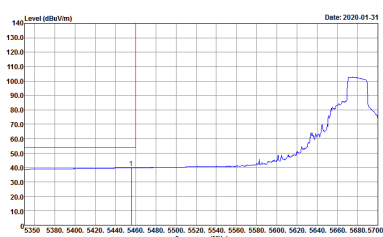
WIFI	Band 3 5470~5725MHz Band Edge @ 3m	
ANT	802.11ax HE40 CH134 5670MHz - L	
1+2	Horizontal	Fundamental
Peak	 <p>Site : 03CHI1-HY            Condition : PEAK_BE(UNIT)_B3 3m HORN 9120D-HF HORIZONTAL            Detector : Peak            Project : 900635-01            Setting : Z3</p>	 <p>Site : 03CHI1-HY            Condition : PEAK(UNIT) 3m HORN 9120D-HF HORIZONTAL            Detector : Peak            Project : 900635-01            Setting : Z3</p>
Avg.	 <p>Site : 03CHI1-HY            Condition : AVG_BE(UNIT)_B3 3m HORN 9120D-HF HORIZONTAL            Detector : Peak            Project : 900635-01            Setting : Z3</p>	Left blank



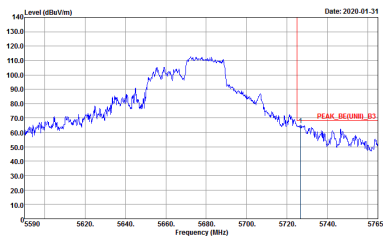

WIFI	Band 3 5470~5725MHz Band Edge @ 3m	
ANT	802.11ax HE40 CH134 5670MHz - R	
1+2	Horizontal	Fundamental
Peak	 <p>Site : DSCH1144 Condition : PEAK_BE([UNIT]), B3 3m HORN 91200-HF HORIZONTAL Detector : Peak Project : 9D0635-01 Setting : Z3</p>	Left blank



WIFI	Band 3 5470~5725MHz Band Edge @ 3m	
ANT	802.11ax HE40 CH134 5670MHz - L	
1+2	Vertical	Fundamental
<p><b>Peak</b></p>	<p>Site : 03CH11-HY            Condition : PEAK_BE(UNIT)_B3 3m HORN 9120D-HF VERTICAL            RBW:1000.000KHz VBW:3000.000KHz SWT:Auto            Detector : Peak            Project : 9D0635-01            Setting : Z3</p>	<p>Site : 03CH11-HY            Condition : PEAK(UNIT) 3m HORN 9120D-HF VERTICAL            RBW:1000.000KHz VBW:3000.000KHz SWT:Auto            Detector : Peak            Project : 9D0635-01            Setting : Z3</p>
<p><b>Avg.</b></p>	<p>Site : 03CH11-HY            Condition : AVG_BE(UNIT)_B3 3m HORN 9120D-HF VERTICAL            RBW:1000.000KHz VBW:0.010KHz SWT:Auto            Detector : Peak            Project : 9D0635-01            Setting : Z3</p>	<p><b>Left blank</b></p>



WIFI	Band 3 5470~5725MHz Band Edge @ 3m	
ANT	802.11ax HE40 CH134 5670MHz - R	
1+2	Vertical	Fundamental
Peak	<p>Site : DSCHE144Y Condition : PEAK_BE([UNIT]), B3 3m HORN 91200-HF VERTICAL Detector : Peak Project : 9D0635-01 Setting : Z3</p>	Left blank



Band 3 - 5470~5725MHz

WIFI 802.11ax HE40 (Partial 242 62RU) (Harmonic @ 3m)

WIFI	Band 3 5470~5725MHz Harmonic @ 3m	
ANT	802.11ax HE40(Partial 242 62RU) CH134 5670MHz	
1+2	Horizontal	Vertical
Peak Avg.	<p>Site : 03CH11-HY  Condition : PEAK(UNEI) 3m HORN 9120D-1HF HORIZONTAL  RBW:1000.000kHz VBW:3000.000kHz SWT:Auto  Detector : Peak  Project : 9D0635-01</p>	<p>Site : 03CH11-HY  Condition : PEAK(UNEI) 3m HORN 9120D-1HF VERTICAL  RBW:1000.000kHz VBW:3000.000kHz SWT:Auto  Detector : Peak  Project : 9D0635-01</p>



Emission below 1GHz  
5GHz WIFI 802.11ax HE80(Full RU) (LF)

WIFI	5GHz WIFI	
ANT	802.11ax HE80(Full RU) LF	
1+2	Horizontal	Vertical
QP / Peak	<p>Site : 03CH11-HY Condition : QP 3m 80LOG_15_41912 HORIZONTAL Detector : Peak Project : 9D0635-01</p>	<p>Site : 03CH11-HY Condition : QP 3m 80LOG_15_41912 VERTICAL Detector : Peak Project : 9D0635-01</p>



### Appendix E. Duty Cycle Plots

Antenna	Band	Duty Cycle(%)	T(us)	1/T(kHz)	VBW Setting	Duty Factor(dB)
1+2	5GHz 802.11ac VHT20 for Ant 1	100.00	-	-	10Hz	0.00
1+2	5GHz 802.11ac VHT20 for Ant 2	100.00	-	-	10Hz	0.00
1+2	5GHz 802.11ac VHT40 for Ant 1	100.00	-	-	10Hz	0.00
1+2	5GHz 802.11ac VHT40 for Ant 2	100.00	-	-	10Hz	0.00
1+2	5GHz 802.11ac VHT80 for Ant 1	100.00	-	-	10Hz	0.00
1+2	5GHz 802.11ac VHT80 for Ant 2	100.00	-	-	10Hz	0.00
1+2	5GHz 802.11ax HE40 for Ant 1	100.00	-	-	10Hz	0.00
1+2	5GHz 802.11ax HE40 for Ant 2	100.00	-	-	10Hz	0.00
1+2	5GHz 802.11ax HE80 for Ant 1	100.00	-	-	10Hz	0.00
1+2	5GHz 802.11ax HE80 for Ant 2	100.00	-	-	10Hz	0.00



MIMO <Ant. 1>

802.11ac VHT20

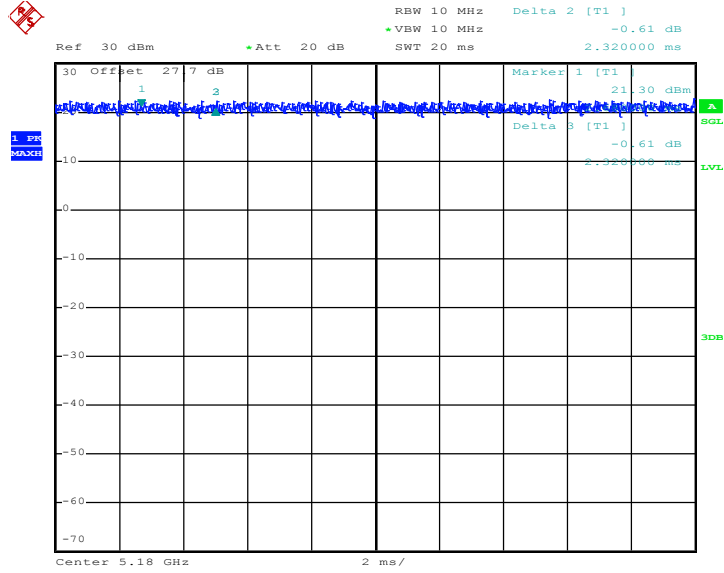

Date: 13.FEB.2020 16:40:59



802.11ac VHT40

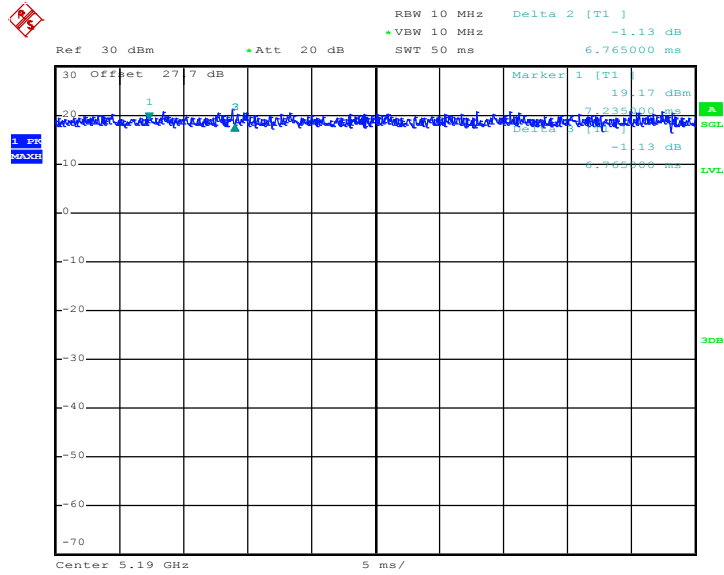

Date: 13.FEB.2020 16:45:19

802.11ac VHT80

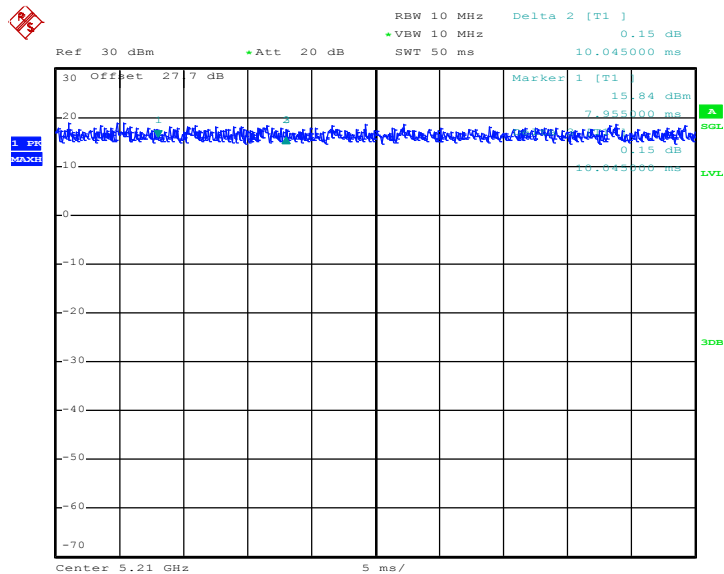

Date: 13.FEB.2020 16:52:34





802.11ax HE40

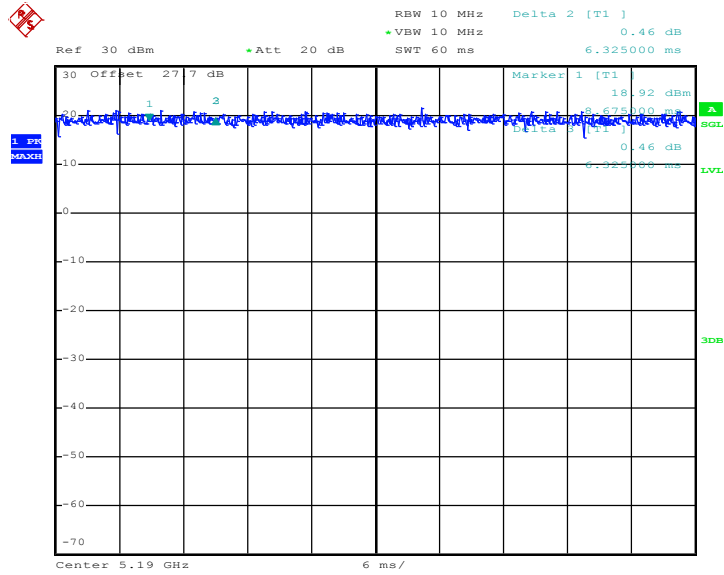

Date: 13.FEB.2020 17:03:31

802.11ax HE80

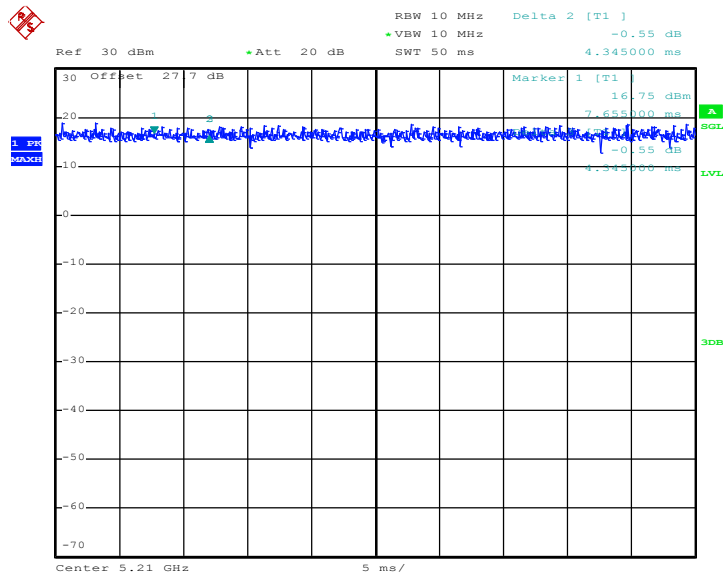

Date: 13.FEB.2020 17:08:19



MIMO <Ant. 2>

802.11ac VHT20

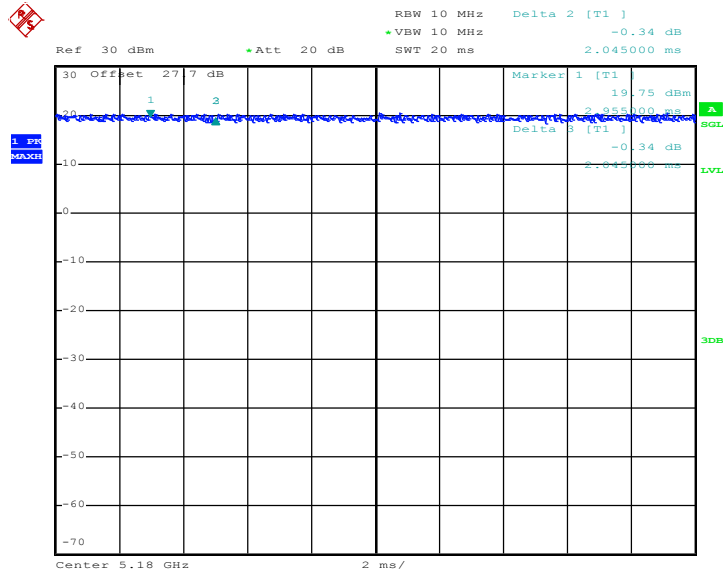

Date: 13.FEB.2020 16:41:35



802.11ac VHT40

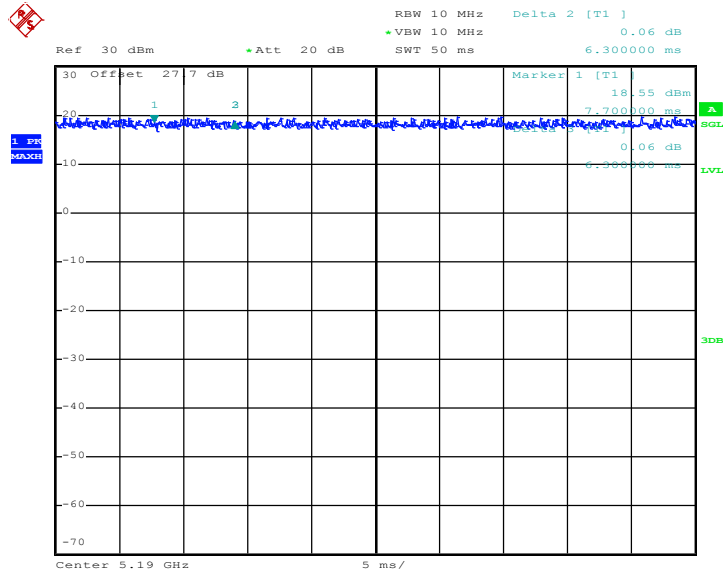

Date: 13.FEB.2020 16:45:58

802.11ac VHT80

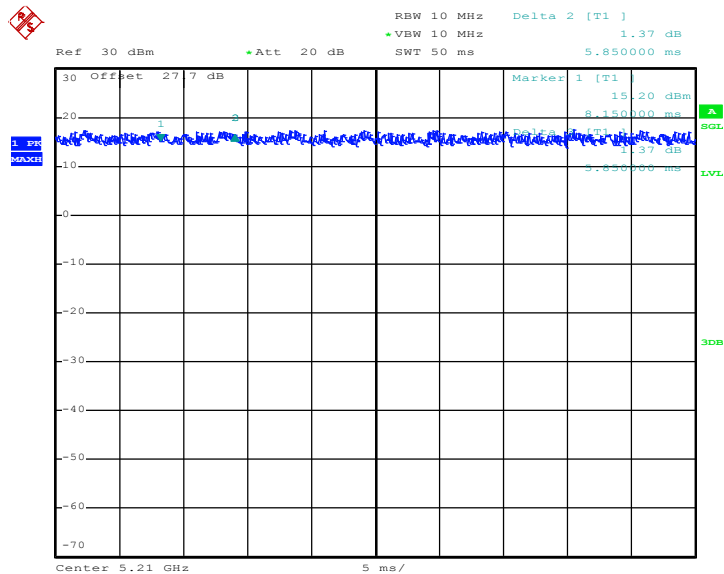

Date: 13.FEB.2020 16:53:21



802.11ax HE40

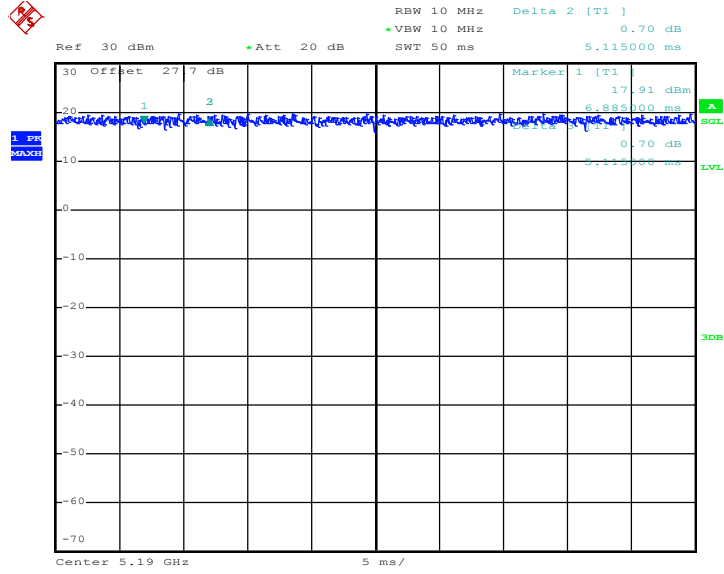

Date: 13.FEB.2020 17:04:03

802.11ax HE80

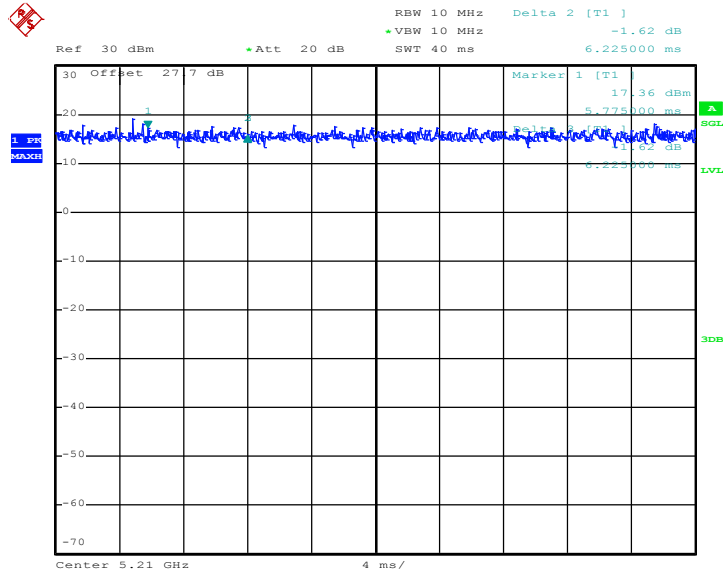

Date: 13.FEB.2020 17:09:18

—THE END—