



FCC RADIO TEST REPORT

FCC ID : IHDT56YJ1
Equipment : Mobile Cellular Phone
Brand Name : Motorola
Model name : XT2061-1
Applicant : Motorola Mobility, LLC
222 W Merchandise Mart Plaza, Suite
1800, Chicago, IL 60654, United States
Manufacturer : Motorola Mobility, LLC
222 W Merchandise Mart Plaza, Suite
1800, Chicago, IL 60654, United States
Standard : FCC Part 15 Subpart E §15.407

The product was received on Dec. 06, 2019 and testing was started from Dec. 26, 2019 and completed on Feb. 12, 2020. We, SPORTON INTERNATIONAL INC., EMC & Wireless Communications Laboratory, would like to declare that the tested sample has been evaluated in accordance with the test procedures and has been in compliance with the applicable technical standards.

The report must not be used by the client to claim product certification, approval, or endorsement by TAF or any agency of government.

The test results in this report apply exclusively to the tested model / sample. Without written approval of SPORTON INTERNATIONAL INC. EMC & Wireless Communications Laboratory, the test report shall not be reproduced except in full.

Louis Wu

Approved by: Louis Wu

SPORTON INTERNATIONAL INC. EMC & Wireless Communications Laboratory

No. 52, Huaya 1st Rd., Guishan Dist., Taoyuan City, Taiwan (R.O.C.)



Table of Contents

History of this test report.....	3
Summary of Test Result	4
1 General Description	5
1.1 Product Feature of Equipment Under Test.....	5
1.2 Product Specification of Equipment Under Test.....	6
1.3 Modification of EUT	7
1.4 Testing Location	8
1.5 Applicable Standards	8
2 Test Configuration of Equipment Under Test	9
2.1 Carrier Frequency and Channel.....	9
2.2 Test Mode	10
2.3 Connection Diagram of Test System	12
2.4 Support Unit used in test configuration and system	14
2.5 EUT Operation Test Setup	14
2.6 Measurement Results Explanation Example.....	14
3 Test Result	15
3.1 6dB and 26dB and 99% Occupied Bandwidth Measurement.....	15
3.2 Maximum Conducted Output Power Measurement	19
3.3 Power Spectral Density Measurement	20
3.4 Unwanted Emissions Measurement	24
3.5 AC Conducted Emission Measurement.....	30
3.6 Automatically Discontinue Transmission	32
3.7 Antenna Requirements.....	34
4 List of Measuring Equipment	36
5 Uncertainty of Evaluation.....	38
Appendix A. Conducted Test Results	
Appendix B. AC Conducted Emission Test Result	
Appendix C. Radiated Spurious Emission	
Appendix D. Radiated Spurious Emission Plots	
Appendix E. Duty Cycle Plots	



Summary of Test Result

Report Clause	Ref Std. Clause	Test Items	Result (PASS/FAIL)	Remark
3.1	15.403 (i)	6dB & 26dB Bandwidth	Pass	-
3.1	2.1049	99% Occupied Bandwidth	Reporting only	-
3.2	15.407 (a)	Maximum Conducted Output Power	Pass	-
3.3	15.407 (a)	Power Spectral Density	Pass	-
3.4	15.407(b)	Unwanted Emissions	Pass	Under limit 4.03 dB at 5631.000 MHz
3.5	15.207	AC Conducted Emission	Pass	Under limit 18.11 dB at 2.300 MHz
3.6	15.407 (c)	Automatically Discontinue Transmission	Pass	-
3.7	15.203 & 15.407 (a)	Antenna Requirement	Pass	-

Declaration of Conformity:

The test results with all measurement uncertainty excluded are presented in accordance with the regulation limits or requirements declared by manufacturers.

Comments and Explanations:

The declared of product specification for EUT presented in the report are provided by the manufacturer, and the manufacturer takes all the responsibilities for the accuracy of product specification.

Reviewed by: Wii Chang

Report Producer: Ann Lee



1 General Description

1.1 Product Feature of Equipment Under Test

Product Feature	
Equipment	Mobile Cellular Phone
Brand Name	Motorola
Model Name	XT2061-1
FCC ID	IHDT56YJ1
IMEI Code	Conducted : IMEI: 359120100011371 Conduction : IMEI: 359120100016479 Radiation : IMEI: 359120100017048
EUT supports Radios application	CDMA/EV-DO/GSM/EGPRS/WCDMA/HSPA/LTE/5G NR/ GNSS/NFC/WPC WLAN 11b/g/n HT20 WLAN 11a/n HT20/HT40 WLAN 11ac VHT20/VHT40/VHT80 WLAN 11ax HE20/HE40/HE80 Bluetooth BR/EDR/LE
HW Version	DVT2
EUT Stage	Identical Prototype

Remark: The above EUT's information was declared by manufacturer.

Accessory List	
AC Adapter 1	Brand Name : Motorola
	Model Name : SC-51 (SA18C30116)
	Manufacturer : Chenyang
AC Adapter 2	Brand Name : Motorola
	Model Name : SC-51 (SA18C62985)
	Manufacturer : Acbel
Battery	Brand Name : ATL
	Model Name : LW50
USB Cable 1	Brand Name : Motorola
	Model Name : SC18C24367
	Manufacturer : Saibao
USB Cable 2	Brand Name : Motorola
	Model Name : SC18C24368
	Manufacturer : Luxshare



1.2 Product Specification of Equipment Under Test

Standards-related Product Specification	
Tx/Rx Frequency Range	5745 MHz ~ 5825 MHz
Maximum Output Power to Antenna <CDD Modes>	<p><5745 MHz ~ 5825 MHz></p> <p><Ant. 1> 802.11a : 16.90 dBm / 0.0490 W 802.11n HT20 : 17.00 dBm / 0.0501 W 802.11n HT40 : 16.90 dBm / 0.0490 W 802.11ac VHT20: 17.10 dBm / 0.0513 W 802.11ac VHT40: 17.00 dBm / 0.0501 W 802.11ac VHT80: 17.10 dBm / 0.0513 W 802.11ax HE20 : 17.20 dBm / 0.0525 W 802.11ax HE40 : 17.20 dBm / 0.0525 W 802.11ax HE80 : 17.00 dBm / 0.0501 W</p> <p><Ant. 2> 802.11a : 17.00 dBm / 0.0501 W 802.11n HT20 : 17.10 dBm / 0.0513 W 802.11n HT40 : 16.80 dBm / 0.0479 W 802.11ac VHT20: 17.20 dBm / 0.0525 W 802.11ac VHT40: 17.20 dBm / 0.0525 W 802.11ac VHT80: 16.80 dBm / 0.0479 W 802.11ax HE20 : 17.20 dBm / 0.0525 W 802.11ax HE40 : 17.20 dBm / 0.0525 W 802.11ax HE80 : 16.80 dBm / 0.0479 W</p> <p>MIMO <Ant. 1 + 2> 802.11a : 20.11 dBm / 0.1026 W 802.11n HT20 : 20.22 dBm / 0.1052 W 802.11n HT40 : 20.21 dBm / 0.1050 W 802.11ac VHT20: 20.27 dBm / 0.1064 W 802.11ac VHT40: 20.27 dBm / 0.1064 W 802.11ac VHT80: 20.14 dBm / 0.1033 W 802.11ax HE20 : 20.27 dBm / 0.1064 W 802.11ax HE40 : 20.28 dBm / 0.1067 W 802.11ax HE80 : 20.10 dBm / 0.1023 W</p>
Maximum Output Power to Antenna <TXBF Modes>	<p>MIMO <Ant. 1 + 2> 802.11ac VHT20: 18.30 dBm / 0.0676 W 802.11ac VHT40: 18.47 dBm / 0.0703 W 802.11ac VHT80: 18.45 dBm / 0.0700 W 802.11ax HE20 : 18.41 dBm / 0.0693 W 802.11ax HE40 : 18.15 dBm / 0.0653 W 802.11ax HE80 : 17.97 dBm / 0.0627 W</p>



Standards-related Product Specification														
99% Occupied Bandwidth <CDD Modes>	MIMO <Ant. 1> 802.11a : 30.82 MHz 802.11ac VHT20 : 32.47 MHz 802.11ac VHT40 : 38.06 MHz 802.11ac VHT80 : 77.44 MHz 802.11ax HE20 : 23.98 MHz 802.11ax HE40 : 48.35 MHz 802.11ax HE80 : 79.72 MHz MIMO <Ant. 2> 802.11a : 33.47 MHz 802.11ac VHT20 : 36.21 MHz 802.11ac VHT40 : 68.23 MHz 802.11ac VHT80 : 99.14 MHz 802.11ax HE20 : 35.61 MHz 802.11ax HE40 : 70.33 MHz 802.11ax HE80 : 97.82 MHz													
99% Occupied Bandwidth <TXBF Modes>	MIMO <Ant. 1> 802.11ac VHT20 : 17.83 MHz 802.11ac VHT40 : 37.36 MHz 802.11ac VHT80 : 78.04 MHz 802.11ax HE20 : 17.83 MHz 802.11ax HE40 : 36.76 MHz 802.11ax HE80 : 78.04 MHz MIMO <Ant. 2> 802.11ac VHT20 : 17.78 MHz 802.11ac VHT40 : 37.36 MHz 802.11ac VHT80 : 77.32 MHz 802.11ax HE20 : 17.83 MHz 802.11ax HE40 : 38.16 MHz 802.11ax HE80 : 77.56 MHz													
Type of Modulation	802.11a/n : OFDM (BPSK / QPSK / 16QAM / 64QAM) 802.11ac : OFDM (BPSK / QPSK / 16QAM / 64QAM / 256QAM) 802.11ax: OFDM (BPSK / QPSK / 16QAM / 64QAM / 256QAM / 1024QAM)													
Antenna Gain / Gain	<Ant. 1> : ILA Antenna with gain 1.50 dBi <Ant. 2> : ILA Antenna with gain 1.30 dBi													
Antenna Function Description	<table border="1"> <thead> <tr> <th></th> <th>Ant. 1</th> <th>Ant. 2</th> </tr> </thead> <tbody> <tr> <td>802.11 a/n/ac/ax</td> <td>V</td> <td>V</td> </tr> <tr> <td>802.11 a/n/ac/ax MIMO</td> <td>V</td> <td>V</td> </tr> <tr> <td>802.11 ac/ax TXBF</td> <td>V</td> <td>V</td> </tr> </tbody> </table>			Ant. 1	Ant. 2	802.11 a/n/ac/ax	V	V	802.11 a/n/ac/ax MIMO	V	V	802.11 ac/ax TXBF	V	V
	Ant. 1	Ant. 2												
802.11 a/n/ac/ax	V	V												
802.11 a/n/ac/ax MIMO	V	V												
802.11 ac/ax TXBF	V	V												

Note: MIMO Ant. 1+2 is a calculated result from sum of the power MIMO Ant. 1 and MIMO Ant. 2.

1.3 Modification of EUT

No modifications are made to the EUT during all test items.



1.4 Testing Location

Test Site	SPORTON INTERNATIONAL INC. EMC & Wireless Communications Laboratory	
Test Site Location	No.52, Huaya 1st Rd., Guishan Dist., Taoyuan City, Taiwan (R.O.C.) TEL: +886-3-327-3456 FAX: +886-3-328-4978	
Test Site No.	Sporton Site No.	
	TH05-HY	CO05-HY

Note: The test site complies with ANSI C63.4 2014 requirement.

Test Site	SPORTON INTERNATIONAL INC. EMC & Wireless Communications Laboratory	
Test Site Location	No.58, Aly. 75, Ln. 564, Wenhua 3rd, Rd., Guishan Dist., Taoyuan City, Taiwan (R.O.C.) TEL: +886-3-327-0868 FAX: +886-3-327-0855	
Test Site No.	Sporton Site No.	
	03CH11-HY	

Note: The test site complies with ANSI C63.4 2014 requirement.

FCC designation No.: TW1190 and TW0007

1.5 Applicable Standards

According to the specifications of the manufacturer, the EUT must comply with the requirements of the following standards:

- ♦ FCC Part 15 Subpart E
- ♦ FCC KDB 789033 D02 General UNII Test Procedures New Rules v02r01.
- ♦ FCC KDB 414788 D01 Radiated Test Site v01r01.
- ♦ FCC KDB 662911 D01 Multiple Transmitter Output v02r01.
- ♦ ANSI C63.10-2013

Remark:

1. All test items were verified and recorded according to the standards and without any deviation during the test.
2. This EUT has also been tested and complied with the requirements of FCC Part 15, Subpart B, recorded in a separate test report.



2 Test Configuration of Equipment Under Test

- a. The EUT has been associated with peripherals and configuration operated in a manner tended to maximize its emission characteristics in a typical application. Frequency range investigated: conduction emission (150 kHz to 30 MHz), radiation emission (9 kHz to the 10th harmonic of the highest fundamental frequency or to 40 GHz, whichever is lower). For radiated measurement, pre-scanned in three orthogonal panels, X, Y, Z. The worst cases (Y plane) were recorded in this report.

- b. AC power line Conducted Emission was tested under maximum output power.

2.1 Carrier Frequency and Channel

Frequency Band	Channel	Freq. (MHz)	Channel	Freq. (MHz)
5725-5850 MHz Band 4 (U-NII-3)	149	5745	157	5785
	151*	5755	159*	5795
	153	5765	161	5805
	155#	5775	165	5825

Note:

- 1. The above Frequency and Channel in "*" were 802.11n HT40 and 802.11ac VHT40.
- 2. The above Frequency and Channel in "#n" were 802.11ac VHT80.



2.2 Test Mode

Final test modes are considering the modulation and worse data rates as below table.

MIMO Mode

Modulation	Data Rate
802.11a	6 Mbps
802.11n HT20 (Covered by VHT20)	MCS0
802.11n HT40 (Covered by VHT40)	MCS0
802.11ac VHT20	MCS0
802.11ac VHT40	MCS0
802.11ac VHT80	MCS0
802.11ax HE20	MCS0
802.11ax HE40	MCS0
802.11ax HE80	MCS0

TXBF Mode

Modulation	Data Rate
802.11ac VHT20	MCS0
802.11ac VHT40	MCS0
802.11ac VHT80	MCS0
802.11ax HE20	MCS0
802.11ax HE40	MCS0
802.11ax HE80	MCS0



Test Cases	
AC Conducted Emission	Mode 1 : GSM850 Idle + Bluetooth Link + WLAN (5GHz) Link + MPEG4 + Earphone + Battery + USB Cable 1 (Charging from Adapter 1)
Remark: For Radiated Test Cases, the tests were performed with Adapter 1 and USB Cable 1.	

Ch. #		Band IV : 5725-5850 MHz			
		802.11a	802.11ac VHT20	802.11ac VHT40	802.11ac VHT80
L	Low	149	149	151	-
M	Middle	157	157	-	155
H	High	165	165	159	-

Ch. #		Band IV : 5725-5850 MHz		
		802.11ax HE20	802.11ax HE40	802.11ax HE80
L	Low	149	151	-
M	Middle	157	-	155
H	High	165	159	-

Remark: For radiation spurious emission, the final modulation and the worst data rate was reference the max RF conducted power.

2.3 Connection Diagram of Test System

<WLAN Tx Mode>

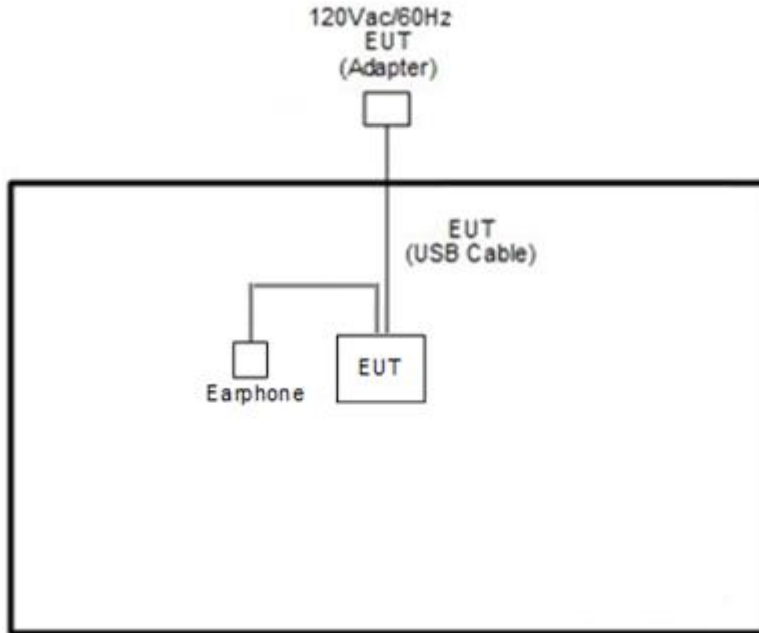

<TXBF Mode>

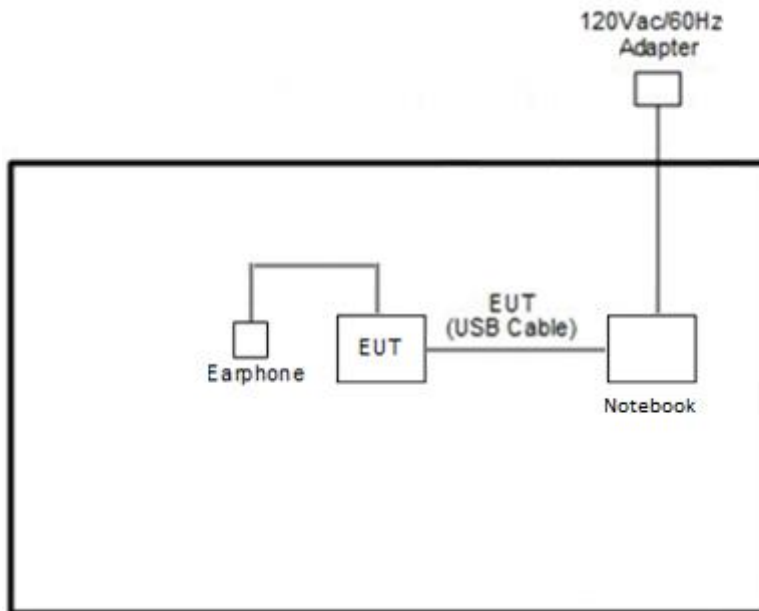

<AC Conducted Emission Mode>

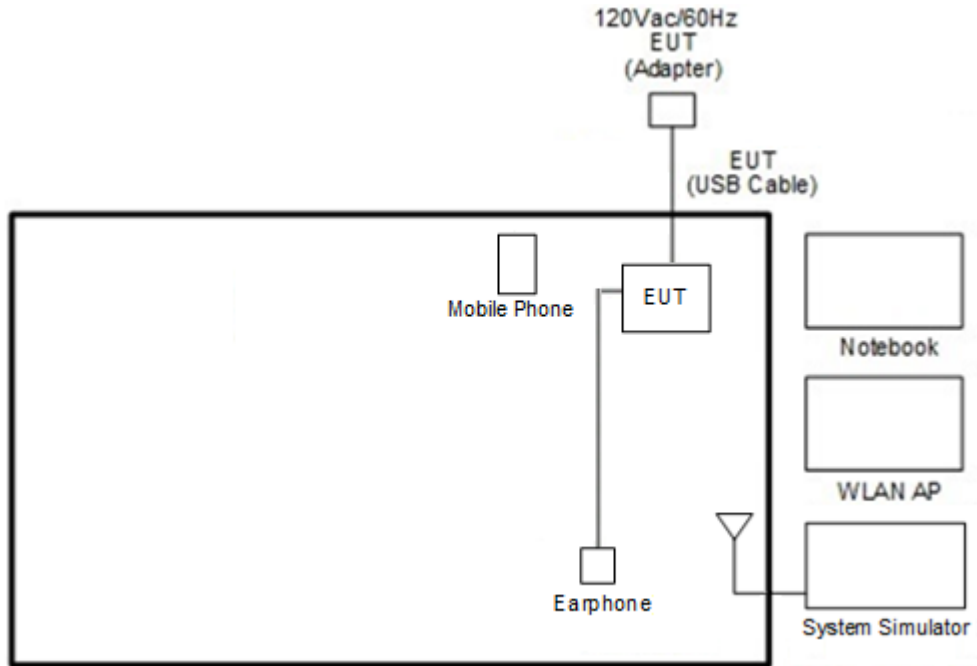

2.4 Support Unit used in test configuration and system

Item	Equipment	Trade Name	Model Name	FCC ID	Data Cable	Power Cord
1.	System Simulator	R&S	CMU 200	N/A	N/A	Unshielded, 1.8 m
2.	WLAN AP	ASUS	RT-AC66U	MSQ-RTAC66U	N/A	Unshielded, 1.8 m
3.	Notebook	DELL	Latitude E3400	FCC DoC	N/A	AC I/P: Unshielded, 1.2 m DC O/P: Shielded, 1.8 m
4.	Mobile Phone	Moto	moto burton	N/A	N/A	N/A
5.	Earphone	Moto	NASH38C16618	N/A	Unshielded, 1.0 m	N/A

2.5 EUT Operation Test Setup

The RF test items, utility “QRCT v4.0.00142.0” was installed in Notebook which was programmed in order to make the EUT get into the engineering modes to provide channel selection, power level, data rate and the application type and for continuous transmitting signals.

For TXBF mode, the modulation modes and data rates manipulated by the command lines in the engineering program made the EUT link to another EUT by power under the normal operation. The “QRCT V4.0.00142.0” software tool was used to enable the EUT to transmit signals continuously.

2.6 Measurement Results Explanation Example

For all conducted test items:

The offset level is set in the spectrum analyzer to compensate the RF cable loss and attenuator factor between EUT conducted output port and spectrum analyzer. With the offset compensation, the spectrum analyzer reading level is exactly the EUT RF output level.

Example :

The spectrum analyzer offset is derived from RF cable loss and attenuator factor.

Offset = RF cable loss + attenuator factor.

Following shows an offset computation example with cable loss 4.2 dB and 10dB attenuator.

$$\begin{aligned}
 \text{Offset(dB)} &= \text{RF cable loss(dB)} + \text{attenuator factor(dB)}. \\
 &= 4.2 + 10 = 14.2 \text{ (dB)}
 \end{aligned}$$

3 Test Result

3.1 6dB and 26dB and 99% Occupied Bandwidth Measurement

3.1.1 Description of 6dB and 26dB and 99% Occupied Bandwidth

The minimum 6 dB bandwidth shall be at least 500 kHz.

26dB and 99% Occupied bandwidth are reporting only.

3.1.2 Measuring Instruments

See list of measuring equipment of this test report.

3.1.3 Test Procedures

1. The testing follows FCC KDB 789033 D02 General UNII Test Procedures New Rules v02r01. Section C) Emission bandwidth for the band 5.725-5.85GHz
2. Set RBW = 100kHz.
3. Set the VBW $\geq 3 \times$ RBW.
4. Detector = Peak.
5. Trace mode = max hold
6. Measure the maximum width of the emission that is 6 dB down from the peak of the emission.
7. Measure and record the results in the test report.

3.1.4 Test Setup

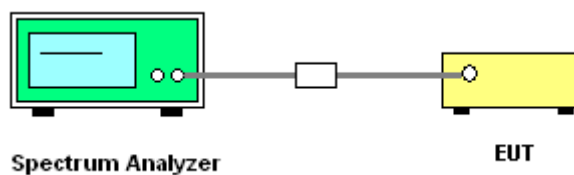

3.1.5 Test Result of 6dB and 26dB and 99% Occupied Bandwidth

Please refer to Appendix A.



<CDD Mode>

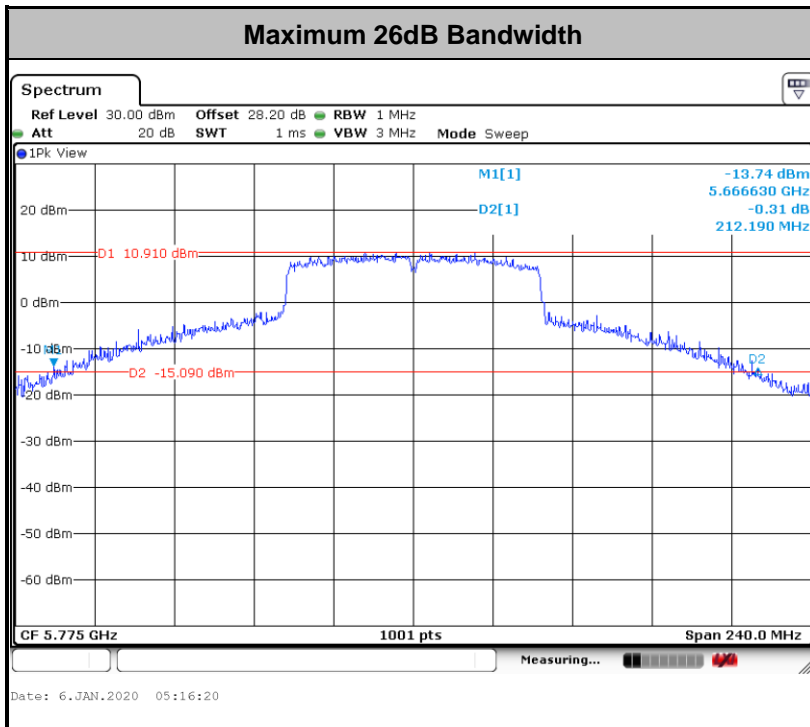
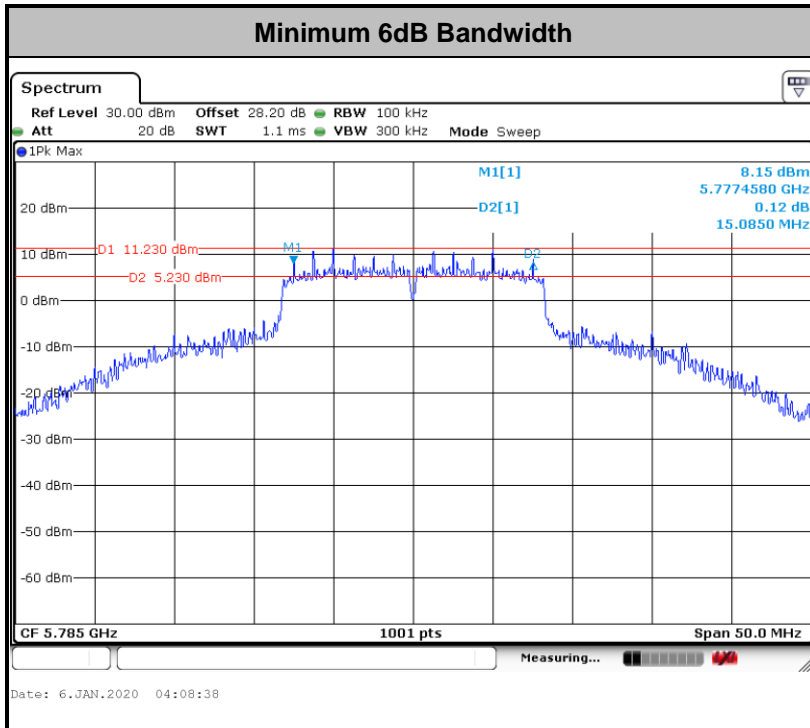

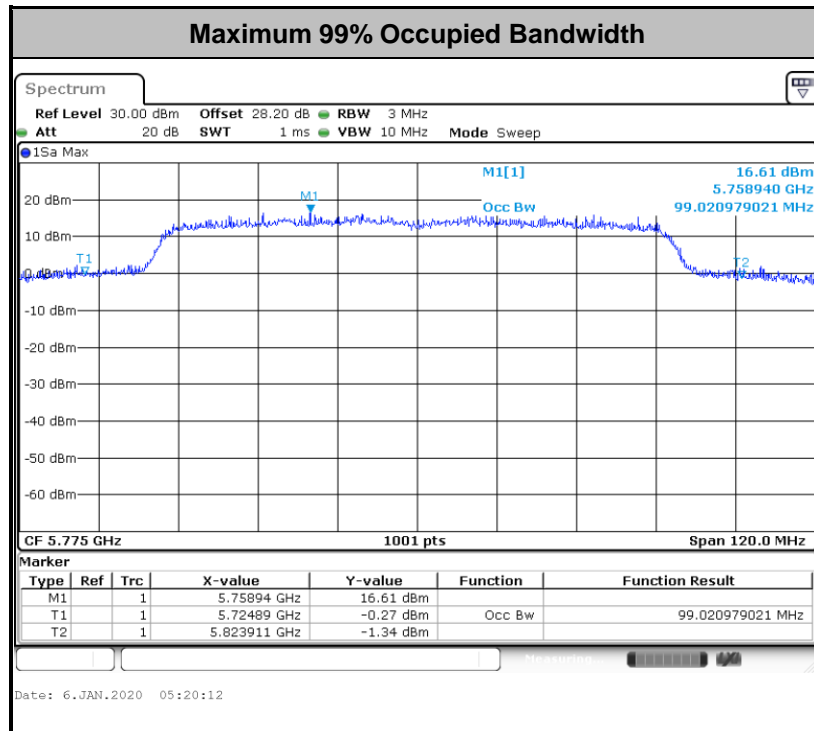

Note: The occupied channel bandwidth is maintained within the band of operation for all of the modulations.

<TXBF Modes>

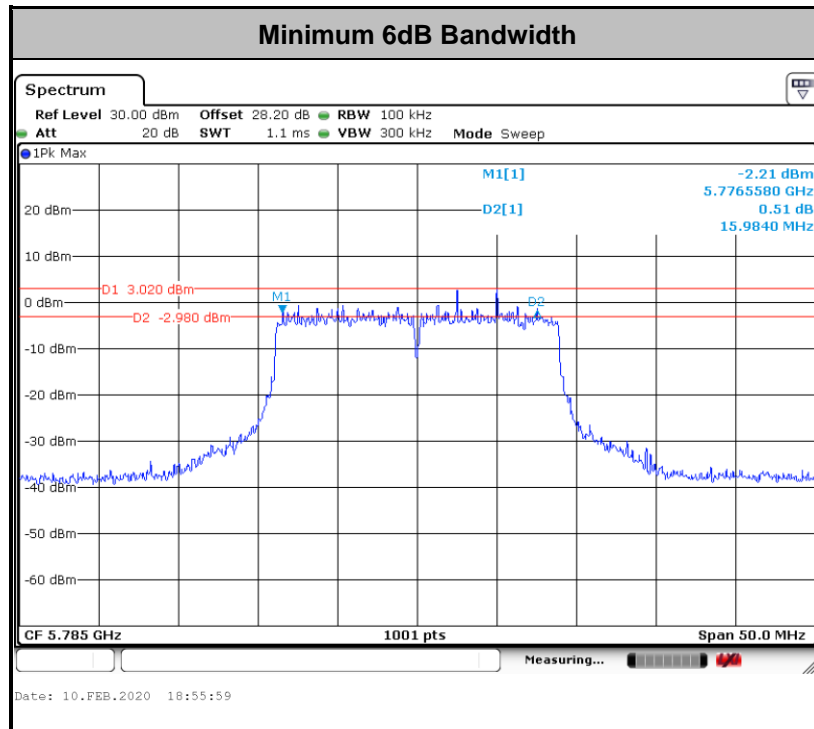

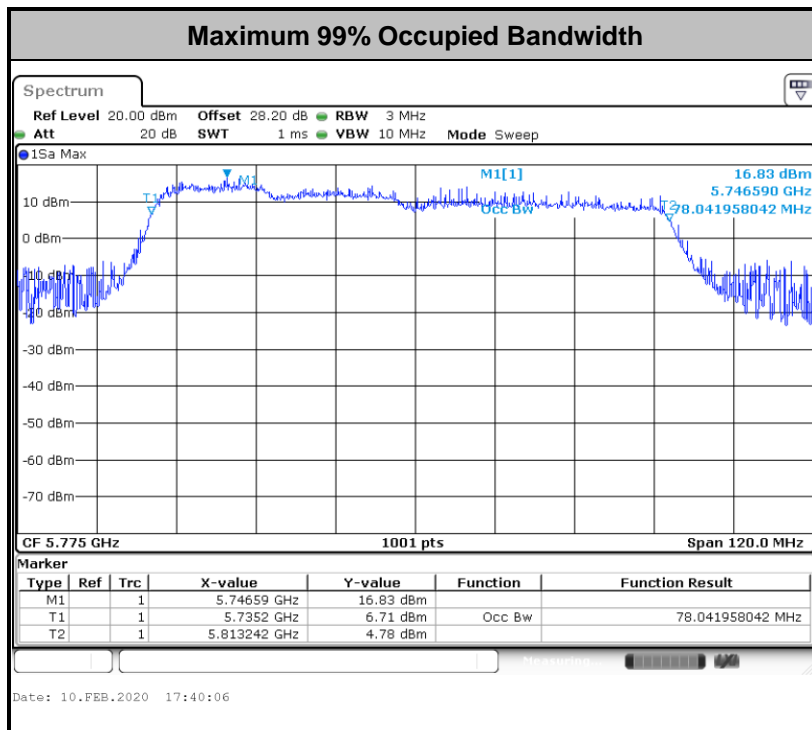
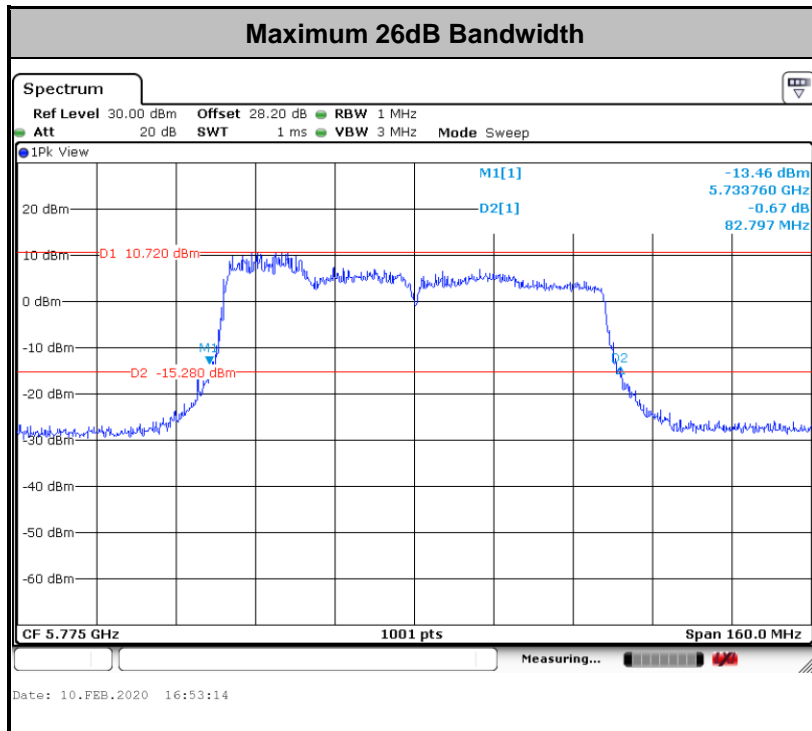

Note: The occupied channel bandwidth is maintained within the band of operation for all of the modulations.

3.2 Maximum Conducted Output Power Measurement

3.2.1 Limit of Maximum Conducted Output Power

For the band 5.725–5.85 GHz, the maximum conducted output power over the frequency band of operation shall not exceed 1 W.

If transmitting antennas of directional gain greater than 6 dBi are used, the peak output power shall be reduced by the amount in dB that the directional gain of the antenna exceeds 6 dBi.

3.2.2 Measuring Instruments

See list of measuring equipment of this test report.

3.2.3 Test Procedures

The testing follows Method PM-G of FCC KDB 789033 D02 General UNII Test Procedures New Rules v02r01

Method PM-G (Measurement using a gated RF average power meter):

1. Measurement is performed using a wideband RF power meter.
2. The EUT is configured to transmit at its maximum power control level.
3. Measure the average power of the transmitter
4. Since the measurement is made only during the ON time of the transmitter, no duty cycle correction factor is required.

3.2.4 Test Setup

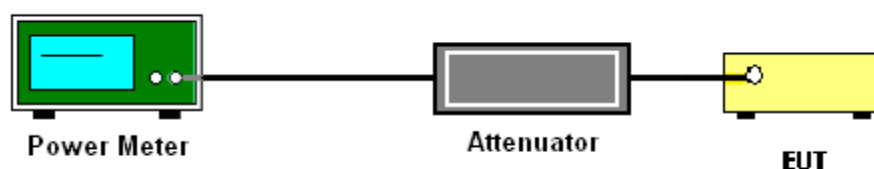

3.2.5 Test Result of Maximum Conducted Output Power

Please refer to Appendix A.



3.3 Power Spectral Density Measurement

3.3.1 Limit of Power Spectral Density

For the band 5.725–5.85 GHz, the maximum power spectral density shall not exceed 30 dBm in any 500-kHz band.

If transmitting antennas of directional gain greater than 6 dBi are used, the peak output power shall be reduced by the amount in dB that the directional gain of the antenna exceeds 6 dBi.

3.3.2 Measuring Instruments

See list of measuring equipment of this test report.

3.3.3 Test Procedures

The testing follows FCC KDB 789033 D02 General UNII Test Procedures New Rules v02r01. Section F) Maximum power spectral density.

Method SA-3

(power averaging (rms) detection with max hold):

- Set span to encompass the entire emission bandwidth (EBW) of the signal.
- Set RBW = 300 kHz.
- Set VBW \geq 1 MHz.
- Number of points in sweep \geq 2 Span / RBW.
- Sweep time \leq (number of points in sweep) \times T, when duty cycle is less than 98 percent where T is the minimum transmission duration over which the transmitter is on and is transmitting at its maximum power control level for the tested mode of operation.
- Detector = power averaging (rms).
- Trace mode = max hold.
- Allow max hold to run for at least 60 seconds, or longer as needed to allow the trace to stabilize.

1. The RF output of EUT was connected to the spectrum analyzer by a low loss cable.
2. Each plot has already offset with cable loss, and attenuator loss. Measure the PPSD and record it.
3. For MIMO mode, calculation method follows FCC KDB 662911 D01 Multiple Transmitter Output v02r01.

Method (c): Measure and add $10 \log(N_{\text{ANT}})$ dB.

With this technique, spectrum measurements are performed at each output of the device, but rather than summing the spectra or the spectral peaks across the outputs, the quantity $10 \log(N_{\text{ANT}})$ dB is added to each spectrum value before comparing to the emission limit. The addition of $10 \log(N_{\text{ANT}})$ dB serves to apportion the emission limit among the N_{ANT} outputs so that each output is permitted to contribute no more than $1/N_{\text{ANT}}^{\text{th}}$ of the PSD limit.

3.3.4 Test Setup

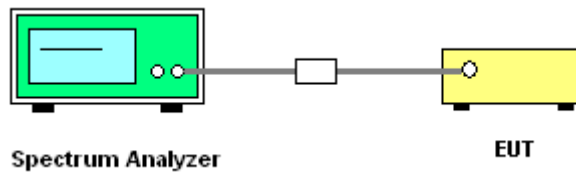



3.3.5 Test Result of Power Spectral Density

Please refer to Appendix A.

<CDD Modes>

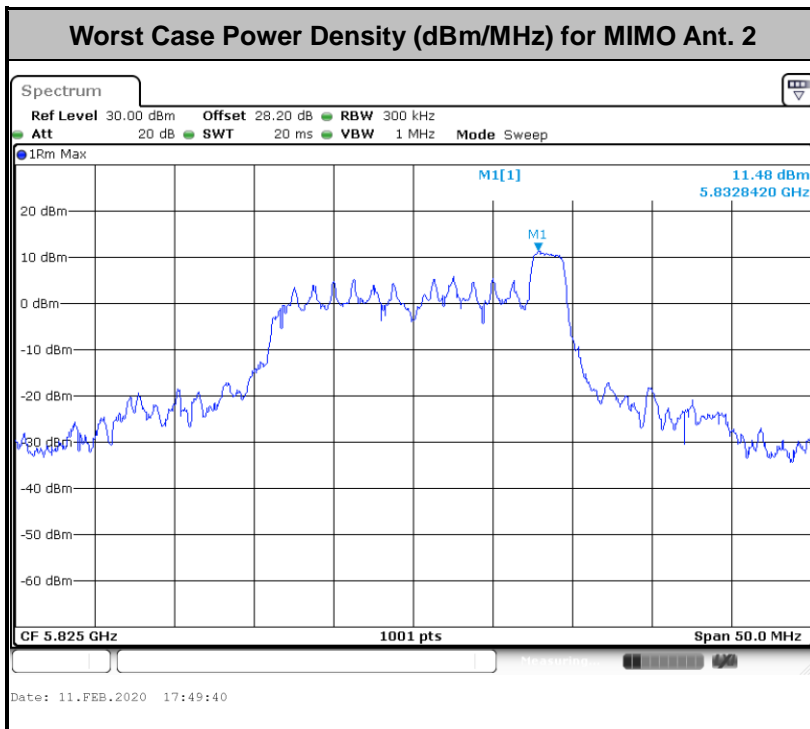
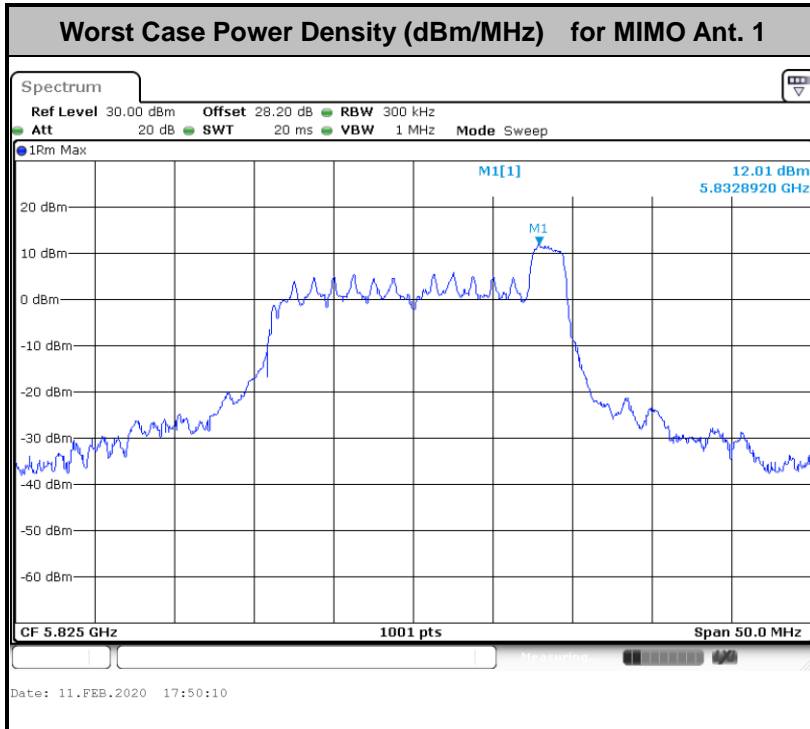



<TXBF Modes>

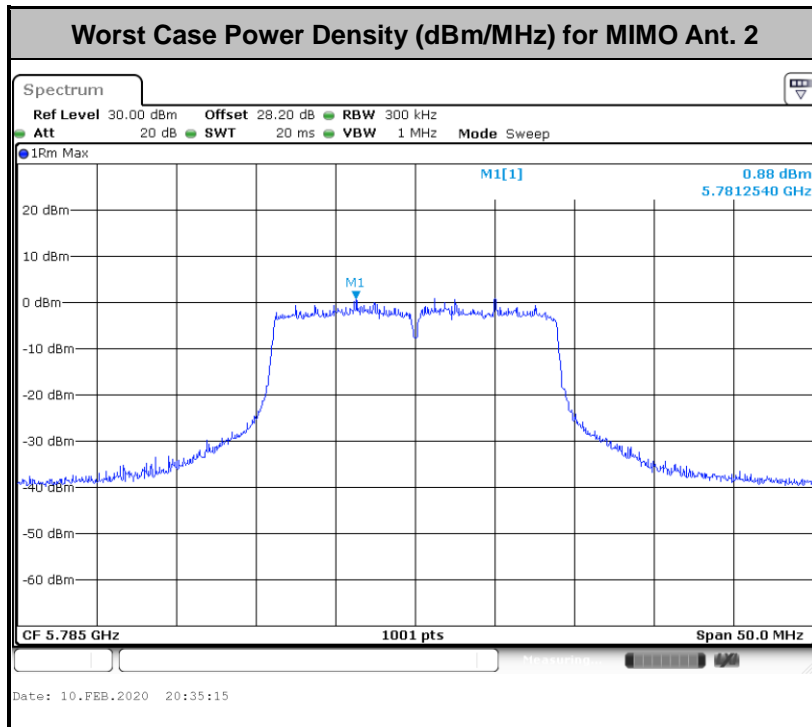
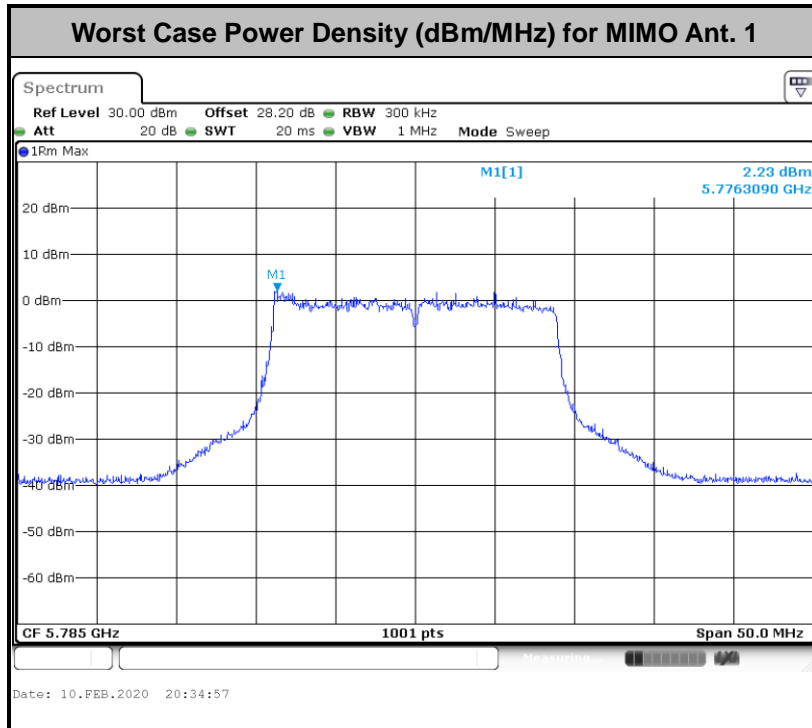



3.4 Unwanted Emissions Measurement

This section is to measure unwanted emissions through radiated measurement for band edge spurious emissions and out of band emissions measurement.

3.4.1 Limit of Unwanted Emissions

(1) For transmitters operating in the 5.725-5.85 GHz band:

15.407(b)(4)(i) All emissions shall be limited to a level of -27 dBm/MHz at 75 MHz or more above or below the band edge increasing linearly to 10 dBm/MHz at 25 MHz above or below the band edge, and from 25 MHz above or below the band edge increasing linearly to a level of 15.6 dBm/MHz at 5 MHz above or below the band edge, and from 5 MHz above or below the band edge increasing linearly to a level of 27 dBm/MHz at the band edge.

(2) Unwanted spurious emissions fallen in restricted bands shall comply with the general field strength limits as below table,

Frequency (MHz)	Field Strength (microvolts/meter)	Measurement Distance (meters)
0.009 – 0.490	2400/F(kHz)	300
0.490 – 1.705	24000/F(kHz)	30
1.705 – 30.0	30	30
30 – 88	100	3
88 – 216	150	3
216 - 960	200	3
Above 960	500	3

Note: The following formula is used to convert the EIRP to field strength.

$$E = \frac{1000000\sqrt{30P}}{3} \mu\text{V/m, where P is the eirp (Watts)}$$



EIRP (dBm)	Field Strength at 3m (dBμV/m)
- 27	68.3

(3) KDB789033 D02 v02r01 G)2)c)

- (i) Sections 15.407(b)(1-3) specifies the unwanted emissions limit for the U-NII-1 and U-NII-2 bands. As specified, emissions above 1000 MHz that are outside of the restricted bands are subject to a peak emission limit of -27 dBm/MHz.
- (ii) Section 15.407(b)(4) specifies the unwanted emissions limit for the U-NII-3 band. A band emissions mask is specified in Section 15.407(b)(4)(i). The emission limits are based on the use of a peak detector.

3.4.2 Measuring Instruments

See list of measuring equipment of this test report.

3.4.3 Test Procedures

1. The testing follows FCC KDB 789033 D02 General UNII Test Procedures New Rules v02r01. Section G) Unwanted emissions measurement.

(1) Procedure for Unwanted Emissions Measurements Below 1000MHz

- RBW = 120 kHz
- VBW = 300 kHz
- Detector = Peak
- Trace mode = max hold

(2) Procedure for Peak Unwanted Emissions Measurements Above 1000 MHz

- RBW = 1 MHz
- VBW ≥ 3 MHz
- Detector = Peak
- Sweep time = auto
- Trace mode = max hold

(3) Procedures for Average Unwanted Emissions Measurements Above 1000MHz

- RBW = 1 MHz
- VBW = 10 Hz, when duty cycle is no less than 98 percent.
- VBW ≥ 1/T, when duty cycle is less than 98 percent where T is the minimum transmission duration over which the transmitter is on and is transmitting at its maximum power control level for the tested mode of operation.



2. The EUT was placed on a turntable with 0.8 meter for frequency below 1GHz and 1.5 meter for frequency above 1GHz respectively above ground.
3. The EUT was set 3 meters from the interference receiving antenna which was mounted on the top of a variable height antenna tower.
4. The antenna is a broadband antenna and its height is adjusted between one meter and four meters above ground to find the maximum value of the field strength for both horizontal polarization and vertical polarization of the antenna.
5. For each suspected emission, the EUT was arranged to its worst case and then adjust the antenna tower (from 1 m to 4 m) and turntable (from 0 degree to 360 degrees) to find the maximum reading.
6. For testing below 1GHz, if the emission level of the EUT in peak mode was 3 dB lower than the limit specified, then peak values of EUT will be reported, otherwise, the emissions will be repeated one by one using the CISPR quasi-peak method and reported.
7. For testing above 1GHz, the emission level of the EUT in peak mode was 20dB lower than average limit (that means the emission level in average mode also complies with the limit in average mode), then peak values of EUT will be reported, otherwise, the emissions will be measured in average mode again and reported.

3.4.4 Test Setup

For radiated emissions below 30MHz

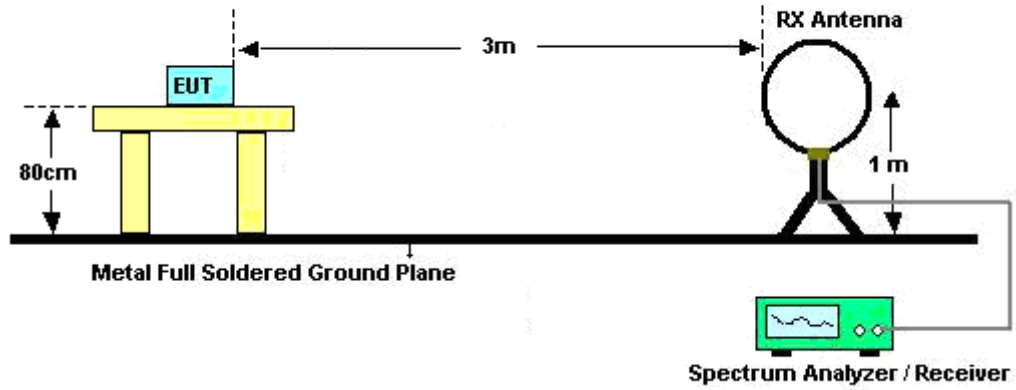

For radiated emissions from 30MHz to 1GHz

<CDD Mode>

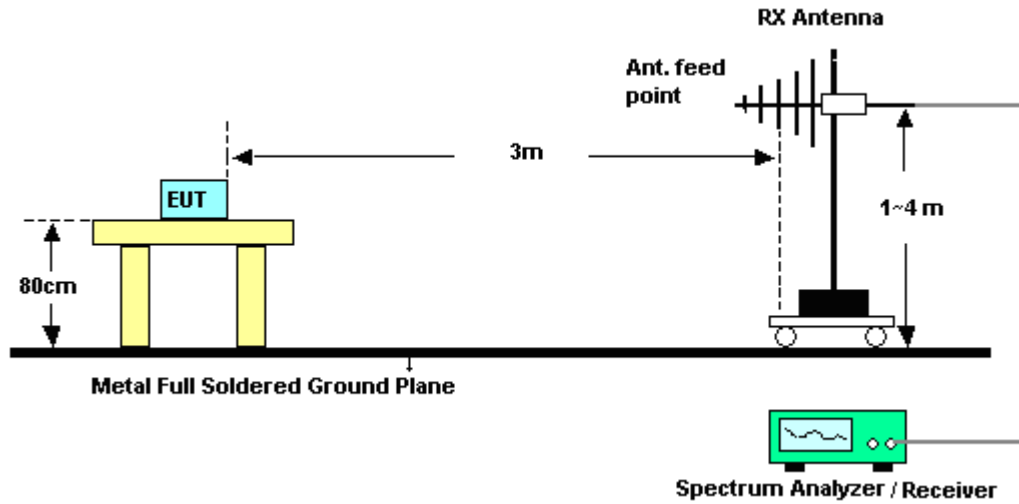

<TXBF Modes>

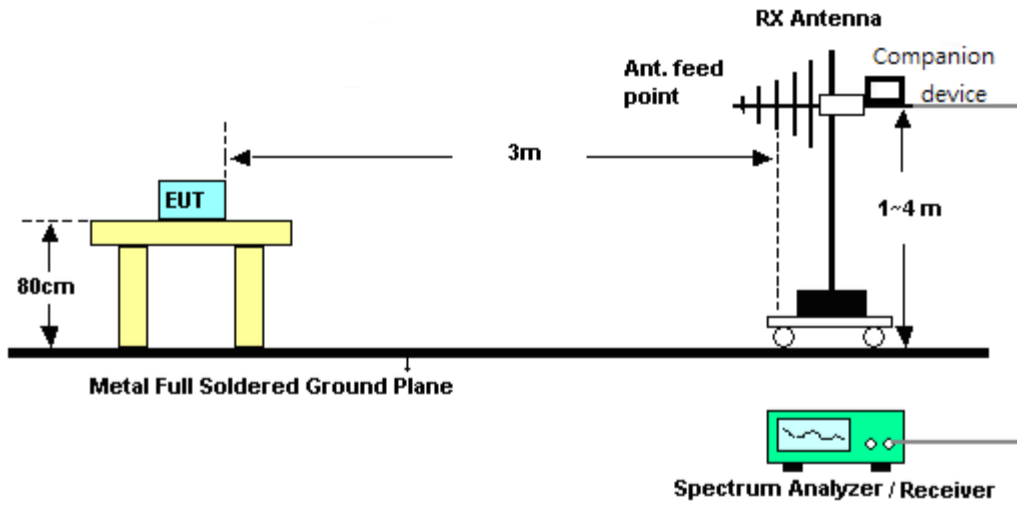

For radiated emissions above 1GHz

<CDD Mode>

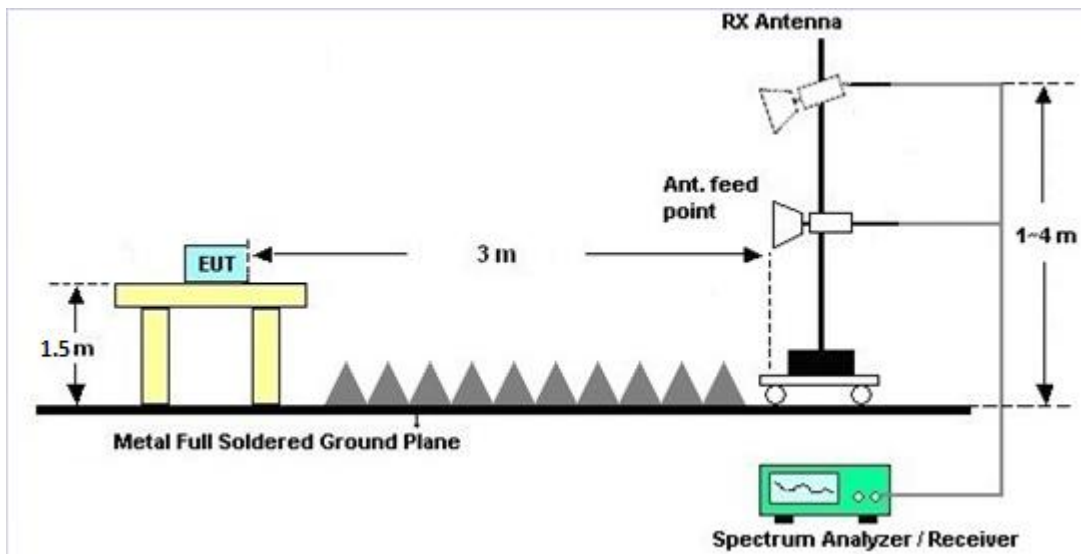

<TXBF Modes>

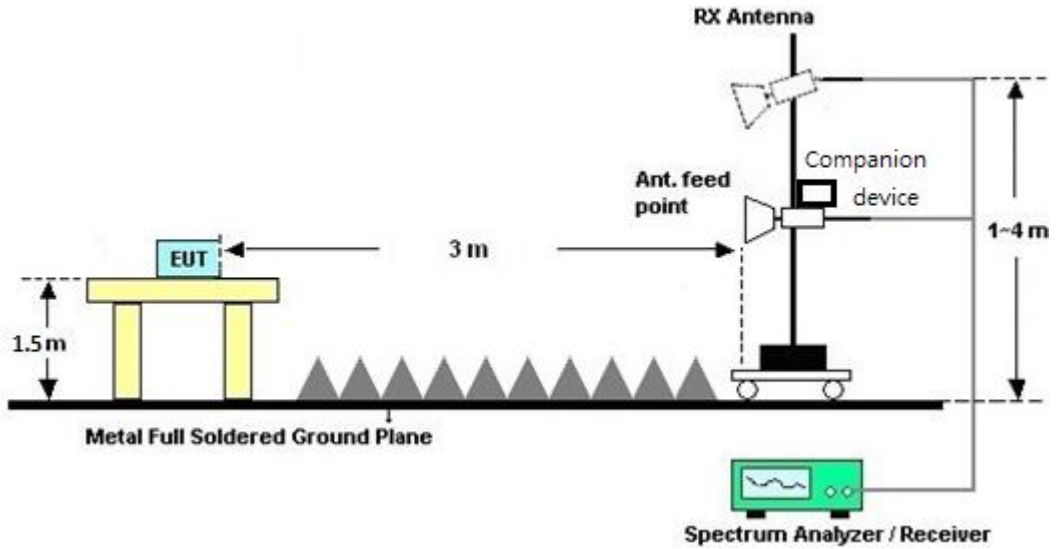

3.4.5 Test Results of Radiated Emissions (9 kHz ~ 30 MHz)

The low frequency, which started from 9 kHz to 30MHz, was pre-scanned and the result which was 20dB lower than the limit line was not reported.

There is a comparison data of both open-field test site and alternative test site - semi-Anechoic chamber according to 414788 D01 Radiated Test Site v01r01, and the result came out very similar.

3.4.6 Test Result of Radiated Band Edges

Please refer to Appendix C and D.

3.4.7 Duty Cycle

Please refer to Appendix E.

3.4.8 Test Result of Unwanted Radiated Emission (30MHz ~ 10th Harmonic)

Please refer to Appendix C and D.



3.5 AC Conducted Emission Measurement

3.5.1 Limit of AC Conducted Emission

For equipment that is designed to be connected to the public utility (AC) power line, the radio frequency voltage that is conducted back onto the AC power line on any frequency or frequencies within the band 150 kHz to 30 MHz shall not exceed the limits in the following table.

Frequency of emission (MHz)	Conducted limit (dB μ V)	
	Quasi-peak	Average
0.15-0.5	66 to 56*	56 to 46*
0.5-5	56	46
5-30	60	50

*Decreases with the logarithm of the frequency.

3.5.2 Measuring Instruments

See list of measuring equipment of this test report.

3.5.3 Test Procedures

1. The EUT was placed 0.4 meter from the conducting wall of the shielding room was kept at least 80 centimeters from any other grounded conducting surface.
2. Connect EUT to the power mains through a line impedance stabilization network (LISN).
3. All the support units are connecting to the other LISN.
4. The LISN provides 50 ohm coupling impedance for the measuring instrument.
5. The FCC states that a 50 ohm, 50 microhenry LISN should be used.
6. Both sides of AC line were checked for maximum conducted interference.
7. The frequency range from 150 kHz to 30 MHz was searched.
8. Set the test-receiver system to Peak Detect Function and specified bandwidth with Maximum Hold Mode.

3.5.4 Test Setup

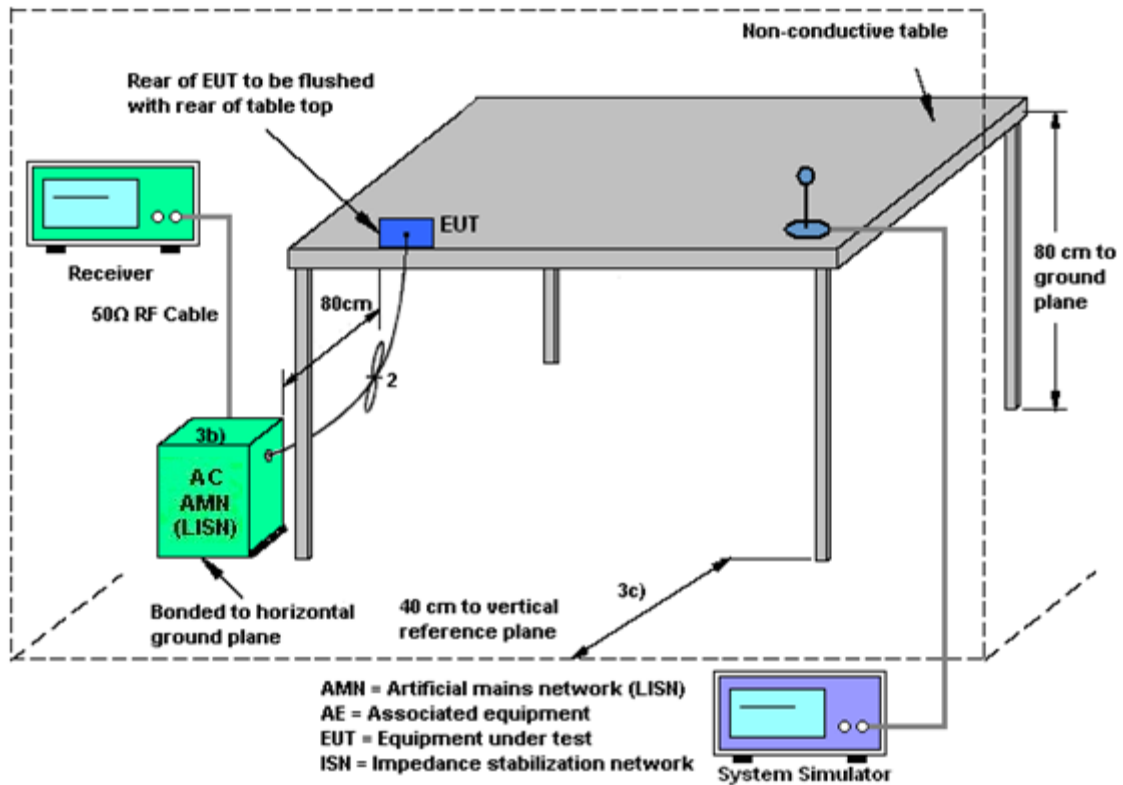

3.5.5 Test Result of AC Conducted Emission

Please refer to Appendix B.



3.6 Automatically Discontinue Transmission

3.6.1 Limit of Automatically Discontinue Transmission

The device shall automatically discontinue transmission in case of either absence of information to transmit or operational failure. These provisions are not intended to preclude the transmission of control or signaling information or the use of repetitive codes used by certain digital technologies to complete frame or burst intervals. Applicants shall include in their application for equipment authorization to describe how this requirement is met.

3.6.2 Measuring Instruments

See list of measuring equipment of this test report.

3.6.3 Test Result of Automatically Discontinue Transmission

EUT is verified this characteristic during the function check of normal sample associated with an access point:

- A. Information start: make EUT supply information to the access point.
- B. Information stop: stop supplying information to the access point.

While the EUT is not transmitting any information, the EUT can automatically discontinue transmission and become standby mode for power saving.

- C. Information start: make EUT supply information to the access point again.

The EUT can detect the controlling signal of ACK message transmitting from remote device and verify whether it shall resend or discontinue transmission.



5745MHz

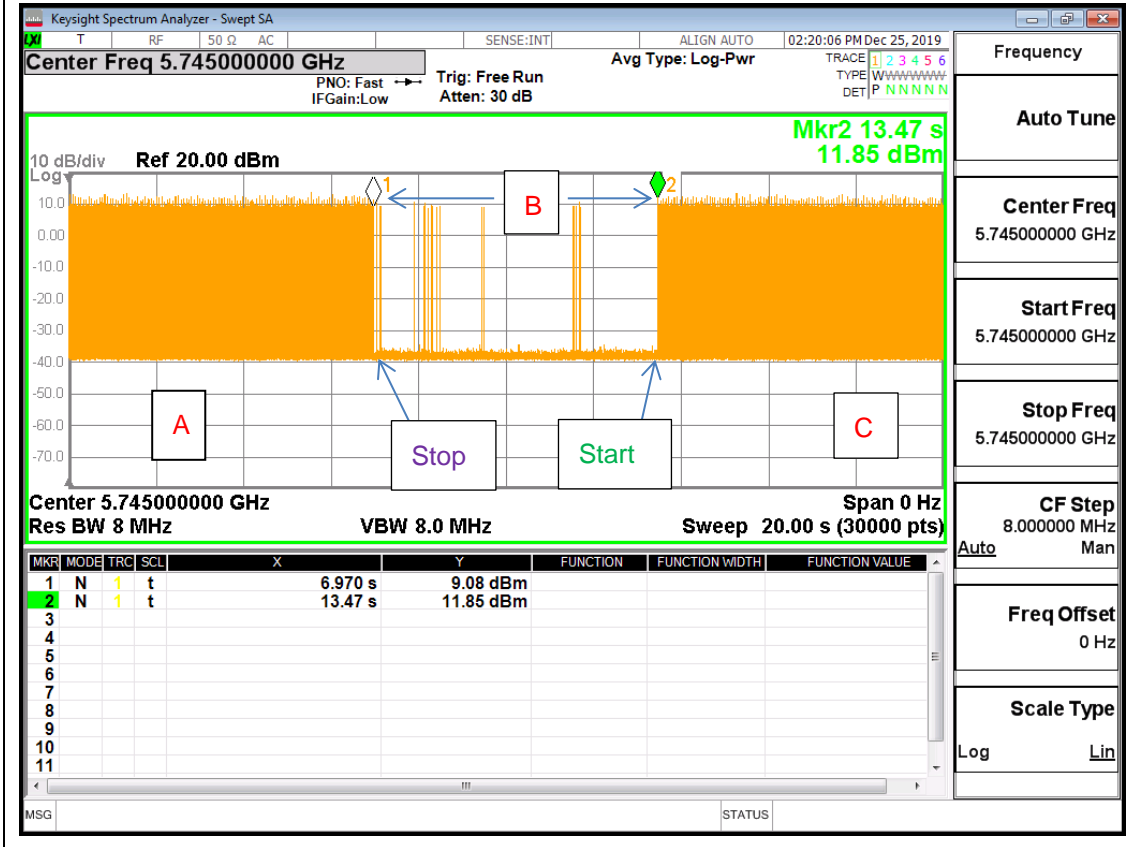

Note : The control / signalling information during the period B is precluded.



3.7 Antenna Requirements

3.7.1 Standard Applicable

If transmitting antenna directional gain is greater than 6 dBi, both the peak transmit power and the peak power spectral density shall be reduced by the amount in dB that the directional gain of the antenna exceeds 6 dBi.

3.7.2 Antenna Anti-Replacement Construction

An embedded-in antenna design is used.

3.7.3 Antenna Gain

<CDD Modes >

FCC KDB 662911 D01 Multiple Transmitter Output v02r01

For CDD transmissions, directional gain is calculated as

Directional gain = GANT + Array Gain, where Array Gain is as follows.

For power spectral density (PSD) measurements on all devices,

Array Gain = 10 log(NANT/NSS=1) dB.

For power measurements on IEEE 802.11 devices,

Array Gain = 0 dB (i.e., no array gain) for NANT ≤ 4.

Directional gain may be calculated by using the formulas applicable to equal gain antennas with GANT set equal to the gain of the antenna having the highest gain;

The EUT supports CDD mode.

For power, the directional gain GANT is set equal to the antenna having the highest gain, i.e., F)2)f)i).

For PSD, the directional gain calculation is following F)2)f)ii) of KDB 662911 D01 v02r01.

The power and PSD limit should be modified if the directional gain of EUT is over 6 dBi,

The directional gain “DG” is calculated as following table.

<CDD Modes>						
			DG	DG	Power	PSD
	Ant. 1	Ant. 2	for	for	Limit	Limit
	(dBi)	(dBi)	Power	PSD	Reduction	Reduction
			(dBi)	(dBi)	(dB)	(dB)
Band IV	1.50	1.30	1.50	4.41	0.00	0.00

Power Limit Reduction = DG(Power) – 6dBi, (min = 0)

PSD Limit Reduction = DG(PSD) – 6dBi, (min = 0)

TXBF modes

FCC KDB 662911 D01 Multiple Transmitter Output v02r01

For CDD transmissions, directional gain is calculated as

$$DirectionalGain = 10 \cdot \log \left[\frac{\sum_{j=1}^{N_{SS}} \left\{ \sum_{k=1}^{N_{ANT}} g_{j,k} \right\}^2}{N_{ANT}} \right]$$

where

Each antenna is driven by no more than one spatial stream;

N_{SS} = the number of independent spatial streams of data;

N_{ANT} = the total number of antennas

$g_{j,k} = 10^{G_k / 20}$ if the k th antenna is being fed by spatial stream j , or zero if it is not;
 G_k is the gain in dBi of the k th antenna.

The EUT supports beamforming for 802.11ac modes.

The directional gain calculation is following F)2)e)ii) of KDB 662911 D01 v02r01.

The power and PSD limit should be modified if the directional gain of EUT is over 6 dBi,

The directional gain “DG” is calculated as following table.

			DG	DG	Power	PSD
			for	for	Limit	Limit
	Ant 1	Ant 2	Power	PSD	Reduction	Reduction
	(dBi)	(dBi)	(dBi)	(dBi)	(dB)	(dB)
Band IV	1.50	1.30	4.41	4.41	0.00	0.00

$Power\ Limit\ Reduction = DG(Power) - 6dBi, (min = 0)$

$PSD\ Limit\ Reduction = DG(PSD) - 6dBi, (min = 0)$



4 List of Measuring Equipment

Instrument	Manufacturer	Model No.	Serial No.	Characteristics	Calibration Date	Test Date	Due Date	Remark
Horn Antenna	SCHWARZBECK	BBHA 9120 D	9120D-1241	1GHz ~ 18GHz	Jul. 02, 2019	Jan. 05, 2020~ Feb. 11, 2020	Jul. 01, 2020	Radiation (03CH13-HY)
Bilog Antenna	TESEQ	CBL 6111D&00800 N1D01N-06	40103 & 07	30MHz~1GHz	Apr. 30, 2019	Jan. 05, 2020~ Feb. 11, 2020	Apr. 29, 2020	Radiation (03CH13-HY)
SHF-EHF Horn Antenna	SCHWARZBECK	BBHA 9170	BBHA9170 576	18GHz- 40GHz	May 14, 2019	Jan. 05, 2020~ Feb. 11, 2020	May 13,2020	Radiation (03CH13-HY)
Preamplifier	Keysight	83017A	MY532701 47	1GHz~26.5GHz	Mar. 15, 2019	Jan. 05, 2020~ Feb. 11, 2020	Mar. 14, 2020	Radiation (03CH13-HY)
Preamplifier	MITEQ	AMF-7D-0010 1800-30-10P	1590074	1GHz~18GHz	May 20, 2019	Jan. 05, 2020~ Feb. 11, 2020	May 19, 2020	Radiation (03CH13-HY)
Amplifier	Sonoma-Instrument	310 N	187282	9KHz~1GHz	Dec. 17, 2019	Jan. 05, 2020~ Feb. 11, 2020	Dec. 16, 2020	Radiation (03CH13-HY)
Preamplifier	EMEC	EM18G40G	060715	18GHz ~ 40GHz	Dec. 13, 2019	Jan. 05, 2020~ Feb. 11, 2020	Dec. 12, 2020	Radiation (03CH13-HY)
Hygrometer	TECPEL	DTM-303B	TP150115	N/A	Nov. 08, 2019	Jan. 05, 2020~ Feb. 11, 2020	Nov. 07, 2020	Radiation (03CH13-HY)
RF Cable	HUBER + SUHNER	SUCOFLEX 126E	0030/126E	30M-18G	Feb. 13, 2019	Jan. 05, 2020~ Feb. 11, 2020	Feb. 12, 2020	Radiation (03CH13-HY)
RF Cable	HUBER + SUHNER	SUCOFLEX 104	804793/4	30M-18G	Feb. 13, 2019	Jan. 05, 2020~ Feb. 11, 2020	Feb. 12, 2020	Radiation (03CH13-HY)
RF Cable	HUBER + SUHNER	SUCOFLEX 104	MY24961/ 4	30M-18G	Feb. 13, 2019	Jan. 05, 2020~ Feb. 11, 2020	Feb. 12, 2020	Radiation (03CH13-HY)
RF Cable	HUBER + SUHNER	SUCOFLEX 102	MY2859/2	30M~40GHz	Mar. 13, 2019	Jan. 05, 2020~ Feb. 11, 2020	Mar. 12, 2020	Radiation (03CH13-HY)
RF Cable	HUBER + SUHNER	SUCOFLEX 102	MY4274/2	30M~40GHz	Mar. 13, 2019	Jan. 05, 2020~ Feb. 11, 2020	Mar. 12, 2020	Radiation (03CH13-HY)
Spectrum Analyzer	Keysight	N9010A	MY553705 26	10Hz~44GHz	Mar. 19, 2019	Jan. 05, 2020~ Feb. 11, 2020	Mar. 18, 2020	Radiation (03CH13-HY)
Controller	EMEC	EM1000	N/A	Control Turn table & Ant Mast	N/A	Jan. 05, 2020~ Feb. 11, 2020	N/A	Radiation (03CH13-HY)
Antenna Mast	EMEC	AM-BS-4500- B	N/A	1m~4m	N/A	Jan. 05, 2020~ Feb. 11, 2020	N/A	Radiation (03CH13-HY)
Turn Table	EMEC	TT2000	N/A	0~360 Degree	N/A	Jan. 05, 2020~ Feb. 11, 2020	N/A	Radiation (03CH13-HY)
Software	AUDIX	E3 6.2009-8-24c	RK-001124	N/A	N/A	Jan. 05, 2020~ Feb. 11, 2020	N/A	Radiation (03CH13-HY)
EMI Test Receiver	Keysight	N9038A(MXE)	MY541300 85	20Hz ~ 8.4GHz	Nov. 01, 2019	Jan. 05, 2020~ Feb. 11, 2020	Oct. 31, 2020	Radiation (03CH13-HY)
Filter	Wainwright	WHKX12-270 0-3000-18000 -60SS	SN2	3GHz High Pass Filter	Jul. 14, 2019	Jan. 05, 2020~ Feb. 11, 2020	Jul. 13, 2020	Radiation (03CH13-HY)
Filter	Wainwright	WLK4-1000-1 530-8000-40S S	SN12	1.53GHz Low Pass Filter	Sep. 16, 2019	Jan. 05, 2020~ Feb. 11, 2020	Sep. 15, 2020	Radiation (03CH13-HY)
Filter	Wainwright	WHKX8-5872. 5-6750-18000 -40ST	SN5	6.75GHz High Pass Filter	Mar. 13, 2019	Jan. 05, 2020~ Feb. 11, 2020	Mar. 12, 2020	Radiation (03CH13-HY)



Instrument	Manufacturer	Model No.	Serial No.	Characteristics	Calibration Date	Test Date	Due Date	Remark
AC Power Source	ChainTek	APC-1000W	N/A	N/A	N/A	Jan. 07, 2020	N/A	Conduction (CO05-HY)
EMI Test Receiver	Rohde & Schwarz	ESR3	102388	9kHz~3.6GHz	Nov. 15, 2019	Jan. 07, 2020	Nov. 14, 2020	Conduction (CO05-HY)
Hygrometer	Testo	608-H1	34913912	N/A	Mar. 19, 2019	Jan. 07, 2020	Mar. 18, 2020	Conduction (CO05-HY)
LISN	Rohde & Schwarz	ENV216	100081	9kHz~30MHz	Nov. 15, 2019	Jan. 07, 2020	Nov. 14, 2020	Conduction (CO05-HY)
Software	Rohde & Schwarz	EMC32 V10.30	N/A	N/A	N/A	Jan. 07, 2020	N/A	Conduction (CO05-HY)
LF Cable	HUBER + SUHNER	RG-214/U	LF01	N/A	Jan. 02, 2020	Jan. 07, 2020	Jan. 01, 2021	Conduction (CO05-HY)
Pulse Limiter	Rohde & Schwarz	ESH3-Z2	100851	N/A	Jan. 02, 2020	Jan. 07, 2020	Jan. 01, 2021	Conduction (CO05-HY)
Hygrometer	Testo	608-H2	41410069	N/A	Jun. 17, 2019	Dec. 26, 2019~ Feb. 12, 2020	Jun. 16, 2020	Conducted (TH05-HY)
Power Sensor	DARE	RPR3006W	16I00054S NO10	10MHz~6GHz	Dec. 23, 2019	Dec. 26, 2019~ Feb. 12, 2020	Dec. 22, 2020	Conducted (TH05-HY)
Signal Analyzer	Rohde & Schwarz	FSV40	101566	10Hz~40GHz	Jul. 15, 2019	Dec. 26, 2019~ Feb. 12, 2020	Jul. 14, 2020	Conducted (TH05-HY)
Power Supply	GW Instek	SPS-606	GES84293 1	NA	Aug. 19, 2019	Dec. 26, 2019~ Feb. 12, 2020	Aug. 18, 2020	Conducted (TH05-HY)
Switch Box & RF Cable	Burgeon	ETF-058	EC120838 2	N/A	Mar. 27, 2019	Dec. 26, 2019~ Feb. 12, 2020	Mar. 26, 2020	Conducted (TH05-HY)



5 Uncertainty of Evaluation

Uncertainty of Conducted Emission Measurement (150kHz ~ 30MHz)

Measuring Uncertainty for a Level of Confidence of 95% ($U = 2Uc(y)$)	2.0
---	-----

Uncertainty of Radiated Emission Measurement (30 MHz ~ 1000 MHz)

Measuring Uncertainty for a Level of Confidence of 95% ($U = 2Uc(y)$)	4.4
---	-----

Uncertainty of Radiated Emission Measurement (1000 MHz ~ 18000 MHz)

Measuring Uncertainty for a Level of Confidence of 95% ($U = 2Uc(y)$)	5.5
---	-----

Uncertainty of Radiated Emission Measurement (18000 MHz ~ 40000 MHz)

Measuring Uncertainty for a Level of Confidence of 95% ($U = 2Uc(y)$)	4.8
---	-----

Appendix A. Test Result of Conducted Test Items**<CDD Mode>**

Test Engineer:	Hank Hsu / Luffy Lin / Richard Qiu	Temperature:	21~25	°C
Test Date:	2019/12/26 / 2020/02/12	Relative Humidity:	51~54	%

TEST RESULTS DATA
6dB and 26dB EBW and 99% OBW

Band IV MIMO												
Mod.	Data Rate	N _{TX}	CH.	Freq. (MHz)	99% Bandwidth (MHz)		26dB Bandwidth (MHz)		6 dB Bandwidth (MHz)		6 dB Bandwidth Min. Limit (MHz)	Pass/Fail
					Ant 1	Ant 2	Ant 1	Ant 2	Ant 1	Ant 2		
11a	6Mbps	2	149	5745	24.68	33.02	40.76	48.43	15.24	16.28	0.5	Pass
11a	6Mbps	2	157	5785	29.57	33.47	46.00	49.79	15.09	16.28	0.5	Pass
11a	6Mbps	2	165	5825	30.82	33.17	46.45	51.07	16.28	16.28	0.5	Pass
VHT20	MCS0	2	149	5745	23.08	35.81	43.00	52.35	17.18	17.58	0.5	Pass
VHT20	MCS0	2	157	5785	30.92	36.21	47.87	54.75	16.88	17.48	0.5	Pass
VHT20	MCS0	2	165	5825	32.47	36.01	49.31	54.99	17.58	17.58	0.5	Pass
VHT40	MCS0	2	151	5755	38.06	67.83	84.40	103.70	35.34	36.23	0.5	Pass
VHT40	MCS0	2	159	5795	37.76	68.23	83.32	102.38	35.43	36.32	0.5	Pass
VHT80	MCS0	2	155	5775	77.44	99.02	173.11	212.19	73.85	71.29	0.5	Pass

TEST RESULTS DATA
6dB and 26dB EBW and 99% OBW

Band IV MIMO													
Mod.	Data Rate	NTX	CH.	Freq. (MHz)	RU Config	99% Bandwidth (MHz)		26dB Bandwidth (MHz)		6 dB Bandwidth (MHz)		6 dB Bandwidth Min. Limit (MHz)	Pass/Fail
						Ant 1	Ant 2	Ant 1	Ant 2	Ant 1	Ant 2		
HE20	MCS0	2	149	5745	Full	19.28	33.77	38.84	53.31	18.48	18.83	0.5	Pass
HE20	MCS0	2	157	5785	Full	22.23	35.61	53.95	55.39	18.78	18.78	0.5	Pass
HE20	MCS0	2	165	5825	Full	23.98	35.46	47.23	53.87	18.63	18.18	0.5	Pass
HE40	MCS0	2	151	5755	Full	39.56	68.33	81.04	108.25	37.67	37.04	0.5	Pass
HE40	MCS0	2	159	5795	Full	48.35	70.33	90.51	106.81	37.85	37.22	0.5	Pass
HE80	MCS0	2	155	5775	Full	79.72	97.82	161.60	201.40	74.97	72.57	0.5	Pass

TEST RESULTS DATA
Average Power Table

Band IV single antenna												
Mod.	Data Rate	NTX	CH.	Freq. (MHz)	Average Conducted Power (dBm)			FCC Conducted Power Limit (dBm)		DG (dBi)		Pass/Fail
					Ant 1	Ant 2	SUM	Ant 1	Ant 2	Ant 1	Ant 2	
11a	6Mbps	1	149	5745	16.80	17.00		30.00	30.00	1.50	1.30	Pass
11a	6Mbps	1	157	5785	16.80	16.90		30.00	30.00	1.50	1.30	Pass
11a	6Mbps	1	165	5825	16.90	16.90		30.00	30.00	1.50	1.30	Pass
HT20	MCS0	1	149	5745	17.00	17.10		30.00	30.00	1.50	1.30	Pass
HT20	MCS0	1	157	5785	16.90	17.00		30.00	30.00	1.50	1.30	Pass
HT20	MCS0	1	165	5825	17.00	16.80		30.00	30.00	1.50	1.30	Pass
HT40	MCS0	1	151	5755	16.90	16.80		30.00	30.00	1.50	1.30	Pass
HT40	MCS0	1	159	5795	16.80	17.10		30.00	30.00	1.50	1.30	Pass
VHT20	MCS0	1	149	5745	17.10	17.20		30.00	30.00	1.50	1.30	Pass
VHT20	MCS0	1	157	5785	17.00	17.10		30.00	30.00	1.50	1.30	Pass
VHT20	MCS0	1	165	5825	17.10	16.90		30.00	30.00	1.50	1.30	Pass
VHT40	MCS0	1	151	5755	17.00	16.90		30.00	30.00	1.50	1.30	Pass
VHT40	MCS0	1	159	5795	16.90	17.20		30.00	30.00	1.50	1.30	Pass
VHT80	MCS0	1	155	5775	17.10	16.80		30.00	30.00	1.50	1.30	Pass

Band IV MIMO												
Mod.	Data Rate	NTX	CH.	Freq. (MHz)	Average Conducted Power (dBm)			FCC Conducted Power Limit (dBm)		DG (dBi)		Pass/Fail
					Ant 1	Ant 2	SUM	Ant 1	Ant 2	Ant 1	Ant 2	
11a	6Mbps	2	149	5745	17.30	16.90	20.11	30.00		1.50		Pass
11a	6Mbps	2	157	5785	17.50	16.20	19.91	30.00		1.50		Pass
11a	6Mbps	2	165	5825	17.20	16.60	19.92	30.00		1.50		Pass
HT20	MCS0	2	149	5745	17.50	16.90	20.22	30.00		1.50		Pass
HT20	MCS0	2	157	5785	17.80	16.50	20.21	30.00		1.50		Pass
HT20	MCS0	2	165	5825	17.50	16.90	20.22	30.00		1.50		Pass
HT40	MCS0	2	151	5755	17.40	16.50	19.98	30.00		1.50		Pass
HT40	MCS0	2	159	5795	17.80	16.50	20.21	30.00		1.50		Pass
VHT20	MCS0	2	149	5745	17.60	16.90	20.27	30.00		1.50		Pass
VHT20	MCS0	2	157	5785	17.90	16.50	20.27	30.00		1.50		Pass
VHT20	MCS0	2	165	5825	17.60	16.90	20.27	30.00		1.50		Pass
VHT40	MCS0	2	151	5755	17.50	16.50	20.04	30.00		1.50		Pass
VHT40	MCS0	2	159	5795	17.90	16.50	20.27	30.00		1.50		Pass
VHT80	MCS0	2	155	5775	17.60	16.60	20.14	30.00		1.50		Pass

TEST RESULTS DATA
Average Power Table

Band IV single antenna													
Mod.	Data Rate	NTX	CH.	Freq. (MHz)	RU Config	Average Conducted Power (dBm)			FCC Conducted Power Limit (dBm)		DG (dBi)		Pass/Fail
						Ant 1	Ant 2	SUM	Ant 1	Ant 2	Ant 1	Ant 2	
HE20	MCS0	1	149	5745	Full	17.10	17.10		30.00	30.00	1.50	1.30	Pass
HE20	MCS0	1	149	5745	26/0	17.00	17.00		30.00	30.00	1.50	1.30	Pass
HE20	MCS0	1	149	5745	52/37	16.90	17.00		30.00	30.00	1.50	1.30	Pass
HE20	MCS0	1	149	5745	106/53	17.00	17.10		30.00	30.00	1.50	1.30	Pass
HE20	MCS0	1	157	5785	Full	17.10	17.10		30.00	30.00	1.50	1.30	Pass
HE20	MCS0	1	165	5825	Full	17.20	17.20		30.00	30.00	1.50	1.30	Pass
HE20	MCS0	1	165	5825	26/8	17.00	17.10		30.00	30.00	1.50	1.30	Pass
HE20	MCS0	1	165	5825	52/40	16.90	17.00		30.00	30.00	1.50	1.30	Pass
HE20	MCS0	1	165	5825	106/54	17.00	17.00		30.00	30.00	1.50	1.30	Pass
HE40	MCS0	1	151	5755	Full	17.20	17.20		30.00	30.00	1.50	1.30	Pass
HE40	MCS0	1	151	5755	242/61	16.90	16.90		30.00	30.00	1.50	1.30	Pass
HE40	MCS0	1	159	5795	Full	16.80	17.10		30.00	30.00	1.50	1.30	Pass
HE40	MCS0	1	159	5795	242/62	16.70	16.90		30.00	30.00	1.50	1.30	Pass
HE80	MCS0	1	155	5775	Full	17.00	16.70		30.00	30.00	1.50	1.30	Pass
HE80	MCS0	1	155	5775	484/65	17.00	16.80		30.00	30.00	1.50	1.30	Pass
HE80	MCS0	1	155	5775	484/66	16.80	16.80		30.00	30.00	1.50	1.30	Pass

Band IV MIMO													
Mod.	Data Rate	NTX	CH.	Freq. (MHz)	RU Config	Average Conducted Power (dBm)			FCC Conducted Power Limit (dBm)		DG (dBi)		Pass/Fail
						Ant 1	Ant 2	SUM	Ant 1	Ant 2	Ant 1	Ant 2	
HE20	MCS0	2	149	5745	Full	17.40	16.90	20.17	30.00		1.50		Pass
HE20	MCS0	2	149	5745	26/0	17.30	16.80	20.07	30.00		1.50		Pass
HE20	MCS0	2	149	5745	52/37	17.20	16.80	20.01	30.00		1.50		Pass
HE20	MCS0	2	149	5745	106/53	17.20	16.90	20.06	30.00		1.50		Pass
HE20	MCS0	2	157	5785	Full	17.20	16.50	19.87	30.00		1.50		Pass
HE20	MCS0	2	165	5825	Full	17.50	17.00	20.27	30.00		1.50		Pass
HE20	MCS0	2	165	5825	26/8	17.50	17.00	20.27	30.00		1.50		Pass
HE20	MCS0	2	165	5825	52/40	17.40	16.60	20.03	30.00		1.50		Pass
HE20	MCS0	2	165	5825	106/54	17.40	16.60	20.03	30.00		1.50		Pass
HE40	MCS0	2	151	5755	Full	17.70	16.80	20.28	30.00		1.50		Pass
HE40	MCS0	2	151	5755	242/61	17.30	16.60	19.97	30.00		1.50		Pass
HE40	MCS0	2	159	5795	Full	17.70	16.40	20.11	30.00		1.50		Pass
HE40	MCS0	2	159	5795	242/62	17.60	16.10	19.92	30.00		1.50		Pass
HE80	MCS0	2	155	5775	Full	17.60	16.50	20.10	30.00		1.50		Pass
HE80	MCS0	2	155	5775	484/65	17.50	16.50	20.04	30.00		1.50		Pass
HE80	MCS0	2	155	5775	484/66	17.60	16.10	19.92	30.00		1.50		Pass

TEST RESULTS DATA
Power Spectral Density

Band IV MIMO														
Mod.	Data Rate	NTX	CH.	Freq. (MHz)	10log (500kHz /RBW) Factor (dB)		Average Power Density (dBm/500kHz)			Average PSD Limit (dBm/500kHz)		DG (dBi)		Pass /Fail
					Ant 1	Ant 2	Ant 1	Ant 2	SUM	Ant 1	Ant 2	Ant 1	Ant 2	
11a	6Mbps	2	149	5745	2.22	6.27	6.11	9.28	30.00	30.00	4.41	4.41	Pass	
11a	6Mbps	2	157	5785	2.22	5.98	5.20	8.99	30.00	30.00	4.41	4.41	Pass	
11a	6Mbps	2	165	5825	2.22	5.83	5.94	8.95	30.00	30.00	4.41	4.41	Pass	
VHT20	MCS0	2	149	5745	2.22	6.52	6.00	9.53	30.00	30.00	4.41	4.41	Pass	
VHT20	MCS0	2	157	5785	2.22	5.93	5.22	8.94	30.00	30.00	4.41	4.41	Pass	
VHT20	MCS0	2	165	5825	2.22	6.38	6.08	9.39	30.00	30.00	4.41	4.41	Pass	
VHT40	MCS0	2	151	5755	2.22	2.87	2.73	5.88	30.00	30.00	4.41	4.41	Pass	
VHT40	MCS0	2	159	5795	2.22	3.36	2.45	6.37	30.00	30.00	4.41	4.41	Pass	
VHT80	MCS0	2	155	5775	2.22	0.48	-0.36	3.49	30.00	30.00	4.41	4.41	Pass	

Note: PSD Sum = Max PSD(Ant. 1, Ant. 2) + 10 log (n)

TEST RESULTS DATA
Power Spectral Density

Band IV MIMO															
Mod.	Data Rate	NTX	CH.	Freq. (MHz)	RU Config	10log (500kHz /RBW) Factor (dB)		Average Power Density (dBm/500kHz)			Average PSD Limit (dBm/500kHz)		DG (dBi)		Pass /Fail
						Ant 1	Ant 2	Ant 1	Ant 2	SUM	Ant 1	Ant 2	Ant 1	Ant 2	
HE20	MCS0	2	149	5745	Full	2.22	5.73	6.09	9.10	30.00	4.41	Pass			
HE20	MCS0	2	149	5745	26/0	2.22	13.54	13.49	16.55	30.00	4.41	Pass			
HE20	MCS0	2	149	5745	52/37	2.22	11.35	10.41	14.36	30.00	4.41	Pass			
HE20	MCS0	2	149	5745	106/53	2.22	8.48	8.43	11.49	30.00	4.41	Pass			
HE20	MCS0	2	157	5785	Full	2.22	6.84	6.08	9.85	30.00	4.41	Pass			
HE20	MCS0	2	165	5825	Full	2.22	6.78	6.01	9.79	30.00	4.41	Pass			
HE20	MCS0	2	165	5825	26/8	2.22	14.23	13.70	17.24	30.00	4.41	Pass			
HE20	MCS0	2	165	5825	52/40	2.22	10.93	10.44	13.94	30.00	4.41	Pass			
HE20	MCS0	2	165	5825	106/54	2.22	8.56	7.90	11.57	30.00	4.41	Pass			
HE40	MCS0	2	151	5755	Full	2.22	3.52	3.09	6.53	30.00	4.41	Pass			
HE40	MCS0	2	151	5755	242/61	2.22	4.83	4.11	7.84	30.00	4.41	Pass			
HE40	MCS0	2	159	5795	Full	2.22	3.59	2.50	6.60	30.00	4.41	Pass			
HE40	MCS0	2	159	5795	242/62	2.22	4.97	3.73	7.98	30.00	4.41	Pass			
HE80	MCS0	2	155	5775	Full	2.22	0.31	-0.02	3.32	30.00	4.41	Pass			
HE80	MCS0	2	155	5775	484/65	2.22	2.45	1.28	5.46	30.00	4.41	Pass			
HE80	MCS0	2	155	5775	484/66	2.22	2.65	1.20	5.66	30.00	4.41	Pass			

Note: PSD Sum = Max PSD(Ant. 1, Ant. 2) + 10 log (n)

<TXBF Mode>

Test Engineer:	Richard Qiu	Temperature:	21~25	°C
Test Date:	2020/1/30~2020/2/10	Relative Humidity:	51~54	%

TEST RESULTS DATA
6dB and 26dB EBW and 99% OBW

Band IV MIMO												
Mod.	Data Rate	NTX	CH.	Freq. (MHz)	99% Bandwidth (MHz)		26dB Bandwidth (MHz)		6 dB Bandwidth (MHz)		6 dB Bandwidth Min. Limit (MHz)	Pass/Fail
					Ant 1	Ant 2	Ant 1	Ant 2	Ant 1	Ant 2		
VHT20	MCS0	2	149	5745	17.83	17.78	25.72	25.43	16.88	16.53	0.5	Pass
VHT20	MCS0	2	157	5785	17.83	17.78	24.88	26.42	17.68	15.98	0.5	Pass
VHT20	MCS0	2	165	5825	17.83	17.73	25.52	24.23	17.63	17.63	0.5	Pass
VHT40	MCS0	2	151	5755	37.36	37.06	41.54	42.71	34.89	35.86	0.5	Pass
VHT40	MCS0	2	159	5795	37.26	37.36	43.88	59.07	35.69	35.56	0.5	Pass
VHT80	MCS0	2	155	5775	78.04	77.32	82.48	82.48	73.73	75.64	0.5	Pass

TEST RESULTS DATA
6dB and 26dB EBW and 99% OBW

Band IV MIMO													
Mod.	Data Rate	NTX	CH.	Freq. (MHz)	RU Config	99% Bandwidth (MHz)		26dB Bandwidth (MHz)		6 dB Bandwidth (MHz)		6 dB Bandwidth Min. Limit (MHz)	Pass/Fail
						Ant 1	Ant 2	Ant 1	Ant 2	Ant 1	Ant 2		
HE20	MCS0	2	149	5745	Full	17.78	17.83	26.27	23.98	17.68	16.08	0.5	Pass
HE20	MCS0	2	157	5785	Full	17.83	17.78	26.27	26.02	17.78	17.58	0.5	Pass
HE20	MCS0	2	165	5825	Full	17.83	17.83	25.12	24.53	17.58	16.28	0.5	Pass
HE40	MCS0	2	151	5755	Full	36.76	37.16	43.43	42.17	35.06	31.97	0.5	Pass
HE40	MCS0	2	159	5795	Full	36.66	38.16	24.62	43.79	34.17	35.76	0.5	Pass
HE80	MCS0	2	155	5775	Full	78.04	77.56	82.80	81.52	75.52	70.73	0.5	Pass

TEST RESULTS DATA
Average Power Table

Band IV MIMO												
Mod.	Data Rate	NTX	CH.	Freq. (MHz)	Average Conducted Power (dBm)			FCC Conducted Power Limit (dBm)		DG (dBi)		Pass/Fail
					Ant 1	Ant 2	SUM	Ant 1	Ant 2	Ant 1	Ant 2	
VHT20	MCS0	2	149	5745	15.20	14.40	17.83	30.00		4.41		Pass
VHT20	MCS0	2	157	5785	15.80	14.70	18.30	30.00		4.41		Pass
VHT20	MCS0	2	165	5825	15.20	14.80	18.01	30.00		4.41		Pass
VHT40	MCS0	2	151	5755	15.30	14.80	18.07	30.00		4.41		Pass
VHT40	MCS0	2	159	5795	16.10	14.70	18.47	30.00		4.41		Pass
VHT80	MCS0	2	155	5775	16.00	14.80	18.45	30.00		4.41		Pass

TEST RESULTS DATA
Average Power Table

Band IV MIMO													
Mod.	Data Rate	NTX	CH.	Freq. (MHz)	RU Config	Average Conducted Power (dBm)			FCC Conducted Power Limit (dBm)		DG (dBi)		Pass/Fail
						Ant 1	Ant 2	SUM	Ant 1	Ant 2	Ant 1	Ant 2	
HE20	MCS0	2	149	5745	Full	15.20	14.80	18.01	30.00		4.41		Pass
HE20	MCS0	2	157	5785	Full	16.00	14.70	18.41	30.00		4.41		Pass
HE20	MCS0	2	165	5825	Full	15.60	14.90	18.27	30.00		4.41		Pass
HE40	MCS0	2	151	5755	Full	15.20	14.70	17.97	30.00		4.41		Pass
HE40	MCS0	2	159	5795	Full	15.70	14.50	18.15	30.00		4.41		Pass
HE80	MCS0	2	155	5775	Full	15.20	14.70	17.97	30.00		4.41		Pass

TEST RESULTS DATA
Power Spectral Density

Band IV MIMO														
Mod.	Data Rate	NTX	CH.	Freq. (MHz)	10log (500kHz /RBW) Factor (dB)		Average Power Density (dBm/500kHz)			Average PSD Limit (dBm/500kHz)		DG (dBi)		Pass /Fail
					Ant 1	Ant 2	Ant 1	Ant 2	SUM	Ant 1	Ant 2	Ant 1	Ant 2	
VHT20	MCS0	2	149	5745	2.22		3.48	3.46	6.49	30.00		4.41		Pass
VHT20	MCS0	2	157	5785	2.22		4.45	3.10	7.46	30.00		4.41		Pass
VHT20	MCS0	2	165	5825	2.22		2.95	2.85	5.96	30.00		4.41		Pass
VHT40	MCS0	2	151	5755	2.22		3.47	2.85	6.48	30.00		4.41		Pass
VHT40	MCS0	2	159	5795	2.22		3.56	2.21	6.57	30.00		4.41		Pass
VHT80	MCS0	2	155	5775	2.22		2.99	2.53	6.00	30.00		4.41		Pass

Note: PSD Sum = Max PSD(Ant. 1, Ant. 2) + 10 log (n)

TEST RESULTS DATA
Power Spectral Density

Band IV MIMO															
Mod.	Data Rate	NTX	CH.	Freq. (MHz)	RU Config	10log (500kHz /RBW) Factor (dB)		Average Power Density (dBm/500kHz)			Average PSD Limit (dBm/500kHz)		DG (dBi)		Pass /Fail
						Ant 1	Ant 2	Ant 1	Ant 2	SUM	Ant 1	Ant 2	Ant 1	Ant 2	
HE20	MCS0	2	149	5745	Full	2.22	3.43	2.75	6.44	30.00	4.41	Pass			
HE20	MCS0	2	157	5785	Full	2.22	4.23	3.46	7.24	30.00	4.41	Pass			
HE20	MCS0	2	165	5825	Full	2.22	3.87	2.93	6.88	30.00	4.41	Pass			
HE40	MCS0	2	151	5755	Full	2.22	4.09	2.65	7.10	30.00	4.41	Pass			
HE40	MCS0	2	159	5795	Full	2.22	3.84	2.45	6.85	30.00	4.41	Pass			
HE80	MCS0	2	155	5775	Full	2.22	2.96	2.95	5.97	30.00	4.41	Pass			

Note: PSD Sum = Max PSD(Ant. 1, Ant. 2) + 10 log (n)



Appendix B. AC Conducted Emission Test Results

Test Engineer :	Tom Lee	Temperature :	21~24°C
		Relative Humidity :	42~45%

EUT Information

Report NO : 9D0635
 Test Mode : Mode 1
 Test Voltage : 120Vac/60Hz
 Phase : Line

Full Spectrum

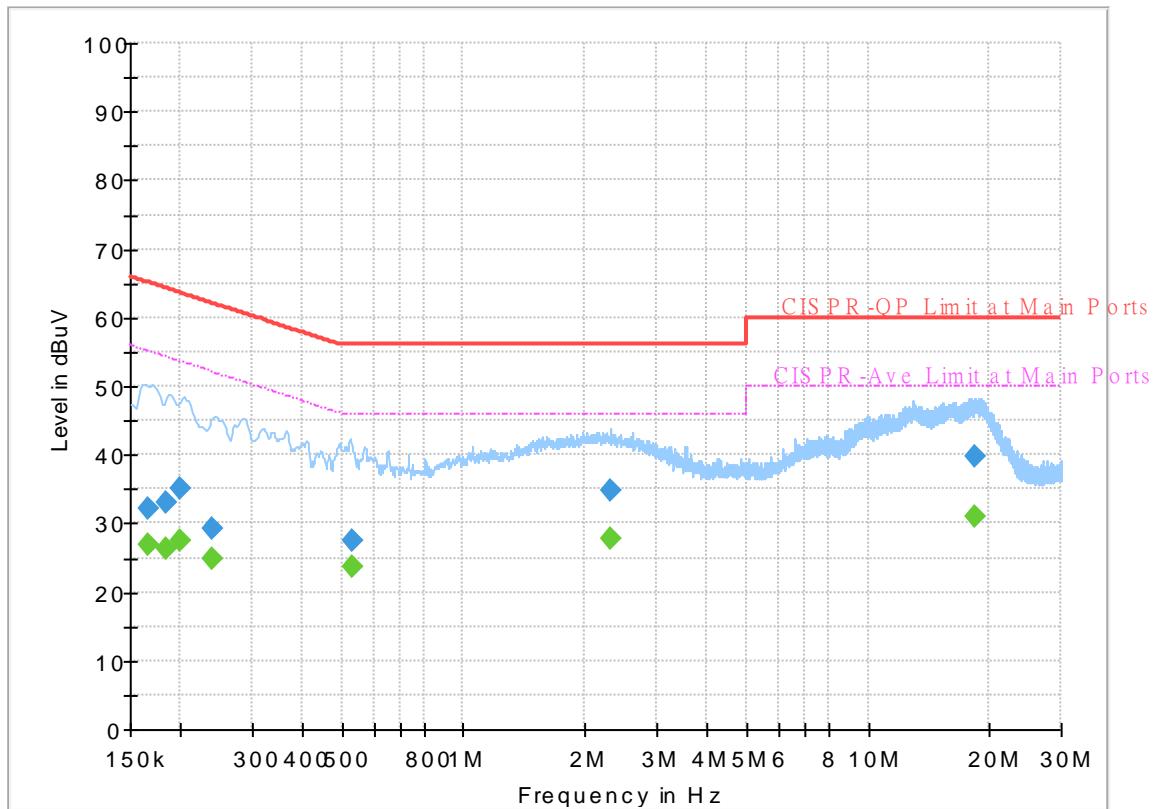

Final Result

Frequency (MHz)	QuasiPeak (dBuV)	CAverage (dBuV)	Limit (dBuV)	Margin (dB)	Line	Filter	Corr. (dB)
0.166110	---	27.02	55.15	28.13	L1	OFF	19.5
0.166110	32.07	---	65.15	33.08	L1	OFF	19.5
0.183750	---	26.19	54.31	28.12	L1	OFF	19.5
0.183750	32.93	---	64.31	31.38	L1	OFF	19.5
0.199500	---	27.38	53.63	26.25	L1	OFF	19.5
0.199500	35.10	---	63.63	28.53	L1	OFF	19.5
0.240000	---	24.73	52.10	27.37	L1	OFF	19.5
0.240000	29.21	---	62.10	32.89	L1	OFF	19.5
0.529440	---	23.58	46.00	22.42	L1	OFF	19.5
0.529440	27.54	---	56.00	28.46	L1	OFF	19.5
2.299650	---	27.89	46.00	18.11	L1	OFF	19.7
2.299650	34.91	---	56.00	21.09	L1	OFF	19.7
18.298500	---	30.87	50.00	19.13	L1	OFF	20.2
18.298500	39.85	---	60.00	20.15	L1	OFF	20.2

EUT Information

Report NO : 9D0635
 Test Mode : Mode 1
 Test Voltage : 120Vac/60Hz
 Phase : Neutral

Full Spectrum

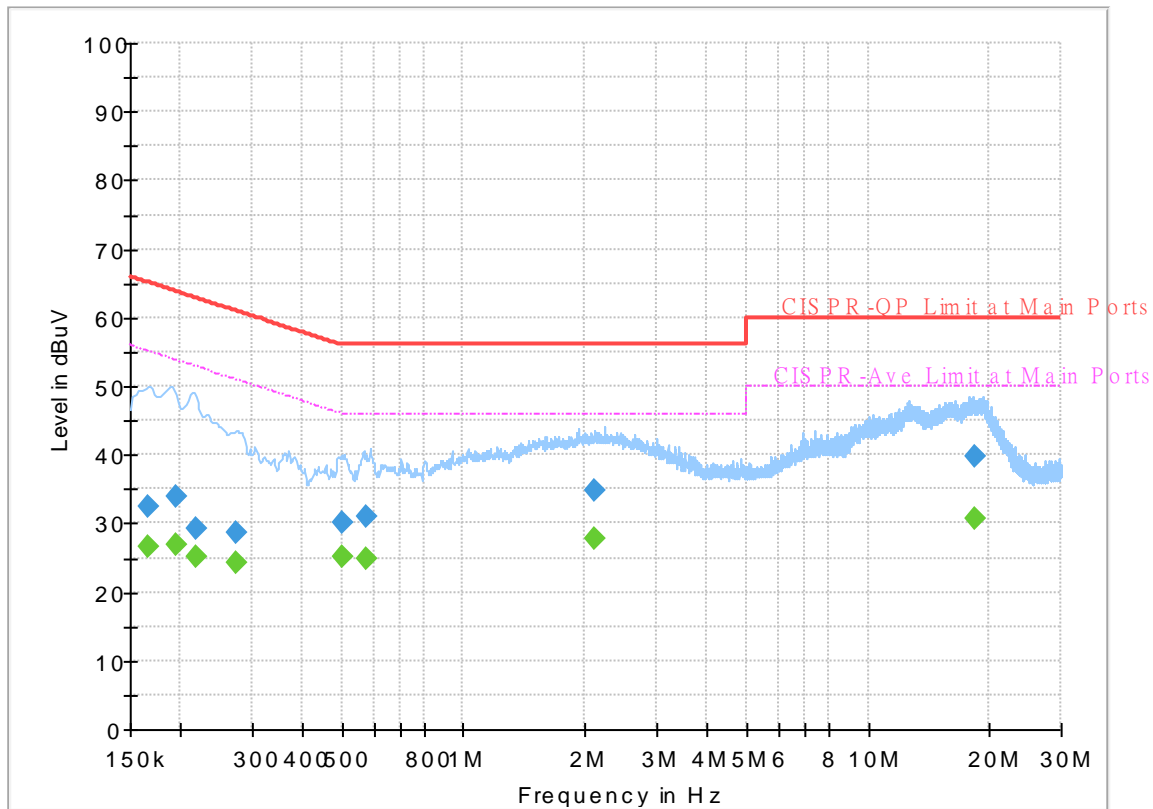

Final_Result

Frequency (MHz)	QuasiPeak (dBuV)	CAverage (dBuV)	Limit (dBuV)	Margin (dB)	Line	Filter	Corr. (dB)
0.165660	---	26.54	55.18	28.64	N	OFF	19.6
0.165660	32.44	---	65.18	32.74	N	OFF	19.6
0.195000	---	26.84	53.82	26.98	N	OFF	19.6
0.195000	33.89	---	63.82	29.93	N	OFF	19.6
0.217230	---	25.21	52.92	27.71	N	OFF	19.6
0.217230	29.10	---	62.92	33.82	N	OFF	19.6
0.274380	---	24.23	50.98	26.75	N	OFF	19.6
0.274380	28.55	---	60.98	32.43	N	OFF	19.6
0.499470	---	25.21	46.01	20.80	N	OFF	19.6
0.499470	30.12	---	56.01	25.89	N	OFF	19.6
0.573000	---	24.96	46.00	21.04	N	OFF	19.6
0.573000	30.85	---	56.00	25.15	N	OFF	19.6
2.112360	---	27.73	46.00	18.27	N	OFF	19.6
2.112360	34.76	---	56.00	21.24	N	OFF	19.6
18.276360	---	30.81	50.00	19.19	N	OFF	20.3
18.276360	39.73	---	60.00	20.27	N	OFF	20.3



Appendix C. Radiated Spurious Emission

Test Engineer :	Jimmy Chung · Karl Hou · Wilson Wu	Temperature :	21.5~23.5°C
		Relative Humidity :	49.5~55.5%

<CDD Mode>

Band 4 - 5725~5850MHz

WIFI 802.11a (Band Edge @ 3m)

WIFI	Note	Frequency	Level	Over	Limit	Read	Antenna	Path	Preamp	Ant	Table	Peak	Pol.	
Ant.				Limit	Line	Level	Factor	Loss	Factor	Pos	Pos	Avg.		
1+2		(MHz)	(dBµV/m)	(dB)	(dBµV/m)	(dBµV)	(dB/m)	(dB)	(dB)	(cm)	(deg)	(P/A)	(H/V)	
802.11a CH 149 5745MHz		5632.6	51.68	-16.52	68.2	40.36	31.8	6.33	26.81	256	314	P	H	
		5699.4	62.8	-41.96	104.76	51.31	32	6.36	26.87	256	314	P	H	
		5719.8	76.16	-34.58	110.74	64.59	32.08	6.37	26.88	256	314	P	H	
		5723.8	81.49	-37.97	119.46	69.91	32.1	6.37	26.89	256	314	P	H	
	*	5745	112.21	-	-	100.56	32.18	6.38	26.91	256	314	P	H	
	*	5745	104.14	-	-	92.49	32.18	6.38	26.91	256	314	A	H	
														H
														H
			5616.6	51.43	-16.77	68.2	40.09	31.8	6.33	26.79	300	178	P	V
			5698	62.07	-41.66	103.73	50.58	31.99	6.36	26.86	300	178	P	V
			5720	76.52	-34.28	110.8	64.95	32.08	6.37	26.88	300	178	P	V
			5724.4	84.1	-36.73	120.83	72.52	32.1	6.37	26.89	300	178	P	V
	*		5745	108.46	-	-	96.81	32.18	6.38	26.91	300	178	P	V
	*		5745	100.2	-	-	88.55	32.18	6.38	26.91	300	178	A	V
														V
														V



WIFI Ant.	Note	Frequency	Level	Over Limit	Limit Line	Read Level	Antenna Factor	Path Loss	Preamp Factor	Ant Pos	Table Pos	Peak Avg.	Pol.
1+2		(MHz)	(dBμV/m)	(dB)	(dBμV/m)	(dBμV)	(dB/m)	(dB)	(dB)	(cm)	(deg)	(P/A)	(H/V)
		5631	52.08	-16.12	68.2	40.76	31.8	6.33	26.81	236	318	P	H
		5694.8	53.82	-47.55	101.37	42.34	31.98	6.36	26.86	236	318	P	H
		5709	59.67	-48.05	107.72	48.14	32.04	6.36	26.87	236	318	P	H
		5724.4	58.82	-62.01	120.83	47.24	32.1	6.37	26.89	236	318	P	H
	*	5785	112.35	-	-	100.63	32.27	6.39	26.94	236	318	P	H
	*	5785	104.03	-	-	92.31	32.27	6.39	26.94	236	318	A	H
		5850.2	56.38	-65.36	121.74	44.54	32.4	6.44	27	236	318	P	H
		5859.2	53.8	-55.82	109.62	41.92	32.44	6.45	27.01	236	318	P	H
		5875	52.55	-52.65	105.2	40.61	32.5	6.46	27.02	236	318	P	H
		5944	51.38	-16.82	68.2	39.25	32.69	6.52	27.08	236	318	P	H
													H
													H
802.11a													
CH 157													
5785MHz		5644	51.99	-16.21	68.2	40.67	31.8	6.34	26.82	299	177	P	V
		5694	52.46	-48.32	100.78	40.98	31.98	6.36	26.86	299	177	P	V
		5719	58.9	-51.62	110.52	47.33	32.08	6.37	26.88	299	177	P	V
		5723.6	57.19	-61.82	119.01	45.62	32.09	6.37	26.89	299	177	P	V
	*	5785	107.72	-	-	96	32.27	6.39	26.94	299	177	P	V
	*	5785	99.19	-	-	87.47	32.27	6.39	26.94	299	177	A	V
		5853.6	54.5	-59.49	113.99	42.65	32.41	6.44	27	299	177	P	V
		5855.6	53.72	-56.91	110.63	41.86	32.42	6.44	27	299	177	P	V
		5879.4	52.75	-49.18	101.93	40.79	32.52	6.46	27.02	299	177	P	V
		5934.8	51.36	-16.84	68.2	39.25	32.67	6.51	27.07	299	177	P	V
													V
													V



WiFi Ant. 1+2	Note	Frequency (MHz)	Level (dBµV/m)	Over Limit (dB)	Limit Line (dBµV/m)	Read Level (dBµV)	Antenna Factor (dB/m)	Path Loss (dB)	Preamp Factor (dB)	Ant Pos (cm)	Table Pos (deg)	Peak Avg. (P/A)	Pol. (H/V)	
802.11a CH 165 5825MHz	*	5825	111.7	-	-	99.91	32.35	6.42	26.98	248	311	P	H	
	*	5825	103.35	-	-	91.56	32.35	6.42	26.98	248	311	A	H	
		5854.4	76.52	-35.65	112.17	64.66	32.42	6.44	27	248	311	P	H	
		5859.2	72.89	-36.73	109.62	61.01	32.44	6.45	27.01	248	311	P	H	
		5879	63.25	-38.98	102.23	51.29	32.52	6.46	27.02	248	311	P	H	
		5943.6	51.91	-16.29	68.2	39.79	32.69	6.51	27.08	248	311	P	H	
														H
														H
	*	5825	107.47	-	-	95.68	32.35	6.42	26.98	292	179	P	V	
	*	5825	99.04	-	-	87.25	32.35	6.42	26.98	292	179	A	V	
		5850	74.2	-48	122.2	62.36	32.4	6.44	27	292	179	P	V	
		5856.6	71.88	-38.47	110.35	60	32.43	6.45	27	292	179	P	V	
		5875	56.04	-49.16	105.2	44.1	32.5	6.46	27.02	292	179	P	V	
		5941.6	51.91	-16.29	68.2	39.8	32.68	6.51	27.08	292	179	P	V	
														V
														V
													V	
Remark	1. No other spurious found. 2. All results are PASS against Peak and Average limit line.													



**Band 4 5725~5850MHz
WIFI 802.11a (Harmonic @ 3m)**

WIFI Ant.	Note	Frequency	Level	Over Limit	Limit Line	Read Level	Antenna Factor	Path Loss	Preamp Factor	Ant Pos	Table Pos	Peak Avg.	Pol.
1+2		(MHz)	(dBμV/m)	(dB)	(dBμV/m)	(dBμV)	(dB/m)	(dB)	(dB)	(cm)	(deg)	(P/A)	(H/V)
802.11a CH 149 5745MHz		11490	47.32	-26.68	74	53.26	39.9	10.46	56.3	100	0	P	H
		17235	49.76	-18.44	68.2	53.44	39.94	12.95	56.57	100	0	P	H
													H
													H
		11490	46.89	-27.11	74	52.83	39.9	10.46	56.3	100	0	P	V
		17235	47.46	-20.74	68.2	51.14	39.94	12.95	56.57	100	0	P	V
													V
													V
802.11a CH 157 5785MHz		11570	46.65	-27.35	74	52.62	39.83	10.5	56.3	100	0	P	H
		17355	48.51	-19.69	68.2	51.91	40.33	13.08	56.81	100	0	P	H
													H
													H
		11570	47.51	-26.49	74	53.48	39.83	10.5	56.3	100	0	P	V
		17355	49.73	-18.47	68.2	53.13	40.33	13.08	56.81	100	0	P	V
													V
													V
802.11a CH 165 5825MHz		11650	47.22	-26.78	74	53.43	39.55	10.54	56.3	100	0	P	H
		17475	48.63	-19.57	68.2	51.64	40.83	13.21	57.05	100	0	P	H
													H
													H
		11650	46.49	-27.51	74	52.7	39.55	10.54	56.3	100	0	P	V
		17475	49.41	-18.79	68.2	52.42	40.83	13.21	57.05	100	0	P	V
													V
													V
Remark	1. No other spurious found. 2. All results are PASS against Peak and Average limit line.												



Band 4 5725~5850MHz
WIFI 802.11ac VHT20 (Band Edge @ 3m)

WIFI Ant.	Note	Frequency	Level	Over Limit	Limit Line	Read Level	Antenna Factor	Path Loss	Preamp Factor	Ant Pos	Table Pos	Peak Avg.	Pol.	
1+2		(MHz)	(dBμV/m)	(dB)	(dBμV/m)	(dBμV)	(dB/m)	(dB)	(dB)	(cm)	(deg)	(P/A)	(H/V)	
802.11ac VHT20 CH 149 5745MHz		5627.2	52.21	-15.99	68.2	40.88	31.8	6.33	26.8	106	323	P	H	
		5695	68.1	-33.41	101.51	56.62	31.98	6.36	26.86	106	323	P	H	
		5719.8	83.11	-27.63	110.74	71.54	32.08	6.37	26.88	106	323	P	H	
		5725	89.45	-32.75	122.2	77.87	32.1	6.37	26.89	106	323	P	H	
	*	5745	113.83	-	-	102.18	32.18	6.38	26.91	106	323	P	H	
	*	5745	105.15	-	-	93.5	32.18	6.38	26.91	106	323	A	H	
														H
														H
			5623.6	51.27	-16.93	68.2	39.94	31.8	6.33	26.8	295	316	P	V
			5699.4	61.64	-43.12	104.76	50.15	32	6.36	26.87	295	316	P	V
			5719.8	79.46	-31.28	110.74	67.89	32.08	6.37	26.88	295	316	P	V
			5725	88.36	-33.84	122.2	76.78	32.1	6.37	26.89	295	316	P	V
	*		5745	109.75	-	-	98.1	32.18	6.38	26.91	295	316	P	V
	*		5745	101.28	-	-	89.63	32.18	6.38	26.91	295	316	A	V
													V	
													V	



WIFI Ant.	Note	Frequency	Level	Over Limit	Limit Line	Read Level	Antenna Factor	Path Loss	Preamp Factor	Ant Pos	Table Pos	Peak Avg.	Pol.
1+2		(MHz)	(dBμV/m)	(dB)	(dBμV/m)	(dBμV)	(dB/m)	(dB)	(dB)	(cm)	(deg)	(P/A)	(H/V)
		5619.4	52.11	-16.09	68.2	40.78	31.8	6.33	26.8	100	324	P	H
		5699	57.04	-47.42	104.46	45.55	32	6.36	26.87	100	324	P	H
		5716	63.02	-46.66	109.68	51.47	32.06	6.37	26.88	100	324	P	H
		5725	63.85	-58.35	122.2	52.27	32.1	6.37	26.89	100	324	P	H
	*	5785	114.19	-	-	102.47	32.27	6.39	26.94	100	324	P	H
	*	5785	105.17	-	-	93.45	32.27	6.39	26.94	100	324	A	H
		5850.8	56.25	-64.13	120.38	44.41	32.4	6.44	27	100	324	P	H
		5869.2	54.17	-52.65	106.82	42.24	32.48	6.46	27.01	100	324	P	H
		5885	53.72	-44.05	97.77	41.74	32.54	6.47	27.03	100	324	P	H
		5947.8	51.83	-16.37	68.2	39.69	32.7	6.52	27.08	100	324	P	H
802.11ac													H
VHT20													H
CH 157		5618	53.12	-15.08	68.2	41.78	31.8	6.33	26.79	292	327	P	V
5785MHz		5697.8	51.55	-52.03	103.58	40.06	31.99	6.36	26.86	292	327	P	V
		5719.2	55.84	-54.74	110.58	44.27	32.08	6.37	26.88	292	327	P	V
		5723	59.13	-58.51	117.64	47.56	32.09	6.37	26.89	292	327	P	V
	*	5785	109	-	-	97.28	32.27	6.39	26.94	292	327	P	V
	*	5785	100.67	-	-	88.95	32.27	6.39	26.94	292	327	A	V
		5853	51.39	-63.97	115.36	39.54	32.41	6.44	27	292	327	P	V
		5859.6	52.15	-57.36	109.51	40.27	32.44	6.45	27.01	292	327	P	V
		5902.6	51.75	-32.99	84.74	39.7	32.61	6.48	27.04	292	327	P	V
		5938.6	52.62	-15.58	68.2	40.51	32.68	6.51	27.08	292	327	P	V
													V
													V



WiFi Ant.	Note	Frequency	Level	Over Limit	Limit Line	Read Level	Antenna Factor	Path Loss	Preamp Factor	Ant Pos	Table Pos	Peak Avg.	Pol.	
1+2		(MHz)	(dBμV/m)	(dB)	(dBμV/m)	(dBμV)	(dB/m)	(dB)	(dB)	(cm)	(deg)	(P/A)	(H/V)	
802.11ac VHT20 CH 165 5825MHz	*	5825	113.62	-	-	101.83	32.35	6.42	26.98	100	323	P	H	
	*	5825	104.86	-	-	93.07	32.35	6.42	26.98	100	323	A	H	
		5850.8	81.01	-39.37	120.38	69.17	32.4	6.44	27	100	323	P	H	
		5855.2	76.64	-34.1	110.74	64.78	32.42	6.44	27	100	323	P	H	
		5878.2	62.58	-40.24	102.82	50.63	32.51	6.46	27.02	100	323	P	H	
		5936.4	51.46	-16.74	68.2	39.35	32.67	6.51	27.07	100	323	P	H	
														H
														H
	*	5825	108.84	-	-	97.05	32.35	6.42	26.98	296	316	P	V	
	*	5825	100.49	-	-	88.7	32.35	6.42	26.98	296	316	A	V	
		5850	78.45	-43.75	122.2	66.61	32.4	6.44	27	296	316	P	V	
		5855.2	70.54	-40.2	110.74	58.68	32.42	6.44	27	296	316	P	V	
		5875.4	56.82	-48.08	104.9	44.88	32.5	6.46	27.02	296	316	P	V	
		5926.6	51.51	-16.69	68.2	39.43	32.65	6.5	27.07	296	316	P	V	
														V
														V
Remark	1. No other spurious found. 2. All results are PASS against Peak and Average limit line.													



**Band 4 5725~5850MHz
WIFI 802.11ac VHT20 (Harmonic @ 3m)**

WIFI Ant.	Note	Frequency	Level	Over Limit	Limit Line	Read Level	Antenna Factor	Path Loss	Preamp Factor	Ant Pos	Table Pos	Peak Avg.	Pol.
1+2		(MHz)	(dBμV/m)	(dB)	(dBμV/m)	(dBμV)	(dB/m)	(dB)	(dB)	(cm)	(deg)	(P/A)	(H/V)
802.11ac VHT20 CH 149 5745MHz		11490	47.1	-26.9	74	53.04	39.9	10.46	56.3	100	0	P	H
		17235	48.08	-20.12	68.2	51.76	39.94	12.95	56.57	100	0	P	H
													H
													H
		11490	47.61	-26.39	74	53.55	39.9	10.46	56.3	100	0	P	V
		17235	48.05	-20.15	68.2	51.73	39.94	12.95	56.57	100	0	P	V
													V
802.11ac VHT20 CH 157 5785MHz		11570	46.46	-27.54	74	52.43	39.83	10.5	56.3	100	0	P	H
		17355	48.43	-19.77	68.2	51.83	40.33	13.08	56.81	100	0	P	H
													H
													H
		11570	47.03	-26.97	74	53	39.83	10.5	56.3	100	0	P	V
		17355	49.05	-19.15	68.2	52.45	40.33	13.08	56.81	100	0	P	V
													V
802.11ac VHT20 CH 165 5825MHz		11650	46.59	-27.41	74	52.8	39.55	10.54	56.3	100	0	P	H
		17475	49.3	-18.9	68.2	52.31	40.83	13.21	57.05	100	0	P	H
													H
													H
		11650	46.8	-27.2	74	53.01	39.55	10.54	56.3	100	0	P	V
		17475	50.31	-17.89	68.2	53.32	40.83	13.21	57.05	100	0	P	V
													V
Remark	1. No other spurious found.												
	2. All results are PASS against Peak and Average limit line.												



Band 4 5725~5850MHz
WIFI 802.11ac VHT40 (Band Edge @ 3m)

WIFI Ant.	Note	Frequency	Level	Over Limit	Limit Line	Read Level	Antenna Factor	Path Loss	Preamp Factor	Ant Pos	Table Pos	Peak Avg.	Pol.
1+2		(MHz)	(dBµV/m)	(dB)	(dBµV/m)	(dBµV)	(dB/m)	(dB)	(dB)	(cm)	(deg)	(P/A)	(H/V)
		5649	60.4	-7.8	68.2	49.08	31.8	6.34	26.82	122	319	P	H
		5700	75.88	-29.32	105.2	64.39	32	6.36	26.87	122	319	P	H
		5719.2	86.87	-23.71	110.58	75.3	32.08	6.37	26.88	122	319	P	H
		5724.6	88.27	-33.02	121.29	76.69	32.1	6.37	26.89	122	319	P	H
	*	5755	109.33	-	-	97.65	32.21	6.38	26.91	122	319	P	H
	*	5755	100.42	-	-	88.74	32.21	6.38	26.91	122	319	A	H
		5850	58.62	-63.58	122.2	46.78	32.4	6.44	27	122	319	P	H
		5867.8	57.27	-49.94	107.21	45.36	32.47	6.45	27.01	122	319	P	H
		5875	56.38	-48.82	105.2	44.44	32.5	6.46	27.02	122	319	P	H
		5927.2	52.32	-15.88	68.2	40.24	32.65	6.5	27.07	122	319	P	H
802.11ac													H
VHT40													H
CH 151		5640.4	57.19	-11.01	68.2	45.86	31.8	6.34	26.81	284	337	P	V
5755MHz		5699.6	71.05	-33.86	104.91	59.56	32	6.36	26.87	284	337	P	V
		5716.2	83.71	-26.03	109.74	72.16	32.06	6.37	26.88	284	337	P	V
		5724	84.06	-35.86	119.92	72.48	32.1	6.37	26.89	284	337	P	V
	*	5755	106.03	-	-	94.35	32.21	6.38	26.91	284	337	P	V
	*	5755	96.9	-	-	85.22	32.21	6.38	26.91	284	337	A	V
		5854	55.31	-57.77	113.08	43.45	32.42	6.44	27	284	337	P	V
		5869.4	52.97	-53.8	106.77	41.05	32.48	6.46	27.02	284	337	P	V
		5877.8	53.64	-49.48	103.12	41.69	32.51	6.46	27.02	284	337	P	V
		5927.2	51.43	-16.77	68.2	39.35	32.65	6.5	27.07	284	337	P	V
													V
													V



WIFI Ant. 1+2	Note	Frequency (MHz)	Level (dBμV/m)	Over Limit (dB)	Limit Line (dBμV/m)	Read Level (dBμV)	Antenna Factor (dB/m)	Path Loss (dB)	Preamp Factor (dB)	Ant Pos (cm)	Table Pos (deg)	Peak Avg. (P/A)	Pol. (H/V)
		5640.8	53.02	-15.18	68.2	41.69	31.8	6.34	26.81	100	7	P	H
		5699	61.47	-42.99	104.46	49.98	32	6.36	26.87	100	7	P	H
		5717.8	66.51	-43.67	110.18	54.95	32.07	6.37	26.88	100	7	P	H
		5723.4	67.83	-50.72	118.55	56.26	32.09	6.37	26.89	100	7	P	H
	*	5795	108.55	-	-	96.81	32.29	6.4	26.95	100	7	P	H
	*	5795	100.15	-	-	88.41	32.29	6.4	26.95	100	7	A	H
		5853	73.8	-41.56	115.36	61.95	32.41	6.44	27	100	7	P	H
		5857.2	71.5	-38.68	110.18	59.62	32.43	6.45	27	100	7	P	H
		5875.6	61.14	-43.61	104.75	49.2	32.5	6.46	27.02	100	7	P	H
		5933.4	54.43	-13.77	68.2	42.32	32.67	6.51	27.07	100	7	P	H
802.11ac													H
VHT40													H
CH 159		5642	54.13	-14.07	68.2	42.8	31.8	6.34	26.81	100	355	P	V
5795MHz		5699.8	59.26	-45.79	105.05	47.77	32	6.36	26.87	100	355	P	V
		5718.6	63.47	-46.94	110.41	51.91	32.07	6.37	26.88	100	355	P	V
		5724.4	64.66	-56.17	120.83	53.08	32.1	6.37	26.89	100	355	P	V
	*	5795	103.96	-	-	92.22	32.29	6.4	26.95	100	355	P	V
	*	5795	95.89	-	-	84.15	32.29	6.4	26.95	100	355	A	V
		5850.8	68.64	-51.74	120.38	56.8	32.4	6.44	27	100	355	P	V
		5857.6	66.08	-43.99	110.07	54.2	32.43	6.45	27	100	355	P	V
		5875	59.15	-46.05	105.2	47.21	32.5	6.46	27.02	100	355	P	V
		5926.4	53.15	-15.05	68.2	41.07	32.65	6.5	27.07	100	355	P	V
													V
													V
Remark	1. No other spurious found. 2. All results are PASS against Peak and Average limit line.												



Band 4 5725~5850MHz
WIFI 802.11ac VHT40 (Harmonic @ 3m)

WIFI Ant.	Note	Frequency	Level	Over Limit	Limit Line	Read Level	Antenna Factor	Path Loss	Preamp Factor	Ant Pos	Table Pos	Peak Avg.	Pol.
1+2		(MHz)	(dBμV/m)	(dB)	(dBμV/m)	(dBμV)	(dB/m)	(dB)	(dB)	(cm)	(deg)	(P/A)	(H/V)
802.11ac VHT40 CH 151 5755MHz		11510	47.51	-26.49	74	53.45	39.89	10.47	56.3	100	0	P	H
		17265	48.63	-19.57	68.2	52.31	39.97	12.98	56.63	100	0	P	H
													H
													H
		11510	47.44	-26.56	74	53.38	39.89	10.47	56.3	100	0	P	V
		17265	48.69	-19.51	68.2	52.37	39.97	12.98	56.63	100	0	P	V
													V
													V
802.11ac VHT40 CH 159 5795MHz		11590	47.45	-26.55	74	53.43	39.81	10.51	56.3	100	0	P	H
		17385	49.1	-19.1	68.2	52.35	40.51	13.11	56.87	100	0	P	H
													H
													H
		11590	46.79	-27.21	74	52.77	39.81	10.51	56.3	100	0	P	V
		17385	49.06	-19.14	68.2	52.31	40.51	13.11	56.87	100	0	P	V
													V
													V
Remark	1. No other spurious found. 2. All results are PASS against Peak and Average limit line.												



Band 4 5725~5850MHz
WIFI 802.11ac VHT80 (Band Edge @ 3m)

WIFI Ant.	Note	Frequency	Level	Over Limit	Limit Line	Read Level	Antenna Factor	Path Loss	Preamp Factor	Ant Pos	Table Pos	Peak Avg.	Pol.
1+2		(MHz)	(dBμV/m)	(dB)	(dBμV/m)	(dBμV)	(dB/m)	(dB)	(dB)	(cm)	(deg)	(P/A)	(H/V)
		5647.8	63.32	-4.88	68.2	52	31.8	6.34	26.82	264	21	P	H
		5700	76.68	-28.52	105.2	65.19	32	6.36	26.87	264	21	P	H
		5720	80.04	-30.76	110.8	68.47	32.08	6.37	26.88	264	21	P	H
		5723.4	79.7	-38.85	118.55	68.13	32.09	6.37	26.89	264	21	P	H
	*	5775	104.4	-	-	92.69	32.25	6.39	26.93	264	21	P	H
	*	5775	95.89	-	-	84.18	32.25	6.39	26.93	264	21	A	H
		5850.4	72.44	-48.85	121.29	60.6	32.4	6.44	27	264	21	P	H
		5855.2	71.04	-39.7	110.74	59.18	32.42	6.44	27	264	21	P	H
		5876.4	60.75	-43.41	104.16	48.8	32.51	6.46	27.02	264	21	P	H
		5934.6	53.72	-14.48	68.2	41.61	32.67	6.51	27.07	264	21	P	H
802.11ac													H
VHT80													H
CH 155		5648.4	63.01	-5.19	68.2	51.69	31.8	6.34	26.82	300	20	P	V
5775MHz		5691.4	75.76	-23.1	98.86	64.29	31.97	6.36	26.86	300	20	P	V
		5713.4	78.61	-30.34	108.95	67.07	32.05	6.37	26.88	300	20	P	V
		5721	79.94	-33.14	113.08	68.37	32.08	6.37	26.88	300	20	P	V
	*	5775	103.78	-	-	92.07	32.25	6.39	26.93	300	20	P	V
	*	5775	95.32	-	-	83.61	32.25	6.39	26.93	300	20	A	V
		5850.4	75.84	-45.45	121.29	64	32.4	6.44	27	300	20	P	V
		5859.6	73.33	-36.18	109.51	61.45	32.44	6.45	27.01	300	20	P	V
		5875.4	65.13	-39.77	104.9	53.19	32.5	6.46	27.02	300	20	P	V
		5926.8	55.03	-13.17	68.2	42.95	32.65	6.5	27.07	300	20	P	V
													V
													V
Remark	1. No other spurious found. 2. All results are PASS against Peak and Average limit line.												



**Band 4 5725~5850MHz
WIFI 802.11ac VHT80 (Harmonic @ 3m)**

WIFI Ant.	Note	Frequency	Level	Over Limit	Limit Line	Read Level	Antenna Factor	Path Loss	Preamp Factor	Ant Pos	Table Pos	Peak Avg.	Pol.
1+2		(MHz)	(dBμV/m)	(dB)	(dBμV/m)	(dBμV)	(dB/m)	(dB)	(dB)	(cm)	(deg)	(P/A)	(H/V)
802.11ac VHT80 CH 155 5775MHz		11550	47.39	-26.61	74	53.35	39.85	10.49	56.3	100	0	P	H
		17325	48.86	-19.34	68.2	52.42	40.15	13.04	56.75	100	0	P	H
													H
													H
		11550	46.56	-27.44	74	52.52	39.85	10.49	56.3	100	0	P	V
		17325	47.91	-20.29	68.2	51.47	40.15	13.04	56.75	100	0	P	V
													V
													V
Remark	1. No other spurious found. 2. All results are PASS against Peak and Average limit line.												



Band 4 - 5725~5850MHz

WIFI 802.11ax HE20 (Band Edge @ 3m)

WIFI	Note	Frequency	Level	Over	Limit	Read	Antenna	Path	Preamp	Ant	Table	Peak	Pol.	
Ant.				Limit	Line	Level	Factor	Loss	Factor	Pos	Pos	Avg.		
1+2		(MHz)	(dBμV/m)	(dB)	(dBμV/m)	(dBμV)	(dB/m)	(dB)	(dB)	(cm)	(deg)	(P/A)	(H/V)	
802.11ax HE20 CH 149 5745MHz		5646.8	51.91	-16.29	68.2	40.59	31.8	6.34	26.82	100	321	P	H	
		5695.4	68.93	-32.88	101.81	57.45	31.98	6.36	26.86	100	321	P	H	
		5719.2	81.21	-29.37	110.58	69.64	32.08	6.37	26.88	100	321	P	H	
		5723.4	87.03	-31.52	118.55	75.46	32.09	6.37	26.89	100	321	P	H	
	*	5745	112.48	-	-	100.83	32.18	6.38	26.91	100	321	P	H	
	*	5745	102.56	-	-	90.91	32.18	6.38	26.91	100	321	A	H	
														H
														H
			5628.4	52.17	-16.03	68.2	40.84	31.8	6.33	26.8	331	184	P	V
			5700	61.87	-43.33	105.2	50.38	32	6.36	26.87	331	184	P	V
			5720	79.74	-31.06	110.8	68.17	32.08	6.37	26.88	331	184	P	V
			5724.4	85.07	-35.76	120.83	73.49	32.1	6.37	26.89	331	184	P	V
	*		5745	109.45	-	-	97.8	32.18	6.38	26.91	331	184	P	V
	*		5745	99.27	-	-	87.62	32.18	6.38	26.91	331	184	A	V
														V
													V	



WIFI Ant.	Note	Frequency	Level	Over Limit	Limit Line	Read Level	Antenna Factor	Path Loss	Preamp Factor	Ant Pos	Table Pos	Peak Avg.	Pol.
1+2		(MHz)	(dBμV/m)	(dB)	(dBμV/m)	(dBμV)	(dB/m)	(dB)	(dB)	(cm)	(deg)	(P/A)	(H/V)
		5619.6	51.34	-16.86	68.2	40.01	31.8	6.33	26.8	107	317	P	H
		5699.6	53.7	-51.21	104.91	42.21	32	6.36	26.87	107	317	P	H
		5717.2	59.3	-50.72	110.02	47.74	32.07	6.37	26.88	107	317	P	H
		5725	61.05	-61.15	122.2	49.47	32.1	6.37	26.89	107	317	P	H
	*	5785	113.02	-	-	101.3	32.27	6.39	26.94	107	317	P	H
	*	5785	102.8	-	-	91.08	32.27	6.39	26.94	107	317	A	H
		5851	57.21	-62.71	119.92	45.37	32.4	6.44	27	107	317	P	H
		5855.2	55.4	-55.34	110.74	43.54	32.42	6.44	27	107	317	P	H
		5883.8	52.31	-46.36	98.67	40.33	32.54	6.47	27.03	107	317	P	H
		5927.2	52.23	-15.97	68.2	40.15	32.65	6.5	27.07	107	317	P	H
802.11ax													H
HE20													H
CH 157		5626	52.42	-15.78	68.2	41.09	31.8	6.33	26.8	313	185	P	V
5785MHz		5697.6	54.14	-49.29	103.43	42.65	31.99	6.36	26.86	313	185	P	V
		5715.6	58.43	-51.14	109.57	46.88	32.06	6.37	26.88	313	185	P	V
		5724.4	59.13	-61.7	120.83	47.55	32.1	6.37	26.89	313	185	P	V
	*	5785	108.57	-	-	96.85	32.27	6.39	26.94	313	185	P	V
	*	5785	98.62	-	-	86.9	32.27	6.39	26.94	313	185	A	V
		5850.8	53.99	-66.39	120.38	42.15	32.4	6.44	27	313	185	P	V
		5866.2	53.69	-53.97	107.66	41.79	32.46	6.45	27.01	313	185	P	V
		5875.6	52.26	-52.49	104.75	40.32	32.5	6.46	27.02	313	185	P	V
		5948	51.7	-16.5	68.2	39.56	32.7	6.52	27.08	313	185	P	V
													V
													V



WiFi Ant.	Note	Frequency	Level	Over Limit	Limit Line	Read Level	Antenna Factor	Path Loss	Preamp Factor	Ant Pos	Table Pos	Peak Avg.	Pol.	
1+2		(MHz)	(dBμV/m)	(dB)	(dBμV/m)	(dBμV)	(dB/m)	(dB)	(dB)	(cm)	(deg)	(P/A)	(H/V)	
802.11ax HE20 CH 165 5825MHz	*	5825	113.09	-	-	101.3	32.35	6.42	26.98	119	321	P	H	
	*	5825	102.9	-	-	91.11	32.35	6.42	26.98	119	321	A	H	
		5850	84.02	-38.18	122.2	72.18	32.4	6.44	27	119	321	P	H	
		5855.2	78.94	-31.8	110.74	67.08	32.42	6.44	27	119	321	P	H	
		5875.2	62.91	-42.14	105.05	50.97	32.5	6.46	27.02	119	321	P	H	
		5926.8	51.92	-16.28	68.2	39.84	32.65	6.5	27.07	119	321	P	H	
														H
														H
	*	5825	108.6	-	-	96.81	32.35	6.42	26.98	291	178	P	V	
	*	5825	98.47	-	-	86.68	32.35	6.42	26.98	291	178	A	V	
		5850.8	80.43	-39.95	120.38	68.59	32.4	6.44	27	291	178	P	V	
		5855.2	77.52	-33.22	110.74	65.66	32.42	6.44	27	291	178	P	V	
		5876	58.21	-46.25	104.46	46.27	32.5	6.46	27.02	291	178	P	V	
		5930.4	52.29	-15.91	68.2	40.2	32.66	6.5	27.07	291	178	P	V	
														V
													V	
Remark	1. No other spurious found. 2. All results are PASS against Peak and Average limit line.													



Band 4 5725~5850MHz
WIFI 802.11ax HE20 (Harmonic @ 3m)

WIFI Ant.	Note	Frequency	Level	Over Limit	Limit Line	Read Level	Antenna Factor	Path Loss	Preamp Factor	Ant Pos	Table Pos	Peak Avg.	Pol.
1+2		(MHz)	(dBµV/m)	(dB)	(dBµV/m)	(dBµV)	(dB/m)	(dB)	(dB)	(cm)	(deg)	(P/A)	(H/V)
802.11ax HE20 CH 149 5745MHz		11490	46.5	-27.5	74	52.44	39.9	10.46	56.3	100	0	P	H
		17235	48.3	-19.9	68.2	51.98	39.94	12.95	56.57	100	0	P	H
													H
													H
		11490	47.15	-26.85	74	53.09	39.9	10.46	56.3	100	0	P	V
		17235	48.49	-19.71	68.2	52.17	39.94	12.95	56.57	100	0	P	V
													V
802.11ax HE20 CH 157 5785MHz		11570	45.76	-28.24	74	51.73	39.83	10.5	56.3	100	0	P	H
		17355	47.81	-20.39	68.2	51.21	40.33	13.08	56.81	100	0	P	H
													H
													H
		11570	46.45	-27.55	74	52.42	39.83	10.5	56.3	100	0	P	V
		17355	47.64	-20.56	68.2	51.04	40.33	13.08	56.81	100	0	P	V
													V
802.11ax HE20 CH 165 5825MHz		11650	46.44	-27.56	74	52.65	39.55	10.54	56.3	100	0	P	H
		17475	48.78	-19.42	68.2	51.79	40.83	13.21	57.05	100	0	P	H
													H
													H
		11650	46.28	-27.72	74	52.49	39.55	10.54	56.3	100	0	P	V
		17475	49.51	-18.69	68.2	52.52	40.83	13.21	57.05	100	0	P	V
													V
Remark	1. No other spurious found.												
	2. All results are PASS against Peak and Average limit line.												



Band 4 5725~5850MHz
WIFI 802.11ax HE40 (Band Edge @ 3m)

WIFI Ant.	Note	Frequency	Level	Over Limit	Limit Line	Read Level	Antenna Factor	Path Loss	Preamp Factor	Ant Pos	Table Pos	Peak Avg.	Pol.
1+2		(MHz)	(dBμV/m)	(dB)	(dBμV/m)	(dBμV)	(dB/m)	(dB)	(dB)	(cm)	(deg)	(P/A)	(H/V)
		5648.8	59.73	-8.47	68.2	48.41	31.8	6.34	26.82	100	319	P	H
		5696.8	73.06	-29.78	102.84	61.57	31.99	6.36	26.86	100	319	P	H
		5718.2	85.24	-25.06	110.3	73.68	32.07	6.37	26.88	100	319	P	H
		5721.4	86.96	-27.03	113.99	75.38	32.09	6.37	26.88	100	319	P	H
	*	5755	108.82	-	-	97.14	32.21	6.38	26.91	100	319	P	H
	*	5755	99.59	-	-	87.91	32.21	6.38	26.91	100	319	A	H
		5850.6	58.7	-62.13	120.83	46.86	32.4	6.44	27	100	319	P	H
		5857.6	57.77	-52.3	110.07	45.89	32.43	6.45	27	100	319	P	H
		5884	53.39	-45.13	98.52	41.41	32.54	6.47	27.03	100	319	P	H
		5946.4	51.22	-16.98	68.2	39.09	32.69	6.52	27.08	100	319	P	H
802.11ax													H
HE40													H
CH 151		5646.2	56.99	-11.21	68.2	45.67	31.8	6.34	26.82	301	181	P	V
5755MHz		5696.6	71.84	-30.85	102.69	60.35	31.99	6.36	26.86	301	181	P	V
		5720	84.15	-26.65	110.8	72.58	32.08	6.37	26.88	301	181	P	V
		5724.4	85.62	-35.21	120.83	74.04	32.1	6.37	26.89	301	181	P	V
	*	5755	106.61	-	-	94.93	32.21	6.38	26.91	301	181	P	V
	*	5755	96.39	-	-	84.71	32.21	6.38	26.91	301	181	A	V
		5851.6	55.62	-62.93	118.55	43.77	32.41	6.44	27	301	181	P	V
		5864	54.52	-53.76	108.28	42.62	32.46	6.45	27.01	301	181	P	V
		5876.4	53.37	-50.79	104.16	41.42	32.51	6.46	27.02	301	181	P	V
		5933	50.67	-17.53	68.2	38.56	32.67	6.51	27.07	301	181	P	V
													V
													V



WIFI Ant. 1+2	Note	Frequency (MHz)	Level (dBμV/m)	Over Limit (dB)	Limit Line (dBμV/m)	Read Level (dBμV)	Antenna Factor (dB/m)	Path Loss (dB)	Preamp Factor (dB)	Ant Pos (cm)	Table Pos (deg)	Peak Avg. (P/A)	Pol. (H/V)
		5639	54.63	-13.57	68.2	43.3	31.8	6.34	26.81	107	320	P	H
		5696.2	63.88	-38.52	102.4	52.4	31.98	6.36	26.86	107	320	P	H
		5714.8	69.41	-39.94	109.35	57.86	32.06	6.37	26.88	107	320	P	H
		5723.4	72.2	-46.35	118.55	60.63	32.09	6.37	26.89	107	320	P	H
	*	5795	110.31	-	-	98.57	32.29	6.4	26.95	107	320	P	H
	*	5795	100.24	-	-	88.5	32.29	6.4	26.95	107	320	A	H
		5850.4	76.19	-45.1	121.29	64.35	32.4	6.44	27	107	320	P	H
		5857	74.77	-35.47	110.24	62.89	32.43	6.45	27	107	320	P	H
		5883.8	67.27	-31.4	98.67	55.29	32.54	6.47	27.03	107	320	P	H
		5932.8	54.53	-13.67	68.2	42.42	32.67	6.51	27.07	107	320	P	H
802.11ax													H
HE40													H
CH 159		5641.6	55.16	-13.04	68.2	43.83	31.8	6.34	26.81	294	180	P	V
5795MHz		5697.4	62.39	-40.89	103.28	50.9	31.99	6.36	26.86	294	180	P	V
		5715.4	69.67	-39.84	109.51	58.12	32.06	6.37	26.88	294	180	P	V
		5725	70.69	-51.51	122.2	59.11	32.1	6.37	26.89	294	180	P	V
	*	5795	104.96	-	-	93.22	32.29	6.4	26.95	294	180	P	V
	*	5795	96.05	-	-	84.31	32.29	6.4	26.95	294	180	A	V
		5853.4	72.58	-41.87	114.45	60.73	32.41	6.44	27	294	180	P	V
		5855.4	72.39	-38.3	110.69	60.53	32.42	6.44	27	294	180	P	V
		5878.8	62.58	-39.8	102.38	50.62	32.52	6.46	27.02	294	180	P	V
		5927	52.86	-15.34	68.2	40.78	32.65	6.5	27.07	294	180	P	V
													V
													V
Remark	1. No other spurious found. 2. All results are PASS against Peak and Average limit line.												



Band 4 5725~5850MHz
WIFI 802.11ax HE40 (Harmonic @ 3m)

WIFI Ant.	Note	Frequency	Level	Over Limit	Limit Line	Read Level	Antenna Factor	Path Loss	Preamp Factor	Ant Pos	Table Pos	Peak Avg.	Pol.
1+2		(MHz)	(dBμV/m)	(dB)	(dBμV/m)	(dBμV)	(dB/m)	(dB)	(dB)	(cm)	(deg)	(P/A)	(H/V)
802.11ax HE40 CH 151 5755MHz		11510	47.35	-26.65	74	53.29	39.89	10.47	56.3	100	0	P	H
		17265	47.91	-20.29	68.2	51.59	39.97	12.98	56.63	100	0	P	H
													H
													H
		11510	48.32	-25.68	74	54.26	39.89	10.47	56.3	100	0	P	V
		17265	47.46	-20.74	68.2	51.14	39.97	12.98	56.63	100	0	P	V
													V
													V
802.11ax HE40 CH 159 5795MHz		11590	47.12	-26.88	74	53.1	39.81	10.51	56.3	100	0	P	H
		17385	49	-19.2	68.2	52.25	40.51	13.11	56.87	100	0	P	H
													H
													H
		11590	46.72	-27.28	74	52.7	39.81	10.51	56.3	100	0	P	V
		17385	48.54	-19.66	68.2	51.79	40.51	13.11	56.87	100	0	P	V
													V
													V
Remark	1. No other spurious found. 2. All results are PASS against Peak and Average limit line.												



Band 4 5725~5850MHz
WIFI 802.11ax HE80 (Band Edge @ 3m)

WIFI Ant.	Note	Frequency	Level	Over Limit	Limit Line	Read Level	Antenna Factor	Path Loss	Preamp Factor	Ant Pos	Table Pos	Peak Avg.	Pol.
1+2		(MHz)	(dBμV/m)	(dB)	(dBμV/m)	(dBμV)	(dB/m)	(dB)	(dB)	(cm)	(deg)	(P/A)	(H/V)
		5645.8	62.95	-5.25	68.2	51.63	31.8	6.34	26.82	264	21	P	H
		5687.2	74.97	-20.79	95.76	63.52	31.95	6.35	26.85	264	21	P	H
		5711.4	79.8	-28.59	108.39	68.27	32.05	6.36	26.88	264	21	P	H
		5724	80.45	-39.47	119.92	68.87	32.1	6.37	26.89	264	21	P	H
	*	5775	105.94	-	-	94.23	32.25	6.39	26.93	264	21	P	H
	*	5775	95.36	-	-	83.65	32.25	6.39	26.93	264	21	A	H
		5850	70.31	-51.89	122.2	58.47	32.4	6.44	27	264	21	P	H
		5861.2	69.81	-39.25	109.06	57.93	32.44	6.45	27.01	264	21	P	H
		5875.2	64.16	-40.89	105.05	52.22	32.5	6.46	27.02	264	21	P	H
		5926.4	53.6	-14.6	68.2	41.52	32.65	6.5	27.07	264	21	P	H
802.11ax													H
HE80													H
CH 155		5646.8	63	-5.2	68.2	51.68	31.8	6.34	26.82	307	319	P	V
5775MHz		5694.6	76.67	-24.55	101.22	65.19	31.98	6.36	26.86	307	319	P	V
		5717.6	82.49	-27.64	110.13	70.93	32.07	6.37	26.88	307	319	P	V
		5723.8	82.51	-36.95	119.46	70.93	32.1	6.37	26.89	307	319	P	V
	*	5775	105.97	-	-	94.26	32.25	6.39	26.93	307	319	P	V
	*	5775	96.71	-	-	85	32.25	6.39	26.93	307	319	A	V
		5854.4	76.39	-35.78	112.17	64.53	32.42	6.44	27	307	319	P	V
		5856	74.83	-35.69	110.52	62.97	32.42	6.44	27	307	319	P	V
		5875	66.6	-38.6	105.2	54.66	32.5	6.46	27.02	307	319	P	V
		5929.6	55.45	-12.75	68.2	43.36	32.66	6.5	27.07	307	319	P	V
													V
													V
Remark	1. No other spurious found. 2. All results are PASS against Peak and Average limit line.												



**Band 4 5725~5850MHz
WIFI 802.11ax HE80 (Harmonic @ 3m)**

WIFI Ant.	Note	Frequency	Level	Over Limit	Limit Line	Read Level	Antenna Factor	Path Loss	Preamp Factor	Ant Pos	Table Pos	Peak Avg.	Pol.
1+2		(MHz)	(dBμV/m)	(dB)	(dBμV/m)	(dBμV)	(dB/m)	(dB)	(dB)	(cm)	(deg)	(P/A)	(H/V)
802.11ax HE80 CH 155 5775MHz		11550	46.41	-27.59	74	52.37	39.85	10.49	56.3	100	0	P	H
		17325	48.82	-19.38	68.2	52.38	40.15	13.04	56.75	100	0	P	H
													H
													H
		11550	47.23	-26.77	74	53.19	39.85	10.49	56.3	100	0	P	V
		17325	47.44	-20.76	68.2	51	40.15	13.04	56.75	100	0	P	V
													V
													V
Remark	1. No other spurious found. 2. All results are PASS against Peak and Average limit line.												



Band 4 5725~5850MHz

WIFI 802.11ax HE20 (Partial RU 26/0) (Band Edge @ 3m)

WIFI Ant.	Note	Frequency	Level	Over Limit	Limit Line	Read Level	Antenna Factor	Path Loss	Preamp Factor	Ant Pos	Table Pos	Peak Avg.	Pol.	
1+2		(MHz)	(dBμV/m)	(dB)	(dBμV/m)	(dBμV)	(dB/m)	(dB)	(dB)	(cm)	(deg)	(P/A)	(H/V)	
802.11ax HE20 26/0 RU CH 149 5745MHz		5616.4	51.33	-16.87	68.2	39.99	31.8	6.33	26.79	305	329	P	H	
		5694.6	53.93	-47.29	101.22	42.45	31.98	6.36	26.86	305	329	P	H	
		5719.8	62.75	-47.99	110.74	51.18	32.08	6.37	26.88	305	329	P	H	
		5724.8	71.97	-49.77	121.74	60.39	32.1	6.37	26.89	305	329	P	H	
	*	5745	116.74	-	-	105.09	32.18	6.38	26.91	305	329	P	H	
	*	5745	111.01	-	-	99.36	32.18	6.38	26.91	305	329	A	H	
														H
														H
			5612.6	52.81	-15.39	68.2	41.47	31.8	6.33	26.79	203	33	P	V
			5697.6	52.18	-51.25	103.43	40.69	31.99	6.36	26.86	203	33	P	V
			5719.6	69.43	-41.26	110.69	57.86	32.08	6.37	26.88	203	33	P	V
			5724.2	71.16	-49.22	120.38	59.58	32.1	6.37	26.89	203	33	P	V
	*		5745	115.3	-	-	103.65	32.18	6.38	26.91	203	33	P	V
	*		5745	109.37	-	-	97.72	32.18	6.38	26.91	203	33	A	V
														V
													V	
Remark	1. No other spurious found. 2. All results are PASS against Peak and Average limit line.													



Band 4 5725~5850MHz

WIFI 802.11ax HE20 (Partial RU 26/8) (Band Edge @ 3m)

WIFI Ant. 1+2	Note	Frequency (MHz)	Level (dBμV/m)	Over Limit (dB)	Limit Line (dBμV/m)	Read Level (dBμV)	Antenna Factor (dB/m)	Path Loss (dB)	Preamp Factor (dB)	Ant Pos (cm)	Table Pos (deg)	Peak Avg. (P/A)	Pol. (H/V)	
802.11ax HE20 26/8 RU CH 165 5825MHz	*	5825	116.96	-	-	105.17	32.35	6.42	26.98	300	36	P	H	
	*	5825	111.04	-	-	99.25	32.35	6.42	26.98	300	36	A	H	
		5851.2	78.16	-41.3	119.46	66.32	32.4	6.44	27	300	36	P	H	
		5862.4	65.43	-43.3	108.73	53.54	32.45	6.45	27.01	300	36	P	H	
		5881.6	57.24	-43.06	100.3	45.27	32.53	6.47	27.03	300	36	P	H	
		5936.6	51.91	-16.29	68.2	39.8	32.67	6.51	27.07	300	36	P	H	
														H
														H
	*	5825	114.28	-	-	102.49	32.35	6.42	26.98	191	34	P	V	
	*	5825	108.22	-	-	96.43	32.35	6.42	26.98	191	34	A	V	
		5850	60.69	-61.51	122.2	48.85	32.4	6.44	27	191	34	P	V	
		5859	56.31	-53.37	109.68	44.43	32.44	6.45	27.01	191	34	P	V	
		5883.2	54.28	-44.83	99.11	42.31	32.53	6.47	27.03	191	34	P	V	
		5948	51.55	-16.65	68.2	39.41	32.7	6.52	27.08	191	34	P	V	
														V
													V	
Remark	1. No other spurious found. 2. All results are PASS against Peak and Average limit line.													



Band 4 5725~5850MHz

WIFI 802.11ax HE20 (Partial RU 52/37(Band Edge @ 3m))

WIFI Ant.	Note	Frequency	Level	Over Limit	Limit Line	Read Level	Antenna Factor	Path Loss	Preamp Factor	Ant Pos	Table Pos	Peak Avg.	Pol.	
1+2		(MHz)	(dBμV/m)	(dB)	(dBμV/m)	(dBμV)	(dB/m)	(dB)	(dB)	(cm)	(deg)	(P/A)	(H/V)	
802.11ax HE20 52/37 RU CH 149 5745MHz		5634.4	52.17	-16.03	68.2	40.85	31.8	6.33	26.81	309	329	P	H	
		5695.8	57.48	-44.62	102.1	46	31.98	6.36	26.86	309	329	P	H	
		5717.2	69.38	-40.64	110.02	57.82	32.07	6.37	26.88	309	329	P	H	
		5722.4	76.87	-39.4	116.27	65.3	32.09	6.37	26.89	309	329	P	H	
	*	5745	117.02	-	-	105.37	32.18	6.38	26.91	309	329	P	H	
	*	5745	109.26	-	-	97.61	32.18	6.38	26.91	309	329	A	H	
														H
														H
			5628.6	51.94	-16.26	68.2	40.61	31.8	6.33	26.8	199	35	P	V
			5694.6	51.64	-49.58	101.22	40.16	31.98	6.36	26.86	199	35	P	V
			5718.2	65.61	-44.69	110.3	54.05	32.07	6.37	26.88	199	35	P	V
			5724.6	74.54	-46.75	121.29	62.96	32.1	6.37	26.89	199	35	P	V
	*		5745	115.12	-	-	103.47	32.18	6.38	26.91	199	35	P	V
	*		5745	107.74	-	-	96.09	32.18	6.38	26.91	199	35	A	V
													V	
													V	
Remark	1. No other spurious found. 2. All results are PASS against Peak and Average limit line.													



Band 4 5725~5850MHz

WIFI 802.11ax HE20 (Partial RU 52/40) (Band Edge @ 3m)

WIFI Ant. 1+2	Note	Frequency (MHz)	Level (dBμV/m)	Over Limit (dB)	Limit Line (dBμV/m)	Read Level (dBμV)	Antenna Factor (dB/m)	Path Loss (dB)	Preamp Factor (dB)	Ant Pos (cm)	Table Pos (deg)	Peak Avg. (P/A)	Pol. (H/V)	
802.11ax HE20 52/40 RU CH 165 5825MHz	*	5825	116.49	-	-	104.7	32.35	6.42	26.98	317	43	P	H	
	*	5825	109.21	-	-	97.42	32.35	6.42	26.98	317	43	A	H	
		5851.4	77.67	-41.34	119.01	65.82	32.41	6.44	27	317	43	P	H	
		5864	62.12	-46.16	108.28	50.22	32.46	6.45	27.01	317	43	P	H	
		5888.6	52.78	-42.32	95.1	40.79	32.55	6.47	27.03	317	43	P	H	
		5931.2	51.67	-16.53	68.2	39.58	32.66	6.5	27.07	317	43	P	H	
														H
														H
	*	5825	114	-	-	102.21	32.35	6.42	26.98	202	37	P	V	
	*	5825	106.11	-	-	94.32	32.35	6.42	26.98	202	37	A	V	
		5850.8	75.43	-44.95	120.38	63.59	32.4	6.44	27	202	37	P	V	
		5857.4	64.44	-45.69	110.13	52.56	32.43	6.45	27	202	37	P	V	
		5883	54.74	-44.52	99.26	42.77	32.53	6.47	27.03	202	37	P	V	
		5929	52.48	-15.72	68.2	40.39	32.66	6.5	27.07	202	37	P	V	
														V
													V	
Remark	1. No other spurious found. 2. All results are PASS against Peak and Average limit line.													



Band 4 5725~5850MHz

WIFI 802.11ax HE20 (Partial RU 106/53) (Band Edge @ 3m)

WIFI Ant.	Note	Frequency	Level	Over Limit	Limit Line	Read Level	Antenna Factor	Path Loss	Preamp Factor	Ant Pos	Table Pos	Peak Avg.	Pol.	
1+2		(MHz)	(dBμV/m)	(dB)	(dBμV/m)	(dBμV)	(dB/m)	(dB)	(dB)	(cm)	(deg)	(P/A)	(H/V)	
802.11ax HE20 106/53 RU CH 149 5745MHz		5604.4	51.88	-16.32	68.2	40.54	31.8	6.32	26.78	309	327	P	H	
		5687.4	55.65	-40.26	95.91	44.2	31.95	6.35	26.85	309	327	P	H	
		5718.2	73.21	-37.09	110.3	61.65	32.07	6.37	26.88	309	327	P	H	
		5724.6	75.58	-45.71	121.29	64	32.1	6.37	26.89	309	327	P	H	
	*	5745	115.09	-	-	103.44	32.18	6.38	26.91	309	327	P	H	
	*	5745	107.62	-	-	95.97	32.18	6.38	26.91	309	327	A	H	
														H
														H
			5615.2	51.71	-16.49	68.2	40.37	31.8	6.33	26.79	195	34	P	V
			5699.4	59.8	-44.96	104.76	48.31	32	6.36	26.87	195	34	P	V
			5719.8	76.3	-34.44	110.74	64.73	32.08	6.37	26.88	195	34	P	V
			5724.8	78.35	-43.39	121.74	66.77	32.1	6.37	26.89	195	34	P	V
	*		5745	114.34	-	-	102.69	32.18	6.38	26.91	195	34	P	V
	*		5745	107.05	-	-	95.4	32.18	6.38	26.91	195	34	A	V
													V	
													V	
Remark	1. No other spurious found. 2. All results are PASS against Peak and Average limit line.													



Band 4 5725~5850MHz

WIFI 802.11ax HE20 (Partial RU 106/54) (Band Edge @ 3m)

WIFI Ant.	Note	Frequency	Level	Over Limit	Limit Line	Read Level	Antenna Factor	Path Loss	Preamp Factor	Ant Pos	Table Pos	Peak Avg.	Pol.	
1+2		(MHz)	(dBμV/m)	(dB)	(dBμV/m)	(dBμV)	(dB/m)	(dB)	(dB)	(cm)	(deg)	(P/A)	(H/V)	
802.11ax HE20 106/54 RU CH 165 5825MHz	*	5825	115.25	-	-	103.46	32.35	6.42	26.98	316	43	P	H	
	*	5825	107.85	-	-	96.06	32.35	6.42	26.98	316	43	A	H	
		5850	70.73	-51.47	122.2	58.89	32.4	6.44	27	316	43	P	H	
		5855.8	69.76	-40.82	110.58	57.9	32.42	6.44	27	316	43	P	H	
		5875.4	58.09	-46.81	104.9	46.15	32.5	6.46	27.02	316	43	P	H	
		5940.8	52.7	-15.5	68.2	40.59	32.68	6.51	27.08	316	43	P	H	
														H
														H
	*	5825	112.66	-	-	100.87	32.35	6.42	26.98	191	37	P	V	
	*	5825	104.43	-	-	92.64	32.35	6.42	26.98	191	37	A	V	
		5852.6	68.37	-47.9	116.27	56.52	32.41	6.44	27	191	37	P	V	
		5863.4	64.7	-43.75	108.45	52.81	32.45	6.45	27.01	191	37	P	V	
		5881.8	54.25	-45.9	100.15	42.28	32.53	6.47	27.03	191	37	P	V	
		5928.8	52.65	-15.55	68.2	40.56	32.66	6.5	27.07	191	37	P	V	
														V
													V	
Remark	1. No other spurious found. 2. All results are PASS against Peak and Average limit line.													



Band 4 5725~5850MHz

WIFI 802.11ax HE40 (Partial RU 242/61) (Band Edge @ 3m)

WIFI Ant.	Note	Frequency	Level	Over Limit	Limit Line	Read Level	Antenna Factor	Path Loss	Preamp Factor	Ant Pos	Table Pos	Peak Avg.	Pol.
1+2		(MHz)	(dBμV/m)	(dB)	(dBμV/m)	(dBμV)	(dB/m)	(dB)	(dB)	(cm)	(deg)	(P/A)	(H/V)
		5646.2	60.55	-7.65	68.2	49.23	31.8	6.34	26.82	105	325	P	H
		5700	74.6	-30.6	105.2	63.11	32	6.36	26.87	105	325	P	H
		5719.4	88.25	-22.38	110.63	76.68	32.08	6.37	26.88	105	325	P	H
		5722.6	87.58	-29.15	116.73	76.01	32.09	6.37	26.89	105	325	P	H
	*	5755	113.05	-	-	101.37	32.21	6.38	26.91	105	325	P	H
	*	5755	104.82	-	-	93.14	32.21	6.38	26.91	105	325	A	H
		5851.6	60.32	-58.23	118.55	48.47	32.41	6.44	27	105	325	P	H
		5858.2	56.17	-53.73	109.9	44.3	32.43	6.45	27.01	105	325	P	H
		5890.2	54.84	-39.08	93.92	42.84	32.56	6.47	27.03	105	325	P	H
		5935.4	52.05	-16.15	68.2	39.94	32.67	6.51	27.07	105	325	P	H
802.11ax													H
HE40													H
242/61 RU													
CH 151		5649.8	59	-9.2	68.2	47.68	31.8	6.34	26.82	186	34	P	V
5755MHz		5695	68.98	-32.53	101.51	57.5	31.98	6.36	26.86	186	34	P	V
		5719.6	80.28	-30.41	110.69	68.71	32.08	6.37	26.88	186	34	P	V
		5724.4	85.06	-35.77	120.83	73.48	32.1	6.37	26.89	186	34	P	V
	*	5755	112.63	-	-	100.95	32.21	6.38	26.91	186	34	P	V
	*	5755	102.84	-	-	91.16	32.21	6.38	26.91	186	34	A	V
		5850	56.45	-65.75	122.2	44.61	32.4	6.44	27	186	34	P	V
		5860.2	54.75	-54.59	109.34	42.87	32.44	6.45	27.01	186	34	P	V
		5894.2	51.89	-39.06	90.95	39.87	32.58	6.48	27.04	186	34	P	V
		5939.2	51.97	-16.23	68.2	39.86	32.68	6.51	27.08	186	34	P	V
													V
													V
Remark	1. No other spurious found. 2. All results are PASS against Peak and Average limit line.												



Band 4 5725~5850MHz

WIFI 802.11ax HE40 (Partial RU 242/62) (Band Edge @ 3m)

WIFI Ant.	Note	Frequency	Level	Over Limit	Limit Line	Read Level	Antenna Factor	Path Loss	Preamp Factor	Ant Pos	Table Pos	Peak Avg.	Pol.
1+2		(MHz)	(dBμV/m)	(dB)	(dBμV/m)	(dBμV)	(dB/m)	(dB)	(dB)	(cm)	(deg)	(P/A)	(H/V)
		5644.2	52.39	-15.81	68.2	41.07	31.8	6.34	26.82	309	40	P	H
		5696.4	61.38	-41.17	102.55	49.89	31.99	6.36	26.86	309	40	P	H
		5717.6	67.59	-42.54	110.13	56.03	32.07	6.37	26.88	309	40	P	H
		5721.6	66.6	-47.85	114.45	55.03	32.09	6.37	26.89	309	40	P	H
	*	5795	113.57	-	-	101.83	32.29	6.4	26.95	309	40	P	H
	*	5795	104.92	-	-	93.18	32.29	6.4	26.95	309	40	A	H
		5851.6	78.63	-39.92	118.55	66.78	32.41	6.44	27	309	40	P	H
		5859.4	70.47	-39.1	109.57	58.59	32.44	6.45	27.01	309	40	P	H
		5880	62.27	-39.22	101.49	50.31	32.52	6.46	27.02	309	40	P	H
		5925	54.22	-13.98	68.2	42.13	32.65	6.5	27.06	309	40	P	H
802.11ax													H
HE40													H
242/62 RU													
CH 159		5642.8	54.74	-13.46	68.2	43.42	31.8	6.34	26.82	190	36	P	V
5795MHz		5686.2	59.5	-35.52	95.02	48.06	31.94	6.35	26.85	190	36	P	V
		5717.4	64.9	-45.17	110.07	53.34	32.07	6.37	26.88	190	36	P	V
		5721.4	65.74	-48.25	113.99	54.16	32.09	6.37	26.88	190	36	P	V
	*	5795	110.73	-	-	98.99	32.29	6.4	26.95	190	36	P	V
	*	5795	102.79	-	-	91.05	32.29	6.4	26.95	190	36	A	V
		5853	71.09	-44.27	115.36	59.24	32.41	6.44	27	190	36	P	V
		5859.2	67.73	-41.89	109.62	55.85	32.44	6.45	27.01	190	36	P	V
		5884.2	58.73	-39.64	98.37	46.75	32.54	6.47	27.03	190	36	P	V
		5948.4	52.43	-15.77	68.2	40.29	32.7	6.52	27.08	190	36	P	V
													V
													V
Remark	1. No other spurious found. 2. All results are PASS against Peak and Average limit line.												



Band 4 5725~5850MHz

WIFI 802.11ax HE80 (Partial RU 484/65) (Band Edge @ 3m)

WIFI Ant.	Note	Frequency	Level	Over Limit	Limit Line	Read Level	Antenna Factor	Path Loss	Preamp Factor	Ant Pos	Table Pos	Peak Avg.	Pol.
1+2		(MHz)	(dBμV/m)	(dB)	(dBμV/m)	(dBμV)	(dB/m)	(dB)	(dB)	(cm)	(deg)	(P/A)	(H/V)
		5631	64.17	-4.03	68.2	52.85	31.8	6.33	26.81	266	319	P	H
		5697	78.75	-24.24	102.99	67.26	31.99	6.36	26.86	266	319	P	H
		5719.8	86.97	-23.77	110.74	75.4	32.08	6.37	26.88	266	319	P	H
		5721.8	87.36	-27.54	114.9	75.79	32.09	6.37	26.89	266	319	P	H
	*	5775	110.53	-	-	98.82	32.25	6.39	26.93	266	319	P	H
	*	5775	100.81	-	-	89.1	32.25	6.39	26.93	266	319	A	H
		5851	79.05	-40.87	119.92	67.21	32.4	6.44	27	266	319	P	H
		5859	76.28	-33.4	109.68	64.4	32.44	6.45	27.01	266	319	P	H
		5875.8	67.47	-37.14	104.61	55.53	32.5	6.46	27.02	266	319	P	H
		5931	58.65	-9.55	68.2	46.56	32.66	6.5	27.07	266	319	P	H
802.11ax													H
HE80													H
484/65 RU													
CH 155		5623.2	60.32	-7.88	68.2	48.99	31.8	6.33	26.8	192	29	P	V
5775MHz		5680.6	72.69	-18.19	90.88	61.27	31.92	6.35	26.85	192	29	P	V
		5718.8	83.39	-27.07	110.46	71.82	32.08	6.37	26.88	192	29	P	V
		5723	82.4	-35.24	117.64	70.83	32.09	6.37	26.89	192	29	P	V
	*	5775	106.43	-	-	94.72	32.25	6.39	26.93	192	29	P	V
	*	5775	96.96	-	-	85.25	32.25	6.39	26.93	192	29	A	V
		5851.2	71.73	-47.73	119.46	59.89	32.4	6.44	27	192	29	P	V
		5859	70.4	-39.28	109.68	58.52	32.44	6.45	27.01	192	29	P	V
		5877.8	61.71	-41.41	103.12	49.76	32.51	6.46	27.02	192	29	P	V
		5926.4	55.04	-13.16	68.2	42.96	32.65	6.5	27.07	192	29	P	V
													V
													V
Remark	1. No other spurious found. 2. All results are PASS against Peak and Average limit line.												



Band 4 5725~5850MHz

WIFI 802.11ax HE80 (Partial RU 484/66) (Band Edge @ 3m)

WIFI Ant.	Note	Frequency	Level	Over Limit	Limit Line	Read Level	Antenna Factor	Path Loss	Preamp Factor	Ant Pos	Table Pos	Peak Avg.	Pol.
1+2		(MHz)	(dBμV/m)	(dB)	(dBμV/m)	(dBμV)	(dB/m)	(dB)	(dB)	(cm)	(deg)	(P/A)	(H/V)
		5650	62.63	-5.57	68.2	51.31	31.8	6.34	26.82	286	39	P	H
		5691.2	80.8	-17.91	98.71	69.34	31.96	6.36	26.86	286	39	P	H
		5717.8	84.42	-25.76	110.18	72.86	32.07	6.37	26.88	286	39	P	H
		5723.2	86.36	-31.74	118.1	74.79	32.09	6.37	26.89	286	39	P	H
	*	5775	110.17	-	-	98.46	32.25	6.39	26.93	286	39	P	H
	*	5775	100.71	-	-	89	32.25	6.39	26.93	286	39	A	H
		5850.4	78.31	-42.98	121.29	66.47	32.4	6.44	27	286	39	P	H
		5872.8	77.36	-28.46	105.82	65.43	32.49	6.46	27.02	286	39	P	H
		5886	68.73	-28.3	97.03	56.75	32.54	6.47	27.03	286	39	P	H
		5931.4	59.33	-8.87	68.2	47.23	32.66	6.51	27.07	286	39	P	H
802.11ax													H
HE80													H
484/66 RU													
CH 155		5645.6	63.07	-5.13	68.2	51.75	31.8	6.34	26.82	196	29	P	V
5775MHz		5696.8	77.18	-25.66	102.84	65.69	31.99	6.36	26.86	196	29	P	V
		5719	83.11	-27.41	110.52	71.54	32.08	6.37	26.88	196	29	P	V
		5723.2	83.13	-34.97	118.1	71.56	32.09	6.37	26.89	196	29	P	V
	*	5775	106.56	-	-	94.85	32.26	6.39	26.94	196	29	P	V
	*	5775	97.49	-	-	85.78	32.26	6.39	26.94	196	29	A	V
		5851.2	74.82	-44.64	119.46	62.98	32.4	6.44	27	196	29	P	V
		5859	72.2	-37.48	109.68	60.32	32.44	6.45	27.01	196	29	P	V
		5877.2	65.06	-38.51	103.57	53.11	32.51	6.46	27.02	196	29	P	V
		5932	55.59	-12.61	68.2	43.49	32.66	6.51	27.07	196	29	P	V
													V
													V
Remark	1. No other spurious found. 2. All results are PASS against Peak and Average limit line.												



<TXBF Mode>

Band 4 - 5725~5850MHz

WIFI 802.11ac VHT20 (Band Edge @ 3m)

WIFI	Note	Frequency	Level	Over	Limit	Read	Antenna	Path	Preamp	Ant	Table	Peak	Pol.	
Ant.				Limit	Line	Level	Factor	Loss	Factor	Pos	Pos	Avg.		
1+2		(MHz)	(dBµV/m)	(dB)	(dBµV/m)	(dBµV)	(dB/m)	(dB)	(dB)	(cm)	(deg)	(P/A)	(H/V)	
802.11ac VHT20 CH 149 5745MHz		5629.8	51.4	-16.8	68.2	40.07	31.8	6.33	26.8	207	305	P	H	
		5685.8	51.87	-42.85	94.72	40.43	31.94	6.35	26.85	207	305	P	H	
		5718.6	52.12	-58.29	110.41	40.56	32.07	6.37	26.88	207	305	P	H	
		5724.6	61.84	-59.45	121.29	50.26	32.1	6.37	26.89	207	305	P	H	
	*	5745	104.54	-	-	92.9	32.16	6.38	26.9	207	305	P	H	
	*	5745	96.54	-	-	84.9	32.16	6.38	26.9	207	305	A	H	
														H
														H
			5612	52.64	-15.56	68.2	41.31	31.8	6.32	26.79	189	32	P	V
			5696.2	52.7	-49.7	102.4	41.22	31.98	6.36	26.86	189	32	P	V
			5715.8	51.48	-58.15	109.63	39.93	32.06	6.37	26.88	189	32	P	V
			5723.2	50.97	-67.13	118.1	39.4	32.09	6.37	26.89	189	32	P	V
	*		5745	101.75	-	-	90.08	32.2	6.38	26.91	189	32	P	V
	*		5745	93.01	-	-	81.34	32.2	6.38	26.91	189	32	A	V
													V	
													V	



WIFI Ant. 1+2	Note	Frequency (MHz)	Level (dBμV/m)	Over Limit (dB)	Limit Line (dBμV/m)	Read Level (dBμV)	Antenna Factor (dB/m)	Path Loss (dB)	Preamp Factor (dB)	Ant Pos (cm)	Table Pos (deg)	Peak Avg. (P/A)	Pol. (H/V)
		5618	52.16	-16.04	68.2	40.82	31.8	6.33	26.79	214	308	P	H
		5671	52.14	-31.64	83.78	40.75	31.88	6.35	26.84	214	308	P	H
		5712.8	51.26	-57.53	108.79	39.72	32.05	6.37	26.88	214	308	P	H
		5722.6	50.24	-66.49	116.73	38.67	32.09	6.37	26.89	214	308	P	H
	*	5785	104.6	-	-	92.89	32.26	6.39	26.94	214	308	P	H
	*	5785	95.87	-	-	84.16	32.26	6.39	26.94	214	308	A	H
		5852	51.42	-66.22	117.64	39.57	32.41	6.44	27	214	308	P	H
		5864.8	51.11	-56.94	108.05	39.21	32.46	6.45	27.01	214	308	P	H
		5910.8	52.54	-26.14	78.68	40.48	32.62	6.49	27.05	214	308	P	H
		5939.6	51.71	-16.49	68.2	39.6	32.68	6.51	27.08	214	308	P	H
802.11ac													H
VHT20													H
CH 157		5619	52.04	-16.16	68.2	40.7	31.8	6.33	26.79	189	32	P	V
5785MHz		5665.6	52.22	-27.56	79.78	40.85	31.86	6.35	26.84	189	32	P	V
		5701.2	52.42	-53.12	105.54	40.93	32	6.36	26.87	189	32	P	V
		5720	50.06	-60.74	110.8	38.49	32.08	6.37	26.88	189	32	P	V
	*	5785	101.5	-	-	89.79	32.26	6.39	26.94	189	32	P	V
	*	5785	92.49	-	-	80.78	32.26	6.39	26.94	189	32	A	V
		5853	51.46	-63.9	115.36	39.61	32.41	6.44	27	189	32	P	V
		5869.4	51.71	-55.06	106.77	39.79	32.48	6.46	27.02	189	32	P	V
		5875.4	52.18	-52.72	104.9	40.24	32.5	6.46	27.02	189	32	P	V
		5925.2	51.6	-16.6	68.2	39.51	32.65	6.5	27.06	189	32	P	V
													V
													V



WiFi Ant.	Note	Frequency	Level	Over Limit	Limit Line	Read Level	Antenna Factor	Path Loss	Preamp Factor	Ant Pos	Table Pos	Peak Avg.	Pol.	
1+2		(MHz)	(dBμV/m)	(dB)	(dBμV/m)	(dBμV)	(dB/m)	(dB)	(dB)	(cm)	(deg)	(P/A)	(H/V)	
802.11ac VHT20 CH 165 5825MHz	*	5825	105.33	-	-	93.54	32.35	6.42	26.98	275	318	P	H	
	*	5825	97.8	-	-	86.01	32.35	6.42	26.98	275	318	A	H	
		5850.8	54.47	-65.91	120.38	42.63	32.4	6.44	27	275	318	P	H	
		5855.8	53.15	-57.43	110.58	41.29	32.42	6.44	27	275	318	P	H	
		5876	52.88	-51.58	104.46	40.94	32.5	6.46	27.02	275	318	P	H	
		5939.2	52.65	-15.55	68.2	40.54	32.68	6.51	27.08	275	318	P	H	
														H
														H
	*	5825	99.75	-	-	87.96	32.35	6.42	26.98	100	33	P	V	
	*	5825	91.2	-	-	79.41	32.35	6.42	26.98	100	33	A	V	
		5850	53.04	-69.16	122.2	41.2	32.4	6.44	27	100	33	P	V	
		5867.6	53.35	-53.92	107.27	41.44	32.47	6.45	27.01	100	33	P	V	
		5882.8	53.87	-45.54	99.41	41.9	32.53	6.47	27.03	100	33	P	V	
		5926.2	52.11	-16.09	68.2	40.03	32.65	6.5	27.07	100	33	P	V	
														V
													V	
Remark	1. No other spurious found. 2. All results are PASS against Peak and Average limit line.													



Band 4 5725~5850MHz
WIFI 802.11ac VHT20 (Harmonic @ 3m)

WIFI Ant.	Note	Frequency	Level	Over Limit	Limit Line	Read Level	Antenna Factor	Path Loss	Preamp Factor	Ant Pos	Table Pos	Peak Avg.	Pol.
1+2		(MHz)	(dBµV/m)	(dB)	(dBµV/m)	(dBµV)	(dB/m)	(dB)	(dB)	(cm)	(deg)	(P/A)	(H/V)
802.11ac VHT20 CH 149 5745MHz		11490	45.54	-28.46	74	51.48	39.9	10.46	56.3	100	0	P	H
		17235	46.98	-21.22	68.2	50.66	39.94	12.95	56.57	100	0	P	H
													H
													H
		11490	45.81	-28.19	74	51.75	39.9	10.46	56.3	100	0	P	V
		17235	47.32	-20.88	68.2	51	39.94	12.95	56.57	100	0	P	V
802.11ac VHT20 CH 157 5785MHz		11570	45.36	-28.64	74	51.33	39.83	10.5	56.3	100	0	P	H
		17355	46.97	-21.23	68.2	50.37	40.33	13.08	56.81	100	0	P	H
													H
													H
		11570	45.64	-28.36	74	51.61	39.83	10.5	56.3	100	0	P	V
		17355	47.39	-20.81	68.2	50.79	40.33	13.08	56.81	100	0	P	V
802.11ac VHT20 CH 165 5825MHz		11650	46.92	-27.08	74	53.13	39.55	10.54	56.3	100	0	P	H
		17475	48.89	-19.31	68.2	51.9	40.83	13.21	57.05	100	0	P	H
													H
													H
		11650	46.34	-27.66	74	52.55	39.55	10.54	56.3	100	0	P	V
		17475	48.74	-19.46	68.2	51.75	40.83	13.21	57.05	100	0	P	V
Remark	1. No other spurious found.												
	2. All results are PASS against Peak and Average limit line.												



Band 4 5725~5850MHz
WIFI 802.11ac VHT40 (Band Edge @ 3m)

WIFI Ant.	Note	Frequency	Level	Over Limit	Limit Line	Read Level	Antenna Factor	Path Loss	Preamp Factor	Ant Pos	Table Pos	Peak Avg.	Pol.
1+2		(MHz)	(dBμV/m)	(dB)	(dBμV/m)	(dBμV)	(dB/m)	(dB)	(dB)	(cm)	(deg)	(P/A)	(H/V)
		5614.6	51.35	-16.85	68.2	40.01	31.8	6.33	26.79	271	312	P	H
		5688.2	53	-43.5	96.5	41.55	31.95	6.36	26.86	271	312	P	H
		5712.8	59.02	-49.77	108.79	47.48	32.05	6.37	26.88	271	312	P	H
		5722.8	59.45	-57.73	117.18	47.88	32.09	6.37	26.89	271	312	P	H
	*	5755	102.5	-	-	90.83	32.2	6.38	26.91	271	312	P	H
	*	5755	92.83	-	-	81.16	32.2	6.38	26.91	271	312	A	H
		5853.4	51.09	-63.36	114.45	39.24	32.41	6.44	27	271	312	P	H
		5858.4	52.11	-57.74	109.85	40.24	32.43	6.45	27.01	271	312	P	H
		5910.4	51.99	-26.98	78.97	39.93	32.62	6.49	27.05	271	312	P	H
		5930.4	51.06	-17.14	68.2	38.97	32.66	6.5	27.07	271	312	P	H
802.11ac													H
VHT40													H
CH 151		5626	51.58	-16.62	68.2	40.25	31.8	6.33	26.8	207	34	P	V
5755MHz		5681.4	51.61	-39.86	91.47	40.18	31.93	6.35	26.85	207	34	P	V
		5717.6	53.76	-56.37	110.13	42.2	32.07	6.37	26.88	207	34	P	V
		5724.8	54.78	-66.96	121.74	43.2	32.1	6.37	26.89	207	34	P	V
	*	5755	98.57	-	-	86.93	32.16	6.38	26.9	207	34	P	V
	*	5755	89.28	-	-	77.64	32.16	6.38	26.9	207	34	A	V
		5850.6	50.65	-70.18	120.83	38.81	32.4	6.44	27	207	34	P	V
		5863	52.64	-55.92	108.56	40.75	32.45	6.45	27.01	207	34	P	V
		5889.8	53.27	-40.95	94.22	41.27	32.56	6.47	27.03	207	34	P	V
		5936.8	50.71	-17.49	68.2	38.6	32.67	6.51	27.07	207	34	P	V
													V
													V



WIFI Ant. 1+2	Note	Frequency (MHz)	Level (dBμV/m)	Over Limit (dB)	Limit Line (dBμV/m)	Read Level (dBμV)	Antenna Factor (dB/m)	Path Loss (dB)	Preamp Factor (dB)	Ant Pos (cm)	Table Pos (deg)	Peak Avg. (P/A)	Pol. (H/V)
		5610.2	51.99	-16.21	68.2	40.66	31.8	6.32	26.79	200	304	P	H
		5693.2	51.83	-48.36	100.19	40.36	31.97	6.36	26.86	200	304	P	H
		5715.8	52.38	-57.25	109.63	40.83	32.06	6.37	26.88	200	304	P	H
		5722.2	51.47	-64.35	115.82	39.9	32.09	6.37	26.89	200	304	P	H
	*	5795	103.21	-	-	91.5	32.26	6.39	26.94	200	304	P	H
	*	5795	91.24	-	-	79.53	32.26	6.39	26.94	200	304	A	H
		5851.2	50.86	-68.6	119.46	39.02	32.4	6.44	27	200	304	P	H
		5856.6	52.02	-58.33	110.35	40.14	32.43	6.45	27	200	304	P	H
		5887.6	51.78	-44.07	95.85	39.79	32.55	6.47	27.03	200	304	P	H
		5925	51.08	-17.12	68.2	38.99	32.65	6.5	27.06	200	304	P	H
802.11ac													H
VHT40													H
CH 159		5607.6	51.32	-16.88	68.2	39.98	31.8	6.32	26.78	188	34	P	V
5795MHz		5670.8	52.82	-30.81	83.63	41.43	31.88	6.35	26.84	188	34	P	V
		5716.2	50.78	-58.96	109.74	39.23	32.06	6.37	26.88	188	34	P	V
		5720.2	50.23	-61.03	111.26	38.66	32.08	6.37	26.88	188	34	P	V
	*	5795	99.39	-	-	87.65	32.28	6.4	26.94	188	34	P	V
	*	5795	88.47	-	-	76.73	32.28	6.4	26.94	188	34	A	V
		5850.8	51.64	-68.74	120.38	39.8	32.4	6.44	27	188	34	P	V
		5858.6	51.58	-58.21	109.79	39.71	32.43	6.45	27.01	188	34	P	V
		5877	51.79	-51.92	103.71	39.84	32.51	6.46	27.02	188	34	P	V
		5932.8	52.83	-15.37	68.2	40.72	32.67	6.51	27.07	188	34	P	V
													V
													V
Remark	1. No other spurious found. 2. All results are PASS against Peak and Average limit line.												



Band 4 5725~5850MHz
WIFI 802.11ac VHT40 (Harmonic @ 3m)

WIFI Ant.	Note	Frequency	Level	Over Limit	Limit Line	Read Level	Antenna Factor	Path Loss	Preamp Factor	Ant Pos	Table Pos	Peak Avg.	Pol.
1+2		(MHz)	(dBμV/m)	(dB)	(dBμV/m)	(dBμV)	(dB/m)	(dB)	(dB)	(cm)	(deg)	(P/A)	(H/V)
802.11ac VHT40 CH 151 5755MHz		11510	47.03	-26.97	74	52.97	39.89	10.47	56.3	100	0	P	H
		17265	48.11	-20.09	68.2	51.79	39.97	12.98	56.63	100	0	P	H
													H
													H
802.11ac VHT40 CH 159 5795MHz		11510	47.25	-26.75	74	53.19	39.89	10.47	56.3	100	0	P	V
		17265	47.52	-20.68	68.2	51.2	39.97	12.98	56.63	100	0	P	V
													V
													V
802.11ac VHT40 CH 159 5795MHz		11590	47.28	-26.72	74	53.26	39.81	10.51	56.3	100	0	P	H
		17385	48.74	-19.46	68.2	51.99	40.51	13.11	56.87	100	0	P	H
													H
													H
802.11ac VHT40 CH 159 5795MHz		11590	47.23	-26.77	74	53.21	39.81	10.51	56.3	100	0	P	V
		17385	49.11	-19.09	68.2	52.36	40.51	13.11	56.87	100	0	P	V
													V
													V
Remark	1. No other spurious found. 2. All results are PASS against Peak and Average limit line.												



Band 4 5725~5850MHz
WIFI 802.11ac VHT80 (Band Edge @ 3m)

WIFI Ant.	Note	Frequency	Level	Over Limit	Limit Line	Read Level	Antenna Factor	Path Loss	Preamp Factor	Ant Pos	Table Pos	Peak Avg.	Pol.
1+2		(MHz)	(dBμV/m)	(dB)	(dBμV/m)	(dBμV)	(dB/m)	(dB)	(dB)	(cm)	(deg)	(P/A)	(H/V)
		5639.4	51.68	-16.52	68.2	40.35	31.8	6.34	26.81	187	307	P	H
		5693	52.63	-47.41	100.04	41.16	31.97	6.36	26.86	187	307	P	H
		5718	55.74	-54.5	110.24	44.18	32.07	6.37	26.88	187	307	P	H
		5724.6	64.05	-57.24	121.29	52.47	32.1	6.37	26.89	187	307	P	H
	*	5775	105.01	-	-	93.36	32.18	6.38	26.91	187	307	P	H
	*	5775	89.75	-	-	78.1	32.18	6.38	26.91	187	307	A	H
		5852.4	53.49	-63.24	116.73	41.64	32.41	6.44	27	187	307	P	H
		5859.6	52.21	-57.3	109.51	40.33	32.44	6.45	27.01	187	307	P	H
		5878.4	52.09	-50.58	102.67	40.14	32.51	6.46	27.02	187	307	P	H
		5935	51.88	-16.32	68.2	39.77	32.67	6.51	27.07	187	307	P	H
802.11ac													H
VHT80													H
CH 155		5605	51.78	-16.42	68.2	40.44	31.8	6.32	26.78	207	34	P	V
5775MHz		5689.2	54.87	-42.37	97.24	43.41	31.96	6.36	26.86	207	34	P	V
		5702.4	56.31	-49.56	105.87	44.81	32.01	6.36	26.87	207	34	P	V
		5722.8	59.88	-57.3	117.18	48.31	32.09	6.37	26.89	207	34	P	V
	*	5775	95.84	-	-	84.13	32.26	6.39	26.94	207	34	P	V
	*	5775	88.39	-	-	76.68	32.26	6.39	26.94	207	34	A	V
		5854.2	53.71	-58.91	112.62	41.85	32.42	6.44	27	207	34	P	V
		5859.6	53.9	-55.61	109.51	42.02	32.44	6.45	27.01	207	34	P	V
		5880.4	53.32	-47.87	101.19	41.36	32.52	6.46	27.02	207	34	P	V
		5930.4	51.66	-16.54	68.2	39.57	32.66	6.5	27.07	207	34	P	V
													V
													V
Remark	1. No other spurious found. 2. All results are PASS against Peak and Average limit line.												



**Band 4 5725~5850MHz
WIFI 802.11ac VHT80 (Harmonic @ 3m)**

WIFI Ant.	Note	Frequency	Level	Over Limit	Limit Line	Read Level	Antenna Factor	Path Loss	Preamp Factor	Ant Pos	Table Pos	Peak Avg.	Pol.
1+2		(MHz)	(dBμV/m)	(dB)	(dBμV/m)	(dBμV)	(dB/m)	(dB)	(dB)	(cm)	(deg)	(P/A)	(H/V)
802.11ac VHT80 CH 155 5775MHz		11550	45.96	-28.04	74	51.92	39.85	10.49	56.3	100	0	P	H
		17325	47.99	-20.21	68.2	51.55	40.15	13.04	56.75	100	0	P	H
													H
													H
		11550	46.47	-27.53	74	52.43	39.85	10.49	56.3	100	0	P	V
		17325	48.74	-19.46	68.2	52.3	40.15	13.04	56.75	100	0	P	V
													V
													V
Remark	1. No other spurious found. 2. All results are PASS against Peak and Average limit line.												



Band 4 - 5725~5850MHz

WIFI 802.11ax HE20 (Band Edge @ 3m)

WIFI	Note	Frequency	Level	Over	Limit	Read	Antenna	Path	Preamp	Ant	Table	Peak	Pol.	
Ant.				Limit	Line	Level	Factor	Loss	Factor	Pos	Pos	Avg.		
1+2		(MHz)	(dBμV/m)	(dB)	(dBμV/m)	(dBμV)	(dB/m)	(dB)	(dB)	(cm)	(deg)	(P/A)	(H/V)	
802.11ax HE20 CH 149 5745MHz		5647.6	51.24	-16.96	68.2	39.92	31.8	6.34	26.82	184	319	P	H	
		5653.4	51.6	-19.13	70.73	40.27	31.81	6.34	26.82	184	319	P	H	
		5715	51.35	-58.05	109.4	39.8	32.06	6.37	26.88	184	319	P	H	
		5722.4	53.91	-62.36	116.27	42.34	32.09	6.37	26.89	184	319	P	H	
	*	5745	103.63	-	-	91.98	32.18	6.38	26.91	184	319	P	H	
	*	5745	97.82	-	-	86.17	32.18	6.38	26.91	184	319	A	H	
														H
														H
			5603.8	50.93	-17.27	68.2	39.59	31.8	6.32	26.78	253	330	P	V
			5684.4	52.49	-41.2	93.69	41.05	31.94	6.35	26.85	253	330	P	V
			5719.4	52.99	-57.64	110.63	41.42	32.08	6.37	26.88	253	330	P	V
			5720.2	55.19	-56.07	111.26	43.62	32.08	6.37	26.88	253	330	P	V
	*		5745	101.92	-	-	90.27	32.18	6.38	26.91	253	330	P	V
	*		5745	93.59	-	-	81.94	32.18	6.38	26.91	253	330	A	V
														V
													V	



WiFi Ant.	Note	Frequency	Level	Over Limit	Limit Line	Read Level	Antenna Factor	Path Loss	Preamp Factor	Ant Pos	Table Pos	Peak Avg.	Pol.
1+2		(MHz)	(dBμV/m)	(dB)	(dBμV/m)	(dBμV)	(dB/m)	(dB)	(dB)	(cm)	(deg)	(P/A)	(H/V)
		5608.8	52.27	-15.93	68.2	40.94	31.8	6.32	26.79	205	300	P	H
		5655.4	52.42	-19.79	72.21	41.09	31.82	6.34	26.83	205	300	P	H
		5718.6	52.4	-58.01	110.41	40.84	32.07	6.37	26.88	205	300	P	H
		5721.2	51.02	-62.52	113.54	39.45	32.08	6.37	26.88	205	300	P	H
	*	5785	106.67	-	-	94.95	32.27	6.39	26.94	205	300	P	H
	*	5785	98.14	-	-	86.42	32.27	6.39	26.94	205	300	A	H
		5851	51.59	-68.33	119.92	39.75	32.4	6.44	27	205	300	P	H
		5860.4	51.81	-57.48	109.29	39.93	32.44	6.45	27.01	205	300	P	H
		5917	52.3	-21.8	74.1	40.24	32.63	6.49	27.06	205	300	P	H
		5947.4	52.06	-16.14	68.2	39.93	32.69	6.52	27.08	205	300	P	H
802.11ax													H
HE20													H
CH 157		5609	52.39	-15.81	68.2	41.06	31.8	6.32	26.79	165	30	P	V
5785MHz		5659.8	51.05	-24.43	75.48	39.7	31.84	6.34	26.83	165	30	P	V
		5719.8	51.16	-59.58	110.74	39.59	32.08	6.37	26.88	165	30	P	V
		5720	50.61	-60.19	110.8	39.04	32.08	6.37	26.88	165	30	P	V
	*	5785	104.31	-	-	92.59	32.27	6.39	26.94	165	30	P	V
	*	5785	96.36	-	-	84.64	32.27	6.39	26.94	165	30	A	V
		5852.4	50.9	-65.83	116.73	39.05	32.41	6.44	27	165	30	P	V
		5863.4	50.9	-57.55	108.45	39.01	32.45	6.45	27.01	165	30	P	V
		5876.6	51.95	-52.06	104.01	40	32.51	6.46	27.02	165	30	P	V
		5949.8	52.09	-16.11	68.2	39.96	32.7	6.52	27.09	165	30	P	V
													V
													V



WiFi Ant.	Note	Frequency	Level	Over Limit	Limit Line	Read Level	Antenna Factor	Path Loss	Preamp Factor	Ant Pos	Table Pos	Peak Avg.	Pol.	
1+2		(MHz)	(dBμV/m)	(dB)	(dBμV/m)	(dBμV)	(dB/m)	(dB)	(dB)	(cm)	(deg)	(P/A)	(H/V)	
802.11ax HE20 CH 165 5825MHz	*	5825	104.52	-	-	92.73	32.35	6.42	26.98	190	315	P	H	
	*	5825	96.14	-	-	84.35	32.35	6.42	26.98	190	315	A	H	
		5850.6	58.72	-62.11	120.83	46.88	32.4	6.44	27	190	315	P	H	
		5861.8	52.99	-55.9	108.89	41.1	32.45	6.45	27.01	190	315	P	H	
		5877.4	53.06	-50.36	103.42	41.11	32.51	6.46	27.02	190	315	P	H	
		5926	52.21	-15.99	68.2	40.12	32.65	6.5	27.06	190	315	P	H	
														H
														H
	*	5825	100.99	-	-	89.2	32.35	6.42	26.98	210	28	P	V	
	*	5825	93.84	-	-	82.05	32.35	6.42	26.98	210	28	A	V	
		5852	51.03	-66.61	117.64	39.18	32.41	6.44	27	210	28	P	V	
		5868	52.97	-54.19	107.16	41.06	32.47	6.45	27.01	210	28	P	V	
		5893	51.81	-40.03	91.84	39.81	32.57	6.47	27.04	210	28	P	V	
		5949.8	51.36	-16.84	68.2	39.23	32.7	6.52	27.09	210	28	P	V	
														V
													V	
Remark	1. No other spurious found. 2. All results are PASS against Peak and Average limit line.													



Band 4 5725~5850MHz
WIFI 802.11ax HE20 (Harmonic @ 3m)

WIFI Ant.	Note	Frequency	Level	Over Limit	Limit Line	Read Level	Antenna Factor	Path Loss	Preamp Factor	Ant Pos	Table Pos	Peak Avg.	Pol.
1+2		(MHz)	(dBμV/m)	(dB)	(dBμV/m)	(dBμV)	(dB/m)	(dB)	(dB)	(cm)	(deg)	(P/A)	(H/V)
802.11ax HE20 CH 149 5745MHz		11490	47.24	-26.76	74	53.18	39.9	10.46	56.3	100	0	P	H
		17235	47.31	-20.89	68.2	50.99	39.94	12.95	56.57	100	0	P	H
													H
													H
		11490	47.16	-26.84	74	53.1	39.9	10.46	56.3	100	0	P	V
		17235	47.23	-20.97	68.2	50.91	39.94	12.95	56.57	100	0	P	V
802.11ax HE20 CH 157 5785MHz		11570	46.37	-27.63	74	52.34	39.83	10.5	56.3	100	0	P	H
		17355	47.29	-20.91	68.2	50.69	40.33	13.08	56.81	100	0	P	H
													H
													H
		11570	47.67	-26.33	74	53.64	39.83	10.5	56.3	100	0	P	V
		17355	47.6	-20.6	68.2	51	40.33	13.08	56.81	100	0	P	V
802.11ax HE20 CH 165 5825MHz		11650	46.81	-27.19	74	53.02	39.55	10.54	56.3	100	0	P	H
		17475	47.44	-20.76	68.2	50.45	40.83	13.21	57.05	100	0	P	H
													H
													H
		11650	46.7	-27.3	74	52.91	39.55	10.54	56.3	100	0	P	V
		17475	48.12	-20.08	68.2	51.13	40.83	13.21	57.05	100	0	P	V
Remark	1. No other spurious found.												
	2. All results are PASS against Peak and Average limit line.												



Band 4 5725~5850MHz
WIFI 802.11ax HE40 (Band Edge @ 3m)

WIFI Ant.	Note	Frequency	Level	Over Limit	Limit Line	Read Level	Antenna Factor	Path Loss	Preamp Factor	Ant Pos	Table Pos	Peak Avg.	Pol.
1+2		(MHz)	(dBμV/m)	(dB)	(dBμV/m)	(dBμV)	(dB/m)	(dB)	(dB)	(cm)	(deg)	(P/A)	(H/V)
		5600	51.5	-16.7	68.2	40.16	31.8	6.32	26.78	210	322	P	H
		5697.4	52.08	-51.2	103.28	40.59	31.99	6.36	26.86	210	322	P	H
		5719	61.63	-48.89	110.52	50.06	32.08	6.37	26.88	210	322	P	H
		5723.2	63.22	-54.88	118.1	51.65	32.09	6.37	26.89	210	322	P	H
	*	5755	102.32	-	-	90.64	32.21	6.38	26.91	210	322	P	H
	*	5755	93.03	-	-	81.35	32.21	6.38	26.91	210	322	A	H
		5850.4	50	-71.29	121.29	38.16	32.4	6.44	27	210	322	P	H
		5866.8	51.03	-56.46	107.49	39.12	32.47	6.45	27.01	210	322	P	H
		5914.2	51.22	-24.95	76.17	39.15	32.63	6.49	27.05	210	322	P	H
		5925.8	51.66	-16.54	68.2	39.57	32.65	6.5	27.06	210	322	P	H
802.11ax													H
HE40													H
CH 151		5610	52.31	-15.89	68.2	40.98	31.8	6.32	26.79	184	31	P	V
5755MHz		5691.8	51.9	-47.25	99.15	40.43	31.97	6.36	26.86	184	31	P	V
		5715.4	52.27	-57.24	109.51	40.72	32.06	6.37	26.88	184	31	P	V
		5724.8	54.63	-67.11	121.74	43.05	32.1	6.37	26.89	184	31	P	V
	*	5755	98.87	-	-	87.19	32.21	6.38	26.91	184	31	P	V
	*	5755	90.19	-	-	78.51	32.21	6.38	26.91	184	31	A	V
		5850.2	49.65	-72.09	121.74	37.81	32.4	6.44	27	184	31	P	V
		5856.8	51.02	-59.28	110.3	39.14	32.43	6.45	27	184	31	P	V
		5896.4	52.33	-37	89.33	40.3	32.59	6.48	27.04	184	31	P	V
		5949.4	51.43	-16.77	68.2	39.3	32.7	6.52	27.09	184	31	P	V
													V
													V



WIFI Ant. 1+2	Note	Frequency (MHz)	Level (dBμV/m)	Over Limit (dB)	Limit Line (dBμV/m)	Read Level (dBμV)	Antenna Factor (dB/m)	Path Loss (dB)	Preamp Factor (dB)	Ant Pos (cm)	Table Pos (deg)	Peak Avg. (P/A)	Pol. (H/V)
		5644.4	52.5	-15.7	68.2	41.18	31.8	6.34	26.82	188	311	P	H
		5657.4	52.41	-21.29	73.7	41.07	31.83	6.34	26.83	188	311	P	H
		5718.2	51.89	-58.41	110.3	40.33	32.07	6.37	26.88	188	311	P	H
		5723.6	51.54	-67.47	119.01	39.97	32.09	6.37	26.89	188	311	P	H
	*	5795	103.04	-	-	91.3	32.29	6.4	26.95	188	311	P	H
	*	5795	92.28	-	-	80.54	32.29	6.4	26.95	188	311	A	H
		5853.6	51.62	-62.37	113.99	39.77	32.41	6.44	27	188	311	P	H
		5872.4	52.34	-53.59	105.93	40.41	32.49	6.46	27.02	188	311	P	H
		5899.2	51.76	-35.49	87.25	39.72	32.6	6.48	27.04	188	311	P	H
		5949.2	51.44	-16.76	68.2	39.31	32.7	6.52	27.09	188	311	P	H
802.11ax													H
HE40													H
CH 159		5638.4	51.68	-16.52	68.2	40.35	31.8	6.34	26.81	180	30	P	V
5795MHz		5696.6	51.63	-51.06	102.69	40.14	31.99	6.36	26.86	180	30	P	V
		5717.8	52.03	-58.15	110.18	40.47	32.07	6.37	26.88	180	30	P	V
		5724	50.55	-69.37	119.92	38.97	32.1	6.37	26.89	180	30	P	V
	*	5795	99.25	-	-	87.51	32.29	6.4	26.95	180	30	P	V
	*	5795	89.59	-	-	77.85	32.29	6.4	26.95	180	30	A	V
		5855	50.57	-60.23	110.8	38.71	32.42	6.44	27	180	30	P	V
		5865	51.77	-56.23	108	39.87	32.46	6.45	27.01	180	30	P	V
		5912.4	51.99	-25.5	77.49	39.93	32.62	6.49	27.05	180	30	P	V
		5940.4	52.2	-16	68.2	40.09	32.68	6.51	27.08	180	30	P	V
													V
													V
Remark	1. No other spurious found. 2. All results are PASS against Peak and Average limit line.												



**Band 4 5725~5850MHz
WIFI 802.11ax HE40 (Harmonic @ 3m)**

WIFI Ant.	Note	Frequency	Level	Over Limit	Limit Line	Read Level	Antenna Factor	Path Loss	Preamp Factor	Ant Pos	Table Pos	Peak Avg.	Pol.
1+2		(MHz)	(dBμV/m)	(dB)	(dBμV/m)	(dBμV)	(dB/m)	(dB)	(dB)	(cm)	(deg)	(P/A)	(H/V)
802.11ax HE40 CH 151 5755MHz		11510	47.72	-26.28	74	53.66	39.89	10.47	56.3	100	0	P	H
		17265	46.46	-21.74	68.2	50.14	39.97	12.98	56.63	100	0	P	H
													H
													H
		11510	46.96	-27.04	74	52.9	39.89	10.47	56.3	100	0	P	V
		17265	46.75	-21.45	68.2	50.43	39.97	12.98	56.63	100	0	P	V
													V
													V
802.11ax HE40 CH 159 5795MHz		11590	46.37	-27.63	74	52.35	39.81	10.51	56.3	100	0	P	H
		17385	47.95	-20.25	68.2	51.2	40.51	13.11	56.87	100	0	P	H
													H
													H
		11590	47.04	-26.96	74	53.02	39.81	10.51	56.3	100	0	P	V
		17385	47.64	-20.56	68.2	50.89	40.51	13.11	56.87	100	0	P	V
													V
													V
Remark	1. No other spurious found. 2. All results are PASS against Peak and Average limit line.												



Band 4 5725~5850MHz
WIFI 802.11ax HE80 (Band Edge @ 3m)

WIFI Ant.	Note	Frequency	Level	Over Limit	Limit Line	Read Level	Antenna Factor	Path Loss	Preamp Factor	Ant Pos	Table Pos	Peak Avg.	Pol.
1+2		(MHz)	(dBμV/m)	(dB)	(dBμV/m)	(dBμV)	(dB/m)	(dB)	(dB)	(cm)	(deg)	(P/A)	(H/V)
		5639	52.84	-15.36	68.2	41.51	31.8	6.34	26.81	205	313	P	H
		5698.4	56.72	-47.3	104.02	45.23	31.99	6.36	26.86	205	313	P	H
		5719.8	60.18	-50.56	110.74	48.61	32.08	6.37	26.88	205	313	P	H
		5723.8	63.3	-56.16	119.46	51.72	32.1	6.37	26.89	205	313	P	H
	*	5775	100.47	-	-	88.76	32.25	6.39	26.93	205	313	P	H
	*	5775	91.02	-	-	79.31	32.25	6.39	26.93	205	313	A	H
		5851	56.55	-63.37	119.92	44.71	32.4	6.44	27	205	313	P	H
		5859	56.92	-52.76	109.68	45.04	32.44	6.45	27.01	205	313	P	H
		5903.2	53.03	-31.26	84.29	40.98	32.61	6.48	27.04	205	313	P	H
		5943.2	52.57	-15.63	68.2	40.45	32.69	6.51	27.08	205	313	P	H
802.11ax													H
HE80													H
CH 155		5634.8	51.65	-16.55	68.2	40.33	31.8	6.33	26.81	191	33	P	V
5775MHz		5673.2	54.35	-31.06	85.41	42.95	31.89	6.35	26.84	191	33	P	V
		5709.8	56.05	-51.9	107.95	44.52	32.04	6.36	26.87	191	33	P	V
		5724.6	60.79	-60.5	121.29	49.21	32.1	6.37	26.89	191	33	P	V
	*	5775	98.06	-	-	86.35	32.25	6.39	26.93	191	33	P	V
	*	5775	87.76	-	-	76.05	32.25	6.39	26.93	191	33	A	V
		5852	54.01	-63.63	117.64	42.16	32.41	6.44	27	191	33	P	V
		5868.2	54.07	-53.03	107.1	42.16	32.47	6.45	27.01	191	33	P	V
		5907.6	53.28	-27.76	81.04	41.22	32.62	6.49	27.05	191	33	P	V
		5927.8	52.55	-15.65	68.2	40.46	32.66	6.5	27.07	191	33	P	V
													V
													V
Remark	1. No other spurious found. 2. All results are PASS against Peak and Average limit line.												



**Band 4 5725~5850MHz
WIFI 802.11ax HE80 (Harmonic @ 3m)**

WIFI Ant.	Note	Frequency	Level	Over Limit	Limit Line	Read Level	Antenna Factor	Path Loss	Preamp Factor	Ant Pos	Table Pos	Peak Avg.	Pol.
1+2		(MHz)	(dBμV/m)	(dB)	(dBμV/m)	(dBμV)	(dB/m)	(dB)	(dB)	(cm)	(deg)	(P/A)	(H/V)
802.11ax HE80 CH 155 5775MHz		11550	46.83	-27.17	74	52.79	39.85	10.49	56.3	100	0	P	H
		17325	47.18	-21.02	68.2	50.74	40.15	13.04	56.75	100	0	P	H
													H
													H
		11550	46.87	-27.13	74	52.83	39.85	10.49	56.3	100	0	P	V
		17325	47.25	-20.95	68.2	50.81	40.15	13.04	56.75	100	0	P	V
													V
													V
Remark	1. No other spurious found. 2. All results are PASS against Peak and Average limit line.												



Emission below 1GHz

5GHz WIFI 802.11ax HE80 (LF @ 3m)

WIFI	Note	Frequency	Level	Over	Limit	Read	Antenna	Path	Preamp	Ant	Table	Peak	Pol.	
Ant.				Limit	Line	Level	Factor	Loss	Factor	Pos	Pos	Avg.		
1+2		(MHz)	(dBμV/m)	(dB)	(dBμV/m)	(dBμV)	(dB/m)	(dB)	(dB)	(cm)	(deg)	(P/A)	(H/V)	
5GHz 802.11ax HE80 LF		167.74	33.97	-9.53	43.5	49.61	15.5	1.11	32.25	-	-	P	H	
		199.75	36.89	-6.61	43.5	53.36	14.6	1.24	32.31	100	0	P	H	
		233.7	38.76	-7.24	46	53.41	16.24	1.31	32.2	-	-	P	H	
		266.68	35.89	-10.11	46	47.31	19.3	1.38	32.1	-	-	P	H	
		600.36	36.41	-9.59	46	41.37	25.21	2.12	32.29	-	-	P	H	
		800.18	36.95	-9.05	46	38.97	27.5	2.43	31.95	-	-	P	H	
														H
														H
														H
														H
														H
														H
														H
														H
														H
			199.75	31.47	-12.03	43.5	47.94	14.6	1.24	32.31	-	-	P	V
			233.7	34.09	-11.91	46	48.74	16.24	1.31	32.2	-	-	P	V
			266.68	32.37	-13.63	46	43.79	19.3	1.38	32.1	-	-	P	V
		800.18	39.5	-6.5	46	41.52	27.5	2.43	31.95	100	0	P	V	
		836.07	33.49	-12.51	46	34.31	28.44	2.57	31.83	-	-	P	V	
		914.64	34.89	-11.11	46	34.64	29.08	2.62	31.45	-	-	P	V	
													V	
													V	
													V	
													V	
													V	
													V	
Remark	1. No other spurious found. 2. All results are PASS against limit line.													



Note symbol

*	Fundamental Frequency which can be ignored. However, the level of any unwanted emissions shall not exceed the level of the fundamental frequency.
!	Test result is over limit line.
P/A	Peak or Average
H/V	Horizontal or Vertical



A calculation example for radiated spurious emission is shown as below:

WIFI	Note	Frequency	Level	Over	Limit	Read	Antenna	Path	Preamp	Ant	Table	Peak	Pol.
Ant.				Limit	Line	Level	Factor	Loss	Factor	Pos	Pos	Avg.	
1+2		(MHz)	(dBμV/m)	(dB)	(dBμV/m)	(dBμV)	(dB/m)	(dB)	(dB)	(cm)	(deg)	(P/A)	(H/V)
802.11b		2390	55.45	-18.55	74	54.51	32.22	4.58	35.86	103	308	P	H
CH 01													
2412MHz		2390	43.54	-10.46	54	42.6	32.22	4.58	35.86	103	308	A	H

1. Path Loss(dB) = Cable loss(dB) + Filter loss(dB) + Attenuator loss(dB)
2. Level(dBμV/m) = Antenna Factor(dB/m) + Path Loss(dB) + Read Level(dBμV) - Preamp Factor(dB)
3. Over Limit(dB) = Level(dBμV/m) – Limit Line(dBμV/m)

For Peak Limit @ 2390MHz:

1. Level(dBμV/m)
= Antenna Factor(dB/m) + Path Loss(dB) + Read Level(dBμV) - Preamp Factor(dB)
= 32.22(dB/m) + 4.58(dB) + 54.51(dBμV) – 35.86 (dB)
= 55.45 (dBμV/m)
2. Over Limit(dB)
= Level(dBμV/m) – Limit Line(dBμV/m)
= 55.45(dBμV/m) – 74(dBμV/m)
= -18.55(dB)

For Average Limit @ 2390MHz:

1. Level(dBμV/m)
= Antenna Factor(dB/m) + Path Loss(dB) + Read Level(dBμV) - Preamp Factor(dB)
= 32.22(dB/m) + 4.58(dB) + 42.6(dBμV) – 35.86 (dB)
= 43.54 (dBμV/m)
2. Over Limit(dB) = Level(dBμV/m) – Limit Line(dBμV/m)
= 43.54(dBμV/m) – 54(dBμV/m)
= -10.46(dB)

Both peak and average measured complies with the limit line, so test result is “PASS”.



Appendix D. Radiated Spurious Emission Plots

Test Engineer :	Jimmy Chung · Karl Hou · Wilson Wu	Temperature :	21.5~23.5°C
		Relative Humidity :	49.5~55.5%

Note symbol

-L	Low channel location
-R	High channel location



<CDD Mode>

Band 4 - 5725~5850MHz
WIFI 802.11a (Band Edge @ 3m)

WIFI	Band 4 5725~5850MHz Band Edge @ 3m	
ANT	802.11a CH149 5745MHz	
1+2	Horizontal	Fundamental
Peak	<p>Site : 03CH13-1HY Condition : PEAK_85(B4)_16-24 3m HORN_91200_1241 HORIZONTAL Detector : Peak Project : 900635 Mode : 69 Power : 25</p>	<p>Site : 03CH13-1HY Condition : PEAK(LINE) 3m HORN_91200_1241 HORIZONTAL Detector : Peak Project : 900635 Mode : 69 Power : 25</p>

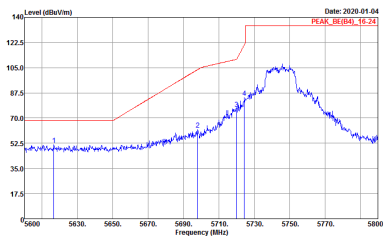
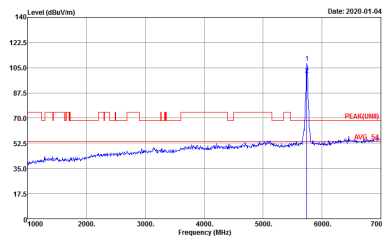

WIFI	Band 4 5725~5850MHz Band Edge @ 3m	
ANT	802.11a CH149 5745MHz	
1+2	Vertical	Fundamental
Peak	 <p>Date: 2020-01-04 PEAK_BE(B4)_16-24</p> <p>Site : 03CHE3-11Y Condition : PEAK_BE(B4)_16-24 3m HORN_91200_1241 VERTICAL RBW:1000.000KHz VBW:3000.000KHz SWT:Auto Detector : Peak Project : 900635 Mode : 69 Power : 25</p>	 <p>Date: 2020-01-04 PEAK(LINB)_16-24</p> <p>Site : 03CHE3-11Y Condition : PEAK(LINB)_16-24 3m HORN_91200_1241 VERTICAL RBW:1000.000KHz VBW:3000.000KHz SWT:Auto Detector : Peak Project : 900635 Mode : 69 Power : 25</p>



WIFI	Band 4 5725~5850MHz Band Edge @ 3m	
ANT	802.11a CH157 5785MHz	
1+2	Horizontal	Fundamental
<p>Peak</p>	<p>Site : 03CH13-HY Condition : PEAK_BE(B4)_16-24 3m HORN_91200_1241 HORIZONTAL Detector : Peak Project : 9D0635 Mode : 70 Power : 26</p>	<p>Site : 03CH13-HY Condition : PEAK(LINE1) 3m HORN_91200_1241 HORIZONTAL Detector : Peak Project : 9D0635 Mode : 70 Power : 26</p>
<p>Peak</p>	<p>Site : 03CH13-HY Condition : PEAK_BE(B4)_16-24 3m HORN_91200_1241 HORIZONTAL Detector : Peak Project : 9D0635 Mode : 70 Power : 26</p>	<p>Left blank</p>

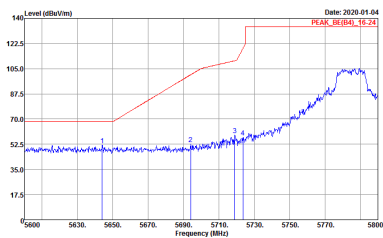
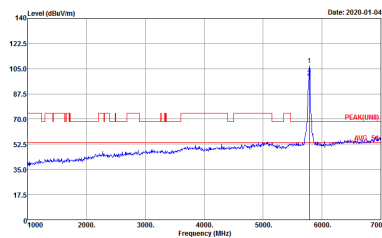
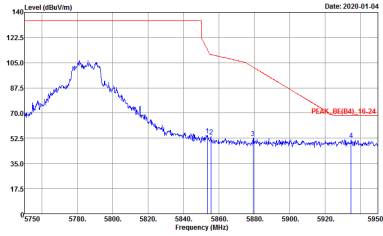

WIFI	Band 4 5725~5850MHz Band Edge @ 3m	
ANT	802.11a CH157 5785MHz	
1+2	Vertical	Fundamental
<p>Peak</p>	 <p>Site : 03CH13-HY Condition : PEAK_BE(B4)_16-24 3m HORN_91200_1241 VERTICAL RBW:1000.000KHz VBW:3000.000KHz SWT:Auto Detector : Peak Project : 9D0635 Mode : 70 Power : 26</p>	 <p>Site : 03CH13-HY Condition : PEAK(LINE1) 3m HORN_91200_1241 VERTICAL RBW:1000.000KHz VBW:3000.000KHz SWT:Auto Detector : Peak Project : 9D0635 Mode : 70 Power : 26</p>
<p>Peak</p>	 <p>Site : 03CH13-HY Condition : PEAK_BE(B4)_16-24 3m HORN_91200_1241 VERTICAL RBW:1000.000KHz VBW:3000.000KHz SWT:Auto Detector : Peak Project : 9D0635 Mode : 70 Power : 26</p>	<p>Left blank</p>



WIFI	Band 4 5725~5850MHz Band Edge @ 3m	
ANT	802.11a CH165 5825MHz	
1+2	Horizontal	Fundamental
Peak	<p>Site : 03CHE3-11Y Condition : PEAK_BE(B4)_16-24 3m HORN_91200_1241 HORIZONTAL Detector : Peak Project : 900635 Mode : 71 Power : 26</p>	<p>Site : 03CHE3-11Y Condition : PEAK(LINE) 3m HORN_91200_1241 HORIZONTAL Detector : Peak Project : 900635 Mode : 71 Power : 26</p>

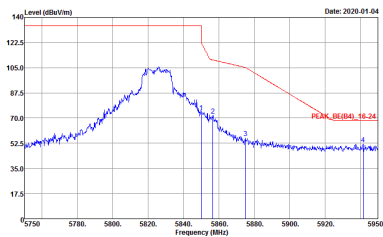
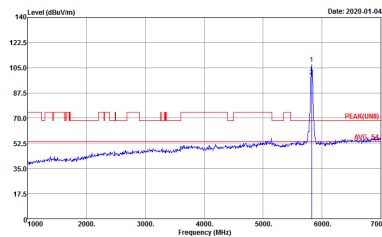

WIFI	Band 4 5725~5850MHz Band Edge @ 3m	
ANT	802.11a CH165 5825MHz	
1+2	Vertical	Fundamental
Peak	 <p>Site : 03CHE3-11Y Condition : PEAK_BE(B4)_16-24 3m HORN_91200_1241 VERTICAL : RBW:1000.000KHz VBW:3000.000KHz SWT:Auto Detector : Peak Project : 900635 Mode : 71 Power : 26</p>	 <p>Site : 03CHE3-11Y Condition : PEAK(LINE1) 3m HORN_91200_1241 VERTICAL : RBW:1000.000KHz VBW:3000.000KHz SWT:Auto Detector : Peak Project : 900635 Mode : 71 Power : 26</p>



Band 4 5725~5850MHz
WIFI 802.11ac VHT20 (Band Edge @ 3m)

WIFI	Band 4 5725~5850MHz Band Edge @ 3m	
ANT	802.11ac VHT20 CH149 5745MHz	
1+2	Horizontal	Fundamental
Peak	<p>Site : 03CH13-HY Condition : PEAK_BE(84)_16-24 3m HORN_91200_1241 HORIZONTAL Detector : Peak Project : 9D0635 Mode : F2 Power : 25</p>	<p>Site : 03CH13-HY Condition : PEAK(UNIT) 3m HORN_91200_1241 HORIZONTAL Detector : Peak Project : 9D0635 Mode : F2 Power : 25</p>

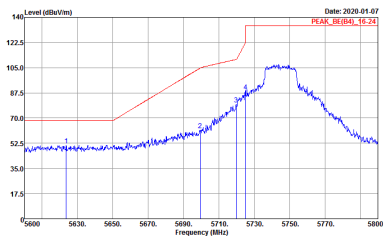
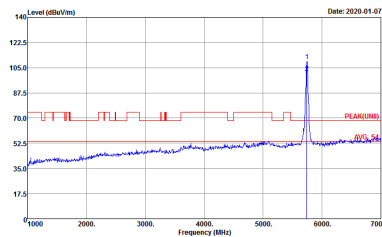

WIFI	Band 4 5725~5850MHz Band Edge @ 3m	
ANT	802.11ac VHT20 CH149 5745MHz	
1+2	Vertical	Fundamental
Peak Avg.	 <p>Site : 03CHE3-11Y Condition : PEAK_BE(B4)_16-24 3m HORN_91200_1241 VERTICAL : RBW:1000.000KHz VBW:3000.000KHz SWT:Auto Detector : Peak Project : 900635 Mode : 72 Power : 25</p>	 <p>Site : 03CHE3-11Y Condition : PEAK(LINE1) 3m HORN_91200_1241 VERTICAL : RBW:1000.000KHz VBW:3000.000KHz SWT:Auto Detector : Peak Project : 900635 Mode : 72 Power : 25</p>



WIFI	Band 4 5725~5850MHz Band Edge @ 3m	
ANT	802.11ac VHT20 CH157 5785MHz	
1+2	Horizontal	Fundamental
Peak	<p>Site : 03CH13-HY Condition : PEAK_BE(B4)_16-24 3m HORN_91200_1241 HORIZONTAL RBW:1000.000KHz VBW:3000.000KHz SWT:Auto Detector : Peak Project : 9D0635 Mode : 73 Power : 25.5</p>	<p>Site : 03CH13-HY Condition : PEAK(LIN1) 3m HORN_91200_1241 HORIZONTAL RBW:1000.000KHz VBW:3000.000KHz SWT:Auto Detector : Peak Project : 9D0635 Mode : 73 Power : 25.5</p>
Peak	<p>Site : 03CH13-HY Condition : PEAK_BE(B4)_16-24 3m HORN_91200_1241 HORIZONTAL RBW:1000.000KHz VBW:3000.000KHz SWT:Auto Detector : Peak Project : 9D0635 Mode : 73 Power : 25.5</p>	Left blank



WIFI	Band 4 5725~5850MHz Band Edge @ 3m	
ANT	802.11ac VHT20 CH157 5785MHz	
1+2	Vertical	Fundamental
<p>Peak</p>	<p>Date: 2020-01-07 PEAK_BE(B4)_16-24</p> <p>Site : 03CH13-HY Condition : PEAK_BE(B4)_16-24 3m HORN_91200_1241 VERTICAL RBW:1000.000KHz VBW:3000.000KHz SWT:Auto Detector : Peak Project : 9D0635 Mode : 73 Power : 25.5</p>	<p>Date: 2020-01-07 PEAK(LINB) AVG 24</p> <p>Site : 03CH13-HY Condition : PEAK(LINB)_16-24 3m HORN_91200_1241 VERTICAL RBW:1000.000KHz VBW:3000.000KHz SWT:Auto Detector : Peak Project : 9D0635 Mode : 73 Power : 25.5</p>
<p>Peak</p>	<p>Date: 2020-01-07 PEAK_BE(B4)_16-24</p> <p>Site : 03CH13-HY Condition : PEAK_BE(B4)_16-24 3m HORN_91200_1241 VERTICAL RBW:1000.000KHz VBW:3000.000KHz SWT:Auto Detector : Peak Project : 9D0635 Mode : 73 Power : 25.5</p>	<p>Left blank</p>

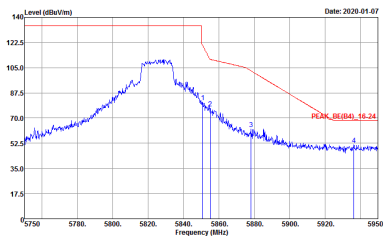
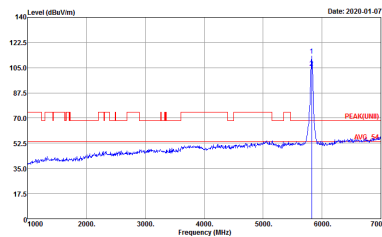

WIFI	Band 4 5725~5850MHz Band Edge @ 3m	
ANT	802.11ac VHT20 CH165 5825MHz	
1+2	Horizontal	Fundamental
Peak	 <p>Site : 03CHE3-11Y Condition : PEAK_BE(B4)_16-24 3m HORN_91200_1241 HORIZONTAL Detector : Peak Project : 900635 Mode : 74 Power : 25.5</p>	 <p>Site : 03CHE3-11Y Condition : PEAK(LINE) 3m HORN_91200_1241 HORIZONTAL Detector : Peak Project : 900635 Mode : 74 Power : 25.5</p>

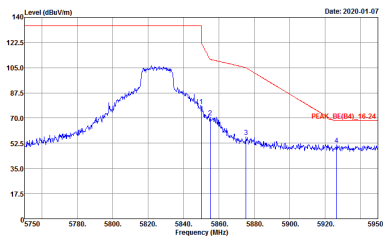
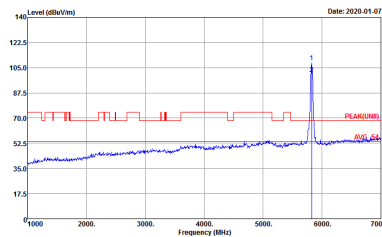

WIFI	Band 4 5725~5850MHz Band Edge @ 3m	
ANT	802.11ac VHT20 CH165 5825MHz	
1+2	Vertical	Fundamental
Peak Avg.	 <p>Site : 03CHE3-11Y Condition : PEAK_BE(B4)_16-24 3m HORN_91200_1241 VERTICAL Detector : Peak Project : 900635 Mode : 74 Power : 25.5</p>	 <p>Site : 03CHE3-11Y Condition : PEAK(LINB) 3m HORN_91200_1241 VERTICAL Detector : Peak Project : 900635 Mode : 74 Power : 25.5</p>



Band 4 5725~5850MHz
WIFI 802.11ac VHT40 (Band Edge @ 3m)

WIFI	Band 4 5725~5850MHz Band Edge @ 3m	
ANT	802.11ac VHT40 CH151 5755MHz	
1+2	Horizontal	Fundamental
Peak	<p>Site : 03CH13-HY Condition : PEAK_BE(B4)_16-24 3m HORN_91200_1241 HORIZONTAL Detector : Peak Project : 9D0635 Mode : 75 Power : 23</p>	<p>Site : 03CH13-HY Condition : PEAK(UNIT) 3m HORN_91200_1241 HORIZONTAL Detector : Peak Project : 9D0635 Mode : 75 Power : 23</p>
Peak	<p>Site : 03CH13-HY Condition : PEAK_BE(B4)_16-24 3m HORN_91200_1241 HORIZONTAL Detector : Peak Project : 9D0635 Mode : 75 Power : 23</p>	Left blank

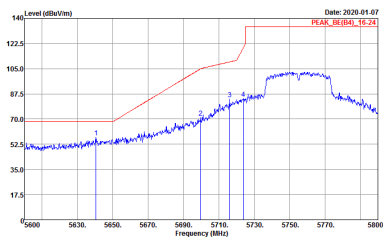
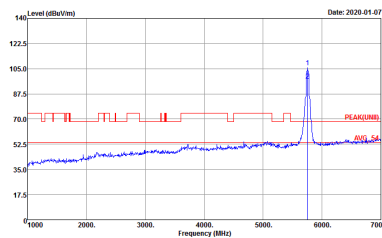
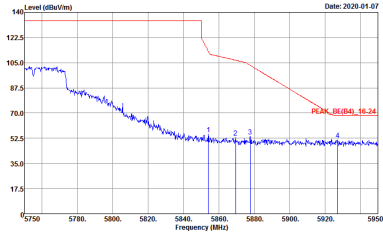

WIFI	Band 4 5725~5850MHz Band Edge @ 3m	
ANT	802.11ac VHT40 CH151 5755MHz	
1+2	Vertical	Fundamental
<p>Peak</p>	 <p>Site : 03CH13-HY Condition : PEAK_BE(B4)_16-24 3m HORN_91200_1241 VERTICAL RBW:1000.000KHz VBW:3000.000KHz SWT:Auto Detector : Peak Project : 9D0635 Mode : 75 Power : 23</p>	 <p>Site : 03CH13-HY Condition : PEAK(LINE1) 3m HORN_91200_1241 VERTICAL RBW:1000.000KHz VBW:3000.000KHz SWT:Auto Detector : Peak Project : 9D0635 Mode : 75 Power : 23</p>
<p>Peak</p>	 <p>Site : 03CH13-HY Condition : PEAK_BE(B4)_16-24 3m HORN_91200_1241 VERTICAL RBW:1000.000KHz VBW:3000.000KHz SWT:Auto Detector : Peak Project : 9D0635 Mode : 75 Power : 23</p>	<p>Left blank</p>

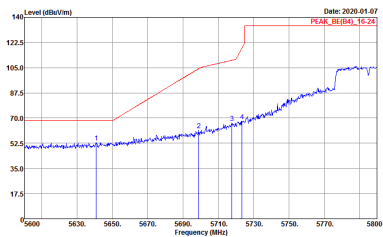
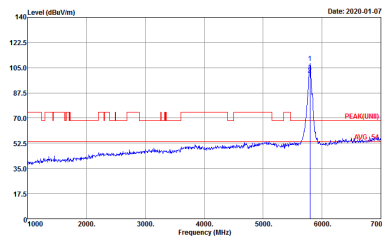
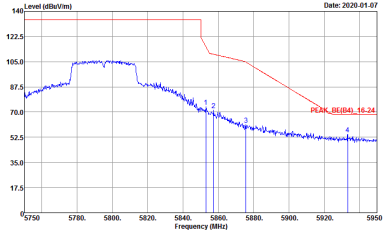

WIFI	Band 4 5725~5850MHz Band Edge @ 3m	
ANT	802.11ac VHT40 CH159 5795MHz	
1+2	Horizontal	Fundamental
<p>Peak</p>	 <p>Site : 03CH13-HY Condition : PEAK_BE(B4)_16-24 3m HORN_91200_1241 HORIZONTAL Detector : Peak Project : 9D0635</p>	 <p>Site : 03CH13-HY Condition : PEAK(LINB) 3m HORN_91200_1241 HORIZONTAL Detector : Peak Project : 9D0635</p>
<p>Peak</p>	 <p>Site : 03CH13-HY Condition : PEAK_BE(B4)_16-24 3m HORN_91200_1241 HORIZONTAL Detector : Peak Project : 9D0635</p>	<p>Left blank</p>

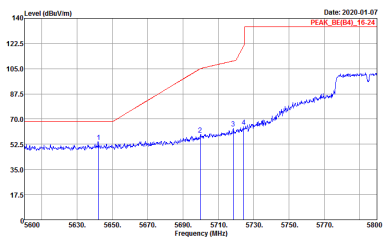
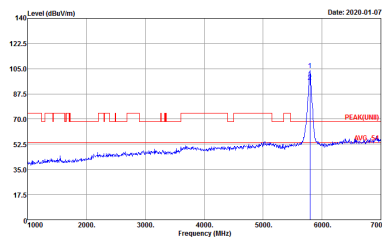
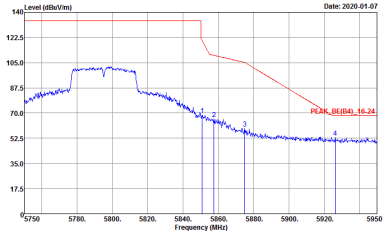

WIFI	Band 4 5725~5850MHz Band Edge @ 3m	
ANT	802.11ac VHT40 CH159 5795MHz	
1+2	Vertical	Fundamental
<p>Peak</p>	 <p>Site : 03CH13-HY Condition : PEAK_BE(B4)_16-24 3m HORN_91200_1241 VERTICAL Detector : Peak Project : 9D0635</p>	 <p>Site : 03CH13-HY Condition : PEAK(LINB) 3m HORN_91200_1241 VERTICAL Detector : Peak Project : 9D0635</p>
<p>Peak</p>	 <p>Site : 03CH13-HY Condition : PEAK_BE(B4)_16-24 3m HORN_91200_1241 VERTICAL Detector : Peak Project : 9D0635</p>	<p>Left blank</p>



Band 4 5725~5850MHz
WIFI 802.11ac VHT80 (Band Edge @ 3m)

WIFI	Band 4 5725~5850MHz Band Edge @ 3m	
ANT	802.11ac VHT80 CH155 5775MHz	
1+2	Horizontal	Fundamental
Peak	<p>Site : 03CH13-HY Condition : PEAK_BE(B4)_16-24 3m HORN_91200_1241 HORIZONTAL Detector : Peak Project : 9D0635 Mode : 77 Setting : 22</p>	<p>Site : 03CH13-HY Condition : PEAK(UNIT) 3m HORN_91200_1241 HORIZONTAL Detector : Peak Project : 9D0635 Mode : 77 Setting : 22</p>
Peak	<p>Site : 03CH13-HY Condition : PEAK_BE(B4)_16-24 3m HORN_91200_1241 HORIZONTAL Detector : Peak Project : 9D0635 Mode : 77 Setting : 22</p>	Left blank

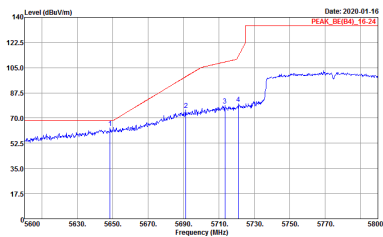
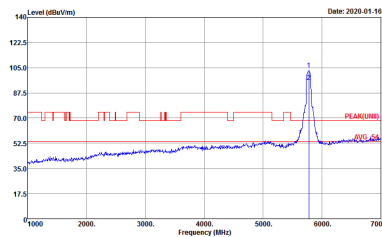
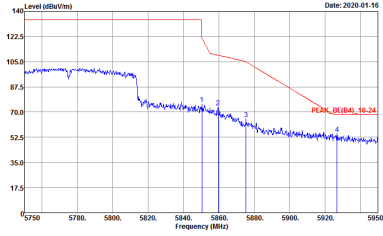

WIFI	Band 4 5725~5850MHz Band Edge @ 3m	
ANT	802.11ac VHT80 CH155 5775MHz	
1+2	Vertical	Fundamental
Peak	 <p>Site : 03CH13-HY Condition : PEAK_BE(B4)_16-24 3m HORN_91200_1241 VERTICAL Detector : Peak Project : 9D0635 Mode : 77 Setting : 22</p>	 <p>Site : 03CH13-HY Condition : PEAK(LINE1) 3m HORN_91200_1241 VERTICAL Detector : Peak Project : 9D0635 Mode : 77 Setting : 22</p>
Peak	 <p>Site : 03CH13-HY Condition : PEAK_BE(B4)_16-24 3m HORN_91200_1241 VERTICAL Detector : Peak Project : 9D0635 Mode : 77 Setting : 22</p>	Left blank



Band 4 - 5725~5850MHz
WIFI 802.11a (Harmonic @ 3m)

Table with 2 columns: Horizontal and Vertical. Each column contains a spectral plot showing Level (dBuV/m) vs Frequency (MHz) with Peak and Avg. markers. Includes metadata like Site, Condition, Detector, Project, and Mode.



WIFI	Band 4 5725~5850MHz Harmonic @ 3m	
ANT	802.11a CH157 5785MHz	
1+2	Horizontal	Vertical
Peak Avg.	<p>Site : 03CHE2-11Y Condition : PEAQ(LINEI) 3m HORN_9120D_1241 HORIZONTAL Detector : Peak Project : 9D0635 Mode : 70</p>	<p>Site : 03CHE2-11Y Condition : PEAQ(LINEI) 3m HORN_9120D_1241 VERTICAL Detector : Peak Project : 9D0635 Mode : 70</p>



WIFI	Band 4 5725~5850MHz Harmonic @ 3m	
ANT	802.11a CH165 5825MHz	
1+2	Horizontal	Vertical
Peak Avg.	<p>Site : 03CHE2-11Y Condition : PEAK(LINE) 3m HORN_9120D_1241 HORIZONTAL Detector : Peak Project : 9D0635 Mode : 71</p>	<p>Site : 03CHE2-11Y Condition : PEAK(LINE) 3m HORN_9120D_1241 VERTICAL Detector : Peak Project : 9D0635 Mode : 71</p>



**Band 4 5725~5850MHz
WIFI 802.11ac VHT20 (Harmonic @ 3m)**

WIFI	Band 4 5725~5850MHz Harmonic @ 3m	
ANT	802.11ac VHT20 CH149 5745MHz	
1+2	Horizontal	Vertical
Peak Avg.	<p>Site : 03CH13-HY Condition : PEAK(UNIT) 3m HORN_9120D_1241 HORIZONTAL Detector : Peak Project : 9D0635</p>	<p>Site : 03CH13-HY Condition : PEAK(UNIT) 3m HORN_9120D_1241 VERTICAL Detector : Peak Project : 9D0635</p>



WIFI	Band 4 5725~5850MHz Harmonic @ 3m	
ANT	802.11ac VHT20 CH157 5785MHz	
1+2	Horizontal	Vertical
Peak Avg.	<p>Site : 03CHE2-11Y Condition : PEAK(LINE) 3m HORN_9120D_1241 HORIZONTAL Detector : Peak Project : 9D0635</p>	<p>Site : 03CHE2-11Y Condition : PEAK(LINE) 3m HORN_9120D_1241 VERTICAL Detector : Peak Project : 9D0635</p>



WIFI	Band 4 5725~5850MHz Harmonic @ 3m	
ANT	802.11ac VHT20 CH165 5825MHz	
1+2	Horizontal	Vertical
<p>Peak</p> <p>Avg.</p>	<p>Site : 03CHE2-11Y Condition : PEAK(LINE) 3m HORN_9120D_1241 HORIZONTAL Detector : Peak Project : 9D0635</p>	<p>Site : 03CHE2-11Y Condition : PEAK(LINE) 3m HORN_9120D_1241 VERTICAL Detector : Peak Project : 9D0635</p>



**Band 4 5725~5850MHz
WIFI 802.11ac VHT40 (Harmonic @ 3m)**

WIFI	Band 4 5725~5850MHz Harmonic @ 3m	
ANT	802.11ac VHT40 CH151 5755MHz	
1+2	Horizontal	Vertical
Peak Avg.	<p>Site : 03CH13-HY Condition : PEAK(UNIT) 3m HORN_9120D_1241 HORIZONTAL Detector : Peak Project : 9D0635</p>	<p>Site : 03CH13-HY Condition : PEAK(UNIT) 3m HORN_9120D_1241 VERTICAL Detector : Peak Project : 9D0635</p>



WIFI	Band 4 5725~5850MHz Harmonic @ 3m	
ANT	802.11ac VHT40 CH159 5795MHz	
1+2	Horizontal	Vertical
<p>Peak</p> <p>Avg.</p>	<p>Site : 03CHE2-11Y Condition : PEAK(LINE) 3m HORN_9120D_1241 HORIZONTAL Detector : Peak Project : 9D0635</p>	<p>Site : 03CHE2-11Y Condition : PEAK(LINE) 3m HORN_9120D_1241 VERTICAL Detector : Peak Project : 9D0635</p>



**Band 4 5725~5850MHz
WIFI 802.11ac VHT80 (Harmonic @ 3m)**

WIFI	Band 4 5725~5850MHz Harmonic @ 3m	
ANT	802.11ac VHT80 CH155 5775MHz	
1+2	Horizontal	Vertical
Peak Avg.	<p>Site : 03CH13-HY Condition : PEAK(UNIT) 3m HORN_9120D_1241 HORIZONTAL Detector : Peak Project : 9D0635</p>	<p>Site : 03CH13-HY Condition : PEAK(UNIT) 3m HORN_9120D_1241 VERTICAL Detector : Peak Project : 9D0635</p>



Band 4 - 5725~5850MHz
WIFI 802.11ax HE20 (Band Edge @ 3m)

WIFI	Band 4 5725~5850MHz Band Edge @ 3m	
ANT	802.11ax HE20 CH149 5745MHz	
1+2	Horizontal	Fundamental
Peak	<p> Site : 03CH13-HY Condition : PEAK_85(BA)_16-24 3m HORN_91200_1241 HORIZONTAL Detector : Peak Project : 900635 Mode : 7B Power : 25 </p>	<p> Site : 03CH13-HY Condition : PEAK(LINE) 3m HORN_91200_1241 HORIZONTAL Detector : Peak Project : 900635 Mode : 7B Power : 25 </p>



WIFI	Band 4 5725~5850MHz Band Edge @ 3m	
ANT	802.11ax HE20 CH149 5745MHz	
1+2	Vertical	Fundamental
<p>Peak</p> <p>Avg.</p>	<p>Site : 03CHE3-14Y Condition : PEAK_BE(B4)_16-24 3m HORN_91200_1241 VERTICAL Detector : Peak Project : 900635 Mode : 7B Power : 25</p>	<p>Site : 03CHE3-14Y Condition : PEAK(LINE) 3m HORN_91200_1241 VERTICAL Detector : Peak Project : 900635 Mode : 7B Power : 25</p>

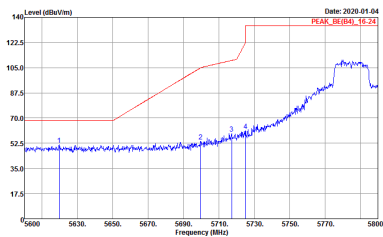
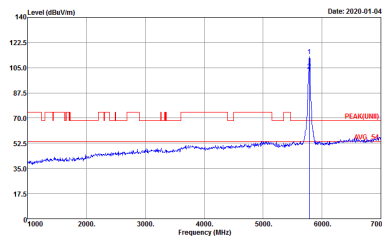
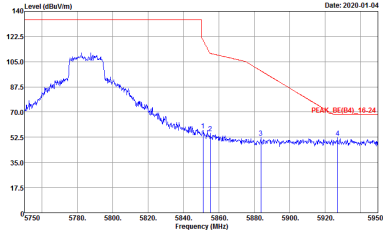

WIFI	Band 4 5725~5850MHz Band Edge @ 3m	
ANT	802.11ax HE20 CH157 5785MHz	
1+2	Horizontal	Fundamental
<p>Peak</p>	 <p>Site : 03CH13-HY Condition : PEAK_BE(B4)_16-24 3m HORN_91200_1241 HORIZONTAL RBW:1000.000kHz VBW:3000.000kHz SWT:Auto Detector : Peak Project : 9D0635 Mode : 79 Power : 24.5</p>	 <p>Site : 03CH13-HY Condition : PEAK(LIN1) 3m HORN_91200_1241 HORIZONTAL RBW:1000.000kHz VBW:3000.000kHz SWT:Auto Detector : Peak Project : 9D0635 Mode : 79 Power : 24.5</p>
<p>Peak</p>	 <p>Site : 03CH13-HY Condition : PEAK_BE(B4)_16-24 3m HORN_91200_1241 HORIZONTAL RBW:1000.000kHz VBW:3000.000kHz SWT:Auto Detector : Peak Project : 9D0635 Mode : 79 Power : 24.5</p>	<p>Left blank</p>



WIFI	Band 4 5725~5850MHz Band Edge @ 3m	
ANT	802.11ax HE20 CH157 5785MHz	
1+2	Vertical	Fundamental
<p>Peak</p>	<p>Site : 03CH13-HY Condition : PEAK_BE(B4)_16-24 3m HORN_91200_1241 VERTICAL Detector : Peak Project : 9D0635 Mode : 79 Power : 24.5</p>	<p>Site : 03CH13-HY Condition : PEAK(LINB)_3m HORN_91200_1241 VERTICAL Detector : Peak Project : 9D0635 Mode : 79 Power : 24.5</p>
<p>Peak</p>	<p>Site : 03CH13-HY Condition : PEAK_BE(B4)_16-24 3m HORN_91200_1241 VERTICAL Detector : Peak Project : 9D0635 Mode : 79 Power : 24.5</p>	<p>Left blank</p>



WIFI	Band 4 5725~5850MHz Band Edge @ 3m	
ANT	802.11ax HE20 CH165 5825MHz	
1+2	Horizontal	Fundamental
Peak	<p>Site : 03CHE3-11Y Condition : PEAK_BE(B4)_16-24 3m HORN_91200_1241 HORIZONTAL RBW:1000.000KHz VBW:3000.000KHz SWT:Auto Detector : Peak Project : 900635 Mode : 80 Power : 24.5</p>	<p>Site : 03CHE3-11Y Condition : PEAK(LINB) 3m HORN_91200_1241 HORIZONTAL RBW:1000.000KHz VBW:3000.000KHz SWT:Auto Detector : Peak Project : 900635 Mode : 80 Power : 24.5</p>

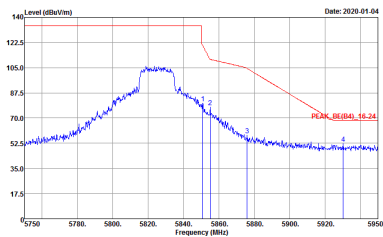
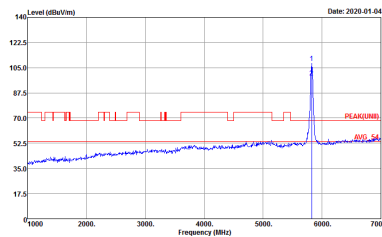

WIFI	Band 4 5725~5850MHz Band Edge @ 3m	
ANT	802.11ax HE20 CH165 5825MHz	
1+2	Vertical	Fundamental
Peak Avg.	 <p>Site : 03CHE3-11Y Condition : PEAK_BE(B4)_16-24 3m HORN_91200_1241 VERTICAL Detector : Peak Project : 900635 Mode : 80 Power : 24.5</p>	 <p>Site : 03CHE3-11Y Condition : PEAK(LINII) 3m HORN_91200_1241 VERTICAL Detector : Peak Project : 900635 Mode : 80 Power : 24.5</p>



Band 4 5725~5850MHz
WIFI 802.11ax HE40 (Band Edge @ 3m)

WIFI	Band 4 5725~5850MHz Band Edge @ 3m	
ANT	802.11ax HE40 CH151 5755MHz	
1+2	Horizontal	Fundamental
Peak	<p>Site : 03CH13-HY Condition : PEAK_BE(B4)_16-24 3m HORN_91200_1241 HORIZONTAL Detector : Peak Project : 9D0635 Mode : B1 Power : 23.5</p>	<p>Site : 03CH13-HY Condition : PEAK(UNIT) 3m HORN_91200_1241 HORIZONTAL Detector : Peak Project : 9D0635 Mode : B1 Power : 23.5</p>
Peak	<p>Site : 03CH13-HY Condition : PEAK_BE(B4)_16-24 3m HORN_91200_1241 HORIZONTAL Detector : Peak Project : 9D0635 Mode : B1 Power : 23.5</p>	Left blank



WIFI	Band 4 5725~5850MHz Band Edge @ 3m	
ANT	802.11ax HE40 CH151 5755MHz	
1+2	Vertical	Fundamental
<p>Peak</p>	<p>Site : 03CH13-HY Condition : PEAK_BE(B4)_16-24 3m HORN_91200_1241 VERTICAL RBW:1000.000KHz VBW:3000.000KHz SWT:Auto Detector : Peak Project : 9D0635 Mode : B1 Power : 23.5</p>	<p>Site : 03CH13-HY Condition : PEAK(LINE1) 3m HORN_91200_1241 VERTICAL RBW:1000.000KHz VBW:3000.000KHz SWT:Auto Detector : Peak Project : 9D0635 Mode : B1 Power : 23.5</p>
<p>Peak</p>	<p>Site : 03CH13-HY Condition : PEAK_BE(B4)_16-24 3m HORN_91200_1241 VERTICAL RBW:1000.000KHz VBW:3000.000KHz SWT:Auto Detector : Peak Project : 9D0635 Mode : B1 Power : 23.5</p>	<p>Left blank</p>



WIFI	Band 4 5725~5850MHz Band Edge @ 3m	
ANT	802.11ax HE40 CH159 5795MHz	
1+2	Horizontal	Fundamental
Peak	<p>Site : 03CH13-HY Condition : PEAK_BE(B4)_16-24 3m HORN_91200_1241 HORIZONTAL Detector : Peak Project : 90D635 Mode : 82 Power : 23.5</p>	<p>Site : 03CH13-HY Condition : PEAK(LINE1) 3m HORN_91200_1241 HORIZONTAL Detector : Peak Project : 90D635 Mode : 82 Power : 23.5</p>
Peak	<p>Site : 03CH13-HY Condition : PEAK_BE(B4)_16-24 3m HORN_91200_1241 HORIZONTAL Detector : Peak Project : 90D635 Mode : 82 Power : 23.5</p>	Left blank

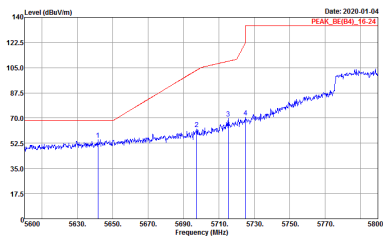
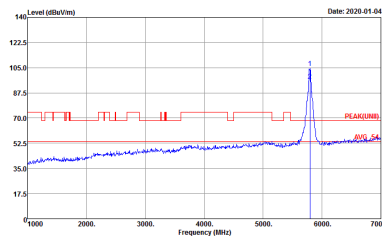
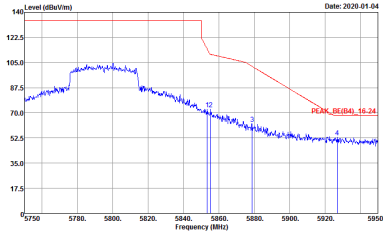

WIFI	Band 4 5725~5850MHz Band Edge @ 3m	
ANT	802.11ax HE40 CH159 5795MHz	
1+2	Vertical	Fundamental
Peak	 <p>Site : 03CH13-HY Condition : PEAK_BE(B4)_16-24 3m HORN_91200_1241 VERTICAL RBW:1000.000KHz VBW:3000.000KHz SWT:Auto Detector : Peak Project : 90D635 Mode : 82 Power : 23.5</p>	 <p>Site : 03CH13-HY Condition : PEAK(LINE1) 3m HORN_91200_1241 VERTICAL RBW:1000.000KHz VBW:3000.000KHz SWT:Auto Detector : Peak Project : 90D635 Mode : 82 Power : 23.5</p>
Peak	 <p>Site : 03CH13-HY Condition : PEAK_BE(B4)_16-24 3m HORN_91200_1241 VERTICAL RBW:1000.000KHz VBW:3000.000KHz SWT:Auto Detector : Peak Project : 90D635 Mode : 82 Power : 23.5</p>	Left blank



Band 4 5725~5850MHz
WIFI 802.11ax HE80 (Band Edge @ 3m)

WIFI	Band 4 5725~5850MHz Band Edge @ 3m	
ANT	802.11ax HE80 CH155 5775MHz	
1+2	Horizontal	Fundamental
Peak	<p>Site : 03CH13-HY Condition : PEAK_BE(B4)_16-24 3m HORN_91200_1241 HORIZONTAL Detector : Peak Project : 9D0635 Mode : 83 Power : 21.5</p>	<p>Site : 03CH13-HY Condition : PEAK(UNIT) 3m HORN_91200_1241 HORIZONTAL Detector : Peak Project : 9D0635 Mode : 83 Power : 21.5</p>
Peak	<p>Site : 03CH13-HY Condition : PEAK_BE(B4)_16-24 3m HORN_91200_1241 HORIZONTAL Detector : Peak Project : 9D0635 Mode : 83 Power : 21.5</p>	Left blank

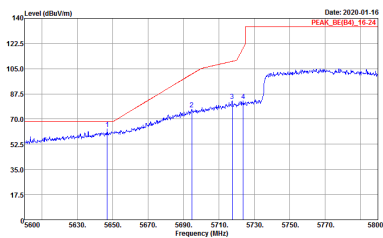
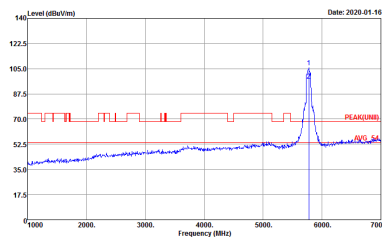
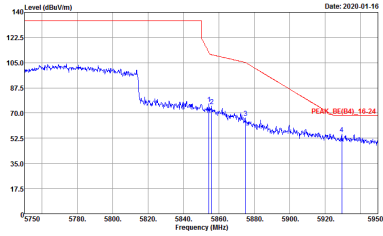

WIFI	Band 4 5725~5850MHz Band Edge @ 3m	
ANT	802.11ax HE80 CH155 5775MHz	
1+2	Vertical	Fundamental
<p>Peak</p>	 <p>Site : 03CH13-HY Condition : PEAK_BE(B4)_16-24 3m HORN_91200_1241 VERTICAL Detector : Peak Project : 900635 Mode : 83 Power : 21.5</p>	 <p>Site : 03CH13-HY Condition : PEAK(LINE1) 3m HORN_91200_1241 VERTICAL Detector : Peak Project : 900635 Mode : 83 Power : 21.5</p>
<p>Peak</p>	 <p>Site : 03CH13-HY Condition : PEAK_BE(B4)_16-24 3m HORN_91200_1241 VERTICAL Detector : Peak Project : 900635 Mode : 83 Power : 21.5</p>	<p>Left blank</p>



Band 4 5725~5850MHz

WIFI 802.11ax HE20 (Partial RU 26/0) (Band Edge @ 3m)

WIFI	Band 4 5725~5850MHz Band Edge @ 3m	
ANT	802.11ax HE20 CH149 5745MHz	
1+2	Horizontal	Fundamental
Peak	<p>Site : 03CH3-14Y Condition : PEAK_8E(B4)_16-24 3m HORN_91200_1241 HORIZONTAL Detector : Peak Project : 900635</p>	<p>Site : 03CH3-14Y Condition : PEAK(UNII) 3m HORN_91200_1241 HORIZONTAL Detector : Peak Project : 900635</p>



WIFI	Band 4 5725~5850MHz Band Edge @ 3m	
ANT	802.11ax HE20 CH149 5745MHz	
1+2	Vertical	Fundamental
Peak Avg.	<p>Site : 03CH13-14Y Condition : PEAK_BE(B4)_16-24 3m HORN_91200_1241 VERTICAL RBW:1000.000KHz VBW:3000.000KHz SWT:Auto Detector : Peak Project : 900635</p>	<p>Site : 03CH13-14Y Condition : PEAK(LINB) 3m HORN_91200_1241 VERTICAL RBW:1000.000KHz VBW:3000.000KHz SWT:Auto Detector : Peak Project : 900635</p>



Band 4 5725~5850MHz

WIFI 802.11ax HE20 (Partial RU 26/8) (Band Edge @ 3m)

WIFI	Band 4 5725~5850MHz Band Edge @ 3m	
ANT	802.11ax HE20 CH165 5825MHz	
1+2	Horizontal	Fundamental
Peak	<p>Site : 03CH3-14Y Condition : PEAK_8E(B4)_16-24 3m HORN_91200_1241 HORIZONTAL Detector : Peak Project : 900635</p>	<p>Site : 03CH3-14Y Condition : PEAK(UNII) 3m HORN_91200_1241 HORIZONTAL Detector : Peak Project : 900635</p>

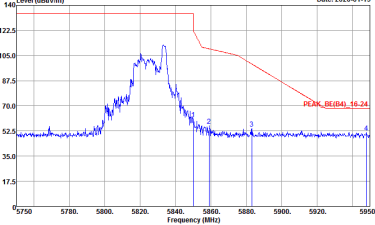
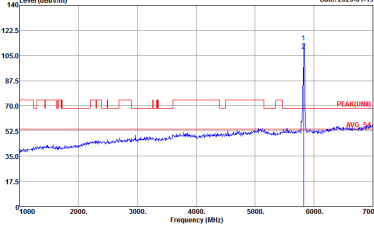

WIFI	Band 4 5725~5850MHz Band Edge @ 3m	
ANT	802.11ax HE20 CH165 5825MHz	
1+2	Vertical	Fundamental
Peak Avg.	 <p>Site : 03CH13-11Y Condition : PEAK_8E(B4)_16-24 3m HORN_91200_1241 VERTICAL RBW:1000.000KHz VBW:3000.000KHz SWT:Auto Detector : Peak Project : 900635</p>	 <p>Site : 03CH13-11Y Condition : PEAK(UNII) 3m HORN_91200_1241 VERTICAL RBW:1000.000KHz VBW:3000.000KHz SWT:Auto Detector : Peak Project : 900635</p>



Band 4 5725~5850MHz

WIFI 802.11ax HE20 (Partial RU 52/37) (Band Edge @ 3m)

WIFI	Band 4 5725~5850MHz Band Edge @ 3m	
ANT	802.11ax HE20 CH149 5745MHz	
1+2	Horizontal	Fundamental
Peak	<p> Site : 03CH13-14Y Condition : PEAK_RE(B4)_16-24 3m HORN_91200_1241 HORIZONTAL Detector : Peak Project : 900635 </p>	<p> Site : 03CH13-14Y Condition : PEAK(UNII) 3m HORN_91200_1241 HORIZONTAL Detector : Peak Project : 900635 </p>

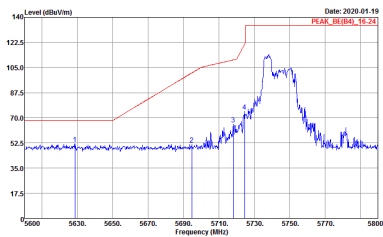
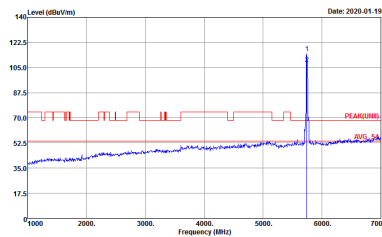

WIFI	Band 4 5725~5850MHz Band Edge @ 3m	
ANT	802.11ax HE20 CH149 5745MHz	
1+2	Vertical	Fundamental
Peak Avg.	 <p>Site : 03CH13-14Y Condition : PEAK_8E(B4)_16-24 3m HORN_91200_1241 VERTICAL RBW:1000.000KHz VBW:3000.000KHz SWT:Auto Detector : Peak Project : 900635</p>	 <p>Site : 03CH13-14Y Condition : PEAK(LINII) 3m HORN_91200_1241 VERTICAL RBW:1000.000KHz VBW:3000.000KHz SWT:Auto Detector : Peak Project : 900635</p>



Band 4 5725~5850MHz

WIFI 802.11ax HE20 (Partial RU 52/40) (Band Edge @ 3m)

WIFI	Band 4 5725~5850MHz Band Edge @ 3m	
ANT	802.11ax HE20 CH165 5825MHz	
1+2	Horizontal	Fundamental
Peak	<p>Site : 03CH13-14Y Condition : PEAK_8E(B4)_16-24 3m HORN_91200_1241 HORIZONTAL Detector : Peak Project : 900635</p>	<p>Site : 03CH13-14Y Condition : PEAK(UNII) 3m HORN_91200_1241 HORIZONTAL Detector : Peak Project : 900635</p>

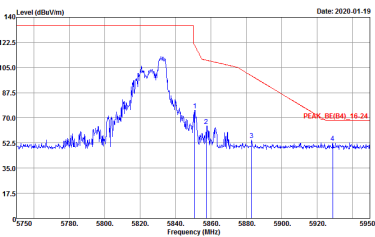
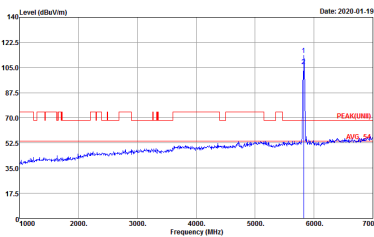

WIFI	Band 4 5725~5850MHz Band Edge @ 3m	
ANT	802.11ax HE20 CH165 5825MHz	
1+2	Vertical	Fundamental
Peak Avg.	 <p>Site : 03CH13-11Y Condition : PEAK_8E(B4)_16-24 3m HORN_91200_1241 VERTICAL RBW:1000.000KHz VBW:3000.000KHz SWT:Auto Detector : Peak Project : 900635</p>	 <p>Site : 03CH13-11Y Condition : PEAK(UNII) 3m HORN_91200_1241 VERTICAL RBW:1000.000KHz VBW:3000.000KHz SWT:Auto Detector : Peak Project : 900635</p>



Band 4 5725~5850MHz

WIFI 802.11ax HE20 (Partial RU 106/53) (Band Edge @ 3m)

WIFI	Band 4 5725~5850MHz Band Edge @ 3m	
ANT	802.11ax HE20 CH149 5745MHz	
1+2	Horizontal	Fundamental
Peak	<p> Site : 03CH13-14Y Condition : PEAK_RE(B4)_16-24 3m HORN_91200_1241 HORIZONTAL Detector : Peak Project : 900635 </p>	<p> Site : 03CH13-14Y Condition : PEAK(UNI) 3m HORN_91200_1241 HORIZONTAL Detector : Peak Project : 900635 </p>

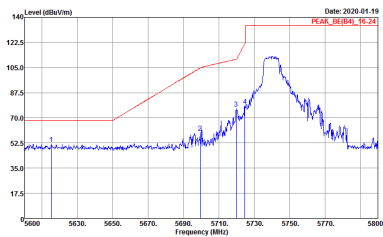
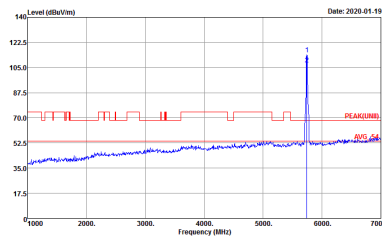

WIFI	Band 4 5725~5850MHz Band Edge @ 3m	
ANT	802.11ax HE20 CH149 5745MHz	
1+2	Vertical	Fundamental
Peak Avg.	 <p>Site : 03CH13-14Y Condition : PEAK_8E(B4)_16-24 3m HORN_91200_1241 VERTICAL RBW:1000.000KHz VBW:3000.000KHz SWT:Auto Detector : Peak Project : 900635</p>	 <p>Site : 03CH13-14Y Condition : PEAK(LUNII) 3m HORN_91200_1241 VERTICAL RBW:1000.000KHz VBW:3000.000KHz SWT:Auto Detector : Peak Project : 900635</p>



Band 4 5725~5850MHz

WIFI 802.11ax HE20 (Partial RU 106/54) (Band Edge @ 3m)

WIFI	Band 4 5725~5850MHz Band Edge @ 3m	
ANT	802.11ax HE20 CH165 5825MHz	
1+2	Horizontal	Fundamental
Peak	<p>Site : 03CH13-14Y Condition : PEAK_8E(B4)_16-24 3m HORN_91200_1241 HORIZONTAL Detector : Peak Project : 900635</p>	<p>Site : 03CH13-14Y Condition : PEAK(UWB) 3m HORN_91200_1241 HORIZONTAL Detector : Peak Project : 900635</p>

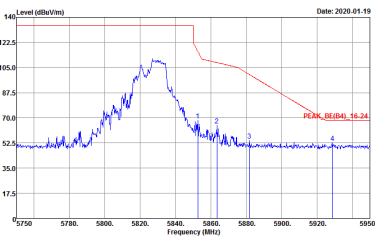
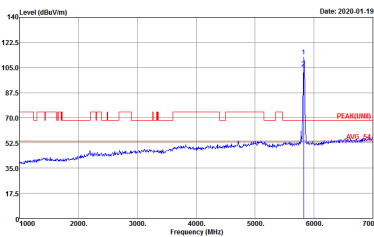

WIFI	Band 4 5725~5850MHz Band Edge @ 3m	
ANT	802.11ax HE20 CH165 5825MHz	
1+2	Vertical	Fundamental
<p>Peak Avg.</p>	 <p>Site : 03CH13-14Y Condition : PEAK_8E(B4)_16-24 3m HORN_91200_1241 VERTICAL RBW:1000.000KHz VBW:3000.000KHz SWT:Auto Detector : Peak Project : 900635</p>	 <p>Site : 03CH13-14Y Condition : PEAK(UNII) 3m HORN_91200_1241 VERTICAL RBW:1000.000KHz VBW:3000.000KHz SWT:Auto Detector : Peak Project : 900635</p>



Band 4 5725~5850MHz

WIFI 802.11ax HE40 (Partial RU 242/61) (Band Edge @ 3m)

WIFI	Band 4 5725~5850MHz Band Edge @ 3m	
ANT	802.11ax HE40 CH151 5755MHz	
1+2	Horizontal	Fundamental
Peak	<p>Site : 03CH13-HY Condition : PEAK_BE(B4)_16-24 3m HORN_91200_1241 HORIZONTAL Detector : Peak Project : 9D0635</p>	<p>Site : 03CH13-HY Condition : PEAK(UNII) 3m HORN_91200_1241 HORIZONTAL Detector : Peak Project : 9D0635</p>
Peak	<p>Site : 03CH13-HY Condition : PEAK_BE(B4)_16-24 3m HORN_91200_1241 HORIZONTAL Detector : Peak Project : 9D0635</p>	Left blank

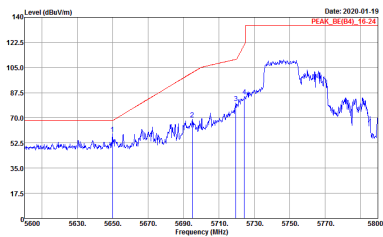
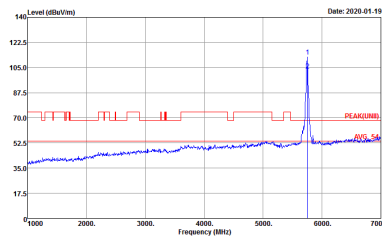
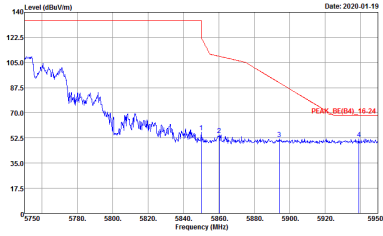

WIFI	Band 4 5725~5850MHz Band Edge @ 3m	
ANT	802.11ax HE40 CH151 5755MHz	
1+2	Vertical	Fundamental
Peak	 <p>Site : 03CH13-HY Condition : PEAK_BE(B4)_16-24 3m HORN_91200_1241 VERTICAL RBW:1000.000KHz VBW:3000.000KHz SWT:Auto Detector : Peak Project : 900635</p>	 <p>Site : 03CH13-HY Condition : PEAK(LINB) 3m HORN_91200_1241 VERTICAL RBW:1000.000KHz VBW:3000.000KHz SWT:Auto Detector : Peak Project : 900635</p>
Peak	 <p>Site : 03CH13-HY Condition : PEAK_BE(B4)_16-24 3m HORN_91200_1241 VERTICAL RBW:1000.000KHz VBW:3000.000KHz SWT:Auto Detector : Peak Project : 900635</p>	Left blank



Band 4 5725~5850MHz

WIFI 802.11ax HE40 (Partial RU 242/62) (Band Edge @ 3m)

WIFI	Band 4 5725~5850MHz Band Edge @ 3m	
ANT	802.11ax HE40 CH159 5795MHz	
1+2	Horizontal	Fundamental
Peak	<p>Site : 03CH13-HY Condition : PEAK_BE(B4)_16-24 3m HORN_91200_1241 HORIZONTAL Detector : Peak Project : 9D0635</p>	<p>Site : 03CH13-HY Condition : PEAK(UNII) 3m HORN_91200_1241 HORIZONTAL Detector : Peak Project : 9D0635</p>
Peak	<p>Site : 03CH13-HY Condition : PEAK_BE(B4)_16-24 3m HORN_91200_1241 HORIZONTAL Detector : Peak Project : 9D0635</p>	Left blank

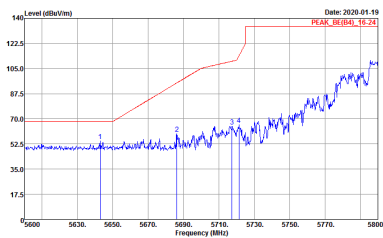
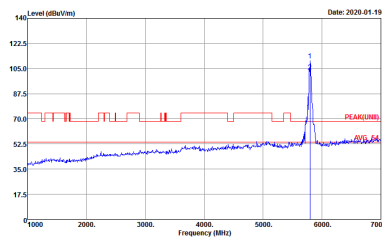
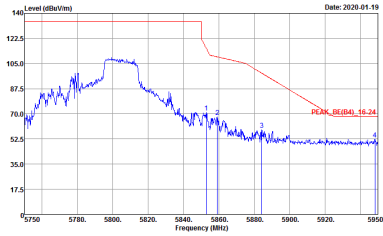

WIFI	Band 4 5725~5850MHz Band Edge @ 3m	
ANT	802.11ax HE40 CH151 5795MHz	
1+2	Vertical	Fundamental
Peak	 <p>Site : 03CH13-HY Condition : PEAK_BE(B4)_16-24 3m HORN_91200_1241 VERTICAL RBW:1000.000KHz VBW:3000.000KHz SWT:Auto Detector : Peak Project : 900635</p>	 <p>Site : 03CH13-HY Condition : PEAK(UNII) 3m HORN_91200_1241 VERTICAL RBW:1000.000KHz VBW:3000.000KHz SWT:Auto Detector : Peak Project : 900635</p>
Peak	 <p>Site : 03CH13-HY Condition : PEAK_BE(B4)_16-24 3m HORN_91200_1241 VERTICAL RBW:1000.000KHz VBW:3000.000KHz SWT:Auto Detector : Peak Project : 900635</p>	Left blank





Band 4 5725~5850MHz

WIFI 802.11ax HE80 (Partial RU 484/65) (Band Edge @ 3m)

WIFI	Band 4 5725~5850MHz Band Edge @ 3m	
ANT	802.11ax HE80 CH155 5775MHz	
1+2	Horizontal	Fundamental
Peak	<p>Site : 03CH13-HY Condition : PEAK_BE(B4)_16-24 3m HORN_91200_1241 HORIZONTAL Detector : Peak Project : 9D0635 Setting : 22.5</p>	<p>Site : 03CH13-HY Condition : PEAK(UNI) 3m HORN_91200_1241 HORIZONTAL Detector : Peak Project : 9D0635 Setting : 22.5</p>
Peak	<p>Site : 03CH13-HY Condition : PEAK_BE(B4)_16-24 3m HORN_91200_1241 HORIZONTAL Detector : Peak Project : 9D0635 Setting : 22.5</p>	Left blank

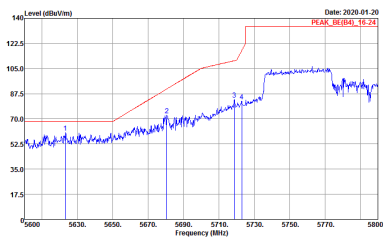
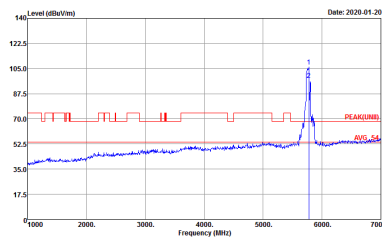

WIFI	Band 4 5725~5850MHz Band Edge @ 3m	
ANT	802.11ax HE80 CH155 5775MHz	
1+2	Vertical	Fundamental
Peak	 <p>Site : 03CH13-HY Condition : PEAK_BE(B4)_16-24 3m HORN_91200_1241 VERTICAL Detector : Peak Project : 90D635 Setting : 22.5</p>	 <p>Site : 03CH13-HY Condition : PEAK(LINII) 3m HORN_91200_1241 VERTICAL Detector : Peak Project : 90D635 Setting : 22.5</p>
Peak	 <p>Site : 03CH13-HY Condition : PEAK_BE(B4)_16-24 3m HORN_91200_1241 VERTICAL Detector : Peak Project : 90D635 Setting : 22.5</p>	Left blank



Band 4 5725~5850MHz

WIFI 802.11ax HE80 (Partial RU 484/66) (Band Edge @ 3m)

WIFI	Band 4 5725~5850MHz Band Edge @ 3m	
ANT	802.11ax HE80 CH155 5775MHz	
1+2	Horizontal	Fundamental
Peak	<p>Site : 03CH13-HY Condition : PEAK_BE(B4)_16-24 3m HORN_91200_1241 HORIZONTAL Detector : Peak Project : 9D0635</p>	<p>Site : 03CH13-HY Condition : PEAK(UNII) 3m HORN_91200_1241 HORIZONTAL Detector : Peak Project : 9D0635</p>
Peak	<p>Site : 03CH13-HY Condition : PEAK_BE(B4)_16-24 3m HORN_91200_1241 HORIZONTAL Detector : Peak Project : 9D0635</p>	Left blank

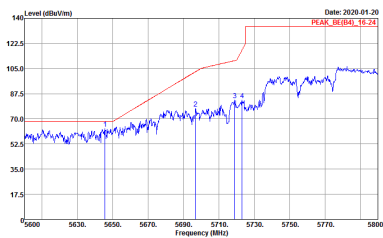
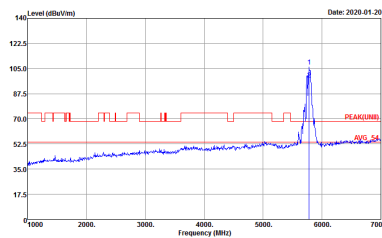
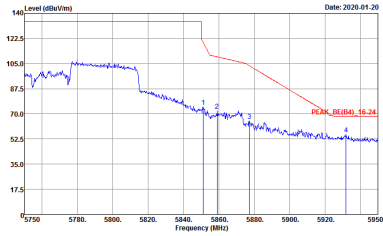

WIFI	Band 4 5725~5850MHz Band Edge @ 3m	
ANT	802.11ax HE80 CH155 5775MHz	
1+2	Vertical	Fundamental
<p>Peak</p>	 <p>Site : 03CH13-HY Condition : PEAK_BE(B4)_16-24 3m HORN_91200_1241 VERTICAL RBW:1000.000KHz VBW:3000.000KHz SWT:Auto Detector : Peak Project : 9D0635</p>	 <p>Site : 03CH13-HY Condition : PEAK(UNII) 3m HORN_91200_1241 VERTICAL RBW:1000.000KHz VBW:3000.000KHz SWT:Auto Detector : Peak Project : 9D0635</p>
<p>Peak</p>	 <p>Site : 03CH13-HY Condition : PEAK_BE(B4)_16-24 3m HORN_91200_1241 VERTICAL RBW:1000.000KHz VBW:3000.000KHz SWT:Auto Detector : Peak Project : 9D0635</p>	<p>Left blank</p>



Band 4 - 5725~5850MHz
WIFI 802.11ax HE20 (Harmonic @ 3m)

WIFI	Band 4 5725~5850MHz Harmonic @ 3m	
ANT	802.11ax HE20 CH149 5745MHz	
1+2	Horizontal	Vertical
Peak Avg.	<p>Site : 05CH13-HY Condition : PEAR(UNIT) 3m HORN_9120D_1241 HORIZONTAL Detector : Peak Project : 9D0635 Mode : 78</p>	<p>Site : 05CH13-HY Condition : PEAR(UNIT) 3m HORN_9120D_1241 VERTICAL Detector : Peak Project : 9D0635 Mode : 78</p>



WIFI	Band 4 5725~5850MHz Harmonic @ 3m	
ANT	802.11ax HE20 CH157 5785MHz	
1+2	Horizontal	Vertical
Peak Avg.	<p>Site : 03CHE2-11Y Condition : PEAK(LINE) 3m HORN_9120D_1241 HORIZONTAL Detector : Peak Project : 9D0635 Mode : 79</p>	<p>Site : 03CHE2-11Y Condition : PEAK(LINE) 3m HORN_9120D_1241 VERTICAL Detector : Peak Project : 9D0635 Mode : 79</p>



WIFI	Band 4 5725~5850MHz Harmonic @ 3m	
ANT	802.11ax HE20 CH165 5825MHz	
1+2	Horizontal	Vertical
Peak Avg.	<p>Site : 03CHE2-11Y Condition : PEAK(LINE) 3m HORN_9120D_1241 HORIZONTAL Detector : Peak Project : 9D0635 Mode : 80</p>	<p>Site : 03CHE2-11Y Condition : PEAK(LINE) 3m HORN_9120D_1241 VERTICAL Detector : Peak Project : 9D0635 Mode : 80</p>



Band 4 5725~5850MHz
WIFI 802.11ax HE40 (Harmonic @ 3m)

WIFI	Band 4 5725~5850MHz Harmonic @ 3m	
ANT	802.11ax HE40 CH151 5755MHz	
1+2	Horizontal	Vertical
Peak Avg.	<p>Site : 03CH13-HY Condition : PEAK(UNIT) 3m HORN_9120D_1241 HORIZONTAL Detector : Peak Project : 9D0635 Mode : 81</p>	<p>Site : 03CH13-HY Condition : PEAK(UNIT) 3m HORN_9120D_1241 VERTICAL Detector : Peak Project : 9D0635 Mode : 81</p>



WIFI	Band 4 5725~5850MHz Harmonic @ 3m	
ANT	802.11ax HE40 CH159 5795MHz	
1+2	Horizontal	Vertical
Peak Avg.	<p>Site : 03CHE2-11Y Condition : PEAK(LINE) 3m HORN_9120D_1241 HORIZONTAL Detector : Peak Project : 9D0635 Mode : B2</p>	<p>Site : 03CHE2-11Y Condition : PEAK(LINE) 3m HORN_9120D_1241 VERTICAL Detector : Peak Project : 9D0635 Mode : B2</p>



**Band 4 5725~5850MHz
WIFI 802.11ax HE80 (Harmonic @ 3m)**

WIFI	Band 4 5725~5850MHz Harmonic @ 3m	
ANT	802.11ax HE80 CH155 5775MHz	
1+2	Horizontal	Vertical
Peak Avg.	<p>Site : 03CH13-HY Condition : PEAK(UNIT) 3m HORN_9120D_1241 HORIZONTAL Detector : Peak Project : 9D0635 Mode : 83</p>	<p>Site : 03CH13-HY Condition : PEAK(UNIT) 3m HORN_9120D_1241 VERTICAL Detector : Peak Project : 9D0635 Mode : 83</p>



Emission below 1GHz

5GHz WIFI 802.11ax HE80 (Partial RU 484/65) (LF)

WIFI	5GHz WIFI	
ANT	802.11ax HE80 LF	
1+2	Horizontal	Vertical
QP / Peak	<p>Site : 03CH13-HY Condition : QP 3m 80LOG_40103 HORIZONTAL Detector : Peak Project : 9D0635 Mode : 94</p>	<p>Site : 03CH13-HY Condition : QP 3m 80LOG_40103 VERTICAL Detector : Peak Project : 9D0635 Mode : 94</p>



<TXBF Mode>

Band 4 - 5725~5850MHz

WIFI 802.11ac VHT20 (Band Edge @ 3m)

WIFI	Band 4 5725~5850MHz Band Edge @ 3m	
ANT	802.11ac VHT20 CH149 5745MHz	
1+2	Horizontal	Fundamental
Peak	<p>Site : 05CH13-HY Condition : PEAK_85(B4)_16-24 3m HORN_91200_1241 HORIZONTAL RBW:1000.000KHz VBW:3000.000KHz SWT:Auto Detector : Peak Project : 900635 Mode : 113</p>	<p>Site : 05CH13-HY Condition : PEAK(LINE) 3m HORN_91200_1241 HORIZONTAL RBW:1000.000KHz VBW:3000.000KHz SWT:Auto Detector : Peak Project : 900635 Mode : 113</p>



WIFI	Band 4 5725~5850MHz Band Edge @ 3m	
ANT	802.11ac VHT20 CH149 5745MHz	
1+2	Vertical	Fundamental
<p>Peak</p> <p>Avg.</p>	<p>Site : 03CH2-11Y Condition : PEAK_BE(B4)_16-24 3m HORN_91200_1241 VERTICAL Detector : Peak Project : 900635 Mode : 113</p>	<p>Site : 03CH2-11Y Condition : PEAK(LINB)_1 3m HORN_91200_1241 VERTICAL Detector : Peak Project : 900635 Mode : 113</p>



WIFI	Band 4 5725~5850MHz Band Edge @ 3m	
ANT	802.11ac VHT20 CH157 5785MHz	
1+2	Horizontal	Fundamental
Peak	<p>Date: 2020-02-08 PEAK_BE(B4)_16-24</p> <p>Site : 03CH13-HY Condition : PEAK_BE(B4)_16-24 3m HORN_91200_1241 HORIZONTAL RBW:1000.000kHz VBW:3000.000kHz SWT:Auto Detector : Peak Project : 9D0635 Mode : 114</p>	<p>Date: 2020-02-08 PEAKLUNB</p> <p>Site : 03CH13-HY Condition : PEAKLUNB1 3m HORN_91200_1241 HORIZONTAL RBW:1000.000kHz VBW:3000.000kHz SWT:Auto Detector : Peak Project : 9D0635 Mode : 114</p>
Peak	<p>Date: 2020-02-08 PEAK_BE(B4)_16-24</p> <p>Site : 03CH13-HY Condition : PEAK_BE(B4)_16-24 3m HORN_91200_1241 HORIZONTAL RBW:1000.000kHz VBW:3000.000kHz SWT:Auto Detector : Peak Project : 9D0635 Mode : 114</p>	Left blank



WIFI	Band 4 5725~5850MHz Band Edge @ 3m	
ANT	802.11ac VHT20 CH157 5785MHz	
1+2	Vertical	Fundamental
<p>Peak</p>	<p>Date: 2020-02-08 PEAK_BE(B4)_16-24</p> <p>Site : 03CH13-HY Condition : PEAK_BE(B4)_16-24 3m HORN_91200_1241 VERTICAL RBW:1000.000KHz VBW:3000.000KHz SWT:Auto Detector : Peak Project : 9D0635 Mode : 114</p>	<p>Date: 2020-02-08 PEAK(LINB) AUG_04</p> <p>Site : 03CH13-HY Condition : PEAK(LINB)_16-24 3m HORN_91200_1241 VERTICAL RBW:1000.000KHz VBW:3000.000KHz SWT:Auto Detector : Peak Project : 9D0635 Mode : 114</p>
<p>Peak</p>	<p>Date: 2020-02-08 PEAK_BE(B4)_16-24</p> <p>Site : 03CH13-HY Condition : PEAK_BE(B4)_16-24 3m HORN_91200_1241 VERTICAL RBW:1000.000KHz VBW:3000.000KHz SWT:Auto Detector : Peak Project : 9D0635 Mode : 114</p>	<p>Left blank</p>



WIFI	Band 4 5725~5850MHz Band Edge @ 3m	
ANT	802.11ac VHT20 CH165 5825MHz	
1+2	Horizontal	Fundamental
Peak	<p>Site : 03CHE3-11Y Condition : PEAK_BE(B4)_16-24 3m HORN_91200_1241 HORIZONTAL Detector : Peak Project : 900635</p>	<p>Site : 03CHE3-11Y Condition : PEAK(LINII) 3m HORN_91200_1241 HORIZONTAL Detector : Peak Project : 900635</p>

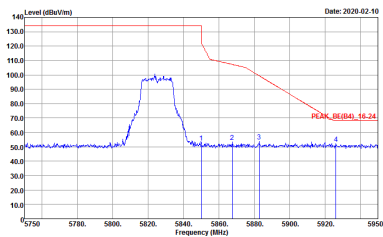
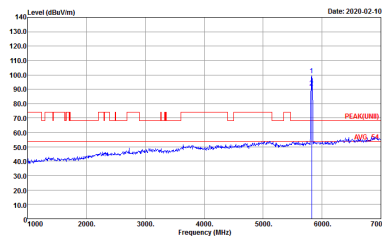

WIFI	Band 4 5725~5850MHz Band Edge @ 3m	
ANT	802.11ac VHT20 CH165 5825MHz	
1+2	Vertical	Fundamental
Peak Avg.	 <p>Site : 03CHE3-11Y Condition : PEAK_BE(B4)_16-24 3m HORN_91200_1241 VERTICAL RBW:1000.000KHz VBW:3000.000KHz SWT:Auto Detector : Peak Project : 900635</p>	 <p>Site : 03CHE3-11Y Condition : PEAK(LINII) 3m HORN_91200_1241 VERTICAL RBW:1000.000KHz VBW:3000.000KHz SWT:Auto Detector : Peak Project : 900635</p>



Band 4 5725~5850MHz
WIFI 802.11ac VHT40 (Band Edge @ 3m)

WIFI	Band 4 5725~5850MHz Band Edge @ 3m	
ANT	802.11ac VHT40 CH151 5755MHz	
1+2	Horizontal	Fundamental
Peak	<p>Site : 03CH13-HY Condition : PEAK_BE(B4)_16-24 3m HORN_91200_1241 HORIZONTAL Detector : Peak Project : 900635 Mode : 116</p>	<p>Site : 03CH13-HY Condition : PEAK(UNIT) 3m HORN_91200_1241 HORIZONTAL Detector : Peak Project : 900635 Mode : 116</p>
Peak	<p>Site : 03CH13-HY Condition : PEAK_BE(B4)_16-24 3m HORN_91200_1241 HORIZONTAL Detector : Peak Project : 900635 Mode : 116</p>	Left blank

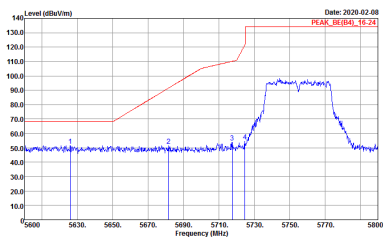
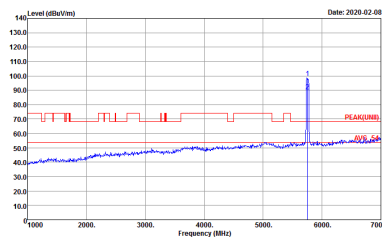
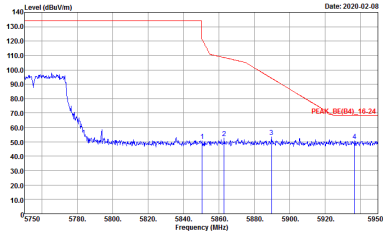

WIFI	Band 4 5725~5850MHz Band Edge @ 3m	
ANT	802.11ac VHT40 CH151 5755MHz	
1+2	Vertical	Fundamental
<p>Peak</p>	 <p>Site : 03CH13-HY Condition : PEAK_BE(B4)_16-24 3m HORN_91200_1241 VERTICAL Detector : Peak Project : 9D0635 Mode : 116</p>	 <p>Site : 03CH13-HY Condition : PEAK(LINII) 3m HORN_91200_1241 VERTICAL Detector : Peak Project : 9D0635 Mode : 116</p>
<p>Peak</p>	 <p>Site : 03CH13-HY Condition : PEAK_BE(B4)_16-24 3m HORN_91200_1241 VERTICAL Detector : Peak Project : 9D0635 Mode : 116</p>	<p>Left blank</p>



WIFI	Band 4 5725~5850MHz Band Edge @ 3m	
ANT	802.11ac VHT40 CH159 5795MHz	
1+2	Horizontal	Fundamental
<p>Peak</p>	<p>Site : 03CH13-HY Condition : PEAK_BE(B4)_16-24 3m HORN_91200_1241 HORIZONTAL Detector : Peak Project : 90D635 Mode : 117</p>	<p>Site : 03CH13-HY Condition : PEAKUNII 3m HORN_91200_1241 HORIZONTAL Detector : Peak Project : 90D635 Mode : 117</p>
<p>Peak</p>	<p>Site : 03CH13-HY Condition : PEAK_BE(B4)_16-24 3m HORN_91200_1241 HORIZONTAL Detector : Peak Project : 90D635 Mode : 117</p>	<p>Left blank</p>

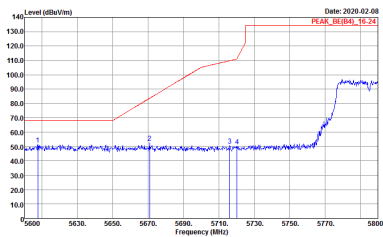
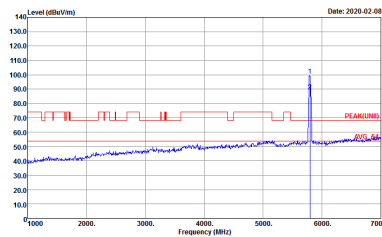
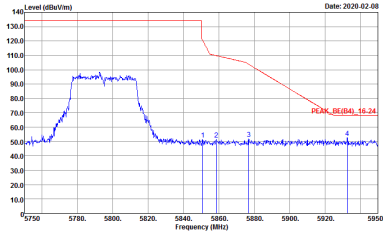

WIFI	Band 4 5725~5850MHz Band Edge @ 3m	
ANT	802.11ac VHT40 CH159 5795MHz	
1+2	Vertical	Fundamental
<p>Peak</p>	 <p>Site : 03CH13-HY Condition : PEAK_BE(B4)_16-24 3m HORN_91200_1241 VERTICAL RBW:1000.000KHz VBW:3000.000KHz SWT:Auto Detector : Peak Project : 90D635 Mode : 117</p>	 <p>Site : 03CH13-HY Condition : PEAK(LINII) 3m HORN_91200_1241 VERTICAL RBW:1000.000KHz VBW:3000.000KHz SWT:Auto Detector : Peak Project : 90D635 Mode : 117</p>
<p>Peak</p>	 <p>Site : 03CH13-HY Condition : PEAK_BE(B4)_16-24 3m HORN_91200_1241 VERTICAL RBW:1000.000KHz VBW:3000.000KHz SWT:Auto Detector : Peak Project : 90D635 Mode : 117</p>	<p>Left blank</p>



Band 4 5725~5850MHz
WIFI 802.11ac VHT80 (Band Edge @ 3m)

WIFI	Band 4 5725~5850MHz Band Edge @ 3m	
ANT	802.11ac VHT80 CH155 5775MHz	
1+2	Horizontal	Fundamental
Peak	<p>Site : 03CH13-HY Condition : PEAK_BE(B4)_16-24 3m HORN_91200_1241 HORIZONTAL Detector : Peak Project : 9D0635 Mode : 11B</p>	<p>Site : 03CH13-HY Condition : PEAK(UNIT) 3m HORN_91200_1241 HORIZONTAL Detector : Peak Project : 9D0635 Mode : 11B</p>
Peak	<p>Site : 03CH13-HY Condition : PEAK_BE(B4)_16-24 3m HORN_91200_1241 HORIZONTAL Detector : Peak Project : 9D0635 Mode : 11B</p>	Left blank

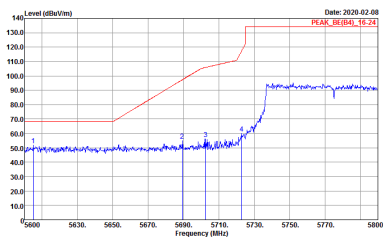
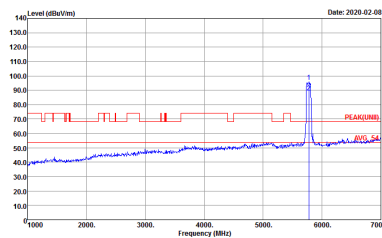
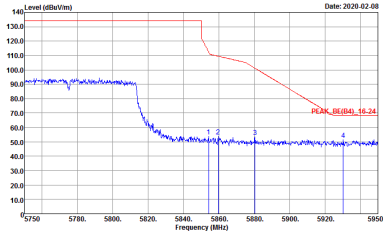

WIFI	Band 4 5725~5850MHz Band Edge @ 3m	
ANT	802.11ac VHT80 CH155 5775MHz	
1+2	Vertical	Fundamental
<p>Peak</p>	 <p>Date: 2020-02-08 PEAK_BE(B4)_16-24</p> <p>Site : 03CH13-HY Condition : PEAK_BE(B4)_16-24 3m HORN_91200_1241 VERTICAL RBW:1000.000kHz VBW:3000.000kHz SWT:Auto Detector : Peak Project : 9D0635 Mode : 11B</p>	 <p>Date: 2020-02-08 PEAK(LINB) RTG_24</p> <p>Site : 03CH13-HY Condition : PEAK(LINB)_16-24 3m HORN_91200_1241 VERTICAL RBW:1000.000kHz VBW:3000.000kHz SWT:Auto Detector : Peak Project : 9D0635 Mode : 11B</p>
<p>Peak</p>	 <p>Date: 2020-02-08 PEAK_BE(B4)_16-24</p> <p>Site : 03CH13-HY Condition : PEAK_BE(B4)_16-24 3m HORN_91200_1241 VERTICAL RBW:1000.000kHz VBW:3000.000kHz SWT:Auto Detector : Peak Project : 9D0635 Mode : 11B</p>	<p>Left blank</p>



Band 4 - 5725~5850MHz
WIFI 802.11ac VHT20 (Harmonic @ 3m)

WIFI	Band 4 5725~5850MHz Harmonic @ 3m	
ANT	802.11ac VHT20 CH149 5745MHz	
1+2	Horizontal	Vertical
Peak Avg.	<p>Site : 05CH13-HY Condition : PEAK(UNIT) 3m HORN_9120D_1241 HORIZONTAL Detector : Peak Project : 900635 Mode : 113</p>	<p>Site : 05CH13-HY Condition : PEAK(UNIT) 3m HORN_9120D_1241 VERTICAL Detector : Peak Project : 900635 Mode : 113</p>

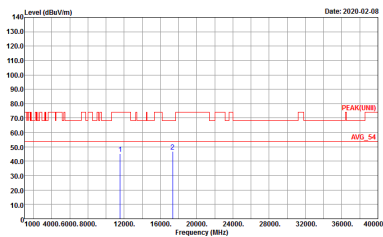
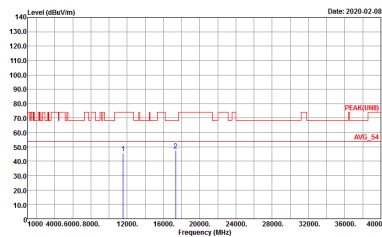

WIFI	Band 4 5725~5850MHz Harmonic @ 3m	
ANT	802.11ac VHT20 CH157 5785MHz	
1+2	Horizontal	Vertical
<p>Peak</p> <p>Avg.</p>	 <p>Site : 03CHE2-11Y Condition : PEAK(LINE) 3m HORN_9120D_1241 HORIZONTAL Detector : Peak Project : 9D0635 Mode : 114</p>	 <p>Site : 03CHE2-11Y Condition : PEAK(LINE) 3m HORN_9120D_1241 VERTICAL Detector : Peak Project : 9D0635 Mode : 114</p>



WIFI	Band 4 5725~5850MHz Harmonic @ 3m	
ANT	802.11ac VHT20 CH165 5825MHz	
1+2	Horizontal	Vertical
Peak Avg.	<p>Site : 03CHE2-11Y Condition : PEAK(LINE) 3m HORN_9120D_1241 HORIZONTAL Detector : Peak Project : 9D0635</p>	<p>Site : 03CHE2-11Y Condition : PEAK(LINE) 3m HORN_9120D_1241 VERTICAL Detector : Peak Project : 9D0635</p>



**Band 4 5725~5850MHz
WIFI 802.11ac VHT40 (Harmonic @ 3m)**

WIFI	Band 4 5725~5850MHz Harmonic @ 3m	
ANT	802.11ac VHT40 CH151 5755MHz	
1+2	Horizontal	Vertical
Peak Avg.	<p> Site : 03CH13-HY Condition : PEAK(LINII) 3m HORN_9120D_1241 HORIZONTAL Detector : Peak Project : 9D0635 Mode : 116 </p>	<p> Site : 03CH13-HY Condition : PEAK(LINII) 3m HORN_9120D_1241 VERTICAL Detector : Peak Project : 9D0635 Mode : 116 </p>

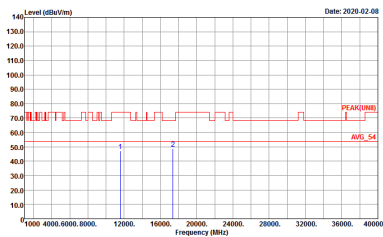
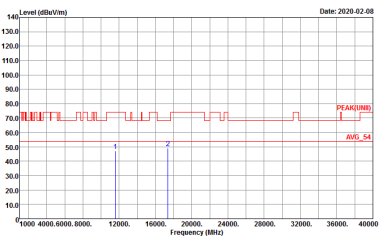

WIFI	Band 4 5725~5850MHz Harmonic @ 3m	
ANT	802.11ac VHT40 CH159 5795MHz	
1+2	Horizontal	Vertical
<p>Peak</p> <p>Avg.</p>	 <p>Site : 03CHE2-11Y Condition : PEAK(LINE) 3m HORN_9120D_1241 HORIZONTAL Detector : Peak Project : 9D0635 Mode : 117</p>	 <p>Site : 03CHE2-11Y Condition : PEAK(LINE) 3m HORN_9120D_1241 VERTICAL Detector : Peak Project : 9D0635 Mode : 117</p>



**Band 4 5725~5850MHz
WIFI 802.11ac VHT80 (Harmonic @ 3m)**

WIFI	Band 4 5725~5850MHz Harmonic @ 3m	
ANT	802.11ac VHT80 CH155 5775MHz	
1+2	Horizontal	Vertical
Peak Avg.	<p>Site : 03CH13-HY Condition : PEAK(UNIT) 3m HORN_9120D_1241 HORIZONTAL Detector : Peak Project : 9D0635 Mode : 118</p>	<p>Site : 03CH13-HY Condition : PEAK(UNIT) 3m HORN_9120D_1241 VERTICAL Detector : Peak Project : 9D0635 Mode : 118</p>



Band 4 - 5725~5850MHz
WIFI 802.11ax HE20 (Band Edge @ 3m)

WIFI	Band 4 5725~5850MHz Band Edge @ 3m	
ANT	802.11ax HE20 CH149 5745MHz	
1+2	Horizontal	Fundamental
Peak	<p>Date: 2020-02-09 PEAK: 135.0 @ 5745.24</p> <p>Site : 03CH13-HY Condition : PEAK_85(BA)_16-24 3m HORN_91200_1241 HORIZONTAL Detector : Peak Project : 9D0635</p>	<p>Date: 2020-02-09 PEAK: 135.0 @ 5745.24</p> <p>Site : 03CH13-HY Condition : PEAK(FUN) 3m HORN_91200_1241 HORIZONTAL Detector : Peak Project : 9D0635</p>

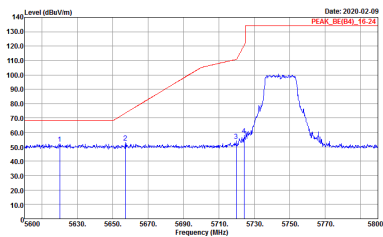
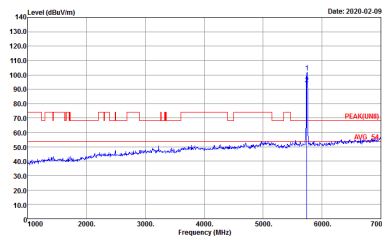

WIFI	Band 4 5725~5850MHz Band Edge @ 3m	
ANT	802.11ax HE20 CH149 5745MHz	
1+2	Vertical	Fundamental
<p>Peak Avg.</p>	 <p>Site : 03CHE3-14Y Condition : PEAK_BE(B4)_16-24 3m HORN_91200_1241 VERTICAL RBW:1000.000KHz VBW:3000.000KHz SWT:Auto Detector : Peak Project : 900635</p>	 <p>Site : 03CHE3-14Y Condition : PEAK(LINB) 3m HORN_91200_1241 VERTICAL RBW:1000.000KHz VBW:3000.000KHz SWT:Auto Detector : Peak Project : 900635</p>



WIFI	Band 4 5725~5850MHz Band Edge @ 3m	
ANT	802.11ax HE20 CH157 5785MHz	
1+2	Horizontal	Fundamental
<p>Peak</p>	<p>Site : 03CH13-HY Condition : PEAK_BE(B4)_16-24 3m HORN_91200_1241 HORIZONTAL Detector : Peak Project : 9D0635</p>	<p>Site : 03CH13-HY Condition : PEAK(LIN)I 3m HORN_91200_1241 HORIZONTAL Detector : Peak Project : 9D0635</p>
<p>Peak</p>	<p>Site : 03CH13-HY Condition : PEAK_BE(B4)_16-24 3m HORN_91200_1241 HORIZONTAL Detector : Peak Project : 9D0635</p>	<p>Left blank</p>



WIFI	Band 4 5725~5850MHz Band Edge @ 3m	
ANT	802.11ax HE20 CH157 5785MHz	
1+2	Vertical	Fundamental
<p>Peak</p>	<p>Site : 03CH13-HY Condition : PEAK_BE(B4)_16-24 3m HORN_91200_1241 VERTICAL Detector : Peak Project : 9D0635</p>	<p>Site : 03CH13-HY Condition : PEAK(LINII) 3m HORN_91200_1241 VERTICAL Detector : Peak Project : 9D0635</p>
<p>Peak</p>	<p>Site : 03CH13-HY Condition : PEAK_BE(B4)_16-24 3m HORN_91200_1241 VERTICAL Detector : Peak Project : 9D0635</p>	<p>Left blank</p>

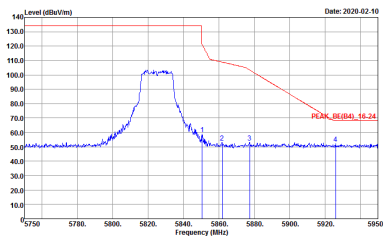
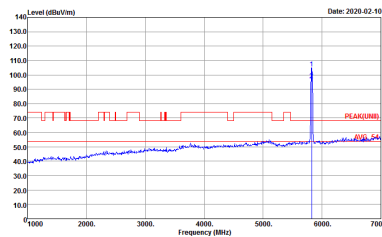

WIFI	Band 4 5725~5850MHz Band Edge @ 3m	
ANT	802.11ax HE20 CH165 5825MHz	
1+2	Horizontal	Fundamental
Peak	 <p>Site : 03CHE3-11Y Condition : PEAK_BE(B4)_16-24 3m HORN_91200_1241 HORIZONTAL RBW:1000.000KHz VBW:3000.000KHz SWT:Auto Detector : Peak Project : 900635</p>	 <p>Site : 03CHE3-11Y Condition : PEAK(LINE) 3m HORN_91200_1241 HORIZONTAL RBW:1000.000KHz VBW:3000.000KHz SWT:Auto Detector : Peak Project : 900635</p>

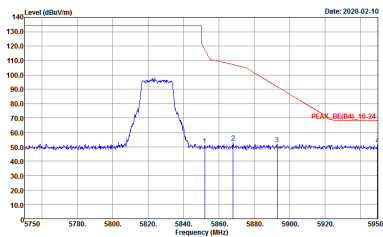
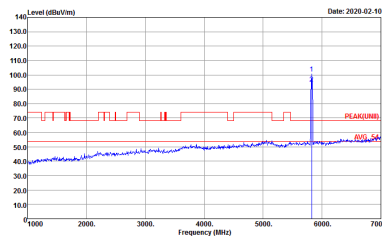

WIFI	Band 4 5725~5850MHz Band Edge @ 3m	
ANT	802.11ax HE20 CH165 5825MHz	
1+2	Vertical	Fundamental
Peak Avg.	 <p>Site : 03CHE3-11Y Condition : PEAK_BE(B4)_16-24 3m HORN_91200_1241 VERTICAL RBW:1000.000KHz VBW:3000.000KHz SWT:Auto Detector : Peak Project : 900635</p>	 <p>Site : 03CHE3-11Y Condition : PEAK(LINB) 3m HORN_91200_1241 VERTICAL RBW:1000.000KHz VBW:3000.000KHz SWT:Auto Detector : Peak Project : 900635</p>



Band 4 5725~5850MHz
WIFI 802.11ax HE40 (Band Edge @ 3m)

WIFI	Band 4 5725~5850MHz Band Edge @ 3m	
ANT	802.11ax HE40 CH151 5755MHz	
1+2	Horizontal	Fundamental
Peak	<p>Site : 03CH13-HY Condition : PEAK_BE(B4)_16-24 3m HORN_91200_1241 HORIZONTAL RBW:1000.000kHz VBW:3000.000kHz SWT:Auto Detector : Peak Project : 9D0635</p>	<p>Site : 03CH13-HY Condition : PEAK(UNIT) 3m HORN_91200_1241 HORIZONTAL RBW:1000.000kHz VBW:3000.000kHz SWT:Auto Detector : Peak Project : 9D0635</p>
Peak	<p>Site : 03CH13-HY Condition : PEAK_BE(B4)_16-24 3m HORN_91200_1241 HORIZONTAL RBW:1000.000kHz VBW:3000.000kHz SWT:Auto Detector : Peak Project : 9D0635</p>	Left blank



WIFI	Band 4 5725~5850MHz Band Edge @ 3m	
ANT	802.11ax HE40 CH151 5755MHz	
1+2	Vertical	Fundamental
<p>Peak</p>	<p>Site : 03CH13-HY Condition : PEAK_BE(B4)_16-24 3m HORN_91200_1241 VERTICAL Detector : Peak Project : 9D0635</p>	<p>Site : 03CH13-HY Condition : PEAK(LIN)I 3m HORN_91200_1241 VERTICAL Detector : Peak Project : 9D0635</p>
<p>Peak</p>	<p>Site : 03CH13-HY Condition : PEAK_BE(B4)_16-24 3m HORN_91200_1241 VERTICAL Detector : Peak Project : 9D0635</p>	<p>Left blank</p>



WIFI	Band 4 5725~5850MHz Band Edge @ 3m	
ANT	802.11ax HE40 CH159 5795MHz	
1+2	Horizontal	Fundamental
<p>Peak</p>	<p>Site : 03CH13-HY Condition : PEAK_BE(B4)_16-24 3m HORN_91200_1241 HORIZONTAL Detector : Peak Project : 9D0635</p>	<p>Site : 03CH13-HY Condition : PEAK(LIN)I 3m HORN_91200_1241 HORIZONTAL Detector : Peak Project : 9D0635</p>
<p>Peak</p>	<p>Site : 03CH13-HY Condition : PEAK_BE(B4)_16-24 3m HORN_91200_1241 HORIZONTAL Detector : Peak Project : 9D0635</p>	<p>Left blank</p>

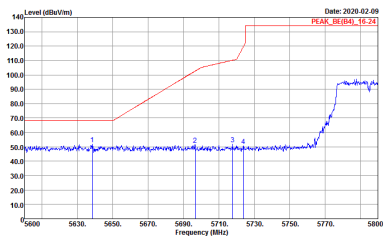
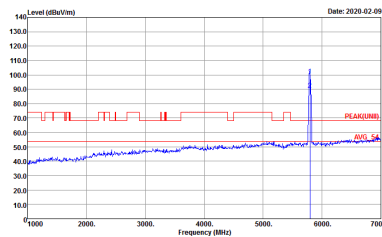
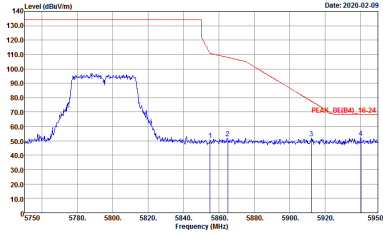

WIFI	Band 4 5725~5850MHz Band Edge @ 3m	
ANT	802.11ax HE40 CH159 5795MHz	
1+2	Vertical	Fundamental
<p>Peak</p>	 <p>Date: 2020-02-09 PEAK_BE(B4)_16-24</p> <p>Site : 03CH13-HY Condition : PEAK_BE(B4)_16-24 3m HORN_91200_1241 VERTICAL Detector : Peak Project : 9D0635</p>	 <p>Date: 2020-02-09 PEAK(LINB) AVG_24</p> <p>Site : 03CH13-HY Condition : PEAK(LINB)_3m HORN_91200_1241 VERTICAL Detector : Peak Project : 9D0635</p>
<p>Peak</p>	 <p>Date: 2020-02-09 PEAK_BE(B4)_16-24</p> <p>Site : 03CH13-HY Condition : PEAK_BE(B4)_16-24 3m HORN_91200_1241 VERTICAL Detector : Peak Project : 9D0635</p>	<p>Left blank</p>