



FCC RADIO TEST REPORT

FCC ID : IHDT56YJ1
Equipment : Mobile Cellular Phone
Brand Name : Motorola
Model Name : XT2061-1
Applicant : Motorola Mobility, LLC
222 W Merchandise Mart Plaza, Suite
1800, Chicago, IL 60654, United States
Manufacturer : Motorola Mobility, LLC
222 W Merchandise Mart Plaza, Suite
1800, Chicago, IL 60654, United States
Standard : FCC Part 15 Subpart C §15.247

The product was received on Dec. 06, 2019 and testing was started from Jan. 07, 2020 and completed on Feb. 13, 2020. We, SPORTON INTERNATIONAL INC., EMC & Wireless Communications Laboratory, would like to declare that the tested sample has been evaluated in accordance with the test procedures and has been in compliance with the applicable technical standards.

The report must not be used by the client to claim product certification, approval, or endorsement by TAF or any agency of government.

The test results in this report apply exclusively to the tested model / sample. Without written approval of SPORTON INTERNATIONAL INC. EMC & Wireless Communications Laboratory, the test report shall not be reproduced except in full.

Louis Wu

Approved by: Louis Wu

SPORTON INTERNATIONAL INC. EMC & Wireless Communications Laboratory
No. 52, Huaya 1st Rd., Guishan Dist., Taoyuan City, Taiwan (R.O.C.)



Table of Contents

History of this test report.....	3
Summary of Test Result.....	4
1 General Description	5
1.1 Product Feature of Equipment Under Test.....	5
1.2 Product Specification of Equipment Under Test.....	6
1.3 Modification of EUT	7
1.4 Testing Location	7
1.5 Applicable Standards.....	7
2 Test Configuration of Equipment Under Test	8
2.1 Carrier Frequency and Channel	8
2.2 Test Mode.....	9
2.3 Connection Diagram of Test System.....	11
2.4 Support Unit used in test configuration and system	13
2.5 EUT Operation Test Setup	13
2.6 Measurement Results Explanation Example.....	14
3 Test Result	15
3.1 6dB and 99% Bandwidth Measurement	15
3.2 Output Power Measurement.....	17
3.3 Power Spectral Density Measurement	18
3.4 Conducted Band Edges and Spurious Emission Measurement	22
3.5 Radiated Band Edges and Spurious Emission Measurement	75
3.6 AC Conducted Emission Measurement.....	80
3.7 Antenna Requirements.....	82
4 List of Measuring Equipment.....	84
5 Uncertainty of Evaluation	86
Appendix A. Conducted Test Results	
Appendix B. AC Conducted Emission Test Result	
Appendix C. Radiated Spurious Emission	
Appendix D. Radiated Spurious Emission Plots	
Appendix E. Duty Cycle Plots	



History of this test report

Report No.	Version	Description	Issued Date
FR9D0635C	01	Initial issue of report	Feb. 14, 2020



Summary of Test Result

Report Clause	Ref Std. Clause	Test Items	Result (PASS/FAIL)	Remark
3.1	15.247(a)(2)	6dB Bandwidth	Pass	-
3.1	2.1049	99% Occupied Bandwidth	Reporting only	-
3.2	15.247(b)	Power Output Measurement	Pass	-
3.3	15.247(e)	Power Spectral Density	Pass	-
3.4	15.247(d)	Conducted Band Edges	Pass	-
		Conducted Spurious Emission	Pass	-
3.5	15.247(d)	Radiated Band Edges and Radiated Spurious Emission	Pass	Under limit 3.31 dB at 2390.000 MHz
3.6	15.207	AC Conducted Emission	Pass	Under limit 18.23 dB at 2.013 MHz
3.7	15.203 & 15.247(b)	Antenna Requirement	Pass	-

Declaration of Conformity:

The test results with all measurement uncertainty excluded are presented in accordance with the regulation limits or requirements declared by manufacturers.

Comments and Explanations:

The declared of product specification for EUT presented in the report are provided by the manufacturer, and the manufacturer takes all the responsibilities for the accuracy of product specification.

Reviewed by: Wii Chang

Report Producer: Fiona Wu



1 General Description

1.1 Product Feature of Equipment Under Test

Product Feature	
Equipment	Mobile Cellular Phone
Brand Name	Motorola
Model Name	XT2061-1
FCC ID	IHDT56YJ1
IMEI Code	Conducted : IMEI: 359120100011371 Conduction : IMEI: 359120100016479 Radiation : IMEI: 359120100016305 IMEI: 359120100017071
EUT supports Radios application	CDMA/EV-DO/GSM/EGPRS/WCDMA/HSPA/LTE/5G NR/ GNSS/NFC/WPC WLAN 11b/g/n HT20 WLAN 11a/n HT20/HT40 WLAN 11ac VHT20/VHT40/VHT80 WLAN 11ax HE20/HE40/HE80 Bluetooth BR/EDR/LE
HW Version	DVT2
EUT Stage	Identical Prototype

Remark: The above EUT's information was declared by manufacturer.

Accessory List	
AC Adapter 1	Brand Name : Motorola
	Model Name : SC-51 (SA18C30116)
	Manufacturer : Chenyang
AC Adapter 2	Brand Name : Motorola
	Model Name : SC-51 (SA18C62985)
	Manufacturer : Acbel
Battery	Brand Name : ATL
	Model Name : LW50
USB Cable 1	Brand Name : Motorola
	Model Name : SC18C24367
	Manufacturer : Saibao
USB Cable 2	Brand Name : Motorola
	Model Name : SC18C24368
	Manufacturer : Luxshare



1.2 Product Specification of Equipment Under Test

Standards-related Product Specification										
Tx/Rx Channel Frequency Range	2412 MHz ~ 2462 MHz									
Maximum Output Power to antenna <CDD Mode>	<p><Ant. 1> 802.11b : 20.80 dBm (0.1202 W) 802.11g : 20.20 dBm (0.1047 W) 802.11n HT20 : 20.10 dBm (0.1023 W) 802.11ax HE20 : 20.70 dBm (0.1175 W) 802.11ax HE40 : 18.60 dBm (0.0724 W)</p> <p><Ant. 2> 802.11b : 20.70 dBm (0.1175 W) 802.11g : 20.30 dBm (0.1072 W) 802.11n HT20 : 20.20 dBm (0.1047 W) 802.11ax HE20 : 20.70 dBm (0.1175 W) 802.11ax HE40 : 18.70 dBm (0.0741 W)</p> <p>MIMO <Ant. 1+2> 802.11b : 23.72 dBm (0.2355 W) 802.11g : 23.27 dBm (0.2123 W) 802.11n HT20 : 23.31 dBm (0.2143W) 802.11ax HE20 : 23.77 dBm (0.2382 W) 802.11ax HE40 : 21.93 dBm (0.1560 W)</p>									
Maximum Output Power to antenna <TXBF Mode>	<p>MIMO <Ant. 1+2> 802.11ax HE20 : 21.91 dBm (0.1552 W)</p>									
99% Occupied Bandwidth <CDD Mode>	<p>MIMO <Ant. 1> 802.11b : 13.39MHz 802.11g : 16.58MHz 802.11n HT20 : 17.78MHz 802.11ax HE20 : 19.13MHz 802.11ax HE40 : 38.56MHz</p> <p>MIMO <Ant. 2> 802.11b : 13.79MHz 802.11g : 17.08MHz 802.11n HT20 : 19.23MHz 802.11ax HE20 : 21.68MHz 802.11ax HE40 : 38.96MHz</p>									
99% Occupied Bandwidth <TXBF Mode>	<p>MIMO <Ant. 1> 802.11ax HE20 : 17.63MHz</p> <p>MIMO <Ant. 2> 802.11ax HE20 : 17.53MHz</p>									
Antenna Type / Gain	<p><Ant. 1>: Fixed Internal type with gain -2.50 dBi <Ant. 2>: Fixed Internal type with gain -6.60 dBi</p>									
Type of Modulation	802.11b : DSSS (DBPSK / DQPSK / CCK) 802.11g/n : OFDM (BPSK / QPSK / 16QAM / 64QAM) 802.11ax : OFDM (BPSK / QPSK / 16QAM / 64QAM / 256 QAM / 1024 QAM)									
Antenna Function Description	<table border="1"> <thead> <tr> <th></th> <th>Ant. 1</th> <th>Ant. 2</th> </tr> </thead> <tbody> <tr> <td>802.11 b/g/n/ax</td> <td>V</td> <td>V</td> </tr> <tr> <td>802.11 b/g/n/ax MIMO</td> <td>V</td> <td>V</td> </tr> </tbody> </table>		Ant. 1	Ant. 2	802.11 b/g/n/ax	V	V	802.11 b/g/n/ax MIMO	V	V
	Ant. 1	Ant. 2								
802.11 b/g/n/ax	V	V								
802.11 b/g/n/ax MIMO	V	V								

Remark: MIMO Ant. 1+2 is a calculated result from sum of the power MIMO Ant. 1 and MIMO Ant. 2.



1.3 Modification of EUT

No modifications are made to the EUT during all test items.

1.4 Testing Location

Test Site	SPORTON INTERNATIONAL INC. EMC & Wireless Communications Laboratory	
Test Site Location	No.52, Huaya 1st Rd., Guishan Dist., Taoyuan City, Taiwan (R.O.C.) TEL: +886-3-327-3456 FAX: +886-3-328-4978	
Test Site No.	Sporton Site No.	
	TH05-HY	CO05-HY

Note: The test site complies with ANSI C63.4 2014 requirement.

Test Site	SPORTON INTERNATIONAL INC. EMC & Wireless Communications Laboratory	
Test Site Location	No.58, Aly. 75, Ln. 564, Wenhua 3rd, Rd., Guishan Dist., Taoyuan City, Taiwan (R.O.C.) TEL: +886-3-327-0868 FAX: +886-3-327-0855	
Test Site No.	Sporton Site No.	
	03CH15-HY	

Note: The test site complies with ANSI C63.4 2014 requirement.

FCC designation No.: TW1190 and TW0007

1.5 Applicable Standards

According to the specifications of the manufacturer, the EUT must comply with the requirements of the following standards:

- ♦ FCC Part 15 Subpart C §15.247
- ♦ FCC KDB Publication No. 558074 D01 DTS Meas. Guidance v05r02
- ♦ FCC KDB 414788 D01 Radiated Test Site v01r01.
- ♦ FCC KDB 662911 D01 Multiple Transmitter Output v02r01.
- ♦ ANSI C63.10-2013

Remark:

1. All test items were verified and recorded according to the standards and without any deviation during the test.
2. This EUT has also been tested and complied with the requirements of FCC Part 15, Subpart B, recorded in a separate test report.



2 Test Configuration of Equipment Under Test

- a. The EUT has been associated with peripherals and configuration operated in a manner tended to maximize its emission characteristics in a typical application. Frequency range investigated: conduction emission (150 kHz to 30 MHz), radiation emission (9 kHz to the 10th harmonic of the highest fundamental frequency or to 40 GHz, whichever is lower). For radiated measurement, pre-scanned in three orthogonal panels, X, Y, Z. The worst cases (Y Plane for 802.11ax Partial RU, WPC, and TXBF Mode; Z plane for 802.11 b/g/n Mode) were recorded in this report.

- b. AC power line Conducted Emission was tested under maximum output power.

2.1 Carrier Frequency and Channel

Frequency Band	Channel	Freq. (MHz)	Channel	Freq. (MHz)
2400-2483.5 MHz	1	2412	7	2442
	2	2417	8	2447
	3	2422	9	2452
	4	2427	10	2457
	5	2432	11	2462
	6	2437		



2.2 Test Mode

Final test modes are considering the modulation and worse data rates as below table.

Single Mode

Modulation	Data Rate
802.11ax HH20	MCS0
802.11ax HH40	MCS0

MIMO Mode

Modulation	Data Rate
802.11b	1 Mbps
802.11g	6 Mbps
802.11n HT20	MCS0
802.11n HT40	MCS0
802.11ax HH20	MCS0
802.11ax HH40	MCS0

TXBF Mode

Modulation	Data Rate
802.11ax HH20	MCS0

Test Cases	
AC Conducted Emission	Mode 1 :GSM850 Idle + Bluetooth Link + WLAN (2.4GHz) Link + MPEG4 + Earphone + Battery + USB Cable 1 (Charging from Adapter 1)
Remark: For Radiated Test Cases, the tests were performed with Adapter 1 and USB Cable 1	



<CDD Mode>

Ch. #	2400-2483.5 MHz		
	802.11b	802.11g	802.11n HT20
Low	01	01	01
Middle	06	06	06
High	11	11	11

Ch. #	2400-2483.5 MHz	
	802.11ax HE20	802.11ax HE40
Low	01	03
Middle	-	06
High	11	09

<TXBF Mode>

Ch. #	2400-2483.5 MHz
	802.11ax HE20
Low	01
Middle	06
High	11

<WPC Mode>

Ch. #	2400-2483.5 MHz
	802.11ax HE20
Low	01
Middle	-
High	-

Remark: For radiation spurious emission, the final modulation and the worst data rate was reference the max RF conducted power.

2.3 Connection Diagram of Test System

<WLAN Tx Mode>

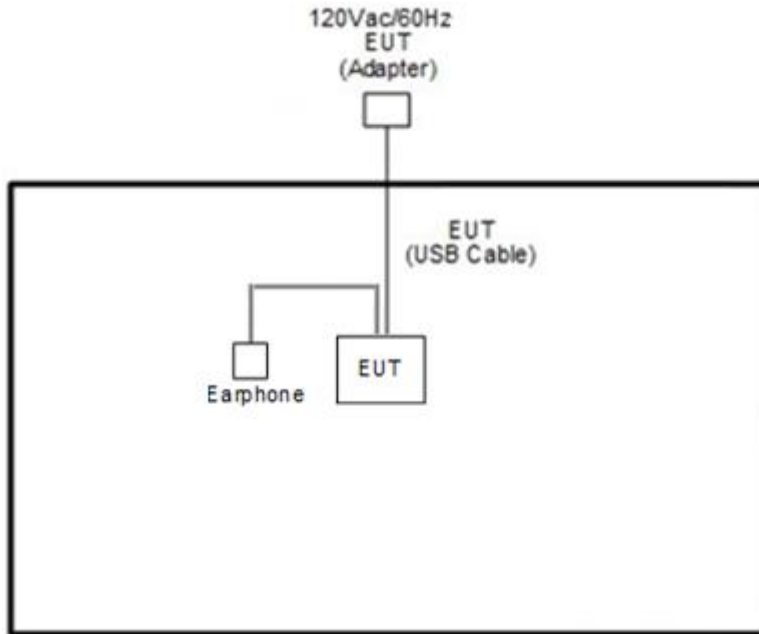

<TXBF Mode>

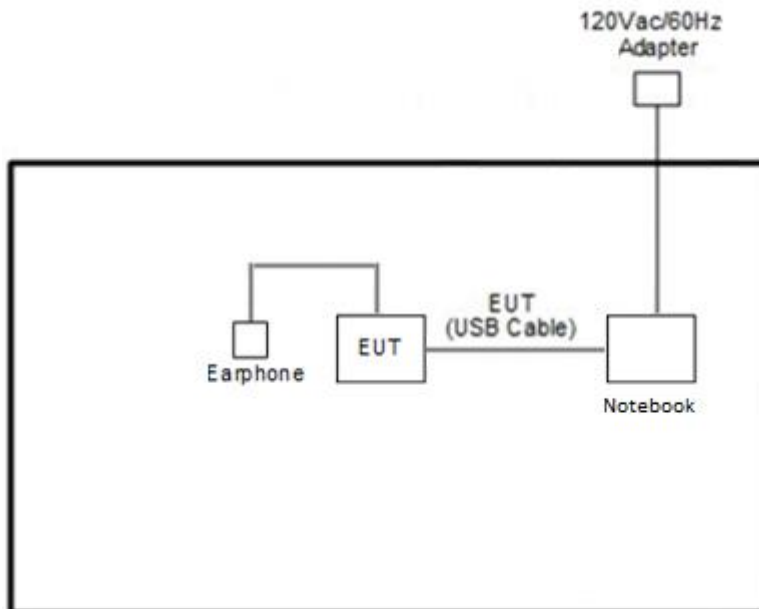

<WPC Mode>

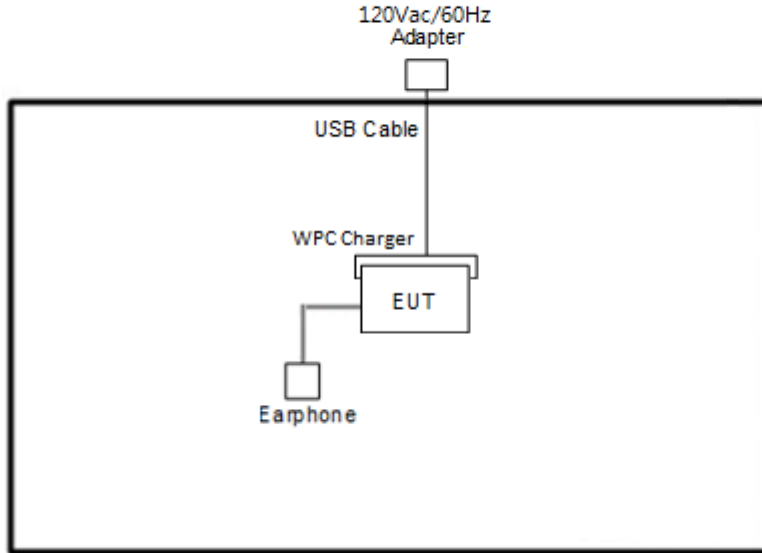

<AC Conducted Emission Mode>

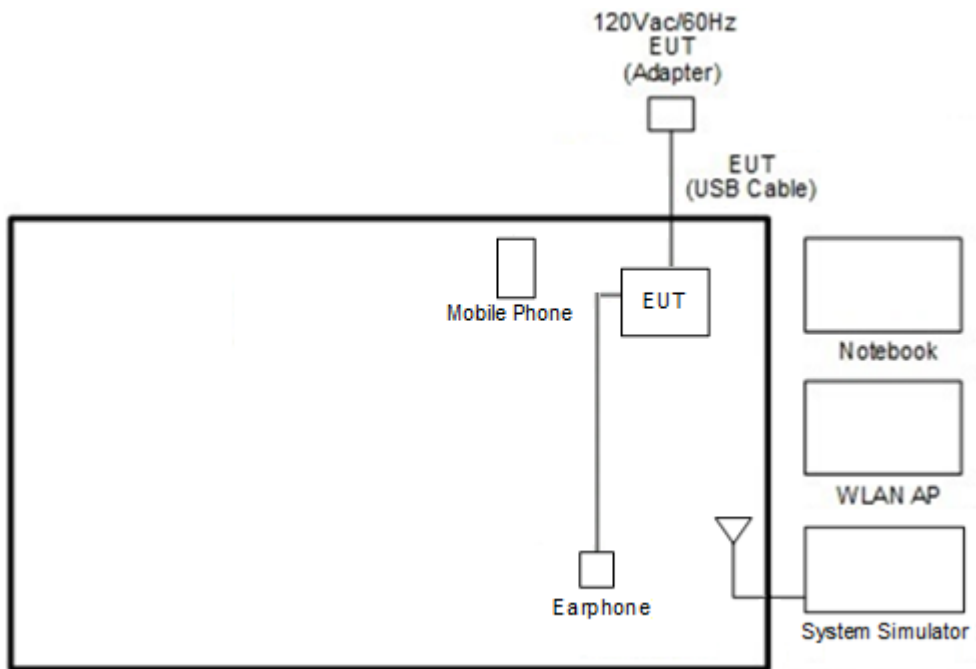

2.4 Support Unit used in test configuration and system

Item	Equipment	Trade Name	Model Name	FCC ID	Data Cable	Power Cord
1.	System Simulator	R&S	CMU 200	N/A	N/A	Unshielded, 1.8 m
2.	WLAN AP	ASUS	RT-AC66U	MSQ-RTAC66U	N/A	Unshielded, 1.8 m
3.	Notebook	DELL	Latitude E3400	FCC DoC	N/A	AC I/P: Unshielded, 1.2 m DC O/P: Shielded, 1.8 m
4.	Mobile Phone	Moto	moto burton	N/A	N/A	N/A
5.	Earphone	Moto	NASH38C16 618	N/A	Unshielded, 1.0 m	N/A
6.	Wireless Charger Stand	Samsung	EP-N5200	N/A	N/A	N/A
7.	Adapter	N/A	N/A	N/A	N/A	N/A
8.	USB Cable	N/A	N/A	N/A	N/A	N/A

2.5 EUT Operation Test Setup

The RF test items, utility “QRCT V4.0.00142.0” was installed in Notebook which was programmed in order to make the EUT get into the engineering modes to provide channel selection, power level, data rate and the application type and for continuous transmitting signals.

For TXBF mode, the modulation modes and data rates manipulated by the command lines in the engineering program made the EUT link to another EUT by power under the normal operation. The “QRCT V4.0.00142.0” software tool was used to enable the EUT to transmit signals continuously.



2.6 Measurement Results Explanation Example

For all conducted test items:

The offset level is set in the spectrum analyzer to compensate the RF cable loss and attenuator factor between EUT conducted output port and spectrum analyzer. With the offset compensation, the spectrum analyzer reading level is exactly the EUT RF output level.

Example:

The spectrum analyzer offset is derived from RF cable loss and attenuator factor.

Offset = RF cable loss + attenuator factor.

Following shows an offset computation example with cable loss 4.2 dB and 10dB attenuator.

$$\begin{aligned} \text{Offset(dB)} &= \text{RF cable loss(dB)} + \text{attenuator factor(dB)}. \\ &= 4.2 + 10 = 14.2 \text{ (dB)} \end{aligned}$$

3 Test Result

3.1 6dB and 99% Bandwidth Measurement

3.1.1 Limit of 6dB and 99% Bandwidth

The minimum 6 dB bandwidth shall be at least 500 kHz.

3.1.2 Measuring Instruments

See list of measuring equipment of this test report.

3.1.3 Test Procedures

1. The testing follows the ANSI C63.10 Section 6.9.3 (OBW) and 11.8.1 (6dB BW).
2. The RF output of EUT was connected to the spectrum analyzer by RF cable and attenuator. The path loss was compensated to the results for each measurement.
3. Set to the maximum power setting and enable the EUT transmit continuously.
4. Make the measurement with the spectrum analyzer's resolution bandwidth (RBW) = 100 kHz. Set the Video bandwidth (VBW) = 300 kHz. In order to make an accurate measurement. The 6 dB bandwidth must be greater than 500 kHz.
5. For 99% Bandwidth Measurement, the spectrum analyzer's resolution bandwidth (RBW) is set 1-5% of the emission bandwidth and set the Video bandwidth (VBW) $\geq 3 * RBW$.
6. Measure and record the results in the test report.

3.1.4 Test Setup

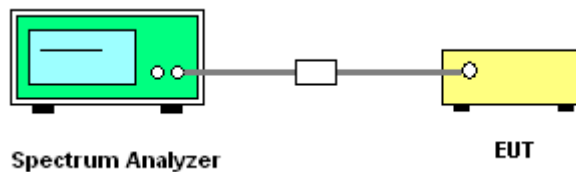



3.1.5 Test Result of 6dB and 99% Occupied Bandwidth

Please refer to Appendix A.

<CDD Mode>

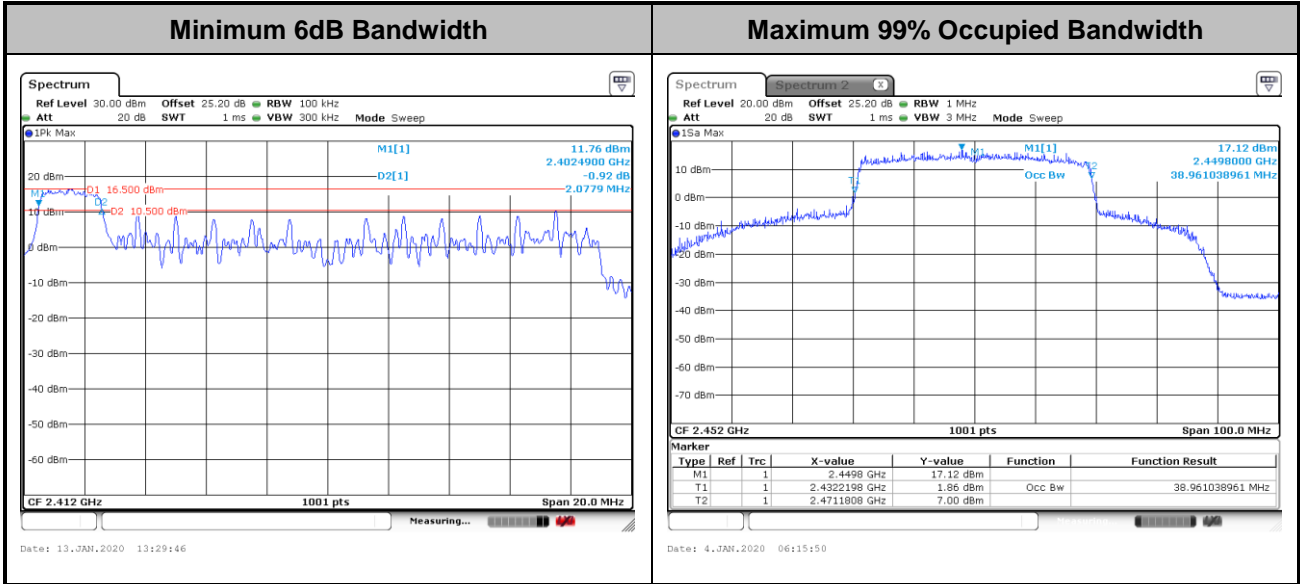

Note: The occupied channel bandwidth is maintained within the band of operation for all of the modulations.

<TXBF Modes>

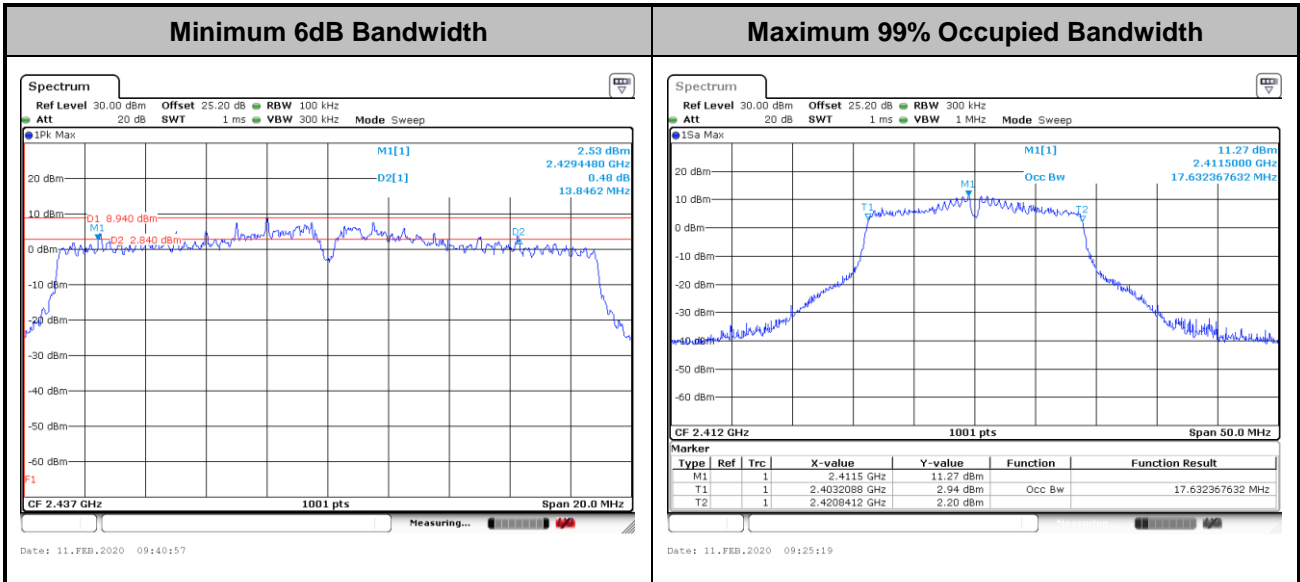

Note: The occupied channel bandwidth is maintained within the band of operation for all of the modulations.

3.2 Output Power Measurement

3.2.1 Limit of Output Power

For systems using digital modulation in the 2400-2483.5MHz, the limit for output power is 30dBm. If transmitting antenna with directional gain greater than 6dBi is used, the output power from the intentional radiator shall be reduced below the above stated value by the amount in dB that the directional gain of the antenna exceeds 6 dBi. In case of point-to-point operation, the limit has to be reduced by 1dB for every 3dB that the directional gain of the antenna exceeds 6dBi.

3.2.2 Measuring Instruments

See list of measuring equipment of this test report.

3.2.3 Test Procedures

1. For Peak Power, the testing follows ANSI C63.10 Section 11.9.1.3 PKPM1
2. For Average Power, the testing follows ANSI C63.10 Section 11.9.2.3.2 Method AVGPM-G
3. The RF output of EUT was connected to the power meter by RF cable and attenuator. The path loss was compensated to the results for each measurement.
4. Set to the maximum power setting and enable the EUT transmit continuously.
5. Measure the conducted output power and record the results in the test report.
6. For MIMO mode, calculation method follows FCC KDB 662911 D01 Multiple Transmitter Output v02r01.

3.2.4 Test Setup

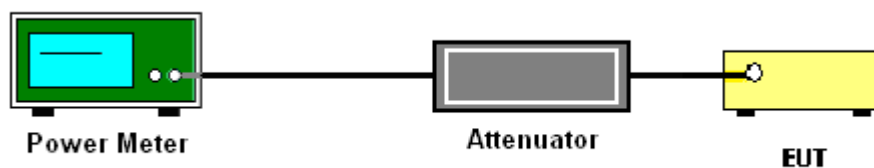

3.2.5 Test Result of Peak Output Power (Reporting Only)

Please refer to Appendix A.

3.2.6 Test Result of Average Output Power

Please refer to Appendix A.



3.3 Power Spectral Density Measurement

3.3.1 Limit of Power Spectral Density

The peak power spectral density shall not be greater than 8dBm in any 3kHz band at any time interval of continuous transmission.

3.3.2 Measuring Instruments

See list of measuring equipment of this test report.

3.3.3 Test Procedures

Method AVGPSD-3

1. The testing follows the ANSI C63.10 Section 11.10.7 Method AVGPSD-3.
2. The RF output of EUT was connected to the spectrum analyzer by RF cable and attenuator. The path loss was compensated to the results for each measurement.
3. Set to the maximum power setting and enable the EUT transmit continuously.
4. Make the measurement with the spectrum analyzer's resolution bandwidth (RBW) = 10 kHz. Video bandwidth VBW = 30 kHz In order to make an accurate measurement, set the span to 1.5 times DTS Channel Bandwidth. (6dB BW).
5. Number of points in sweep ≥ 2 Span / RBW. (This ensures that bin-to-bin spacing is \leq RBW/2, so that narrowband signals are not lost between frequency bins).
6. Detector = RMS, Sweep time = auto couple.
7. Trace mode = max hold.
8. Allow max hold to run for at least 60 seconds, or longer as needed to allow the trace to stabilize.
9. Measure and record the results in the test report.
10. For MIMO mode, calculation method follows FCC KDB 662911 D01 Multiple Transmitter Output v02r01.

Method (c): Measure and add $10 \log(N_{ANT})$ dB.

With this technique, spectrum measurements are performed at each output of the device, but rather than summing the spectra or the spectral peaks across the outputs, the quantity $10 \log(N_{ANT})$ dB is added to each spectrum value before comparing to the emission limit. The addition of $10 \log(N_{ANT})$ dB serves to apportion the emission limit among the N_{ANT} outputs so that each output is permitted to contribute no more than $1/N_{ANT}^{th}$ of the PSD limit .

3.3.4 Test Setup

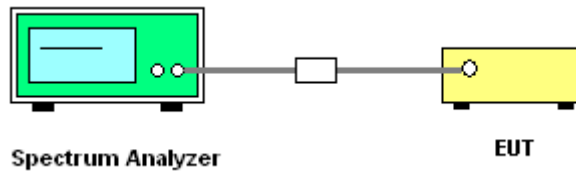



3.3.5 Test Result of Power Spectral Density

Please refer to Appendix A.

<CDD Modes>

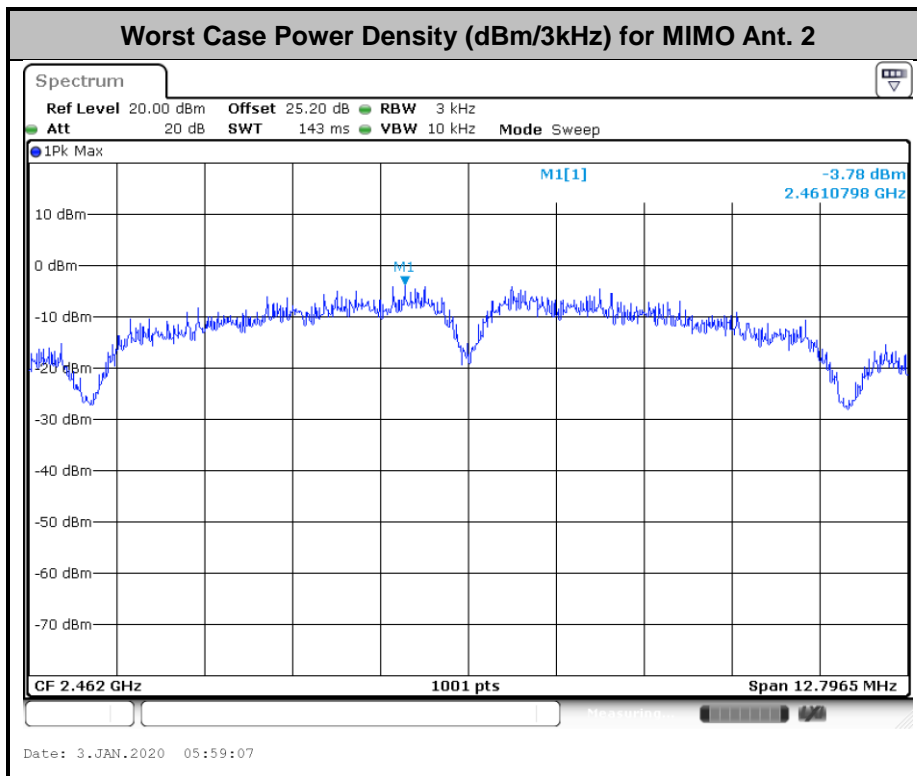
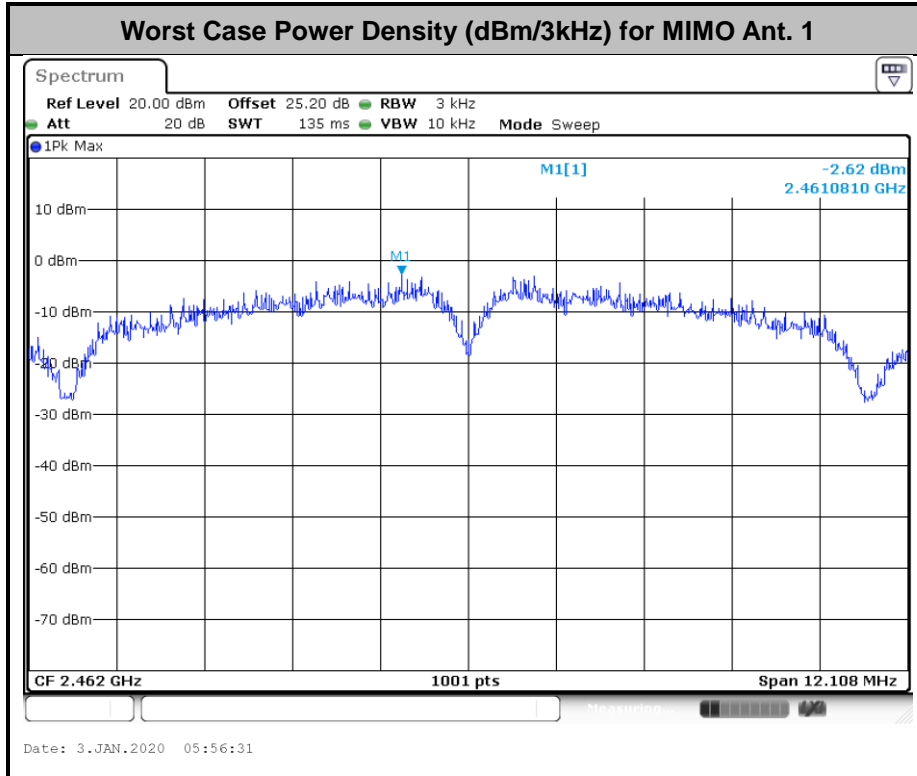



<TXBF Modes>

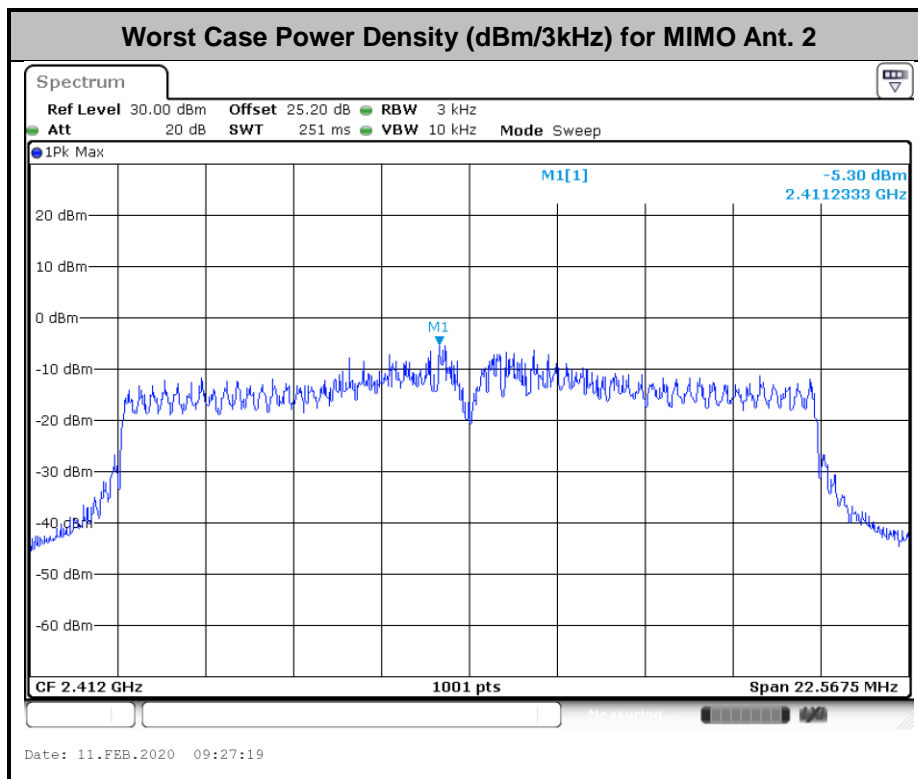
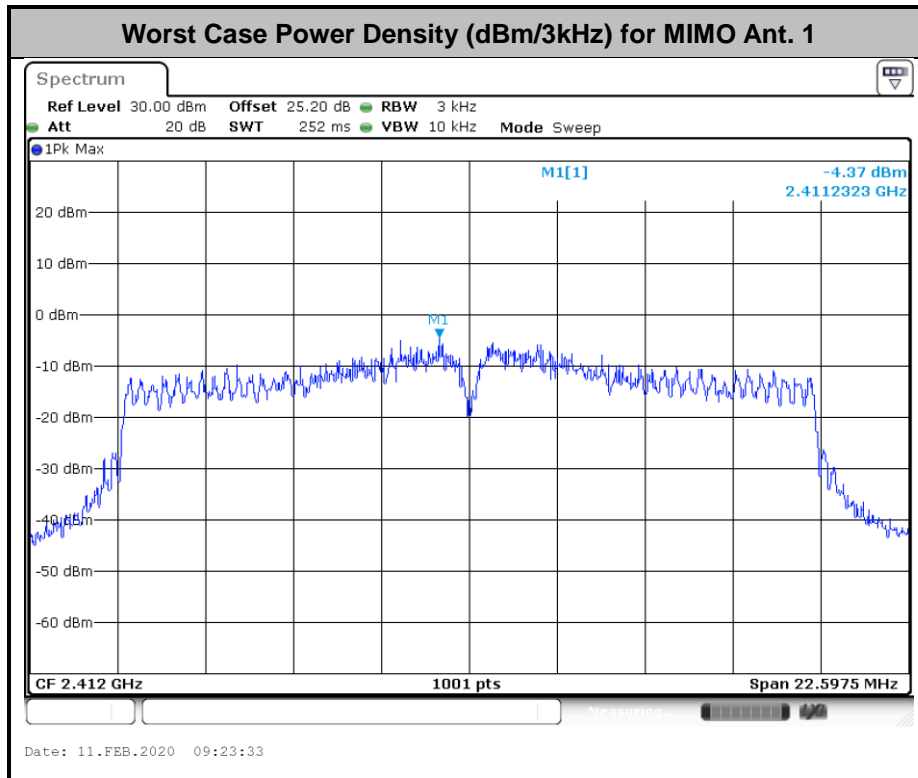

3.4 Conducted Band Edges and Spurious Emission Measurement

3.4.1 Limit of Conducted Band Edges and Spurious Emission Measurement

In any 100 kHz bandwidth outside of the authorized frequency band, the emissions which fall in the non-restricted bands shall be attenuated at least 20 dB / 30dB relative to the maximum PSD level in 100 kHz by RF conducted measurement.

3.4.2 Measuring Instruments

See list of measuring equipment of this test report.

3.4.3 Test Procedures

1. The testing follows the ANSI C63.10 Section 11.11.3 Emission level measurement
2. The RF output of EUT was connected to the spectrum analyzer by RF cable and attenuator. The path loss was compensated to the results for each measurement.
3. Set to the maximum power setting and enable the EUT transmit continuously.
4. Set RBW = 100 kHz, VBW=300 kHz, Peak Detector. Unwanted Emissions measured in any 100 kHz bandwidth outside of the authorized frequency band shall be attenuated by at least 20 dB relative to the maximum in-band peak PSD level in 100 kHz when maximum peak conducted output power procedure is used. If the transmitter complies with the conducted power limits based on the use of RMS averaging over a time interval, the attenuation required under this paragraph shall be 30 dB instead of 20 dB per 15.247(d).
5. Measure and record the results in the test report.
6. The RF fundamental frequency should be excluded against the limit line in the operating frequency band.

3.4.4 Test Setup

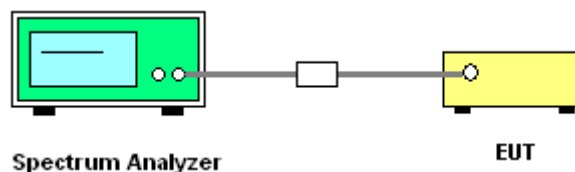



3.4.5 Test Result of Conducted Band Edges and Spurious Emission

Test Engineer : Luffy Lin / Richard Qiu	Temperature :	21~25°C
	Relative Humidity :	51~54%

<CDD Modes>

Number of TX = 2, Ant. 1 (Measured)

Test Mode :	802.11b	Test Channel :	01
-------------	---------	----------------	----

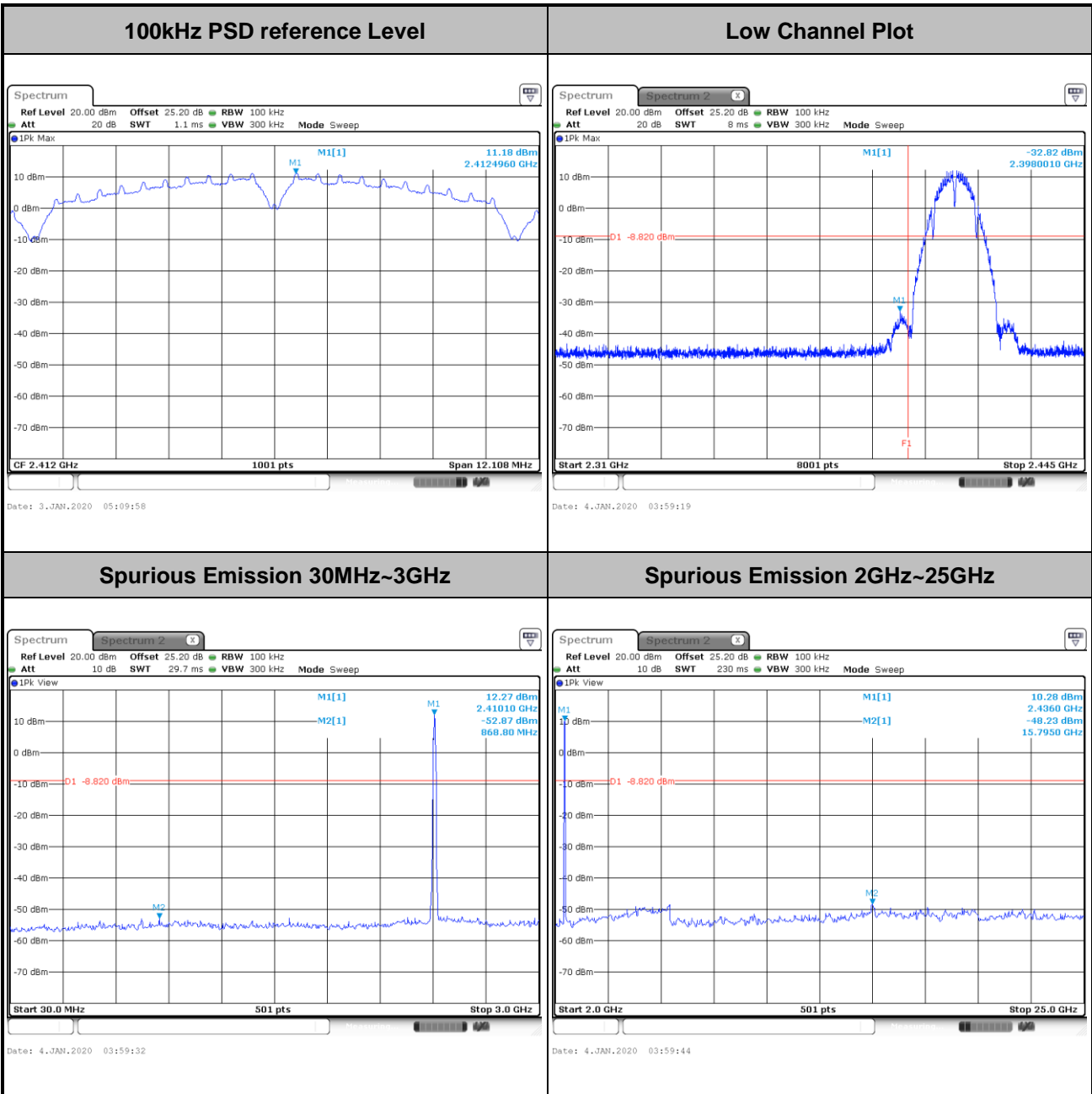



Test Mode :	802.11b	Test Channel :	06
-------------	---------	----------------	----

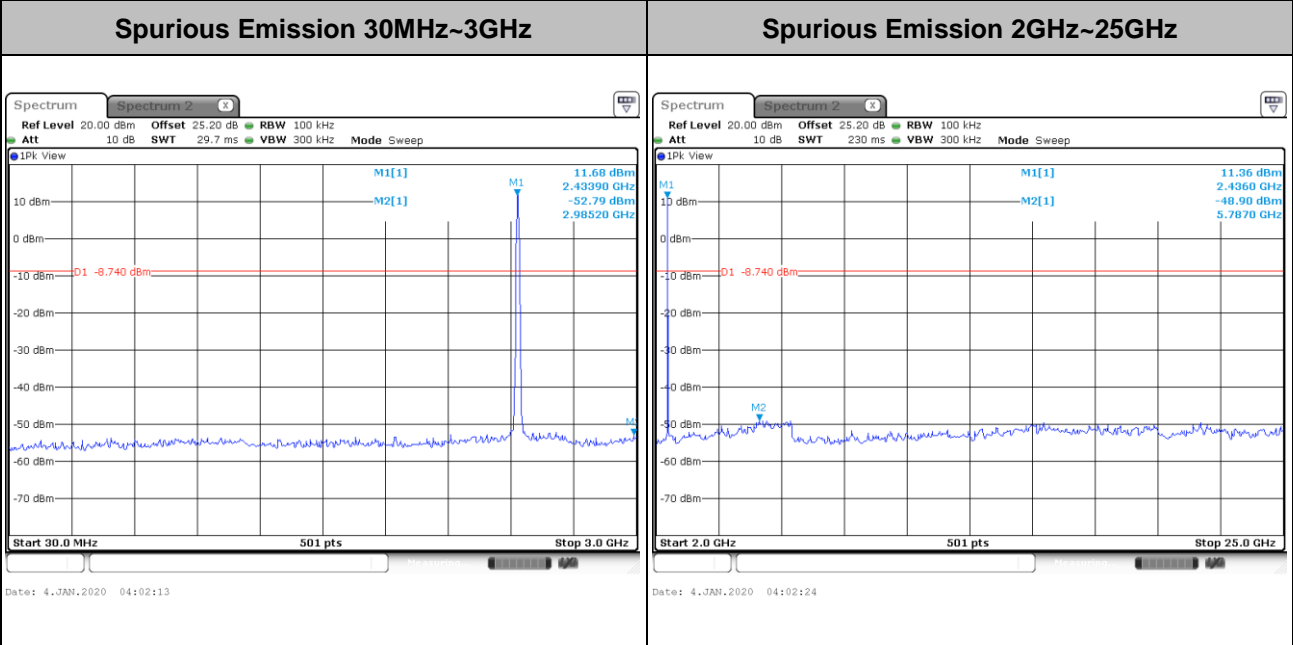
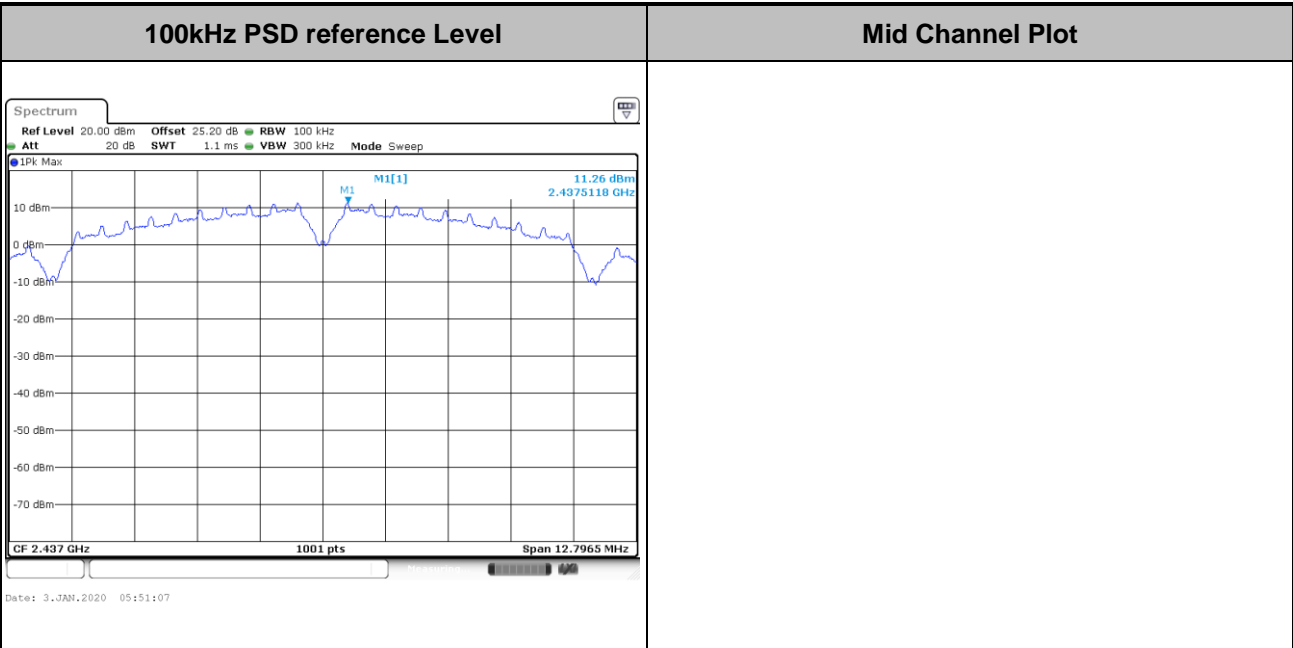



Test Mode :	802.11b	Test Channel :	11
-------------	---------	----------------	----

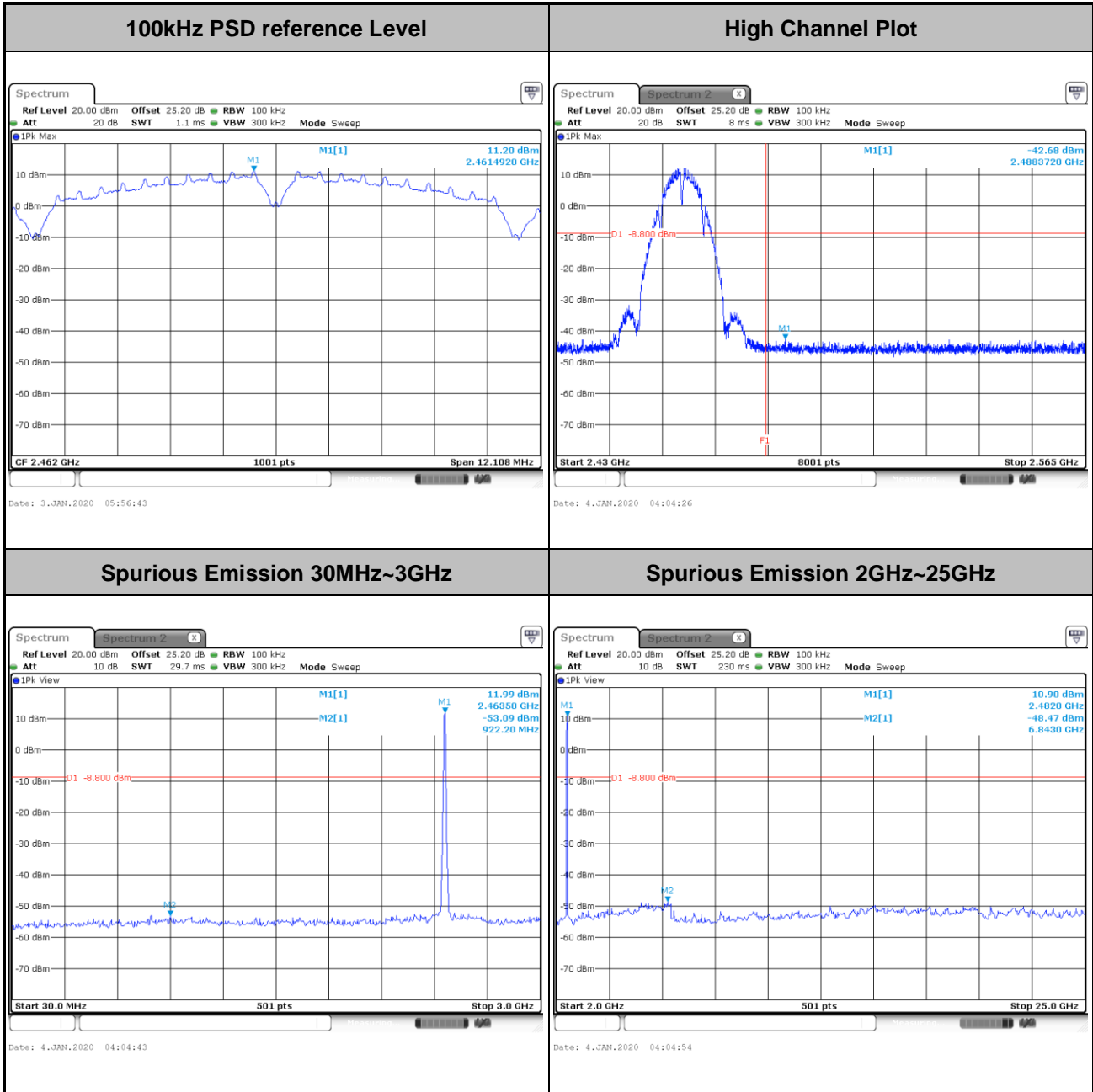



Test Mode :	802.11g	Test Channel :	01
-------------	---------	----------------	----

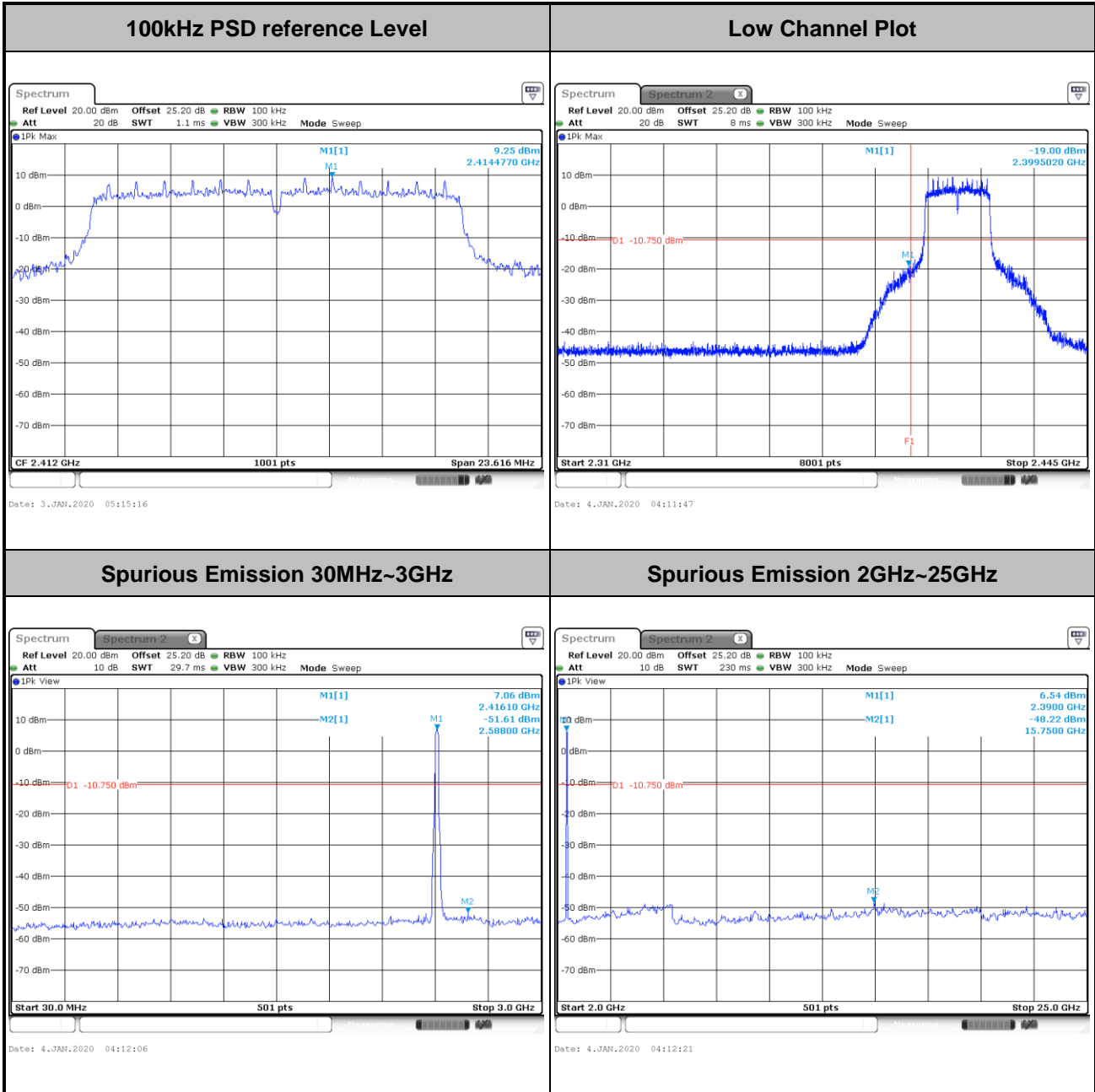



Test Mode :	802.11g	Test Channel :	06
-------------	---------	----------------	----

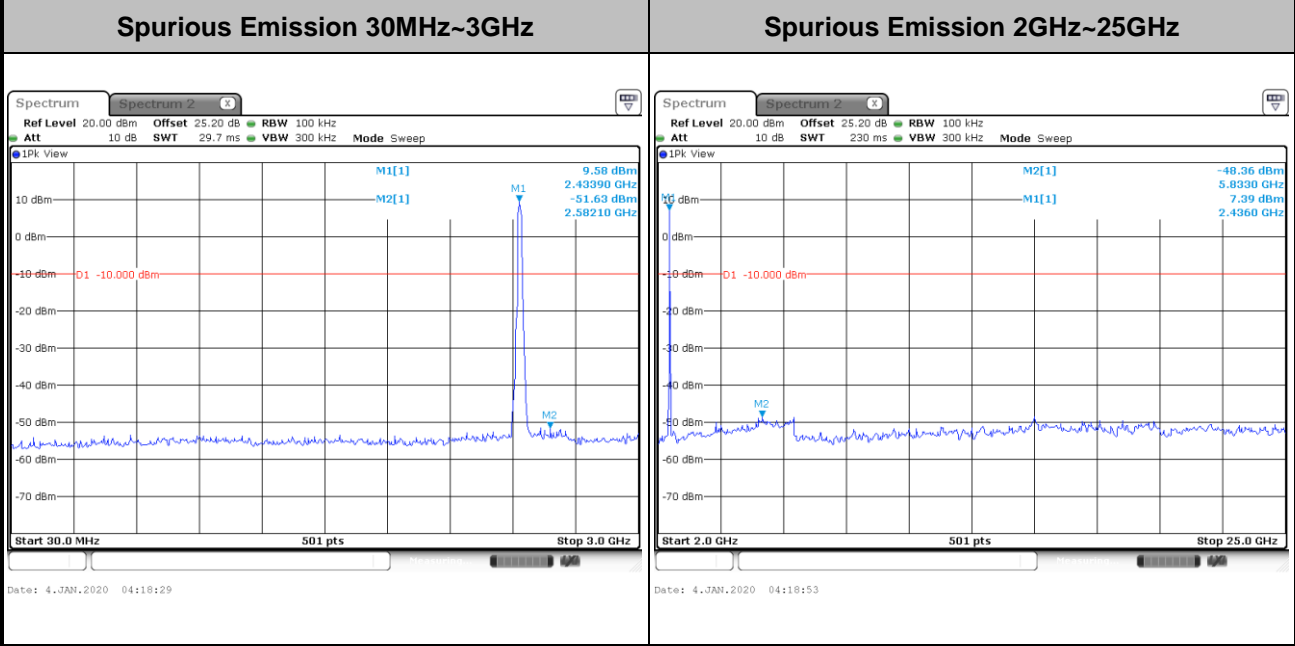
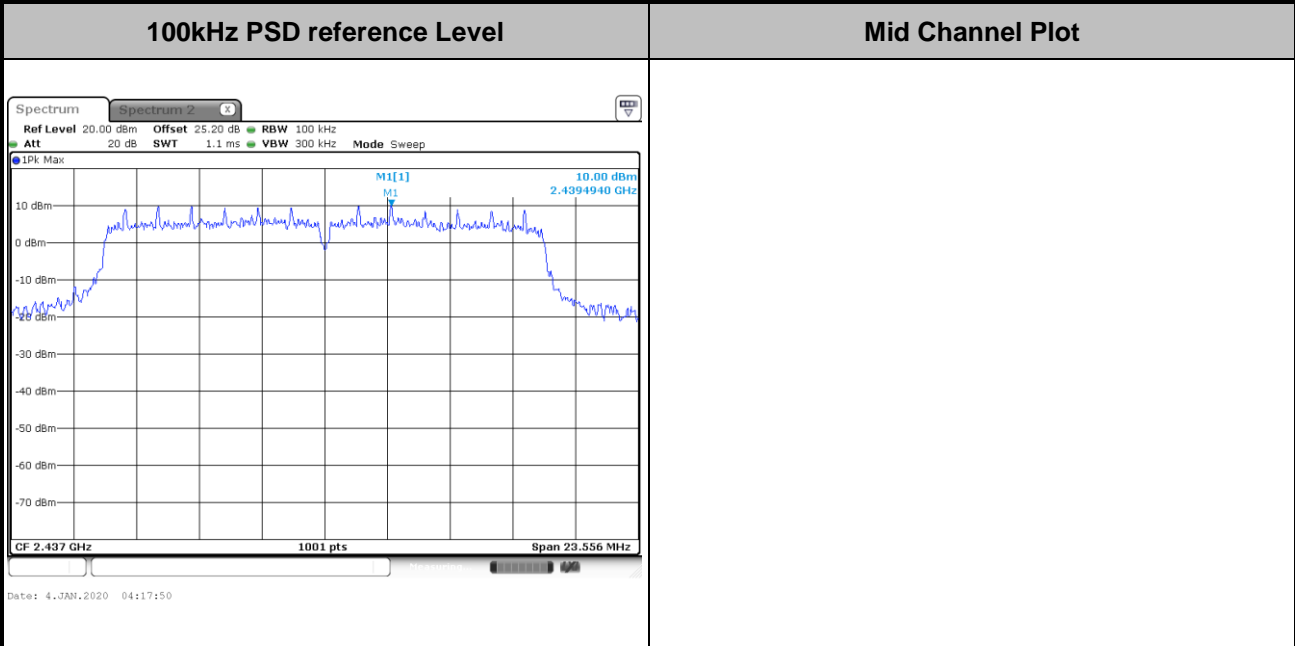



Test Mode :	802.11g	Test Channel :	11
-------------	---------	----------------	----

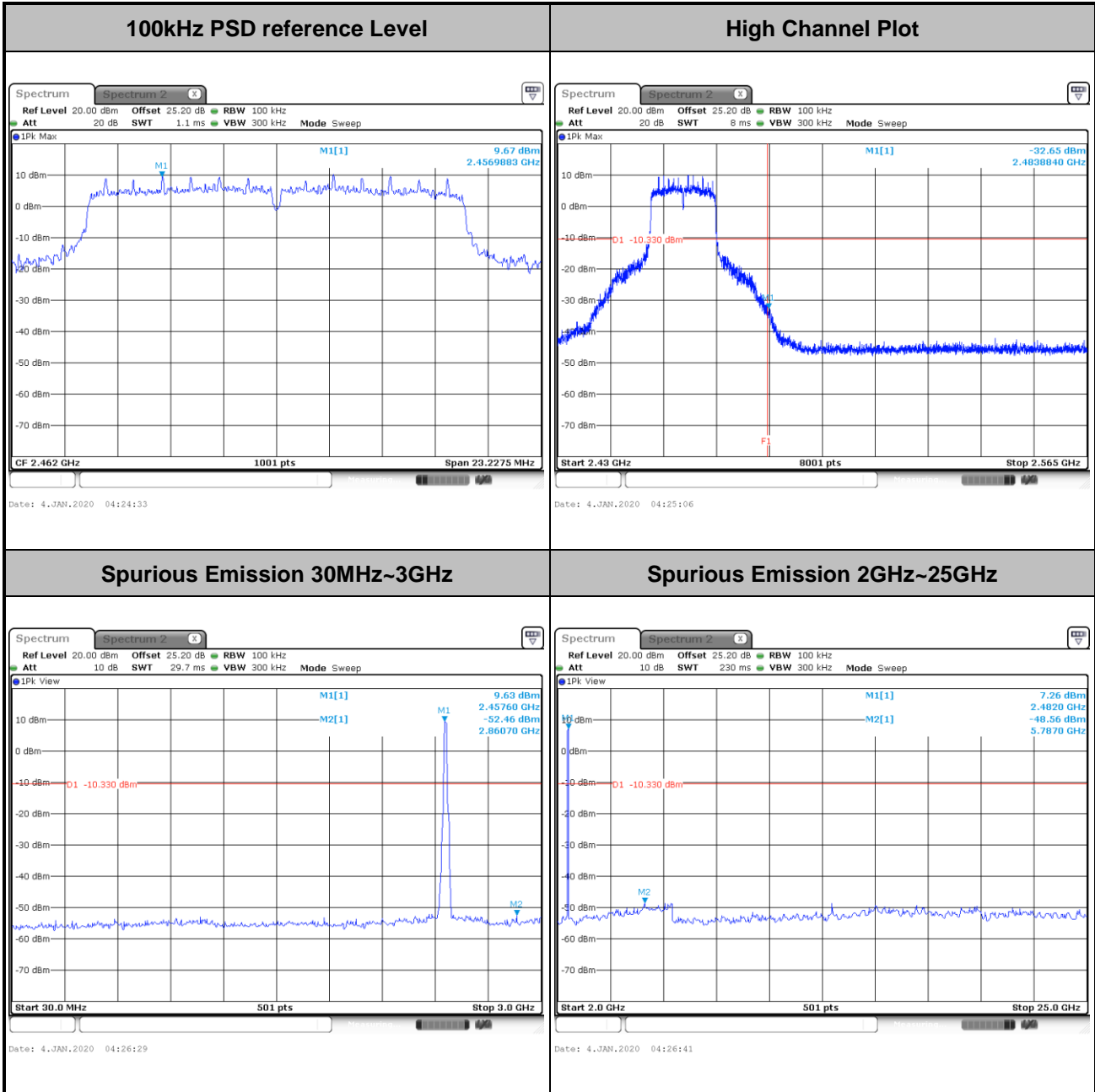



Test Mode :	802.11n HT20	Test Channel :	01
-------------	--------------	----------------	----

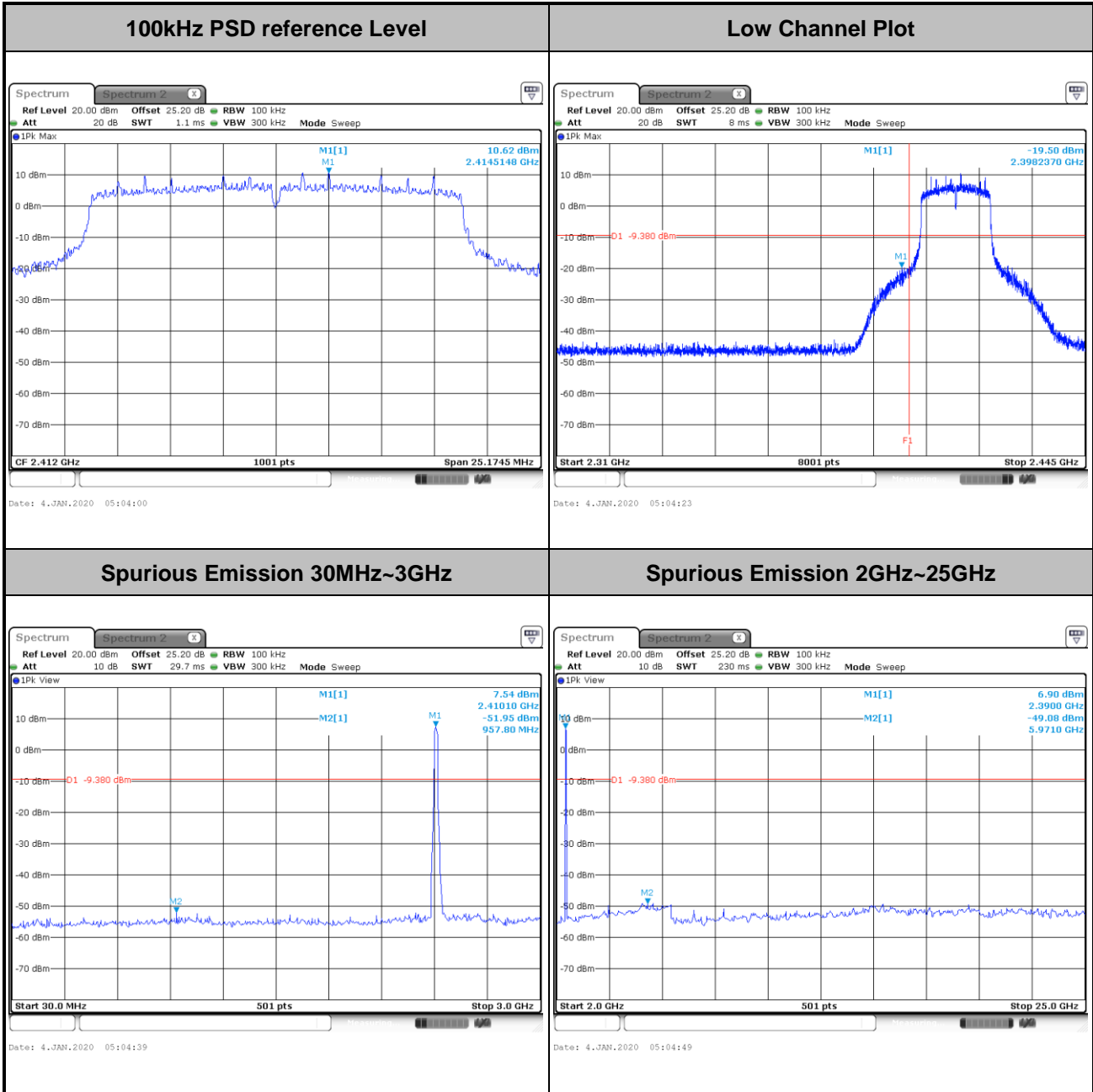



Test Mode :	802.11n HT20	Test Channel :	06
-------------	--------------	----------------	----

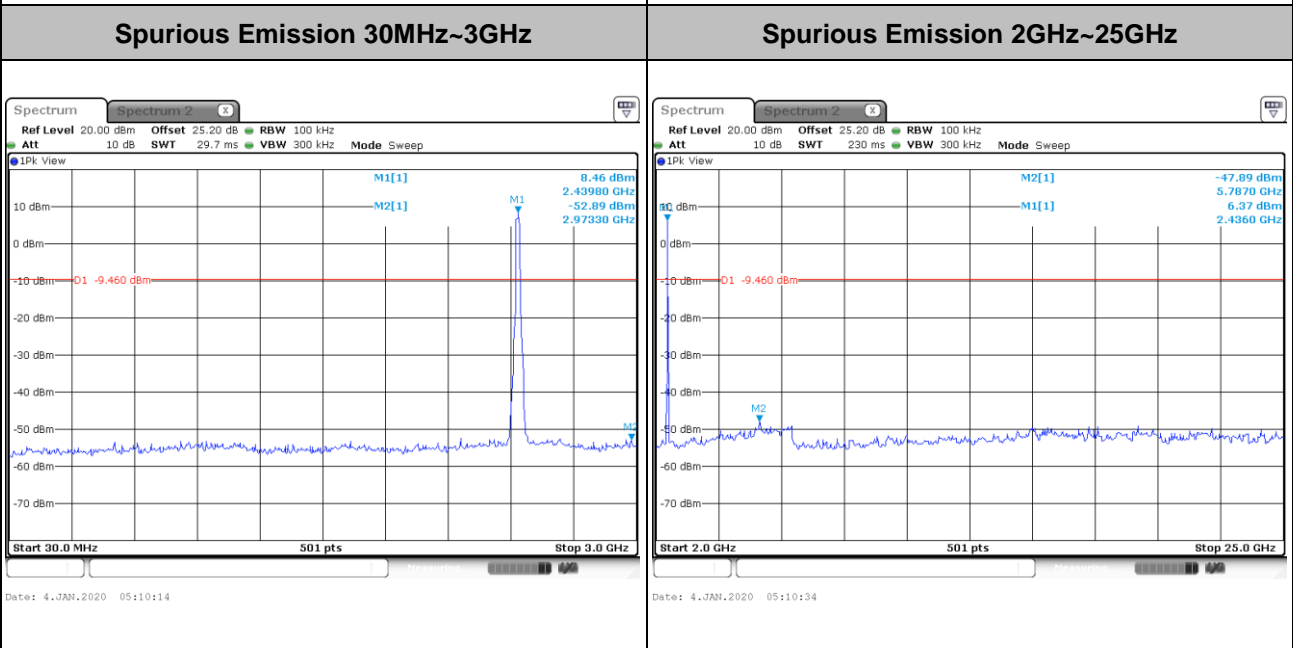
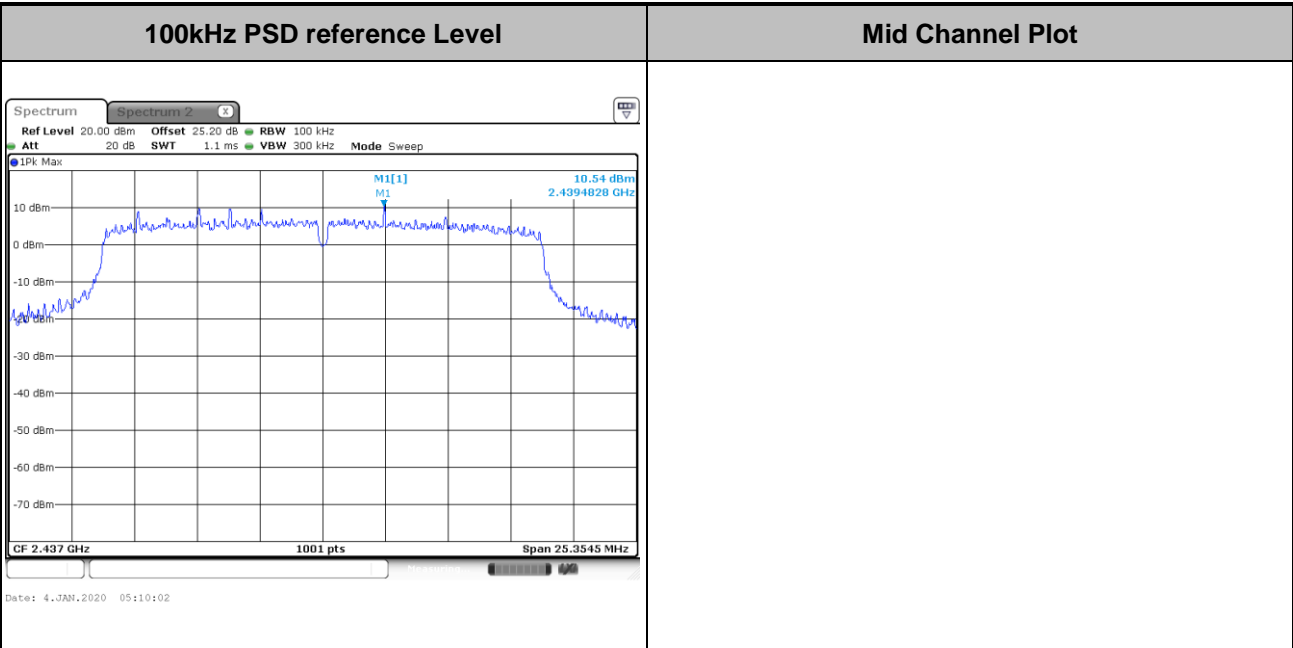



Test Mode :	802.11n HT20	Test Channel :	11
-------------	--------------	----------------	----

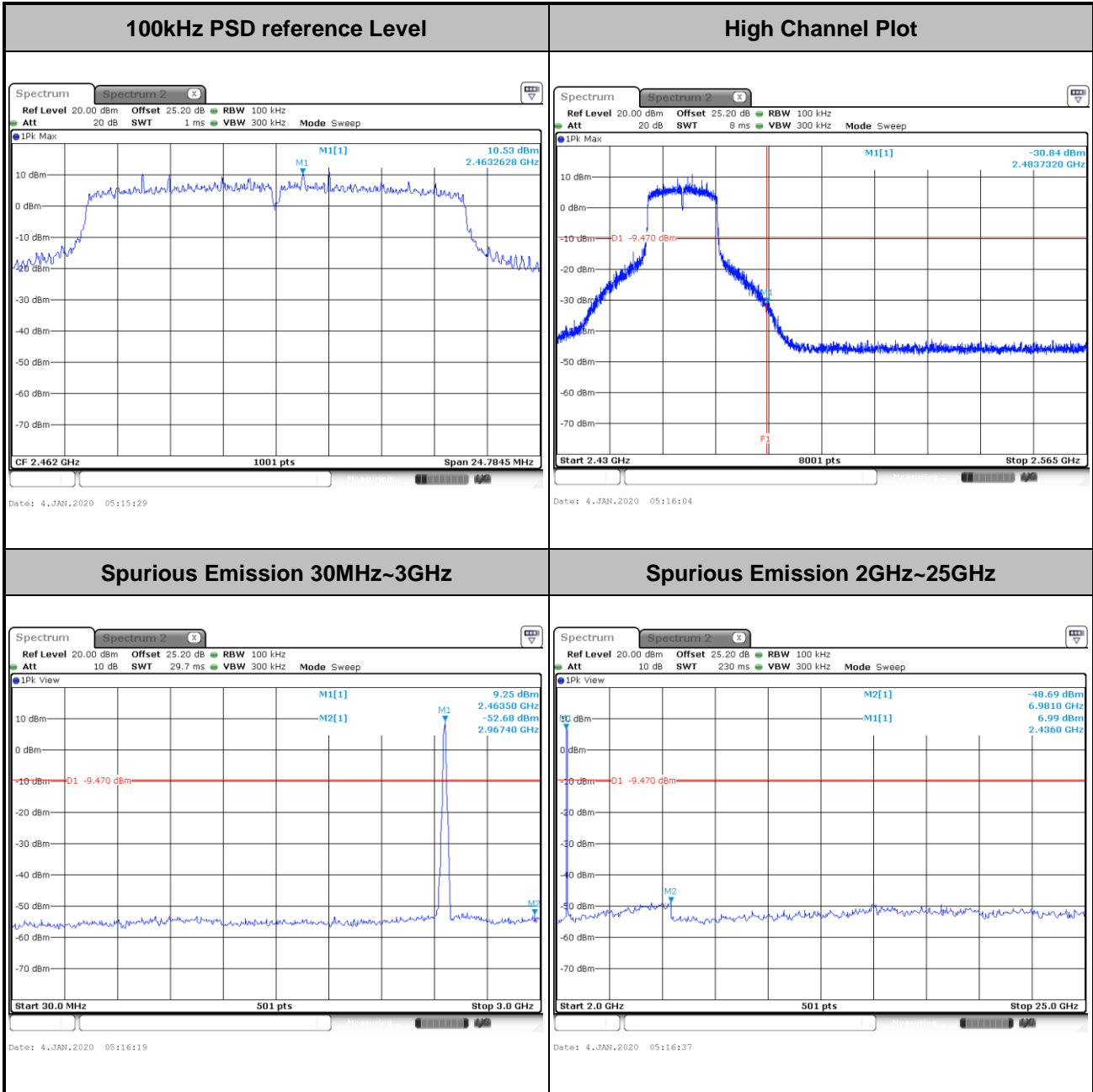



Test Mode :	802.11ax HE20	Test Channel :	01 Full RU
-------------	---------------	----------------	------------

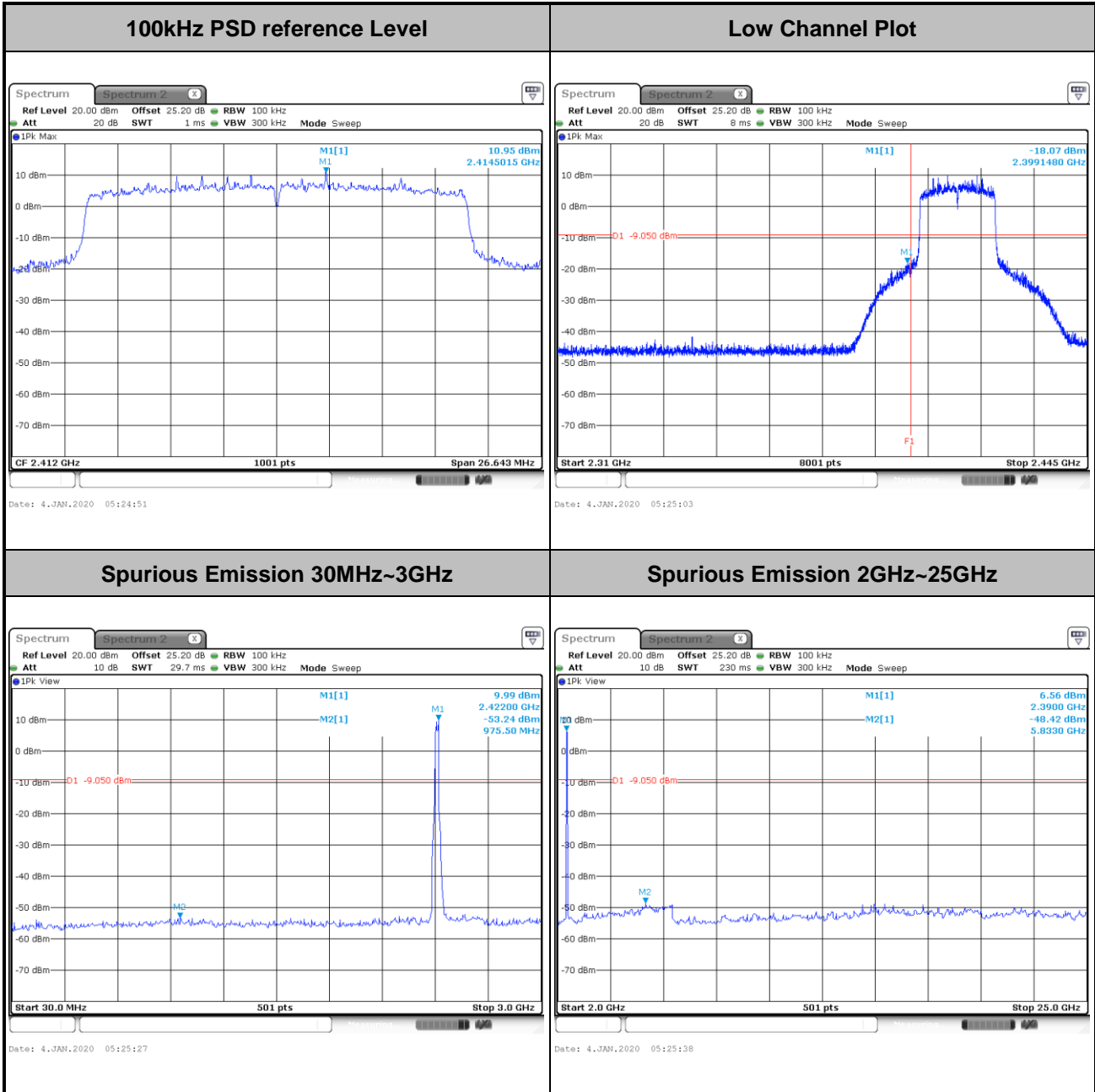



Test Mode :	802.11ax HE20	Test Channel :	01 Partial RU 26/0
--------------------	---------------	-----------------------	--------------------

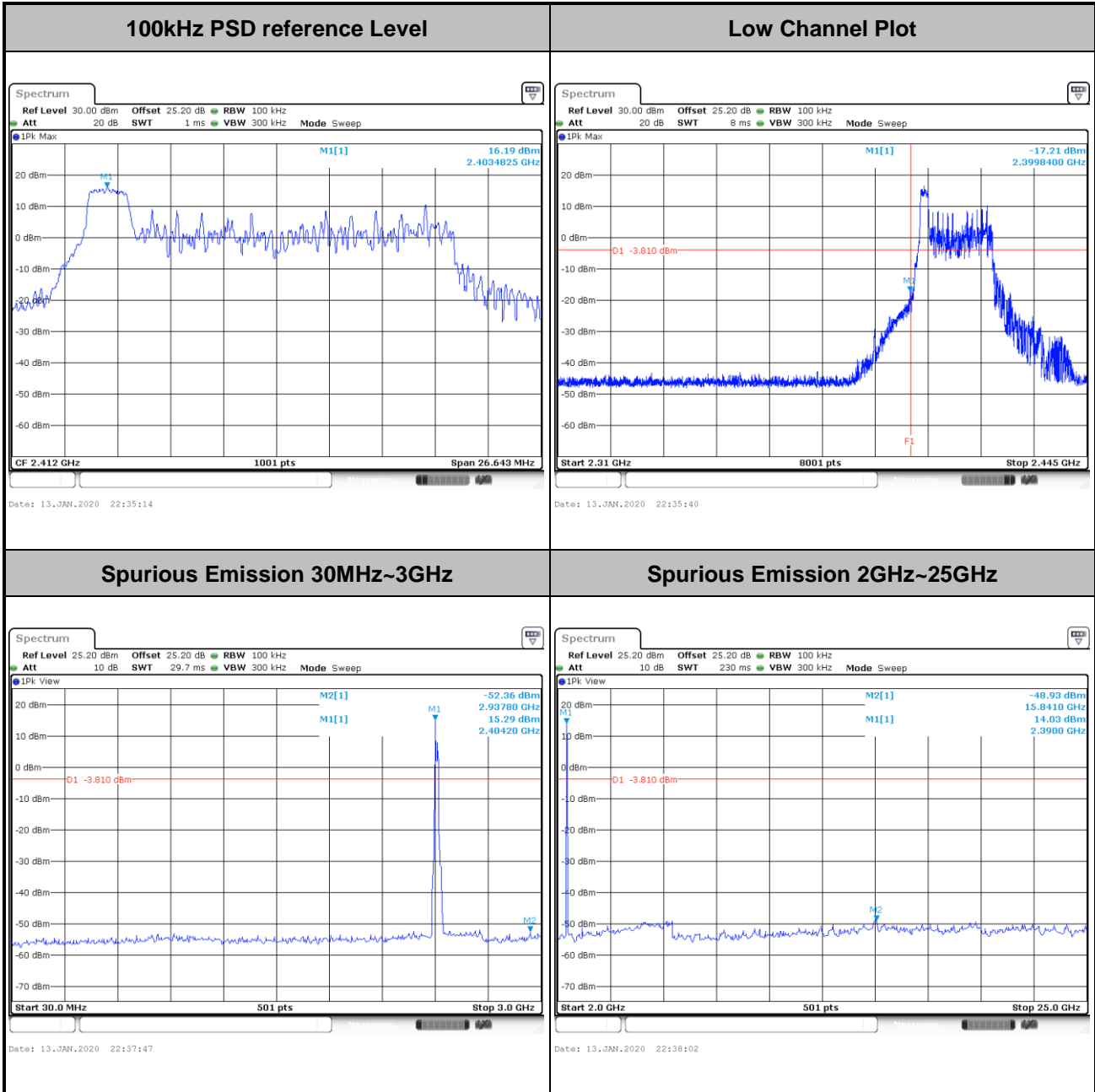



Test Mode :	802.11ax HE20	Test Channel :	01 Partial RU 52/37
-------------	---------------	----------------	---------------------

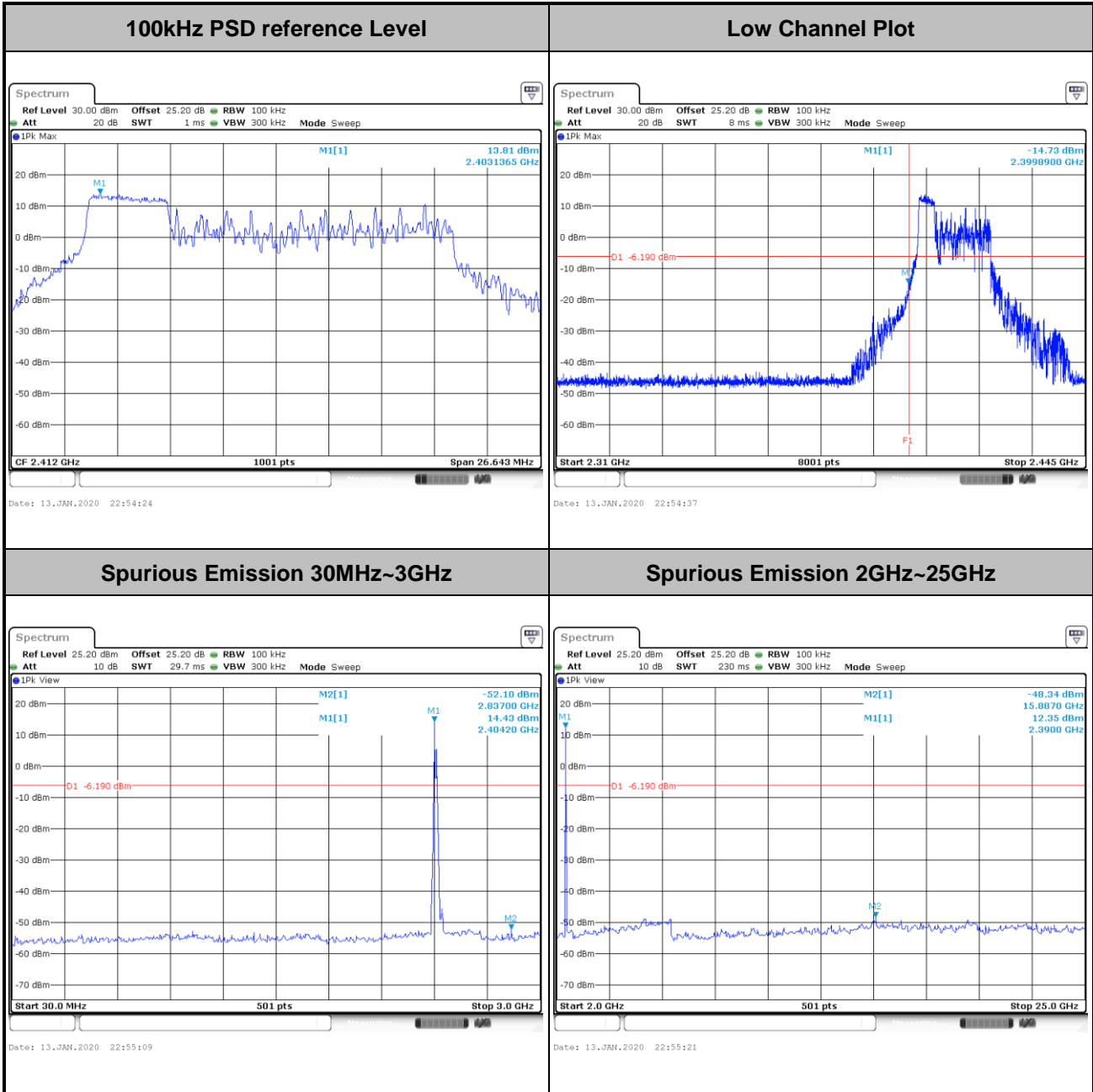



Test Mode :	802.11ax HE20	Test Channel :	01 Partial RU 106/53
-------------	---------------	----------------	----------------------

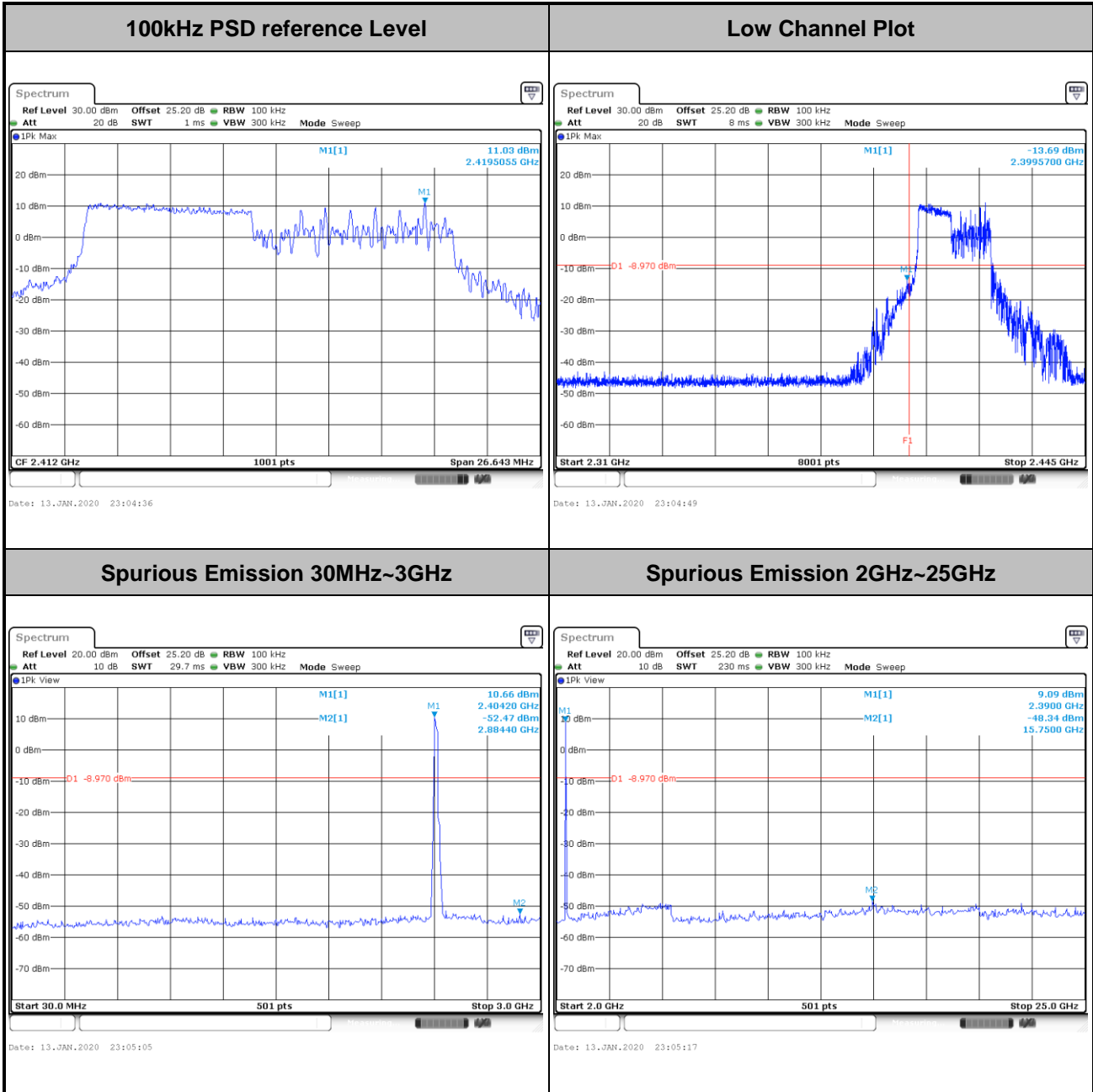



Test Mode :	802.11ax HE20	Test Channel :	06 Full RU
--------------------	---------------	-----------------------	------------

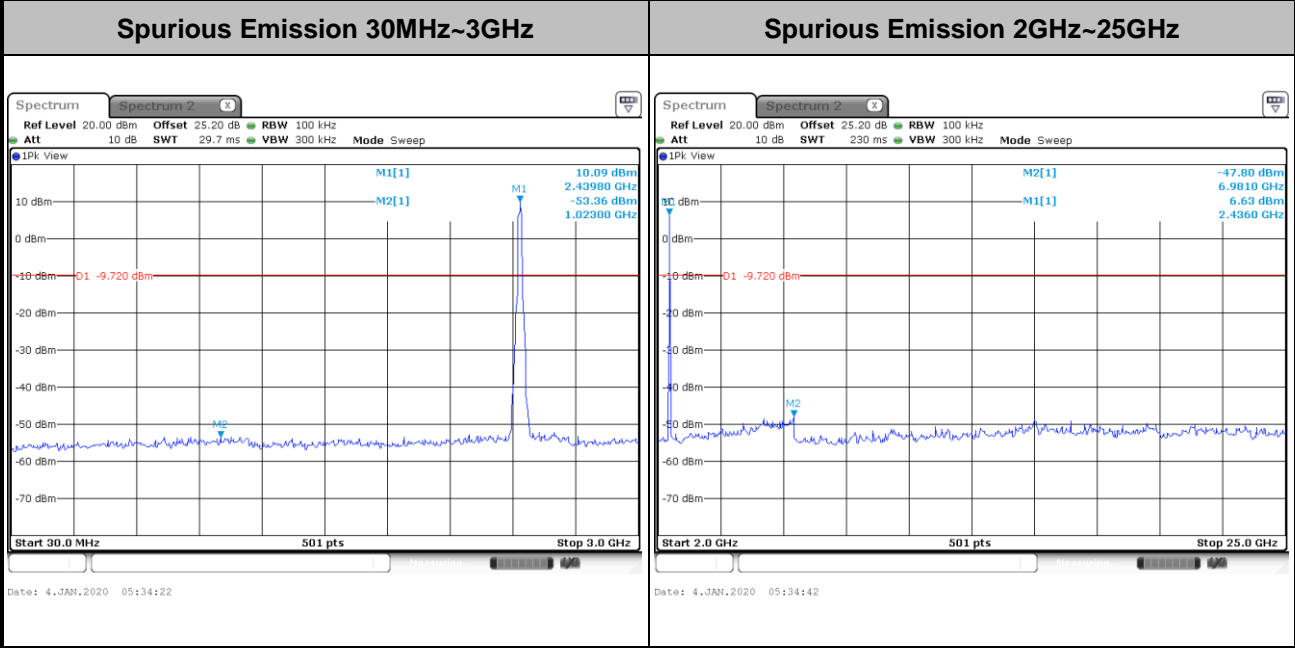
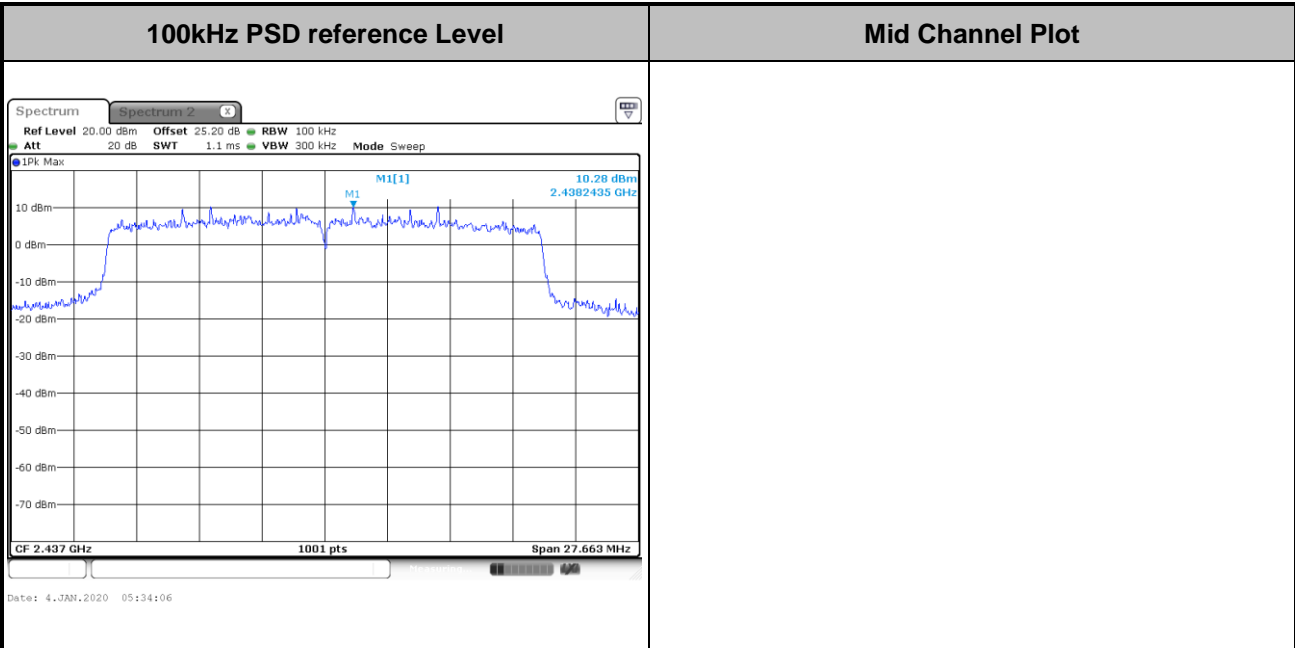



Test Mode :	802.11ax HE20	Test Channel :	11 Full RU
-------------	---------------	----------------	------------

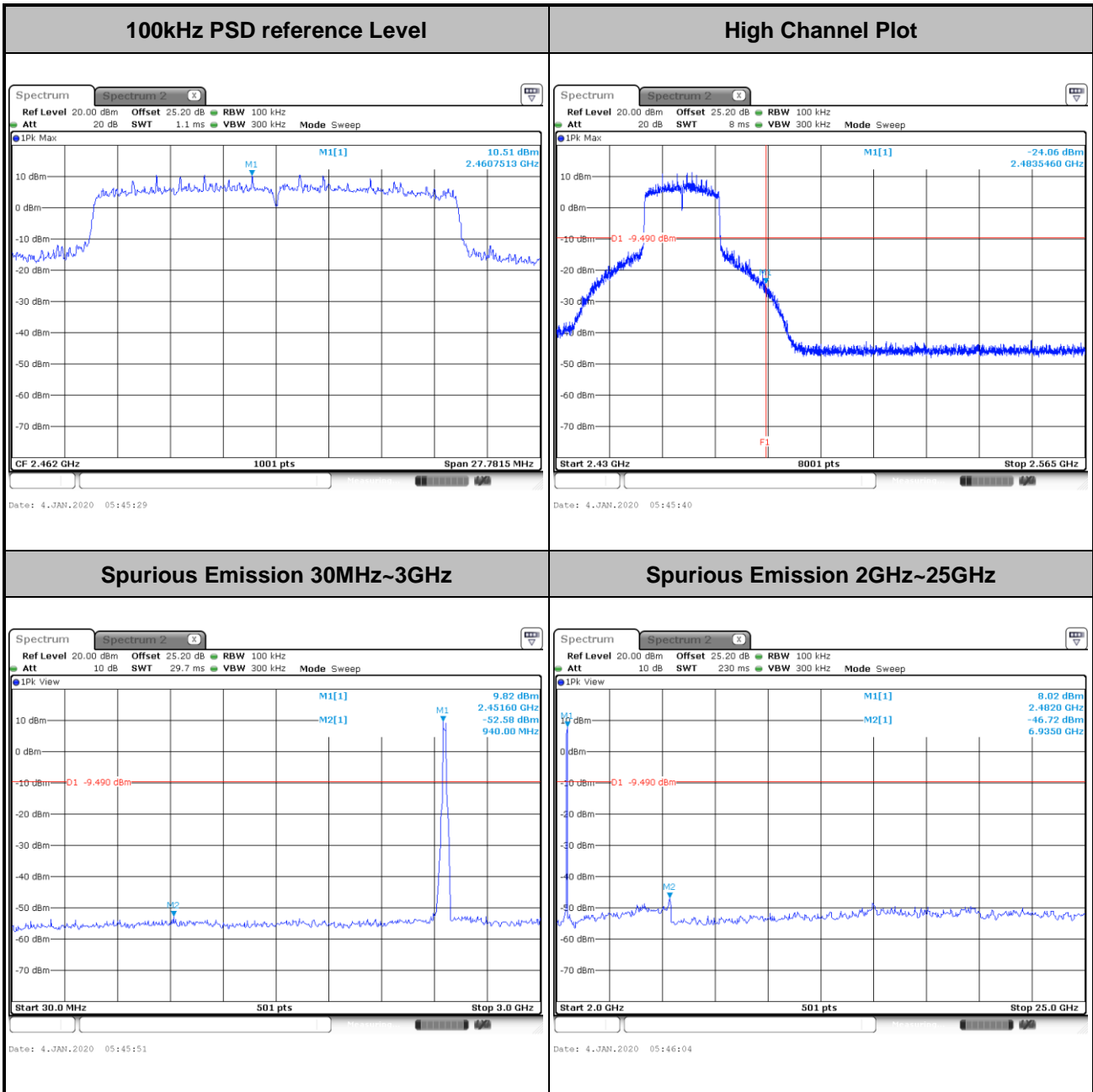



Test Mode :	802.11ax HE20	Test Channel :	11 Partial RU 26/8
--------------------	---------------	-----------------------	--------------------

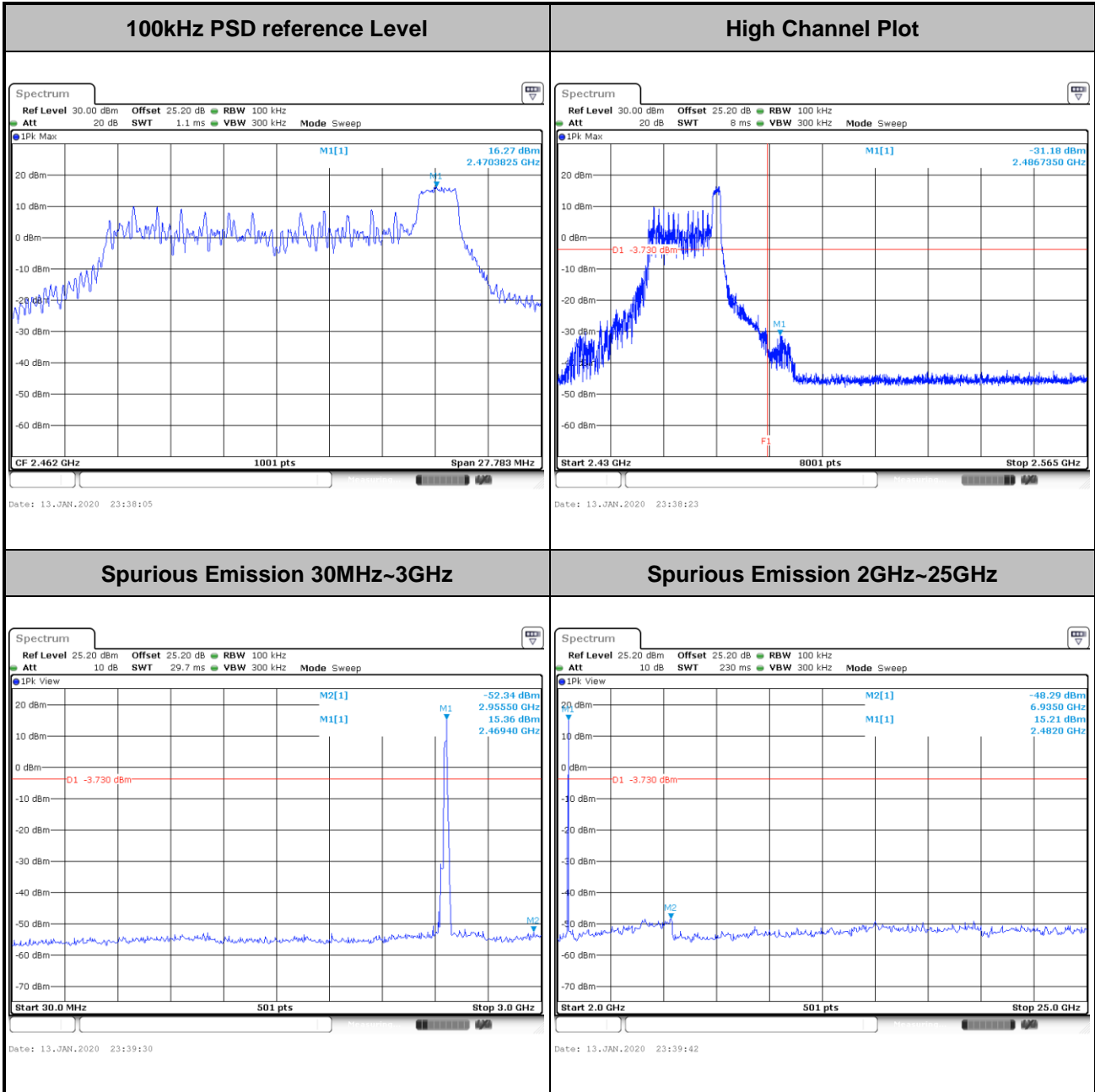



Test Mode :	802.11ax HE20	Test Channel :	11 Partial RU 52/40
--------------------	---------------	-----------------------	---------------------

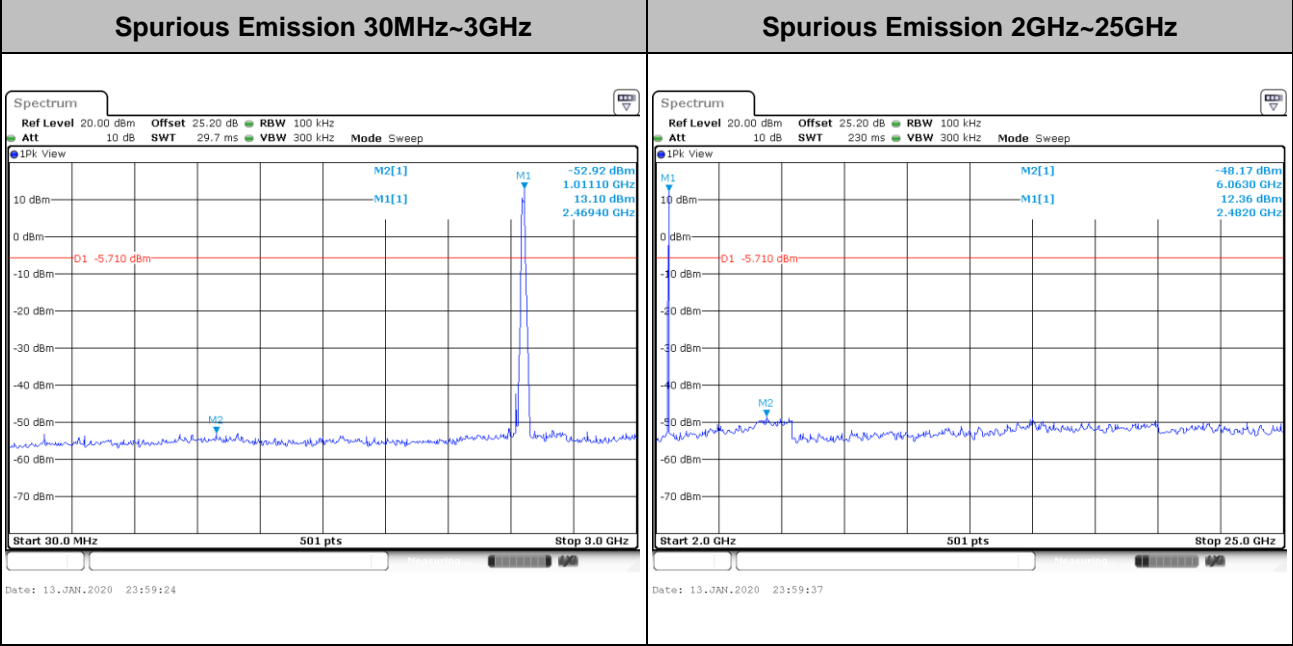
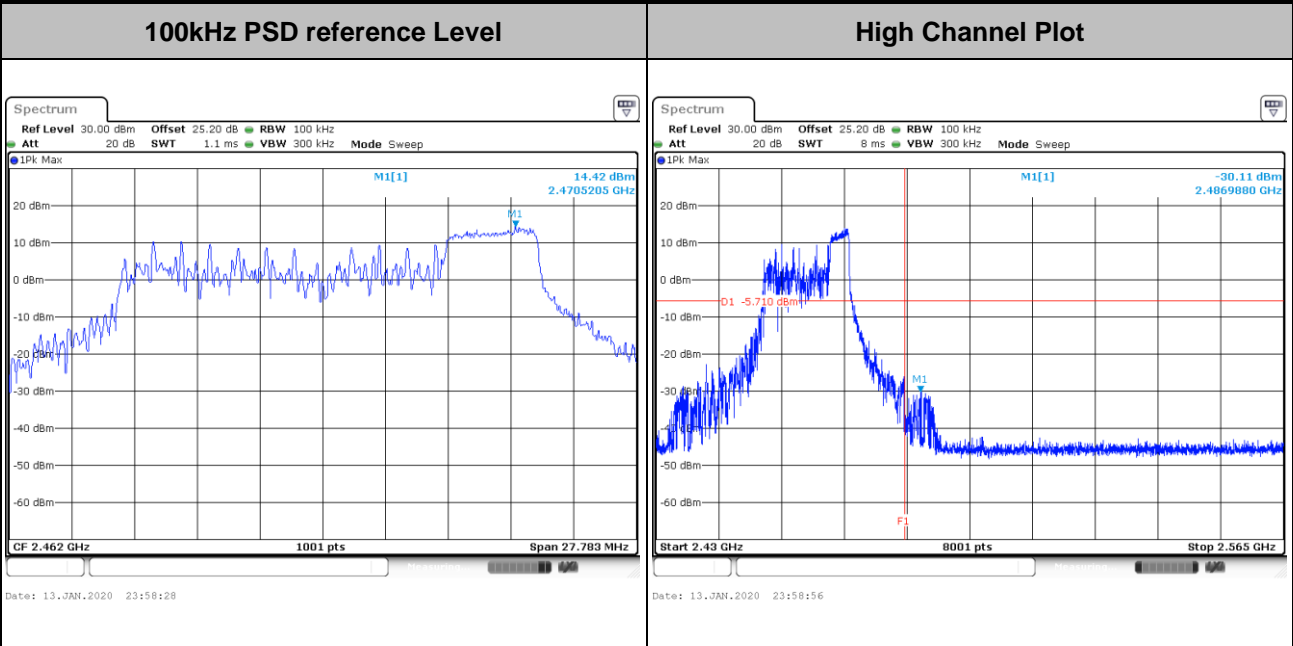



Test Mode :	802.11ax HE20	Test Channel :	11 Partial RU 106/54
--------------------	---------------	-----------------------	----------------------

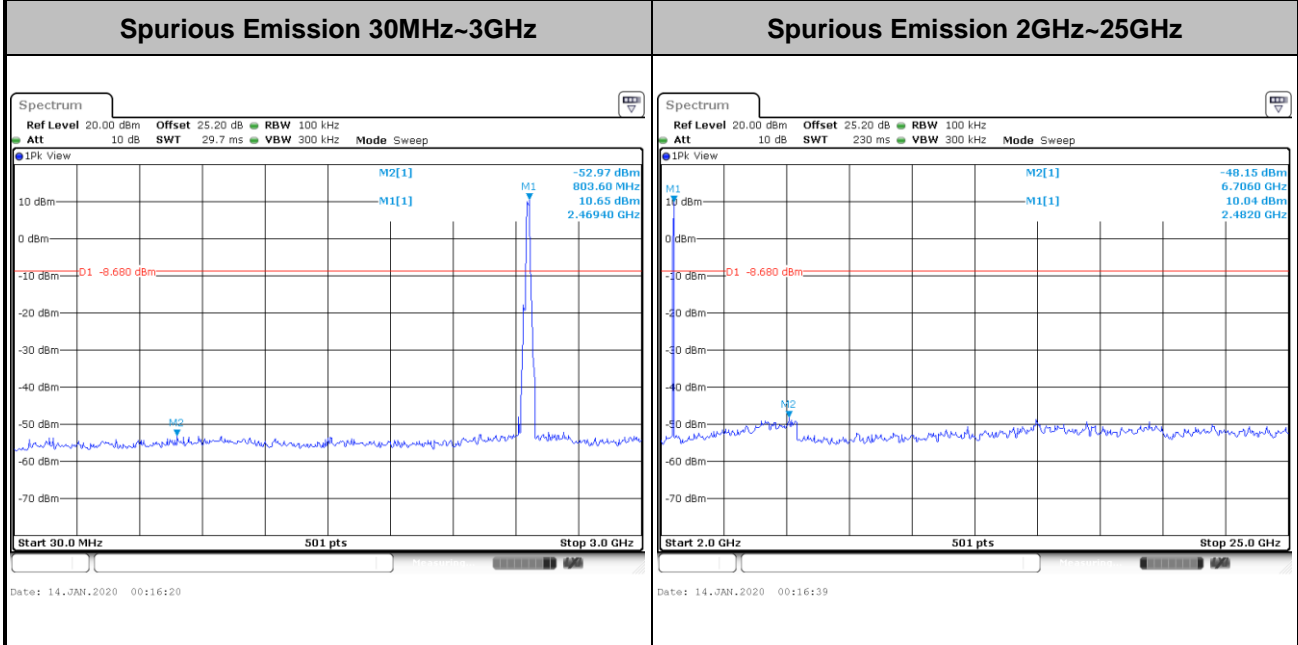
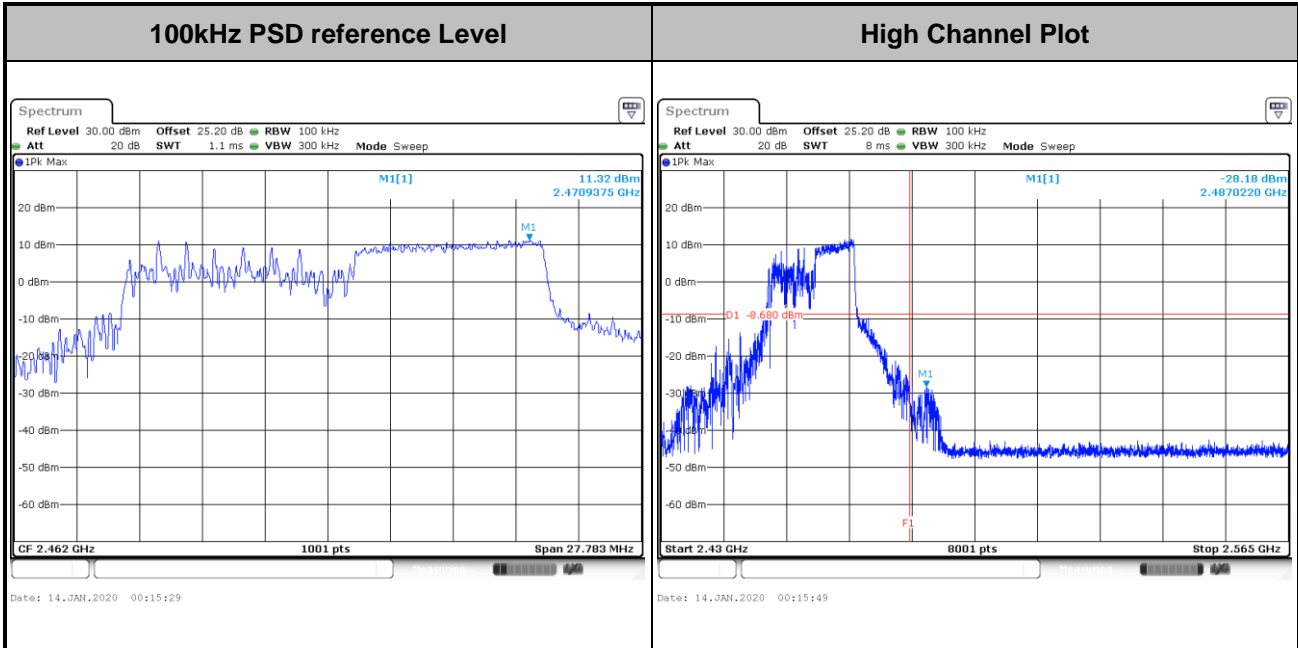



Test Mode :	802.11ax HE40	Test Channel :	03 Full RU
--------------------	---------------	-----------------------	------------

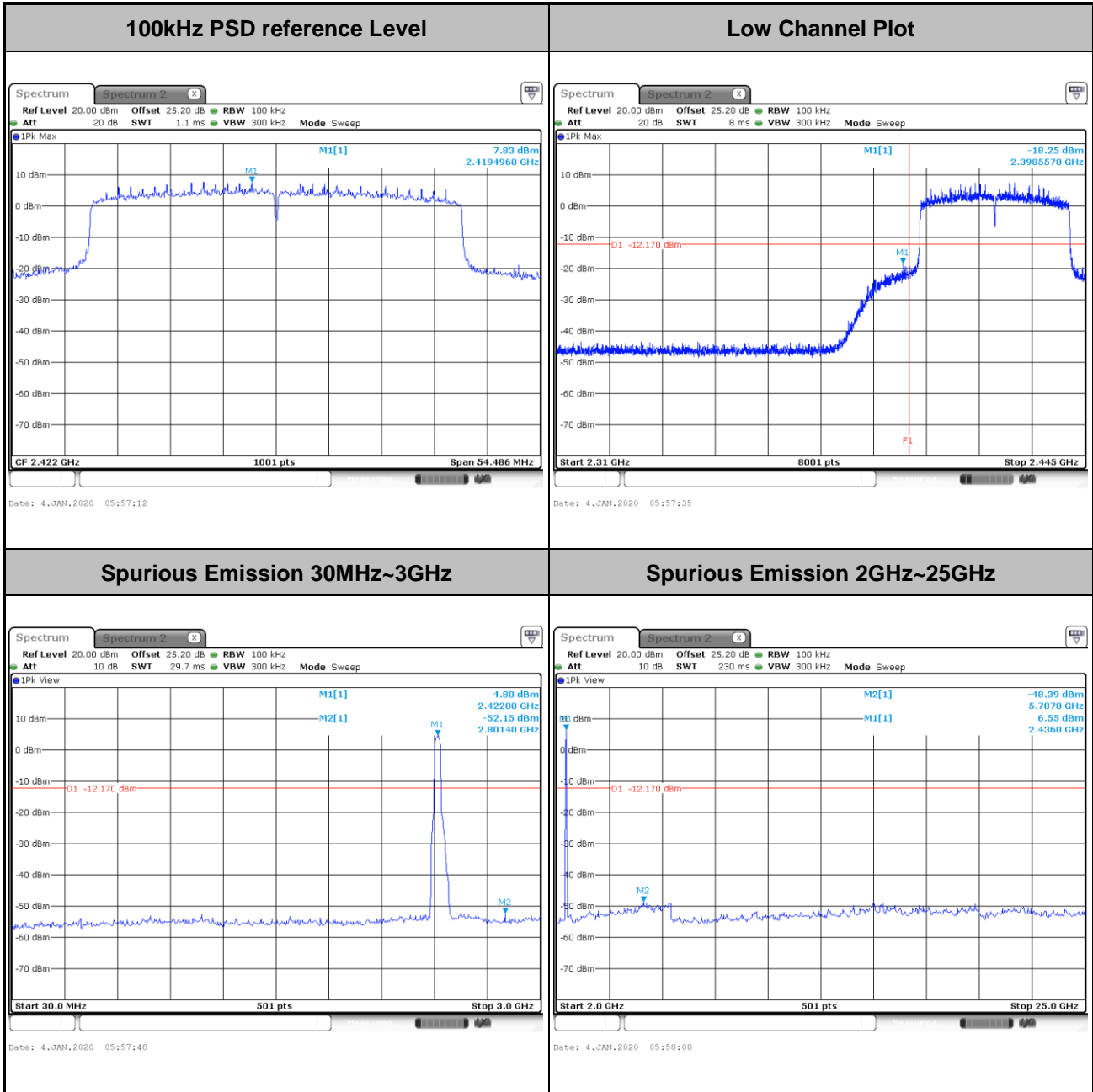



Test Mode :	802.11ax HE40	Test Channel :	03 Partial RU 242/61
--------------------	---------------	-----------------------	----------------------

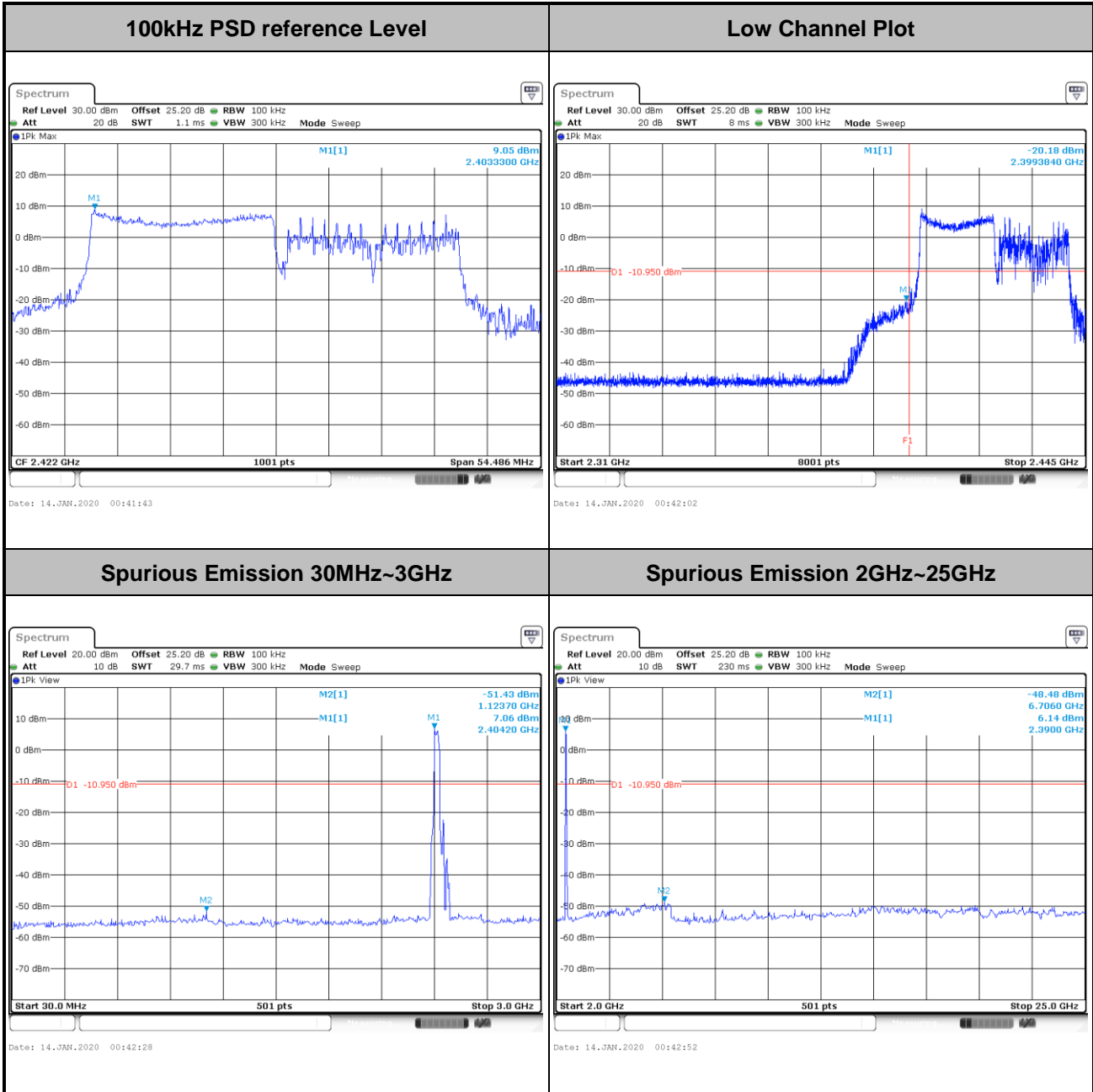



Test Mode :	802.11ax HE40	Test Channel :	06 Full RU
--------------------	---------------	-----------------------	------------

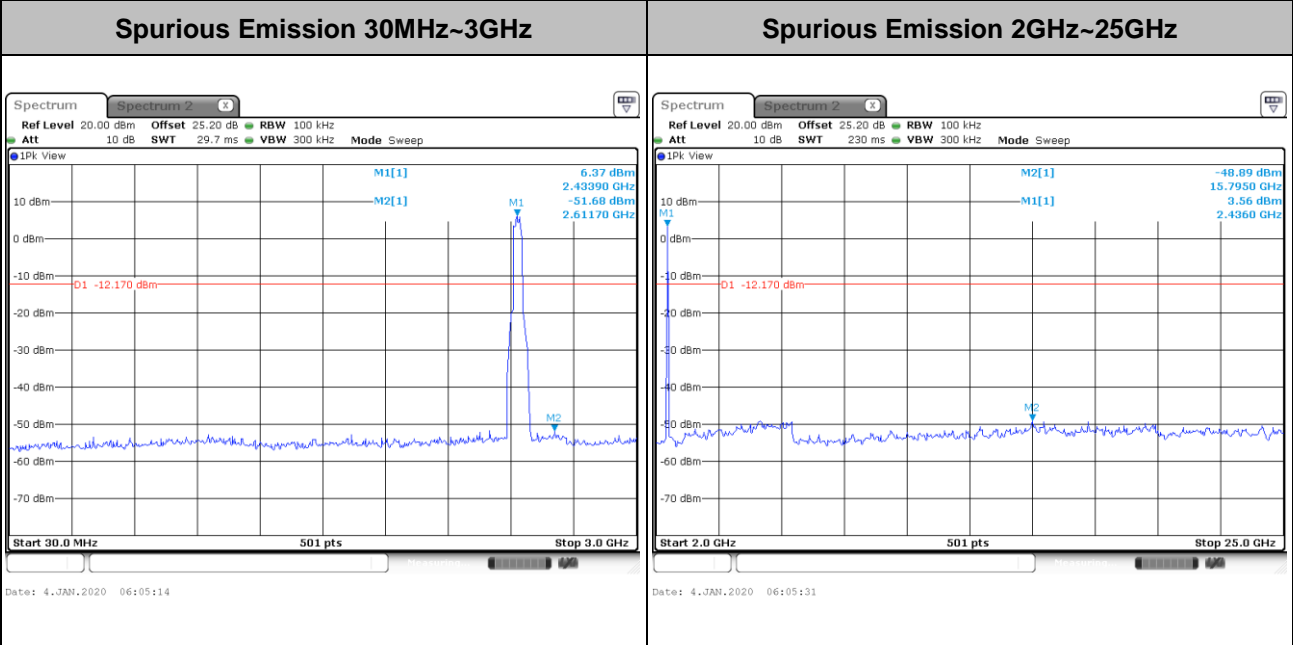
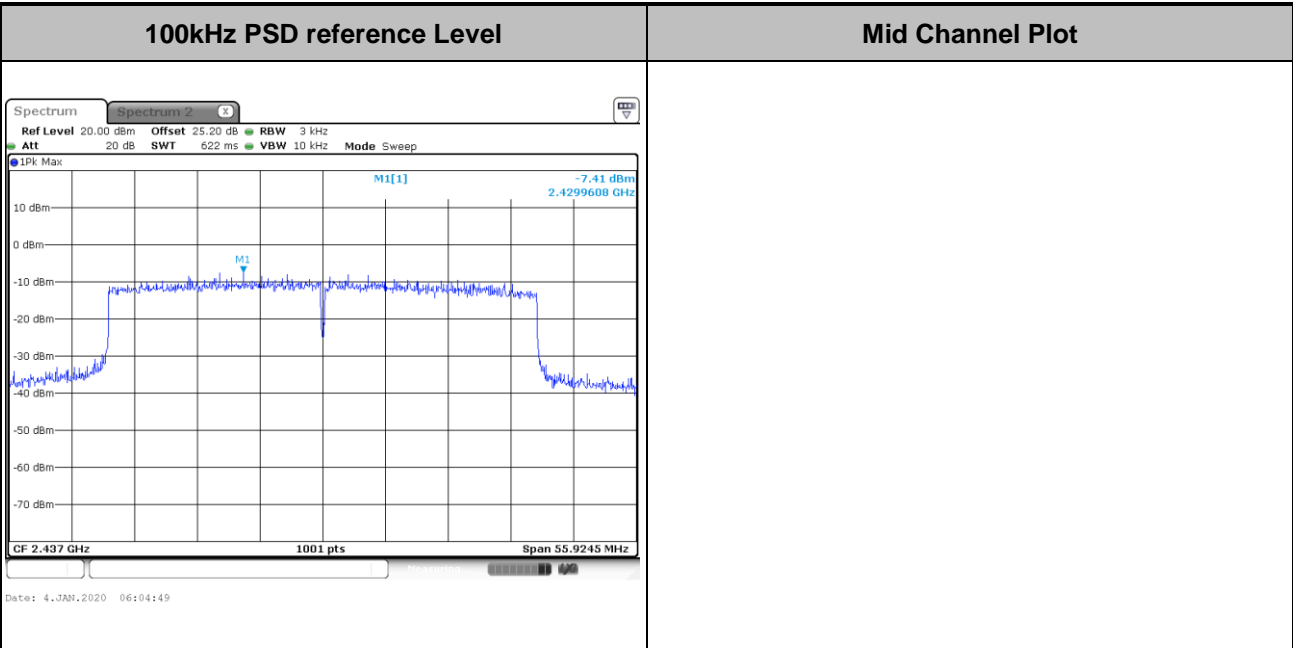



Test Mode :	802.11ax HE40	Test Channel :	09 Full RU
-------------	---------------	----------------	------------

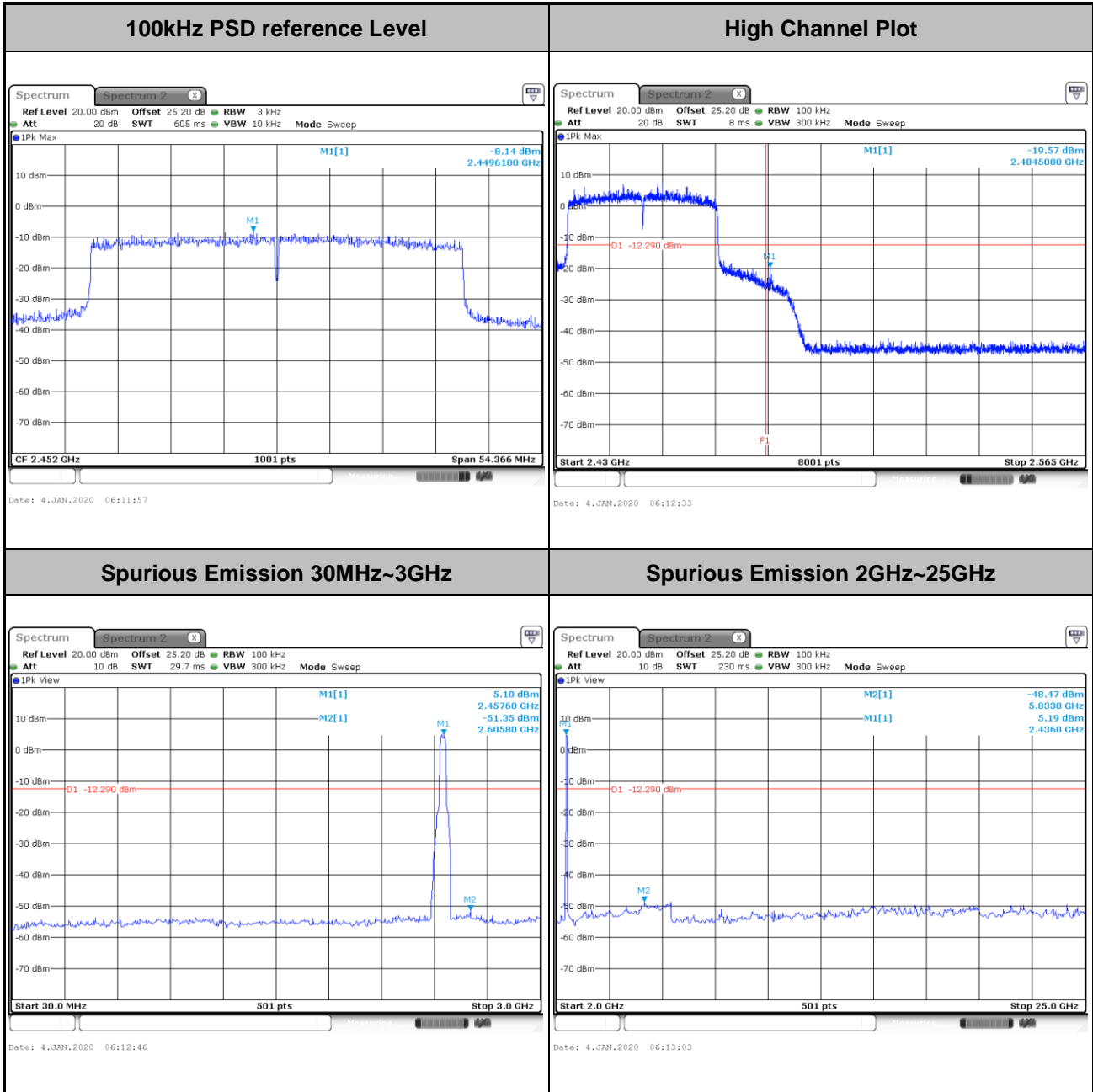



Test Mode :	802.11ax HE40	Test Channel :	09 Partial RU 242/62
--------------------	---------------	-----------------------	----------------------

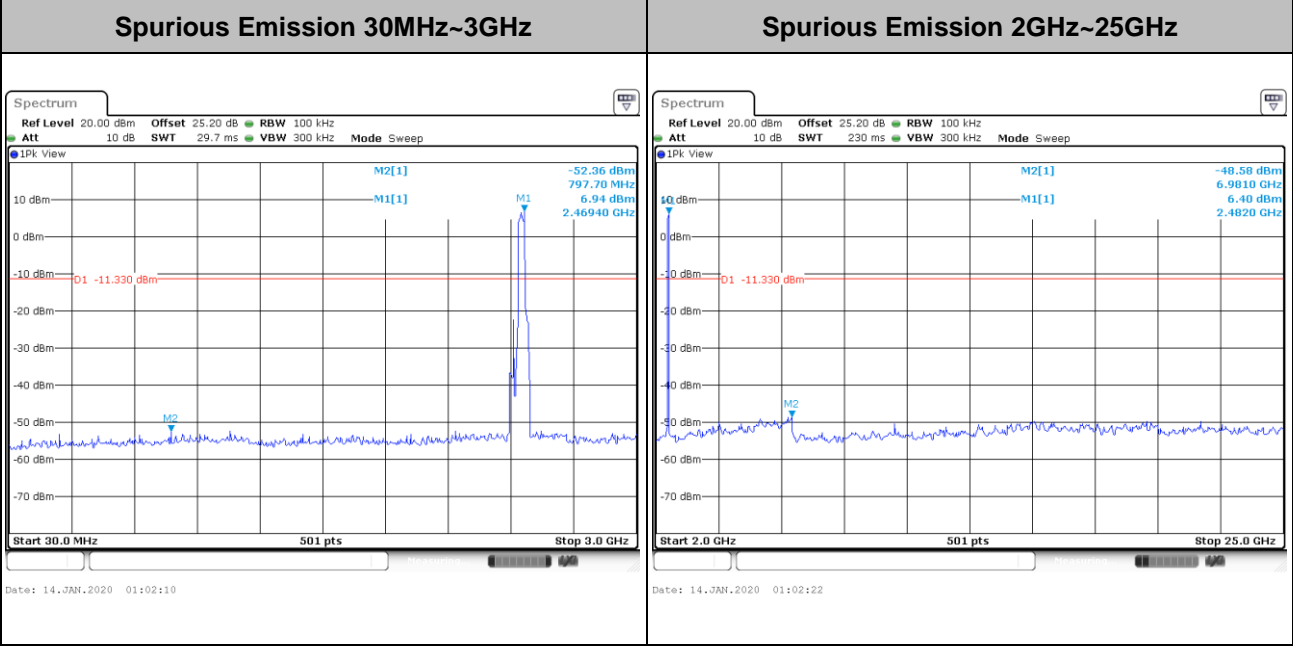
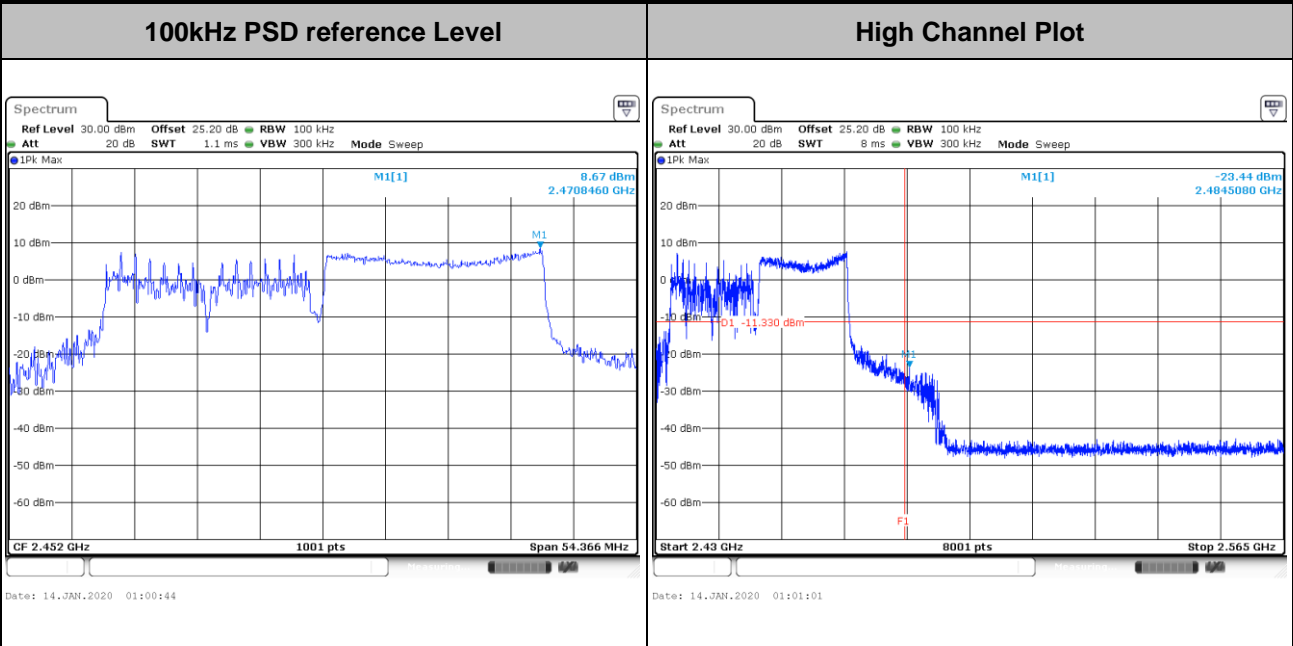



Number of TX = 2, Ant. 2 (Measured)

Test Mode :	802.11b	Test Channel :	01
-------------	---------	----------------	----

100kHz PSD reference Level	Low Channel Plot
-----------------------------------	-------------------------

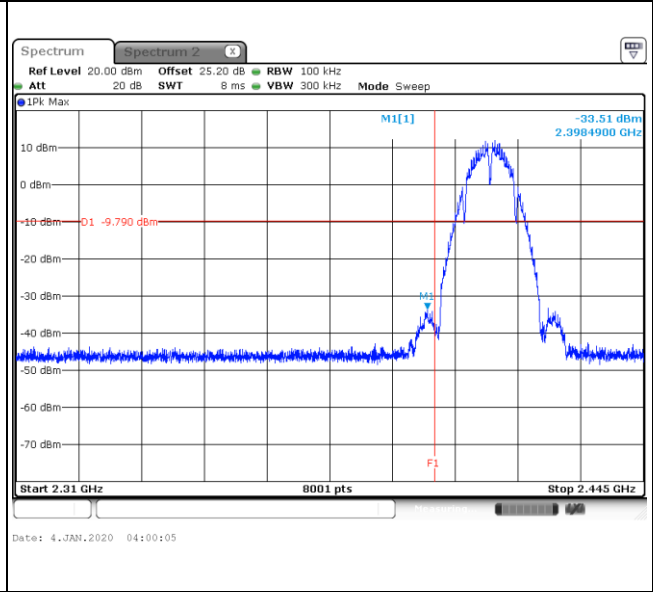
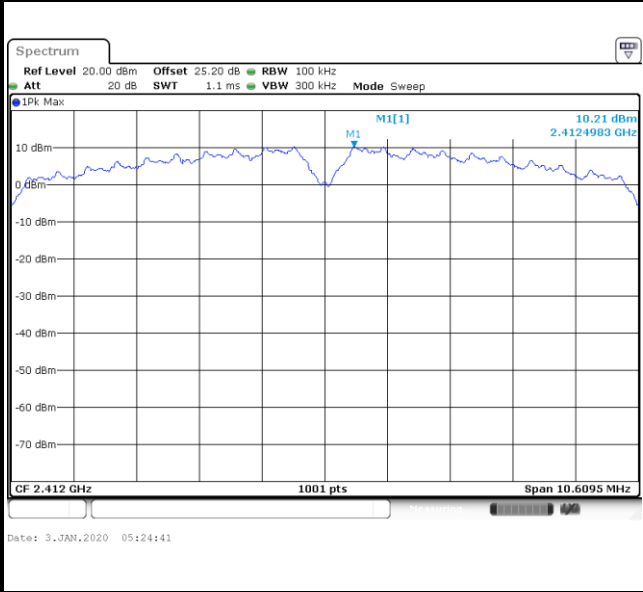

Spurious Emission 30MHz~3GHz

Spurious Emission 2GHz~25GHz

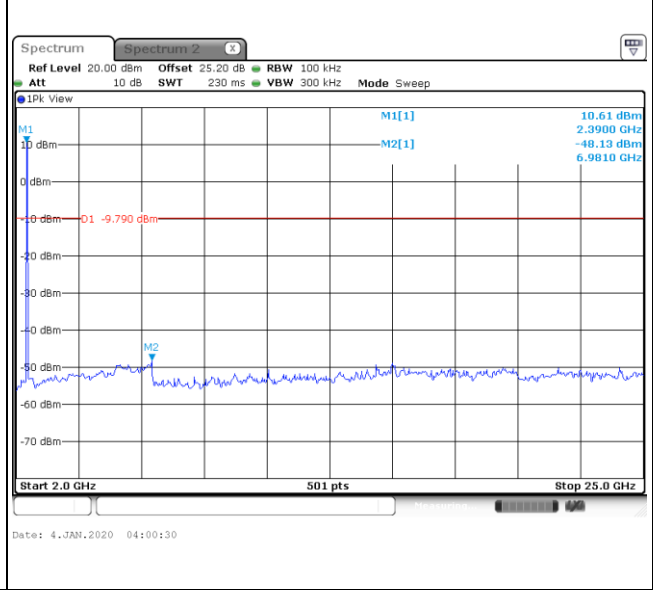
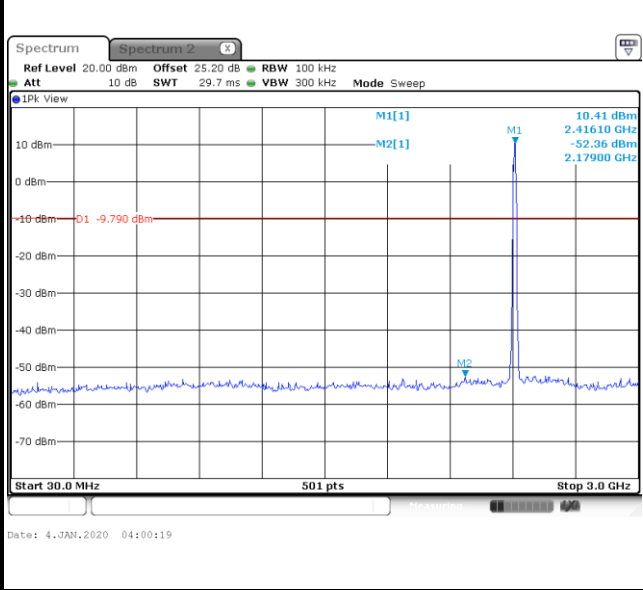



Test Mode :	802.11b	Test Channel :	06
-------------	---------	----------------	----

100kHz PSD reference Level	Mid Channel Plot
----------------------------	------------------

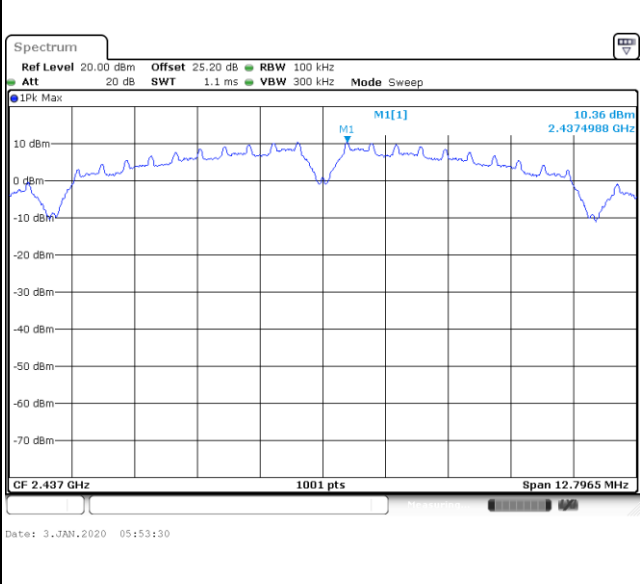

Spurious Emission 30MHz~3GHz	Spurious Emission 2GHz~25GHz
------------------------------	------------------------------

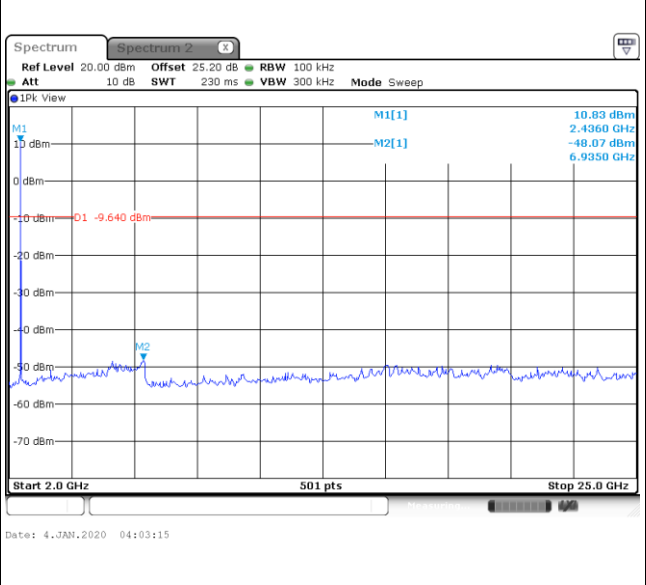
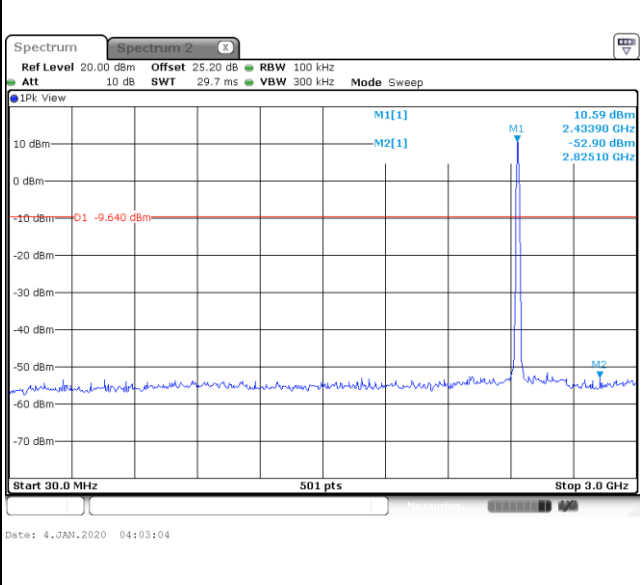



Test Mode :	802.11b	Test Channel :	11
-------------	---------	----------------	----

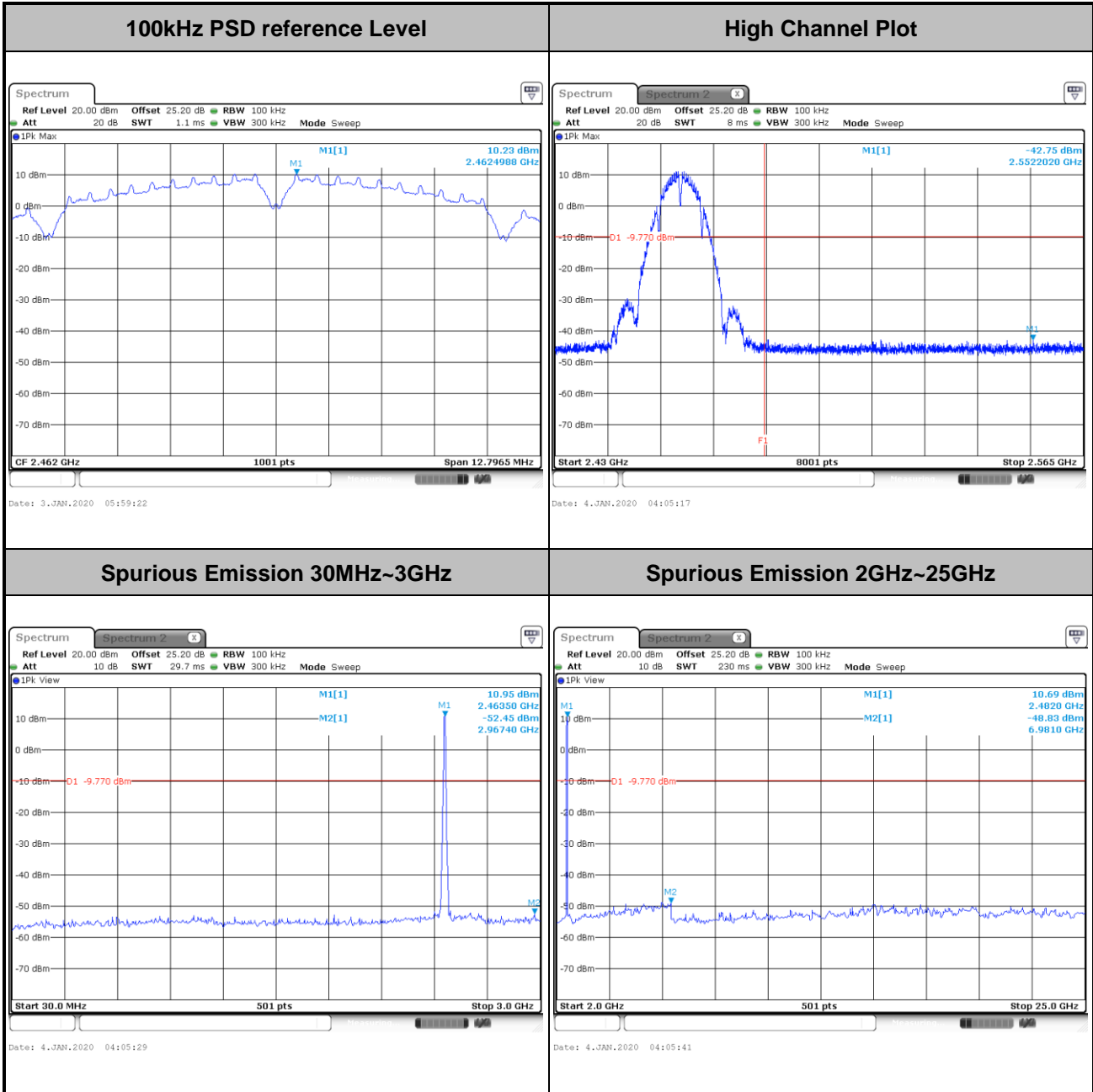



Test Mode :	802.11g	Test Channel :	01
-------------	---------	----------------	----

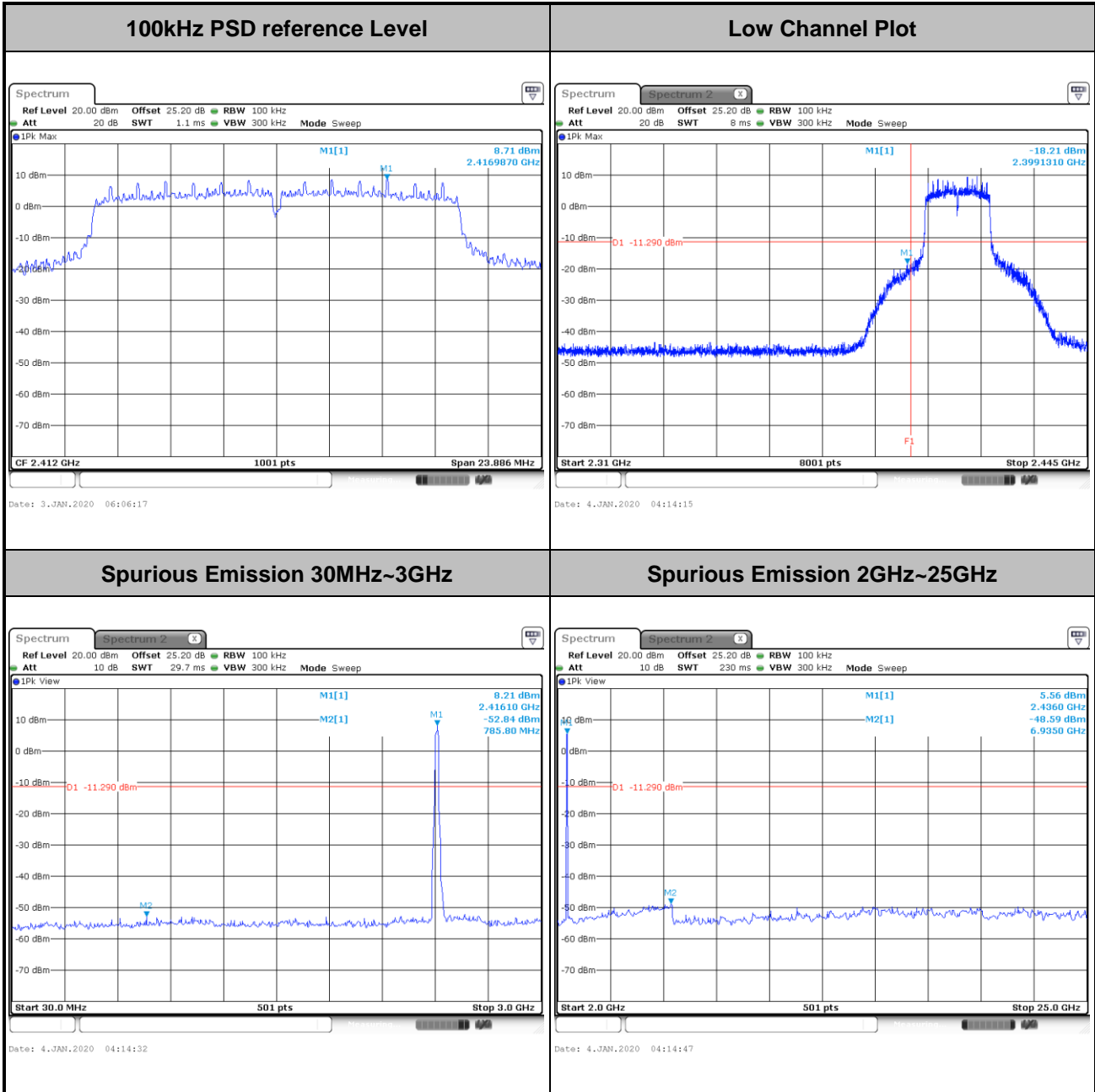



Test Mode :	802.11g	Test Channel :	06
-------------	---------	----------------	----

100kHz PSD reference Level	Mid Channel Plot
-----------------------------------	-------------------------

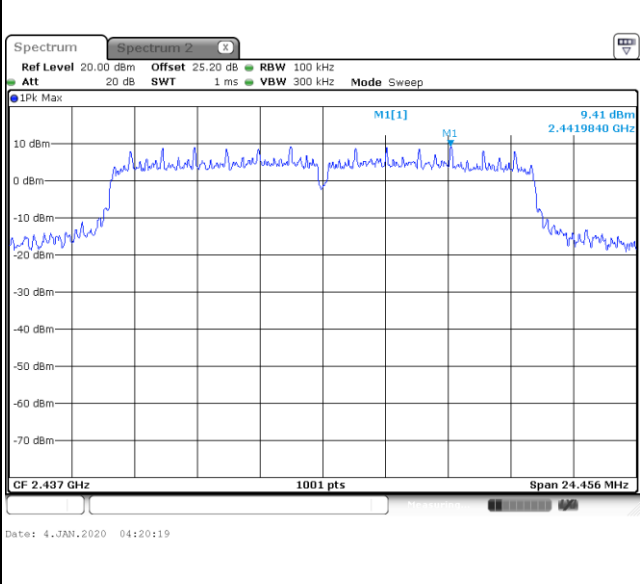

Spurious Emission 30MHz~3GHz	Spurious Emission 2GHz~25GHz
-------------------------------------	-------------------------------------

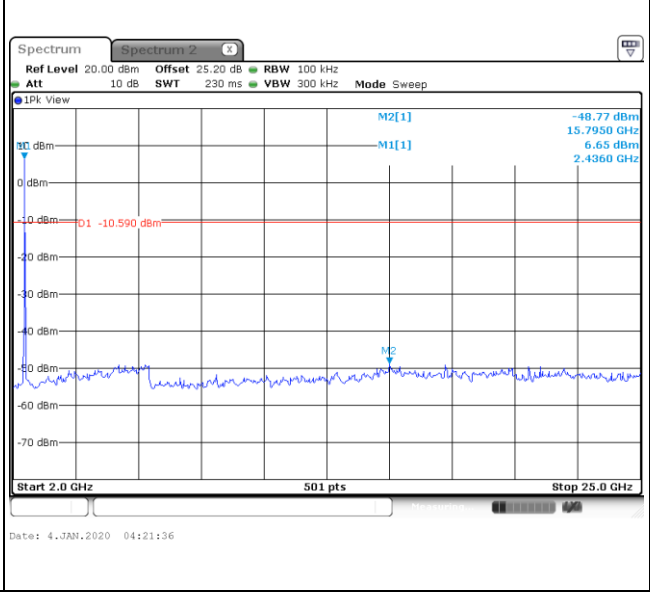
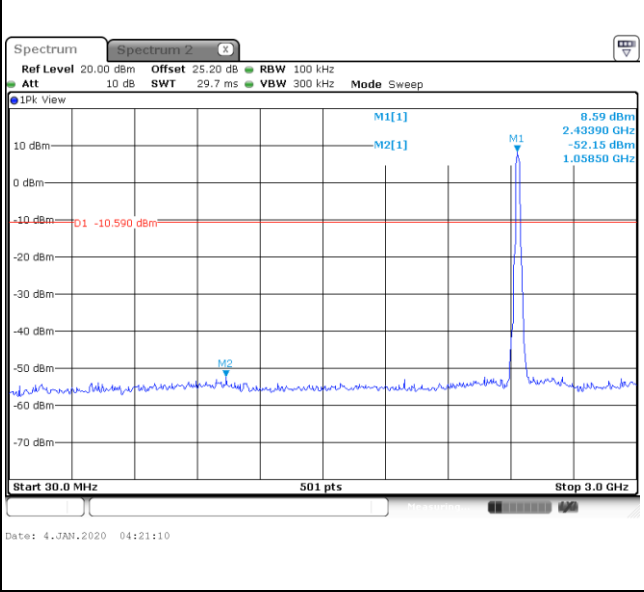



Test Mode :	802.11g	Test Channel :	11
-------------	---------	----------------	----

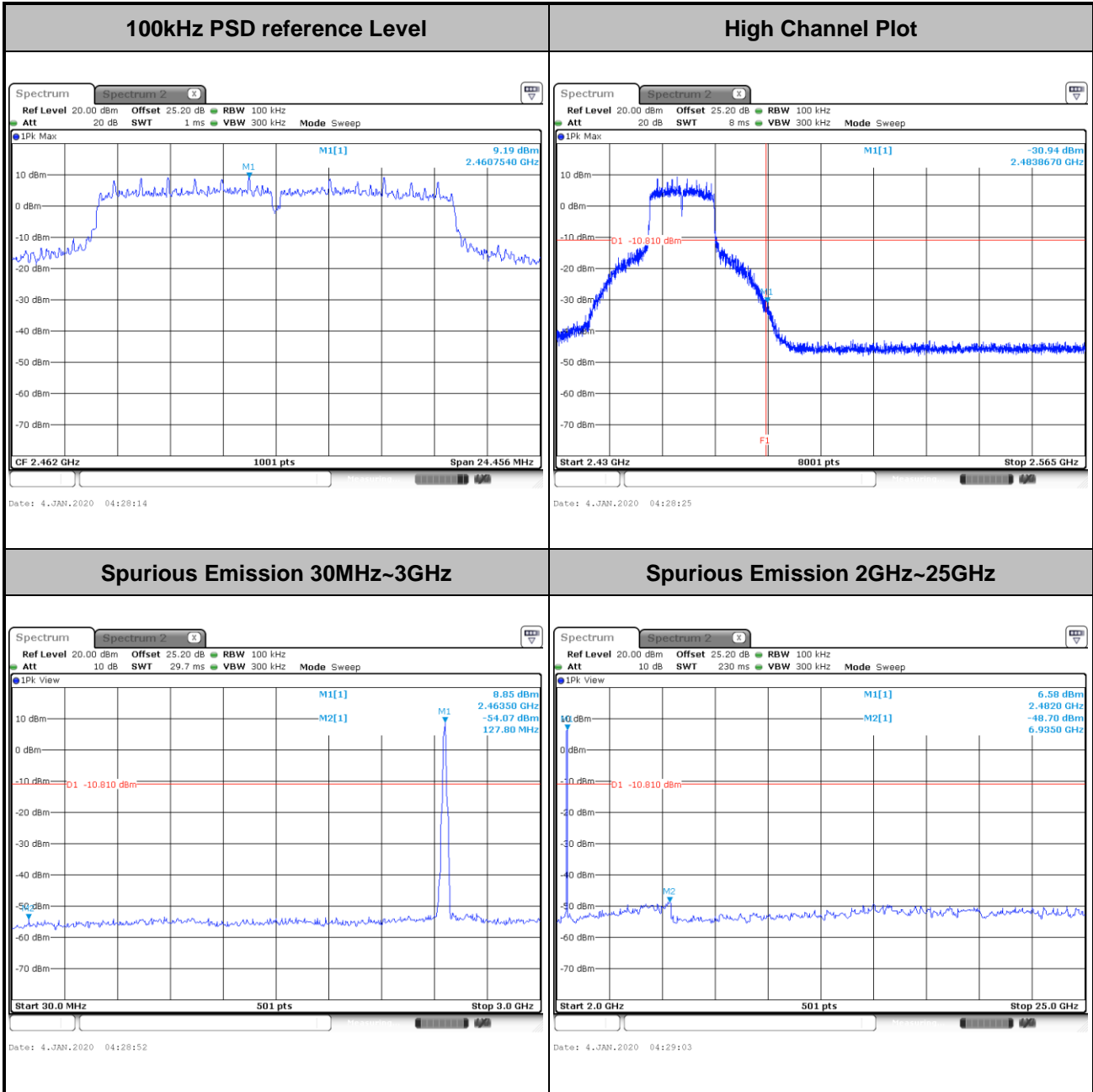



Test Mode :	802.11n HT20	Test Channel :	01
-------------	--------------	----------------	----

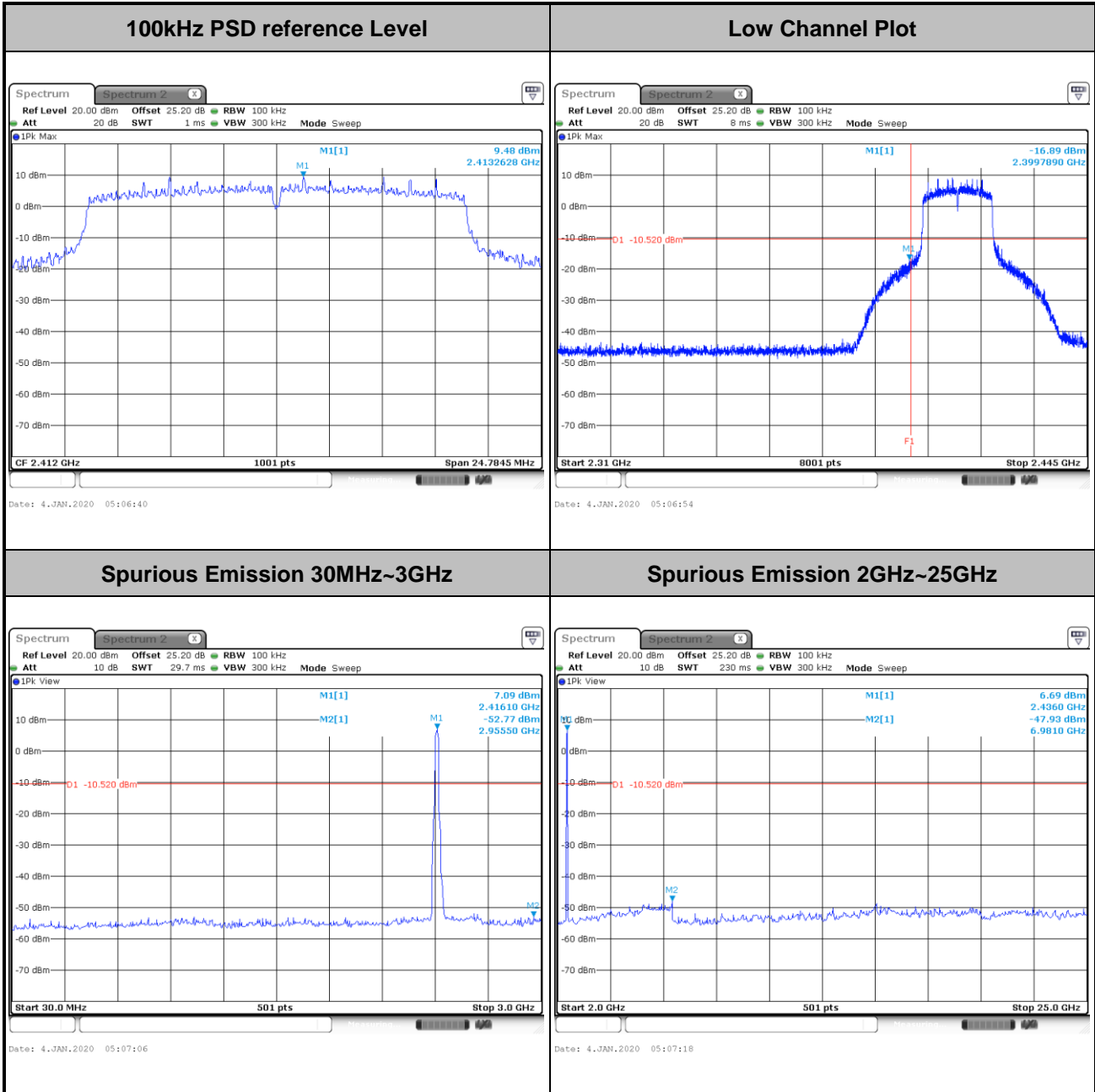



Test Mode :	802.11n HT20	Test Channel :	06
-------------	--------------	----------------	----

