



FCC RADIO TEST REPORT

FCC ID : IHDT56YJ1
Equipment : Mobile Cellular Phone
Brand Name : Motorola
Model Name : XT2061-1
Applicant : Motorola Mobility, LLC
222 W Merchandise Mart Plaza, Suite
1800, Chicago, IL 60654, United States
Manufacturer : Motorola Mobility, LLC
222 W Merchandise Mart Plaza, Suite
1800, Chicago, IL 60654, United States
Standard : FCC Part 15 Subpart C §15.247

The product was received on Dec. 06, 2019 and testing was started from Dec. 23, 2019 and completed on Jan. 17, 2020. We, SPORTON INTERNATIONAL INC., EMC & Wireless Communications Laboratory, would like to declare that the tested sample has been evaluated in accordance with the test procedures and has been in compliance with the applicable technical standards.

The report must not be used by the client to claim product certification, approval, or endorsement by TAF or any agency of government.

The test results in this report apply exclusively to the tested model / sample. Without written approval of SPORTON INTERNATIONAL INC. EMC & Wireless Communications Laboratory, the test report shall not be reproduced except in full.

Louis Wu

Reviewed by: Louis Wu

SPORTON INTERNATIONAL INC. EMC & Wireless Communications Laboratory
No. 52, Huaya 1st Rd., Guishan Dist., Taoyuan City, Taiwan (R.O.C.)



Table of Contents

History of this test report.....	3
Summary of Test Result.....	4
1 General Description.....	5
1.1 Product Feature of Equipment Under Test.....	5
1.2 Product Specification of Equipment Under Test.....	6
1.3 Modification of EUT	6
1.4 Testing Location	6
1.5 Applicable Standards.....	7
2 Test Configuration of Equipment Under Test.....	8
2.1 Carrier Frequency Channel	8
2.2 Test Mode.....	9
2.3 Connection Diagram of Test System.....	10
2.4 Support Unit used in test configuration and system	11
2.5 EUT Operation Test Setup	11
2.6 Measurement Results Explanation Example.....	11
3 Test Result.....	12
3.1 Number of Channel Measurement	12
3.2 Hopping Channel Separation Measurement	14
3.3 Dwell Time Measurement.....	20
3.4 20dB and 99% Bandwidth Measurement	22
3.5 Output Power Measurement.....	33
3.6 Conducted Band Edges Measurement.....	34
3.7 Conducted Spurious Emission Measurement	41
3.8 Radiated Band Edges and Spurious Emission Measurement	51
3.9 AC Conducted Emission Measurement.....	55
3.10 Antenna Requirements.....	57
4 List of Measuring Equipment	58
5 Uncertainty of Evaluation.....	60
Appendix A. Conducted Test Results	
Appendix B. AC Conducted Emission Test Result	
Appendix C. Radiated Spurious Emission	
Appendix D. Radiated Spurious Emission Plots	
Appendix E. Duty Cycle Plots	



History of this test report

Report No.	Version	Description	Issued Date
FR9D0635A	01	Initial issue of report	Feb. 03, 2020
FR9D0635A	02	Revised EUT information	Feb. 12, 2020



Summary of Test Result

Report Clause	Ref Std. Clause	Test Items	Result (PASS/FAIL)	Remark
3.1	15.247(a)(1)	Number of Channels	Pass	-
3.2	15.247(a)(1)	Hopping Channel Separation	Pass	-
3.3	15.247(a)(1)	Dwell Time of Each Channel	Pass	-
3.4	15.247(a)(1)	20dB Bandwidth	Pass	-
3.4	2.1049	99% Occupied Bandwidth	Reporting only	-
3.5	15.247(b)(1)	Peak Output Power	Pass	-
3.6	15.247(d)	Conducted Band Edges	Pass	-
3.7	15.247(d)	Conducted Spurious Emission	Pass	-
3.8	15.247(d)	Radiated Band Edges and Radiated Spurious Emission	Pass	Under limit 7.90 dB at 298.690 MHz
3.9	15.207	AC Conducted Emission	Pass	Under limit 18.23 dB at 2.013 MHz
3.10	15.203 & 15.247(b)	Antenna Requirement	Pass	-

Declaration of Conformity:

The test results with all measurement uncertainty excluded are presented in accordance with the regulation limits or requirements declared by manufacturers.

Comments and Explanations:

The declared of product specification for EUT presented in the report are provided by the manufacturer, and the manufacturer takes all the responsibilities for the accuracy of product specification.

Reviewed by: Wii Chang**Report Producer: Ann Lee**



1 General Description

1.1 Product Feature of Equipment Under Test

Product Feature	
Equipment	Mobile Cellular Phone
Brand Name	Motorola
Model Name	XT2061-1
FCC ID	IHDT56YJ1
IMEI Code	Conducted : IMEI: 359120100011371 Conduction : IMEI: 359120100016479 Radiation : IMEI: 359120100016305
EUT supports Radios application	CDMA/EV-DO/GSM/EGPRS/WCDMA/HSPA/LTE/5G NR/ GNSS/NFC/WPC WLAN 11b/g/n HT20 WLAN 11a/n HT20/HT40 WLAN 11ac VHT20/VHT40/VHT80 WLAN 11ax HE20/HE40/HE80 Bluetooth BR/EDR/LE
HW Version	DVT2
EUT Stage	Identical Prototype

Remark: The above EUT's information was declared by manufacturer.

Accessory List	
AC Adapter 1	Brand Name : Motorola
	Model Name : SC-51 (SA18C30116)
	Manufacturer : Chenyang
AC Adapter 2	Brand Name : Motorola
	Model Name : SC-51 (SA18C62985)
	Manufacturer : Acbel
Battery	Brand Name : ATL
	Model Name : LW50
USB Cable 1	Brand Name : Motorola
	Model Name : SC18C24367
	Manufacturer : Saibao
USB Cable 2	Brand Name : Motorola
	Model Name : SC18C24368
	Manufacturer : Luxshare



1.2 Product Specification of Equipment Under Test

Standards-related Product Specification	
Tx/Rx Frequency Range	2402 MHz ~ 2480 MHz
Number of Channels	79
Carrier Frequency of Each Channel	2402+n*1 MHz; n=0~78
Maximum Output Power to Antenna	Bluetooth BR(1Mbps) : 17.51 dBm (0.0564 W) Bluetooth EDR (2Mbps) : 17.02 dBm (0.0504 W) Bluetooth EDR (3Mbps) : 17.37 dBm (0.0546 W)
99% Occupied Bandwidth	Bluetooth BR(1Mbps) : 0.834MHz Bluetooth EDR (2Mbps) : 1.166MHz Bluetooth EDR (3Mbps) : 1.152MHz
Antenna Type / Gain	ILA Antenna type with gain -2.5 dBi
Type of Modulation	Bluetooth BR (1Mbps) : GFSK Bluetooth EDR (2Mbps) : $\pi/4$ -DQPSK Bluetooth EDR (3Mbps) : 8-DPSK

1.3 Modification of EUT

No modifications are made to the EUT during all test items.

1.4 Testing Location

Test Site	SPORTON INTERNATIONAL INC. EMC & Wireless Communications Laboratory	
Test Site Location	No.52, Huaya 1st Rd., Guishan Dist., Taoyuan City, Taiwan (R.O.C.) TEL: +886-3-327-3456 FAX: +886-3-328-4978	
Test Site No.	Sporton Site No.	
	TH05-HY	CO05-HY

Note: The test site complies with ANSI C63.4 2014 requirement.

Test Site	SPORTON INTERNATIONAL INC. EMC & Wireless Communications Laboratory	
Test Site Location	No.58, Aly. 75, Ln. 564, Wenhua 3rd, Rd., Guishan Dist., Taoyuan City, Taiwan (R.O.C.) TEL: +886-3-327-0868 FAX: +886-3-327-0855	
Test Site No.	Sporton Site No.	
	03CH15-HY	

Note: The test site complies with ANSI C63.4 2014 requirement.

FCC designation No.: TW1190 and TW0007



1.5 Applicable Standards

According to the specifications of the manufacturer, the EUT must comply with the requirements of the following standards:

- ♦ FCC Part 15 Subpart C §15.247
- ♦ FCC KDB Publication No. 558074 D01 DTS Meas. Guidance v05r02
- ♦ FCC KDB 414788 D01 Radiated Test Site v01r01
- ♦ ANSI C63.10-2013

Remark:

1. All test items were verified and recorded according to the standards and without any deviation during the test.
2. This EUT has also been tested and complied with the requirements of FCC Part 15, Subpart B, recorded in a separate test report.



2 Test Configuration of Equipment Under Test

2.1 Carrier Frequency Channel

Frequency Band	Channel	Freq. (MHz)	Channel	Freq. (MHz)	Channel	Freq. (MHz)
2400-2483.5 MHz	0	2402	27	2429	54	2456
	1	2403	28	2430	55	2457
	2	2404	29	2431	56	2458
	3	2405	30	2432	57	2459
	4	2406	31	2433	58	2460
	5	2407	32	2434	59	2461
	6	2408	33	2435	60	2462
	7	2409	34	2436	61	2463
	8	2410	35	2437	62	2464
	9	2411	36	2438	63	2465
	10	2412	37	2439	64	2466
	11	2413	38	2440	65	2467
	12	2414	39	2441	66	2468
	13	2415	40	2442	67	2469
	14	2416	41	2443	68	2470
	15	2417	42	2444	69	2471
	16	2418	43	2445	70	2472
	17	2419	44	2446	71	2473
	18	2420	45	2447	72	2474
	19	2421	46	2448	73	2475
	20	2422	47	2449	74	2476
	21	2423	48	2450	75	2477
	22	2424	49	2451	76	2478
	23	2425	50	2452	77	2479
	24	2426	51	2453	78	2480
	25	2427	52	2454	-	-
	26	2428	53	2455	-	-



2.2 Test Mode

- a. The EUT has been associated with peripherals and configuration operated in a manner tended to maximize its emission characteristics in a typical application. Frequency range investigated: conduction emission (150 kHz to 30 MHz), radiation emission (9 kHz to the 10th harmonic of the highest fundamental frequency or to 40 GHz, whichever is lower). For radiated measurement, pre-scanned in three orthogonal panels, X, Y, Z. The worst cases (Z plane) were recorded in this report, and the worst mode of radiated spurious emissions is Bluetooth 1Mbps mode, and recorded in this report.
- b. AC power line Conducted Emission was tested under maximum output power.

The following summary table is showing all test modes to demonstrate in compliance with the standard.

Summary table of Test Cases			
Test Item	Data Rate / Modulation		
	Bluetooth BR 1Mbps GFSK	Bluetooth EDR 2Mbps $\pi/4$ -DQPSK	Bluetooth EDR 3Mbps 8-DPSK
Conducted Test Cases	Mode 1: CH00_2402 MHz Mode 2: CH39_2441 MHz Mode 3: CH78_2480 MHz	Mode 4: CH00_2402 MHz Mode 5: CH39_2441 MHz Mode 6: CH78_2480 MHz	Mode 7: CH00_2402 MHz Mode 8: CH39_2441 MHz Mode 9: CH78_2480 MHz
Radiated Test Cases	Bluetooth BR 1Mbps GFSK Mode 1: CH00_2402 MHz Mode 2: CH39_2441 MHz Mode 3: CH78_2480 MHz		
AC Conducted Emission	Mode 1: GSM850 Idle + Bluetooth Link + WLAN (2.4GHz) Link + MPEG4 + Earphone + Battery + USB Cable 1 (Charging from Adapter 1)		
Remark: <ol style="list-style-type: none"> 1. For radiated test cases, the worst mode data rate 1Mbps was reported only since the highest RF output power in the preliminary tests. The conducted spurious emissions and conducted band edge measurement for other data rates were not worse than 1Mbps, and no other significantly frequencies found in conducted spurious emission. 2. For Radiated Test Cases, the tests were performed with Adapter 1 and USB Cable 1. 			

2.3 Connection Diagram of Test System

<Bluetooth Tx Mode>

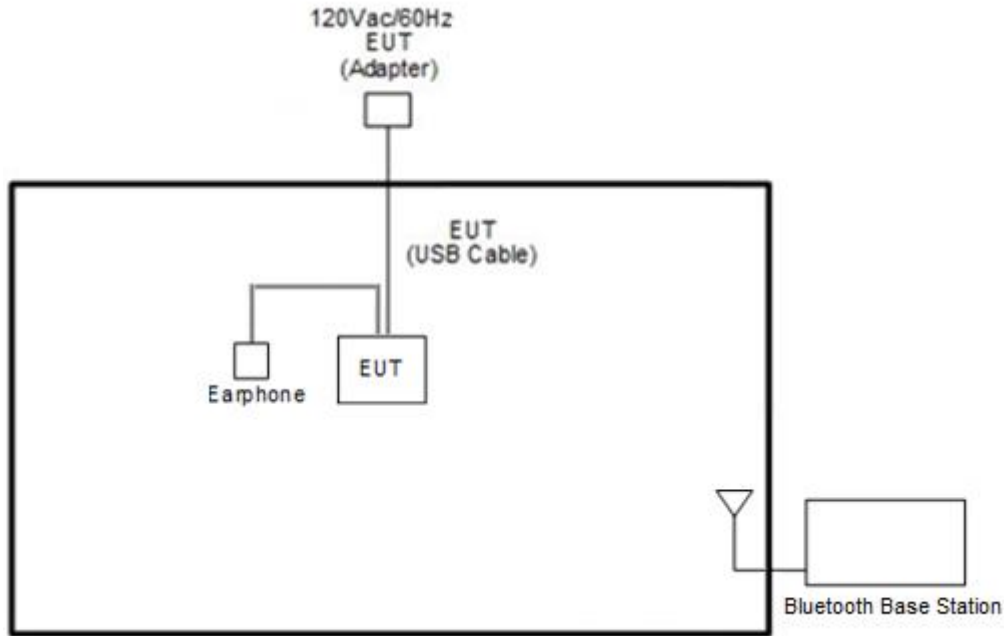

<AC Conducted Emission Mode>

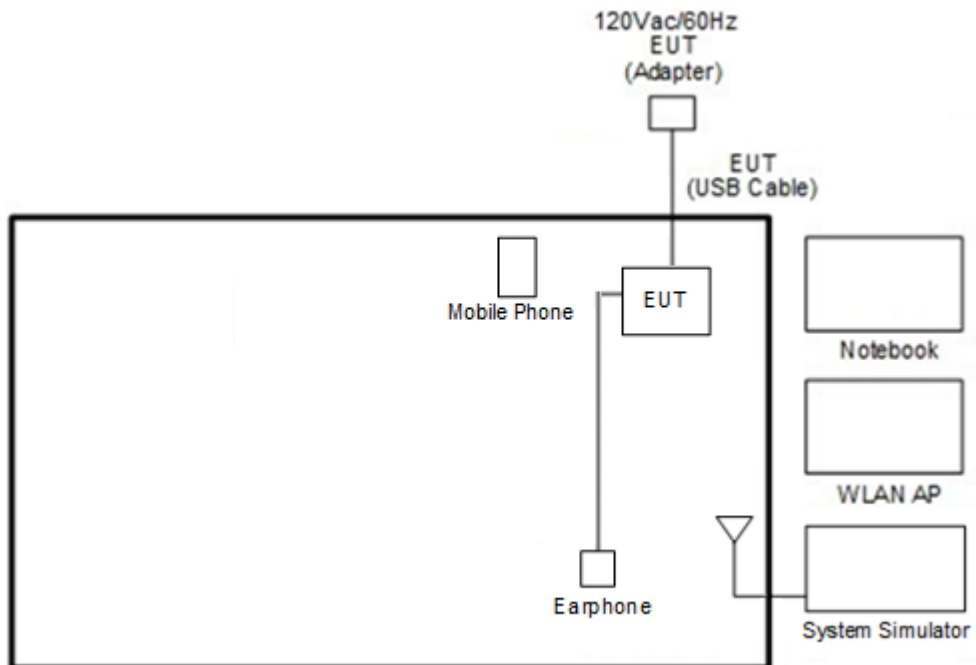



2.4 Support Unit used in test configuration and system

Item	Equipment	Trade Name	Model Name	FCC ID	Data Cable	Power Cord
1.	WLAN AP	ASUS	RT-AC66U	MSQ-RTAC66U	N/A	Unshielded, 1.8 m
2.	Notebook	DELL	Latitude E3400	FCC DoC	N/A	AC I/P: Unshielded, 1.2 m DC O/P: Shielded, 1.8 m
3.	Mobile Phone	Moto	moto burton	N/A	N/A	N/A
4.	System Simulator	R&S	CMU 200	N/A	N/A	Unshielded, 1.8 m
5.	Bluetooth Base Station	R&S	CBT32	N/A	N/A	Unshielded, 1.8 m
6.	Earphone	Moto	NASH38C16618	N/A	Unshielded, 1.0 m	N/A

2.5 EUT Operation Test Setup

The RF test items, utility "QRCT v4.0.00142.0" was installed in Notebook which was programmed in order to make the EUT get into the engineering modes to contact with base station to provide channel selection, power level, data rate and the application type and for continuous transmitting signals.

2.6 Measurement Results Explanation Example

For all conducted test items:

The offset level is set in the spectrum analyzer to compensate the RF cable loss and attenuator factor between EUT conducted output port and spectrum analyzer. With the offset compensation, the spectrum analyzer reading level is exactly the EUT RF output level.

Example:

The spectrum analyzer offset is derived from RF cable loss and attenuator factor.

Offset = RF cable loss + attenuator factor.

Following shows an offset computation example with cable loss 4.2 dB and 10dB attenuator.

$$\begin{aligned} \text{Offset(dB)} &= \text{RF cable loss(dB)} + \text{attenuator factor(dB)}. \\ &= 4.2 + 10 = 14.2 \text{ (dB)} \end{aligned}$$

3 Test Result

3.1 Number of Channel Measurement

3.1.1 Limits of Number of Hopping Frequency

Frequency hopping systems in the 2400-2483.5 MHz band shall use at least 15 channels.

3.1.2 Measuring Instruments

See list of measuring equipment of this test report.

3.1.3 Test Procedure

1. The testing follows ANSI C63.10-2013 clause 7.8.3.
2. The RF output of EUT was connected to the spectrum analyzer by RF cable and attenuator. The path loss was compensated to the results for each measurement.
3. Set to the maximum power setting and enable the EUT transmit continuously.
4. Enable the EUT hopping function.
5. Use the following spectrum analyzer settings: Span = the frequency band of operation; RBW = 300kHz; VBW \geq RBW; Sweep = auto; Detector function = peak; Trace = max hold.
6. The number of hopping frequency used is defined as the number of total channel.
7. Record the measurement data derived from spectrum analyzer.

3.1.4 Test Setup

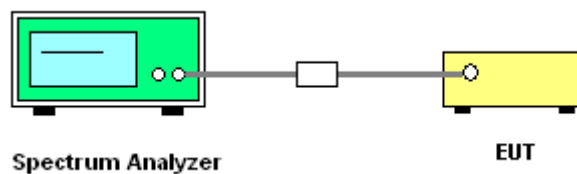



3.1.5 Test Result of Number of Hopping Frequency

Please refer to Appendix A.

Number of Hopping Channel Plot on Channel 00 - 78

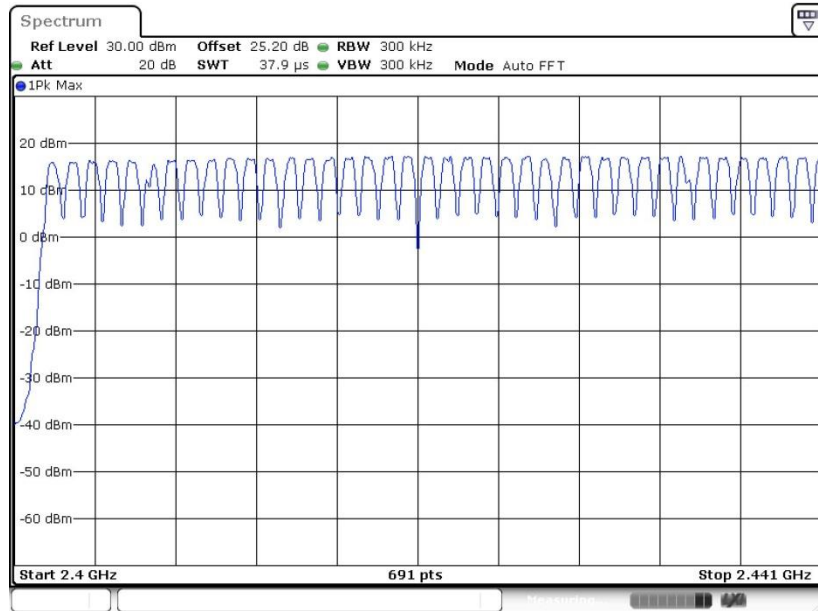

Date: 6.JAN.2020 00:07:02

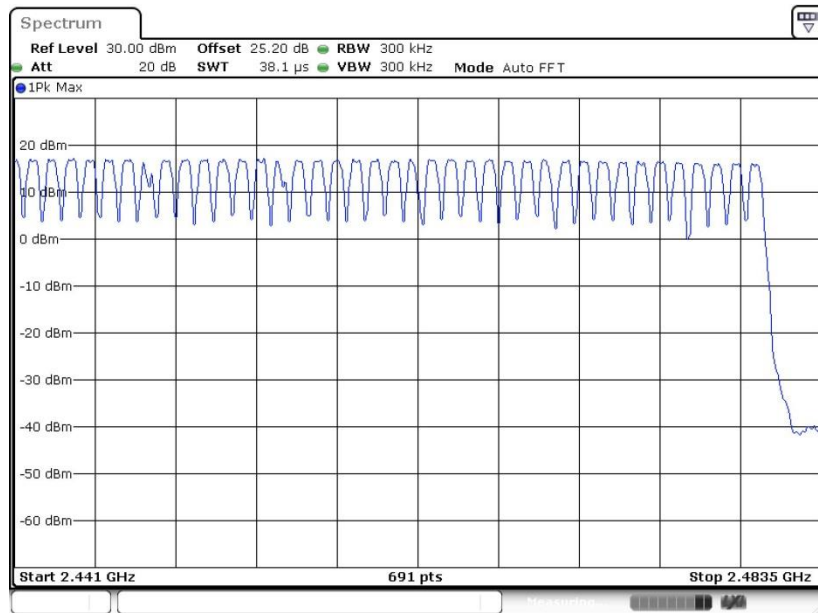

Date: 6.JAN.2020 00:07:42

3.2 Hopping Channel Separation Measurement

3.2.1 Limit of Hopping Channel Separation

Frequency hopping systems operating in the 2400-2483.5 MHz band may have hopping channel carrier frequencies that are separated by 25 kHz or two-thirds of the 20 dB bandwidth of the hopping channel, whichever is greater.

3.2.2 Measuring Instruments

See list of measuring equipment of this test report.

3.2.3 Test Procedures

1. The testing follows ANSI C63.10-2013 clause 7.8.2.
2. The RF output of EUT was connected to the spectrum analyzer by RF cable and attenuator. The path loss was compensated to the results for each measurement.
3. Set to the maximum power setting and enable the EUT transmit continuously.
4. Enable the EUT hopping function.
5. Use the following spectrum analyzer settings:
Span = wide enough to capture the peaks of two adjacent channels;
RBW = 300kHz; VBW \geq RBW; Sweep = auto; Detector function = peak; Trace = max hold.
6. Measure and record the results in the test report.

3.2.4 Test Setup

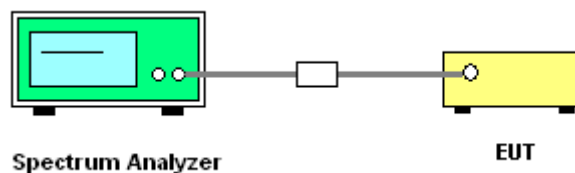

3.2.5 Test Result of Hopping Channel Separation

Please refer to Appendix A.



<1Mbps>

Channel Separation Plot on Channel 00 - 01

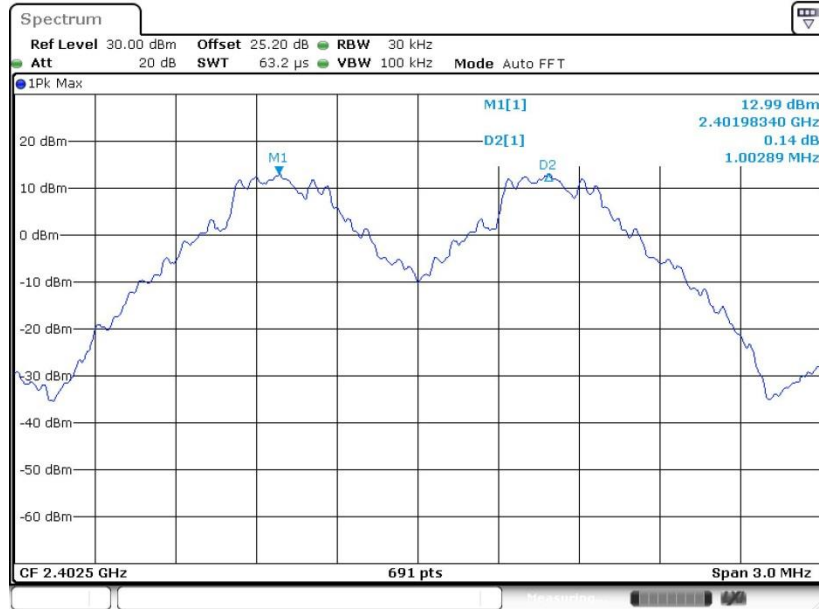

Date: 6.JAN.2020 00:13:36

Channel Separation Plot on Channel 39 - 40

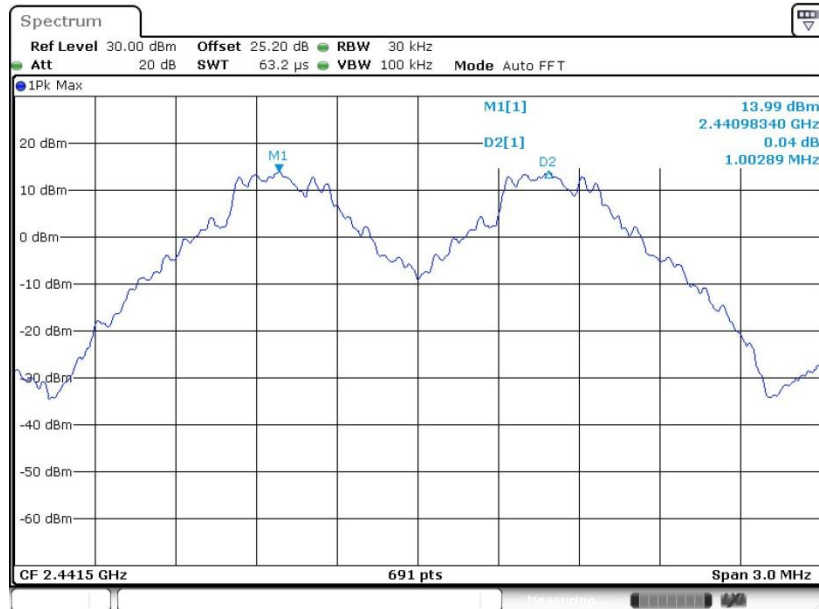

Date: 6.JAN.2020 00:14:35



Channel Separation Plot on Channel 77 - 78



Date: 6.JAN.2020 00:15:33

<2Mbps>

Channel Separation Plot on Channel 00 - 01

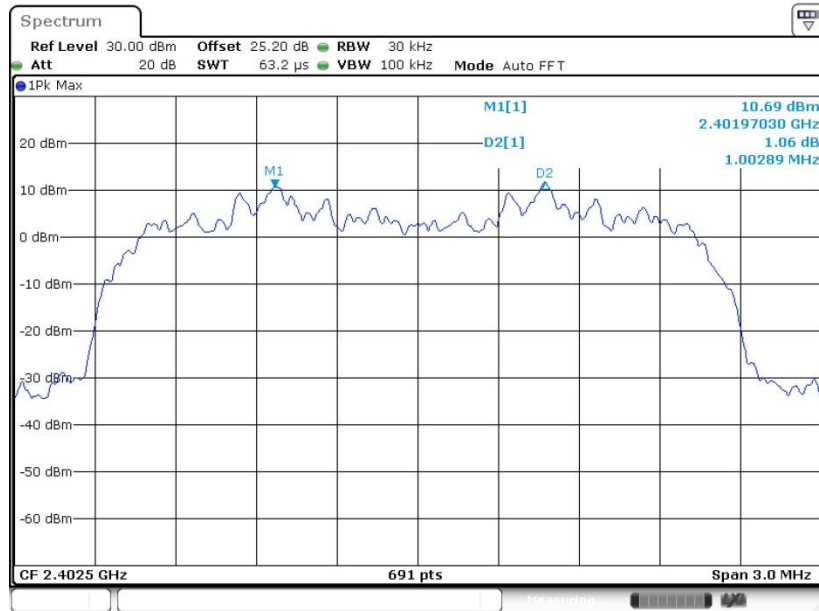

Date: 6.JAN.2020 00:20:33



Channel Separation Plot on Channel 39 - 40

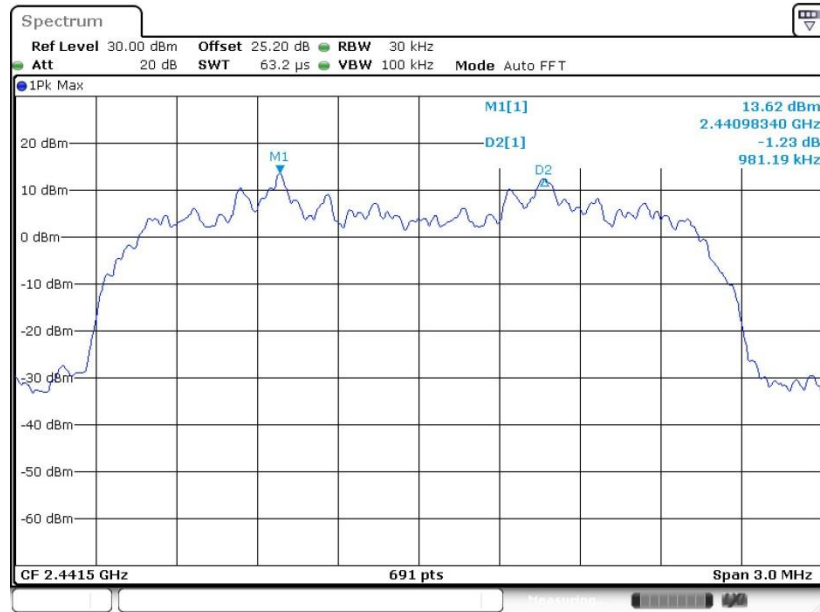

Date: 6.JAN.2020 00:21:42

Channel Separation Plot on Channel 77 - 78

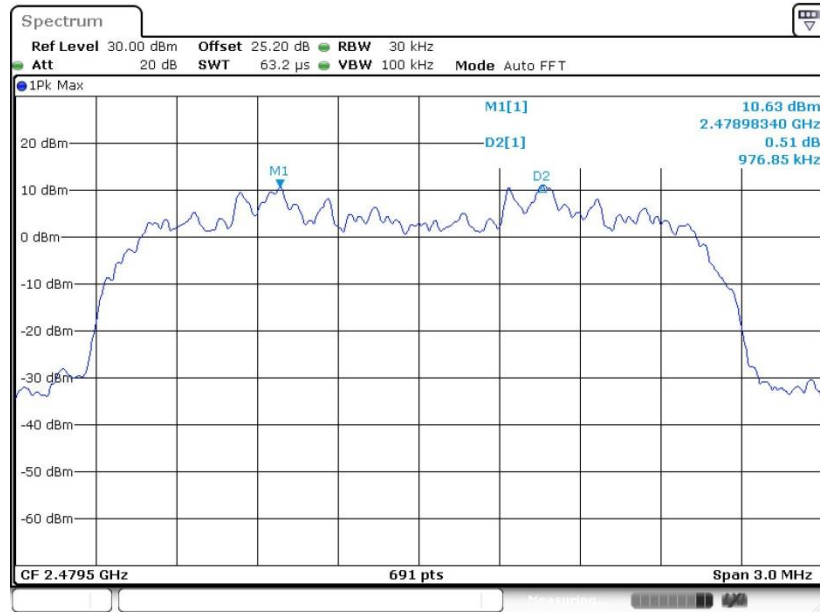

Date: 6.JAN.2020 00:22:31



<3Mbps>

Channel Separation Plot on Channel 00 - 01

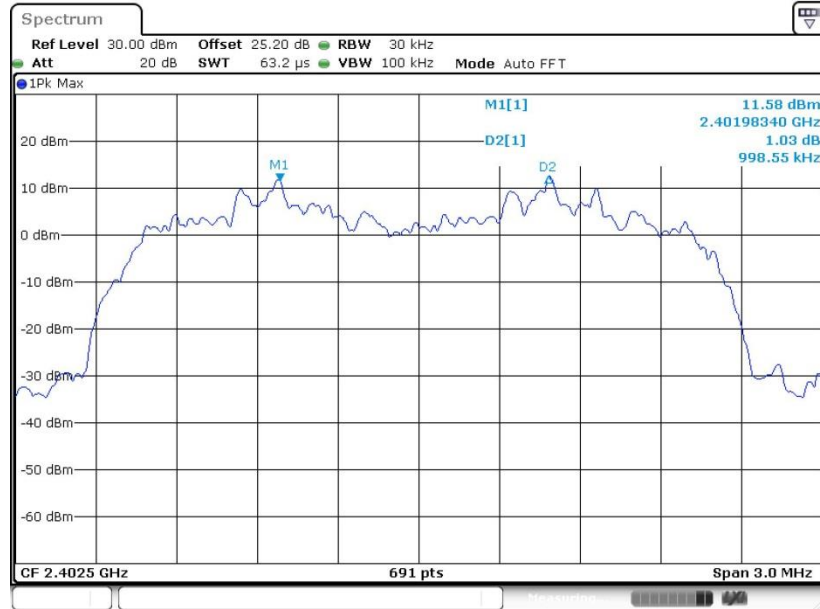

Date: 6.JAN.2020 00:23:43

Channel Separation Plot on Channel 39 - 40

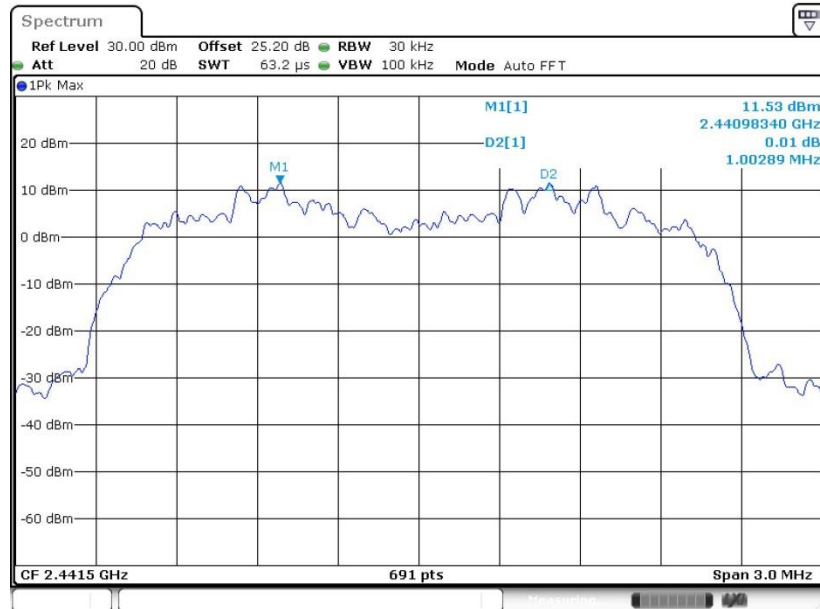

Date: 6.JAN.2020 00:25:07



Channel Separation Plot on Channel 77 - 78

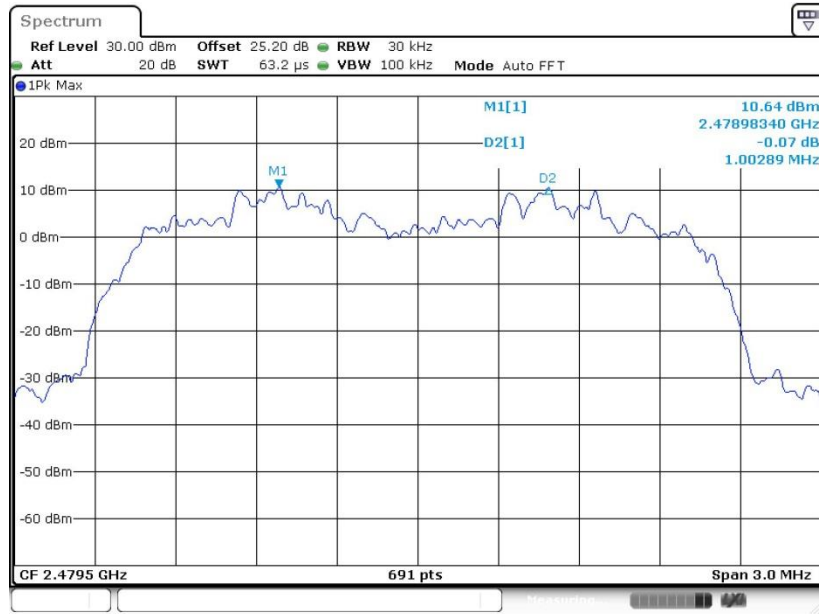

Date: 6.JAN.2020 00:26:11

3.3 Dwell Time Measurement

3.3.1 Limit of Dwell Time

The average time of occupancy on any channel shall not be greater than 0.4 seconds within a period of 0.4 seconds multiplied by the number of hopping channels employed.

3.3.2 Measuring Instruments

See list of measuring equipment of this test report.

3.3.3 Test Procedures

1. The testing follows ANSI C63.10-2013 clause 7.8.4.
2. The RF output of EUT was connected to the spectrum analyzer by RF cable and attenuator. The path loss was compensated to the results for each measurement.
3. Set to the maximum power setting and enable the EUT transmit continuously.
4. Enable the EUT hopping function.
5. Use the following spectrum analyzer settings: Span = zero span, centered on a hopping channel; RBW = 1 MHz; VBW \geq RBW; Sweep = as necessary to capture the entire dwell time per hopping channel; Detector function = peak; Trace = max hold.
6. Measure and record the results in the test report.

3.3.4 Test Setup

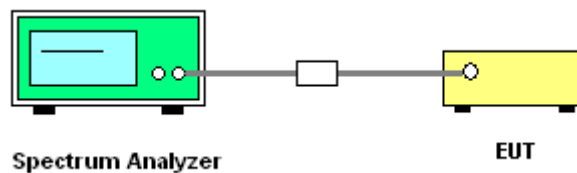

3.3.5 Test Result of Dwell Time

Please refer to Appendix A.



Package Transfer Time Plot

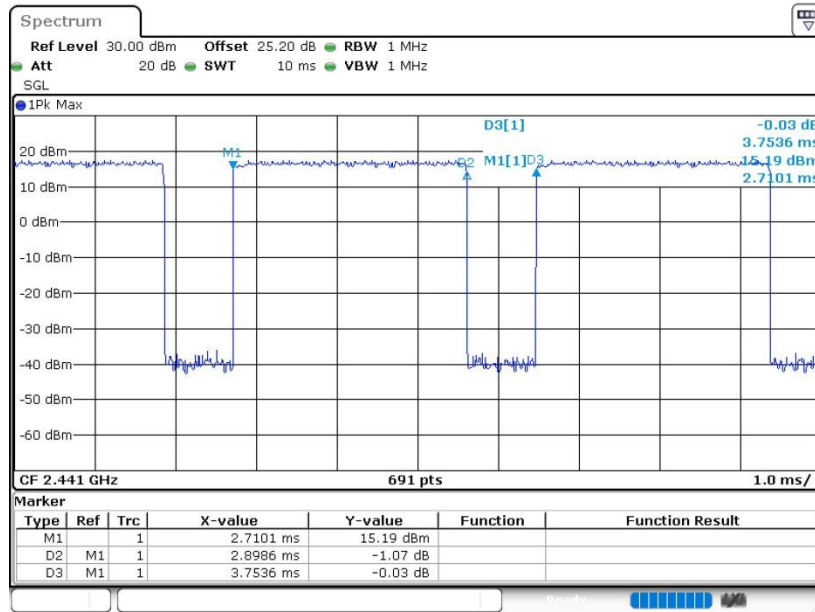

Date: 23.DEC.2019 23:56:52

Remark:

1. In normal mode, hopping rate is 1600 hops/s with 6 slots in 79 hopping channels. With channel hopping rate (1600 / 6 / 79) in Occupancy Time Limit (0.4 x 79) (s), Hops Over Occupancy Time comes to (1600 / 6 / 79) x (0.4 x 79) = 106.67 hops.
2. In AFH mode, hopping rate is 800 hops/s with 6 slots in 20 hopping channels. With channel hopping rate (800 / 6 / 20) in Occupancy Time Limit (0.4 x 20) (s), Hops Over Occupancy Time comes to (800 / 6 / 20) x (0.4 x 20) = 53.33 hops.
3. Dwell Time(s) = Hops Over Occupancy Time (hops) x Package Transfer Time

3.4 20dB and 99% Bandwidth Measurement

3.4.1 Limit of 20dB and 99% Bandwidth

Reporting only

3.4.2 Measuring Instruments

See list of measuring equipment of this test report.

3.4.3 Test Procedures

1. The testing follows ANSI C63.10-2013 clause 6.9.2 and 6.9.3.
2. The RF output of EUT was connected to the spectrum analyzer by RF cable and attenuator. The path loss was compensated to the results for each measurement.
3. Set to the maximum power setting and enable the EUT transmit continuously.
4. Use the following spectrum analyzer settings for 20dB Bandwidth measurement.
Span = approximately 2 to 5 times the 20 dB bandwidth, centered on a hopping channel;
RBW \geq 1% of the 20 dB bandwidth; VBW \geq RBW; Sweep = auto; Detector function = peak;
Trace = max hold.
5. Use the following spectrum analyzer settings for 99 % Bandwidth measurement.
Span = approximately 1.5 to 5 times the 99% bandwidth, centered on a hopping channel;
RBW \geq 1-5% of the 99% bandwidth; VBW \geq 3 * RBW; Sweep = auto; Detector function = peak;
Trace = max hold.
6. Measure and record the results in the test report.

3.4.4 Test Setup



3.4.5 Test Result of 20dB Bandwidth

Please refer to Appendix A.



<1Mbps>

20 dB Bandwidth Plot on Channel 00



Date: 6.JAN.2020 00:31:56

20 dB Bandwidth Plot on Channel 39

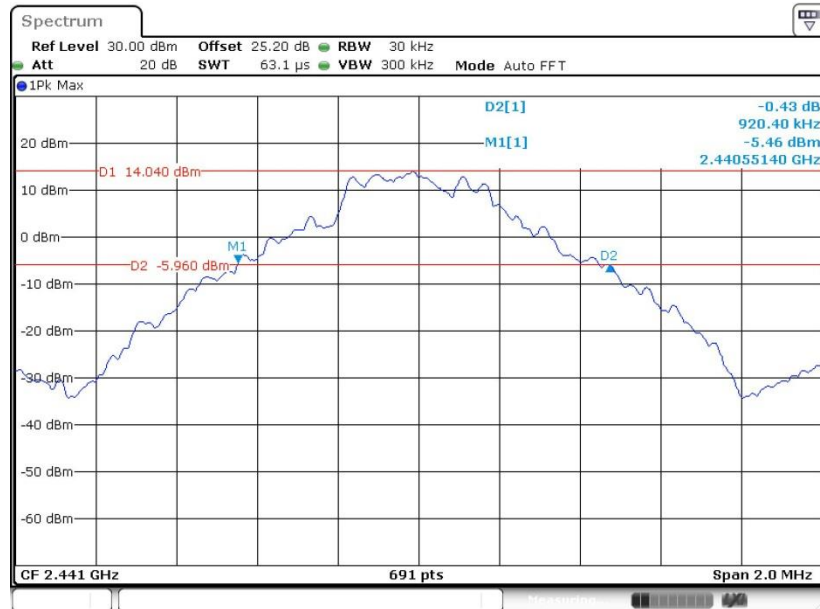

Date: 6.JAN.2020 00:37:38



20 dB Bandwidth Plot on Channel 78

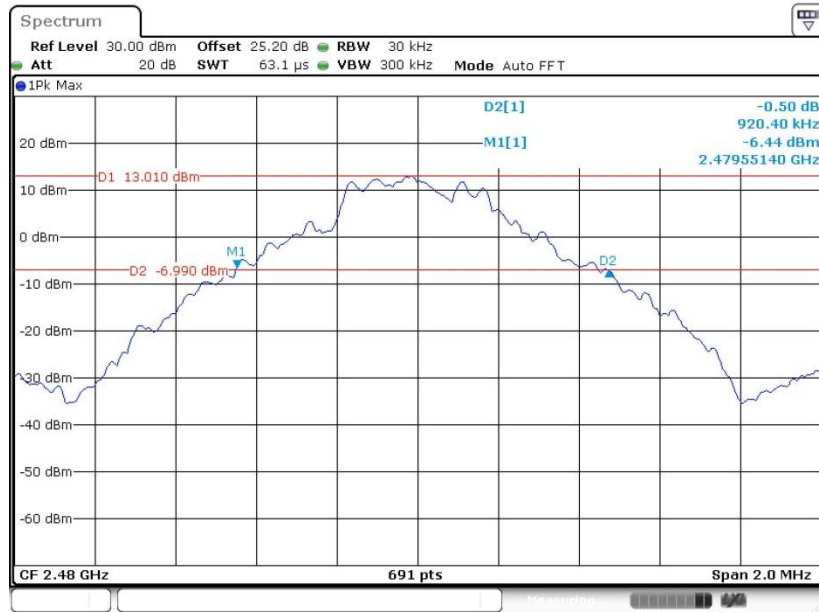

Date: 6.JAN.2020 00:42:24

<2Mbps>

20 dB Bandwidth Plot on Channel 00

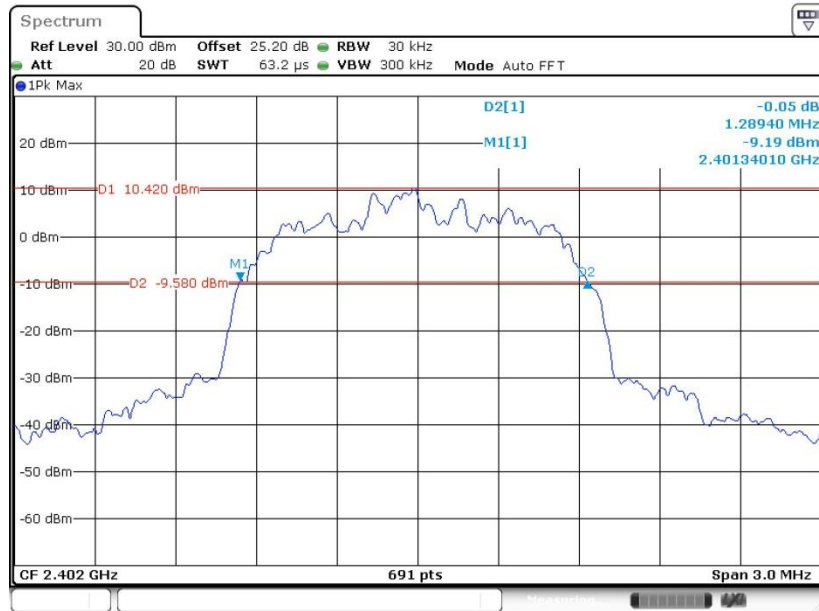

Date: 6.JAN.2020 00:45:44



20 dB Bandwidth Plot on Channel 39

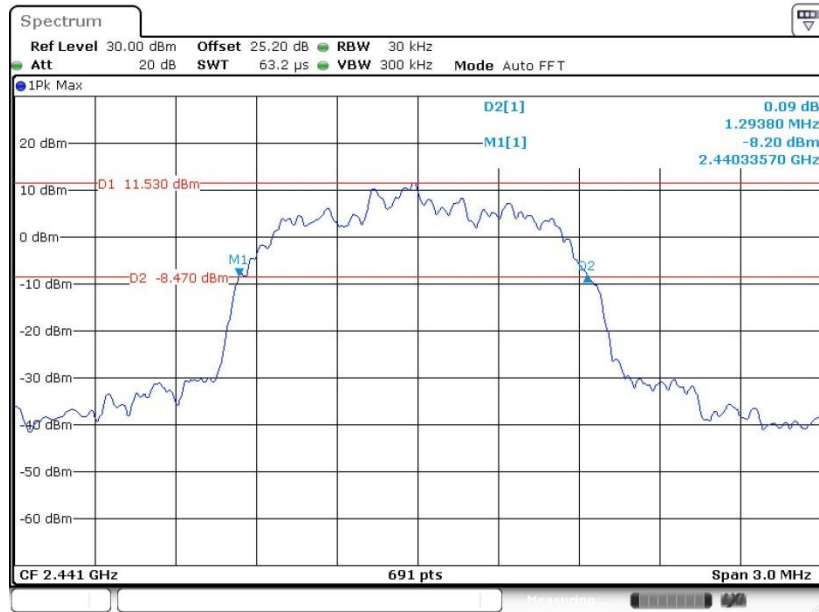

Date: 6.JAN.2020 00:48:37

20 dB Bandwidth Plot on Channel 78

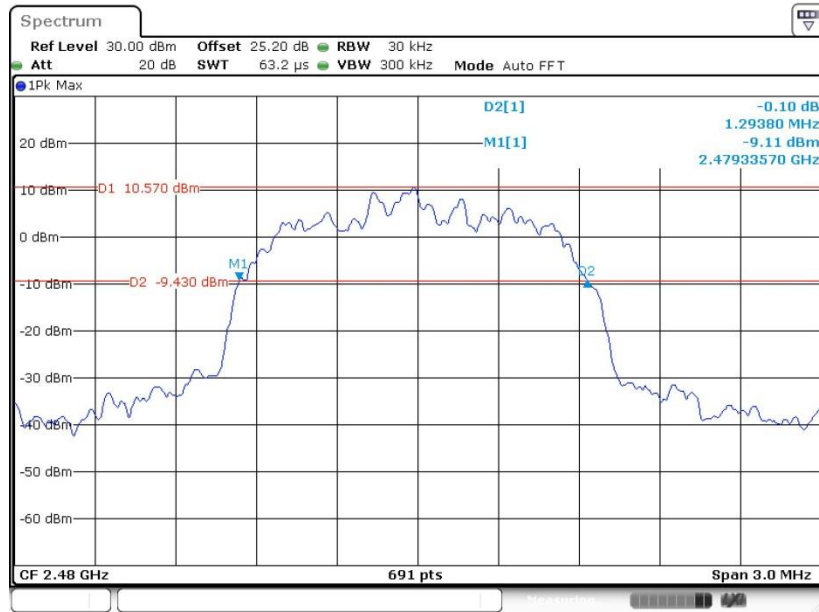

Date: 6.JAN.2020 00:53:12



<3Mbps>

20 dB Bandwidth Plot on Channel 00

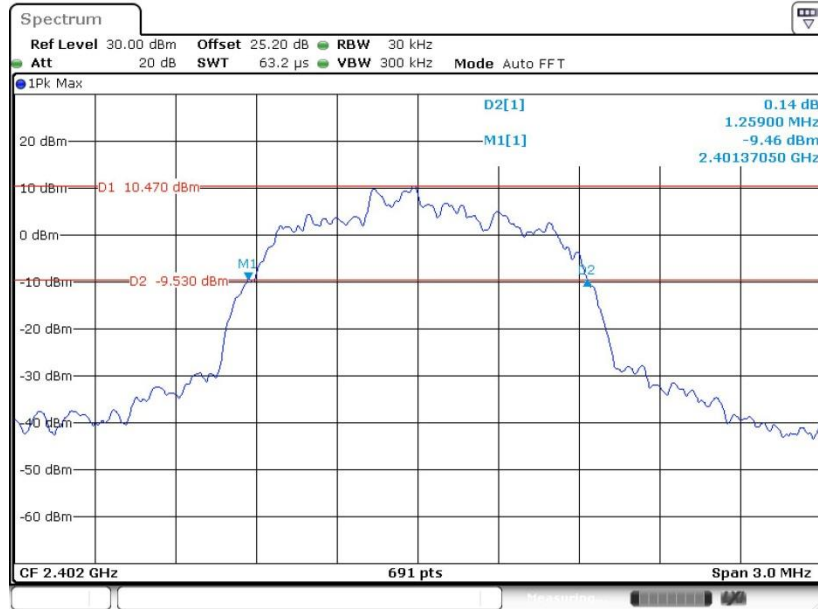

Date: 6.JAN.2020 00:58:41

20 dB Bandwidth Plot on Channel 39

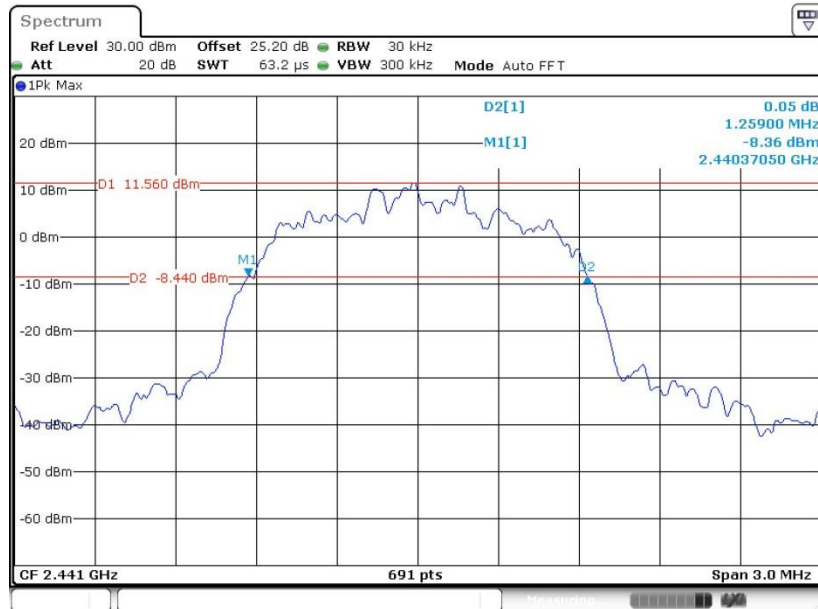

Date: 6.JAN.2020 01:03:47



20 dB Bandwidth Plot on Channel 78

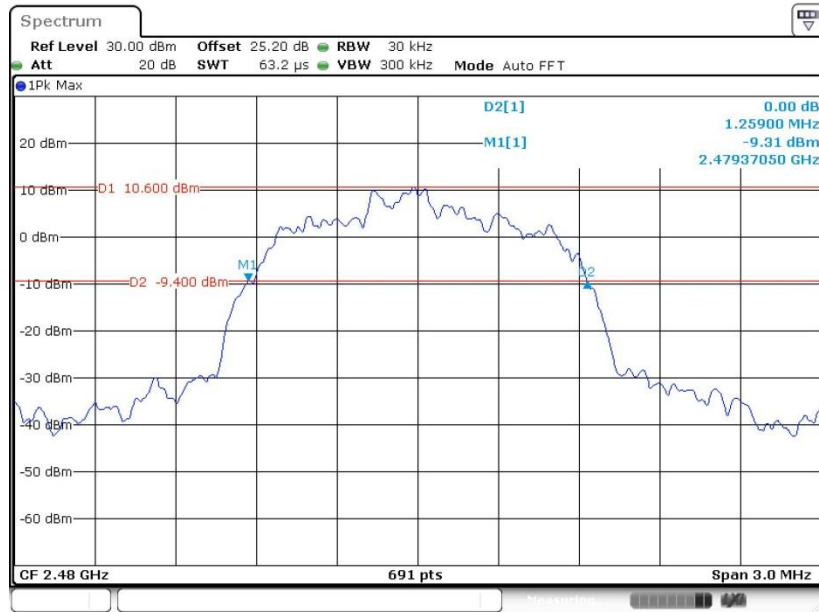

Date: 6.JAN.2020 01:09:32



3.4.6 Test Result of 99% Occupied Bandwidth

Please refer to Appendix A.

<1Mbps>

99% Occupied Bandwidth Plot on Channel 00

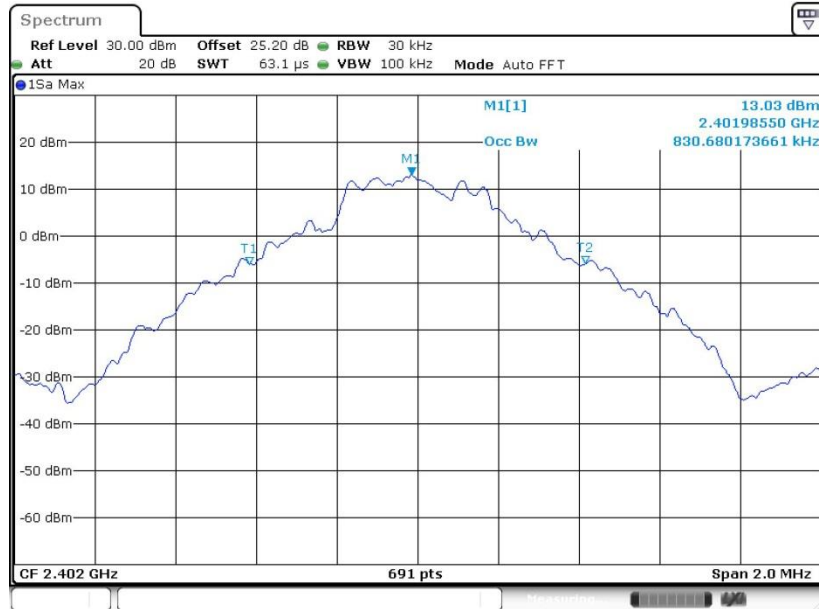

Date: 6.JAN.2020 00:29:10



99% Occupied Bandwidth Plot on Channel 39

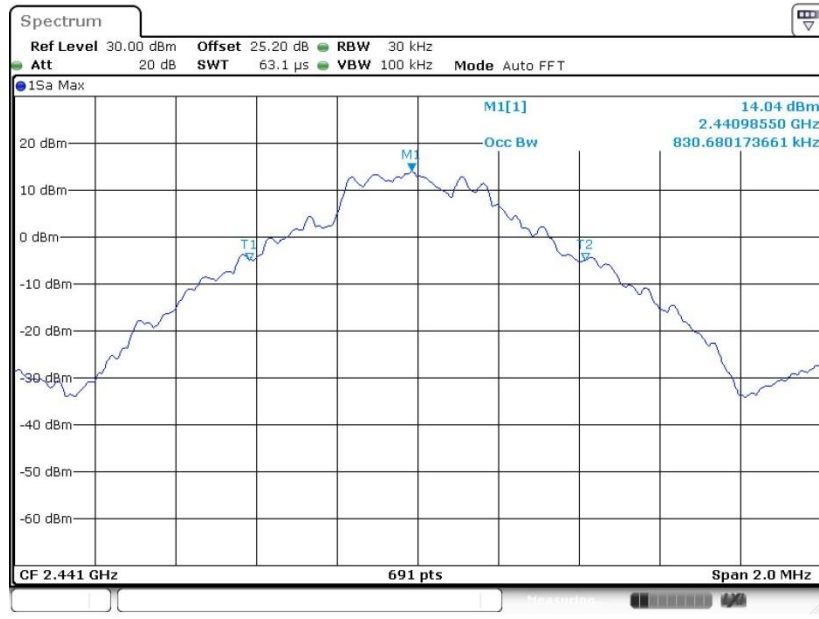

Date: 6.JAN.2020 00:35:29

99% Occupied Bandwidth Plot on Channel 78

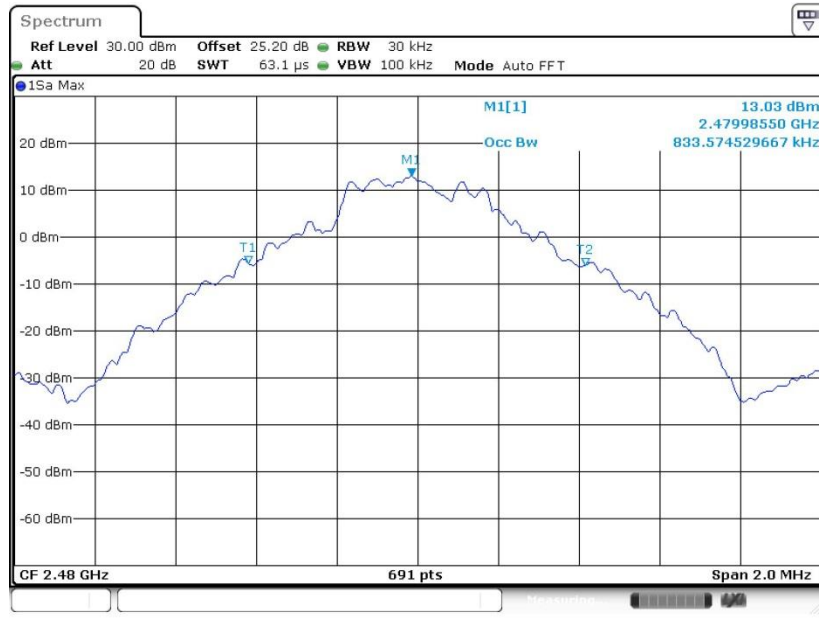

Date: 6.JAN.2020 00:40:09



<2Mbps>

99% Occupied Bandwidth Plot on Channel 00

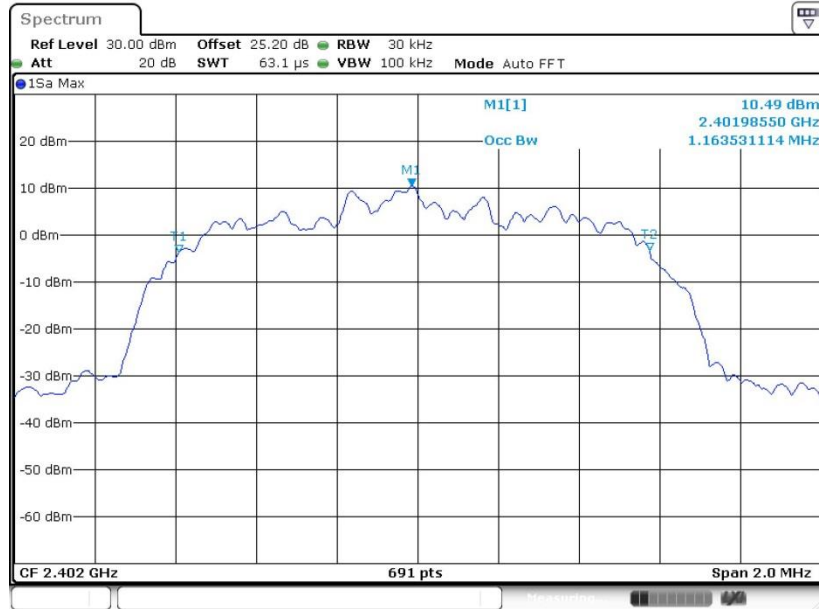

Date: 6.JAN.2020 00:44:20

99% Occupied Bandwidth Plot on Channel 39

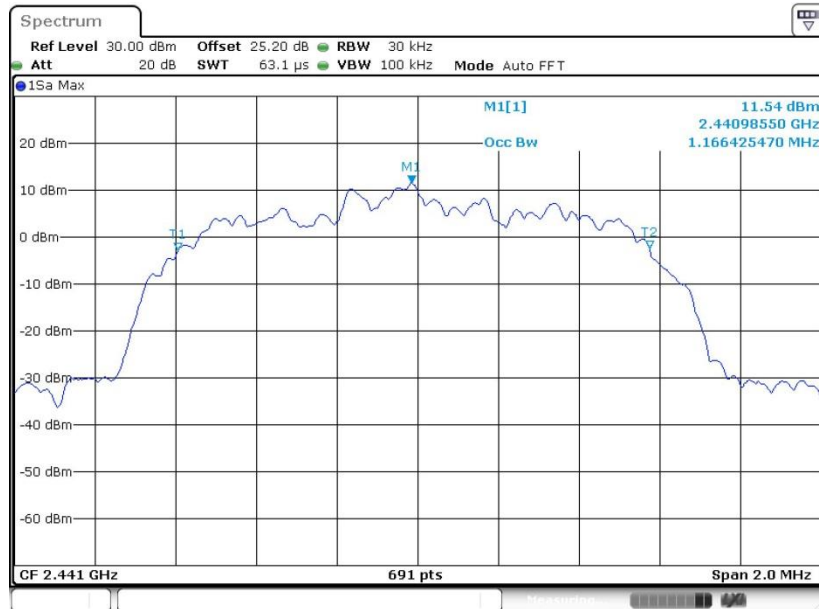

Date: 6.JAN.2020 00:47:42



99% Occupied Bandwidth Plot on Channel 78

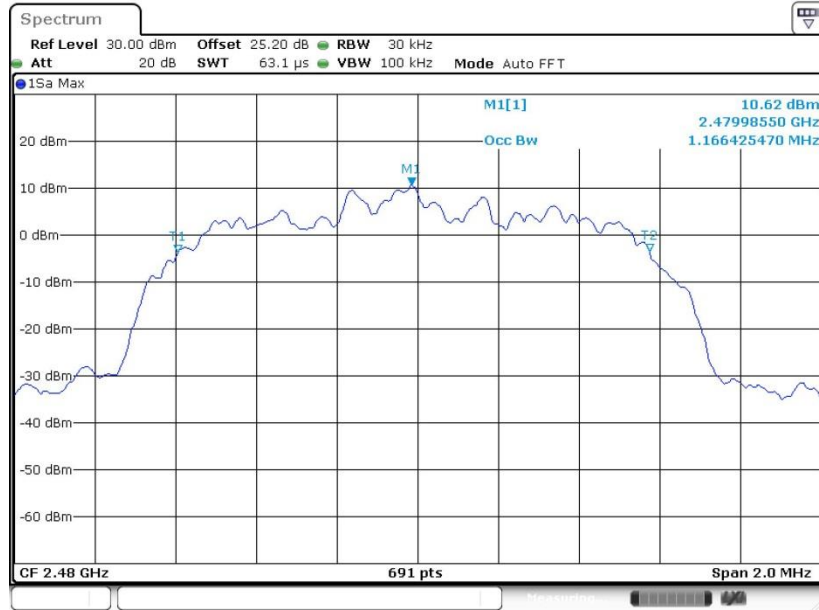

Date: 6.JAN.2020 00:50:50

<3Mbps>

99% Occupied Bandwidth Plot on Channel 00

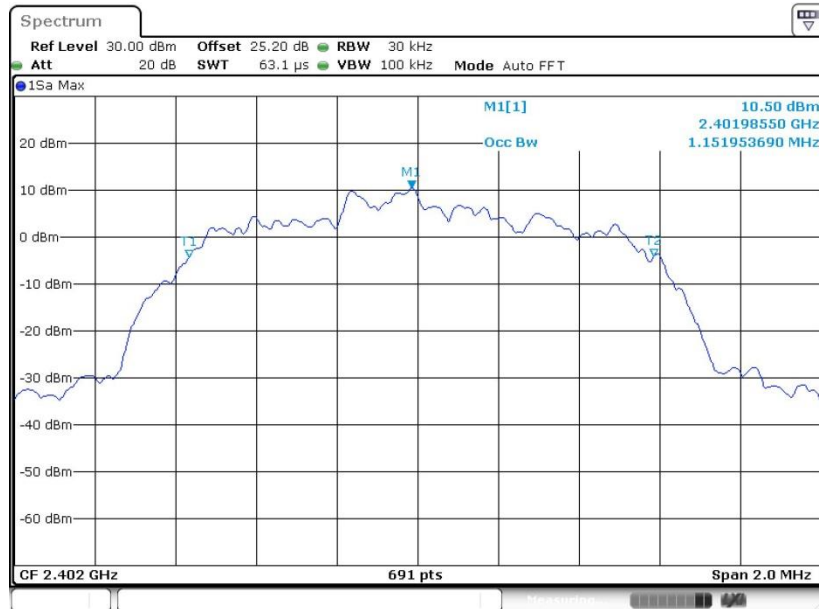

Date: 6.JAN.2020 00:56:28



99% Occupied Bandwidth Plot on Channel 39

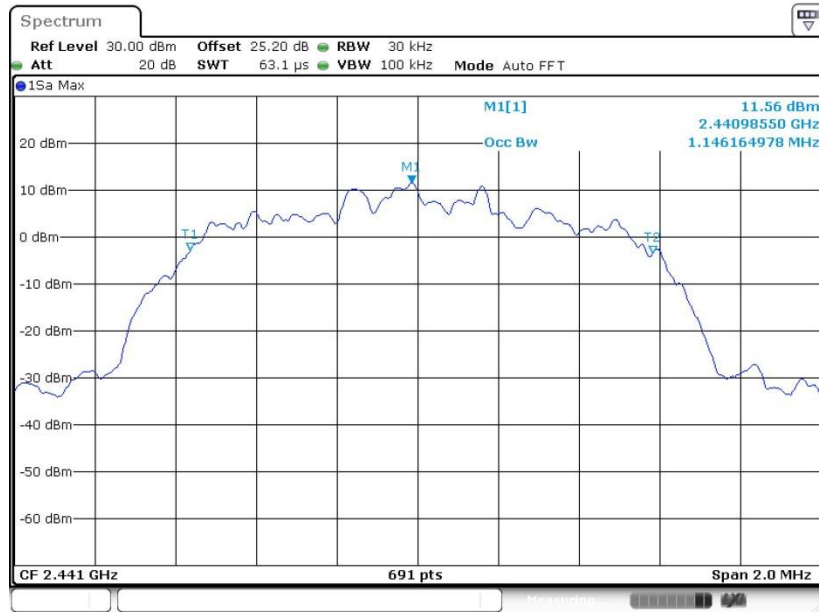

Date: 6.JAN.2020 01:01:26

99% Occupied Bandwidth Plot on Channel 78



Date: 6.JAN.2020 01:06:08

Note: The occupied channel bandwidth is maintained within the band of operation for all of the modulations.

3.5 Output Power Measurement

3.5.1 Limit of Output Power

The maximum peak conducted output power of the intentional radiator shall not exceed the following:
For frequency hopping systems operating in the 2400-2483.5 MHz band employing at least 75 non-overlapping hopping channels, and all frequency hopping systems in the 5725-5850 MHz band: 1 watt. For all other frequency hopping systems in the 2400-2483.5 MHz band 0.125 watts.

3.5.2 Measuring Instruments

See list of measuring equipment of this test report.

3.5.3 Test Procedures

1. The testing follows ANSI C63.10-2013 clause 7.8.5.
2. The RF output of EUT was connected to the power meter by RF cable and attenuator. The path loss was compensated to the results for each measurement.
3. Set to the maximum power setting and enable the EUT transmit continuously.
4. Measure the conducted output power with cable loss and record the results in the test report.
5. Measure and record the results in the test report.

3.5.4 Test Setup

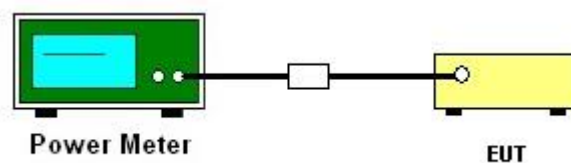

3.5.5 Test Result of Peak Output Power

Please refer to Appendix A.

3.5.6 Test Result of Average Output Power (Reporting Only)

Please refer to Appendix A.

3.6 Conducted Band Edges Measurement

3.6.1 Limit of Band Edges

In any 100 kHz bandwidth outside the intentional radiation frequency band, the radio frequency power shall be at least 20 dB below the highest level of the radiated power. In addition, radiated emissions which fall in the restricted bands must also comply with the radiated emission limits.

3.6.2 Measuring Instruments

See list of measuring equipment of this test report.

3.6.3 Test Procedures

1. The testing follows ANSI C63.10-2013 clause 7.8.6.
2. Set to the maximum power setting and enable the EUT transmit continuously.
3. Set RBW = 100kHz, VBW = 300kHz. Band edge emissions must be at least 20 dB down from the highest emission level within the authorized band as measured with a 100kHz RBW. The attenuation shall be 30 dB instead of 20 dB when RMS conducted output power procedure is used.
4. Enable hopping function of the EUT and then repeat step 2. and 3.
5. Measure and record the results in the test report.

3.6.4 Test Setup

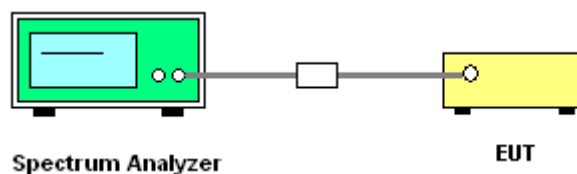



3.6.5 Test Result of Conducted Band Edges

<1Mbps>

Low Band Edge Plot on Channel 00

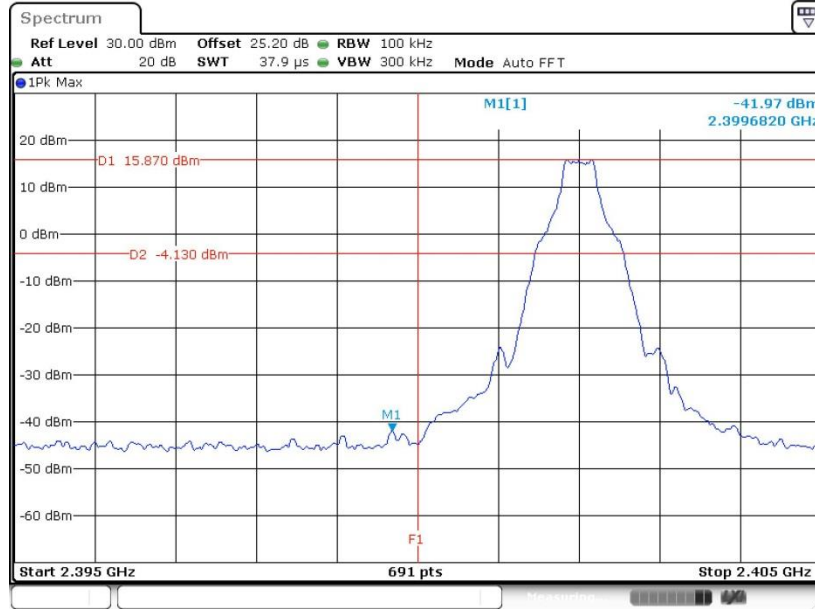

Date: 6.JAN.2020 00:30:06

High Band Edge Plot on Channel 78

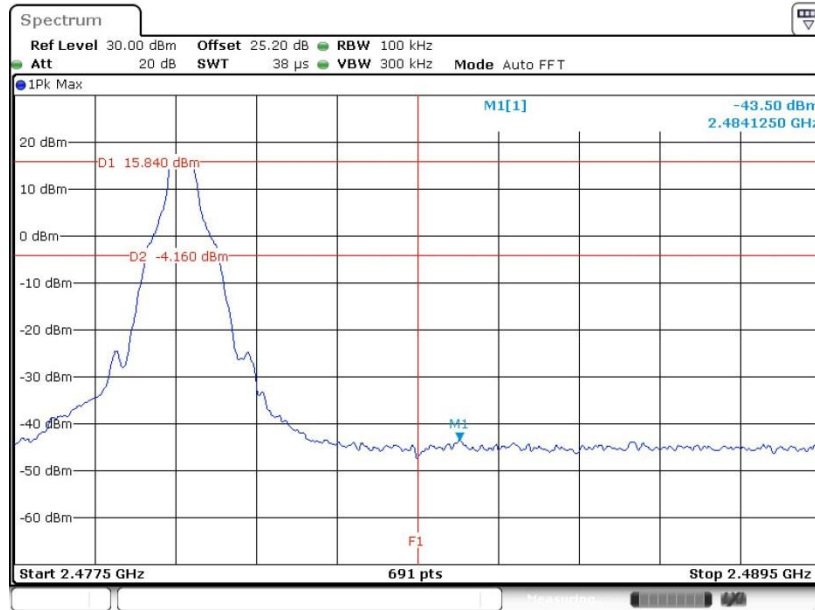

Date: 6.JAN.2020 00:40:44



<2Mbps>

Low Band Edge Plot on Channel 00

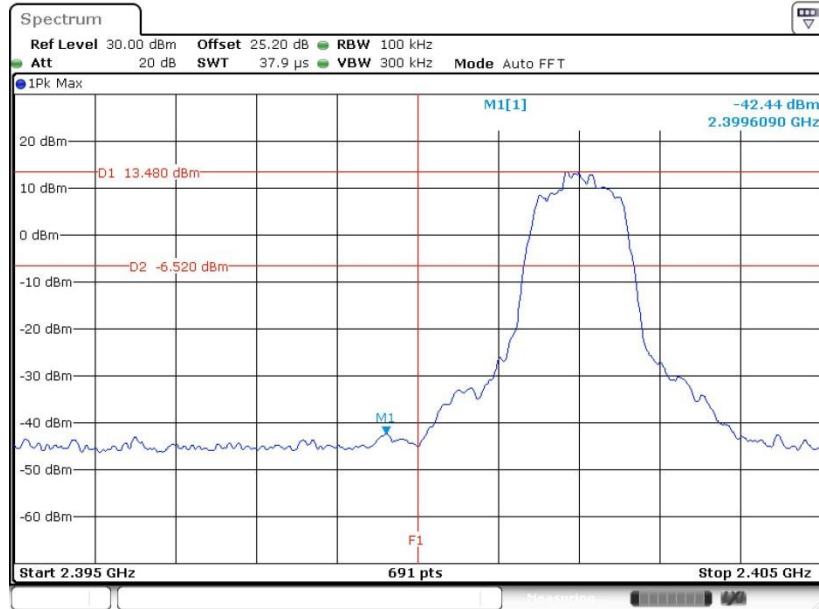

Date: 6.JAN.2020 00:44:43

High Band Edge Plot on Channel 78

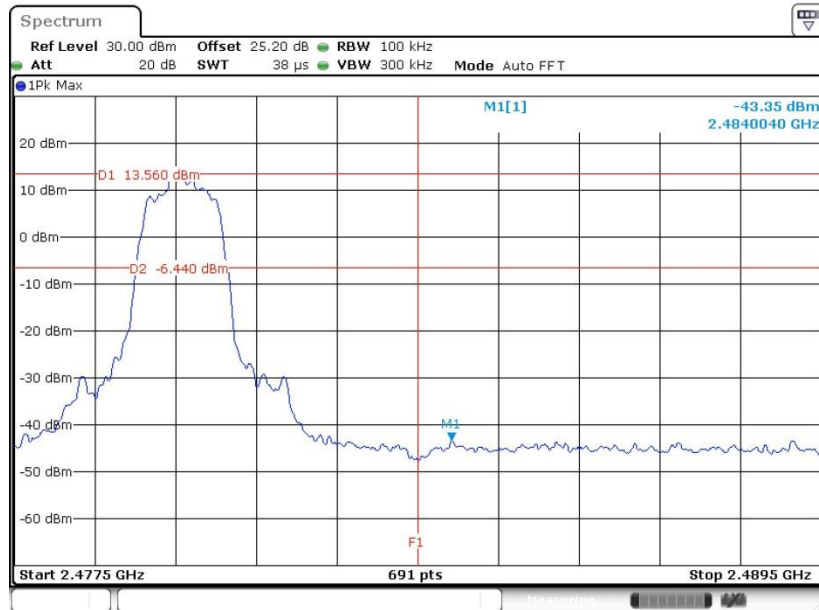

Date: 6.JAN.2020 00:51:24



<3Mbps>

Low Band Edge Plot on Channel 00

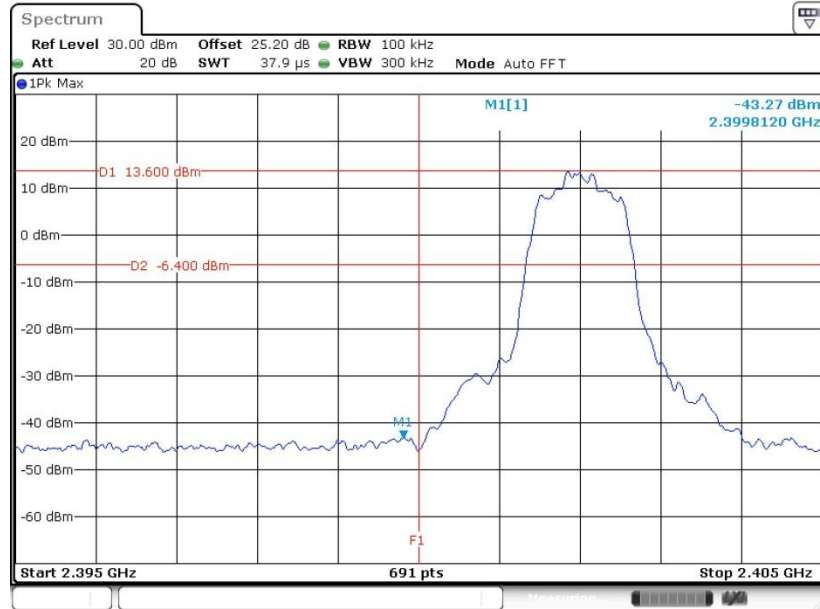

Date: 6.JAN.2020 00:57:11

High Band Edge Plot on Channel 78

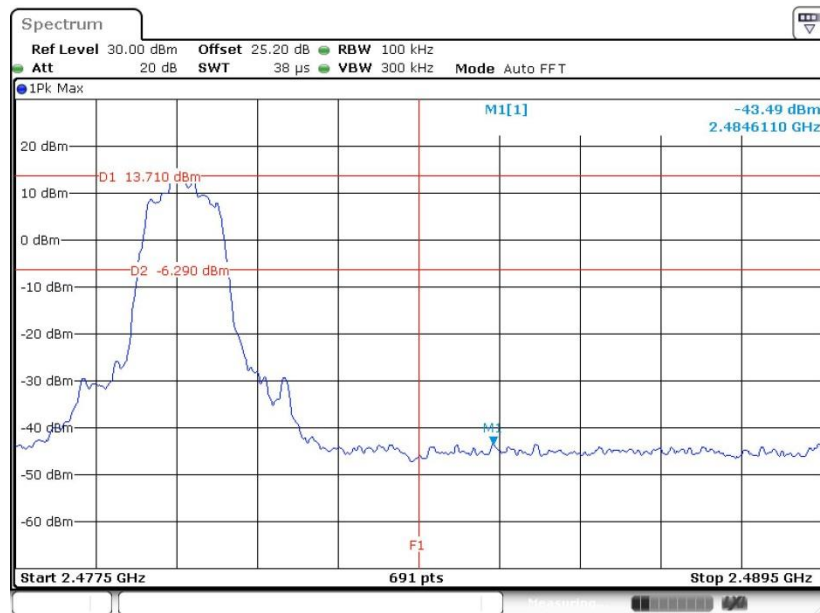

Date: 6.JAN.2020 01:06:48



3.6.6 Test Result of Conducted Hopping Mode Band Edges

<1Mbps>

Hopping Mode Low Band Edge Plot

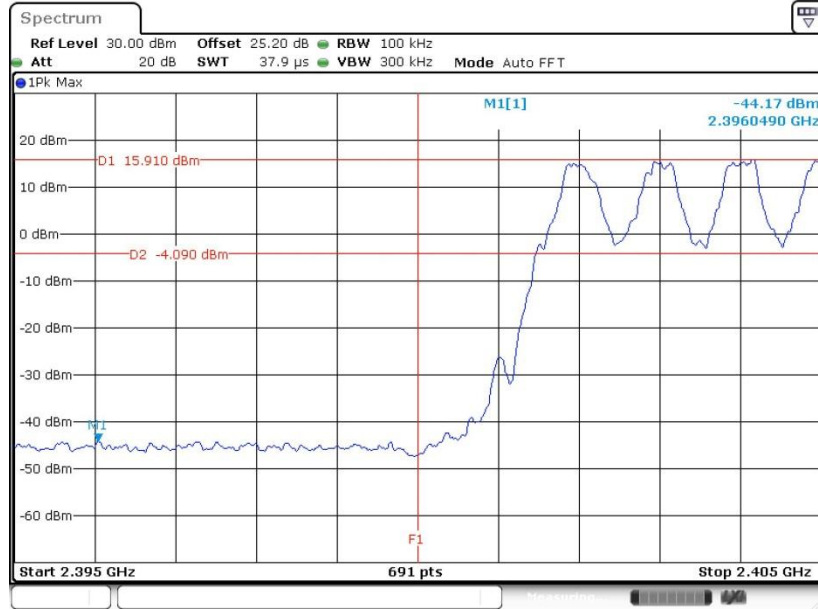

Hopping Mode High Band Edge Plot

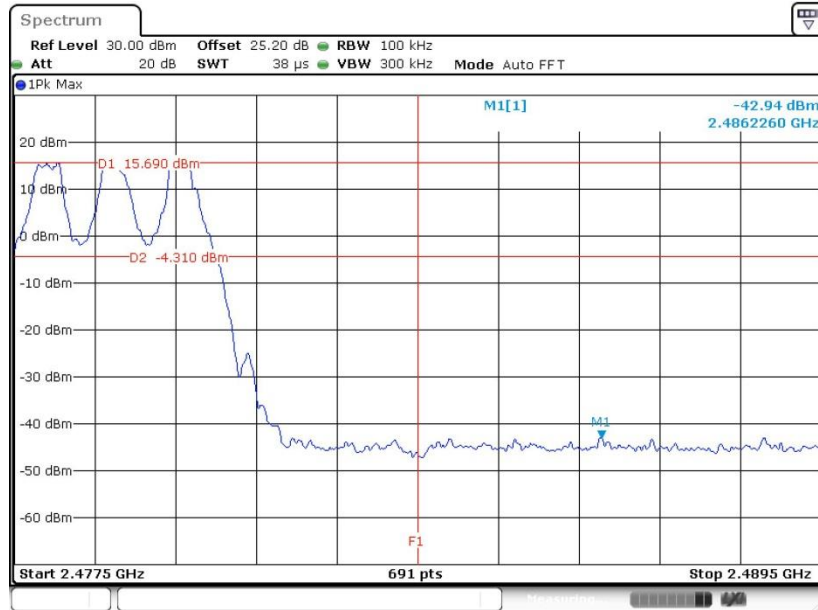



<2Mbps>

Hopping Mode Low Band Edge Plot

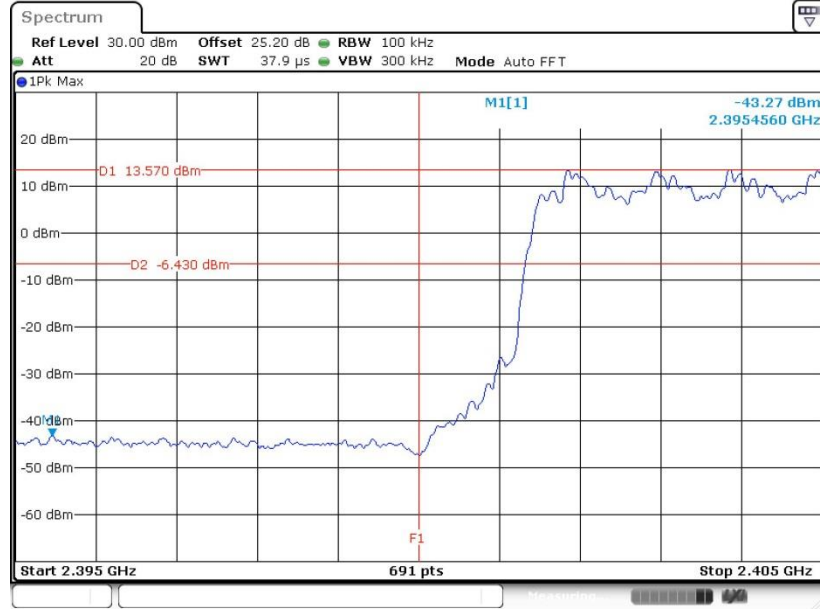

Date: 6.JAN.2020 00:10:07

Hopping Mode High Band Edge Plot

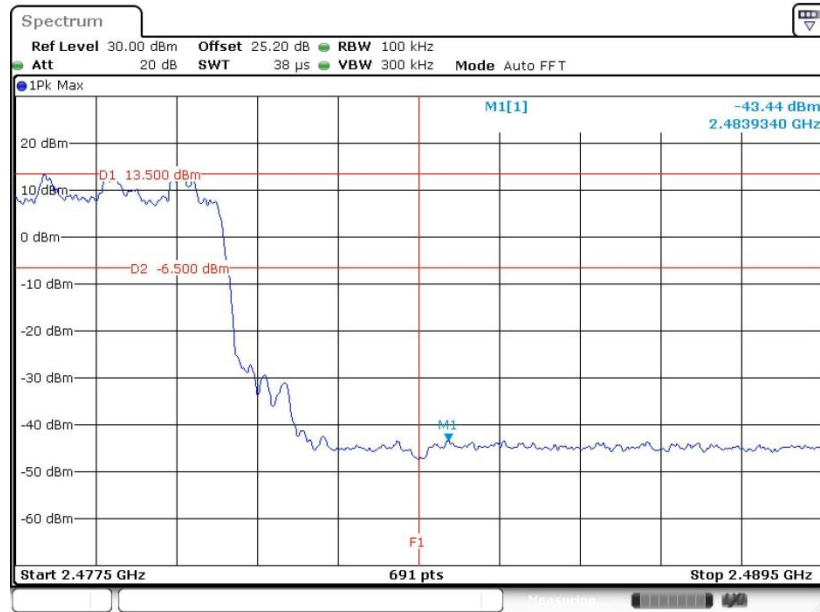

Date: 6.JAN.2020 00:10:58



<3Mbps>

Hopping Mode Low Band Edge Plot

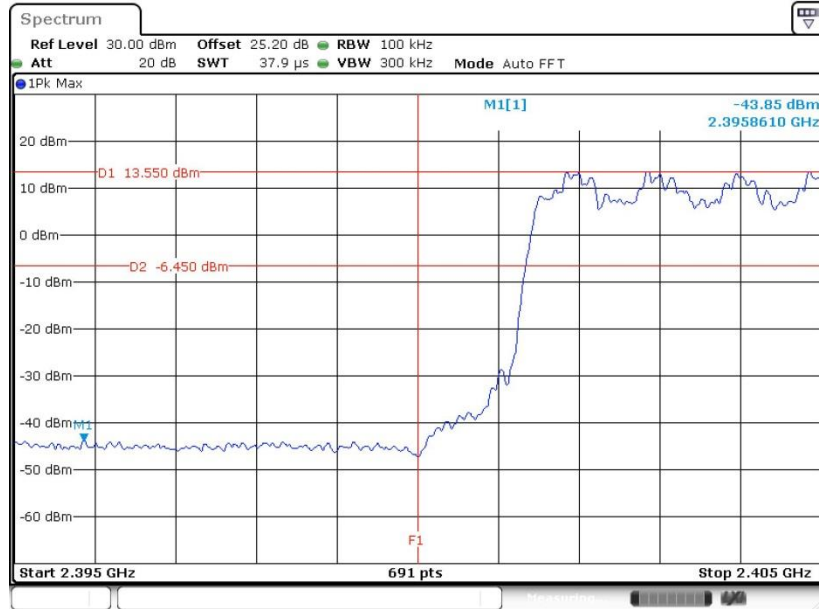

Date: 6.JAN.2020 00:11:41

Hopping Mode High Band Edge Plot

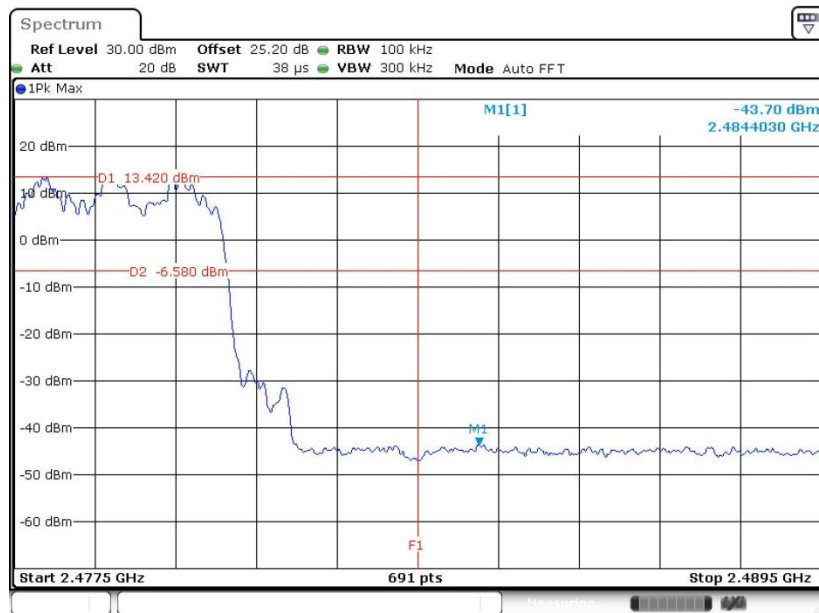

Date: 6.JAN.2020 00:12:13

3.7 Conducted Spurious Emission Measurement

3.7.1 Limit of Spurious Emission Measurement

In any 100 kHz bandwidth outside the intentional radiation frequency band, the radio frequency power shall be at least 20 dB below the highest level of the radiated power. In addition, radiated emissions which fall in the restricted bands must also comply with the radiated emission limits.

3.7.2 Measuring Instruments

See list of measuring equipment of this test report.

3.7.3 Test Procedure

1. The testing follows ANSI C63.10-2013 clause 7.8.8.
2. The RF output of EUT was connected to the spectrum analyzer by RF cable and attenuator. The path loss was compensated to the results for each measurement.
3. Set to the maximum power setting and enable the EUT transmit continuously.
4. Set RBW = 100 kHz, VBW = 300kHz, scan up through 10th harmonic. All harmonics / spurs must be at least 20 dB down from the highest emission level within the authorized band as measured with a 100 kHz RBW.
5. Measure and record the results in the test report.
6. The RF fundamental frequency should be excluded against the limit line in the operating frequency band.

3.7.4 Test Setup

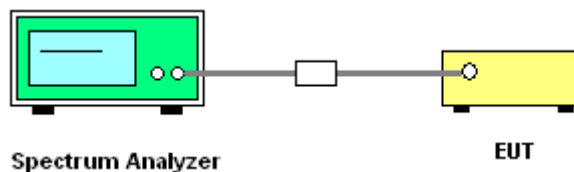



3.7.5 Test Result of Conducted Spurious Emission

<1Mbps>

CSE Plot on Ch 00 between 30MHz ~ 3 GHz

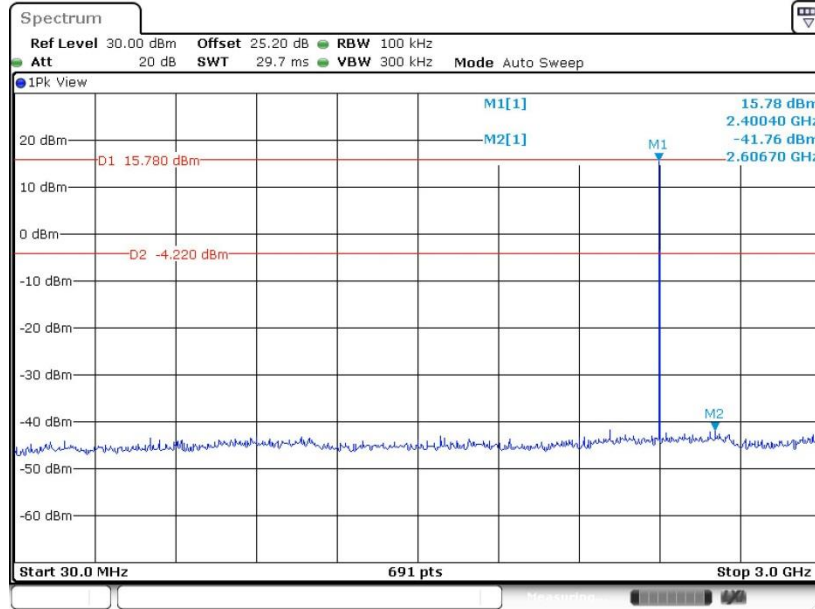

1Mbps CSE Plot on Ch 00 between 2 GHz ~ 25 GHz

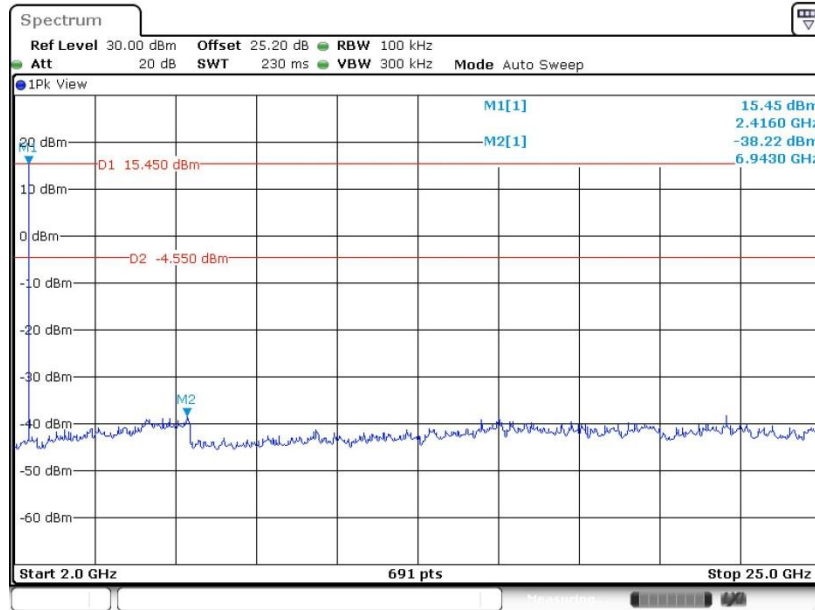



CSE Plot on Ch 39 between 30MHz ~ 3 GHz

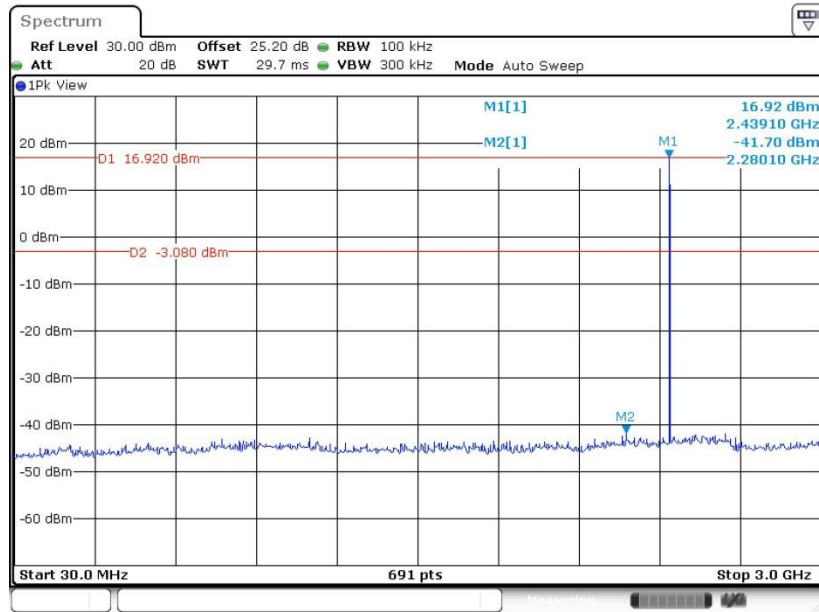

Date: 6.JAN.2020 00:34:22

CSE Plot on Ch 39 between 2 GHz ~ 25 GHz

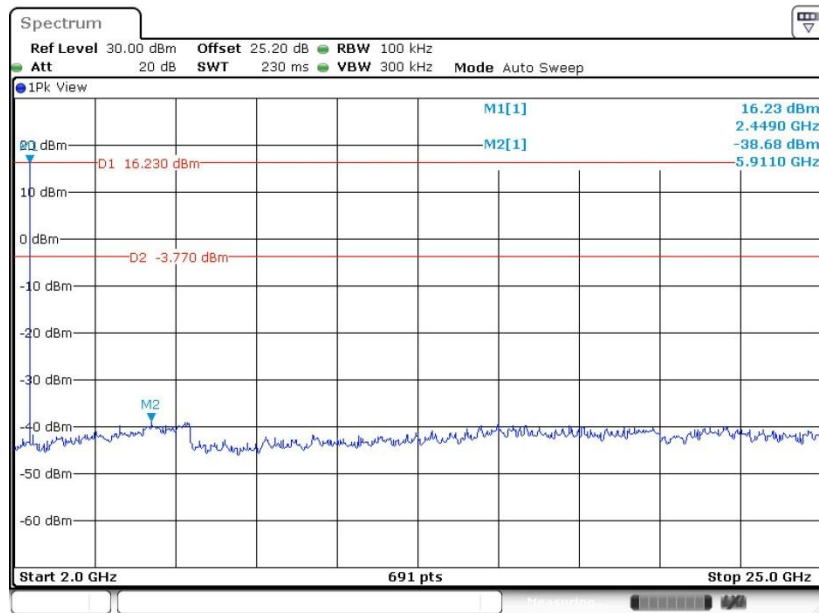

Date: 6.JAN.2020 00:34:51



CSE Plot on Ch 78 between 30MHz ~ 3 GHz

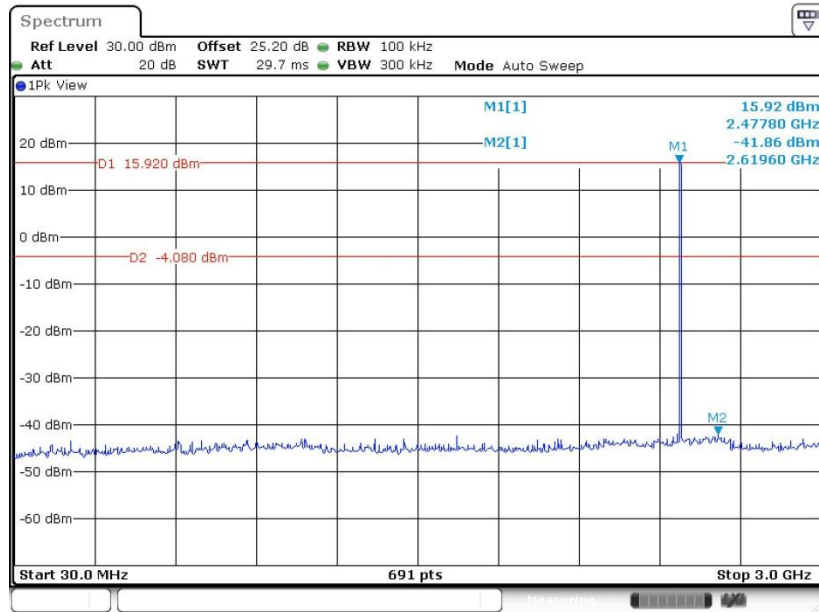

Date: 6.JAN.2020 00:39:01

CSE Plot on Ch 78 between 2 GHz ~ 25 GHz

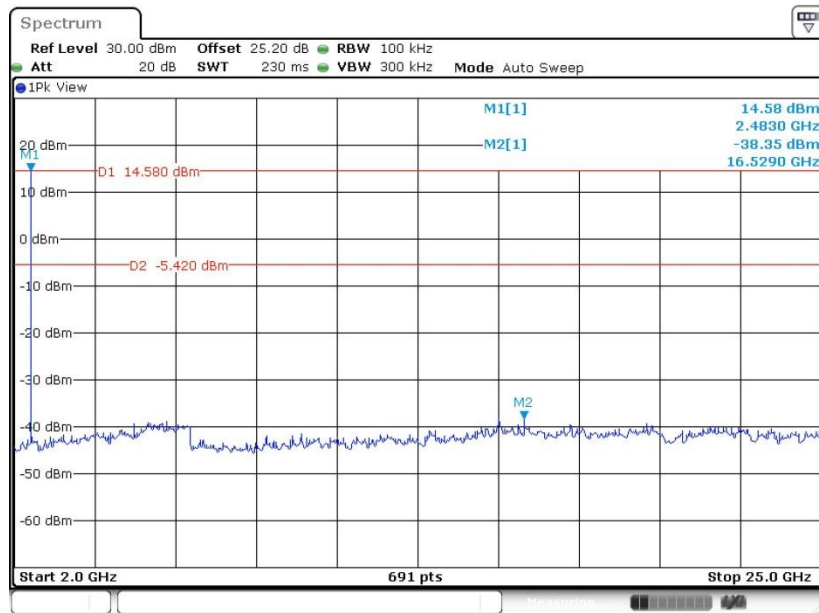

Date: 6.JAN.2020 00:39:33



<2Mbps>

CSE Plot on Ch 00 between 30MHz ~ 3 GHz

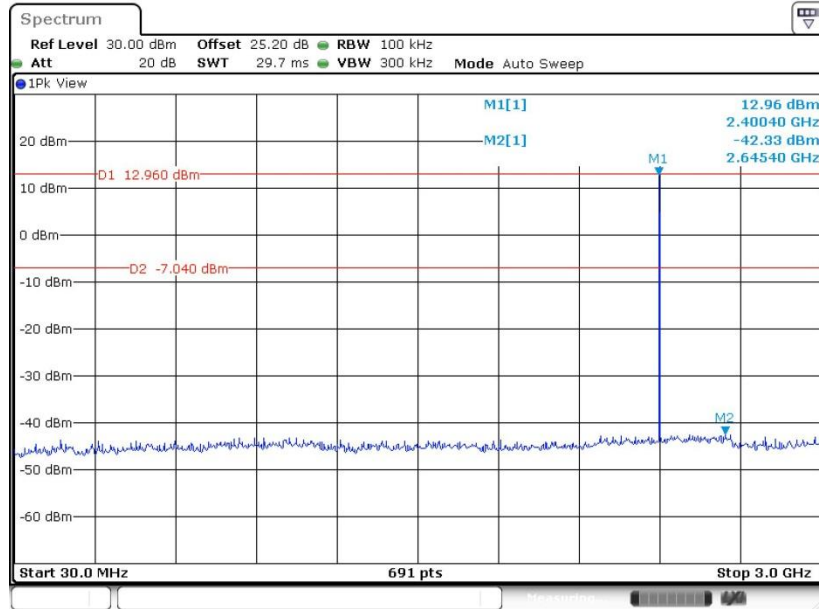

Date: 6.JAN.2020 00:43:10

CSE Plot on Ch 00 between 2 GHz ~ 25 GHz

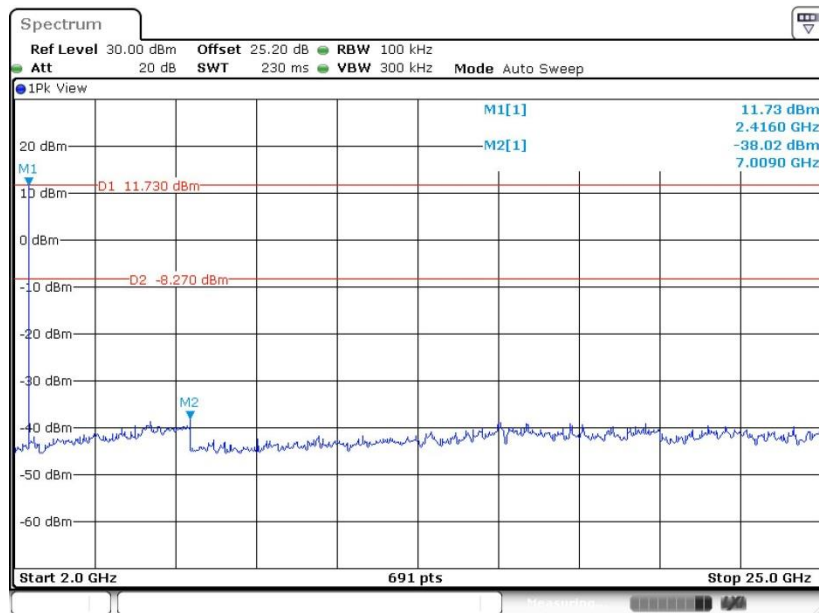

Date: 6.JAN.2020 00:43:41



CSE Plot on Ch 39 between 30MHz ~ 3 GHz

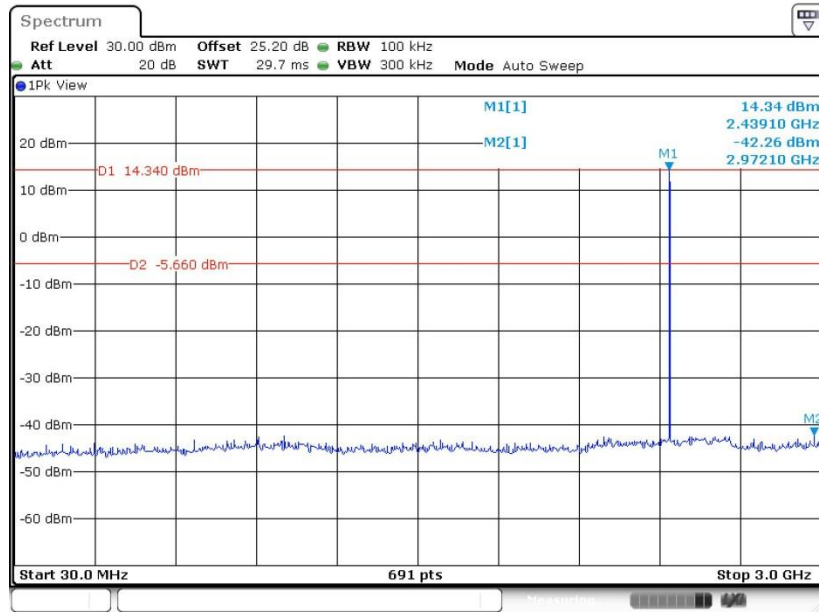

Date: 6.JAN.2020 00:46:21

CSE Plot on Ch 39 between 2 GHz ~ 25 GHz

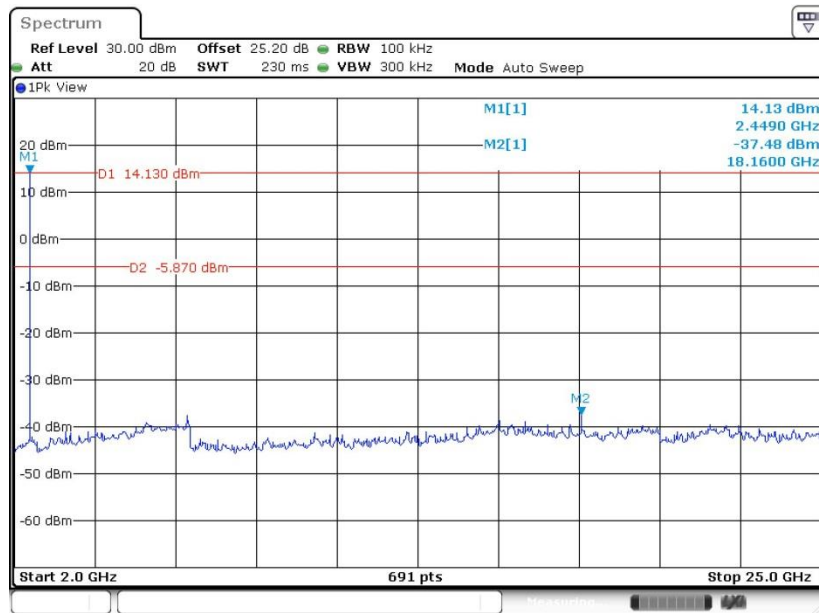

Date: 6.JAN.2020 00:46:51



CSE Plot on Ch 78 between 30MHz ~ 3 GHz

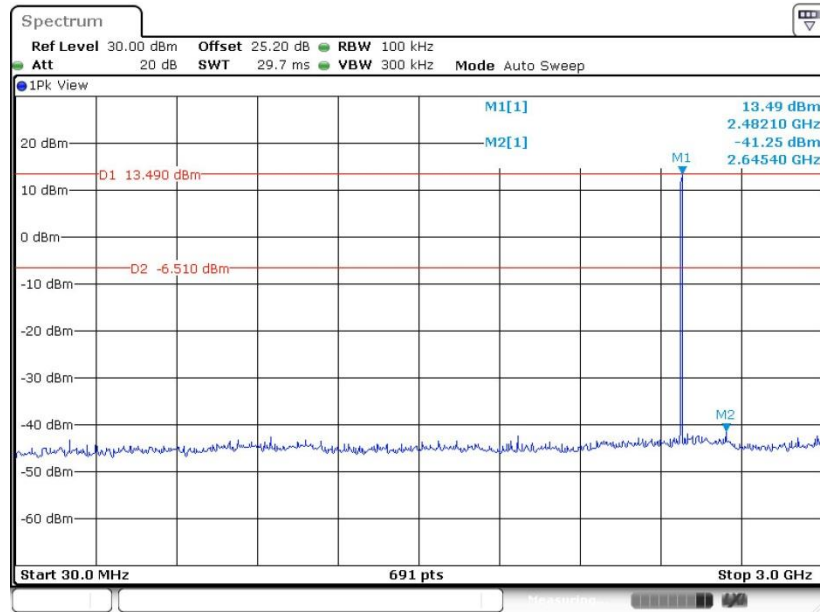

Date: 6.JAN.2020 00:49:14

CSE Plot on Ch 78 between 2 GHz ~ 25 GHz

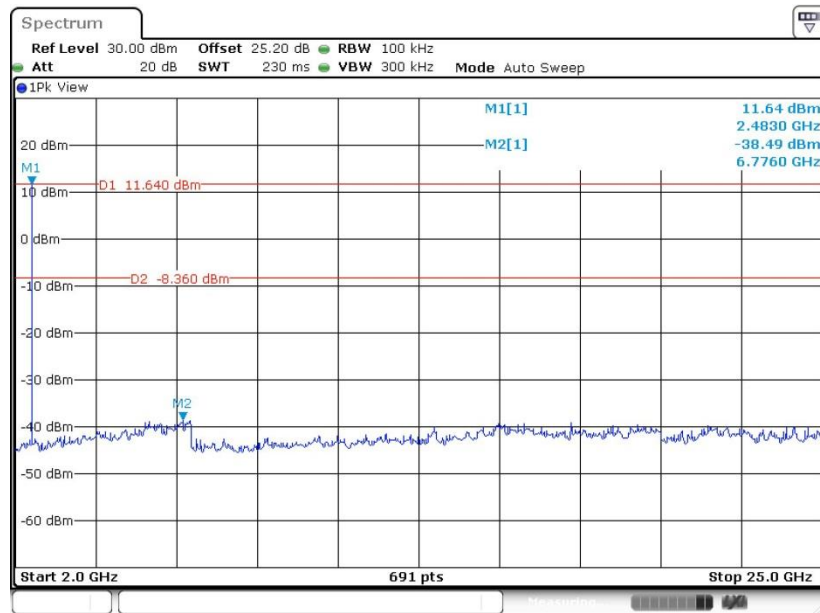

Date: 6.JAN.2020 00:49:57



<3Mbps>

CSE Plot on Ch 00 between 30MHz ~ 3 GHz

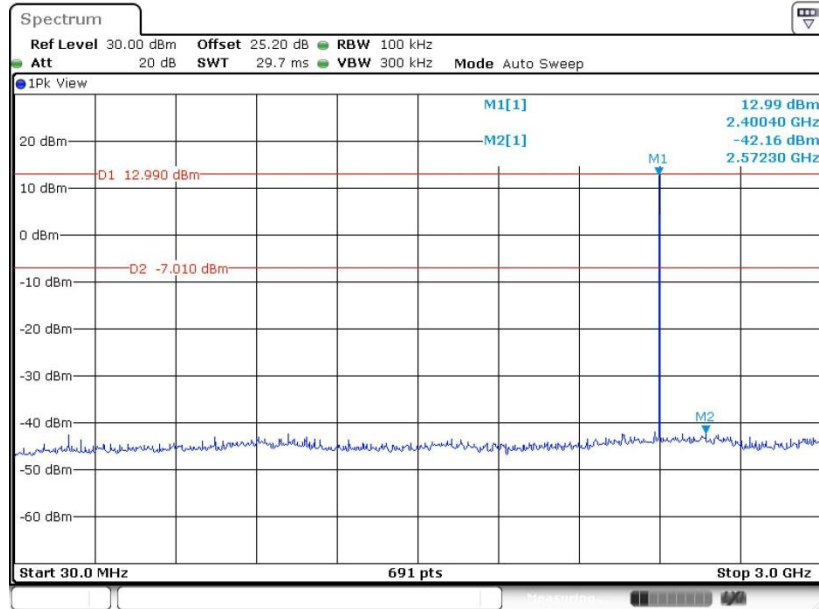

Date: 6.JAN.2020 00:55:09

CSE Plot on Ch 00 between 2 GHz ~ 25 GHz

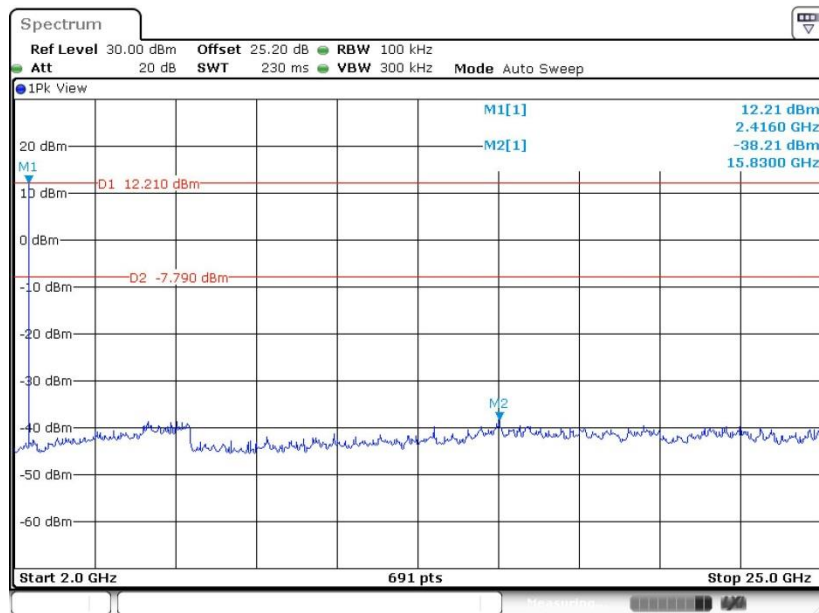

Date: 6.JAN.2020 00:55:50



CSE Plot on Ch 39 between 30MHz ~ 3 GHz

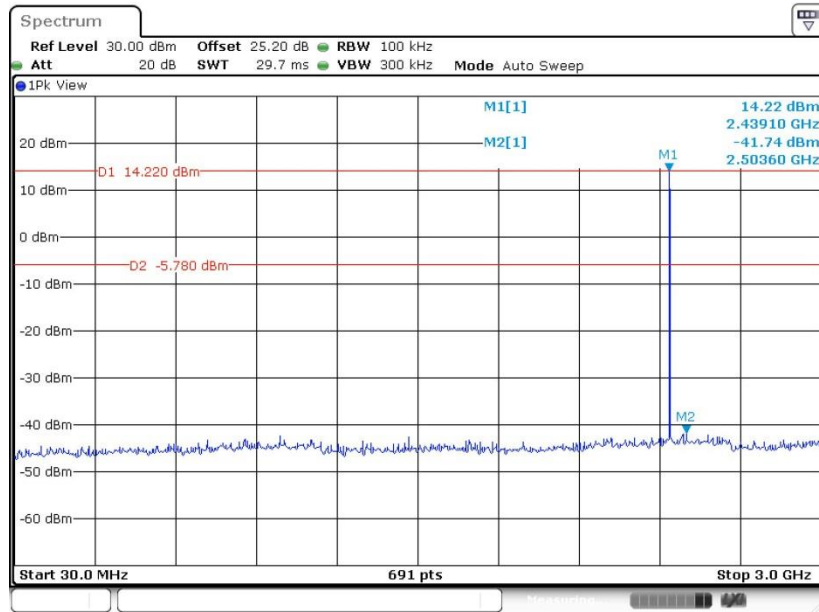

Date: 6.JAN.2020 00:59:17

CSE Plot on Ch 39 between 2 GHz ~ 25 GHz

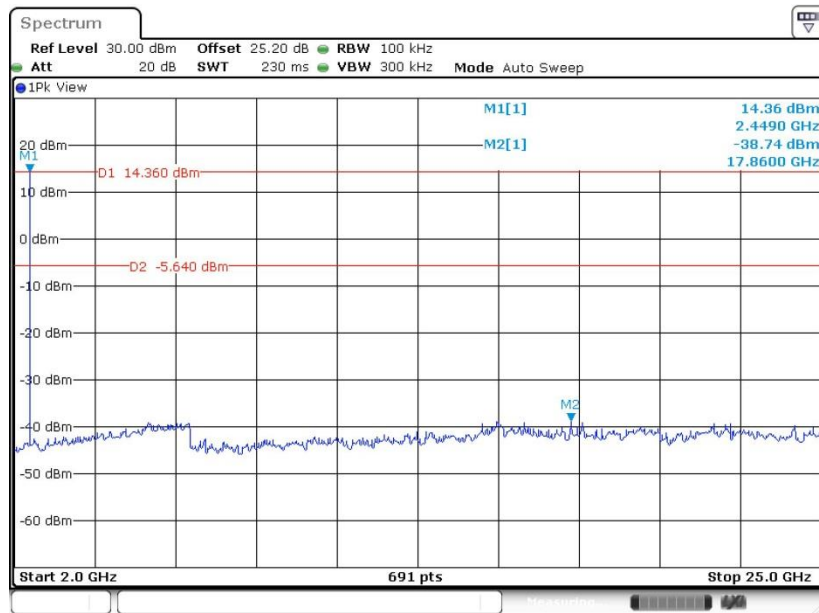

Date: 6.JAN.2020 01:00:40



CSE Plot on Ch 78 between 30MHz ~ 3 GHz

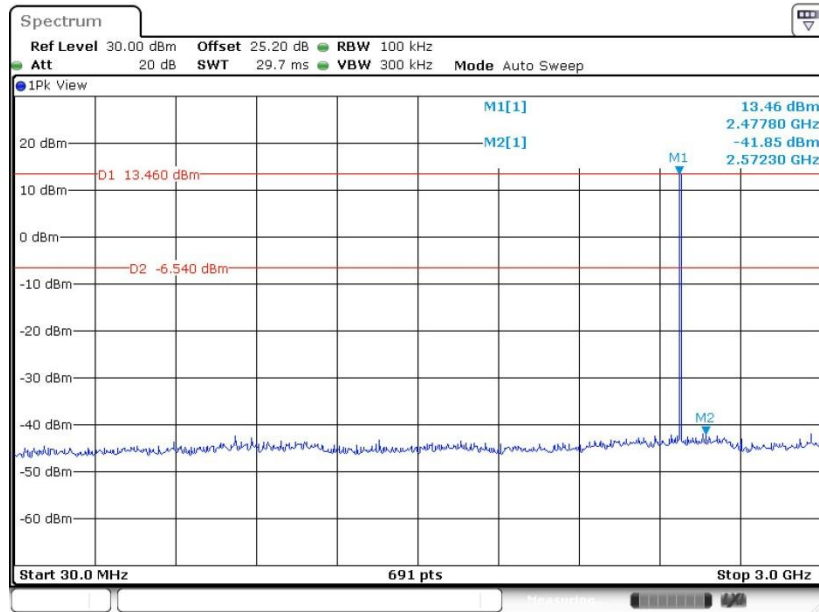

Date: 6.JAN.2020 01:04:57

CSE Plot on Ch 78 between 2 GHz ~ 25 GHz

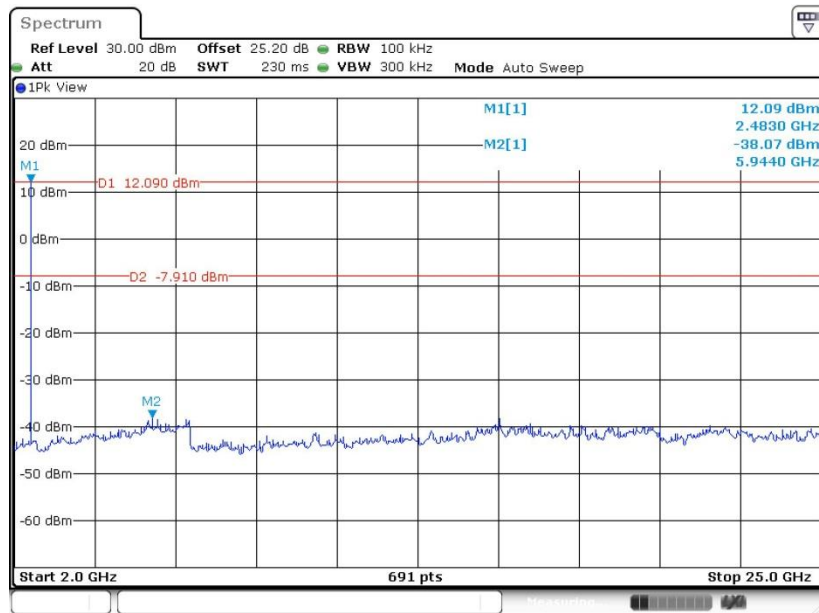

Date: 6.JAN.2020 01:05:31



3.8 Radiated Band Edges and Spurious Emission Measurement

3.8.1 Limit of Radiated Band Edges and Spurious Emission

In any 100 kHz bandwidth outside the intentional radiator frequency band, all harmonics/spurious must be at least 20 dB below the highest emission level within the authorized band. In addition, radiated emissions which fall in the restricted bands must also comply with the limits as below.

Frequency (MHz)	Field Strength (microvolts/meter)	Measurement Distance (meters)
0.009 – 0.490	2400/F(kHz)	300
0.490 – 1.705	24000/F(kHz)	30
1.705 – 30.0	30	30
30 – 88	100	3
88 – 216	150	3
216 - 960	200	3
Above 960	500	3

3.8.2 Measuring Instruments

See list of measuring equipment of this test report.



3.8.3 Test Procedures

1. The EUT was placed on a turntable with 0.8 meter for frequency below 1GHz and 1.5 meter for frequency above 1GHz respectively above ground.
2. The EUT was set 3 meters from the interference receiving antenna, which was mounted on the top of a variable height antenna tower.
3. For each suspected emission, the EUT was arranged to its worst case and then tune the Antenna tower (from 1 m to 4 m) and turntable (from 0 degree to 360 degrees) to find the maximum reading. A pre-amp and a high pass filter are used for the test in order to get better signal level to comply with the guidelines.
4. Set to the maximum power setting and enable the EUT transmit continuously.
5. Use the following spectrum analyzer settings:
 - (1) Span shall wide enough to fully capture the emission being measured;
 - (2) Set RBW=100 kHz for $f < 1 \text{ GHz}$, RBW=1MHz for $f > 1\text{GHz}$; VBW \geq RBW; Sweep = auto; Detector function = peak; Trace = max hold for peak
 - (3) For average measurement: use duty cycle correction factor method per 15.35(c).
Duty cycle = On time/100 milliseconds
On time = $N_1 * L_1 + N_2 * L_2 + \dots + N_{n-1} * L_{n-1} + N_n * L_n$
Where N_1 is number of type 1 pulses, L_1 is length of type 1 pulses, etc.
Average Emission Level = Peak Emission Level + $20 * \log(\text{Duty cycle})$
6. Corrected Reading: Antenna Factor + Cable Loss + Read Level - Preamp Factor = Level
7. For testing below 1GHz, if the emission level of the EUT in peak mode was 3 dB lower than the limit specified, then peak values of EUT will be reported, otherwise, the emissions will be repeated one by one using the CISPR quasi-peak method and reported.
8. For testing above 1GHz, the emission level of the EUT in peak mode was 20dB lower than average limit (that means the emission level in average mode also complies with the limit in average mode), then peak values of EUT will be reported, otherwise, the emissions will be measured in average mode again and reported.

Note: The average levels were calculated from the peak level corrected with duty cycle correction factor (-24.79dB) derived from $20 \log(\text{dwell time}/100\text{ms})$. This correction is only for signals that hop with the fundamental signal, such as band-edge and harmonic. Other spurious signals that are independent of the hopping signal would not use this correction.

3.8.4 Test Setup

For radiated emissions below 30MHz

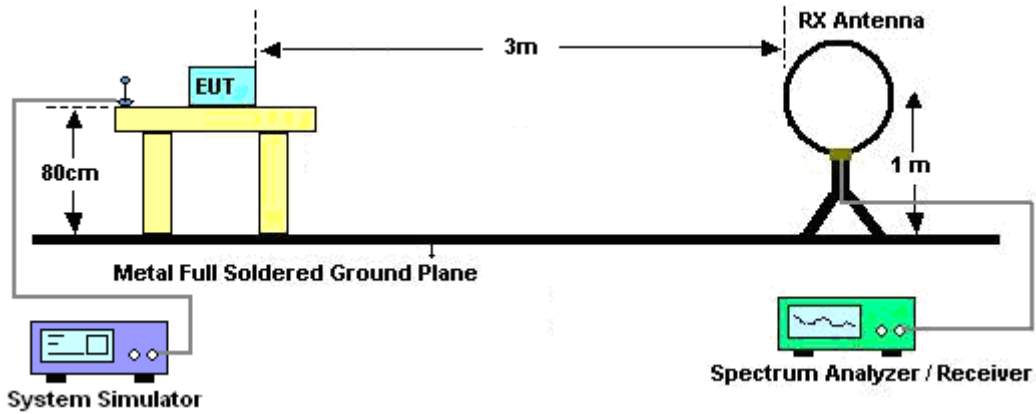

For radiated emissions from 30MHz to 1GHz

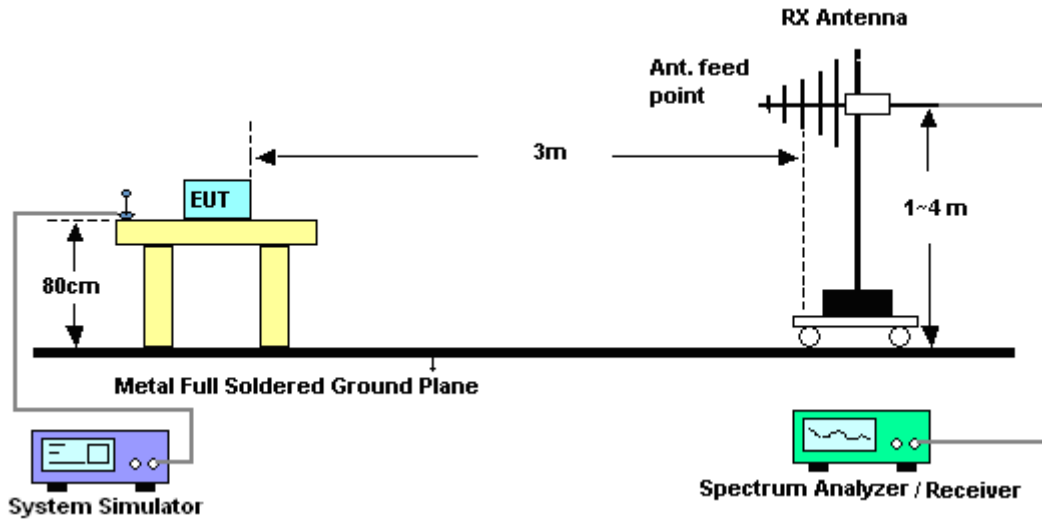

For radiated emissions above 1GHz

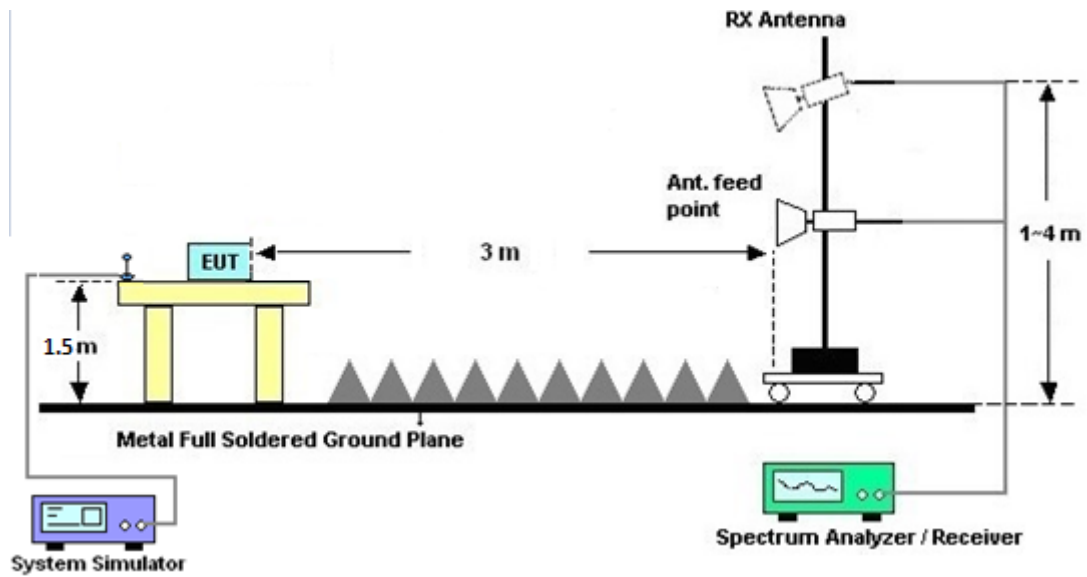

3.8.5 Test Results of Radiated Spurious Emissions (9 kHz ~ 30 MHz)

The low frequency, which started from 9 kHz to 30MHz, was pre-scanned and the result which was 20dB lower than the limit line was not reported.

There is a comparison data of both open-field test site and alternative test site - semi-Anechoic chamber according to 414788 D01 Radiated Test Site v01r01, and the result came out very similar.

3.8.6 Test Result of Radiated Spurious at Band Edges

Please refer to Appendix C and D.

3.8.7 Duty Cycle

Please refer to Appendix E.

3.8.8 Test Result of Radiated Spurious Emission (30MHz ~ 10th Harmonic)

Please refer to Appendix C and D.

3.9 AC Conducted Emission Measurement

3.9.1 Limit of AC Conducted Emission

For equipment that is designed to be connected to the public utility (AC) power line, the radio frequency voltage that is conducted back onto the AC power line on any frequency or frequencies within the band 150 kHz to 30 MHz shall not exceed the limits in the following table.

Frequency of emission (MHz)	Conducted limit (dB μ V)	
	Quasi-peak	Average
0.15-0.5	66 to 56*	56 to 46*
0.5-5	56	46
5-30	60	50

*Decreases with the logarithm of the frequency.

3.9.2 Measuring Instruments

See list of measuring equipment of this test report.

3.9.3 Test Procedures

1. The EUT was placed 0.4 meter from the conducting wall of the shielding room was kept at least 80 centimeters from any other grounded conducting surface.
2. Connect EUT to the power mains through a line impedance stabilization network (LISN).
3. All the support units are connecting to the other LISN.
4. The LISN provides 50 ohm coupling impedance for the measuring instrument.
5. The FCC states that a 50 ohm, 50 microhenry LISN should be used.
6. Both sides of AC line were checked for maximum conducted interference.
7. The frequency range from 150 kHz to 30 MHz was searched.
8. Set the test-receiver system to Peak Detect Function and specified bandwidth (IF Bandwidth = 9kHz) with Maximum Hold Mode. Then measurement is also conducted by Average Detector and Quasi-Peak Detector Function respectively.

3.9.4 Test Setup

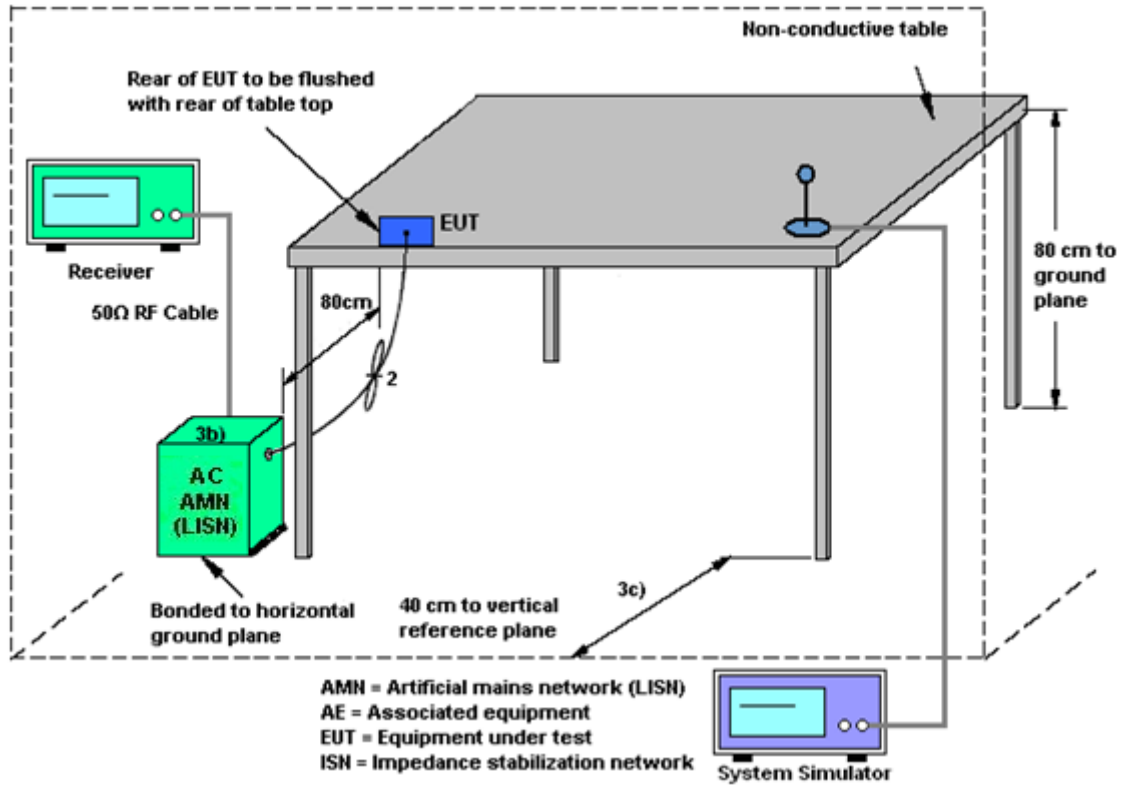

3.9.5 Test Result of AC Conducted Emission

Please refer to Appendix B.



3.10 Antenna Requirements

3.10.1 Standard Applicable

If directional gain of transmitting antennas is greater than 6dBi, the power shall be reduced by the same level in dB comparing to gain minus 6dBi. The use of a permanently attached antenna or of an antenna that uses a unique coupling to the intentional radiator shall be considered sufficient to comply with the rule.

3.10.2 Antenna Anti-Replacement Construction

An embedded-in antenna design is used.

3.10.3 Antenna Gain

The antenna peak gain of EUT is less than 6 dBi. Therefore, it is not necessary to reduce maximum peak output power limit.



4 List of Measuring Equipment

Instrument	Manufacturer	Model No.	Serial No.	Characteristics	Calibration Date	Test Date	Due Date	Remark
AC Power Source	ChainTek	APC-1000W	N/A	N/A	N/A	Jan. 07, 2020	N/A	Conduction (CO05-HY)
EMI Test Receiver	Rohde & Schwarz	ESR3	102388	9kHz~3.6GHz	Nov. 15, 2019	Jan. 07, 2020	Nov. 14, 2020	Conduction (CO05-HY)
Hygrometer	Testo	608-H1	34913912	N/A	Mar. 19, 2019	Jan. 07, 2020	Mar. 18, 2020	Conduction (CO05-HY)
LISN	Rohde & Schwarz	ENV216	100081	9kHz~30MHz	Nov. 15, 2019	Jan. 07, 2020	Nov. 14, 2020	Conduction (CO05-HY)
Software	Rohde & Schwarz	EMC32 V10.30	N/A	N/A	N/A	Jan. 07, 2020	N/A	Conduction (CO05-HY)
LF Cable	HUBER + SUHNER	RG-214/U	LF01	N/A	Jan. 02, 2020	Jan. 07, 2020	Jan. 01, 2021	Conduction (CO05-HY)
Pulse Limiter	Rohde & Schwarz	ESH3-Z2	100851	N/A	Jan. 02, 2020	Jan. 07, 2020	Jan. 01, 2021	Conduction (CO05-HY)
Hygrometer	Testo	608-H2	41410069	N/A	Jun. 17, 2019	Dec. 23, 2019~Jan. 06., 2020	Jun. 16, 2020	Conducted (TH05-HY)
Power Meter	Agilent	E4416A	GB41292344	N/A	Dec. 27, 2018	Dec. 23, 2019~Jan. 06., 2020	Dec. 26, 2019	Conducted (TH05-HY)
Power Sensor	Agilent	E9327A	US40441548	50MHz~18GHz	Dec. 27, 2018	Dec. 23, 2019~Jan. 06., 2020	Dec. 26, 2019	Conducted (TH05-HY)
Power Meter	Agilent	E4416A	GB41292344	N/A	Dec. 27, 2019	Dec. 23, 2019~Jan. 06., 2020	Dec. 26, 2020	Conducted (TH05-HY)
Power Sensor	Agilent	E9327A	US40441548	50MHz~18GHz	Dec. 27, 2019	Dec. 23, 2019~Jan. 06., 2020	Dec. 26, 2020	Conducted (TH05-HY)
Signal Analyzer	Rohde & Schwarz	FSV40	101566	10Hz~40GHz	Jul. 15, 2019	Dec. 23, 2019~Jan. 06., 2020	Jul. 14, 2020	Conducted (TH05-HY)
Switch Box & RF Cable	Burgeon	ETF-058	EC1208382	N/A	Mar. 27, 2019	Dec. 23, 2019~Jan. 06., 2020	Mar. 26, 2020	Conducted (TH05-HY)



Instrument	Manufacturer	Model No.	Serial No.	Characteristics	Calibration Date	Test Date	Due Date	Remark
Preamplifier	EMEC INSTRUMENT S&PE	EMC184045B &PE7005-6	980192	18GHz ~ 40GHz	Aug. 01, 2019	Jan. 09, 2020~ Jan. 17, 2020	Jul. 31, 2020	Radiation (03CH15-HY)
Horn Antenna	SCHWARZBECK	BBHA 9120 D	9120D-1620	1-18GHz	Oct. 28, 2019	Jan. 09, 2020~ Jan. 17, 2020	Oct. 27, 2020	Radiation (03CH15-HY)
SHF-EHF Horn Antenna	SCHWARZBECK	BBHA 9170	BBHA9170576	18GHz~40GHz	May 14, 2019	Jan. 09, 2020~ Jan. 17, 2020	May 13, 2020	Radiation (03CH15-HY)
Preamplifier	Jet-Power	JPA0118-55-303	1710001800055007	1GHz~18GHz	Apr. 01, 2019	Jan. 09, 2020~ Jan. 17, 2020	May 31, 2020	Radiation (03CH15-HY)
Preamplifier	Keysight	83017A	MY53270195	1GHz~26.5GHz	Aug. 23, 2019	Jan. 09, 2020~ Jan. 17, 2020	Aug. 22, 2020	Radiation (03CH15-HY)
EMI Test Receiver	Keysight	N9038A(MXE)	MY54130085	20MHz~8.4GHz	Nov. 01, 2019	Jan. 09, 2020~ Jan. 17, 2020	Oct. 31, 2020	Radiation (03CH15-HY)
Signal Analyzer	R&S	FSV3044	101009	10Hz~44GHz	Nov. 11, 2019	Jan. 09, 2020~ Jan. 17, 2020	Nov. 10, 2020	Radiation (03CH15-HY)
Controller	ChainTek	3000-1	N/A	Control Turn table & Ant Mast	N/A	Jan. 09, 2020~ Jan. 17, 2020	N/A	Radiation (03CH15-HY)
Antenna Mast	ChainTek	MBS-520-1	N/A	1m~4m	N/A	Jan. 09, 2020~ Jan. 17, 2020	N/A	Radiation (03CH15-HY)
Turn Table	ChainTek	T-200-S-1	N/A	0~360 Degree	N/A	Jan. 09, 2020~ Jan. 17, 2020	N/A	Radiation (03CH15-HY)
Software	Audix	E3 6.2009-8-24(k5)	RK-000451	N/A	N/A	Jan. 09, 2020~ Jan. 17, 2020	N/A	Radiation (03CH15-HY)
RF Cable	HUBER + SUHNER	SUCOFLEX 104	MY36980/4	30M-18G	Apr. 15, 2019	Jan. 09, 2020~ Jan. 17, 2020	Apr. 14, 2020	Radiation (03CH15-HY)
RF Cable	HUBER + SUHNER	SUCOFLEX 104	MY9838/4PE	30M-18G	Apr. 15, 2019	Jan. 09, 2020~ Jan. 17, 2020	Apr. 14, 2020	Radiation (03CH15-HY)
RF Cable	HUBER + SUHNER	SUCOFLEX 104	MY802430/4	30M~18G	May. 13, 2019	Jan. 09, 2020~ Jan. 17, 2020	May. 12, 2020	Radiation (03CH15-HY)
RF Cable	HUBER + SUHNER	SUCOFLEX 102	505134/2	30MHz-40GHz	Feb. 26, 2019	Jan. 09, 2020~ Jan. 17, 2020	Feb. 25, 2020	Radiation (03CH15-HY)
RF Cable	HUBER + SUHNER	SUCOFLEX 102	800740/2	30MHz-40GHz	Feb. 26, 2019	Jan. 09, 2020~ Jan. 17, 2020	Feb. 25, 2020	Radiation (03CH15-HY)
Filter	Wainwright	WHKX12-2700-3000-18000-60ST	SN2	3GHz High Pass Filter	Jul. 17, 2019	Jan. 09, 2020~ Jan. 17, 2020	Jul. 14, 2020	Radiation (03CH15-HY)



5 Uncertainty of Evaluation

Uncertainty of Conducted Emission Measurement (150 kHz ~ 30 MHz)

Measuring Uncertainty for a Level of Confidence of 95% ($U = 2Uc(y)$)	2.0
---	-----

Uncertainty of Radiated Emission Measurement (30 MHz ~ 1000 MHz)

Measuring Uncertainty for a Level of Confidence of 95% ($U = 2Uc(y)$)	5.0
---	-----

Uncertainty of Radiated Emission Measurement (1000 MHz ~ 18000 MHz)

Measuring Uncertainty for a Level of Confidence of 95% ($U = 2Uc(y)$)	5.4
---	-----

Uncertainty of Radiated Emission Measurement (18000 MHz ~ 40000 MHz)

Measuring Uncertainty for a Level of Confidence of 95% ($U = 2Uc(y)$)	5.0
---	-----

Appendix A. Test Result of Conducted Test Items

Test Engineer:	Hank Hsu / Luffy Lin	Temperature:	21~25	°C
Test Date:	2019/12/23 ~2020/01/06	Relative Humidity:	51~54	%

TEST RESULTS DATA**20dB and 99% Occupied Bandwidth and Hopping Channel Separation**

Mod.	Data Rate	NTX	CH.	Freq. (MHz)	20db BW (MHz)	99% Bandwidth (MHz)	Hopping Channel Separation Measurement (MHz)	Hopping Channel Separation Measurement Limit (MHz)	Pass/Fail
DH	1Mbps	1	0	2402	0.920	0.831	1.003	0.6133	Pass
DH	1Mbps	1	39	2441	0.920	0.831	1.003	0.6133	Pass
DH	1Mbps	1	78	2480	0.920	0.834	1.003	0.6133	Pass
2DH	2Mbps	1	0	2402	1.289	1.164	1.003	0.8593	Pass
2DH	2Mbps	1	39	2441	1.294	1.166	0.981	0.8625	Pass
2DH	2Mbps	1	78	2480	1.294	1.166	0.977	0.8625	Pass
3DH	3Mbps	1	0	2402	1.259	1.152	0.999	0.8393	Pass
3DH	3Mbps	1	39	2441	1.259	1.146	1.003	0.8393	Pass
3DH	3Mbps	1	78	2480	1.259	1.152	1.003	0.8393	Pass

TEST RESULTS DATA**Dwell Time**

Mod.	Hopping Channel Number Rate	Hops Over Occupancy Time(hops)	Package Transfer Time (msec)	Dwell Time (sec)	Limits (sec)	Pass/Fail
Nomal	79	106.67	2.90	0.31	0.4	Pass
AFH	20	53.33	2.90	0.15	0.4	Pass

TEST RESULTS DATA**Peak Power Table**

DH	CH.	NTX	Peak Power (dBm)	Power Limit (dBm)	Test Result
DH1	0	1	16.51	30.00	Pass
	39	1	17.51	30.00	Pass
	78	1	16.59	30.00	Pass
2DH1	0	1	15.98	20.97	Pass
	39	1	17.02	20.97	Pass
	78	1	16.04	20.97	Pass
3DH1	0	1	16.36	20.97	Pass
	39	1	17.37	20.97	Pass
	78	1	16.45	20.97	Pass

TEST RESULTS DATA**Average Power Table
(Reporting Only)**

DH	CH.	NTX	Average Power (dBm)	Duty Factor (dB)
DH1	0	1	16.05	5.21
	39	1	17.03	5.21
	78	1	16.10	5.21
2DH1	0	1	13.38	5.15
	39	1	14.53	5.15
	78	1	13.60	5.15
3DH1	0	1	13.33	5.13
	39	1	14.29	5.13
	78	1	13.54	5.13

TEST RESULTS DATA**Number of Hopping Frequency**

Number of Hopping (Channel)	Adaptive Frequency Hopping (Channel)	Limits (Channel)	Pass/Fail
79	20	> 15	Pass



Appendix B. AC Conducted Emission Test Results

Test Engineer :	Tom Lee	Temperature :	21~24°C
		Relative Humidity :	42~45%

EUT Information

Report NO : 9D0635
 Test Mode : Mode 1
 Test Voltage : 120Vac/60Hz
 Phase : Line

Full Spectrum

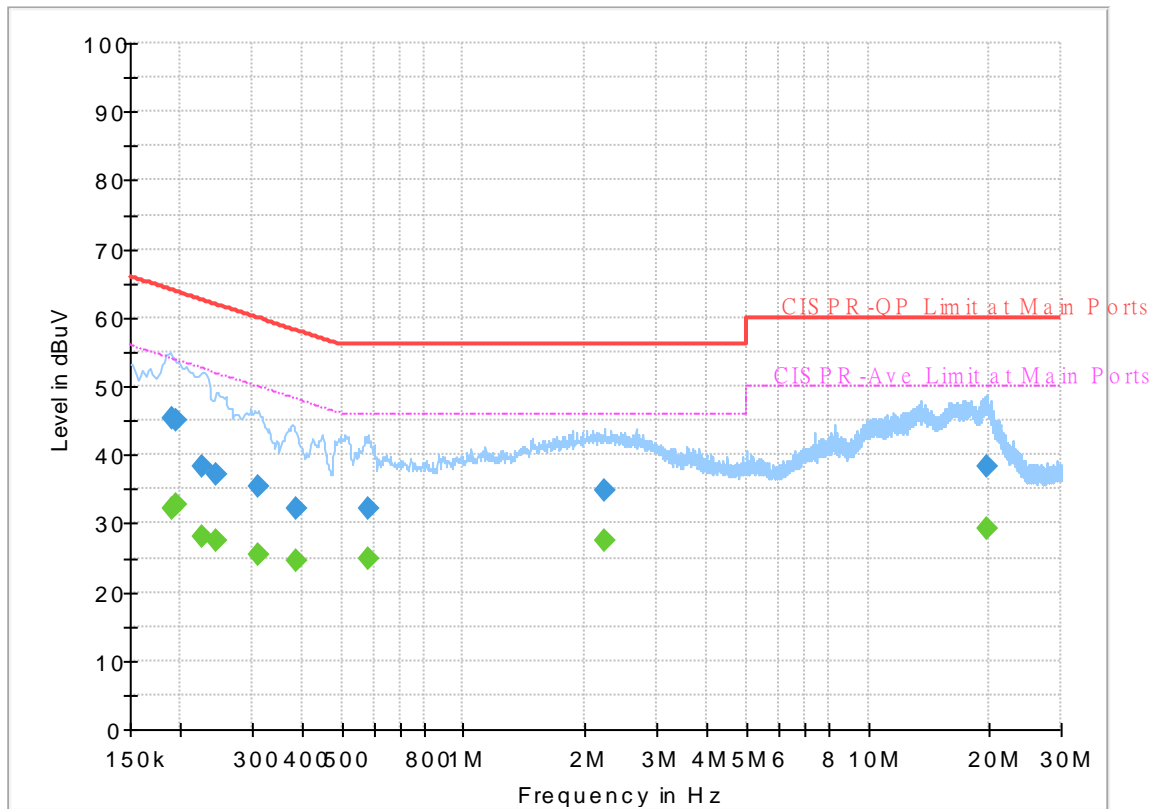

Final_Result

Frequency (MHz)	QuasiPeak (dBuV)	CAverage (dBuV)	Limit (dBuV)	Margin (dB)	Line	Filter	Corr. (dB)
0.190770	---	32.11	54.00	21.89	L1	OFF	19.5
0.190770	45.24	---	64.00	18.76	L1	OFF	19.5
0.195000	---	32.64	53.82	21.18	L1	OFF	19.5
0.195000	45.02	---	63.82	18.80	L1	OFF	19.5
0.225600	---	28.01	52.61	24.60	L1	OFF	19.5
0.225600	38.22	---	62.61	24.39	L1	OFF	19.5
0.244500	---	27.57	51.94	24.37	L1	OFF	19.5
0.244500	37.11	---	61.94	24.83	L1	OFF	19.5
0.312540	---	25.45	49.90	24.45	L1	OFF	19.5
0.312540	35.52	---	59.90	24.38	L1	OFF	19.5
0.386250	---	24.66	48.14	23.48	L1	OFF	19.5
0.386250	32.14	---	58.14	26.00	L1	OFF	19.5
0.581100	---	24.77	46.00	21.23	L1	OFF	19.5
0.581100	32.07	---	56.00	23.93	L1	OFF	19.5
2.229000	---	27.62	46.00	18.38	L1	OFF	19.7
2.229000	34.85	---	56.00	21.15	L1	OFF	19.7
19.711500	---	29.35	50.00	20.65	L1	OFF	20.2
19.711500	38.40	---	60.00	21.60	L1	OFF	20.2

EUT Information

Report NO : 9D0635
 Test Mode : Mode 1
 Test Voltage : 120Vac/60Hz
 Phase : Neutral

Full Spectrum

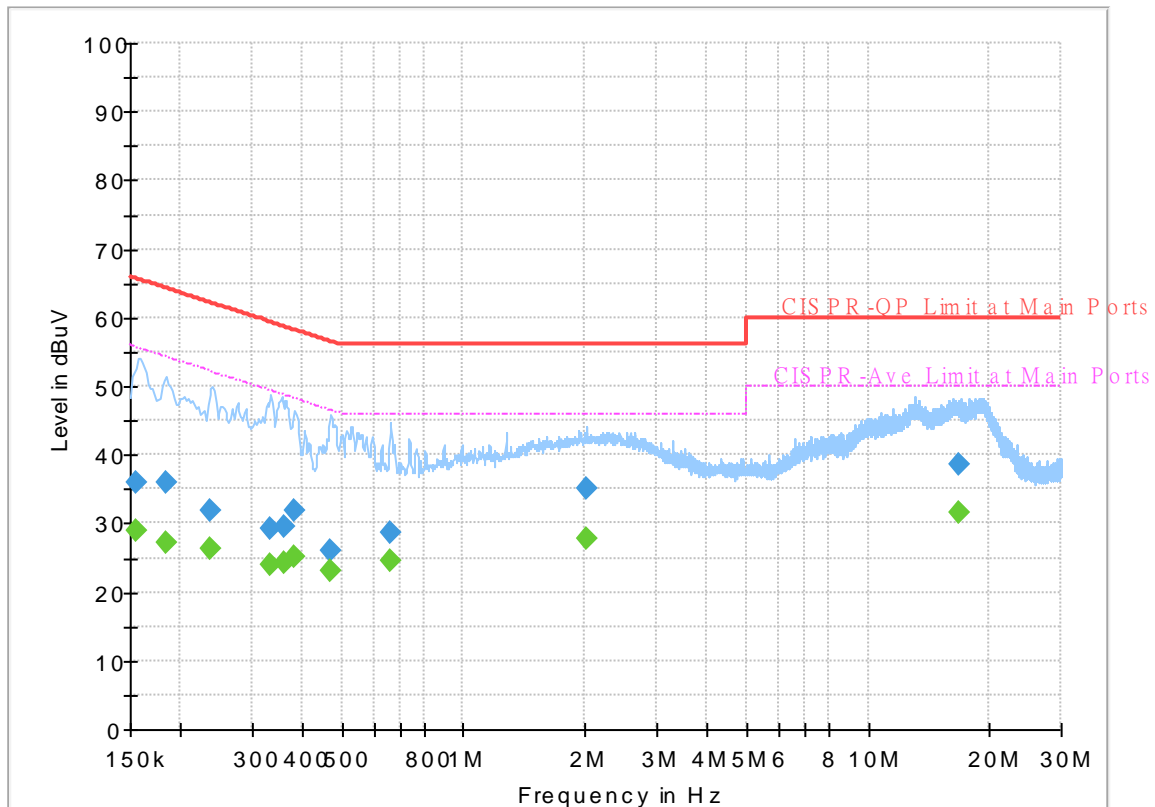

Final_Result

Frequency (MHz)	QuasiPeak (dBuV)	CAverage (dBuV)	Limit (dBuV)	Margin (dB)	Line	Filter	Corr. (dB)
0.154500	---	29.05	55.75	26.70	N	OFF	19.6
0.154500	36.07	---	65.75	29.68	N	OFF	19.6
0.184110	---	27.20	54.30	27.10	N	OFF	19.6
0.184110	36.05	---	64.30	28.25	N	OFF	19.6
0.235500	---	26.21	52.25	26.04	N	OFF	19.6
0.235500	31.80	---	62.25	30.45	N	OFF	19.6
0.332520	---	24.00	49.39	25.39	N	OFF	19.6
0.332520	29.29	---	59.39	30.10	N	OFF	19.6
0.359250	---	24.29	48.75	24.46	N	OFF	19.6
0.359250	29.67	---	58.75	29.08	N	OFF	19.6
0.381570	---	25.17	48.25	23.08	N	OFF	19.6
0.381570	31.75	---	58.25	26.50	N	OFF	19.6
0.471030	---	23.12	46.50	23.38	N	OFF	19.6
0.471030	26.01	---	56.50	30.49	N	OFF	19.6
0.662010	---	24.55	46.00	21.45	N	OFF	19.6
0.662010	28.64	---	56.00	27.36	N	OFF	19.6
2.013000	---	27.77	46.00	18.23	N	OFF	19.6
2.013000	34.98	---	56.00	21.02	N	OFF	19.6
16.707480	---	31.69	50.00	18.31	N	OFF	20.2
16.707480	38.73	---	60.00	21.27	N	OFF	20.2



Appendix C. Radiated Spurious Emission

Test Engineer :	Leo Lee, Mancy Chou and Bigshow Wang	Temperature :	23.9~25.2°C
		Relative Humidity :	53~60%

2.4GHz 2400~2483.5MHz

BT (Band Edge @ 3m)

BT	Note	Frequency (MHz)	Level (dBμV/m)	Over Limit (dB)	Limit Line (dBμV/m)	Read Level (dBμV)	Antenna Factor (dB/m)	Path Loss (dB)	Preamp Factor (dB)	Ant Pos (cm)	Table Pos (deg)	Peak Avg. (P/A)	Pol. (H/V)
BT CH00 2402MHz		2389.695	45.28	-28.72	74	42.43	27.76	6.24	31.15	294	324	P	H
		2389.695	20.49	-33.51	54	-	-	-	-	-	-	A	H
	*	2402	98.94	-	-	96.13	27.7	6.25	31.14	294	324	P	H
	*	2402	74.15	-	-	-	-	-	-	-	-	A	H
		2348.43	44.51	-29.49	74	41.5	28	6.18	31.17	100	349	P	V
		2348.43	19.72	-34.28	54	-	-	-	-	-	-	A	V
	*	2402	103.66	-	-	100.85	27.7	6.25	31.14	100	349	P	V
	*	2402	78.87	-	-	-	-	-	-	-	-	A	V
BT CH 39 2441MHz		2326.38	44.58	-29.42	74	41.56	28.05	6.15	31.18	400	318	P	H
		2326.38	19.79	-34.21	54	-	-	-	-	-	-	A	H
	*	2441	100.25	-	-	97.46	27.62	6.29	31.12	400	318	P	H
	*	2441	75.46	-	-	-	-	-	-	-	-	A	H
		2492.37	44.08	-29.92	74	41.31	27.52	6.34	31.09	400	318	P	H
		2492.37	19.29	-34.71	54	-	-	-	-	-	-	A	H
		2331.56	45.16	-28.84	74	42.13	28.04	6.16	31.17	187	18	P	V
		2331.56	20.37	-33.63	54	-	-	-	-	-	-	A	V
	*	2441	105.93	-	-	103.14	27.62	6.29	31.12	187	18	P	V
	*	2441	81.14	-	-	-	-	-	-	-	-	A	V
		2499.09	44.08	-29.92	74	41.32	27.5	6.35	31.09	187	18	P	V
		2499.09	19.29	-34.71	54	-	-	-	-	-	-	A	V