



FCC RADIO TEST REPORT

FCC ID : IHDT56YJ1
Equipment : Mobile Cellular Phone
Brand Name : Motorola
Model Name : XT2061-1
Applicant : Motorola Mobility, LLC
222 W Merchandise Mart Plaza, Suite 1800,
Chicago, IL 60654, United States
Manufacturer : Motorola Mobility, LLC
222 W Merchandise Mart Plaza, Suite 1800,
Chicago, IL 60654, United States
Standard : FCC 47 CFR Part 2, and 30

The product was received on Dec. 06, 2019 and testing was started from Feb. 03, 2020 and completed on Feb. 12, 2020. We, SPORTON INTERNATIONAL INC., would like to declare that the tested sample has been evaluated in accordance with the test procedures ANSI C63.26-2015 and has been in compliance with the applicable technical standards.

The report must not be used by the client to claim product certification, approval, or endorsement by TAF or any agency of government.

The test results in this report apply exclusively to the tested model / sample. Without written approval of SPORTON INTERNATIONAL INC. EMC & Wireless Communications Laboratory, the test report shall not be reproduced except in full.

Approved by: William Chen

SPORTON INTERNATIONAL INC. EMC & Wireless Communications Laboratory

No. 52, Huaya 1st Rd., Guishan Dist., Taoyuan City, Taiwan (R.O.C.)



Table of Contents

History of this test report 3

Summary of Test Result..... 4

1 General Description 5

 1.1 Feature of Equipment Under Test 5

 1.2 Product Specification of Equipment Under Test..... 6

 1.3 Modification of EUT 6

 1.4 Testing Location 7

 1.5 Applied Standards 7

2 Test Configuration of Equipment Under Test..... 8

 2.1 Test Mode..... 8

 2.2 Connection Diagram of Test System..... 9

 2.3 Support Unit used in test configuration..... 9

 2.4 Measurement Results Explanation Example 10

 2.5 Far Field Condition for Frequency above 18GHz..... 10

 2.6 Frequency List of Low/Middle/High Channels 11

3 Radiated Test Items..... 12

 3.1 Measuring Instruments 12

 3.2 Test Setup 12

 3.3 Test Result of Radiated Test 14

 3.4 EIRP Measurement 15

 3.5 Occupied Bandwidth..... 16

 3.6 Radiated Spurious Emission Measurement 17

 3.7 Frequency Stability Measurement 18

4 List of Measuring Equipment 19

5 Uncertainty of Evaluation 21

Appendix A. Test Results of EIRP and Radiated Test

Appendix B. R&S Mixer Certificate



History of this test report

Report No.	Version	Description	Issued Date
FG9D0365G	01	Initial issue of report	Feb. 14, 2020



Summary of Test Result

Report Clause	Ref Std. Clause	Test Items	Limit	Result (PASS/FAIL)	Remark
3.4	§2.1046 §30.202	EIRP Measurement	+43dBm	Pass	-
3.5	§2.1049	Occupied Bandwidth	Not Applicable	Reporting only	-
3.6	§2.1053 §30.203	Radiated Spurious Emission	-5dBm/MHz -13dBm/MHz	Pass	-
3.7	§2.1055	Frequency Stability for Temperature & Voltage	Within the band	Pass	-

Declaration of Conformity:

The test results with all measurement uncertainty excluded are presented in accordance with the regulation limits or requirements declared by manufacturers.

Comments and Explanations:

The declared of product specification for EUT presented in the report are provided by the manufacturer, and the manufacturer takes all the responsibilities for the accuracy of product specification.

Reviewed by: Yung Hsu

Report Producer: Wii Chang



1 General Description

1.1 Feature of Equipment Under Test

Product Feature & Specification	
Equipment	Mobile Cellular Phone
Brand Name	Motorola
Model Name	XT2061-1
FCC ID	IHDT56YJ1
IMEI Code	IMEI: 359120100016339
EUT supports Radios application	CDMA/EV-DO/GSM/EGPRS/WCDMA/HSPA/LTE/5G NR/ GNSS/NFC/WPC WLAN 11b/g/n HT20 WLAN 11a/n HT20/HT40 WLAN 11ac VHT20/VHT40/VHT80 WLAN 11ax HE20/HE40/HE80 Bluetooth BR/EDR/LE
HW Version	DVT2
EUT Stage	Identical Prototype

Remark: The above EUT's information was declared by manufacturer.

Accessory List	
AC Adapter 1	Brand Name : Motorola
	Model Name : SC-51 (SA18C30116)
	Manufacturer : Chenyang
AC Adapter 2	Brand Name : Motorola
	Model Name : SC-51 (SA18C62985)
	Manufacturer : Acbel
Battery	Brand Name : ATL
	Model Name : LW50
USB Cable 1	Brand Name : Motorola
	Model Name : SC18C24367
	Manufacturer : Saibao
USB Cable 2	Brand Name : Motorola
	Model Name : SC18C24368
	Manufacturer : Luxshare



1.2 Product Specification of Equipment Under Test

Product Specification subjective to this standard	
Device Category in Part 30	Mobile station
Tx Frequency	NR band n260: 37GHz ~ 40GHz NR band n261: 27.5GHz ~ 28.35GHz
Rx Frequency	NR band n260: 37GHz ~ 40GHz NR band n261: 27.5GHz ~ 28.35GHz
Support Bandwidth	NR band n260: 50 MHz and 100 MHz NR band n261: 50 MHz and 100 MHz
Maximum Number of contiguous CC	4
Maximum Aggregated Bandwidth	400MHz
Maximum Output Power (EIRP)	NR band n260: Module 0: 25.49 dBm Module 1: 28.90 dBm NR band n261: Module 0: 23.58 dBm Module 1: 24.32 dBm
Type of Modulation	CP-OFDM: QPSK / 16QAM / 64QAM DFT-s-OFDM: BPSK / QPSK / 16QAM / 64QAM

Note: Highest EIRP was measured on Module 1, dual beam case.

1.3 Modification of EUT

No modifications are made to the EUT during all test items.



1.4 Testing Location

Test Site	SPORTON INTERNATIONAL INC.			
Test Site Location	No.52, Huaya 1st Rd., Guishan Dist., Taoyuan City, Taiwan (R.O.C.) TEL: +886-3-327-3456 FAX: +886-3-328-4978			
Test Site Information	Site No.	Engineer	Temperature	Humidity
	TH02-HY	Chester Chen	20~22°C	43~45 %

Test Site	SPORTON INTERNATIONAL INC.			
Test Site Location	No.58, Aly. 75, Ln. 564, Wenhua 3rd, Rd., Guishan Dist., Taoyuan City, Taiwan (R.O.C.) TEL: +886-3-327-0868 FAX: +886-3-327-0855			
Test Site Information	Site No.	Engineer	Temperature	Humidity
	03CH10-HY	Yu Wang	20~22°C	45~47 %
	03CH18-HY	Yu Wang	20~22°C	47~48 %

FCC Designation No. TW1190 and TW0007

1.5 Applied Standards

According to the specifications of the manufacturer, the EUT must comply with the requirements of the following standards:

- ♦ FCC 47 CFR Part 2, 30
- ♦ ANSI C63.26-2015
- ♦ FCC KDB 971168 D01 Power Meas. License Digital Systems v03r01
- ♦ FCC KDB 842590 D01 Upper Microwave Flexible Use Service v01

Remark:

1. All test items were verified and recorded according to the standards and without any deviation during the test.
2. This EUT has also been tested and complied with the requirements of FCC Part 15, Subpart B, recorded in a separate test report.



2 Test Configuration of Equipment Under Test

EUT has total 2 millimeter wave antenna modules and up to 2 beams operation for each module.

Any antenna module cannot transmit simultaneously with the other antenna modules.

Preliminary EIRP test was performed for all beam configurations in the anechoic chamber at the manufacturer’s facility so the EIRP worst case beam-pair were identified.

EIRP was investigated that the dual beam rated maximum EIRP is higher than single beam.

EUT configured to transmit a single beam at a time and combine the measured value together for both beams by math calculation in linear form method.

The NR radio operation is controlled via software tool QRCT FTM mode (Factory mode).

The EUT is forced to operate continuously (100% duty cycle) with maximum output power during the test.

2.1 Test Mode

For radiated measurement, the pre-scan is performed to find the worst cases EUT position.

Test Items	Band	Bandwidth (MHz)			Modulation			RB #			Test Channel		
		50	100	400	QPSK	16QAM	64QAM	1	-	Full	L	M	H
EIRP	n260 n261	v	v	v	v	v	v	v		v	v	v	v
99% Occupied Bandwidth	n260 n261	v	v	v	v	v	v			v	v	v	v
Out of Band Emission	n260 n261	v	v	v	v	v	v	v		v	v		v
Spurious Emission	n260 n261	v	v	v	v			v			v	v	v
Frequency Stability	n260 n261	CW tone										v	
Remark	<ol style="list-style-type: none"> The mark "v " means that this configuration is chosen for testing The device is investigated from 30MHz to 100GHz of fundamental signal for radiated spurious emission test under different RB size and modulations in exploratory test. Subsequently, only the worst case emissions are reported. All the radiated test cases were performed with built-in battery. The out of band emission were measured conducted emission level for each beam plus 3dB dual beam factor The spurious emissions were measured radiated EIRP for each beam plus 3dB dual beam factor. 												

2.2 Connection Diagram of Test System

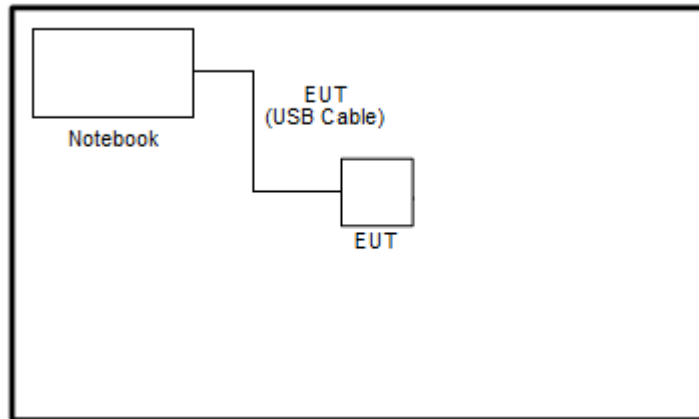

2.3 Support Unit used in test configuration

Item	Equipment	Trade Name	Model No.	FCC ID	Data Cable	Power Cord
1.	Notebook	Dell	N/A	N/A	N/A	N/A



2.4 Measurement Results Explanation Example

According to ANSI C63.26-2015 Section 5.2.7

$$EIRP \text{ (dBm)} = E \text{ (dBuV/m)} + 20\log(D) - 104.8.$$

where D is the measurement distance (in the far field region) in m.

$$E \text{ (dBuV/m)} = \text{Spectrum Reading Level (dBm)} + \text{Antenna Factor (dB/m)} + \text{Cable Loss (dB)} + 107$$

Hence, the spectrum analyzer *Offset* is derived including RF cable loss and antenna factor.

$$\text{Offset} = \text{Antenna Factor (dB/m)} + \text{Cable Loss (dB)} + 107 + 20\log(D) - 104.8$$

The conversion loss of RF mixer is also included by the mixer table of spectrum analyzer when measurement frequency is above 40GHz.

Example :

$$\begin{aligned} \text{Offset} &= \text{Antenna Factor (dB/m)} + \text{Cable Loss (dB)} + 107 + 20\log(D) - 104.8 \\ &= 42.3 + 3.0 + 107 + 20\log(1) - 104.8 \\ &= 47.5 \text{ (dB)} \end{aligned}$$

2.5 Far Field Condition for Frequency above 18GHz

Horn Antenna	Frequency (GHz)	Antenna Dimension A (mm)	Wavelength (λ) (m)	Far field R (m) $\geq 2A^2 / \lambda$	Measurement Distance (D) (m)	Distance Factor $20\log(D)$ (dB)
BBHA 9170	18	60	0.0167	0.43	1	0.00
	40	60	0.0075	0.96		
QWH-UPRR00	40	48	0.0075	0.61	1	0.00
	60	48	0.0050	0.92		
QWH-EPRR00	60	31	0.0050	0.38	1	0.00
	90	31	0.0033	0.58		
QWH-FPRR00	90	21	0.0033	0.26	1	0.00
	140	21	0.0021	0.41		
QWH-GPRR00	140	15	0.0021	0.21	0.5	-6.02
	220	15	0.0014	0.33		



2.6 Frequency List of Low/Middle/High Channels

NR Band n260 Channel and Frequency List				
BW [MHz]	Channel/Frequency(MHz)	Lowest	Middle	Highest
50	Frequency	37025	38500	39975
100	Frequency	37050	38500	39950
400	Frequency 1	37050	38350	39650
	Frequency 2	37150	38450	39750
	Frequency 3	37250	38550	39850
	Frequency 4	37350	38650	39950

NR Band n261 Channel and Frequency List				
BW [MHz]	Channel/Frequency(MHz)	Lowest	Middle	Highest
50	Frequency	27525	27925	28325
100	Frequency	27550	27925	28300
400	Frequency 1	27550	27775	28000
	Frequency 2	27650	27875	28100
	Frequency 3	27750	27975	28200
	Frequency 4	27850	28075	28300

3 Radiated Test Items

3.1 Measuring Instruments

See list of measuring instruments of this test report.

3.2 Test Setup

For radiated emissions from 30MHz to 1GHz

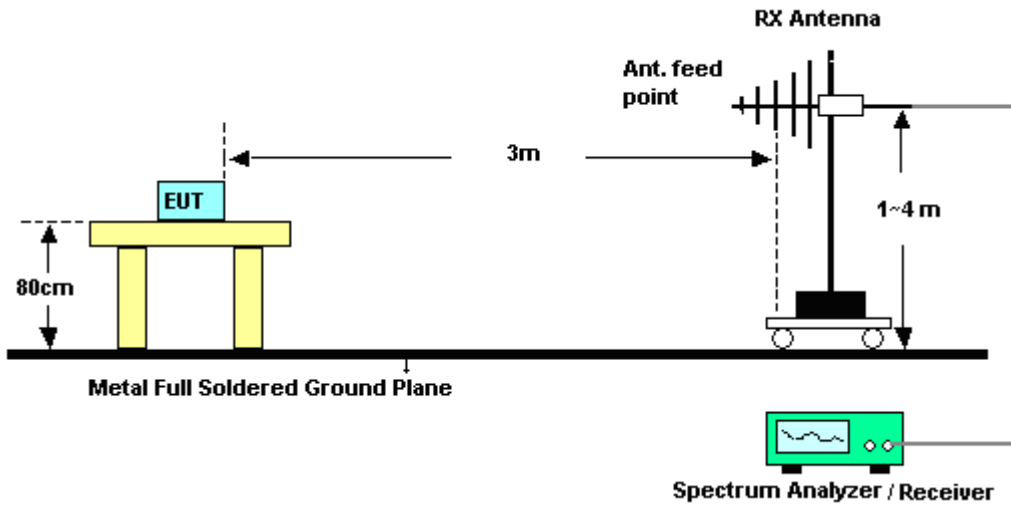

For radiated emissions 1GHz to 18GHz

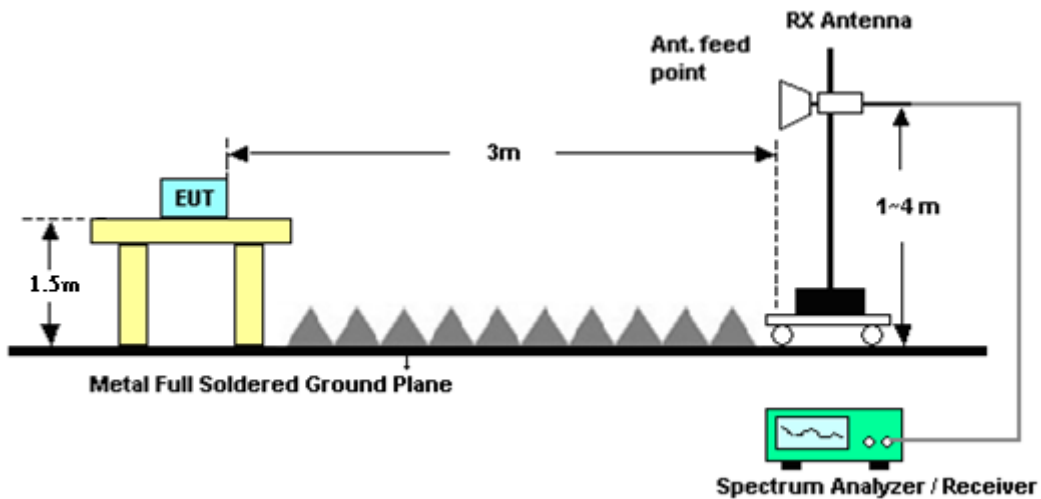

For radiated emissions above 18GHz up to 40GHz

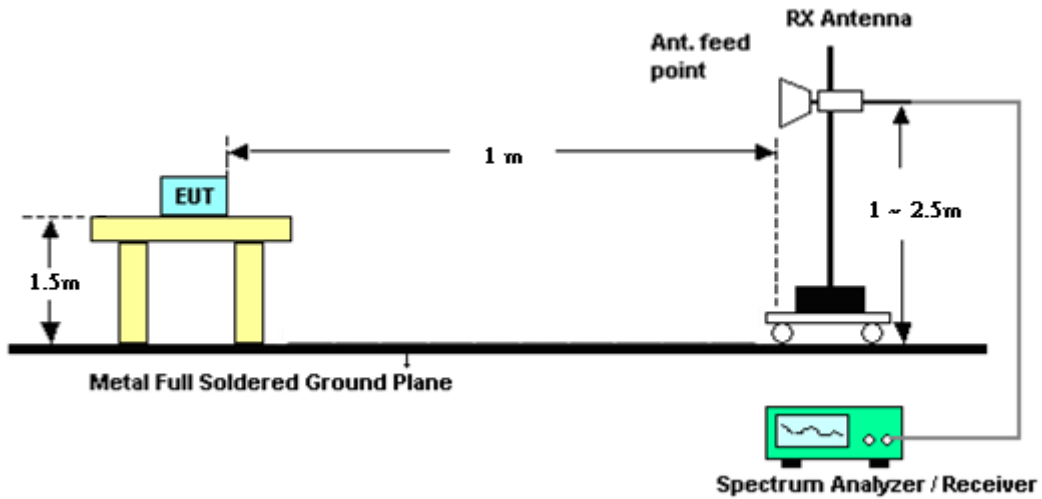

For radiated emissions above 40GHz up to 140GHz

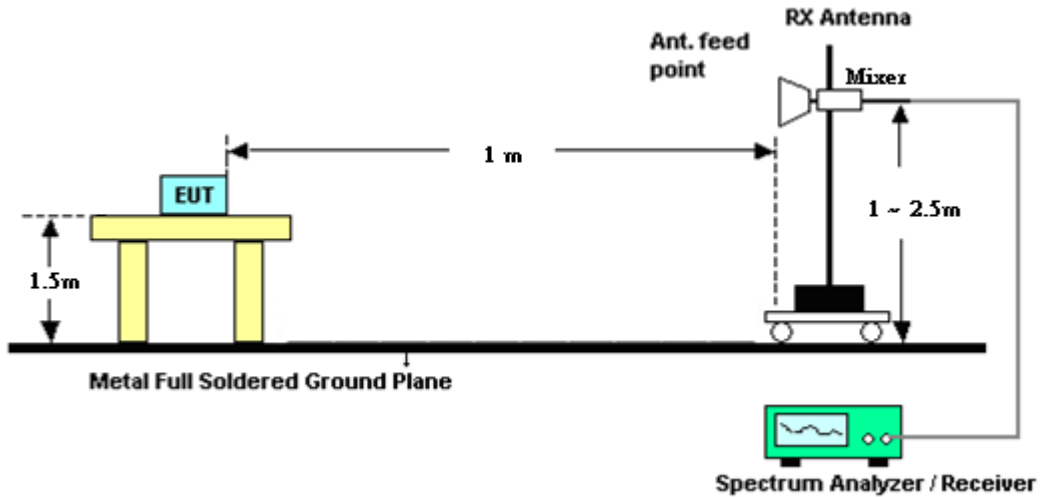

For radiated emissions above 140GHz up to 200GHz

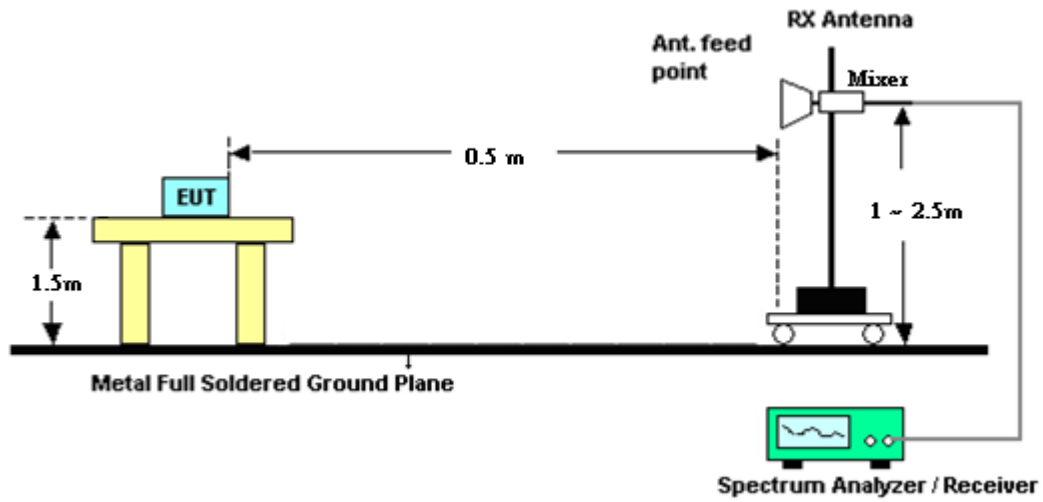

3.3 Test Result of Radiated Test

Please refer to Appendix A.



3.4 EIRP Measurement

3.4.1 Description of EIRP Measurement

For mobile stations, the average power of the sum of all antenna elements is limited to a maximum EIRP of +43 dBm.

3.4.2 Test Procedures

1. Set EUT at maximum output power.
2. Select lowest, middle, and highest channels for each band and different modulation.
3. Enable channel power function of spectrum analyzer
4. Set frequency would like to be investigated.
5. Set Detector = RMS
6. Set Trace mode = trace average
7. Set Sweep time = auto couple
8. Set sweep points $\geq 2 \times \text{Span/RBW}$
9. Set sweep count 100 and wait until the trace to be stabilized
10. Make the measurement with the spectrum analyzer's RBW = 1MHz, VBW = 3MHz, taking the record of maximum spurious emission.
11. Measure and record the power level from the spectrum analyzer.
12. The test result is calculated according to

ANSI C63.26-2015 Section 5.2.7

$$\text{EIRP (dBm)} = E(\text{dBuV/m}) + 20\log(D) - 104.8.$$

where D is the measurement distance (in the far field region) in m.

$$E(\text{dBuV/m}) = \text{Spectrum Level (dBm)} + \text{Antenna Factor (dB/m)} + \text{Cable Loss (dB)} + 107$$

That is, set the spectrum offset including sum of

$$\text{Antenna Factor (dB/m)} + \text{Cable Loss (dB)} + 107 + 20\log(D) - 104.8$$



3.5 Occupied Bandwidth

3.5.1 Description of Occupied Bandwidth Measurement

This is for reporting only.

The occupied bandwidth is the width of a frequency band such that, below the lower and above the upper frequency limits, the mean powers emitted are each equal to a specified percentage 0.5% of the total mean transmitted power.

3.5.2 Test Procedures

The testing follows ANSI C63.26-2015 Section 5.4.4

1. The spectrum analyzer center frequency is set to the nominal EUT channel center frequency. The span range for the spectrum analyzer shall be at least 1.5 times the anticipated OBW.
2. The nominal resolution bandwidth (RBW) shall be in the range of 1 to 5 % of the anticipated OBW, and the VBW shall be at least 3 times the RBW.
3. Set the detection mode to peak, and the trace mode to max hold.
4. Use the 99 % power bandwidth function of the spectrum analyzer and report the measured bandwidth.



3.6 Radiated Spurious Emission Measurement

3.6.1 Description of Radiated Spurious Emission Measurement

The spectrum is scanned from 30 MHz up to 200GHz.

The conductive power or the total radiated power of any emission outside a licensee's frequency block shall be -13 dBm/MHz or lower. However, in the bands immediately outside and adjacent to the licensee's frequency block, having a bandwidth equal to 10 percent of the channel bandwidth, the conductive power or the total radiated power of any emission shall be -5 dBm/MHz or lower.

3.6.2 Test Procedures

1. Set EUT at maximum output power..
2. Select lowest, middle, and highest channels for each band and different modulation.
3. Measure and record the power level from the spectrum analyzer.
4. Set frequency would like to be investigated.
5. Set Detector = RMS
6. Set Trace mode = trace average
7. Set Sweep time = auto couple
8. Set sweep points $\geq 2 \times \text{Span/RBW}$
9. Set sweep count 100 and wait until the trace to be stabilized
10. Make the measurement with the spectrum analyzer's RBW = 1MHz, VBW = 3MHz, taking the record of maximum spurious emission.
11. For measurement frequency from 30MHz to 18GHz,
An antenna was substituted in place of the EUT and was driven by a signal generator.
Tune the output power of signal generator to the same emission level with EUT maximum spurious emission. Take record of output power and repeat for another polarization.
12. For measurement frequency above 18GHz,
the test result is calculated according to
ANSI C63.26-2015 Section 5.2.7 and 5.7.3 and 5.7.4
$$\text{EIRP (dBm)} = \text{E(dBuV/m)} + 20\log(D) - 104.8.$$
where D is the measurement distance (in the far field region) in m.
$$\text{E (dBuV/m)} = \text{Spectrum Level (dBm)} + \text{Antenna Factor (dB/m)} + \text{Cable Loss (dB)} + 107$$
That is, set the spectrum offset including sum of
$$\text{Antenna Factor (dB/m)} + \text{Cable Loss (dB)} + 107 + 20\log(D) - 104.8 + 3\text{dB dual beam factor}$$
For band edge, the antenna gain offset is included in order to compare to the conductive limit.
13. The conversion loss of RF mixer is also included in conversion loss table of the spectrum analyzer when measurement frequency is above 40GHz.



3.7 Frequency Stability Measurement

3.7.1 Description of Frequency Stability Measurement

The frequency stability shall be measured by variation of ambient temperature and variation of primary supply voltage to ensure that the fundamental emission stays within the authorized frequency block.

3.7.2 Test Procedures for Temperature Variation

The testing follows FCC KDB 971168 D01 v03r01 Section 9.

1. The EUT was set up in the thermal chamber.
2. With power OFF, the temperature was decreased to -30°C and the EUT was stabilized before testing. Power was applied and the maximum change in frequency was recorded within one minute.
3. With power OFF, the temperature was raised in 10°C step up to 50°C. The EUT was stabilized at each step for at least half an hour. Power was applied and the maximum frequency change was recorded within one minute.

3.7.3 Test Procedures for Voltage Variation

The testing follows FCC KDB 971168 D01 v03r01 Section 9.

1. The EUT was placed in a temperature chamber at 20° C.
2. The power supply voltage to the EUT was varied from 85% to 115% of the nominal value measured at the input to the EUT.
3. The variation in frequency was measured for the worst case.



4 List of Measuring Equipment

Instrument	Manufacturer	Model No.	Serial No.	Characteristics	Calibration Date	Test Date	Due Date	Remark
Amplifier	SONOMA	310N	187311	9kHz~1GHz	Oct. 22, 2019	Feb. 10, 2020~ Feb. 12, 2020	Oct. 21, 2020	Radiation (03CH10-HY)
Loop Antenna	Rohde & Schwarz	HFH2-Z2	100488	9 kHz~30 MHz	Jan. 09, 2020	Feb. 10, 2020~ Feb. 12, 2020	Jan. 08, 2021	Radiation (03CH10-HY)
Bilog Antenna	TESEQ	CBL 6111D&00800 N1D01N-06	35413 & 02	30MHz~1GHz	Feb. 12, 2019	Feb. 10, 2020	Feb. 11, 2020	Radiation (03CH10-HY)
Horn Antenna	SCHWARZBE CK	BBHA 9120 D	9120D-1325	1GHz ~ 18GHz	Oct. 09, 2019	Feb. 10, 2020~ Feb. 12, 2020	Oct. 08, 2020	Radiation (03CH10-HY)
Preamplifier	Jet-Power	JAP00101800- 30-10P	16011855000 4	1GHz~18GHz	Sep. 27, 2019	Feb. 10, 2020~ Feb. 12, 2020	Sep. 26, 2020	Radiation (03CH10-HY)
Spectrum Analyzer	Rohde & Schwarz	FSV40	101564	10Hz~40GHz	Jul. 17, 2019	Feb. 10, 2020~ Feb. 12, 2020	Jul. 16, 2020	Radiation (03CH10-HY)
Controller	EMEC	EM 1000	N/A	Control Turn table & Ant Mast	N/A	Feb. 10, 2020~ Feb. 12, 2020	N/A	Radiation (03CH10-HY)
Antenna Mast	EMEC	AM-BS-4500-B	N/A	1~4m	N/A	Feb. 10, 2020~ Feb. 12, 2020	N/A	Radiation (03CH10-HY)
Turn Table	EMEC	TT 2200	N/A	0~360 Degree	N/A	Feb. 10, 2020~ Feb. 12, 2020	N/A	Radiation (03CH10-HY)
Software	Audix	E3 6.2009-8-24	RK-001042	N/A	N/A	Feb. 10, 2020~ Feb. 12, 2020	N/A	Radiation (03CH10-HY)
RF Cable	HUBER + SUHNER	SUCOFLEX 104 / 102	MY11692/4P E, MY11693/4P E, MY2855/2	30MHz~1GHz	Nov. 07, 2019	Feb. 10, 2020~ Feb. 12, 2020	Nov. 06, 2020	Radiation (03CH10-HY)
RF Cable	HUBER + SUHNER	SUCOFLEX 104 / 102	MY11692/4P E, MY11693/4P E, MY2855/2	1GHz~18GHz	Nov. 07, 2019	Feb. 10, 2020~ Feb. 12, 2020	Nov. 06, 2020	Radiation (03CH10-HY)
SHF-EHF Horn Antenna	SCHWARZBE CK	BBHA 9170	BBHA917025 1	18GHz~40GHz	Nov. 26, 2019	Feb. 03, 2020~ Feb. 10, 2020	Nov. 25, 2020	Radiation (03CH18-HY)
Signal Analyzer	Rohde & Schwarz	FSV3044	101010	10Hz~44GHz	Nov 11, 2019	Feb. 03, 2020~ Feb. 10, 2020	Nov 10, 2020	Radiation (03CH18-HY)
Spectrum Analyzer	Rohde & Schwarz	FSV40	101564	10Hz~40GHz	Jul. 17, 2019	Feb. 03, 2020~ Feb. 10, 2020	Jul. 16, 2020	Radiation (03CH18-HY)
RF Cable	HUBER + SUHNER	SF102/2*11SK 252	MY4278/2	9kHz~40GHz	May. 16, 2019	Feb. 03, 2020~ Feb. 10, 2020	May. 15, 2020	Radiation (03CH18-HY)
*Mixer	Rohde & Schwarz	FS-Z60	100986	40 ~ 60 GHz	Oct. 31, 2018	Feb. 03, 2020~ Feb. 10, 2020	Oct. 30, 2021	Radiation (03CH18-HY)
*Mixer	Rohde & Schwarz	FS-Z90	101811	60 ~ 90 GHz	Jul. 16, 2018	Feb. 03, 2020~ Feb. 10, 2020	Jul. 16, 2021	Radiation (03CH18-HY)
*Mixer	Rohde & Schwarz	FS-Z140	101128	90 ~ 140 GHz	Sep. 03, 2018	Feb. 03, 2020~ Feb. 10, 2020	Sep. 02, 2021	Radiation (03CH18-HY)
*Mixer	Rohde & Schwarz	FS-Z220	101014	140 ~ 220 GHz	Aug. 28, 2018	Feb. 03, 2020~ Feb. 10, 2020	Aug. 27, 2021	Radiation (03CH18-HY)



Instrument	Manufacturer	Model No.	Serial No.	Characteristics	Calibration Date	Test Date	Due Date	Remark
Standard Horn Antenna	Quinstar	QWH-UPRR00	923600007	40 ~ 60 GHz	Aug. 17, 2018	Feb. 03, 2020~ Feb. 10, 2020	Aug. 16, 2021	Radiation (03CH18-HY)
Standard Horn Antenna	Quinstar	QWH-EPRR00	784600034	60 ~ 90 GHz	Aug. 17, 2018	Feb. 03, 2020~ Feb. 10, 2020	Aug. 16, 2021	Radiation (03CH18-HY)
Standard Horn Antenna	Quinstar	QWH-FPRR00	923800008	90 ~ 140 GHz	Aug. 17, 2018	Feb. 03, 2020~ Feb. 10, 2020	Aug. 16, 2021	Radiation (03CH18-HY)
Standard Horn Antenna	Quinstar	QWH-GPRR0 0	923900001	140 ~ 220 GHz	Aug. 17, 2018	Feb. 03, 2020~ Feb. 10, 2020	Aug. 16, 2021	Radiation (03CH18-HY)
Spectrum Analyzer	Rohde & Schwarz	FSP40	100055	9kHz~40GHz	Jun. 14, 2018	May 03, 2019~ May 22, 2019	Jun. 13, 2019	Thermal (TH02-HY)
Thermal Chamber	Ten Billion	TTH-D3SP	TBN-930701	N/A	Jul. 19, 2018	May 03, 2019~ May 22, 2019	Jul. 18, 2019	Thermal (TH02-HY)
Spectrum Analyzer	Rohde & Schwarz	FSV40	101397	10Hz~40GHz	Nov. 15, 2019	Feb. 11, 2020	Nov. 14, 2020	Conducted (TH05-HY)
Thermal Chamber	Ten Billion	TTH-D3SP	TBN-930701	N/A	Jul. 26, 2019	Feb. 11, 2020	Jul. 25, 2020	Conducted (TH05-HY)

Note: (*) Equipment manufacturer's Calibration Certificate.



5 Uncertainty of Evaluation

Uncertainty of Radiated Emission Measurement (30 MHz ~ 1000 MHz)

Measuring Uncertainty for a Level of Confidence of 95% ($U = 2Uc(y)$)	3.37
---	------

Uncertainty of Radiated Emission Measurement (1 GHz ~ 18 GHz)

Measuring Uncertainty for a Level of Confidence of 95% ($U = 2Uc(y)$)	3.67
---	------

Uncertainty of Radiated Emission Measurement (18 GHz ~ 40 GHz)

Measuring Uncertainty for a Level of Confidence of 95% ($U = 2Uc(y)$)	4.03
---	------

Uncertainty of Radiated Emission Measurement (40 GHz ~ 140 GHz)

Measuring Uncertainty for a Level of Confidence of 95% ($U = 2Uc(y)$)	5.80
---	------

Uncertainty of Radiated Emission Measurement (140 GHz ~ 200 GHz)

Measuring Uncertainty for a Level of Confidence of 95% ($U = 2Uc(y)$)	6.80
---	------



Appendix A. Test Results of EIRP and Radiated Test

EIRP Power(Average power)

NR Band n260 Module 0							
Maximum Average EIRP [dBm]							
BW [MHz]	Antenna Array	RB Size	RB Offset	Mod	Lowest	Middle	Highest
50	AG0	1	0	QPSK	19.68	21.43	22.82
50		32	0		19.17	20.58	23.09
50	AG1	1	0	QPSK	19.23	20.77	22.08
50		32	0		18.84	20.73	21.77
50	AG0+AG1	1	0	QPSK	22.47	24.12	25.48
50		32	0		22.02	23.67	25.49
50	AG0	1	0	16-QAM	17.60	19.65	21.47
50		32	0		17.39	18.91	21.36
50	AG1	1	0	16-QAM	17.96	19.87	20.92
50		32	0		17.03	18.95	20.12
50	AG0+AG1	1	0	16-QAM	20.79	22.77	24.21
50		32	0		20.22	21.94	23.79
50	AG0	1	0	64-QAM	15.87	16.65	19.75
50		32	0		15.19	16.95	19.26
50	AG1	1	0	64-QAM	15.07	16.92	18.01
50		32	0		14.74	16.88	18.00
50	AG0+AG1	1	0	64-QAM	18.50	19.80	21.98
50		32	0		17.98	19.93	21.69



NR Band n260 Module 0							
Maximum Average EIRP [dBm]							
BW [MHz]	Antenna Array	RB Size	RB Offset	Mod	Lowest	Middle	Highest
100	AG0	1	0	QPSK	19.65	21.66	22.30
100		64	0		19.41	21.36	22.68
100	AG1	1	0	QPSK	19.03	20.72	22.10
100		64	0		19.08	20.34	22.37
100	AG0+AG1	1	0	QPSK	22.36	24.23	25.21
100		64	0		22.26	23.89	25.54
100	AG0	1	0	16-QAM	17.32	20.52	20.62
100		64	0		17.60	19.77	21.14
100	AG1	1	0	16-QAM	16.38	18.11	19.82
100		64	0		17.15	18.48	20.65
100	AG0+AG1	1	0	16-QAM	19.89	22.49	23.25
100		64	0		20.39	22.18	23.91
100	AG0	1	0	64-QAM	15.80	17.93	19.46
100		64	0		15.37	17.54	18.63
100	AG1	1	0	64-QAM	15.16	16.69	18.97
100		64	0		14.82	16.42	18.51
100	AG0+AG1	1	0	64-QAM	18.50	20.36	22.23
100		64	0		18.11	20.03	21.58



NR Band n260 Module 0							
Maximum Average EIRP [dBm]							
BW [MHz]	Antenna Array	RB Size	RB Offset	Mod	Lowest	Middle	Highest
400	AG0	64	0	QPSK	16.39	18.94	18.59
400	AG1	64	0	QPSK	18.19	20.16	20.06
400	AG0+AG1	64	0	QPSK	20.39	22.60	22.40
400	AG0	64	0	16-QAM	14.81	17.45	17.11
400	AG1	64	0	16-QAM	16.12	18.45	18.21
400	AG0+AG1	64	0	16-QAM	18.52	20.99	20.71
400	AG0	64	0	64-QAM	13.20	15.94	15.14
400	AG1	64	0	64-QAM	13.82	16.34	16.25
400	AG0+AG1	64	0	64-QAM	16.53	19.15	18.74



NR Band n260 Module 1							
Maximum Average EIRP [dBm]							
BW [MHz]	Antenna Array	RB Size	RB Offset	Mod	Lowest	Middle	Highest
50	AG0	1	0	QPSK	23.46	25.37	24.06
50		32	0		22.85	24.89	23.74
50	AG1	1	0	QPSK	23.51	26.36	25.40
50		32	0		23.43	26.02	25.45
50	AG0+AG1	1	0	QPSK	26.50	28.90	27.79
50		32	0		26.16	28.50	27.69
50	AG0	1	0	16-QAM	21.78	23.75	22.28
50		32	0		20.94	23.19	22.36
50	AG1	1	0	16-QAM	22.50	25.22	24.63
50		32	0		21.63	24.38	23.93
50	AG0+AG1	1	0	16-QAM	25.17	27.56	26.62
50		32	0		24.31	26.84	26.23
50	AG0	1	0	64-QAM	19.42	21.11	20.17
50		32	0		18.62	20.96	19.92
50	AG1	1	0	64-QAM	19.44	22.09	21.75
50		32	0		19.31	22.22	21.60
50	AG0+AG1	1	0	64-QAM	22.44	24.64	24.04
50		32	0		21.99	24.65	23.85



NR Band n260 Module 1							
Maximum Average EIRP [dBm]							
BW [MHz]	Antenna Array	RB Size	RB Offset	Mod	Lowest	Middle	Highest
100	AG0	1	0	QPSK	23.19	25.40	23.64
100		64	0		22.81	25.12	22.95
100	AG1	1	0	QPSK	23.67	26.05	25.36
100		64	0		23.84	25.42	25.59
100	AG0+AG1	1	0	QPSK	26.45	28.75	27.59
100		64	0		26.37	28.28	27.48
100	AG0	1	0	16-QAM	21.24	23.35	21.39
100		64	0		21.14	23.01	21.63
100	AG1	1	0	16-QAM	21.35	23.39	23.09
100		64	0		22.07	23.68	23.95
100	AG0+AG1	1	0	16-QAM	24.31	26.38	25.33
100		64	0		24.64	26.37	25.95
100	AG0	1	0	64-QAM	19.33	20.15	20.14
100		64	0		18.94	21.05	19.45
100	AG1	1	0	64-QAM	19.81	21.57	21.90
100		64	0		19.72	21.68	21.88
100	AG0+AG1	1	0	64-QAM	22.59	23.93	24.12
100		64	0		22.36	24.39	23.84



NR Band n260 Module 1							
Maximum Average EIRP [dBm]							
BW [MHz]	Antenna Array	RB Size	RB Offset	Mod	Lowest	Middle	Highest
400	AG0	64	0	QPSK	20.91	22.24	20.19
400	AG1	64	0	QPSK	23.07	25.53	24.15
400	AG0+AG1	64	0	QPSK	25.13	27.20	25.62
400	AG0	64	0	16-QAM	19.27	20.61	18.65
400	AG1	64	0	16-QAM	21.50	23.84	22.38
400	AG0+AG1	64	0	16-QAM	23.54	25.53	23.91
400	AG0	64	0	64-QAM	17.39	18.94	16.41
400	AG1	64	0	64-QAM	19.17	21.78	20.15
400	AG0+AG1	64	0	64-QAM	21.38	23.60	21.68

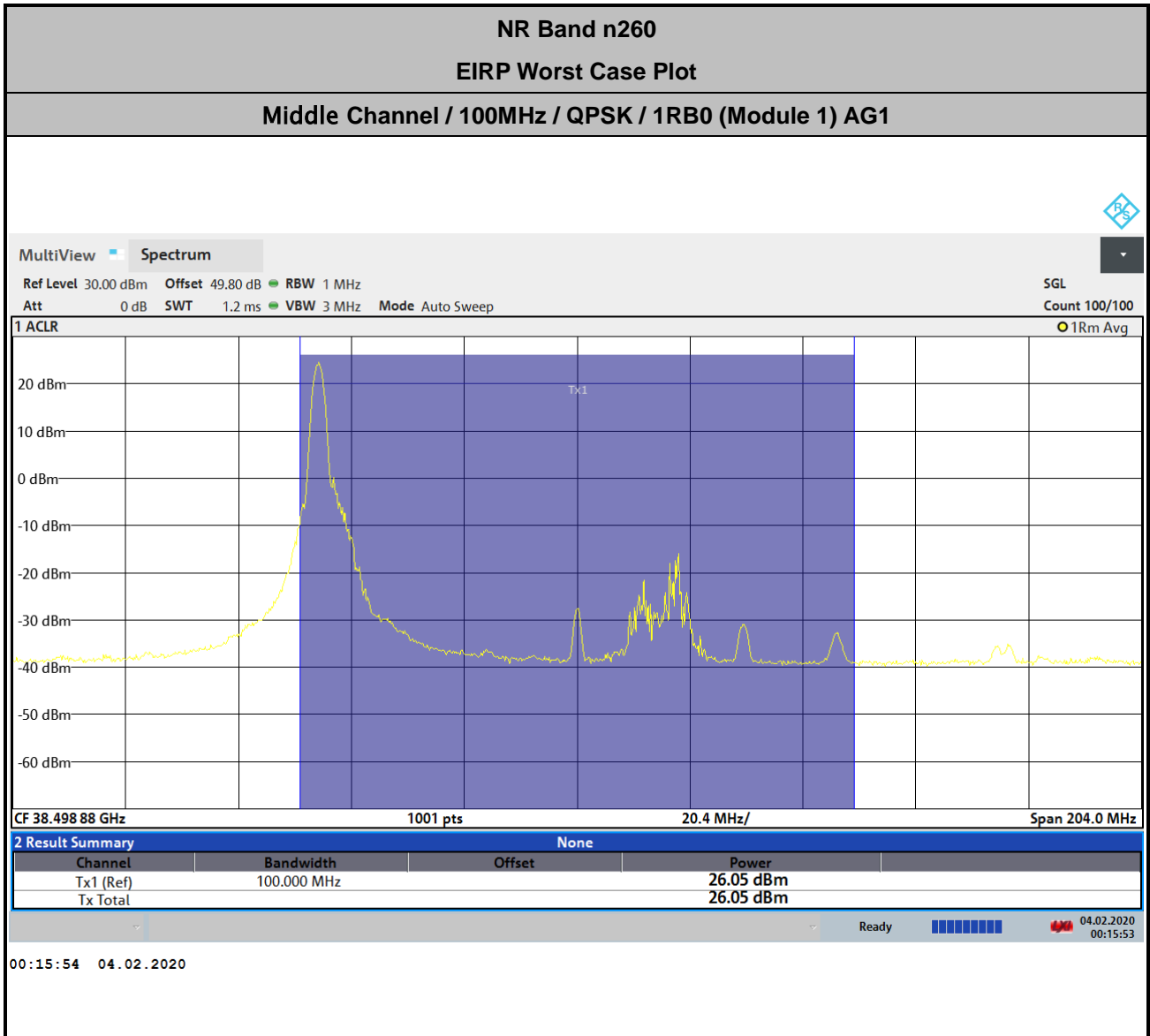

$$\begin{aligned}
 \text{Offset} &= \text{Antenna Factor (dB/m)} + \text{Cable Loss (dB)} + 107 + 20\log(D) - 104.8 \\
 &= 45.1 + 2.5 + 107 + 20\log(1) - 104.8 \\
 &= 49.8 \text{ (dB)}
 \end{aligned}$$



NR Band n261 Module 0							
Maximum Average EIRP [dBm]							
BW [MHz]	Antenna Array	RB Size	RB Offset	Mod	Lowest	Middle	Highest
50	AG0	1	0	QPSK	19.91	20.41	20.44
50		32	0		19.45	20.09	19.98
50	AG1	1	0	QPSK	19.44	20.72	20.31
50		32	0		19.17	20.44	19.86
50	AG0+AG1	1	0	QPSK	22.69	23.58	23.39
50		32	0		22.32	23.28	22.93
50	AG0	1	0	16-QAM	17.83	18.08	18.20
50		32	0		17.85	18.50	18.31
50	AG1	1	0	16-QAM	17.58	18.49	18.17
50		32	0		17.41	18.78	18.22
50	AG0+AG1	1	0	16-QAM	20.72	21.30	21.20
50		32	0		20.65	21.65	21.28
50	AG0	1	0	64-QAM	16.16	16.41	16.50
50		32	0		15.80	16.45	16.37
50	AG1	1	0	64-QAM	15.73	16.78	16.09
50		32	0		15.40	16.78	16.31
50	AG0+AG1	1	0	64-QAM	18.96	19.61	19.31
50		32	0		18.61	19.63	19.35



NR Band n261 Module 0							
Maximum Average EIRP [dBm]							
BW [MHz]	Antenna Array	RB Size	RB Offset	Mod	Lowest	Middle	Highest
100	AG0	1	0	QPSK	20.50	21.29	20.31
100		64	0		19.68	20.96	20.39
100	AG1	1	0	QPSK	20.16	21.08	20.01
100		64	0		19.46	20.73	20.09
100	AG0+AG1	1	0	QPSK	23.34	24.20	23.17
100		64	0		22.58	23.86	23.25
100	AG0	1	0	16-QAM	18.46	19.08	18.27
100		64	0		18.13	19.26	18.66
100	AG1	1	0	16-QAM	18.21	18.97	18.15
100		64	0		17.84	18.97	18.35
100	AG0+AG1	1	0	16-QAM	21.35	22.04	21.22
100		64	0		21.00	22.13	21.52
100	AG0	1	0	64-QAM	16.84	17.21	16.28
100		64	0		15.98	17.13	16.45
100	AG1	1	0	64-QAM	16.54	17.02	16.14
100		64	0		15.57	16.74	16.19
100	AG0+AG1	1	0	64-QAM	19.70	20.13	19.22
100		64	0		18.79	19.95	19.33



NR Band n261 Module 0							
Maximum Average EIRP [dBm]							
BW [MHz]	Antenna Array	RB Size	RB Offset	Mod	Lowest	Middle	Highest
400	AG0	64	0	QPSK	17.26	17.21	17.20
400	AG1	64	0	QPSK	18.83	18.99	18.95
400	AG0+AG1	64	0	QPSK	21.13	21.20	21.17
400	AG0	64	0	16-QAM	15.43	15.35	15.30
400	AG1	64	0	16-QAM	16.97	17.17	17.00
400	AG0+AG1	64	0	16-QAM	19.28	19.36	19.24
400	AG0	64	0	64-QAM	13.38	13.19	13.13
400	AG1	64	0	64-QAM	14.87	14.98	14.79
400	AG0+AG1	64	0	64-QAM	17.20	17.19	17.05



NR Band n261 Module 1							
Maximum Average EIRP [dBm]							
BW [MHz]	Antenna Array	RB Size	RB Offset	Mod	Lowest	Middle	Highest
50	AG0	1	0	QPSK	20.37	20.01	19.25
50		32	0		20.43	20.64	19.71
50	AG1	1	0	QPSK	21.44	20.44	19.81
50		32	0		22.04	21.08	20.35
50	AG0+AG1	1	0	QPSK	23.95	23.24	22.55
50		32	0		24.32	23.88	23.05
50	AG0	1	0	16-QAM	19.88	18.71	17.83
50		32	0		18.75	18.99	18.97
50	AG1	1	0	16-QAM	21.52	19.69	18.93
50		32	0		20.26	19.45	18.71
50	AG0+AG1	1	0	16-QAM	23.79	22.24	21.43
50		32	0		22.58	22.24	21.85
50	AG0	1	0	64-QAM	17.13	17.09	16.32
50		32	0		16.74	16.96	18.82
50	AG1	1	0	64-QAM	18.97	16.88	16.15
50		32	0		18.13	17.45	16.63
50	AG0+AG1	1	0	64-QAM	21.16	20.00	19.25
50		32	0		20.50	20.22	20.87



NR Band n261 Module 1							
Maximum Average EIRP [dBm]							
BW [MHz]	Antenna Array	RB Size	RB Offset	Mod	Lowest	Middle	Highest
100	AG0	1	0	QPSK	20.42	20.42	19.16
100		64	0		20.24	20.87	19.86
100	AG1	1	0	QPSK	21.83	21.15	19.48
100		64	0		21.22	20.65	20.39
100	AG0+AG1	1	0	QPSK	24.19	23.81	22.33
100		64	0		23.77	23.77	23.14
100	AG0	1	0	16-QAM	20.20	19.12	17.79
100		64	0		18.59	19.03	18.11
100	AG1	1	0	16-QAM	20.02	19.21	18.43
100		64	0		19.60	18.97	18.68
100	AG0+AG1	1	0	16-QAM	23.12	22.18	21.13
100		64	0		22.13	22.01	21.41
100	AG0	1	0	64-QAM	17.11	17.14	15.94
100		64	0		16.37	16.86	16.02
100	AG1	1	0	64-QAM	17.65	16.74	15.85
100		64	0		17.39	16.79	16.45
100	AG0+AG1	1	0	64-QAM	20.40	19.95	18.91
100		64	0		19.92	19.84	19.25



NR Band n261 Module 1							
Maximum Average EIRP [dBm]							
BW [MHz]	Antenna Array	RB Size	RB Offset	Mod	Lowest	Middle	Highest
400	AG0	64	0	QPSK	18.31	18.12	17.19
400	AG1	64	0	QPSK	20.73	19.83	18.79
400	AG0+AG1	64	0	QPSK	22.70	22.07	21.07
400	AG0	64	0	16-QAM	16.48	16.29	15.40
400	AG1	64	0	16-QAM	19.03	18.04	17.03
400	AG0+AG1	64	0	16-QAM	20.95	20.26	19.30
400	AG0	64	0	64-QAM	14.35	14.07	13.19
400	AG1	64	0	64-QAM	16.70	15.81	14.74
400	AG0+AG1	64	0	64-QAM	18.69	18.04	17.04

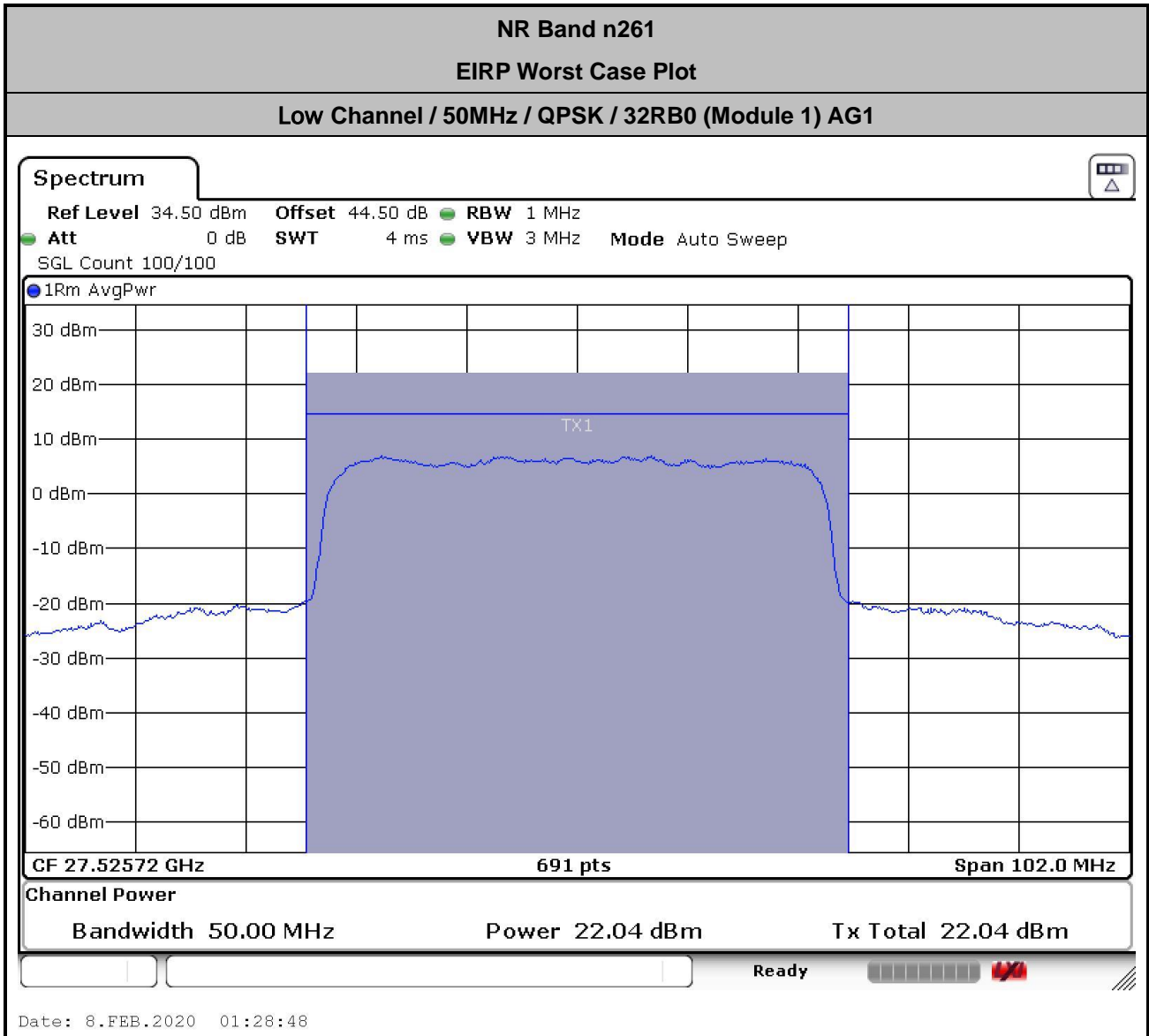

$$\begin{aligned}
 \text{Offset} &= \text{Antenna Factor (dB/m)} + \text{Cable Loss (dB)} + 107 + 20\log(D) - 104.8 \\
 &= 40.5 + 1.8 + 107 + 20\log(1) - 104.8 \\
 &= 44.5 \text{ (dB)}
 \end{aligned}$$



NR Band n260

Occupied Bandwidth

Mode	Module 0 AG0 NR Band n260 : 99%OBW(MHz)								
BW	50MHz			100MHz			400MHz		
Mod.	QPSK	16QAM	64QAM	QPSK	16QAM	64QAM	QPSK	16QAM	64QAM
Lowest CH	45.86	45.18	45.46	90.84	90.39	90.36	385.20	385.34	385.51
Middle CH	45.77	45.16	45.47	90.68	90.36	90.39	385.94	386.18	385.79
Highest CH	45.77	45.21	45.33	91.47	90.10	90.56	386.23	385.23	385.81

Mode	Module 0 AG1 NR Band n260 : 99%OBW(MHz)								
BW	50MHz			100MHz			400MHz		
Mod.	QPSK	16QAM	64QAM	QPSK	16QAM	64QAM	QPSK	16QAM	64QAM
Lowest CH	45.23	45.13	45.34	90.41	90.21	90.49	385.95	384.15	383.92
Middle CH	45.23	45.11	45.37	90.51	90.31	90.57	386.39	384.43	384.80
Highest CH	45.13	45.11	45.26	90.53	90.23	90.45	386.27	384.80	385.23

Mode	Module 1 AG0 NR Band n260 : 99%OBW(MHz)								
BW	50MHz			100MHz			400MHz		
Mod.	QPSK	16QAM	64QAM	QPSK	16QAM	64QAM	QPSK	16QAM	64QAM
Lowest CH	45.66	45.37	45.21	90.69	90.20	90.28	385.96	385.16	384.27
Middle CH	45.61	45.40	45.30	90.72	90.39	90.50	385.83	385.22	384.95
Highest CH	45.93	45.38	45.19	91.25	90.33	90.37	386.88	385.74	385.71

Mode	Module 1 AG1 NR Band n260 : 99%OBW(MHz)								
BW	50MHz			100MHz			400MHz		
Mod.	QPSK	16QAM	64QAM	QPSK	16QAM	64QAM	QPSK	16QAM	64QAM
Lowest CH	45.68	45.40	45.27	90.80	90.39	90.48	386.20	383.75	383.57
Middle CH	45.52	45.35	45.33	91.06	90.21	90.65	385.62	384.80	383.49
Highest CH	45.57	45.35	45.19	90.78	90.57	90.58	386.71	385.01	384.78



Module 0 AGO

NR Band n260

Lowest Channel / 50MHz / QPSK

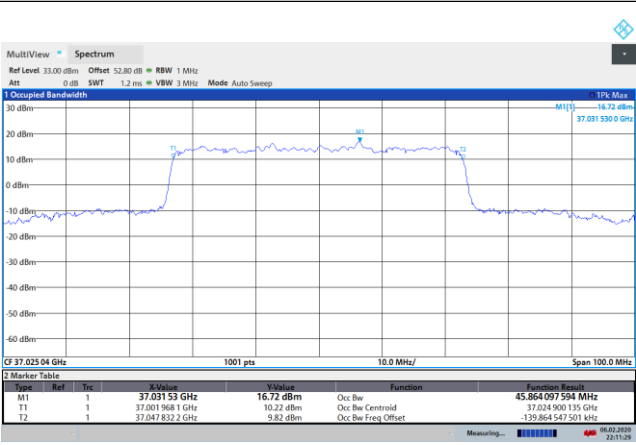

Lowest Channel / 50MHz / 16QAM

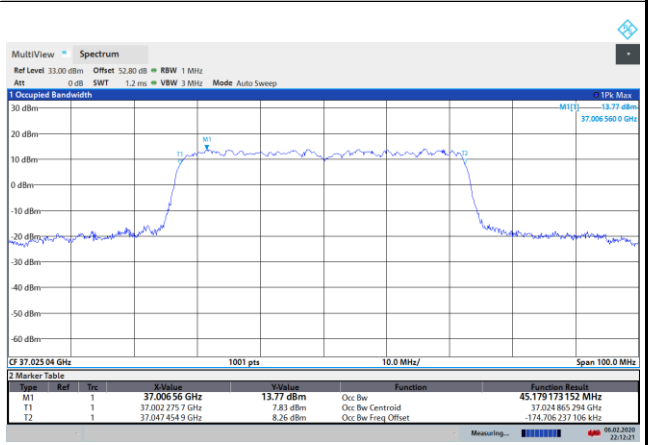

Middle Channel / 50MHz / QPSK

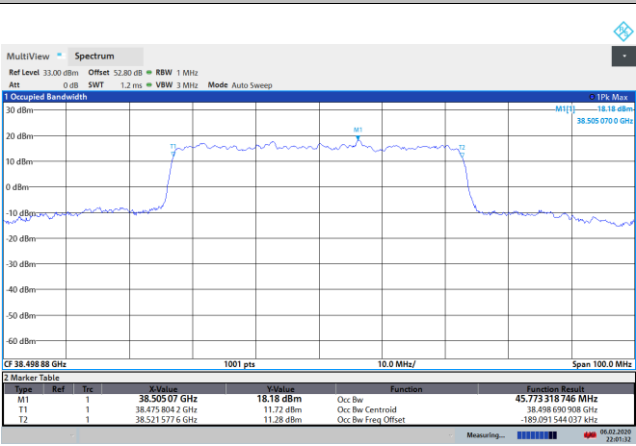

Middle Channel / 50MHz / 16QAM

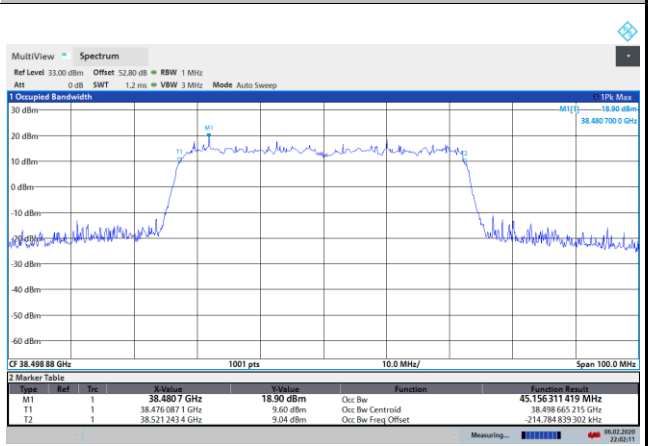

Highest Channel / 50MHz / QPSK

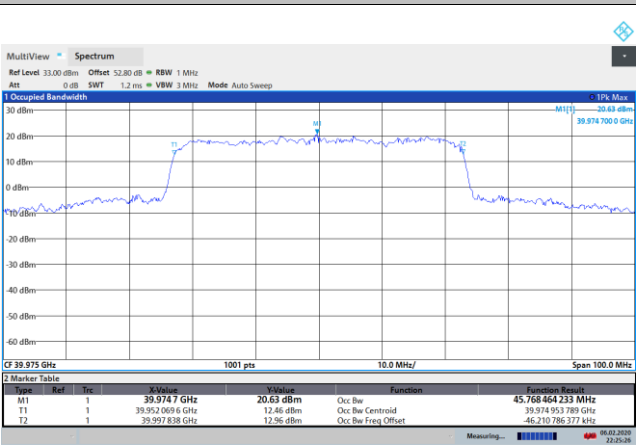

Highest Channel / 50MHz / 16QAM

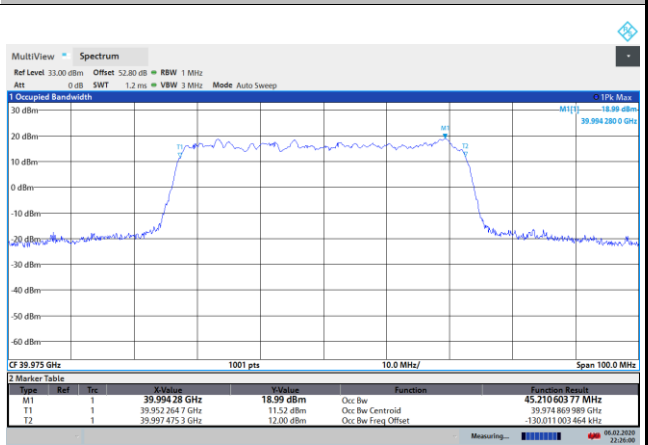



Module 0 AGO

NR Band n260

Lowest Channel / 50MHz / 64QAM

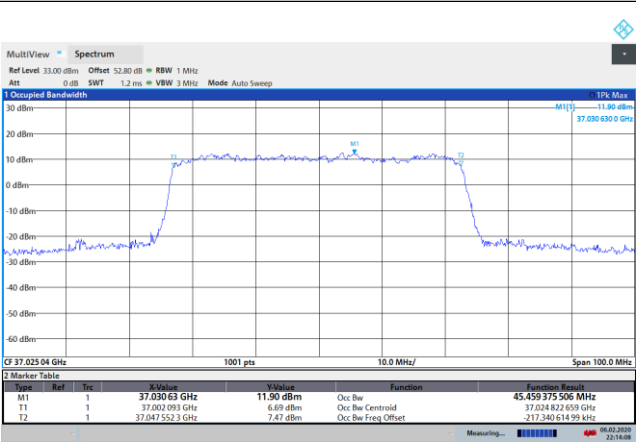

Lowest Channel / 100MHz / QPSK

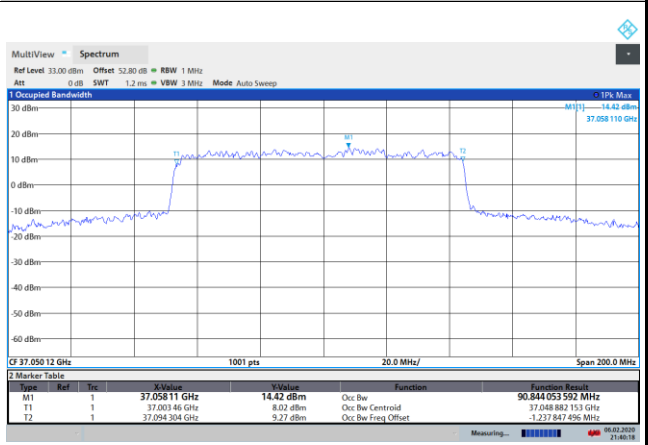

Middle Channel / 50MHz / 64QAM

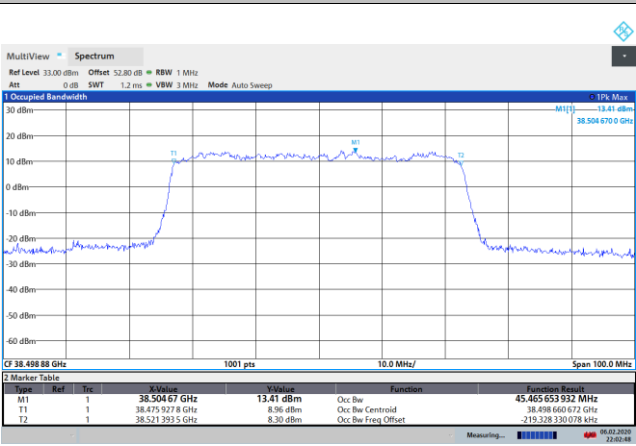

Middle Channel / 100MHz / QPSK

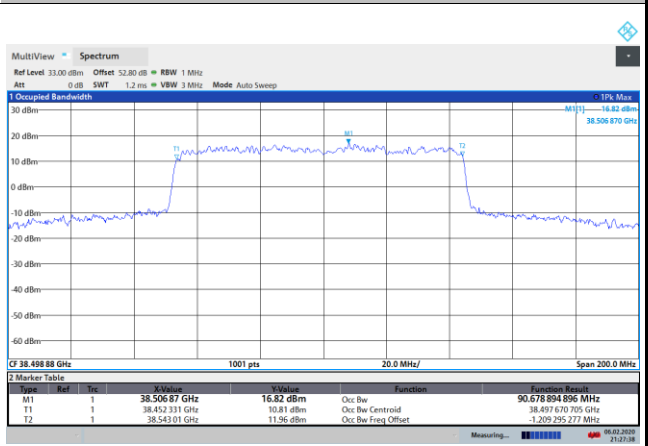

Highest Channel / 50MHz / 64QAM

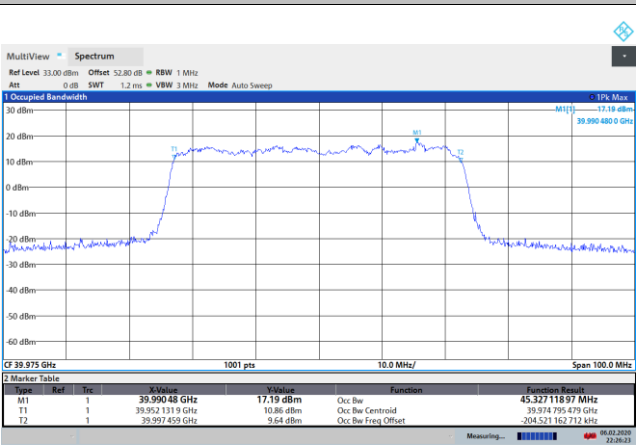

Highest Channel / 100MHz / QPSK

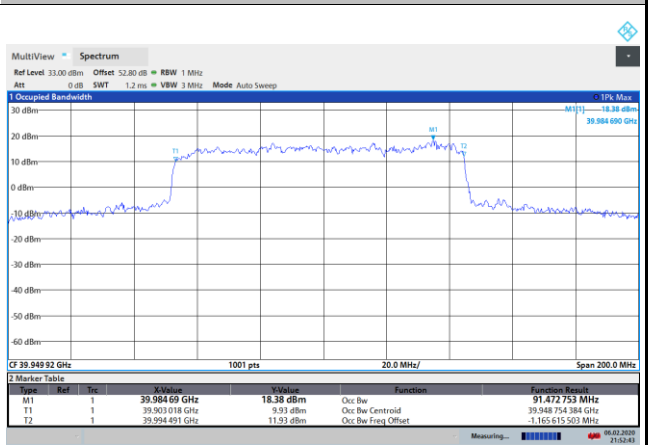



Module 0 AGO

NR Band n260

Lowest Channel / 100MHz / 16QAM

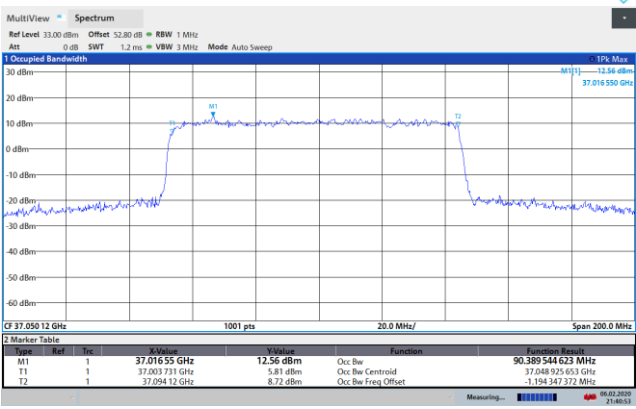

Lowest Channel / 100MHz / 64QAM

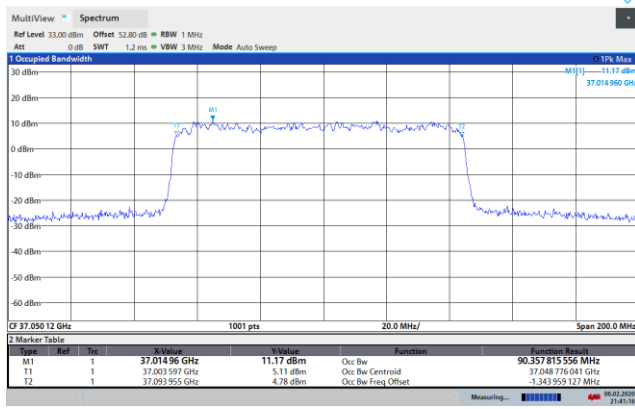

Middle Channel / 100MHz / 16QAM

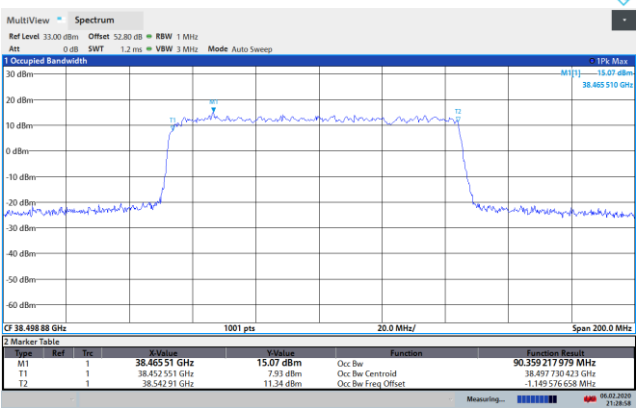

Middle Channel / 100MHz / 64QAM

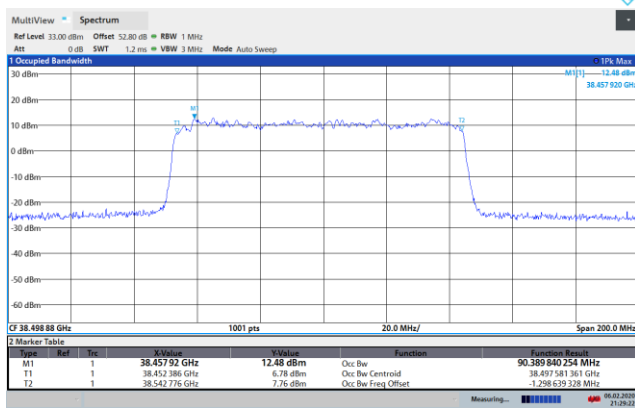

Highest Channel / 100MHz / 16QAM

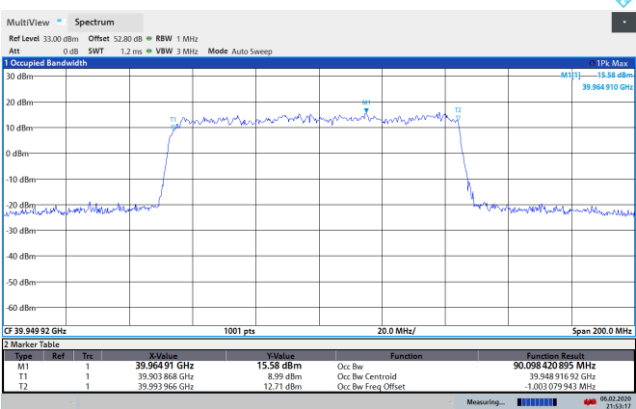

Highest Channel / 100MHz / 64QAM

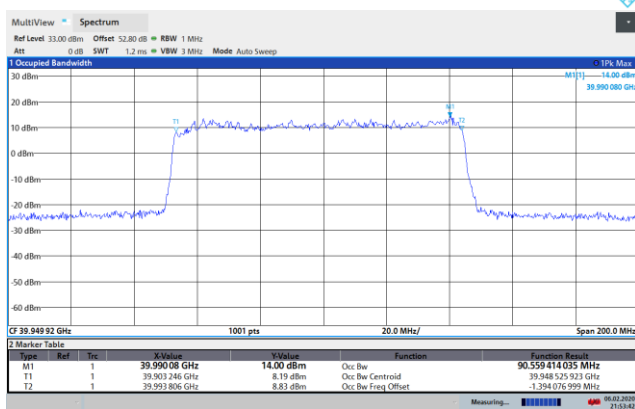



Module 0 AGO

NR Band n260

Lowest Channel / 400MHz / QPSK

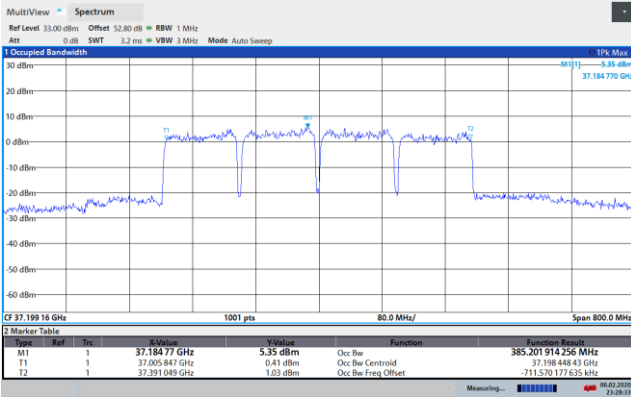

Lowest Channel / 400MHz / 16QAM

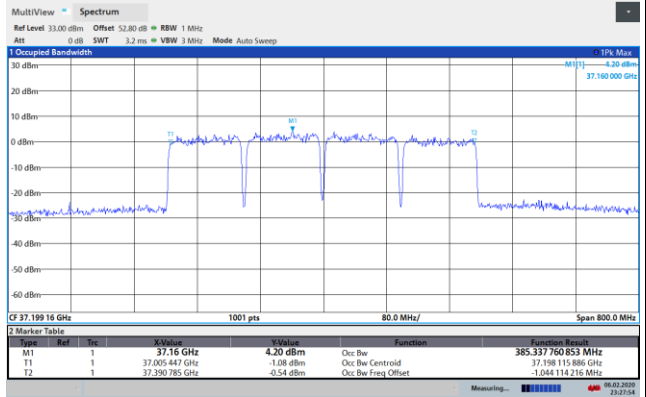

Middle Channel / 400MHz / QPSK

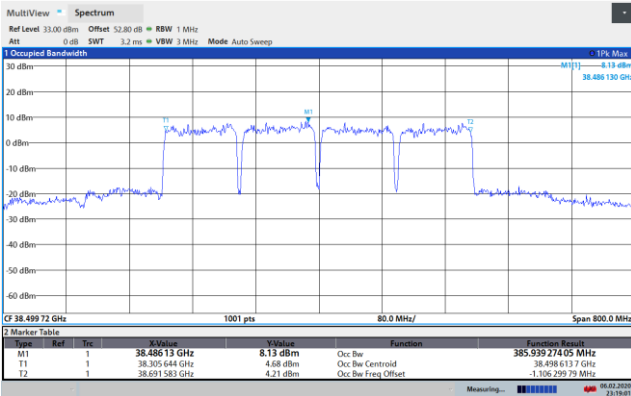

Middle Channel / 400MHz / 16QAM

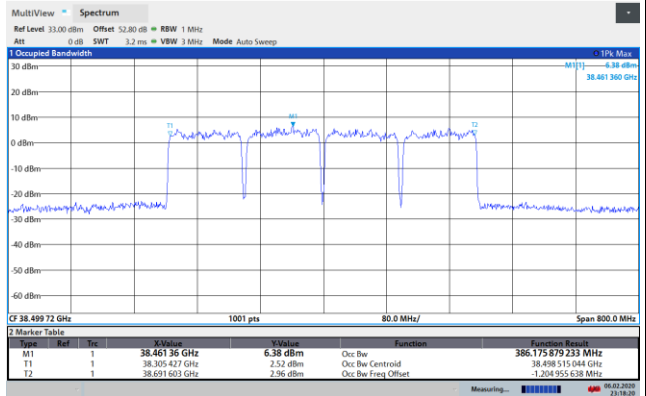

Highest Channel / 400MHz / QPSK

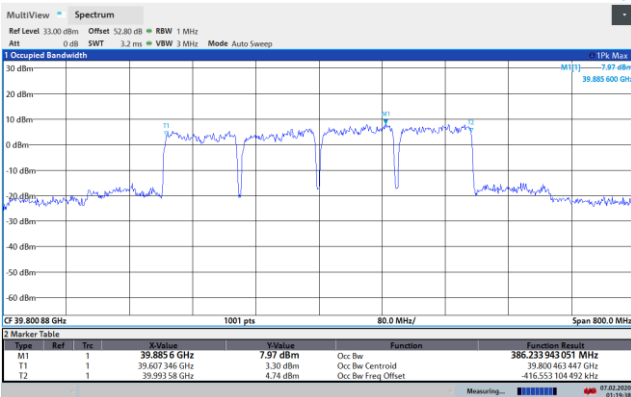

Highest Channel / 400MHz / 16QAM

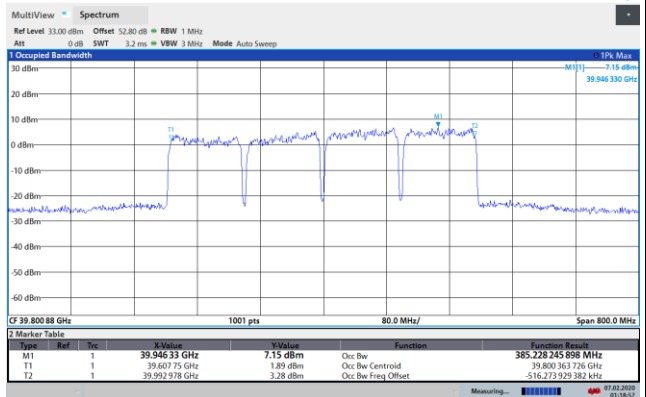



Module 0 AGO

NR Band n260

Lowest Channel / 400MHz / 64QAM

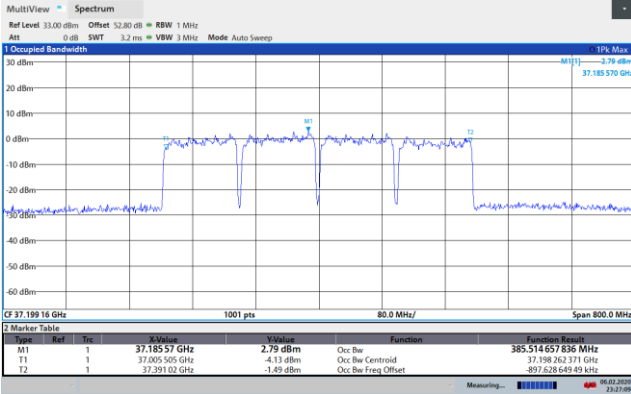

intentionally blank

Middle Channel / 400MHz / 64QAM

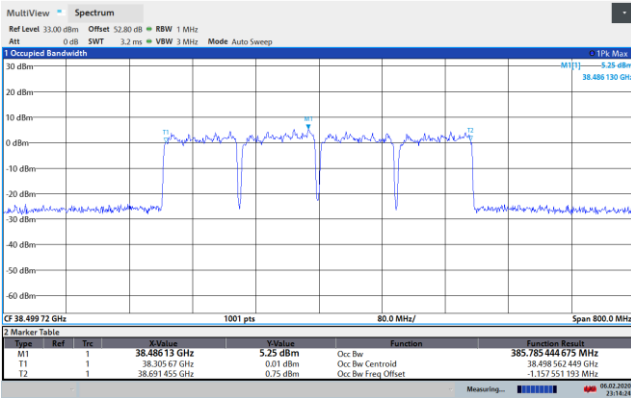

intentionally blank

Highest Channel / 400MHz / 64QAM

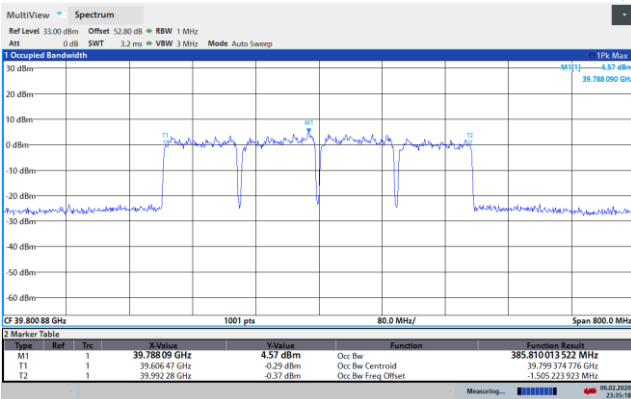

intentionally blank



Module 0 AG1

NR Band n260

Lowest Channel / 50MHz / QPSK

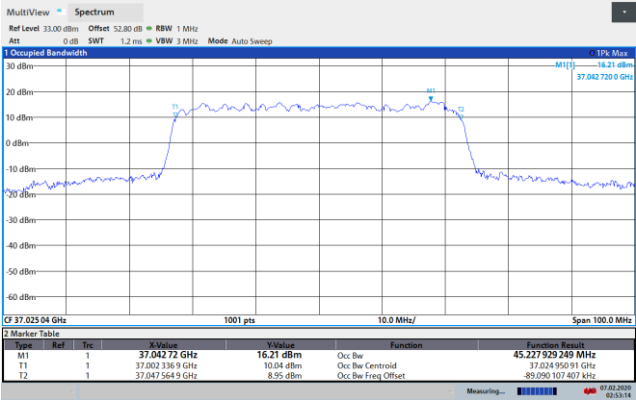

Lowest Channel / 50MHz / 16QAM

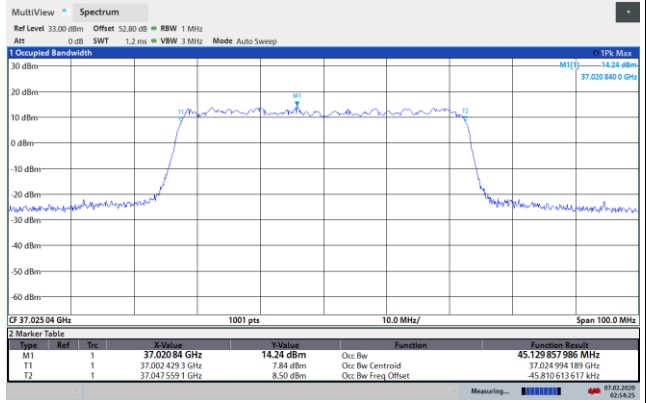

Middle Channel / 50MHz / QPSK

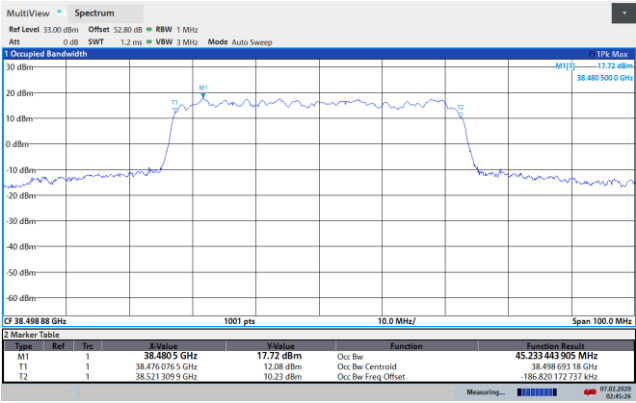

Middle Channel / 50MHz / 16QAM

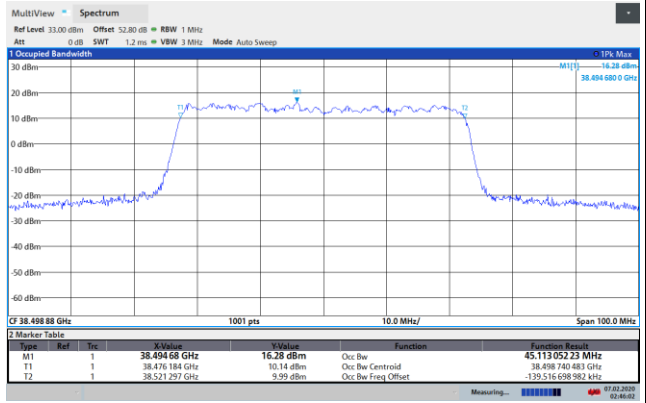

Highest Channel / 50MHz / QPSK

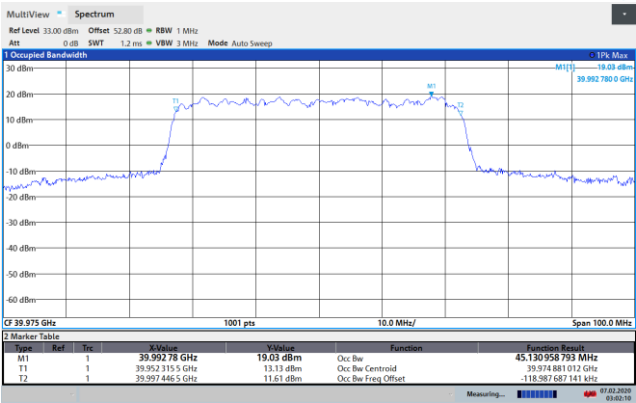

Highest Channel / 50MHz / 16QAM

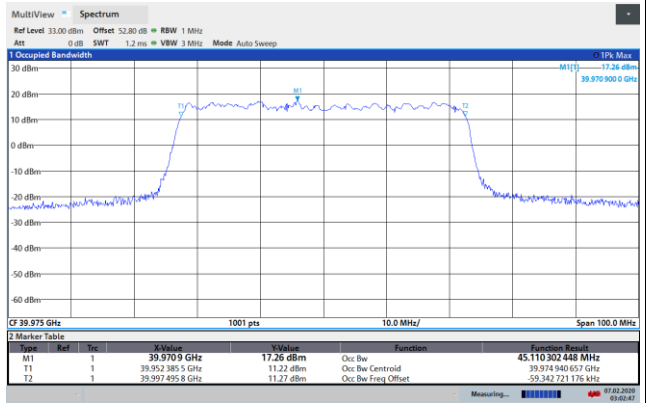



Module 0 AG1

NR Band n260

Lowest Channel / 50MHz / 64QAM

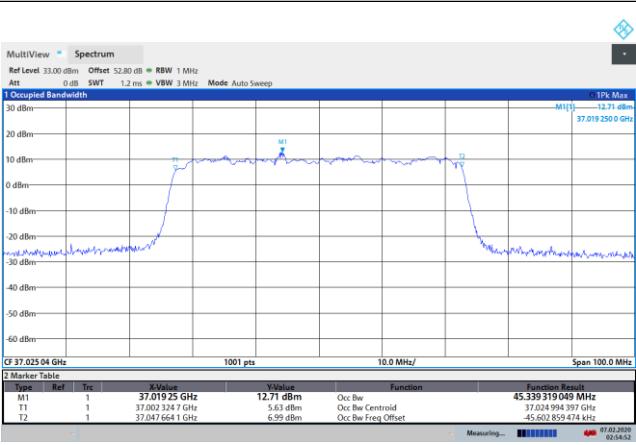

Lowest Channel / 100MHz / QPSK

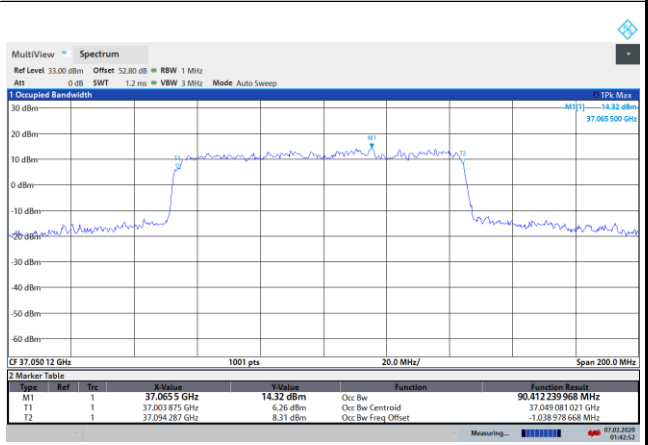

Middle Channel / 50MHz / 64QAM

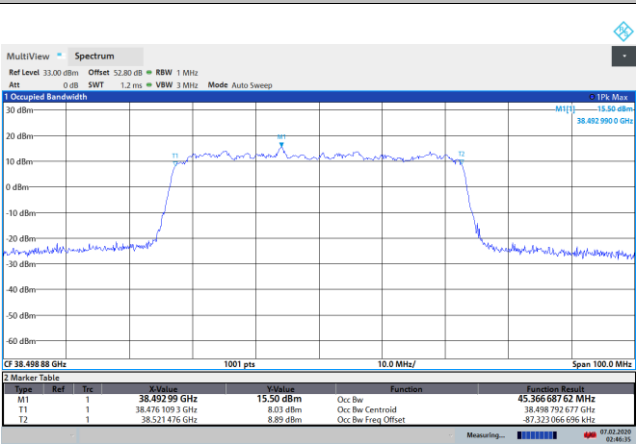

Middle Channel / 100MHz / QPSK

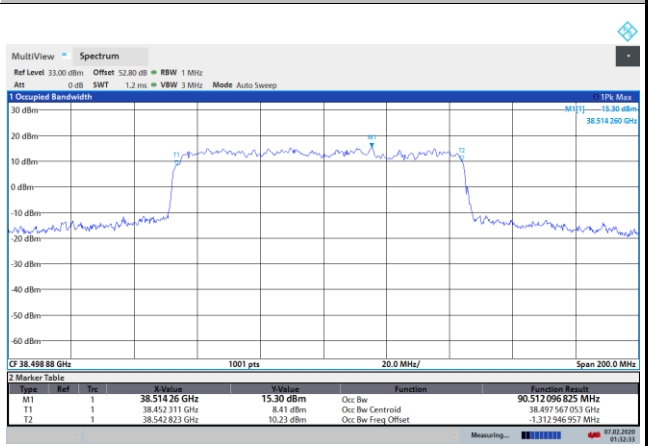

Highest Channel / 50MHz / 64QAM

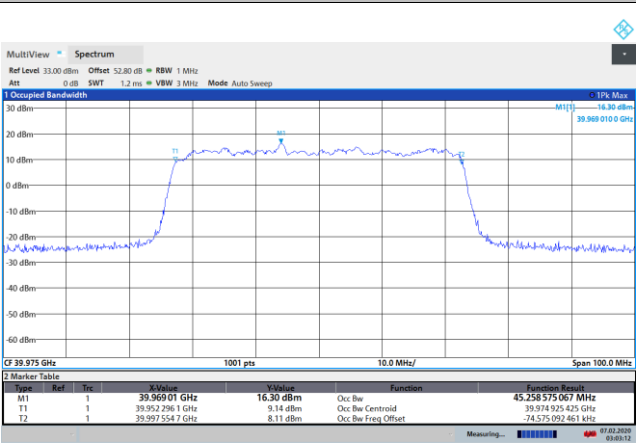

Highest Channel / 100MHz / QPSK

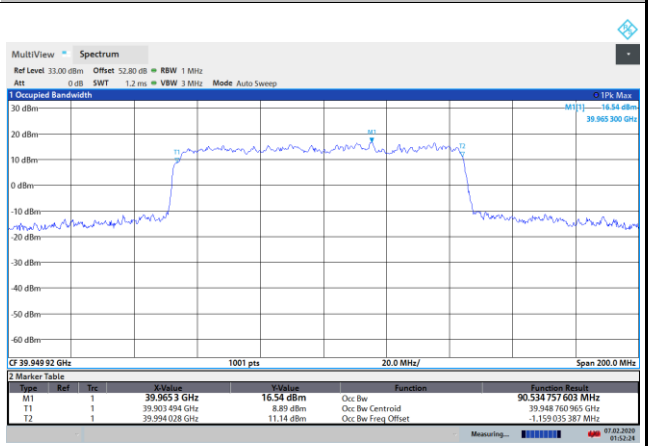



Module 0 AG1

NR Band n260

Lowest Channel / 100MHz / 16QAM

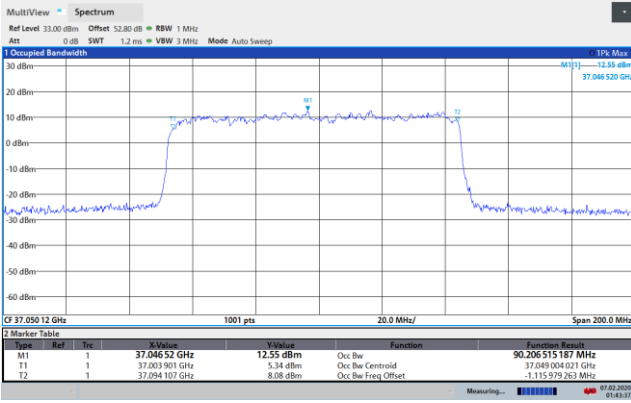

Lowest Channel / 100MHz / 64QAM

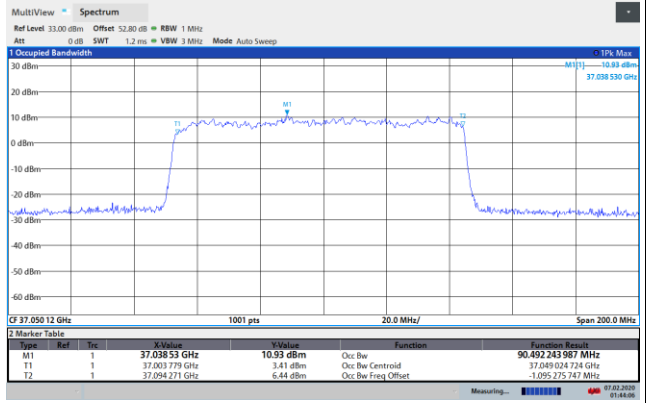

Middle Channel / 100MHz / 16QAM

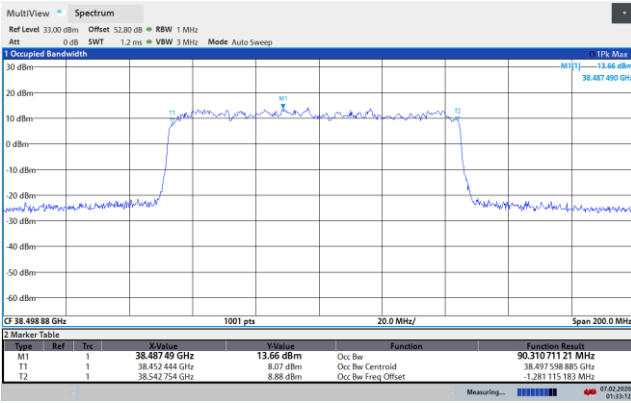

Middle Channel / 100MHz / 64QAM

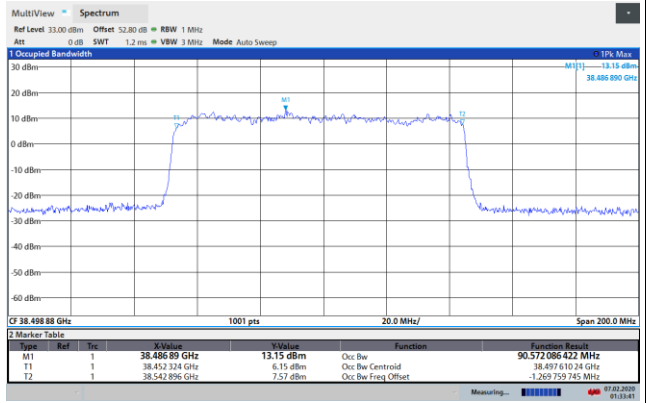

Highest Channel / 100MHz / 16QAM

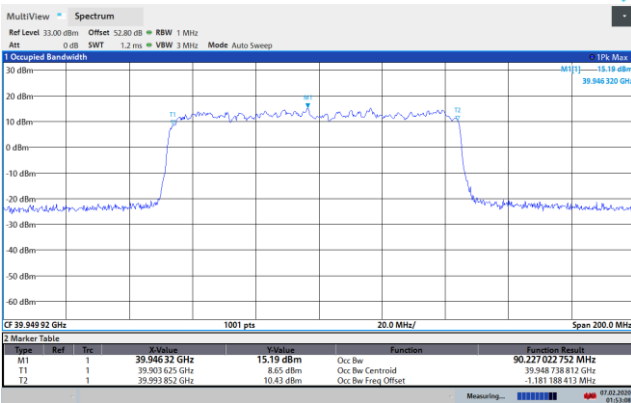

Highest Channel / 100MHz / 64QAM

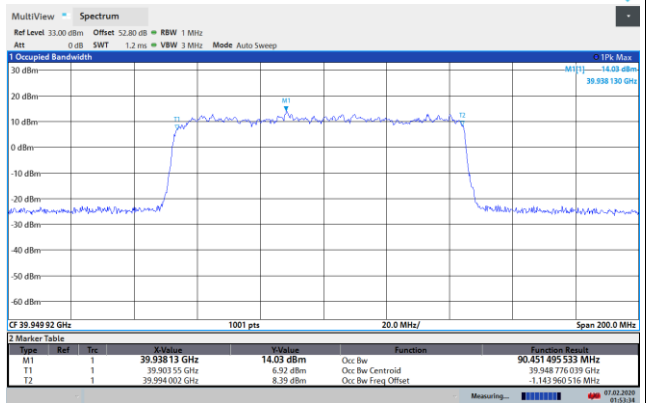



Module 0 AG1

NR Band n260

Lowest Channel / 400MHz / QPSK

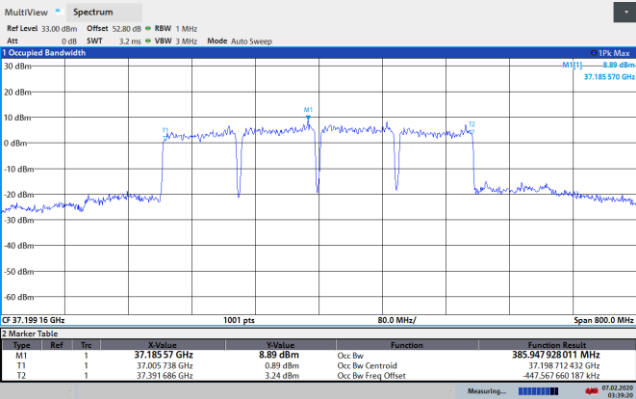

Lowest Channel / 400MHz / 16QAM

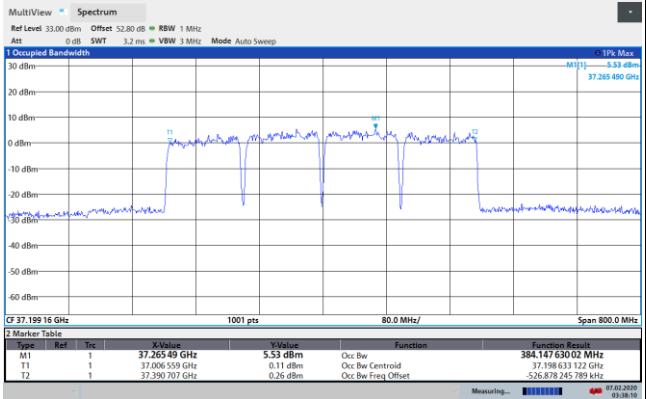

Middle Channel / 400MHz / QPSK

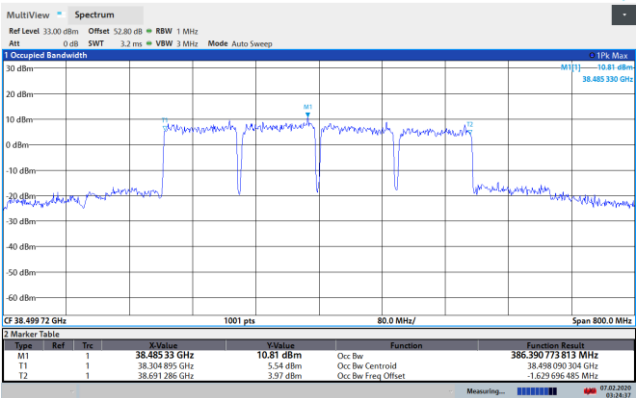

Middle Channel / 400MHz / 16QAM

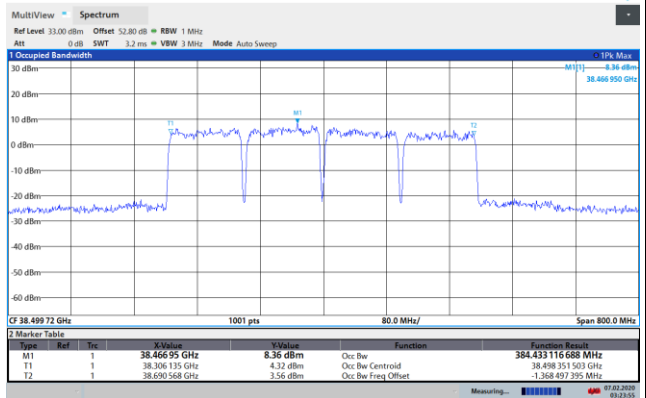

Highest Channel / 400MHz / QPSK

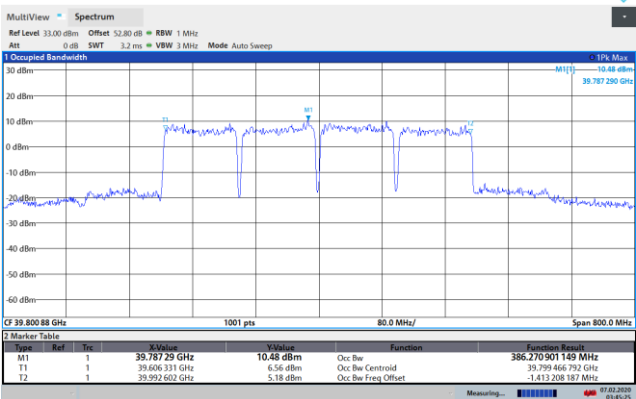

Highest Channel / 400MHz / 16QAM

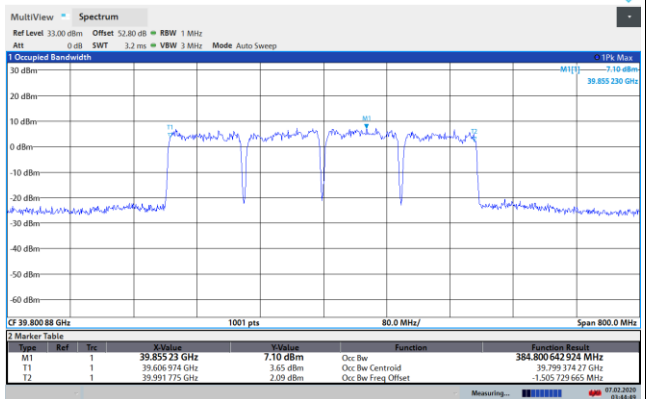



Module 0 AG1

NR Band n260

Lowest Channel / 400MHz / 64QAM

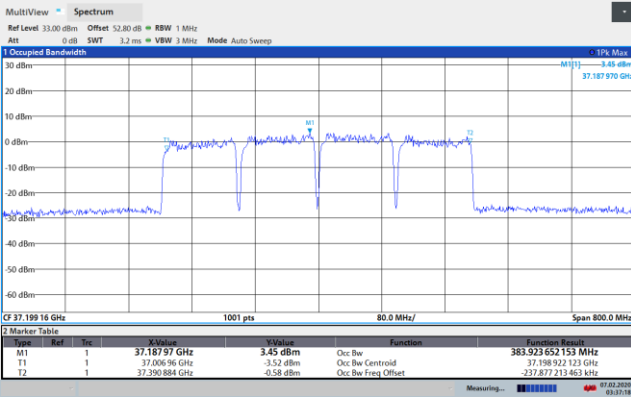

intentionally blank

Middle Channel / 400MHz / 64QAM

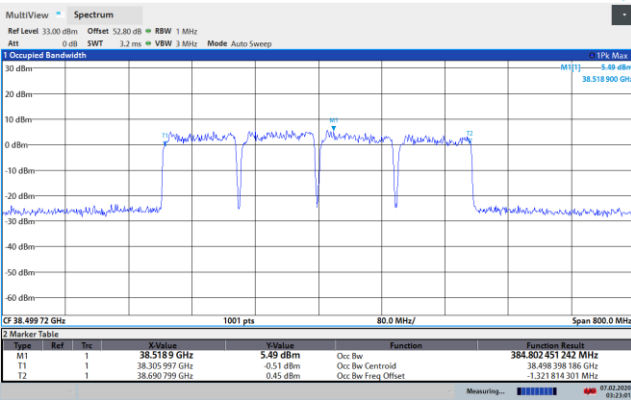

intentionally blank

Highest Channel / 400MHz / 64QAM

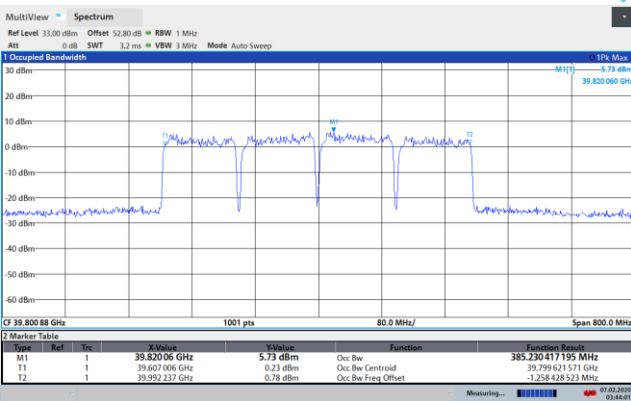

intentionally blank



Module 1 AGO

NR Band n260

Lowest Channel / 50MHz / QPSK

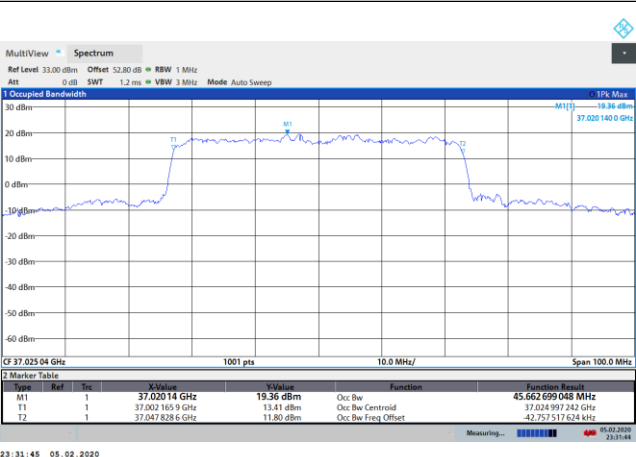

Lowest Channel / 50MHz / 16QAM

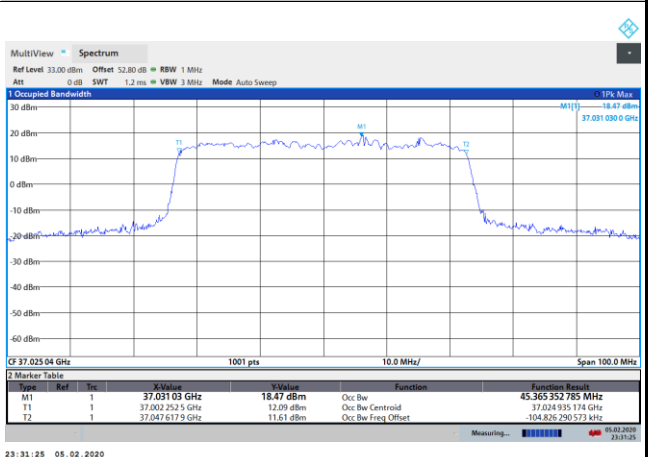

Middle Channel / 50MHz / QPSK

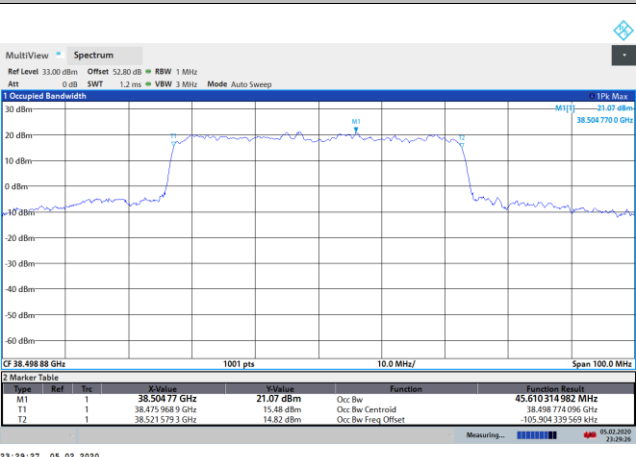

Middle Channel / 50MHz / 16QAM

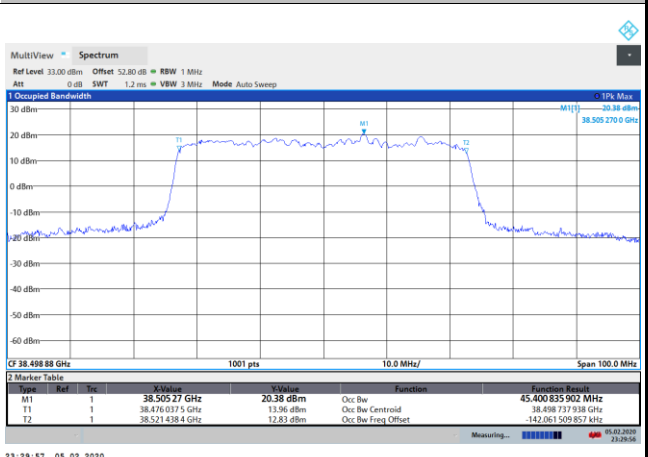

Highest Channel / 50MHz / QPSK

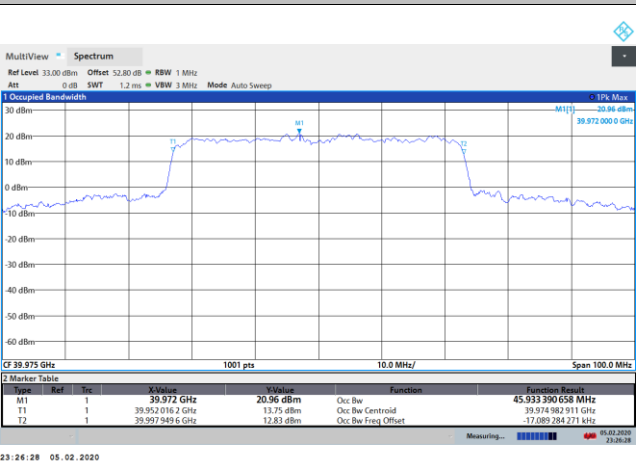

Highest Channel / 50MHz / 16QAM

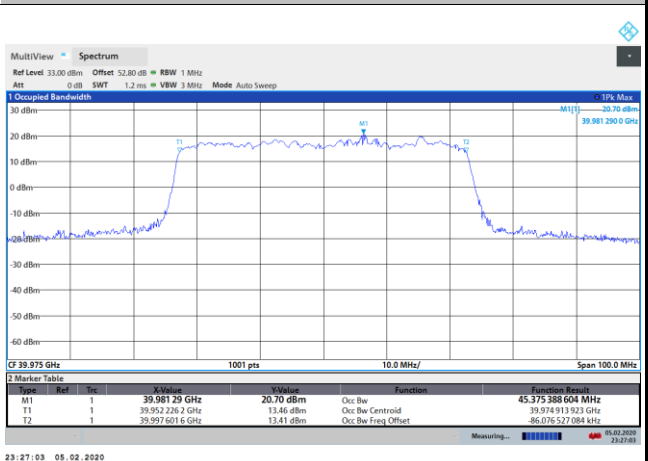



Module 1 AGO

NR Band n260

Lowest Channel / 50MHz / 64QAM

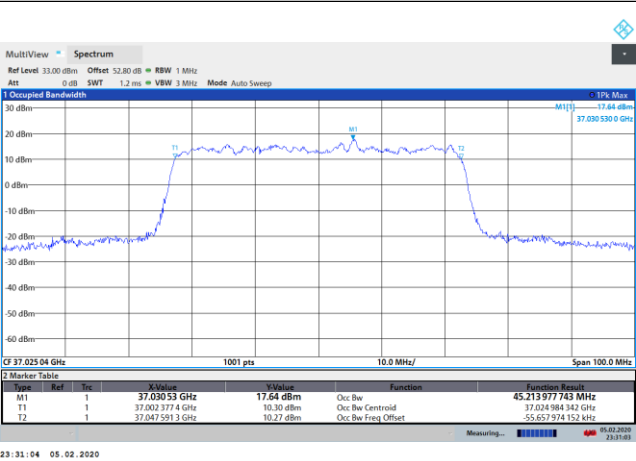

Lowest Channel / 100MHz / QPSK

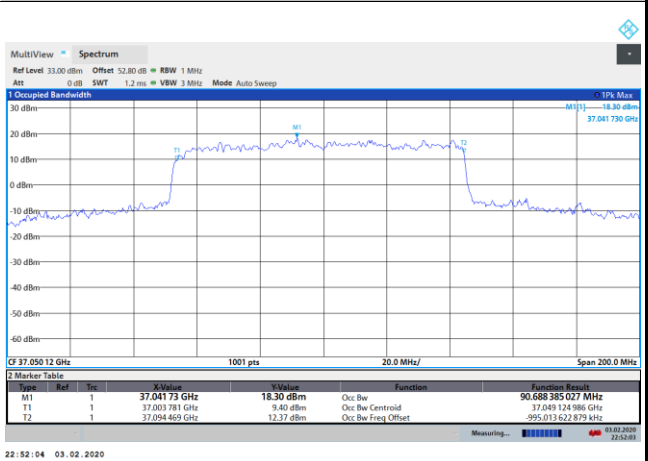

Middle Channel / 50MHz / 64QAM

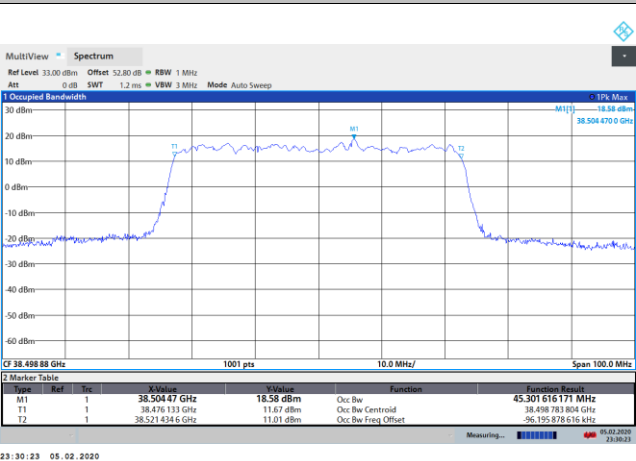

Middle Channel / 100MHz / QPSK

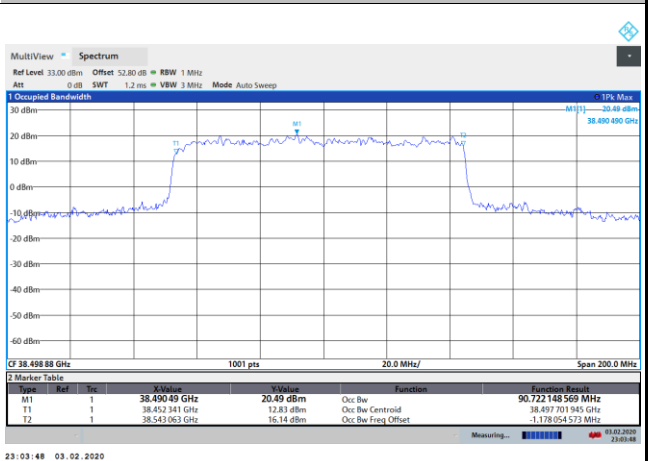

Highest Channel / 50MHz / 64QAM

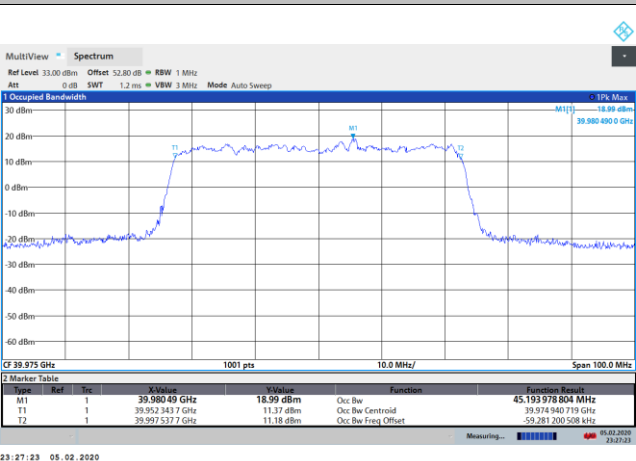

Highest Channel / 100MHz / QPSK

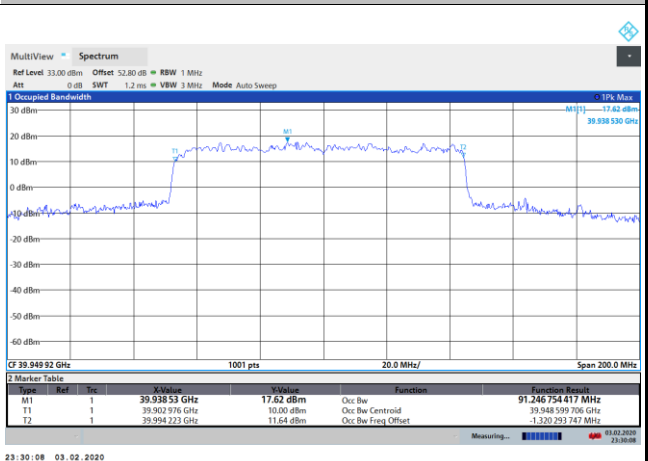



Module 1 AGO

NR Band n260

Lowest Channel / 100MHz / 16QAM

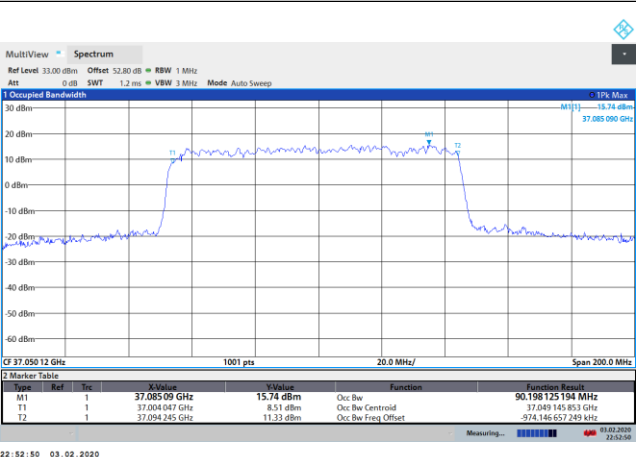

Lowest Channel / 100MHz / 64QAM

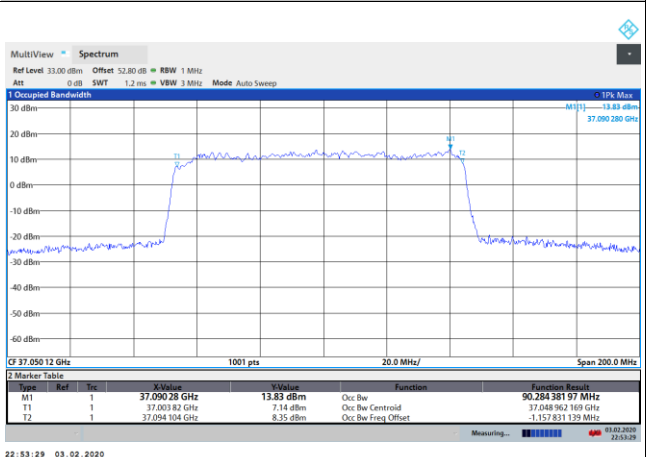

Middle Channel / 100MHz / 16QAM

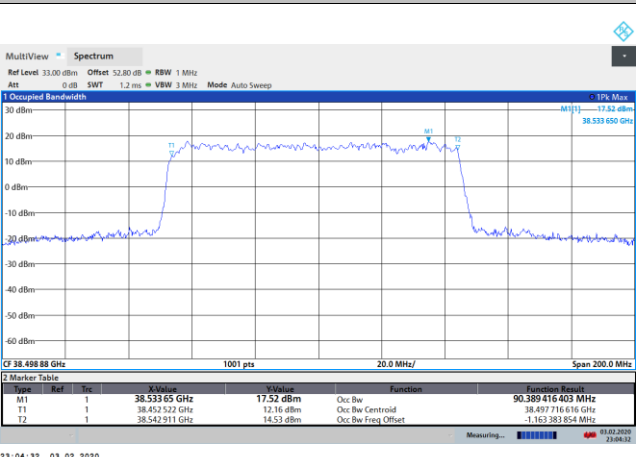

Middle Channel / 100MHz / 64QAM

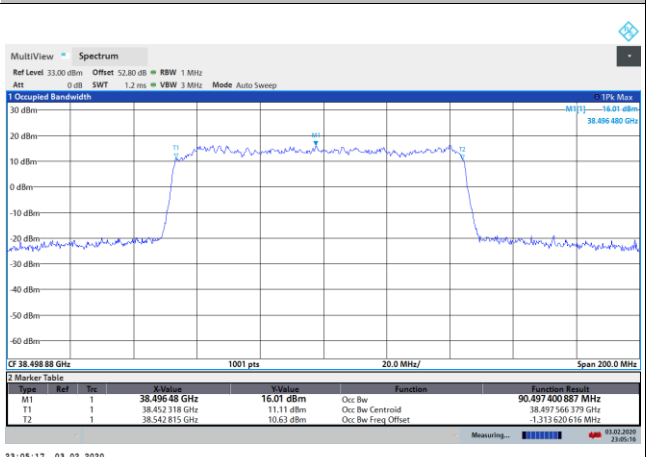

Highest Channel / 100MHz / 16QAM

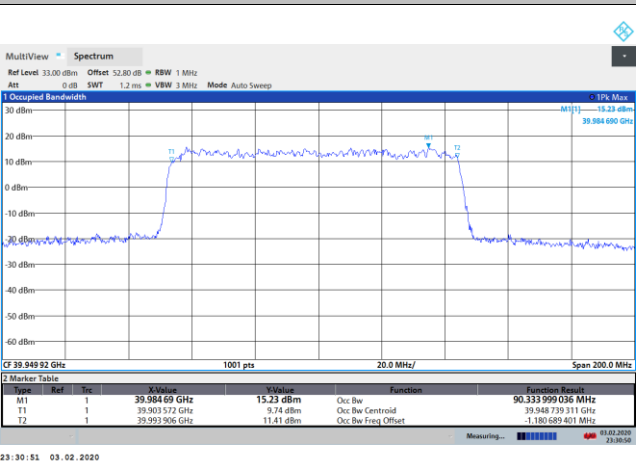

Highest Channel / 100MHz / 64QAM

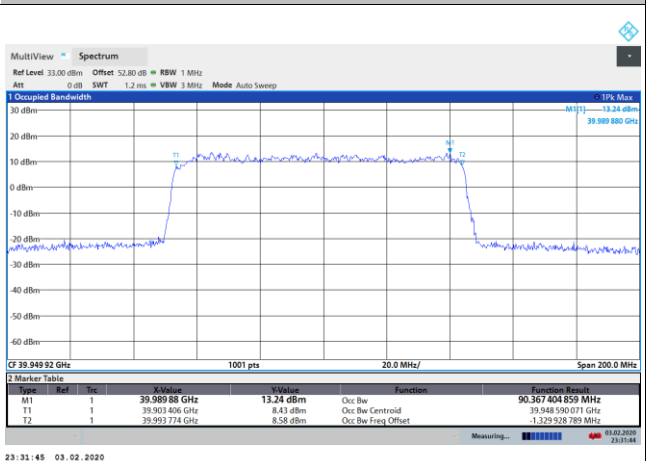



Module 1 AGO

NR Band n260

Lowest Channel / 400MHz / QPSK

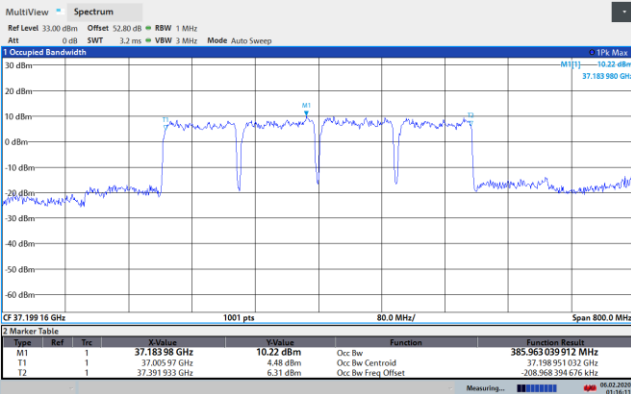

Lowest Channel / 400MHz / 16QAM

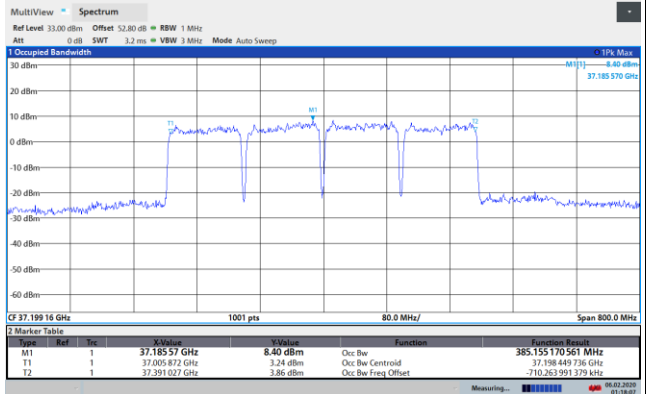

Middle Channel / 400MHz / QPSK

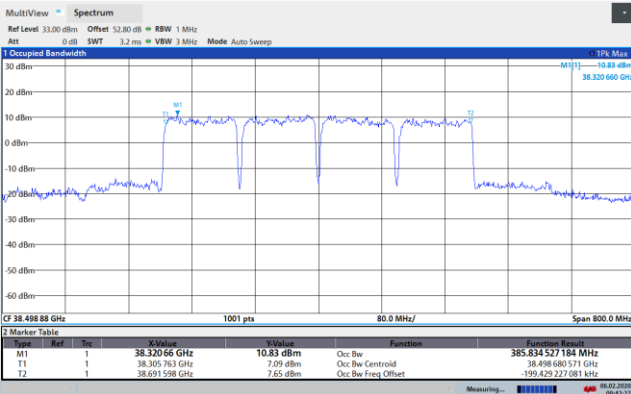

Middle Channel / 400MHz / 16QAM

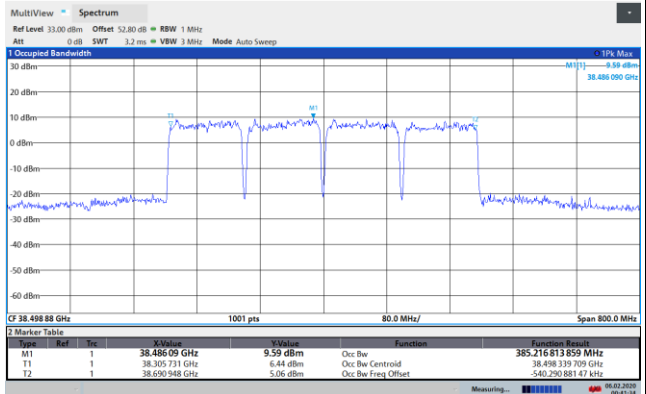

Highest Channel / 400MHz / QPSK

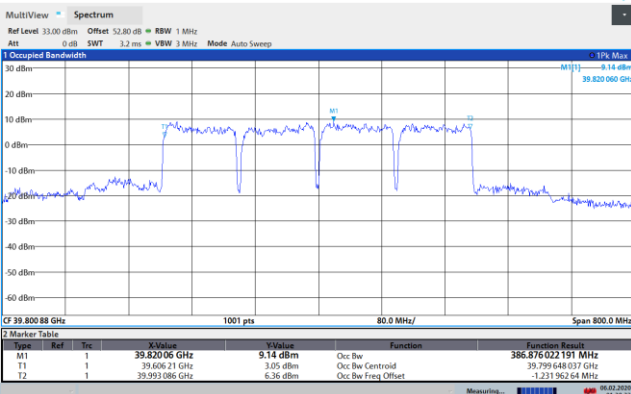

Highest Channel / 400MHz / 16QAM





Module 1 AGO

NR Band n260

Lowest Channel / 400MHz / 64QAM

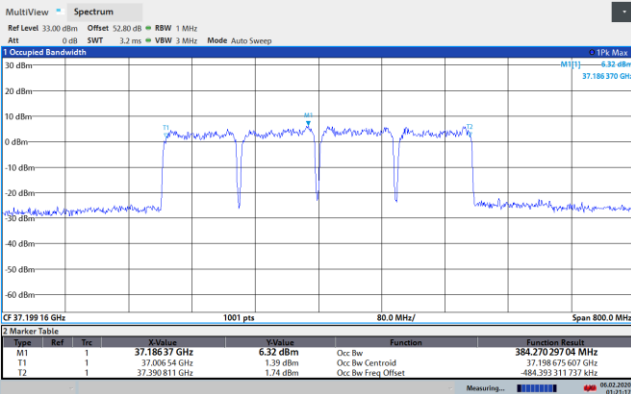

intentionally blank

Middle Channel / 400MHz / 64QAM

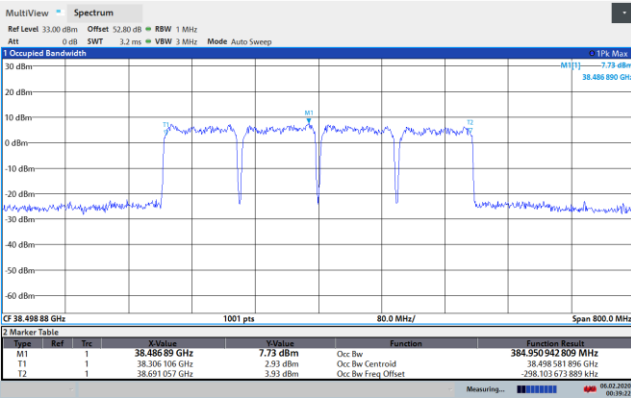

intentionally blank

Highest Channel / 400MHz / 64QAM

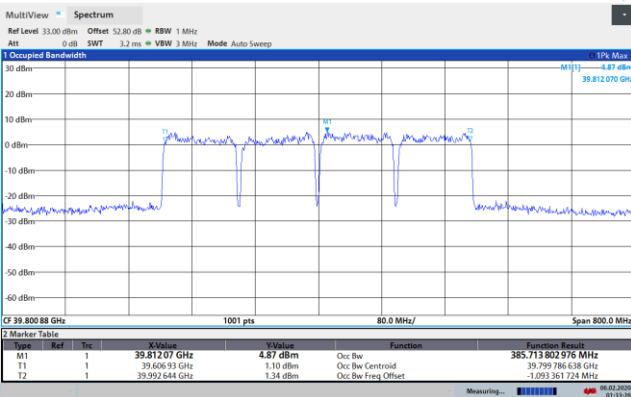

intentionally blank