



FCC RF Test Report

APPLICANT : Motorola Mobility LLC
EQUIPMENT : Mobile Cellular Phone
BRAND NAME : Motorola
MODEL NAME : XT2019-2
FCC ID : IHDT56YG2
STANDARD : FCC Part 15 Subpart E §15.407
CLASSIFICATION : (NII) Unlicensed National Information Infrastructure

The product was received on Jun. 25, 2019 and testing was completed on Aug. 02, 2019. We, Sporton International (Kunshan) Inc., would like to declare that the tested sample has been evaluated in accordance with the test procedures and has been in compliance with the applicable technical standards.

The test results in this report apply exclusively to the tested model / sample. Without written approval of Sporton International (Kunshan) Inc., the test report shall not be reproduced except in full.

Jason Jia

Reviewed by: Jason Jia / Supervisor

James Huang

Approved by: James Huang / Manager



Sporton International (Kunshan) Inc.

**No. 1098, Pengxi North Road, Kunshan Economic Development Zone Jiangsu Province 215300
People's Republic of China**



TABLE OF CONTENTS

REVISION HISTORY..... 3

SUMMARY OF TEST RESULT 4

1 GENERAL DESCRIPTION 5

 1.1 Applicant 5

 1.2 Manufacturer 5

 1.3 Product Feature of Equipment Under Test..... 5

 1.4 Product Specification of Equipment Under Test..... 6

 1.5 Modification of EUT 6

 1.6 Testing Location 6

 1.7 Applicable Standards 7

 1.8 Specification of Accessory 7

2 TEST CONFIGURATION OF EQUIPMENT UNDER TEST 9

 2.1 Carrier Frequency and Channel 9

 2.2 Test Mode 10

 2.3 Connection Diagram of Test System 11

 2.4 Support Unit used in test configuration and system 12

 2.5 EUT Operation Test Setup 12

 2.6 Measurement Results Explanation Example 12

3 TEST RESULT 13

 3.1 6dB and 26dB and 99% Occupied Bandwidth Measurement 13

 3.2 Maximum Conducted Output Power Measurement 16

 3.3 Power Spectral Density Measurement 17

 3.4 Unwanted Emissions Measurement 19

 3.5 AC Conducted Emission Measurement..... 24

 3.6 Automatically Discontinue Transmission 26

 3.7 Antenna Requirements 27

4 LIST OF MEASURING EQUIPMENT 28

5 UNCERTAINTY OF EVALUATION 29

APPENDIX A. CONDUCTED TEST RESULTS

APPENDIX B. AC CONDUCTED EMISSION TEST RESULT

APPENDIX C. RADIATED SPURIOUS EMISSION

APPENDIX D. DUTY CYCLE PLOTS

APPENDIX E. SETUP PHOTOGRAPHS



SUMMARY OF TEST RESULT

| Report Section | FCC Rule | Description | Limit | Result | Remark |
|----------------|--------------------|--|-----------------------------|--------|--------------------------------------|
| 3.1 | 15.403(i) | 6dB, 26dB and 99% Occupied Bandwidth | > 500kHz | Pass | - |
| 3.2 | 15.407(a) | Maximum Conducted Output Power | ≤ 30 dBm | Pass | - |
| 3.3 | 15.407(a) | Power Spectral Density | ≤ 30 dBm/500kHz | Pass | - |
| 3.4 | 15.407(b) | Unwanted Emissions | 15.407(b)(4)(i) & 15.209(a) | Pass | Under limit 14.25 dB at 5952.400 MHz |
| 3.5 | 15.207 | AC Conducted Emission | 15.207(a) | Pass | Under limit 8.81 dB at 0.195 MHz |
| 3.6 | 15.407(c) | Automatically Discontinue Transmission | Discontinue Transmission | Pass | - |
| 3.7 | 15.203 & 15.407(a) | Antenna Requirement | N/A | Pass | - |



1 General Description

1.1 Applicant

Motorola Mobility LLC
222 W,Merchandise Mart Plaza, Chicago IL 60654 USA

1.2 Manufacturer

Motorola Mobility LLC
222 W,Merchandise Mart Plaza, Chicago IL 60654 USA

1.3 Product Feature of Equipment Under Test

| Product Feature | |
|---------------------------------|--|
| Equipment | Mobile Cellular Phone |
| Brand Name | Motorola |
| Model Name | XT2019-2 |
| FCC ID | IHDT56YG2 |
| EUT supports Radios application | GSM/GPRS/EGPRS/WCDMA/HSPA/DC-HSDPA/ HSPA+(16QAM uplink is not supported)/LTE WLAN 2.4GHz 802.11b/g/n HT20 WLAN 5GHz 802.11a/n HT20/HT40 WLAN 5GHz 802.11ac VHT20/VHT40/VHT80 Bluetooth BR / EDR/ LE FM Receiver and GNSS |
| IMEI Code | Conducted: 357207100021757/357207100021765 Conduction: 357207100020114/357207100020122 Radiation: 357207100035252/357207100035260 |
| HW Version | DVT2 |
| SW Version | PPI29.35 |
| EUT Stage | Identical Prototype |

Remark:

1. The above EUT's information was declared by manufacturer. Please refer to the specifications or user's manual for more detailed description.
2. There are two types of EUT, sample 1 is dual SIM card, sample 2 is single SIM card, all the others are the same. We choice the sample 1 to full test.



1.4 Product Specification of Equipment Under Test

| Standards-related Product Specification | |
|---|--|
| Tx/Rx Channel Frequency Range | 5745 MHz ~ 5825 MHz |
| Maximum Output Power | <5745 MHz ~ 5825 MHz> 802.11a : 14.80 dBm / 0.0302 W 802.11n HT20: 14.61 dBm / 0.0289 W 802.11n HT40: 12.88 dBm / 0.0194 W 802.11ac VHT20: 13.79 dBm / 0.0239 W 802.11ac VHT40: 13.87 dBm / 0.0244 W 802.11ac VHT80: 10.19 dBm / 0.0104 W |
| 99% Occupied Bandwidth | 802.11a : 17.53 MHz 802.11n HT20: 18.68 MHz 802.11ac VHT40 : 36.46 MHz 802.11ac VHT80 : 75.52 MHz |
| Type of Modulation | 802.11a/n : OFDM (BPSK / QPSK / 16QAM / 64QAM) 802.11ac : OFDM (BPSK / QPSK / 16QAM / 64QAM / 256QAM) |
| Antenna Type / Gain | PIFA Antenna with gain -1.70 dBi |

Note: For 802.11an HT20 / ac VHT20 and 802.11an HT40 / ac VHT40 mode, the whole testing have assessed only 802.11n HT20/802.11ac VHT40 by referring to their maximum conducted power.

1.5 Modification of EUT

No modifications are made to the EUT during all test items.

1.6 Testing Location

Sporton International (Kunshan) Inc. is accredited to ISO/IEC 17025:2017 by American Association for Laboratory Accreditation with Certificate Number 5145.02.

| | | | |
|---------------------------|--|----------------------------|---------------------------------------|
| Test Firm | Sporton International (Kunshan) Inc. | | |
| Test Site Location | No. 1098, Pengxi North Road, Kunshan Economic Development Zone Jiangsu Province 215300 People's Republic of China TEL : +86-512-57900158 FAX : +86-512-57900958 | | |
| Test Site No. | Sporton Site No. | FCC Designation No. | FCC Test Firm Registration No. |
| | CO01-KS 03CH05-KS TH01-KS | CN1257 | 314309 |



1.7 Applicable Standards

According to the specifications of the manufacturer, the EUT must comply with the requirements of the following standards:

- ♦ 47 CFR Part 15 Subpart E
- ♦ FCC KDB 789033 D02 General UNII Test Procedures New Rules v02r01.
- ♦ ANSI C63.10-2013

Remark:

1. All test items were verified and recorded according to the standards and without any deviation during the test.
2. This EUT has also been tested and complied with the requirements of FCC Part 15, Subpart B, recorded in a separate test report.

1.8 Specification of Accessory

| Specification of Accessory | | | |
|----------------------------|--------------|---|------------------|
| AC Adapter 1(US) | Brand Name | Motorola (Salom) | Model Name SC-51 |
| | Power Rating | I/P: 100-240 Vac, 0.6A, 50/60Hz; O/P: 5/9/12Vdc, 3000/2000/1500mA | |
| AC Adapter 1(EU) | Brand Name | Motorola (Salom) | Model Name SC-52 |
| | Power Rating | I/P: 100-240 Vac, 0.6A, 50/60Hz; O/P: 5/9/12Vdc, 3000/2000/1500mA | |
| AC Adapter 1(BR) | Brand Name | Motorola (Salom) | Model Name SC-57 |
| | Power Rating | I/P: 100-240 Vac, 0.6A, 50/60Hz; O/P: 5/9/12Vdc, 3000/2000/1500mA | |
| AC Adapter 1(Chile) | Brand Name | Motorola (Salom) | Model Name SC-52 |
| | Power Rating | I/P: 100-240 Vac, 0.6A, 50/60Hz; O/P: 5/9/12Vdc, 3000/2000/1500mA | |
| AC Adapter 1(AR) | Brand Name | Motorola (Salom) | Model Name SC-56 |
| | Power Rating | I/P: 100-240 Vac, 0.6A, 50/60Hz; O/P: 5/9/12Vdc, 3000/2000/1500mA | |
| AC Adapter 1 (UK) | Brand Name | Motorola (Salom) | Model Name SC-53 |
| | Power Rating | I/P: 100-240 Vac, 0.6A, 50/60Hz; O/P: 5/9/12Vdc, 3000/2000/1500mA | |
| AC Adapter 1 (AU) | Brand Name | Motorola (Salom) | Model Name SC-55 |
| | Power Rating | I/P: 100-240 Vac, 0.6A, 50/60Hz; O/P: 5/9/12Vdc, 3000/2000/1500mA | |
| AC Adapter 2(US) | Brand Name | Motorola(Chenyang) | Model Name SC-51 |
| | Power Rating | I/P: 100-240 Vac, 0.6A, 50/60Hz; O/P: 5/9/12Vdc, 3000/2000/1500mA | |
| AC Adapter 2(EU) | Brand Name | Motorola(Chenyang) | Model Name SC-52 |
| | Power Rating | I/P: 100-240 Vac, 0.6A, 50/60Hz; O/P: 5/9/12Vdc, 3000/2000/1500mA | |
| AC Adapter 2(AR) | Brand Name | Motorola(Chenyang) | Model Name SC-56 |
| | Power Rating | I/P: 100-240 Vac, 0.6A, 50/60Hz; O/P: 5/9/12Vdc, 3000/2000/1500mA | |
| AC Adapter 2(UK) | Brand Name | Motorola(Chenyang) | Model Name SC-53 |
| | Power Rating | I/P: 100-240 Vac, 0.6A, 50/60Hz; O/P: 5/9/12Vdc, 3000/2000/1500mA | |



| | | | | |
|------------------|------------------|---|------------|------------------------------------|
| AC Adapter 2(AU) | Brand Name | Motorola(Chenyang) | Model Name | SC-55 |
| | Power Rating | I/P: 100-240 Vac, 0.6A, 50/60Hz; O/P: 5/9/12Vdc, 3000/2000/1500mA | | |
| AC Adapter 3(BR) | Brand Name | Motorola(Cliptech/Tenpao) | Model Name | SC-57 |
| | Power Rating | I/P: 100-240 Vac, 0.6A, 50/60Hz; O/P: 5/9/12Vdc, 3000/2000/1500mA | | |
| AC Adapter 4(BR) | Brand Name | Motorola(Flex/Salom) | Model Name | SC-57 |
| | Power Rating | I/P: 100-240 Vac, 0.6A, 50/60Hz; O/P: 5/9/12Vdc, 3000/2000/1500mA | | |
| Battery | Brand Name | Motorola (Sunwoda) | Model Name | KD40 |
| | Power Rating | 3.8Vdc,4000mAh | Type | Li-ion |
| Earphone 1 | Brand Name | Motorola (Lianyun) | Model Name | SH38C37773 |
| | Signal Line Type | 1.1 meter, non-shielded cable, with w/o ferrite core | | |
| Earphone 2 | Brand Name | Motorola (Cosonic) | Model Name | SH38C44959 |
| | Signal Line Type | 1.1 meter, non-shielded cable, with w/o ferrite core | | |
| Earphone 3 | Brand Name | Motorola (NEW LEADER) | Model Name | NLD-EM303H-10SF |
| | Signal Line Type | 1.2 meter, non-shielded cable, with w/o ferrite core | | |
| USB Cable 1 | Brand Name | Motorola (LiQi) | Model Name | L32B-053000100/ L32B-053000100L |
| | Signal Line Type | 1.0 meter, shielded cable, without ferrite core | | |
| USB Cable 2 | Brand Name | Motorola (SaiBao) | Model Name | S32B-053000100/ S32B-053000100L |
| | Signal Line Type | 1.0 meter, shielded cable, without ferrite core | | |
| USB Cable 3 | Brand Name | Motorola (I SHENG) | Model Name | SC18C28955 |
| | Signal Line Type | 1.0 meter, shielded cable, without ferrite core | | |



2 Test Configuration of Equipment Under Test

- a. The EUT has been associated with peripherals and configuration operated in a manner tended to maximize its emission characteristics in a typical application. Frequency range investigated: conduction emission (150 kHz to 30 MHz), radiation emission (9 kHz to the 10th harmonic of the highest fundamental frequency or to 40 GHz, whichever is lower). For radiated measurement, pre-scanned in three orthogonal panels, X, Y, Z. The worst cases (Z plane) were recorded in this report.
- b. AC power line Conducted Emission was tested under maximum output power.

2.1 Carrier Frequency and Channel

| Frequency Band | Channel | Freq. (MHz) | Channel | Freq. (MHz) |
|--------------------------------------|---------|-------------|---------|-------------|
| 5745-5825 MHz Band 4 (U-NII-3) | 149 | 5745 | 157 | 5785 |
| | 151* | 5755 | 159* | 5795 |
| | 153 | 5765 | 161 | 5805 |
| | 155# | 5775 | 165 | 5825 |

Note:

1. The above Frequency and Channel in "*" were 802.11n HT40 and 802.11ac VHT40.
2. The above Frequency and Channel in "#n" were 802.11ac VHT80.



2.2 Test Mode

Final test modes are considering the modulation and worse data rates as below table.

| Modulation | Data Rate |
|----------------|-----------|
| 802.11a | 6 Mbps |
| 802.11n HT20 | MCS0 |
| 802.11ac VHT40 | MCS0 |
| 802.11ac VHT80 | MCS0 |

| | |
|--------------------------------------|--|
| AC Conducted Emission | Mode 1 : GSM 850 Idle + Bluetooth Link + WLAN Link(5G) + Earphone 2 + USB Cable 1(Charging from Adapter 2) |
|--------------------------------------|--|

| Ch. # | | Band IV : 5745-5825 MHz | | | |
|-------|--------|-------------------------|--------------|----------------|----------------|
| | | 802.11a | 802.11n HT20 | 802.11ac VHT40 | 802.11ac VHT80 |
| L | Low | 149 | 149 | 151 | - |
| M | Middle | 157 | 157 | - | 155 |
| H | High | 165 | 165 | 159 | - |

2.3 Connection Diagram of Test System

For Radiation

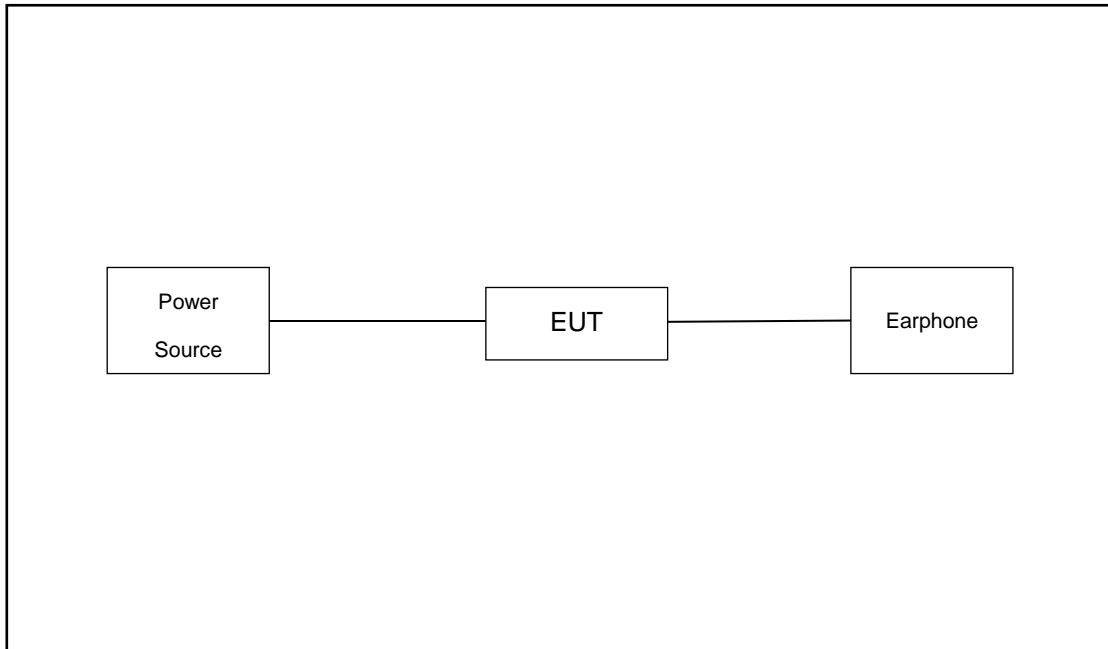

For Conducted Emission

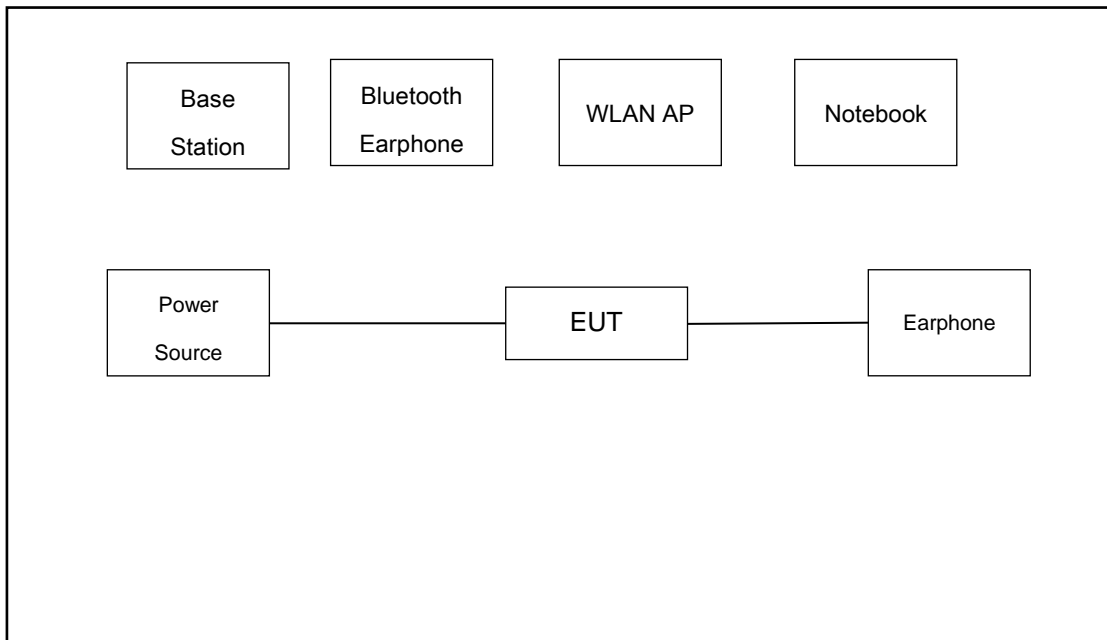

2.4 Support Unit used in test configuration and system

| Item | Equipment | Trade Name | Model Name | FCC ID | Data Cable | Power Cord |
|------|--------------------|------------|------------|-------------|------------|---|
| 1. | Base Station | Anritsu | MT8820C | N/A | N/A | Unshielded,1.8m |
| 2. | Bluetooth Earphone | Lenovo | LBH308 | N/A | N/A | N/A |
| 3. | Notebook | Lenovo | G480 | N/A | N/A | shielded cable DC O/P 1.8m , Unshielded AC I/P cable 1.8m |
| 4. | WLAN AP | D-link | DIR-855 | KA2DIR855A2 | N/A | Unshielded,1.8m |

2.5 EUT Operation Test Setup

For WLAN RF test items, an engineering test program was provided and enabled to make EUT continuously transmit/receive.

For AC power line conducted emissions, the EUT was set to connect with the WLAN AP under large package sizes transmission.

2.6 Measurement Results Explanation Example

For all conducted test items:

The offset level is set in the spectrum analyzer to compensate the RF cable loss between EUT conducted output port and spectrum analyzer. With the offset compensation, the spectrum analyzer reading level is exactly the EUT RF output level.

Example :

The spectrum analyzer offset is derived from RF cable loss

$$\text{Offset} = \text{RF cable loss}$$

Following shows an offset computation example with cable loss 6.90 dB

$$\begin{aligned} \text{Offset(dB)} &= \text{RF cable loss(dB)} \\ &= 6.90 \text{ (dB)} \end{aligned}$$

3 Test Result

3.1 6dB and 26dB and 99% Occupied Bandwidth Measurement

3.1.1 Description of 6dB and 26dB and 99% Occupied Bandwidth

The minimum 6 dB bandwidth shall be at least 500 kHz.

26dB and 99% Occupied bandwidth are reporting only.

3.1.2 Measuring Instruments

The measuring equipment is listed in the section 4 of this test report.

3.1.3 Test Procedures

1. The testing follows FCC KDB 789033 D02 General UNII Test Procedures New Rules v02r01. Section C) Emission bandwidth for the band 5.725-5.85GHz
2. Set RBW = 100kHz.
3. Set the VBW $\geq 3 \times$ RBW.
4. Detector = Peak.
5. Trace mode = max hold
6. Measure the maximum width of the emission that is 6 dB down from the peak of the emission.
7. Measure and record the results in the test report.

3.1.4 Test Setup

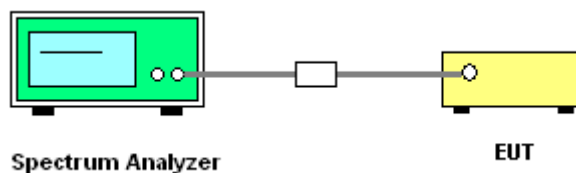

3.1.5 Test Result of 6dB Bandwidth

Please refer to Appendix A.

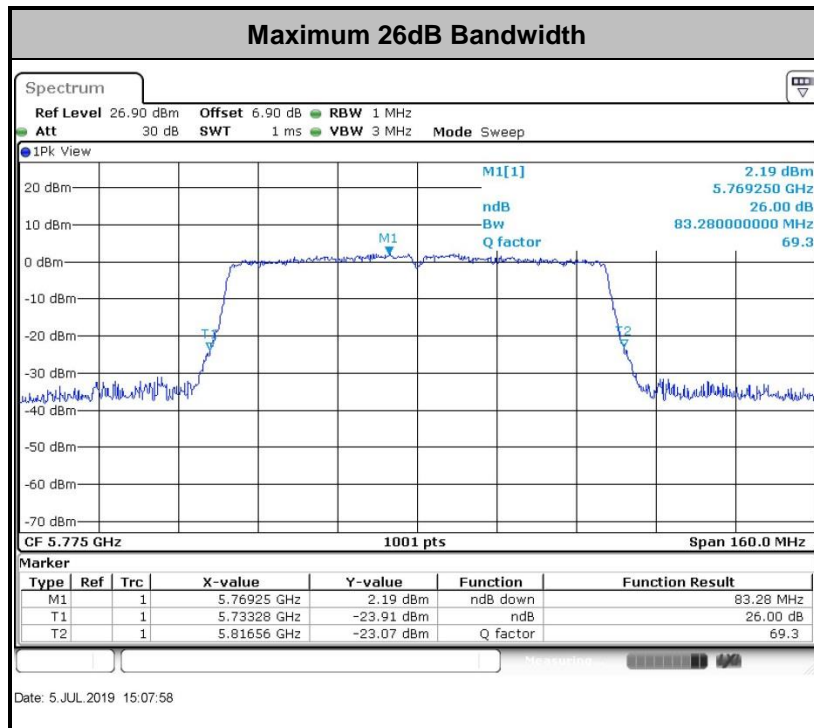
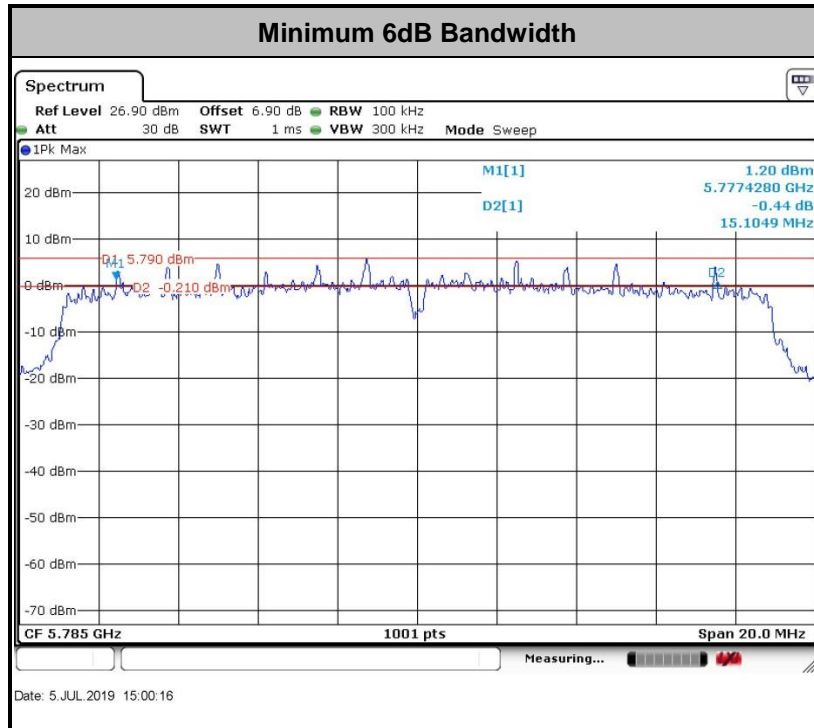

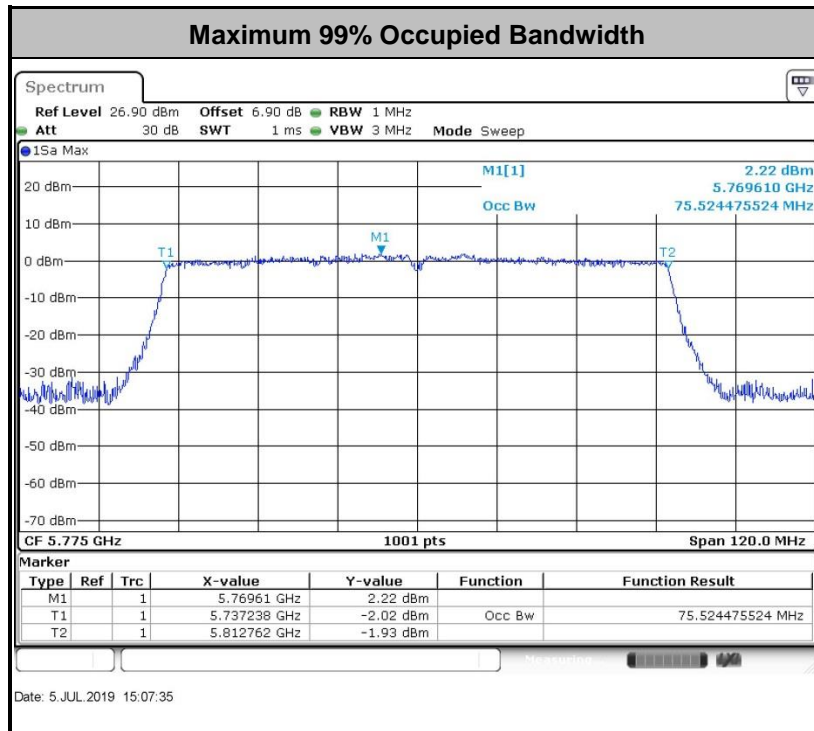

Note: The occupied channel bandwidth is maintained within the band of operation for all of the modulations.

3.2 Maximum Conducted Output Power Measurement

3.2.1 Limit of Maximum Conducted Output Power

For the band 5.725–5.85 GHz, the maximum conducted output power over the frequency band of operation shall not exceed 1 W.

If transmitting antennas of directional gain greater than 6 dBi are used, the peak output power shall be reduced by the amount in dB that the directional gain of the antenna exceeds 6 dBi.

3.2.2 Measuring Instruments

The measuring equipment is listed in the section 4 of this test report.

3.2.3 Test Procedures

The testing follows Method PM of FCC KDB 789033 D02 General UNII Test Procedures New Rules v02r01.

Method PM (Measurement using an RF average power meter):

1. Measurement is performed using a wideband RF power meter.
2. The EUT is configured to transmit continuously with a consistent duty cycle at its maximum power control level.
3. Measure the average power of the transmitter, and the average power is corrected with duty factor, $10 \log(1/x)$, where x is the duty cycle.

3.2.4 Test Setup

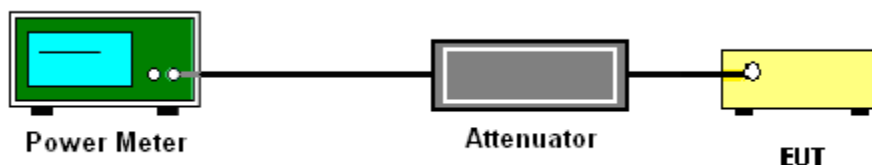

3.2.5 Test Result of Maximum Conducted Output Power

Please refer to Appendix A.



3.3 Power Spectral Density Measurement

3.3.1 Limit of Power Spectral Density

For the band 5.725–5.85 GHz, the maximum power spectral density shall not exceed 30 dBm in any 500-kHz band.

If transmitting antennas of directional gain greater than 6 dBi are used, the peak output power shall be reduced by the amount in dB that the directional gain of the antenna exceeds 6 dBi.

3.3.2 Measuring Instruments

The measuring equipment is listed in the section 4 of this test report.

3.3.3 Test Procedures

The testing follows FCC KDB 789033 D02 General UNII Test Procedures New Rules v02r01. Section F) Maximum power spectral density.

Method SA-2

(trace averaging across on and off times of the EUT transmissions, followed by duty cycle correction).

- Measure the duty cycle.
 - Set span to encompass the entire emission bandwidth (EBW) of the signal.
 - Set RBW = 300kHz.
 - Set VBW \geq 1 MHz.
 - Number of points in sweep \geq 2 Span / RBW.
 - Sweep time = auto.
 - Detector = RMS
 - Trace average at least 100 traces in power averaging mode.
 - Add $10 \log(500\text{kHz}/\text{RBW})$ to the test result, (If $\text{RBW} < 500\text{kHz}$).
 - Add $10 \log(1/x)$, where x is the duty cycle, to the measured power in order to compute the average power during the actual transmission times. For example, add $10 \log(1/0.25) = 6$ dB if the duty cycle is 25 percent.
1. The RF output of EUT was connected to the spectrum analyzer by a low loss cable.
 2. Each plot has already offset with cable loss, and attenuator loss. Measure the PPSD and record it.

3.3.4 Test Setup

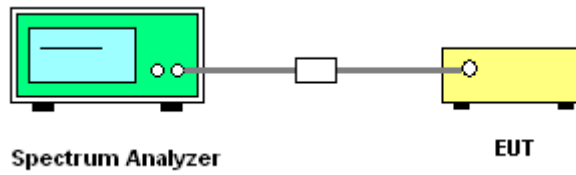

3.3.5 Test Result of Power Spectral Density

Please refer to Appendix A.

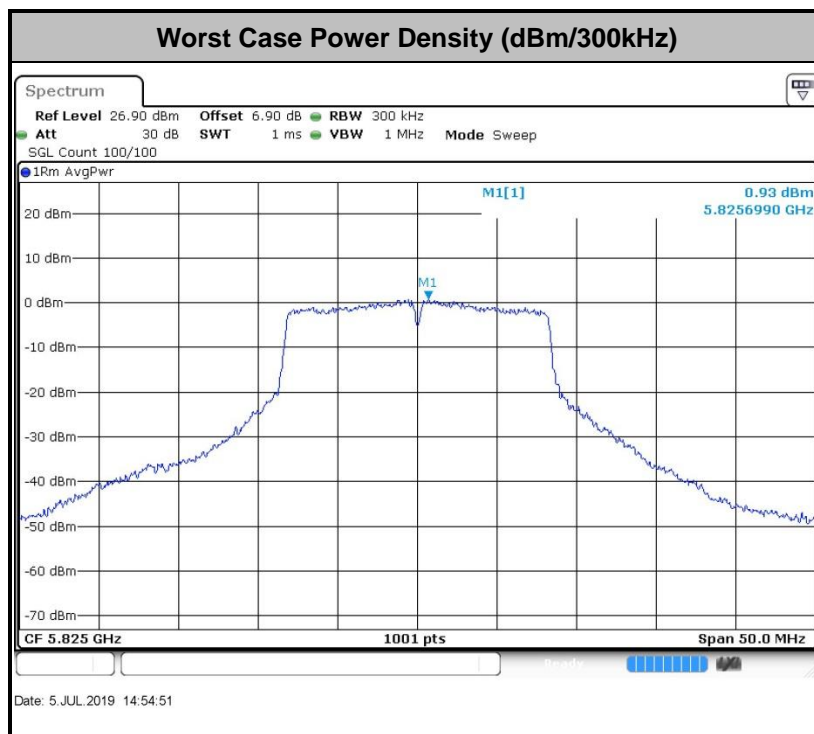



3.4 Unwanted Emissions Measurement

This section is to measure unwanted emissions through radiated measurement for band edge spurious emissions and out of band emissions measurement.

3.4.1 Limit of Unwanted Emissions

- (1) For transmitters operating in the 5.725-5.85 GHz band:
 15.407(b)(4)(i) All emissions shall be limited to a level of -27 dBm/MHz at 75 MHz or more above or below the band edge increasing linearly to 10 dBm/MHz at 25 MHz above or below the band edge, and from 25 MHz above or below the band edge increasing linearly to a level of 15.6 dBm/MHz at 5 MHz above or below the band edge, and from 5 MHz above or below the band edge increasing linearly to a level of 27 dBm/MHz at the band edge.

- (2) Unwanted spurious emissions fallen in restricted bands shall comply with the general field strength limits as below table,

| Frequency (MHz) | Field Strength (microvolts/meter) | Measurement Distance (meters) |
|-----------------|-----------------------------------|-------------------------------|
| 0.009 – 0.490 | 2400/F(kHz) | 300 |
| 0.490 – 1.705 | 24000/F(kHz) | 30 |
| 1.705 – 30.0 | 30 | 30 |
| 30 – 88 | 100 | 3 |
| 88 – 216 | 150 | 3 |
| 216 - 960 | 200 | 3 |
| Above 960 | 500 | 3 |



| EIRP (dBm) | Field Strength at 3m (dBμV/m) |
|------------|-------------------------------|
| - 27 | 68.3 |

Note: The following formula is used to convert the EIRP to field strength.

$$EIRP = E_{Meas} + 20\log (d_{Meas}) - 104.7$$

where

EIRP is the equivalent isotropically radiated power, in dBm

E_{Meas} is the field strength of the emission at the measurement distance, in dBμV/m

d_{Meas} is the measurement distance, in m

3.4.2 Measuring Instruments

The measuring equipment is listed in the section 4 of this test report.



3.4.3 Test Procedures

1. The testing follows FCC KDB 789033 D02 General UNII Test Procedures New Rules v02r01. Section G) Unwanted emissions measurement.
 - (1) Procedure for Unwanted Emissions Measurements Below 1000MHz
 - RBW = 120 kHz
 - VBW = 300 kHz
 - Detector = Peak
 - Trace mode = max hold
 - (2) Procedure for Peak Unwanted Emissions Measurements Above 1000 MHz
 - RBW = 1 MHz
 - VBW \geq 3 MHz
 - Detector = Peak
 - Sweep time = auto
 - Trace mode = max hold
 - (3) Procedures for Average Unwanted Emissions Measurements Above 1000MHz
 - RBW = 1 MHz
 - VBW = 10 Hz, when duty cycle is no less than 98 percent.
 - VBW \geq 1/T, when duty cycle is less than 98 percent where T is the minimum transmission duration over which the transmitter is on and is transmitting at its maximum power control level for the tested mode of operation.
2. The EUT was placed on a turntable with 0.8 meter for frequency below 1GHz and 1.5 meter for frequency above 1GHz respectively above ground.
3. The EUT was set 3 meters from the interference receiving antenna which was mounted on the top of a variable height antenna tower.
4. The antenna is a broadband antenna and its height is adjusted between one meter and four meters above ground to find the maximum value of the field strength for both horizontal polarization and vertical polarization of the antenna.
5. For each suspected emission, the EUT was arranged to its worst case and then adjust the antenna tower (from 1 m to 4 m) and turntable (from 0 degree to 360 degrees) to find the maximum reading.
6. For testing below 1GHz, if the emission level of the EUT in peak mode was 3 dB lower than the limit specified, then peak values of EUT will be reported, otherwise, the emissions will be repeated one by one using the CISPR quasi-peak method and reported.
7. For testing above 1GHz, the emission level of the EUT in peak mode was 20dB lower than average limit (that means the emission level in average mode also complies with the limit in average mode), then peak values of EUT will be reported, otherwise, the emissions will be measured in average mode again and reported.

3.4.4 Test Setup

For radiated emissions below 30MHz

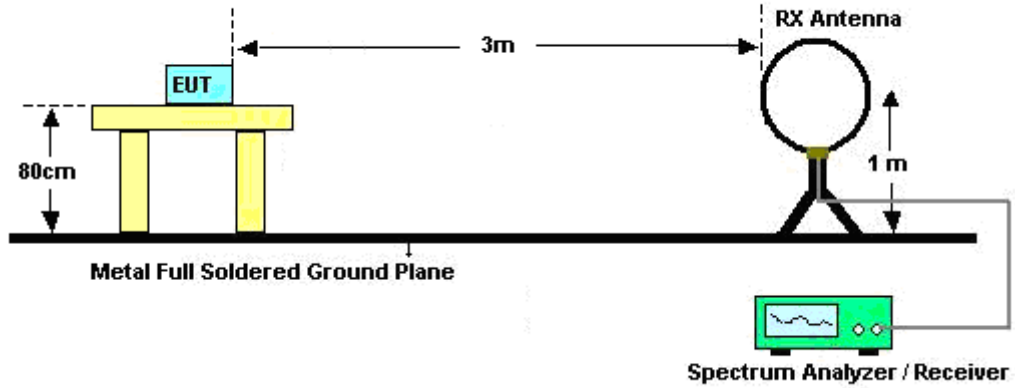

For radiated emissions from 30MHz to 1GHz

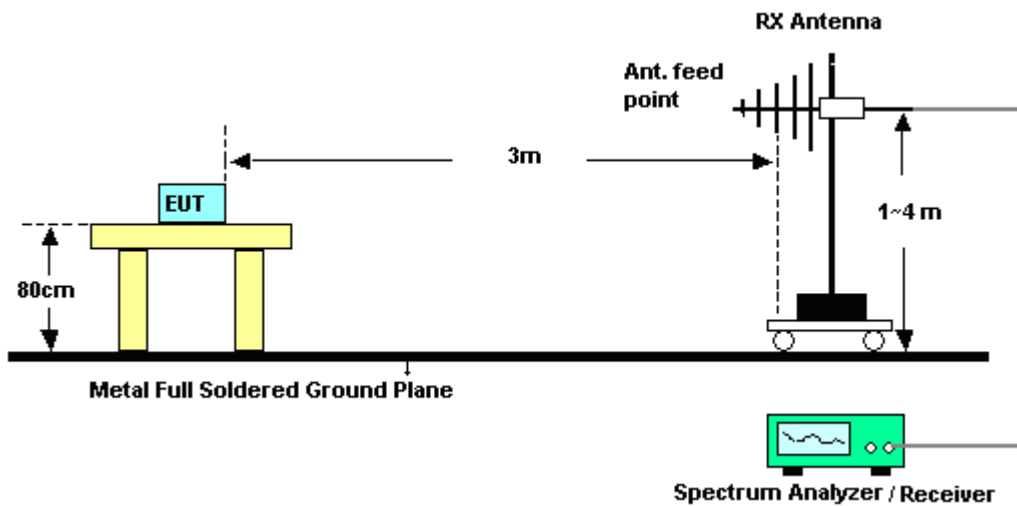

For radiated emissions above 1GHz

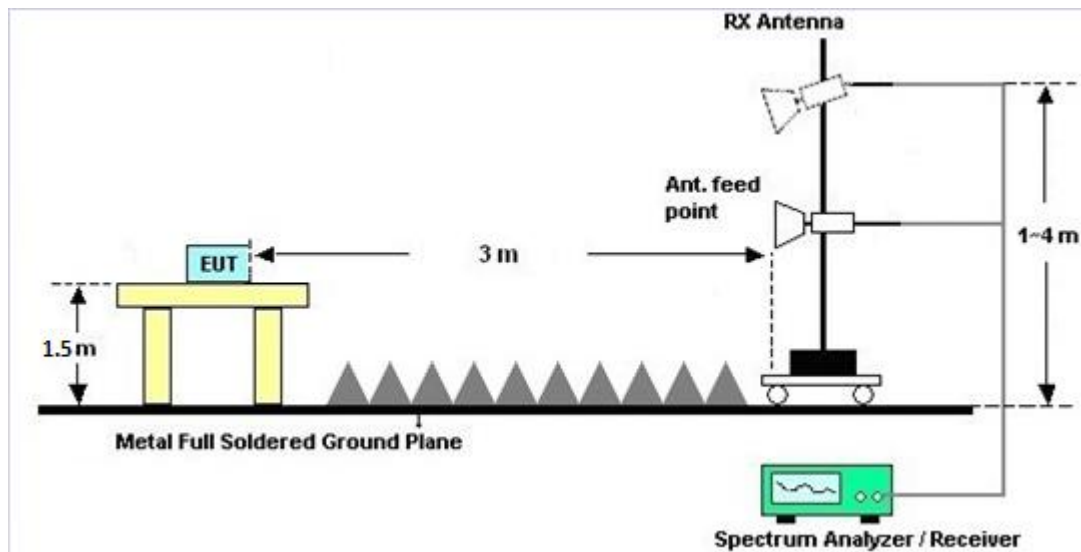

3.4.5 Test Results of Radiated Emissions (9 kHz ~ 30 MHz)

The low frequency, which started from 9 kHz to 30MHz, was pre-scanned and the result which was 20dB lower than the limit line was not reported.

There is a comparison data of both open-field test site and semi-Anechoic chamber, and the result came out very similar.

3.4.6 Test Result of Radiated Band Edges

Please refer to Appendix C.

3.4.7 Duty Cycle

Please refer to Appendix D.

3.4.8 Test Result of Unwanted Radiated Emission (30MHz ~ 10th Harmonic)

Please refer to Appendix C.



3.5 AC Conducted Emission Measurement

3.5.1 Limit of AC Conducted Emission

For equipment that is designed to be connected to the public utility (AC) power line, the radio frequency voltage that is conducted back onto the AC power line on any frequency or frequencies within the band 150 kHz to 30 MHz shall not exceed the limits in the following table.

| Frequency of emission (MHz) | Conducted limit (dBµV) | |
|-----------------------------|------------------------|-----------|
| | Quasi-peak | Average |
| 0.15-0.5 | 66 to 56* | 56 to 46* |
| 0.5-5 | 56 | 46 |
| 5-30 | 60 | 50 |

*Decreases with the logarithm of the frequency.

3.5.2 Measuring Instruments

The measuring equipment is listed in the section 4 of this test report.

3.5.3 Test Procedures

1. The EUT was placed 0.4 meter from the conducting wall of the shielding room was kept at least 80 centimeters from any other grounded conducting surface.
2. Connect EUT to the power mains through a line impedance stabilization network (LISN).
3. All the support units are connecting to the other LISN.
4. The LISN provides 50 ohm coupling impedance for the measuring instrument.
5. The FCC states that a 50 ohm, 50 microhenry LISN should be used.
6. Both sides of AC line were checked for maximum conducted interference.
7. The frequency range from 150 kHz to 30 MHz was searched.
8. Set the test-receiver system to Peak Detect Function and specified bandwidth with Maximum Hold Mode.

3.5.4 Test Setup

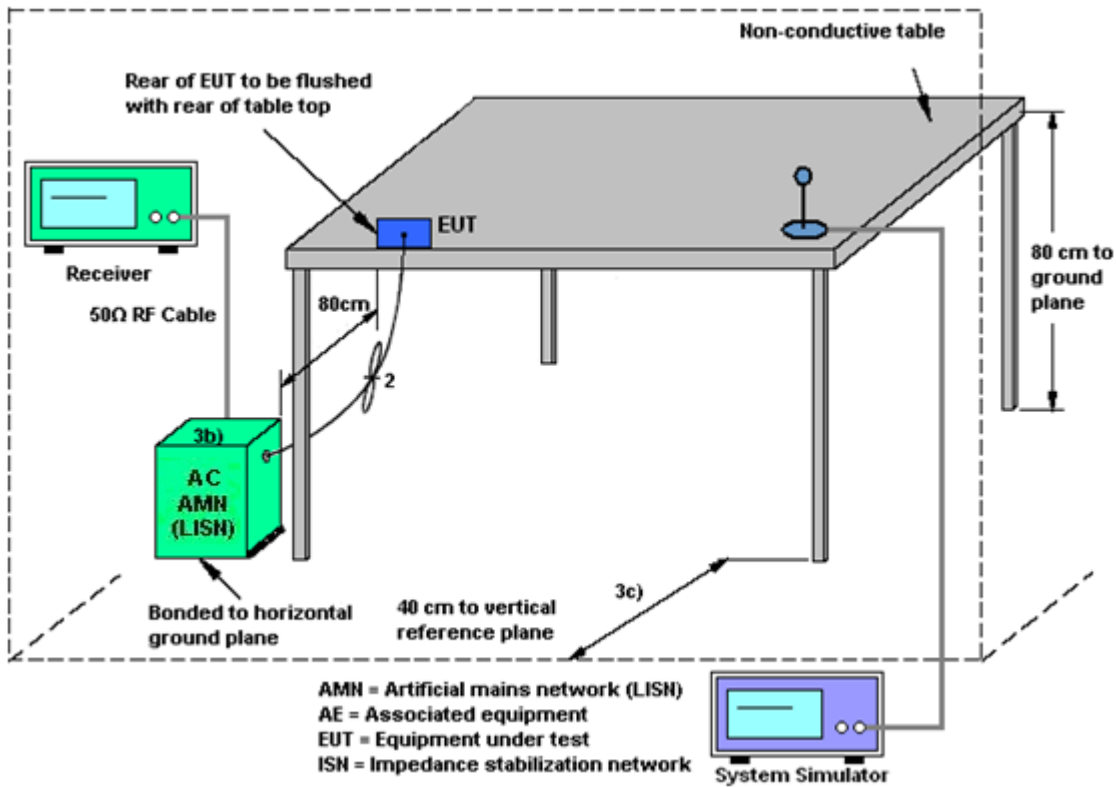

3.5.5 Test Result of AC Conducted Emission

Please refer to Appendix B.



3.6 Automatically Discontinue Transmission

3.6.1 Limit of Automatically Discontinue Transmission

The device shall automatically discontinue transmission in case of either absence of information to transmit or operational failure. These provisions are not intended to preclude the transmission of control or signaling information or the use of repetitive codes used by certain digital technologies to complete frame or burst intervals. Applicants shall include in their application for equipment authorization to describe how this requirement is met.

3.6.2 Measuring Instruments

The measuring equipment is listed in the section 4 of this test report.

3.6.3 Test Result of Automatically Discontinue Transmission

While the EUT is not transmitting any information, the EUT can automatically discontinue transmission and become standby mode for power saving. The EUT can detect the controlling signal of ACK message transmitting from remote device and verify whether it shall resend or discontinue transmission.



3.7 Antenna Requirements

3.7.1 Standard Applicable

If transmitting antenna directional gain is greater than 6 dBi, both the peak transmit power and the peak power spectral density shall be reduced by the amount in dB that the directional gain of the antenna exceeds 6 dBi.

3.7.2 Antenna Anti-Replacement Construction

An embedded-in antenna design is used.

3.7.3 Antenna Gain

The antenna peak gain of EUT is less than 6 dBi. Therefore, it is not necessary to reduce maximum peak output power limit.



4 List of Measuring Equipment

| Instrument | Manufacturer | Model No. | Serial No. | Characteristics | Calibration Date | Test Date | Due Date | Remark |
|-----------------------------------|--------------|-------------------------|--------------|-------------------------|------------------|---------------|---------------|-----------------------|
| Spectrum Analyzer | R&S | FSV40 | 101040 | 10Hz~40GHz | Aug. 07, 2018 | Jul. 05, 2019 | Aug. 06, 2019 | Conducted (TH01-KS) |
| Pulse Power Sensor | Anritsu | MA2411B | 0917070 | 300MHz~40GHz | Jan. 14, 2019 | Jul. 05, 2019 | Jan. 13, 2020 | Conducted (TH01-KS) |
| Power Meter | Anritsu | ML2495A | 1005002 | 50MHz Bandwidth | Jan. 14, 2019 | Jul. 05, 2019 | Jan. 13, 2020 | Conducted (TH01-KS) |
| EMI Test Receiver | Keysight | N9038A | MY56400004 | 3Hz~8.5GHz;Max 30dBm | Oct. 12, 2018 | Aug. 02, 2019 | Oct. 11, 2019 | Radiation (03CH05-KS) |
| EXA Spectrum Analyzer | Keysight | N9010A | MY55370528 | 10Hz~44GHz | Oct. 09, 2018 | Aug. 02, 2019 | Oct. 08, 2019 | Radiation (03CH05-KS) |
| Loop Antenna | R&S | HFH2-Z2 | 100321 | 9kHz~30MHz | Oct. 19, 2018 | Aug. 02, 2019 | Oct. 18, 2019 | Radiation (03CH05-KS) |
| Bilog Antenna | TeseQ | CBL6111D | 44483 | 30MHz~1GHz | Dec. 28, 2018 | Aug. 02, 2019 | Dec. 27, 2019 | Radiation (03CH05-KS) |
| Double Ridge Horn Antenna | ETS-Lindgren | 3117 | 75959 | 1GHz~18GHz | Jan. 27, 2019 | Aug. 02, 2019 | Jan. 26, 2020 | Radiation (03CH05-KS) |
| SHF-EHF Horn | Com-power | AH-840 | 101070 | 18GHz~40GHz | Jan. 05, 2019 | Aug. 02, 2019 | Jan. 04, 2020 | Radiation (03CH05-KS) |
| Amplifier | SONOMA | 310N | 187289 | 9KHz~1GHz | Aug. 06, 2018 | Aug. 02, 2019 | Aug. 05, 2019 | Radiation (03CH05-KS) |
| Amplifier | MITEQ | TTA1840-35-HG | 2014749 | 18~40GHz | Jan. 14, 2019 | Aug. 02, 2019 | Jan. 13, 2020 | Radiation (03CH05-KS) |
| high gain Amplifier | MITEQ | AMF-7D-0010 1800-30-10P | 2025788 | 1Ghz~18Ghz | Aug. 17, 2018 | Aug. 02, 2019 | Aug. 16, 2019 | Radiation (03CH05-KS) |
| Amplifier | Keysight | 83017A | MY53270316 | 500MHz~26.5GHz | Dec. 22, 2018 | Aug. 02, 2019 | Dec. 21, 2019 | Radiation (03CH05-KS) |
| AC Power Source | Chroma | 61601 | F104090004 | N/A | NCR | Aug. 02, 2019 | NCR | Radiation (03CH05-KS) |
| Turn Table | ChamPro | EM 1000-T | 060762-T | 0~360 degree | NCR | Aug. 02, 2019 | NCR | Radiation (03CH05-KS) |
| Antenna Mast | ChamPro | EM 1000-A | 060762-A | 1 m~4 m | NCR | Aug. 02, 2019 | NCR | Radiation (03CH05-KS) |
| EMI Receiver | R&S | ESCI7 | 100768 | 9kHz~7GHz; | Apr. 16, 2019 | Jul. 09, 2019 | Apr. 15, 2020 | Conduction (CO01-KS) |
| AC LISN | MessTec | AN3016 | 060103 | 9kHz~30MHz | Oct. 12, 2018 | Jul. 09, 2019 | Oct. 11, 2019 | Conduction (CO01-KS) |
| AC LISN (for auxiliary equipment) | MessTec | AN3016 | 060105 | 9kHz~30MHz | Nov. 19, 2018 | Jul. 09, 2019 | Nov. 18, 2019 | Conduction (CO01-KS) |
| AC Power Source | Chroma | 61602 | ABP000000811 | AC 0V~300V, 45Hz~1000Hz | Oct. 12, 2018 | Jul. 09, 2019 | Oct. 11, 2019 | Conduction (CO01-KS) |

NCR: No Calibration Required



5 Uncertainty of Evaluation

The measurement uncertainties shown below were calculated in accordance with the requirements of ANSI 63.10-2013. All the measurement uncertainty value were shown with a coverage K=2 to indicate 95% level of confidence. The measurement data show herein meets or exceeds the CISPR measurement uncertainty values specified in CISPR 16-4-2 and can be compared directly to specified limit to determine compliance.

Uncertainty of Conducted Emission Measurement (150kHz ~ 30MHz)

| | |
|---|-------|
| Measuring Uncertainty for a Level of Confidence of 95% (U = 2Uc(y)) | 2.9dB |
|---|-------|

Uncertainty of Radiated Emission Measurement (30 MHz ~ 1000 MHz)

| | |
|---|--------|
| Measuring Uncertainty for a Level of Confidence of 95% (U = 2Uc(y)) | 5.0 dB |
|---|--------|

Uncertainty of Radiated Emission Measurement (1000 MHz ~ 18000 MHz)

| | |
|---|--------|
| Measuring Uncertainty for a Level of Confidence of 95% (U = 2Uc(y)) | 5.0 dB |
|---|--------|

Uncertainty of Radiated Emission Measurement (18000 MHz ~ 40000 MHz)

| | |
|---|--------|
| Measuring Uncertainty for a Level of Confidence of 95% (U = 2Uc(y)) | 5.0 dB |
|---|--------|



Appendix A. Conducted Test Results

| | | | | |
|----------------|----------|--------------------|-------|----|
| Test Engineer: | Lex Wu | Temperature: | 21~25 | °C |
| Test Date: | 2019/7/5 | Relative Humidity: | 51~54 | % |

TEST RESULTS DATA
6dB and 26dB EBW and 99% OBW

| Band IV | | | | | | | | | |
|---------|-----------|-----|-----|-------------|---------------------|-----------------------|----------------------|--------------------------------|-----------|
| Mod. | Data Rate | NTX | CH. | Freq. (MHz) | 99% Bandwidth (MHz) | 26 dB Bandwidth (MHz) | 6 dB Bandwidth (MHz) | 6dB Bandwidth min. Limit (MHz) | Pass/Fail |
| 11a | 6M bps | 1 | 149 | 5745 | 17.48 | 23.63 | 15.50 | 0.5 | Pass |
| 11a | 6Mbps | 1 | 157 | 5785 | 17.53 | 23.58 | 15.50 | 0.5 | Pass |
| 11a | 6Mbps | 1 | 165 | 5825 | 17.43 | 23.38 | 15.50 | 0.5 | Pass |
| HT20 | MCS 0 | 1 | 149 | 5745 | 18.68 | 24.83 | 15.12 | 0.5 | Pass |
| HT20 | MCS 0 | 1 | 157 | 5785 | 18.68 | 24.73 | 15.10 | 0.5 | Pass |
| HT20 | MCS 0 | 1 | 165 | 5825 | 18.58 | 24.48 | 16.54 | 0.5 | Pass |
| VHT40 | MCS 0 | 1 | 151 | 5755 | 36.46 | 41.81 | 35.08 | 0.5 | Pass |
| VHT40 | MCS 0 | 1 | 159 | 5795 | 36.46 | 41.63 | 35.12 | 0.5 | Pass |
| VHT80 | MCS 0 | 1 | 155 | 5775 | 75.52 | 83.28 | 75.12 | 0.5 | Pass |

TEST RESULTS DATA
Average Power Table

| Band IV | | | | | | | | | | |
|---------|-----------|-----|-----|-------------|------------------|-------------------------------|---------------------------------|----------|--|-----------|
| Mod. | Data Rate | NTX | CH. | Freq. (MHz) | Duty Factor (dB) | Average Conducted Power (dBm) | FCC Conducted Power Limit (dBm) | DG (dBi) | | Pass/Fail |
| 11a | 6M bps | 1 | 149 | 5745 | 0.08 | 14.62 | 30.00 | -1.70 | | Pass |
| 11a | 6Mbps | 1 | 157 | 5785 | 0.08 | 14.34 | 30.00 | -1.70 | | Pass |
| 11a | 6Mbps | 1 | 165 | 5825 | 0.08 | 14.80 | 30.00 | -1.70 | | Pass |
| HT20 | MCS 0 | 1 | 149 | 5745 | 0.08 | 14.46 | 30.00 | -1.70 | | Pass |
| HT20 | MCS 0 | 1 | 157 | 5785 | 0.08 | 14.20 | 30.00 | -1.70 | | Pass |
| HT20 | MCS 0 | 1 | 165 | 5825 | 0.08 | 14.61 | 30.00 | -1.70 | | Pass |
| HT40 | MCS 0 | 1 | 151 | 5755 | 0.16 | 12.88 | 30.00 | -1.70 | | Pass |
| HT40 | MCS 0 | 1 | 159 | 5795 | 0.16 | 12.69 | 30.00 | -1.70 | | Pass |
| VHT20 | MCS 0 | 1 | 149 | 5745 | 0.10 | 13.79 | 30.00 | -1.70 | | Pass |
| VHT20 | MCS 0 | 1 | 157 | 5785 | 0.10 | 13.51 | 30.00 | -1.70 | | Pass |
| VHT20 | MCS 0 | 1 | 165 | 5825 | 0.10 | 13.67 | 30.00 | -1.70 | | Pass |
| VHT40 | MCS 0 | 1 | 151 | 5755 | 0.16 | 13.87 | 30.00 | -1.70 | | Pass |
| VHT40 | MCS 0 | 1 | 159 | 5795 | 0.16 | 13.84 | 30.00 | -1.70 | | Pass |
| VHT80 | MCS 0 | 1 | 155 | 5775 | 0.31 | 10.19 | 30.00 | -1.70 | | Pass |

TEST RESULTS DATA
Power Spectral Density

| Band IV | | | | | | | | | | |
|---------|-----------|-----|-----|-------------|------------------|---------------------------------|------------------------------------|--------------------------------|----------|-----------|
| Mod. | Data Rate | NTX | CH. | Freq. (MHz) | Duty Factor (dB) | 10log (500kHz /RBW) Factor (dB) | Average Power Density (dBm/500kHz) | Average PSD Limit (dBm/500kHz) | DG (dBi) | Pass/Fail |
| 11a | 6M bps | 1 | 149 | 5745 | 0.08 | 2.22 | 2.77 | 30.00 | -1.70 | Pass |
| 11a | 6Mbps | 1 | 157 | 5785 | 0.08 | 2.22 | 2.71 | 30.00 | -1.70 | Pass |
| 11a | 6Mbps | 1 | 165 | 5825 | 0.08 | 2.22 | 3.22 | 30.00 | -1.70 | Pass |
| HT20 | MCS 0 | 1 | 149 | 5745 | 0.08 | 2.22 | 1.50 | 30.00 | -1.70 | Pass |
| HT20 | MCS 0 | 1 | 157 | 5785 | 0.08 | 2.22 | 1.76 | 30.00 | -1.70 | Pass |
| HT20 | MCS 0 | 1 | 165 | 5825 | 0.08 | 2.22 | 2.62 | 30.00 | -1.70 | Pass |
| VHT40 | MCS 0 | 1 | 151 | 5755 | 0.16 | 2.22 | -2.63 | 30.00 | -1.70 | Pass |
| VHT40 | MCS 0 | 1 | 159 | 5795 | 0.16 | 2.22 | -2.23 | 30.00 | -1.70 | Pass |
| VHT80 | MCS 0 | 1 | 155 | 5775 | 0.31 | 2.22 | -8.78 | 30.00 | -1.70 | Pass |



Appendix B. AC Conducted Emission Test Results

| | | | |
|-----------------|---------------|---------------------|--------------|
| Test Engineer : | Amos Zhang | Temperature : | 25.3~26.2 °C |
| | | Relative Humidity : | 38~40% |
| Test Voltage : | 120Vac / 60Hz | Phase : | Line |

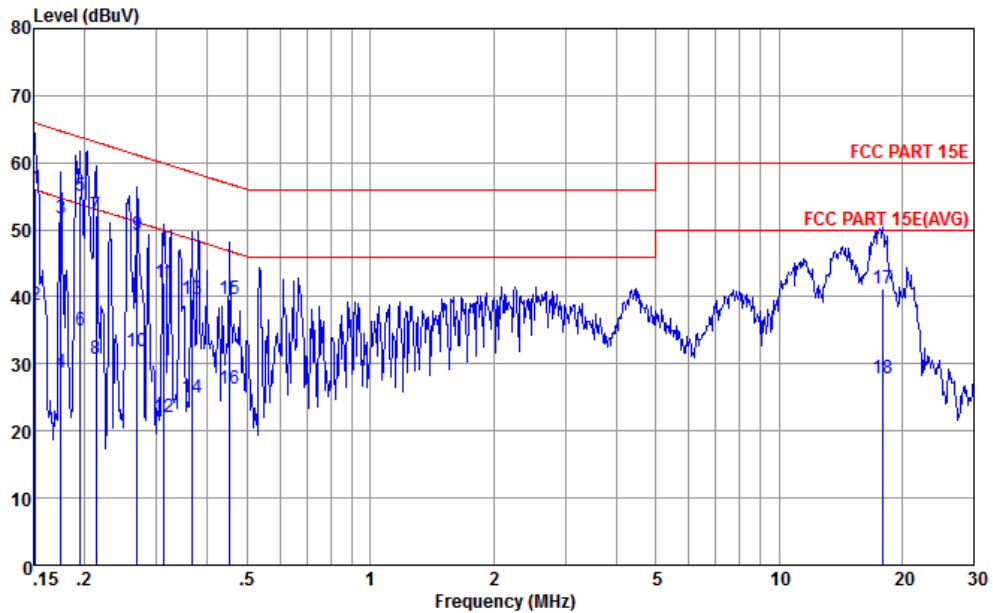

Site : CO01-KS
Condition : FCC PART 15E LISN-L-181119-060105 LINE

| | Freq | Level | Over | Limit | Read | LISN | Cable | Remark |
|-----|--------|-------|--------|-------|-------|--------|-------|---------|
| | MHz | dBuV | Limit | Line | Level | Factor | Loss | |
| | | | dB | dBuV | dBuV | dB | dB | |
| 1 | 0.152 | 56.07 | -9.84 | 65.91 | 45.50 | 0.09 | 10.48 | QP |
| 2 | 0.152 | 38.77 | -17.14 | 55.91 | 28.20 | 0.09 | 10.48 | Average |
| 3 | 0.175 | 51.72 | -13.00 | 64.72 | 41.19 | 0.11 | 10.42 | QP |
| 4 | 0.175 | 28.72 | -26.00 | 54.72 | 18.19 | 0.11 | 10.42 | Average |
| 5 * | 0.195 | 54.99 | -8.81 | 63.80 | 44.50 | 0.12 | 10.37 | QP |
| 6 | 0.195 | 34.99 | -18.81 | 53.80 | 24.50 | 0.12 | 10.37 | Average |
| 7 | 0.213 | 52.08 | -11.02 | 63.10 | 41.60 | 0.12 | 10.36 | QP |
| 8 | 0.213 | 30.78 | -22.32 | 53.10 | 20.30 | 0.12 | 10.36 | Average |
| 9 | 0.269 | 49.36 | -11.80 | 61.16 | 38.90 | 0.14 | 10.32 | QP |
| 10 | 0.269 | 31.76 | -19.40 | 51.16 | 21.30 | 0.14 | 10.32 | Average |
| 11 | 0.313 | 42.05 | -17.83 | 59.88 | 31.61 | 0.14 | 10.30 | QP |
| 12 | 0.313 | 22.05 | -27.83 | 49.88 | 11.61 | 0.14 | 10.30 | Average |
| 13 | 0.365 | 39.73 | -18.88 | 58.61 | 29.30 | 0.15 | 10.28 | QP |
| 14 | 0.365 | 24.93 | -23.68 | 48.61 | 14.50 | 0.15 | 10.28 | Average |
| 15 | 0.454 | 39.71 | -17.09 | 56.80 | 29.30 | 0.16 | 10.25 | QP |
| 16 | 0.454 | 26.31 | -20.49 | 46.80 | 15.90 | 0.16 | 10.25 | Average |
| 17 | 17.944 | 41.27 | -18.73 | 60.00 | 30.60 | 0.21 | 10.46 | QP |
| 18 | 17.944 | 27.77 | -22.23 | 50.00 | 17.10 | 0.21 | 10.46 | Average |



| | | | |
|-----------------|---------------|---------------------|--------------|
| Test Engineer : | Amos Zhang | Temperature : | 25.3~26.2 °C |
| | | Relative Humidity : | 38~40% |
| Test Voltage : | 120Vac / 60Hz | Phase : | Neutral |

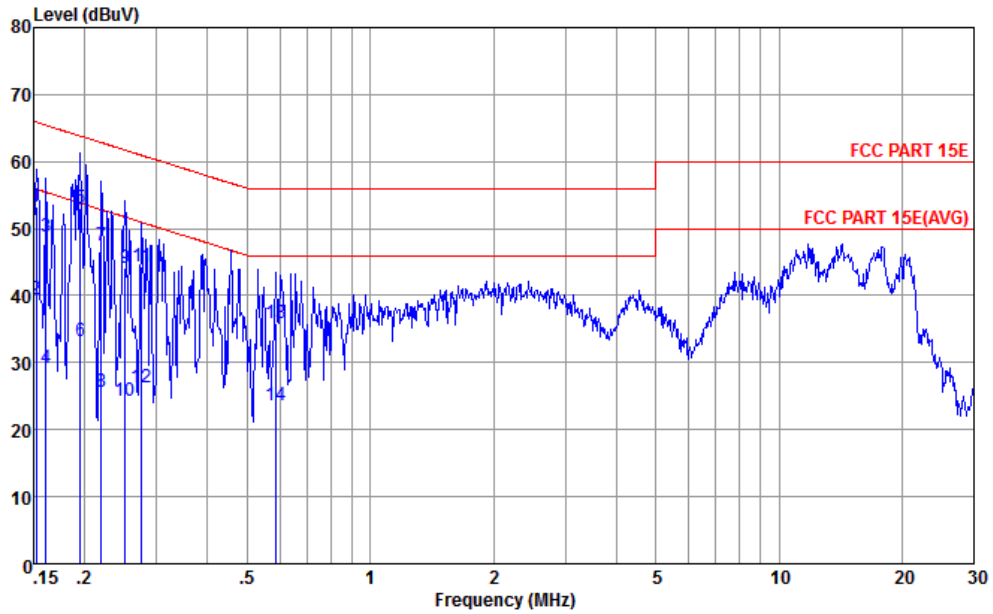

Site : CO01-KS
 Condition : FCC PART 15E LISN-N-181119-060105 NEUTRAL

| | Freq | Level | Over | Limit | Read | LISN | Cable | Remark |
|-----|-------|-------|--------|-------|-------|--------|-------|---------|
| | MHz | dBuV | Limit | Line | Level | Factor | Loss | |
| | | | dB | dBuV | dBuV | dB | dB | |
| 1 | 0.152 | 53.25 | -12.62 | 65.87 | 42.60 | 0.18 | 10.47 | QP |
| 2 | 0.152 | 39.55 | -16.32 | 55.87 | 28.90 | 0.18 | 10.47 | Average |
| 3 | 0.161 | 48.83 | -16.60 | 65.43 | 38.20 | 0.18 | 10.45 | QP |
| 4 | 0.161 | 29.23 | -26.20 | 55.43 | 18.60 | 0.18 | 10.45 | Average |
| 5 * | 0.195 | 53.05 | -10.75 | 63.80 | 42.51 | 0.17 | 10.37 | QP |
| 6 | 0.195 | 33.15 | -20.65 | 53.80 | 22.61 | 0.17 | 10.37 | Average |
| 7 | 0.220 | 47.42 | -15.41 | 62.83 | 36.90 | 0.17 | 10.35 | QP |
| 8 | 0.220 | 25.72 | -27.11 | 52.83 | 15.20 | 0.17 | 10.35 | Average |
| 9 | 0.251 | 44.10 | -17.63 | 61.73 | 33.60 | 0.17 | 10.33 | QP |
| 10 | 0.251 | 24.30 | -27.43 | 51.73 | 13.80 | 0.17 | 10.33 | Average |
| 11 | 0.276 | 44.28 | -16.66 | 60.94 | 33.80 | 0.16 | 10.32 | QP |
| 12 | 0.276 | 26.28 | -24.66 | 50.94 | 15.80 | 0.16 | 10.32 | Average |
| 13 | 0.585 | 35.88 | -20.12 | 56.00 | 25.50 | 0.14 | 10.24 | QP |
| 14 | 0.585 | 23.68 | -22.32 | 46.00 | 13.30 | 0.14 | 10.24 | Average |



Appendix C. Radiated Spurious Emission

Band 4 - 5725~5850MHz
WIFI 802.11a (Band Edge @ 3m)

| WIFI Ant. | Note | Frequency | Level | Over Limit | Limit Line | Read Level | Antenna Factor | Cable Loss | Preamp Factor | Ant Pos | Table Pos | Peak Avg. | Pol. |
|------------------------------|------|-----------|------------|------------|------------|------------|----------------|------------|---------------|---------|-----------|-----------|---------|
| 1 | | (MHz) | (dBμV/m) | (dB) | (dBμV/m) | (dBμV) | (dB/m) | (dB) | (dB) | (cm) | (deg) | (P/A) | (H/V) |
| 802.11a CH 149 5745MHz | | 5621.2 | 53.35 | -14.95 | 68.3 | 40.97 | 35.29 | 8.52 | 31.43 | 100 | 114 | P | H |
| | | 5698.8 | 60.17 | -44.25 | 104.42 | 47.83 | 35.25 | 8.58 | 31.49 | 100 | 114 | P | H |
| | | 5717.2 | 67.87 | -42.25 | 110.12 | 55.54 | 35.24 | 8.61 | 31.52 | 100 | 114 | P | H |
| | | 5724.8 | 75.47 | -46.37 | 121.84 | 63.16 | 35.22 | 8.61 | 31.52 | 100 | 114 | P | H |
| | | 5746 | 107.93 | - | - | 95.63 | 35.21 | 8.64 | 31.55 | 100 | 114 | P | H |
| | | 5746 | 101.02 | - | - | 88.72 | 35.21 | 8.64 | 31.55 | 100 | 114 | A | H |
| | | 5610 | 53.07 | -15.23 | 68.3 | 40.7 | 35.28 | 8.52 | 31.43 | 217 | 162 | P | V |
| | | 5700 | 66.53 | -38.77 | 105.3 | 54.16 | 35.25 | 8.61 | 31.49 | 217 | 162 | P | V |
| | | 5720 | 73.48 | -37.42 | 110.9 | 61.17 | 35.22 | 8.61 | 31.52 | 217 | 162 | P | V |
| | | 5724.8 | 80.34 | -41.5 | 121.84 | 68.03 | 35.22 | 8.61 | 31.52 | 217 | 162 | P | V |
| | | 5746 | 112.62 | - | - | 100.32 | 35.21 | 8.64 | 31.55 | 217 | 162 | P | V |
| | | 5746 | 105.32 | - | - | 93.02 | 35.21 | 8.64 | 31.55 | 217 | 162 | A | V |



| WIFI Ant. 1 | Note | Frequency (MHz) | Level (dBμV/m) | Over Limit (dB) | Limit Line (dBμV/m) | Read Level (dBμV) | Antenna Factor (dB/m) | Cable Loss (dB) | Preamp Factor (dB) | Ant Pos (cm) | Table Pos (deg) | Peak Avg. (P/A) | Pol. (H/V) |
|------------------------------|---|-------------------|------------------|-------------------|-----------------------|---------------------|-------------------------|-------------------|----------------------|----------------|-------------------|-------------------|--------------|
| 802.11a CH 165 5825MHz | | 5824 | 109.07 | - | - | 96.87 | 35.13 | 8.72 | 31.65 | 100 | 114 | P | H |
| | | 5824 | 101.52 | - | - | 89.32 | 35.13 | 8.72 | 31.65 | 100 | 114 | A | H |
| | | 5850.8 | 71.18 | -49.3 | 120.48 | 59.02 | 35.12 | 8.72 | 31.68 | 100 | 114 | P | H |
| | | 5855.2 | 63 | -47.84 | 110.84 | 50.86 | 35.1 | 8.72 | 31.68 | 100 | 114 | P | H |
| | | 5880.4 | 54.61 | -46.68 | 101.29 | 42.44 | 35.1 | 8.77 | 31.7 | 100 | 114 | P | H |
| | | 5964.4 | 53.21 | -15.09 | 68.3 | 41 | 35.09 | 8.88 | 31.76 | 100 | 114 | P | H |
| | | 5824 | 113.17 | - | - | 100.97 | 35.13 | 8.72 | 31.65 | 222 | 163 | P | V |
| | | 5824 | 105.4 | - | - | 93.2 | 35.13 | 8.72 | 31.65 | 222 | 163 | A | V |
| | | 5850.4 | 76.65 | -44.74 | 121.39 | 64.49 | 35.12 | 8.72 | 31.68 | 222 | 163 | P | V |
| | | 5855.2 | 69.51 | -41.33 | 110.84 | 57.37 | 35.1 | 8.72 | 31.68 | 222 | 163 | P | V |
| | | 5875.6 | 57.01 | -47.84 | 104.85 | 44.84 | 35.1 | 8.77 | 31.7 | 222 | 163 | P | V |
| | | 5940.4 | 53.3 | -15 | 68.3 | 41.07 | 35.09 | 8.88 | 31.74 | 222 | 163 | P | V |
| Remark | 1. No other spurious found. 2. All results are PASS against Peak and Average limit line. | | | | | | | | | | | | |



Band 4 5725~5850MHz

WIFI 802.11a (Harmonic @ 3m)

| WIFI Ant. 1 | Note | Frequency (MHz) | Level (dBμV/m) | Over Limit (dB) | Limit Line (dBμV/m) | Read Level (dBμV) | Antenna Factor (dB/m) | Cable Loss (dB) | Preamp Factor (dB) | Ant Pos (cm) | Table Pos (deg) | Peak Avg. (P/A) | Pol. (H/V) |
|----------------|---|-------------------|------------------|-------------------|-----------------------|---------------------|-------------------------|-------------------|----------------------|----------------|-------------------|-------------------|--------------|
| 802.11a CH 149 | | 11490 | 43.33 | -30.67 | 74 | 55.43 | 37.99 | 12.74 | 62.83 | 100 | 360 | P | H |
| 5745MHz | | 11490 | 44.93 | -29.07 | 74 | 57.03 | 37.99 | 12.74 | 62.83 | 100 | 360 | P | V |
| 802.11a CH 157 | | 11570 | 42.31 | -31.69 | 74 | 54.28 | 38.06 | 12.79 | 62.82 | 100 | 0 | P | H |
| 5785MHz | | 11570 | 42.09 | -31.91 | 74 | 54.06 | 38.06 | 12.79 | 62.82 | 100 | 0 | P | V |
| 802.11a CH 165 | | 11650 | 43.24 | -30.76 | 74 | 55.09 | 38.11 | 12.85 | 62.81 | 100 | 360 | P | H |
| 5825MHz | | 11650 | 43.02 | -30.98 | 74 | 54.87 | 38.11 | 12.85 | 62.81 | 100 | 360 | P | V |
| Remark | 1. No other spurious found. 2. All results are PASS against Peak and Average limit line. | | | | | | | | | | | | |



Band 4 5725~5850MHz
WIFI 802.11n HT20 (Band Edge @ 3m)

Table with 14 columns: WIFI Ant. 1, Note, Frequency (MHz), Level (dBµV/m), Over Limit (dB), Limit Line (dBµV/m), Read Level (dBµV), Antenna Factor (dB/m), Cable Loss (dB), Preamp Factor (dB), Ant Pos (cm), Table Pos (deg), Peak Avg. (P/A), Pol. (H/V). Rows include data for frequencies 5613.2, 5692, 5720, 5722.8, 5746, 5746, 5635.6, 5696.8, 5720, 5723.6, 5746, 5746.



| WIFI Ant. 1 | Note | Frequency (MHz) | Level (dBμV/m) | Over Limit (dB) | Limit Line (dBμV/m) | Read Level (dBμV) | Antenna Factor (dB/m) | Cable Loss (dB) | Preamp Factor (dB) | Ant Pos (cm) | Table Pos (deg) | Peak Avg. (P/A) | Pol. (H/V) |
|-----------------------------|---|-------------------|------------------|-------------------|-----------------------|---------------------|-------------------------|-------------------|----------------------|----------------|-------------------|-------------------|--------------|
| 802.11n HT20 CH 165 5825MHz | | 5824 | 108.37 | - | - | 96.17 | 35.13 | 8.72 | 31.65 | 100 | 116 | P | H |
| | | 5824 | 101.36 | - | - | 89.16 | 35.13 | 8.72 | 31.65 | 100 | 116 | A | H |
| | | 5850.4 | 71.78 | -49.61 | 121.39 | 59.62 | 35.12 | 8.72 | 31.68 | 100 | 116 | P | H |
| | | 5856 | 63.42 | -47.2 | 110.62 | 51.23 | 35.1 | 8.77 | 31.68 | 100 | 116 | P | H |
| | | 5883.6 | 54.12 | -44.79 | 98.91 | 41.96 | 35.1 | 8.77 | 31.71 | 100 | 116 | P | H |
| | | 5947.2 | 53.02 | -15.28 | 68.3 | 40.79 | 35.09 | 8.88 | 31.74 | 100 | 116 | P | H |
| | | 5824 | 112.57 | - | - | 100.37 | 35.13 | 8.72 | 31.65 | 224 | 162 | P | V |
| | | 5824 | 105.56 | - | - | 93.36 | 35.13 | 8.72 | 31.65 | 224 | 162 | A | V |
| | | 5850 | 78.1 | -44.2 | 122.3 | 65.94 | 35.12 | 8.72 | 31.68 | 224 | 162 | P | V |
| | | 5855.2 | 66.73 | -44.11 | 110.84 | 54.59 | 35.1 | 8.72 | 31.68 | 224 | 162 | P | V |
| | | 5874.8 | 56.72 | -48.64 | 105.36 | 44.55 | 35.1 | 8.77 | 31.7 | 224 | 162 | P | V |
| | 5942 | 53.29 | -15.01 | 68.3 | 41.06 | 35.09 | 8.88 | 31.74 | 224 | 162 | P | V | |
| Remark | <ol style="list-style-type: none"> No other spurious found. All results are PASS against Peak and Average limit line. | | | | | | | | | | | | |



Band 4 5725~5850MHz
WIFI 802.11n HT20 (Harmonic @ 3m)

| WIFI Ant. 1 | Note | Frequency (MHz) | Level (dBμV/m) | Over Limit (dB) | Limit Line (dBμV/m) | Read Level (dBμV) | Antenna Factor (dB/m) | Cable Loss (dB) | Preamp Factor (dB) | Ant Pos (cm) | Table Pos (deg) | Peak Avg. (P/A) | Pol. (H/V) |
|---------------|---|-------------------|------------------|-------------------|-----------------------|---------------------|-------------------------|-------------------|----------------------|----------------|-------------------|-------------------|--------------|
| 802.11n HT20 | | 11490 | 43.11 | -30.89 | 74 | 55.21 | 37.99 | 12.74 | 62.83 | 100 | 0 | P | H |
| CH 149 | | 11490 | 43.04 | -30.96 | 74 | 55.14 | 37.99 | 12.74 | 62.83 | 100 | 0 | P | V |
| 5745MHz | | | | | | | | | | | | | |
| 802.11n HT20 | | 11570 | 42.06 | -31.94 | 74 | 54.03 | 38.06 | 12.79 | 62.82 | 100 | 0 | P | H |
| CH 157 | | 11570 | 42.07 | -31.93 | 74 | 54.04 | 38.06 | 12.79 | 62.82 | 100 | 0 | P | V |
| 5785MHz | | | | | | | | | | | | | |
| 802.11n HT20 | | 11650 | 43.86 | -30.14 | 74 | 55.71 | 38.11 | 12.85 | 62.81 | 100 | 360 | P | H |
| CH 165 | | 11650 | 43 | -31 | 74 | 54.85 | 38.11 | 12.85 | 62.81 | 100 | 360 | P | V |
| 5825MHz | | | | | | | | | | | | | |
| Remark | 1. No other spurious found. 2. All results are PASS against Peak and Average limit line. | | | | | | | | | | | | |



Band 4 5725~5850MHz
WIFI 802.11ac VHT40 (Band Edge @ 3m)

| WIFI Ant. 1 | Note | Frequency (MHz) | Level (dBμV/m) | Over Limit (dB) | Limit Line (dBμV/m) | Read Level (dBμV) | Antenna Factor (dB/m) | Cable Loss (dB) | Preamp Factor (dB) | Ant Pos (cm) | Table Pos (deg) | Peak Avg. (P/A) | Pol. (H/V) |
|-------------------------------|--------|-------------------|------------------|-------------------|-----------------------|---------------------|-------------------------|-------------------|----------------------|----------------|-------------------|-------------------|--------------|
| 802.11ac VHT40 CH 151 5755MHz | | 5620.8 | 53.49 | -14.81 | 68.3 | 41.11 | 35.29 | 8.52 | 31.43 | 100 | 114 | P | H |
| | | 5700 | 56.87 | -48.43 | 105.3 | 44.5 | 35.25 | 8.61 | 31.49 | 100 | 114 | P | H |
| | | 5718 | 65.36 | -44.98 | 110.34 | 53.05 | 35.22 | 8.61 | 31.52 | 100 | 114 | P | H |
| | | 5722 | 68.22 | -47.24 | 115.46 | 55.91 | 35.22 | 8.61 | 31.52 | 100 | 114 | P | H |
| | | 5752 | 104.05 | - | - | 91.77 | 35.19 | 8.64 | 31.55 | 100 | 114 | P | H |
| | | 5752 | 97.04 | - | - | 84.76 | 35.19 | 8.64 | 31.55 | 100 | 114 | A | H |
| | | 5850 | 51.97 | -70.33 | 122.3 | 39.81 | 35.12 | 8.72 | 31.68 | 100 | 114 | P | H |
| | | 5862 | 53.59 | -55.35 | 108.94 | 41.42 | 35.1 | 8.77 | 31.7 | 100 | 114 | P | H |
| | | 5882.4 | 52.76 | -47.04 | 99.8 | 40.59 | 35.1 | 8.77 | 31.7 | 100 | 114 | P | H |
| | | 5996.8 | 52.61 | -15.69 | 68.3 | 40.38 | 35.08 | 8.93 | 31.78 | 100 | 114 | P | H |
| | | 5633.6 | 53.25 | -15.05 | 68.3 | 40.82 | 35.3 | 8.55 | 31.42 | 217 | 162 | P | V |
| | | 5698.8 | 61.11 | -43.31 | 104.42 | 48.77 | 35.25 | 8.58 | 31.49 | 217 | 162 | P | V |
| | | 5714.4 | 69.52 | -39.81 | 109.33 | 57.19 | 35.24 | 8.61 | 31.52 | 217 | 162 | P | V |
| | | 5724.4 | 71.18 | -49.75 | 120.93 | 58.87 | 35.22 | 8.61 | 31.52 | 217 | 162 | P | V |
| | | 5758 | 109.07 | - | - | 96.82 | 35.19 | 8.64 | 31.58 | 217 | 162 | P | V |
| | | 5758 | 102.06 | - | - | 89.81 | 35.19 | 8.64 | 31.58 | 217 | 162 | A | V |
| | | 5851.2 | 53.87 | -65.69 | 119.56 | 41.71 | 35.12 | 8.72 | 31.68 | 217 | 162 | P | V |
| | | 5862.4 | 54.58 | -54.25 | 108.83 | 42.41 | 35.1 | 8.77 | 31.7 | 217 | 162 | P | V |
| | 5878.4 | 53.38 | -49.39 | 102.77 | 41.21 | 35.1 | 8.77 | 31.7 | 217 | 162 | P | V | |
| | 5954 | 53.2 | -15.1 | 68.3 | 40.97 | 35.09 | 8.88 | 31.74 | 217 | 162 | P | V | |



| WIFI Ant. 1 | Note | Frequency (MHz) | Level (dBμV/m) | Over Limit (dB) | Limit Line (dBμV/m) | Read Level (dBμV) | Antenna Factor (dB/m) | Cable Loss (dB) | Preamp Factor (dB) | Ant Pos (cm) | Table Pos (deg) | Peak Avg. (P/A) | Pol. (H/V) |
|-------------------------------|---|-------------------|------------------|-------------------|-----------------------|---------------------|-------------------------|-------------------|----------------------|----------------|-------------------|-------------------|--------------|
| 802.11ac VHT40 CH 159 5795MHz | | 5640.8 | 52.63 | -15.67 | 68.3 | 40.2 | 35.3 | 8.55 | 31.42 | 100 | 112 | P | H |
| | | 5698.4 | 53.94 | -50.18 | 104.12 | 41.6 | 35.25 | 8.58 | 31.49 | 100 | 112 | P | H |
| | | 5719.2 | 57.54 | -53.14 | 110.68 | 45.23 | 35.22 | 8.61 | 31.52 | 100 | 112 | P | H |
| | | 5720.4 | 57.69 | -54.12 | 111.81 | 45.38 | 35.22 | 8.61 | 31.52 | 100 | 112 | P | H |
| | | 5794 | 106.02 | - | - | 93.8 | 35.16 | 8.67 | 31.61 | 100 | 112 | P | H |
| | | 5794 | 96.56 | - | - | 84.34 | 35.16 | 8.67 | 31.61 | 100 | 112 | A | H |
| | | 5850.8 | 62.33 | -58.15 | 120.48 | 50.17 | 35.12 | 8.72 | 31.68 | 100 | 112 | P | H |
| | | 5856.4 | 62.82 | -47.69 | 110.51 | 50.63 | 35.1 | 8.77 | 31.68 | 100 | 112 | P | H |
| | | 5879.2 | 54.13 | -48.05 | 102.18 | 41.96 | 35.1 | 8.77 | 31.7 | 100 | 112 | P | H |
| | | 5946.8 | 52.49 | -15.81 | 68.3 | 40.26 | 35.09 | 8.88 | 31.74 | 100 | 112 | P | H |
| | | 5624.4 | 53.42 | -14.88 | 68.3 | 41.01 | 35.29 | 8.55 | 31.43 | 182 | 159 | P | V |
| | | 5699.2 | 55.05 | -49.66 | 104.71 | 42.71 | 35.25 | 8.58 | 31.49 | 182 | 159 | P | V |
| | | 5719.6 | 58.21 | -52.58 | 110.79 | 45.9 | 35.22 | 8.61 | 31.52 | 182 | 159 | P | V |
| | | 5724 | 59.74 | -60.28 | 120.02 | 47.43 | 35.22 | 8.61 | 31.52 | 182 | 159 | P | V |
| | | 5794 | 108.69 | - | - | 96.47 | 35.16 | 8.67 | 31.61 | 182 | 159 | P | V |
| | | 5794 | 101.69 | - | - | 89.47 | 35.16 | 8.67 | 31.61 | 182 | 159 | A | V |
| | | 5850.8 | 62.76 | -57.72 | 120.48 | 50.6 | 35.12 | 8.72 | 31.68 | 182 | 159 | P | V |
| | | 5856 | 63.41 | -47.21 | 110.62 | 51.22 | 35.1 | 8.77 | 31.68 | 182 | 159 | P | V |
| | 5882 | 56.13 | -43.97 | 100.1 | 43.96 | 35.1 | 8.77 | 31.7 | 182 | 159 | P | V | |
| | 5968.4 | 53.47 | -14.83 | 68.3 | 41.26 | 35.09 | 8.88 | 31.76 | 182 | 159 | P | V | |
| Remark | 1. No other spurious found. 2. All results are PASS against Peak and Average limit line. | | | | | | | | | | | | |



Band 4 5725~5850MHz
WIFI 802.11ac VHT40 (Harmonic @ 3m)

Table with 14 columns: WIFI Ant. 1, Note, Frequency (MHz), Level (dBµV/m), Over Limit (dB), Limit Line (dBµV/m), Read Level (dBµV), Antenna Factor (dB/m), Cable Loss (dB), Preamp Factor (dB), Ant Pos (cm), Table Pos (deg), Peak Avg. (P/A), Pol. (H/V). Rows include data for 802.11ac VHT40 CH 151 and CH 159 at 11510MHz and 11590MHz.



Band 4 5725~5850MHz
WIFI 802.11ac VHT80 (Band Edge @ 3m)

Table with 14 columns: WIFI Ant. 1, Note, Frequency (MHz), Level (dBµV/m), Over Limit (dB), Limit Line (dBµV/m), Read Level (dBµV), Antenna Factor (dB/m), Cable Loss (dB), Preamp Factor (dB), Ant Pos (cm), Table Pos (deg), Peak Avg. (P/A), Pol. (H/V). Rows include frequency data for 802.11ac VHT80 CH 155 5775MHz.

Remark
1. No other spurious found.
2. All results are PASS against Peak and Average limit line.



Band 4 5725~5850MHz

WIFI 802.11ac VHT80 (Harmonic @ 3m)

| WIFI Ant. 1 | Note | Frequency (MHz) | Level (dBμV/m) | Over Limit (dB) | Limit Line (dBμV/m) | Read Level (dBμV) | Antenna Factor (dB/m) | Cable Loss (dB) | Preamp Factor (dB) | Ant Pos (cm) | Table Pos (deg) | Peak Avg. (P/A) | Pol. (H/V) |
|----------------|---|-------------------|------------------|-------------------|-----------------------|---------------------|-------------------------|-------------------|----------------------|----------------|-------------------|-----------------|------------|
| 802.11ac VHT80 | | 11550 | 43.79 | -30.21 | 74 | 55.78 | 38.04 | 12.79 | 62.82 | 100 | 360 | P | H |
| CH 155 5775MHz | | 11550 | 43.86 | -30.14 | 74 | 55.85 | 38.04 | 12.79 | 62.82 | 100 | 360 | P | V |
| Remark | 1. No other spurious found. 2. All results are PASS against Peak and Average limit line. | | | | | | | | | | | | |



Emission below 1GHz

5GHz WIFI 802.11ac VHT80 (LF @ 3m)

| WIFI | Note | Frequency | Level | Over | Limit | Read | Antenna | Cable | Preamp | Ant | Table | Peak | Pol. |
|---------------------------------|--|-----------|------------|--------|------------|----------|----------|--------|--------|--------|---------|---------|---------|
| Ant. | | | | Limit | Line | Level | Factor | Loss | Factor | Pos | Pos | Avg. | |
| 1 | | (MHz) | (dBμV/m) | (dB) | (dBμV/m) | (dBμV) | (dB/m) | (dB) | (dB) | (cm) | (deg) | (P/A) | (H/V) |
| 5GHz 802.11ac VHT80 LF | | 34.85 | 17.73 | -22.27 | 40 | 26.86 | 22.1 | 0.73 | 31.96 | 100 | 0 | P | H |
| | | 128.94 | 17.16 | -26.34 | 43.5 | 31.04 | 16.78 | 1.28 | 31.94 | - | - | P | H |
| | | 143.49 | 16.25 | -27.25 | 43.5 | 29.79 | 17.07 | 1.33 | 31.94 | - | - | P | H |
| | | 157.07 | 16.16 | -27.34 | 43.5 | 29.71 | 16.91 | 1.47 | 31.93 | - | - | P | H |
| | | 963.14 | 29.65 | -24.35 | 54 | 26.16 | 30.79 | 3.56 | 30.86 | - | - | P | H |
| | | 986.42 | 29.87 | -24.13 | 54 | 26.33 | 30.61 | 3.58 | 30.65 | - | - | P | H |
| | | 42.61 | 22.36 | -17.64 | 40 | 35.49 | 18.08 | 0.74 | 31.95 | 100 | 0 | P | V |
| | | 65.89 | 21.61 | -18.39 | 40 | 40.27 | 12.28 | 0.99 | 31.93 | - | - | P | V |
| | | 84.32 | 13.8 | -26.2 | 40 | 30.39 | 14.26 | 1.08 | 31.93 | - | - | P | V |
| | | 844.8 | 27.01 | -18.99 | 46 | 26.3 | 29.19 | 3.34 | 31.82 | - | - | P | V |
| | | 896.21 | 27.63 | -18.37 | 46 | 26.47 | 29.21 | 3.44 | 31.49 | - | - | P | V |
| | 975.75 | 28.69 | -25.31 | 54 | 25.18 | 30.69 | 3.57 | 30.75 | - | - | P | V | |
| Remark | 1. No other spurious found. 2. All results are PASS against limit line. | | | | | | | | | | | | |



Note symbol

| | |
|-----|--|
| * | Fundamental Frequency which can be ignored. However, the level of any unwanted emissions shall not exceed the level of the fundamental frequency. |
| ! | Test result is over limit line. |
| P/A | Peak or Average |
| H/V | Horizontal or Vertical |



A calculation example for radiated spurious emission is shown as below:

| WIFI | Note | Frequency | Level | Over | Limit | Read | Antenna | Cable | Preamp | Ant | Table | Peak | Pol. |
|---------|------|-----------|------------|--------|------------|----------|----------|--------|--------|--------|---------|---------|---------|
| Ant. | | | | Limit | Line | Level | Factor | Loss | Factor | Pos | Pos | Avg. | |
| 2 | | (MHz) | (dBμV/m) | (dB) | (dBμV/m) | (dBμV) | (dB/m) | (dB) | (dB) | (cm) | (deg) | (P/A) | (H/V) |
| 802.11b | | 2390 | 55.45 | -18.55 | 74 | 54.51 | 32.22 | 4.58 | 35.86 | 103 | 308 | P | H |
| CH 01 | | | | | | | | | | | | | |
| 2412MHz | | 2390 | 43.54 | -10.46 | 54 | 42.6 | 32.22 | 4.58 | 35.86 | 103 | 308 | A | H |

- Level(dBμV/m) =
Antenna Factor(dB/m) + Cable Loss(dB) + Read Level(dBμV) - Preamp Factor(dB)
- Over Limit(dB) = Level(dBμV/m) – Limit Line(dBμV/m)

For Peak Limit @ 2390MHz:

- Level(dBμV/m)
= Antenna Factor(dB/m) + Cable Loss(dB) + Read Level(dBμV) - Preamp Factor(dB)
= 32.22(dB/m) + 4.58(dB) + 54.51(dBμV) – 35.86 (dB)
= 55.45 (dBμV/m)
- Over Limit(dB)
= Level(dBμV/m) – Limit Line(dBμV/m)
= 55.45(dBμV/m) – 74(dBμV/m)
= -18.55(dB)

For Average Limit @ 2390MHz:

- Level(dBμV/m)
= Antenna Factor(dB/m) + Cable Loss(dB) + Read Level(dBμV) - Preamp Factor(dB)
= 32.22(dB/m) + 4.58(dB) + 42.6(dBμV) – 35.86 (dB)
= 43.54 (dBμV/m)
- Over Limit(dB)
= Level(dBμV/m) – Limit Line(dBμV/m)
= 43.54(dBμV/m) – 54(dBμV/m)
= -10.46(dB)

Both peak and average measured complies with the limit line, so test result is “PASS”.



Appendix D. Duty Cycle Plots

| Band | Duty Cycle(%) | T(ms) | 1/T(kHz) | VBW Setting |
|----------------|---------------|-------|----------|-------------|
| 802.11a | 98.28 | - | - | 10Hz |
| 802.11n HT20 | 98.16 | - | - | 10Hz |
| 802.11ac VHT40 | 96.32 | 0.949 | 1.053 | 1.1KHz |
| 802.11ac VHT80 | 93.02 | 0.464 | 2.156 | 2.2KHz |

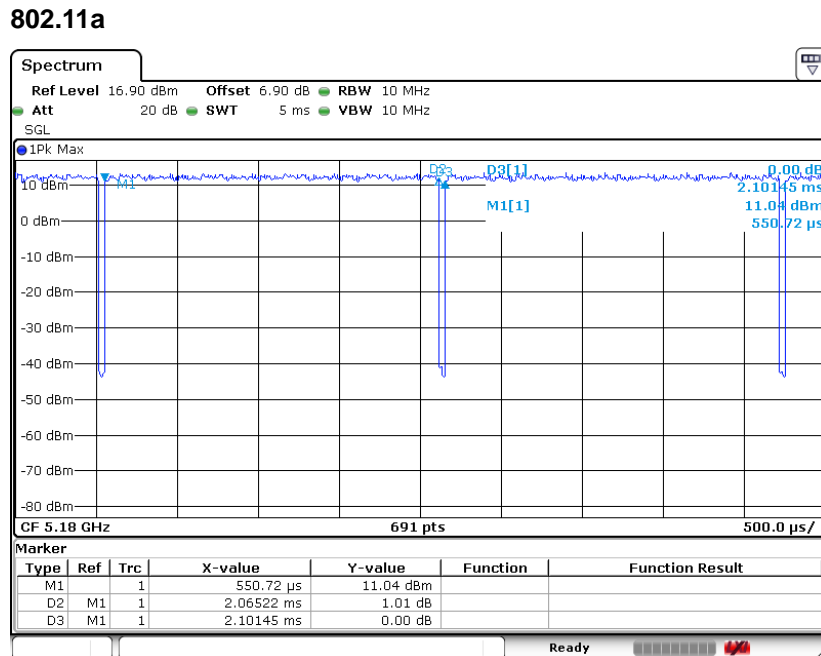



802.11n HT20

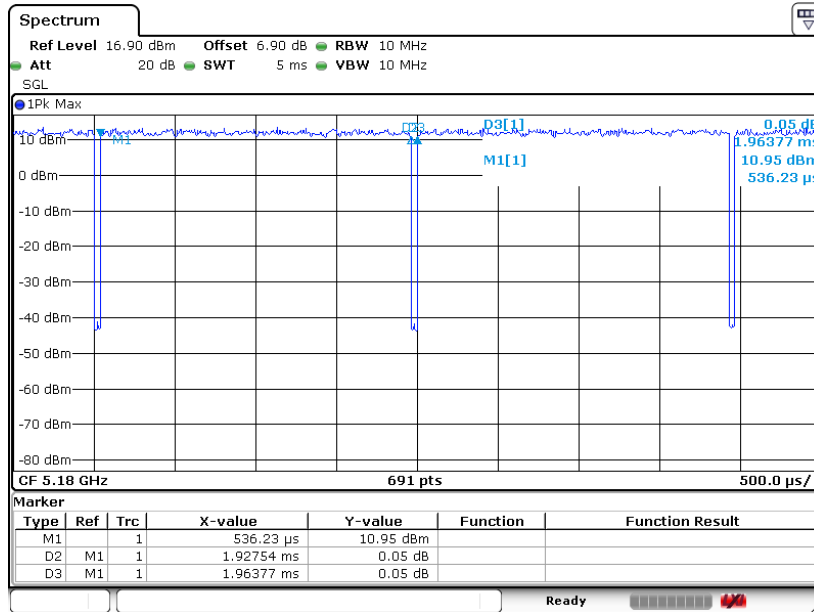

802.11ac VHT40

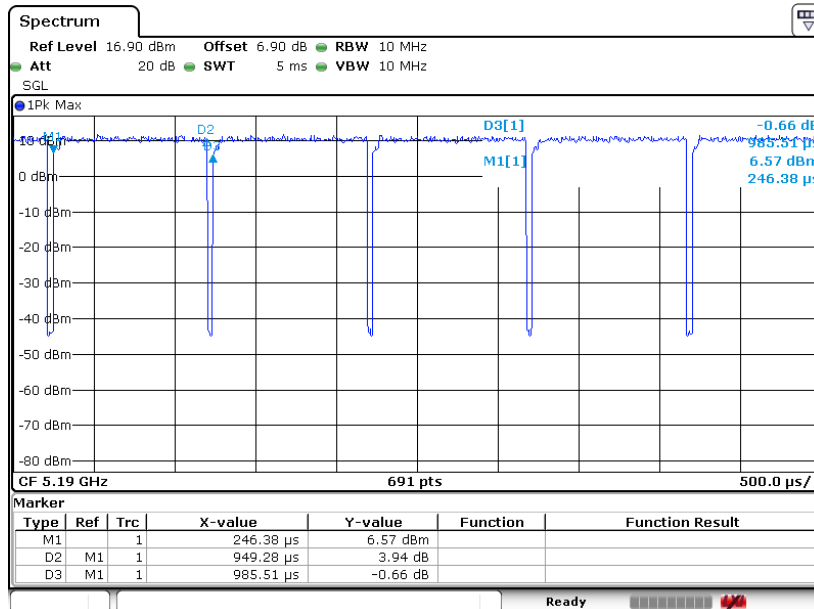



802.11ac VHT80

