



FCC RF Test Report

APPLICANT : Motorola Mobility LLC
EQUIPMENT : Mobile Cellular Phone
BRAND NAME : Motorola
MODEL NAME : XT2019-2
FCC ID : IHDT56YG2
STANDARD : FCC Part 15 Subpart E §15.407
CLASSIFICATION : (NII) Unlicensed National Information Infrastructure

The product was received on Jun. 25, 2019 and testing was completed on Aug. 02, 2019. We, Sporton International (Kunshan) Inc., would like to declare that the tested sample has been evaluated in accordance with the test procedures and has been in compliance with the applicable technical standards.

The test results in this report apply exclusively to the tested model / sample. Without written approval of Sporton International (Kunshan) Inc., the test report shall not be reproduced except in full.

Jason Jia

Reviewed by: Jason Jia / Supervisor

James Huang

Approved by: James Huang / Manager



Sporton International (Kunshan) Inc.

**No. 1098, Pengxi North Road, Kunshan Economic Development Zone Jiangsu Province 215300
People's Republic of China**



TABLE OF CONTENTS

REVISION HISTORY..... 3
SUMMARY OF TEST RESULT 4
1 GENERAL DESCRIPTION 5
1.1 Applicant 5
1.2 Manufacturer 5
1.3 Product Feature of Equipment Under Test 5
1.4 Product Specification of Equipment Under Test 6
1.5 Modification of EUT 7
1.6 Testing Location 7
1.7 Applicable Standards 7
1.8 Specification of Accessory 8
2 TEST CONFIGURATION OF EQUIPMENT UNDER TEST 10
2.1 Carrier Frequency and Channel 10
2.2 Test Mode 11
2.3 Connection Diagram of Test System 13
2.4 Support Unit used in test configuration and system 14
2.5 EUT Operation Test Setup 14
2.6 Measurement Results Explanation Example 14
3 TEST RESULT 15
3.1 26dB & 99% Occupied Bandwidth Measurement 15
3.2 Maximum Conducted Output Power Measurement 17
3.3 Power Spectral Density Measurement 19
3.4 Unwanted Emissions Measurement 22
3.5 AC Conducted Emission Measurement 27
3.6 Automatically Discontinue Transmission 29
3.7 Antenna Requirements 30
4 LIST OF MEASURING EQUIPMENT 31
5 UNCERTAINTY OF EVALUATION 32
APPENDIX A. CONDUCTED TEST RESULTS
APPENDIX B. AC CONDUCTED EMISSION TEST RESULT
APPENDIX C. RADIATED SPURIOUS EMISSION
APPENDIX D. DUTY CYCLE PLOTS
APPENDIX E. SETUP PHOTOGRAPHS



REVISION HISTORY

REPORT NO.	VERSION	DESCRIPTION	ISSUED DATE
FR962524D	Rev. 01	Initial issue of report	Aug. 27, 2019



SUMMARY OF TEST RESULT

Report Section	FCC Rule	Description	Limit	Result	Remark
3.1	2.1049 & 15.403(i)	26dB & 99% Bandwidth	-	Pass	-
3.2	15.407(a)	Maximum Conducted Output Power	≤ 24 dBm	Pass	-
3.3	15.407(a)	Power Spectral Density	≤ 11 dBm	Pass	-
3.4	15.407(b)	Unwanted Emissions	15.407(b) & 15.209(a)	Pass	Under limit 3.15 dB at 5459.980 MHz
3.5	15.207	AC Conducted Emission	15.207(a)	Pass	Under limit 8.81 dB at 0.195 MHz
3.6	15.407(c)	Automatically Discontinue Transmission	Discontinue Transmission	Pass	-
3.7	15.203 & 15.407(a)	Antenna Requirement	N/A	Pass	-



1 General Description

1.1 Applicant

Motorola Mobility LLC
222 W,Merchandise Mart Plaza, Chicago IL 60654 USA

1.2 Manufacturer

Motorola Mobility LLC
222 W,Merchandise Mart Plaza, Chicago IL 60654 USA

1.3 Product Feature of Equipment Under Test

Product Feature	
Equipment	Mobile Cellular Phone
Brand Name	Motorola
Model Name	XT2019-2
FCC ID	IHDT56YG2
EUT supports Radios application	GSM/GPRS/EGPRS/WCDMA/HSPA/DC-HSDPA/ HSPA+(16QAM uplink is not supported)/LTE WLAN 2.4GHz 802.11b/g/n HT20 WLAN 5GHz 802.11a/n HT20/HT40 WLAN 5GHz 802.11ac VHT20/VHT40/VHT80 Bluetooth BR / EDR/ LE FM Receiver and GNSS
IMEI Code	Conducted: 357207100021757/357207100021765 Conduction: 357207100020114/357207100020122 Radiation: 357207100035252/357207100035260
HW Version	DVT2
SW Version	PPI29.35
EUT Stage	Identical Prototype

Remark:

1. The above EUT's information was declared by manufacturer. Please refer to the specifications or user's manual for more detailed description.
2. There are two types of EUT, sample 1 is dual SIM card, sample 2 is single SIM card, all the others are the same. We choice the sample 1 to full test.



1.4 Product Specification of Equipment Under Test

Standards-related Product Specification	
Tx/Rx Frequency Range	5180 MHz ~ 5240 MHz 5260 MHz ~ 5320 MHz 5500 MHz ~ 5720 MHz
Maximum Output Power to Antenna	<p><5180 MHz ~ 5240 MHz> 802.11a : 15.67 dBm / 0.0369 W 802.11n HT20 : 14.96 dBm / 0.0313 W 802.11n HT40 : 13.06 dBm / 0.0202 W 802.11n VHT20 : 14.69 dBm / 0.0294 W 802.11ac VHT40 : 13.50 dBm / 0.0224 W 802.11ac VHT80 : 10.18 dBm / 0.0104 W</p> <p><5260 MHz ~ 5320 MHz> 802.11a : 15.56 dBm / 0.0360 W 802.11n HT20 : 15.38 dBm / 0.0345 W 802.11n HT40 : 13.27 dBm / 0.0212 W 802.11ac VHT20 : 15.05 dBm / 0.0320 W 802.11ac VHT40 : 13.75 dBm / 0.0237 W 802.11ac VHT80 : 10.16 dBm / 0.0104 W</p> <p><5500 MHz ~ 5720 MHz > 802.11a : 15.31 dBm / 0.0340 W 802.11n HT20 : 15.10 dBm / 0.0324 W 802.11n HT40 : 12.90 dBm / 0.0195 W 802.11ac VHT20 : 14.40 dBm / 0.0275 W 802.11ac VHT40 : 13.35 dBm / 0.0216 W 802.11ac VHT80 : 10.34 dBm / 0.0108 W</p>
99% Occupied Bandwidth	<p><5180 MHz ~ 5240 MHz> 802.11a : 17.43 MHz 802.11n HT20 : 18.63 MHz 802.11ac VHT40 : 36.46 MHz 802.11ac VHT80 : 75.64 MHz</p> <p><5260 MHz ~ 5320 MHz> 802.11a : 17.53 MHz 802.11n HT20 : 18.68 MHz 802.11ac VHT40 : 36.46 MHz 802.11ac VHT80 : 75.76 MHz</p> <p><5500 MHz ~ 5720 MHz> 802.11a : 17.48 MHz 802.11n HT20 : 18.68 MHz 802.11ac VHT40 : 36.56 MHz 802.11ac VHT80 : 75.76 MHz</p>
Antenna Type / Gain	<p><5180 MHz ~ 5240 MHz> PIFA Antenna with gain -1.10 dBi</p> <p><5260 MHz ~ 5320 MHz> PIFA Antenna with gain -0.40 dBi</p> <p><5500 MHz ~ 5720 MHz > PIFA Antenna with gain -0.30 dBi</p>
Type of Modulation	802.11a/n : OFDM (BPSK / QPSK / 16QAM / 64QAM) 802.11ac : OFDM (BPSK / QPSK / 16QAM / 64QAM / 256QAM)

Note: For 802.11an HT20 / ac VHT20 and 802.11an HT40 / ac VHT40 mode, the whole testing have assessed only 802.11n HT20/802.11ac VHT40 by referring to their maximum conducted power.



1.5 Modification of EUT

No modifications are made to the EUT during all test items.

1.6 Testing Location

Sporton International (Kunshan) Inc. is accredited to ISO/IEC 17025:2017 by American Association for Laboratory Accreditation with Certificate Number 5145.02.

Test Firm	Sporton International (Kunshan) Inc.		
Test Site Location	No. 1098, Pengxi North Road, Kunshan Economic Development Zone Jiangsu Province 215300 People's Republic of China TEL : +86-512-57900158 FAX : +86-512-57900958		
Test Site No.	Sporton Site No.	FCC Designation No.	FCC Test Firm Registration No.
	TH01-KS CO01-KS 03CH05-KS	CN1257	314309

1.7 Applicable Standards

According to the specifications of the manufacturer, the EUT must comply with the requirements of the following standards:

- ♦ 47 CFR Part 15 Subpart E
- ♦ FCC KDB 789033 D02 General UNII Test Procedures New Rules v02r01.
- ♦ ANSI C63.10-2013

Remark:

1. All test items were verified and recorded according to the standards and without any deviation during the test.
2. This EUT has also been tested and complied with the requirements of FCC Part 15, Subpart B, recorded in a separate test report.



1.8 Specification of Accessory

Specification of Accessory				
AC Adapter 1(US)	Brand Name	Motorola (Salom)	Model Name	SC-51
	Power Rating	I/P: 100-240 Vac, 0.6A, 50/60Hz; O/P: 5/9/12Vdc, 3000/2000/1500mA		
AC Adapter 1(EU)	Brand Name	Motorola (Salom)	Model Name	SC-52
	Power Rating	I/P: 100-240 Vac, 0.6A, 50/60Hz; O/P: 5/9/12Vdc, 3000/2000/1500mA		
AC Adapter 1(BR)	Brand Name	Motorola (Salom)	Model Name	SC-57
	Power Rating	I/P: 100-240 Vac, 0.6A, 50/60Hz; O/P: 5/9/12Vdc, 3000/2000/1500mA		
AC Adapter 1(Chile)	Brand Name	Motorola (Salom)	Model Name	SC-52
	Power Rating	I/P: 100-240 Vac, 0.6A, 50/60Hz; O/P: 5/9/12Vdc, 3000/2000/1500mA		
AC Adapter 1(AR)	Brand Name	Motorola (Salom)	Model Name	SC-56
	Power Rating	I/P: 100-240 Vac, 0.6A, 50/60Hz; O/P: 5/9/12Vdc, 3000/2000/1500mA		
AC Adapter 1 (UK)	Brand Name	Motorola (Salom)	Model Name	SC-53
	Power Rating	I/P: 100-240 Vac, 0.6A, 50/60Hz; O/P: 5/9/12Vdc, 3000/2000/1500mA		
AC Adapter 1 (AU)	Brand Name	Motorola (Salom)	Model Name	SC-55
	Power Rating	I/P: 100-240 Vac, 0.6A, 50/60Hz; O/P: 5/9/12Vdc, 3000/2000/1500mA		
AC Adapter 2(US)	Brand Name	Motorola(Chenyang)	Model Name	SC-51
	Power Rating	I/P: 100-240 Vac, 0.6A, 50/60Hz; O/P: 5/9/12Vdc, 3000/2000/1500mA		
AC Adapter 2(EU)	Brand Name	Motorola(Chenyang)	Model Name	SC-52
	Power Rating	I/P: 100-240 Vac, 0.6A, 50/60Hz; O/P: 5/9/12Vdc, 3000/2000/1500mA		
AC Adapter 2(AR)	Brand Name	Motorola(Chenyang)	Model Name	SC-56
	Power Rating	I/P: 100-240 Vac, 0.6A, 50/60Hz; O/P: 5/9/12Vdc, 3000/2000/1500mA		
AC Adapter 2(UK)	Brand Name	Motorola(Chenyang)	Model Name	SC-53
	Power Rating	I/P: 100-240 Vac, 0.6A, 50/60Hz; O/P: 5/9/12Vdc, 3000/2000/1500mA		
AC Adapter 2(AU)	Brand Name	Motorola(Chenyang)	Model Name	SC-55
	Power Rating	I/P: 100-240 Vac, 0.6A, 50/60Hz; O/P: 5/9/12Vdc, 3000/2000/1500mA		
AC Adapter 3(BR)	Brand Name	Motorola(Cliptech/Tenpao)	Model Name	SC-57
	Power Rating	I/P: 100-240 Vac, 0.6A, 50/60Hz; O/P: 5/9/12Vdc, 3000/2000/1500mA		
AC Adapter 4(BR)	Brand Name	Motorola(Flex/Salom)	Model Name	SC-57
	Power Rating	I/P: 100-240 Vac, 0.6A, 50/60Hz; O/P: 5/9/12Vdc, 3000/2000/1500mA		
Battery	Brand Name	Motorola (Sunwoda)	Model Name	KD40
	Power Rating	3.8Vdc,4000mAh	Type	Li-ion
Earphone 1	Brand Name	Motorola (Lianyun)	Model Name	SH38C37773
	Signal Line Type	1.1 meter, non-shielded cable, with w/o ferrite core		
Earphone 2	Brand Name	Motorola (Cosonic)	Model Name	SH38C44959
	Signal Line Type	1.1 meter, non-shielded cable, with w/o ferrite core		
Earphone 3	Brand Name	Motorola (NEW LEADER)	Model Name	NLD-EM303H-10SF
	Signal Line Type	1.2 meter, non-shielded cable, with w/o ferrite core		



USB Cable 1	Brand Name	Motorola (LiQi)	Model Name	L32B-053000100/ L32B-053000100L
	Signal Line Type	1.0 meter, shielded cable, without ferrite core		
USB Cable 2	Brand Name	Motorola (SaiBao)	Model Name	S32B-053000100/ S32B-053000100L
	Signal Line Type	1.0 meter, shielded cable, without ferrite core		
USB Cable 3	Brand Name	Motorola (I SHENG)	Model Name	SC18C28955
	Signal Line Type	1.0 meter, shielded cable, without ferrite core		



2 Test Configuration of Equipment Under Test

- a. The EUT has been associated with peripherals and configuration operated in a manner tended to maximize its emission characteristics in a typical application. Frequency range investigated: conduction emission (150 kHz to 30 MHz), radiation emission (9 kHz to the 10th harmonic of the highest fundamental frequency or to 40 GHz, whichever is lower). For radiated measurement, pre-scanned in three orthogonal panels, X, Y, Z. The worst cases (Z plane) were recorded in this report.
- b. AC power line Conducted Emission was tested under maximum output power.

2.1 Carrier Frequency and Channel

Frequency Band	Channel	Freq. (MHz)	Channel	Freq. (MHz)
5180-5240 MHz Band 1 (U-NII-1)	36	5180	44	5220
	38*	5190	46*	5230
	40	5200	48	5240
	42 [#]	5210		

Frequency Band	Channel	Freq. (MHz)	Channel	Freq. (MHz)
5260-5320 MHz Band 2 (U-NII-2A)	52	5260	60	5300
	54*	5270	62*	5310
	56	5280	64	5320
	58 [#]	5290		

Frequency Band	Channel	Freq. (MHz)	Channel	Freq. (MHz)
5500-5720 MHz Band 3 (U-NII-2C)	100	5500	112	5560
	102*	5510	116	5580
	104	5520	132	5660
	106 [#]	5530	134*	5670
	108	5540	136	5680
	110*	5550	140	5700



Frequency Band	Channel	Freq. (MHz)	Channel	Freq. (MHz)
TDWR Channel	118*	5590	124	5620
	120	5600	126*	5630
	122 [#]	5610	128	5640

Frequency Band	Channel	Freq. (MHz)	Channel	Freq. (MHz)
Straddle Channel	138 [#]	5690	144	5720
	142*	5710		

Note:

1. The above Frequency and Channel in "*" were 802.11n HT40 and 802.11ac VHT40.
2. The above Frequency and Channel in "[#]" were 802.11ac VHT80.

2.2 Test Mode

Final test modes are considering the modulation and worse data rates as below table.

Modulation	Data Rate
802.11a	6 Mbps
802.11n HT20	MCS0
802.11ac VHT40	MCS0
802.11ac VHT80	MCS0

Test Cases	
AC Conducted Emission	Mode 1 : GSM 850 Idle + Bluetooth Link + WLAN Link(5G) + Earphone 2 + USB Cable 1(Charging from Adapter 2)



Ch. #		Band I : 5180-5240 MHz	Band II : 5260-5320 MHz	Band III : 5500-5720MHz
		802.11a	802.11a	802.11a
L	Low	36	52	100
M	Middle	44	60	116
H	High	48	64	140
Straddle		-	-	144

Ch. #		Band I : 5180-5240 MHz	Band II : 5260-5320 MHz	Band III : 5500-5720MHz
		802.11n HT20	802.11n HT20	802.11n HT20
L	Low	36	52	100
M	Middle	44	60	116
H	High	48	64	140
Straddle		-	-	144

Ch. #		Band I : 5180-5240 MHz	Band II : 5260-5320 MHz	Band III : 5500-5720MHz
		802.11ac VHT40	802.11ac VHT40	802.11ac VHT40
L	Low	38	54	102
M	Middle	-	-	110
H	High	46	62	134
Straddle		-	-	142

Ch. #		Band I : 5180-5240 MHz	Band II : 5260-5320 MHz	Band III : 5500-5720MHz
		802.11ac VHT80	802.11ac VHT80	802.11ac VHT80
L	Low	-	-	106
M	Middle	42	58	-
H	High	-	-	122
Straddle		-	-	138

2.3 Connection Diagram of Test System

For Radiation

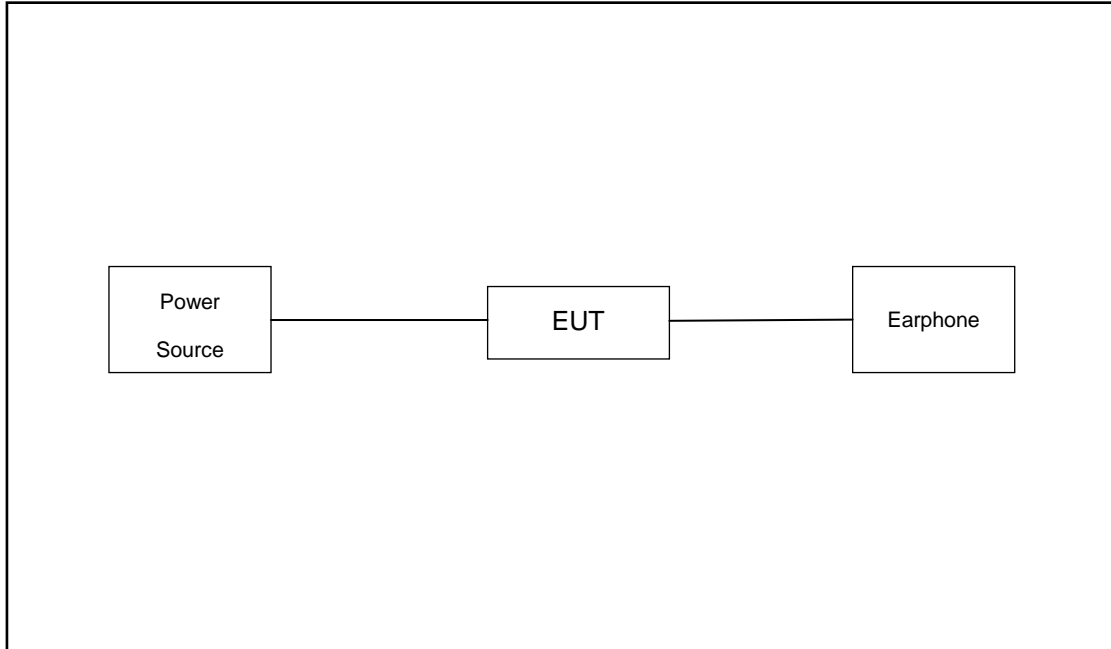

For Conducted Emission

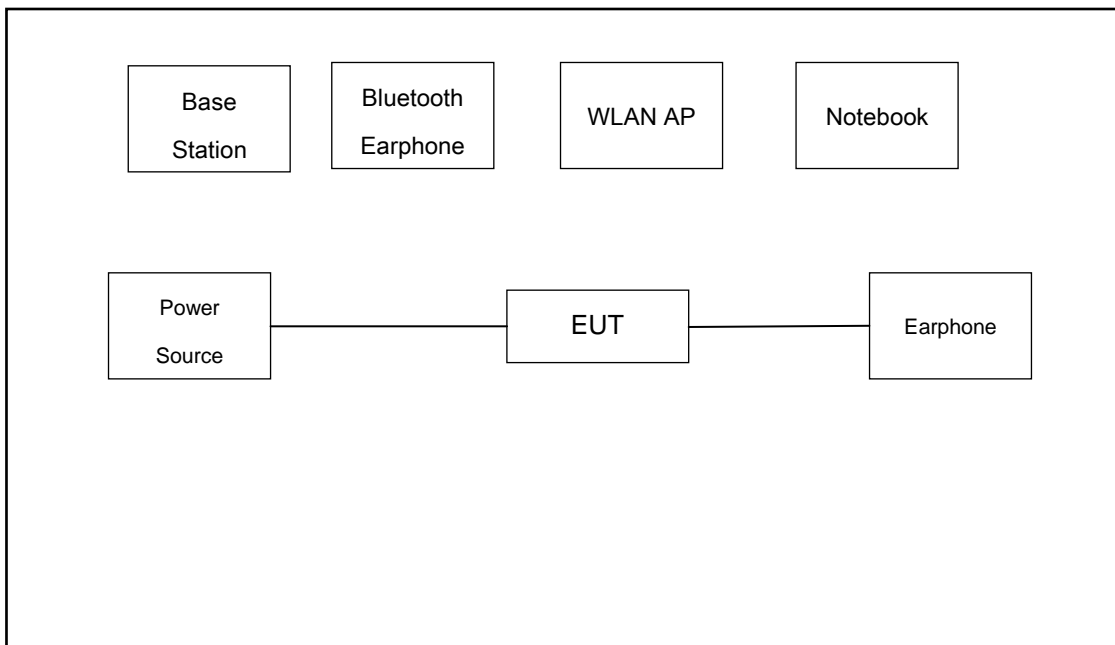



2.4 Support Unit used in test configuration and system

Item	Equipment	Trade Name	Model Name	FCC ID	Data Cable	Power Cord
1.	Base Station	Anritsu	MT8820C	N/A	N/A	Unshielded,1.8m
2.	Bluetooth Earphone	Lenovo	LBH308	N/A	N/A	N/A
3.	Notebook	Lenovo	G480	N/A	N/A	shielded cable DC O/P 1.8m , Unshielded AC I/P cable 1.8m
4.	WLAN AP	D-link	DIR-855	KA2DIR855A2	N/A	Unshielded,1.8m

2.5 EUT Operation Test Setup

For WLAN RF test items, an engineering test program was provided and enabled to make EUT continuous transmit/receive.

For AC power line conducted emissions, the EUT was set to connect with the WLAN AP under large package sizes transmission.

2.6 Measurement Results Explanation Example

For all conducted test items:

The offset level is set in the spectrum analyzer to compensate the RF cable loss between EUT conducted output port and spectrum analyzer. With the offset compensation, the spectrum analyzer reading level is exactly the EUT RF output level.

Example :

The spectrum analyzer offset is derived from RF cable loss.

Offset = RF cable loss.

Following shows an offset computation example with cable loss 6.9 dB.

$$\begin{aligned}
 \text{Offset(dB)} &= \text{RF cable loss(dB)}. \\
 &= 6.9 \text{ (dB)}
 \end{aligned}$$

3 Test Result

3.1 26dB & 99% Occupied Bandwidth Measurement

3.1.1 Description of 26dB & 99% Occupied Bandwidth

This section is for reporting purpose only.

There is no restriction limits for bandwidth.

3.1.2 Measuring Instruments

The measuring equipment is listed in the section 4 of this test report.

3.1.3 Test Procedures

1. The testing follows FCC KDB 789033 D02 General UNII Test Procedures New Rules v02r01. Section C) Emission bandwidth
2. Set RBW = approximately 1% of the emission bandwidth.
3. Set the VBW > RBW.
4. Detector = Peak.
5. Trace mode = max hold
6. Measure the maximum width of the emission that is 26 dB down from the peak of the emission. Compare this with the RBW setting of the analyzer. Readjust RBW and repeat measurement as needed until the RBW/EBW ratio is approximately 1%.
7. For 99% Bandwidth Measurement, the spectrum analyzer's resolution bandwidth (RBW) is set 1MHz and set the Video bandwidth (VBW) $\geq 3 * RBW$.
8. Measure and record the results in the test report.

3.1.4 Test Setup

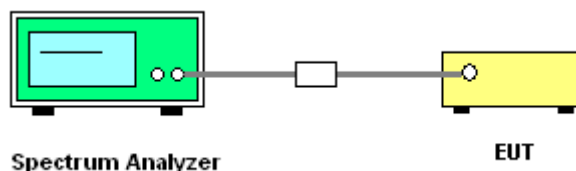

3.1.5 Test Result of 26dB & 99% Occupied Bandwidth

Please refer to Appendix A.

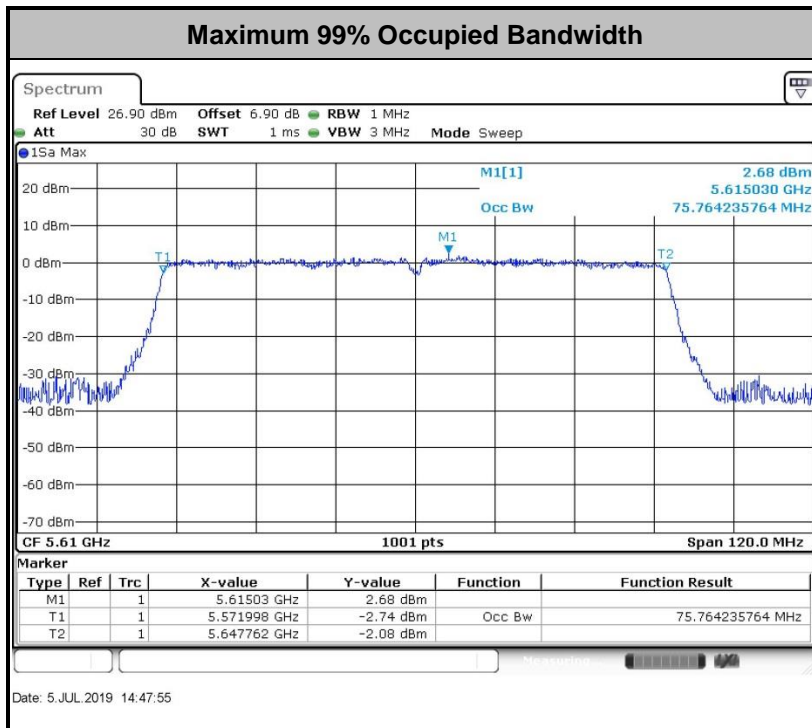
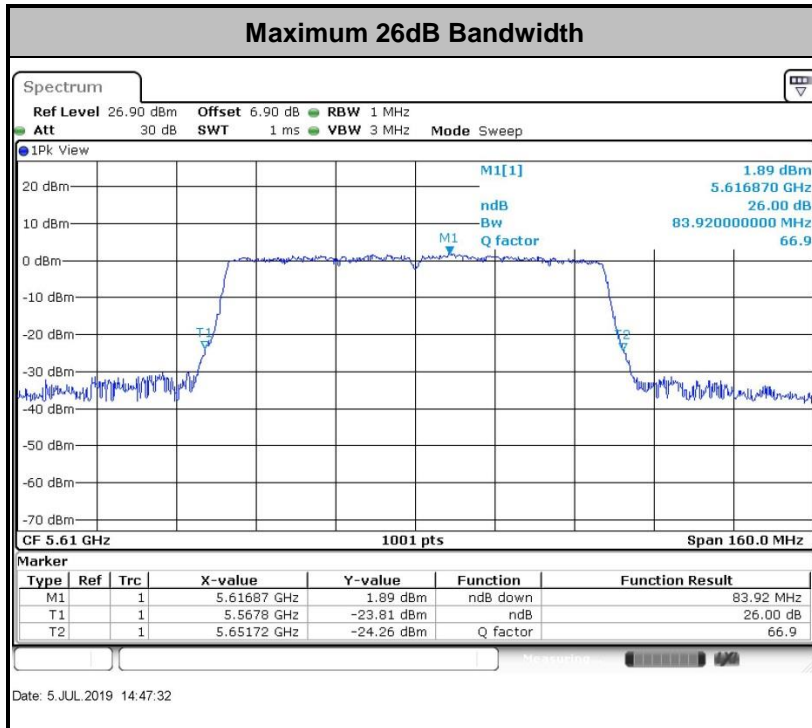

Note: The occupied channel bandwidth is maintained within the band of operation for all of the modulations.



3.2 Maximum Conducted Output Power Measurement

3.2.1 Limit of Maximum Conducted Output Power

<FCC 14-30 CFR 15.407>

For mobile and portable client devices in the 5.15–5.25 GHz band, the maximum conducted output power over the frequency band of operation shall not exceed 250 mW.

For the 5.25–5.725 GHz bands, the maximum conducted output power over the frequency bands of operation shall not exceed the lesser of 250 mW or $11 \text{ dBm} + 10 \log B$, where B is the 26 dB emission bandwidth in megahertz.

For Straddle Channel, According to KDB 789033 D02 General UNII Test Procedures New Rules v02r01, If the power and PSD of the devices are uniform and comply with the lower limits specified for the U-NII-2 bands, a single measurement over the entire emission bandwidth can be performed to show compliance.

If transmitting antennas of directional gain greater than 6 dBi are used, the peak output power shall be reduced by the amount in dB that the directional gain of the antenna exceeds 6 dBi.

Note that U-NII-2 band, devices with a maximum e.i.r.p. greater than 500 mW shall implement TPC in order to have the capability to operate at least 6 dB below the maximum permitted e.i.r.p. of 1 W.

3.2.2 Measuring Instruments

The measuring equipment is listed in the section 4 of this test report.

3.2.3 Test Procedures

The testing follows Method PM of FCC KDB 789033 D02 General UNII Test Procedures New Rules v02r01.

Method PM (Measurement using an RF average power meter):

1. Measurement is performed using a wideband RF power meter.
2. The EUT is configured to transmit continuously with a consistent duty cycle at its maximum power control level.
3. Measure the average power of the transmitter, and the average power is corrected with duty factor, $10 \log(1/x)$, where x is the duty cycle.

3.2.4 Test Setup

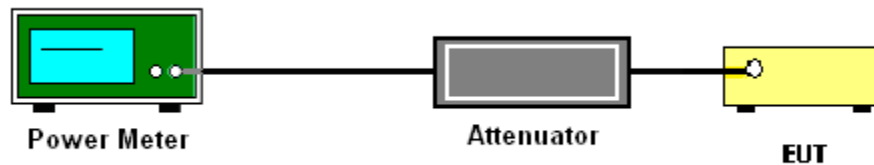

3.2.5 Test Result of Maximum Conducted Output Power

Please refer to Appendix A.



3.3 Power Spectral Density Measurement

3.3.1 Limit of Power Spectral Density

<FCC 14-30 CFR 15.407>

For mobile and portable client devices in the 5.15–5.25 GHz band, the maximum power spectral density shall not exceed 11dBm in any 1 megahertz band.

For the 5.25–5.725 GHz bands, the maximum power spectral density shall not exceed 11 dBm in any 1 megahertz band.

For Straddle Channel, According to KDB 789033 D02 General UNII Test Procedures New Rules v02r01, If the power and PSD of the devices are uniform and comply with the lower limits specified for the U-NII-2 bands, a single measurement over the entire emission bandwidth can be performed to show compliance.

If transmitting antennas of directional gain greater than 6 dBi are used, the peak output power shall be reduced by the amount in dB that the directional gain of the antenna exceeds 6 dBi.

3.3.2 Measuring Instruments

The measuring equipment is listed in the section 4 of this test report.

3.3.3 Test Procedures

The testing follows FCC KDB 789033 D02 General UNII Test Procedures New Rules v02r01.
Section F) Maximum power spectral density.

Method SA-2

(trace averaging across on and off times of the EUT transmissions, followed by duty cycle correction).

- Measure the duty cycle.
 - Set span to encompass the entire emission bandwidth (EBW) of the signal.
 - Set RBW = 1 MHz.
 - Set VBW \geq 3 MHz.
 - Number of points in sweep \geq 2 Span / RBW.
 - Sweep time = auto.
 - Detector = RMS
 - Trace average at least 100 traces in power averaging mode.
 - Add $10 \log(1/x)$, where x is the duty cycle, to the measured power in order to compute the average power during the actual transmission times. For example, add $10 \log(1/0.25) = 6$ dB if the duty cycle is 25 percent.
1. The RF output of EUT was connected to the spectrum analyzer by a low loss cable.
 2. Each plot has already offset with cable loss, and attenuator loss. Measure the PPSD and record it.

3.3.4 Test Setup

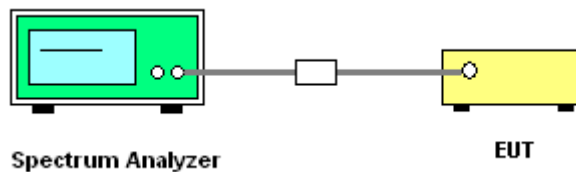

3.3.5 Test Result of Power Spectral Density

Please refer to Appendix A.

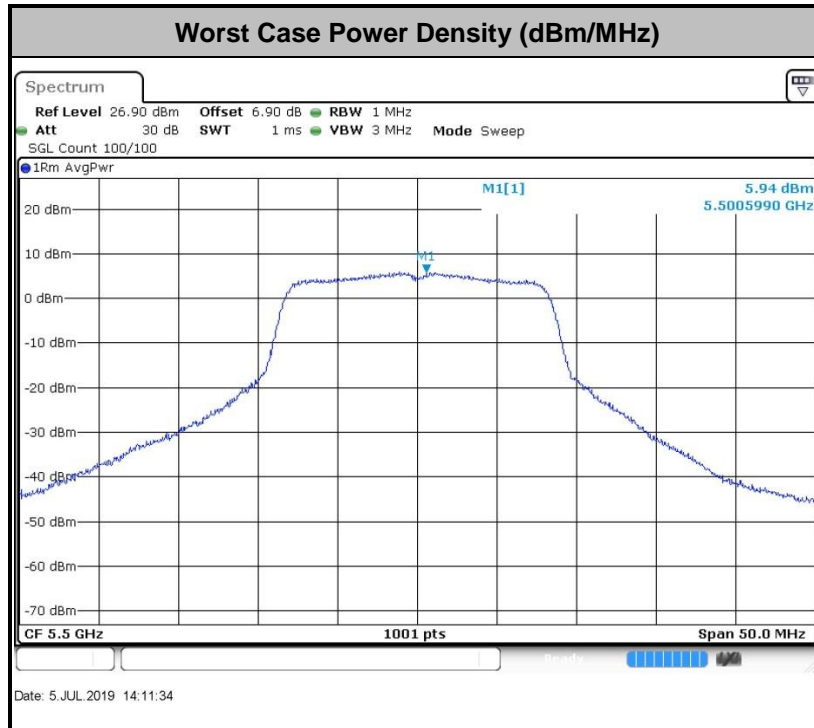

Note: Average Power Density (dB) = Measured value+ Duty Factor



3.4 Unwanted Emissions Measurement

This section is to measure unwanted emissions through radiated measurement for band edge spurious emissions and out of band emissions measurement.

3.4.1 Limit of Unwanted Emissions

- (1) For transmitters operating in the 5150-5250 MHz band: all emissions outside of the 5150-5350 MHz band shall not exceed an EIRP of -27dBm/MHz.

For transmitters operating in the 5250-5350 MHz band: all emissions outside of the 5150-5350 MHz band shall not exceed an EIRP of -27 dBm/MHz. Devices operating in the 5250-5350 MHz band that generate emissions in the 5150-5250 MHz band must meet all applicable technical requirements for operation in the 5150-5250 MHz band (including indoor use) or alternatively meet an out-of-band emission EIRP limit of -27 dBm/MHz in the 5150-5250 MHz band.

For transmitters operating in the 5470-5600 MHz and 5650-5725MHz band: all emissions outside of the 5470-5600 MHz and 5650-5725MHz band shall not exceed an EIRP of -27 dBm/MHz.

- (2) Unwanted spurious emissions fallen in restricted bands shall comply with the general field strength limits as below table,

Frequency (MHz)	Field Strength (microvolts/meter)	Measurement Distance (meters)
0.009 – 0.490	2400/F(kHz)	300
0.490 – 1.705	24000/F(kHz)	30
1.705 – 30.0	30	30
30 – 88	100	3
88 – 216	150	3
216 - 960	200	3
Above 960	500	3



EIRP (dBm)	Field Strength at 3m (dBµV/m)
- 27	68.3

Note: The following formula is used to convert the EIRP to field strength.

$$EIRP = E_{Meas} + 20\log (d_{Meas}) - 104.7$$

where

EIRP is the equivalent isotropically radiated power, in dBm

E_{Meas} is the field strength of the emission at the measurement distance, in dBµV/m

d_{Meas} is the measurement distance, in m

3.4.2 Measuring Instruments

The measuring equipment is listed in the section 4 of this test report.

3.4.3 Test Procedures

- The testing follows FCC KDB 789033 D02 General UNII Test Procedures New Rules v02r01. Section G) Unwanted emissions measurement.

(1) Procedure for Unwanted Emissions Measurements Below 1000MHz

- RBW = 120 kHz
- VBW = 300 kHz
- Detector = Peak
- Trace mode = max hold

(2) Procedure for Peak Unwanted Emissions Measurements Above 1000 MHz

- RBW = 1 MHz
- VBW ≥ 3 MHz
- Detector = Peak
- Sweep time = auto
- Trace mode = max hold

(3) Procedures for Average Unwanted Emissions Measurements Above 1000MHz

- RBW = 1 MHz
- VBW = 10 Hz, when duty cycle is no less than 98 percent.
- VBW ≥ 1/T, when duty cycle is less than 98 percent where T is the minimum transmission duration over which the transmitter is on and is transmitting at its maximum power control level for the tested mode of operation.

- The EUT was placed on a turntable with 0.8 meter for frequency below 1GHz and 1.5 meter for frequency above 1GHz respectively above ground.
- The EUT was set 3 meters from the interference receiving antenna which was mounted on the top of a variable height antenna tower.

4. The antenna is a broadband antenna and its height is adjusted between one meter and four meters above ground to find the maximum value of the field strength for both horizontal polarization and vertical polarization of the antenna.
5. For each suspected emission, the EUT was arranged to its worst case and then adjust the antenna tower (from 1 m to 4 m) and turntable (from 0 degree to 360 degrees) to find the maximum reading.
6. For testing below 1GHz, if the emission level of the EUT in peak mode was 3 dB lower than the limit specified, then peak values of EUT will be reported, otherwise, the emissions will be repeated one by one using the CISPR quasi-peak method and reported.
7. For testing above 1GHz, the emission level of the EUT in peak mode was 20dB lower than average limit (that means the emission level in average mode also complies with the limit in average mode), then peak values of EUT will be reported, otherwise, the emissions will be measured in average mode again and reported.

3.4.4 Test Setup

For radiated emissions below 30MHz

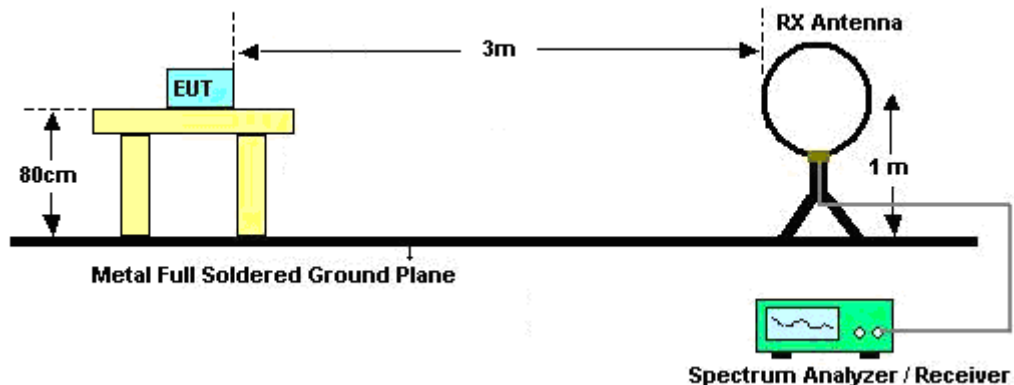

For radiated emissions from 30MHz to 1GHz

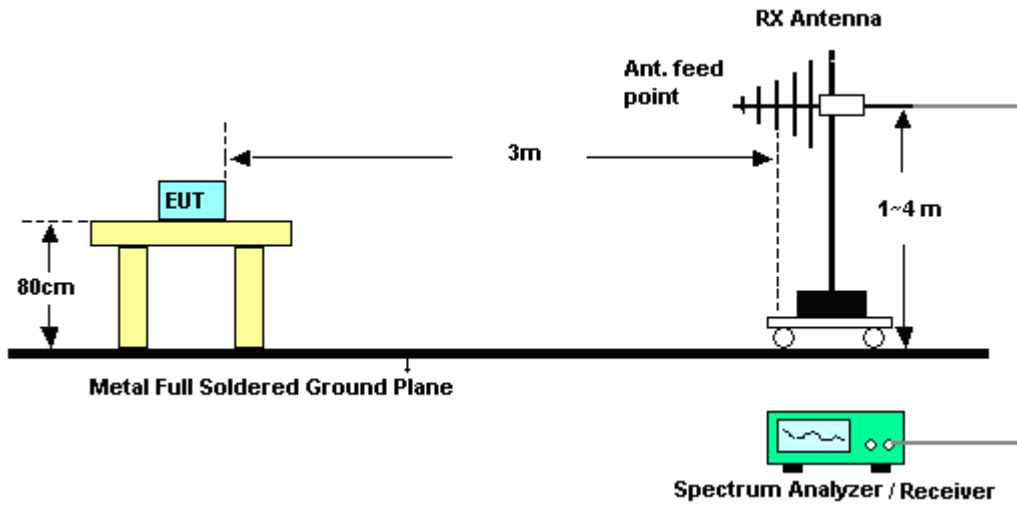

For radiated emissions above 1GHz

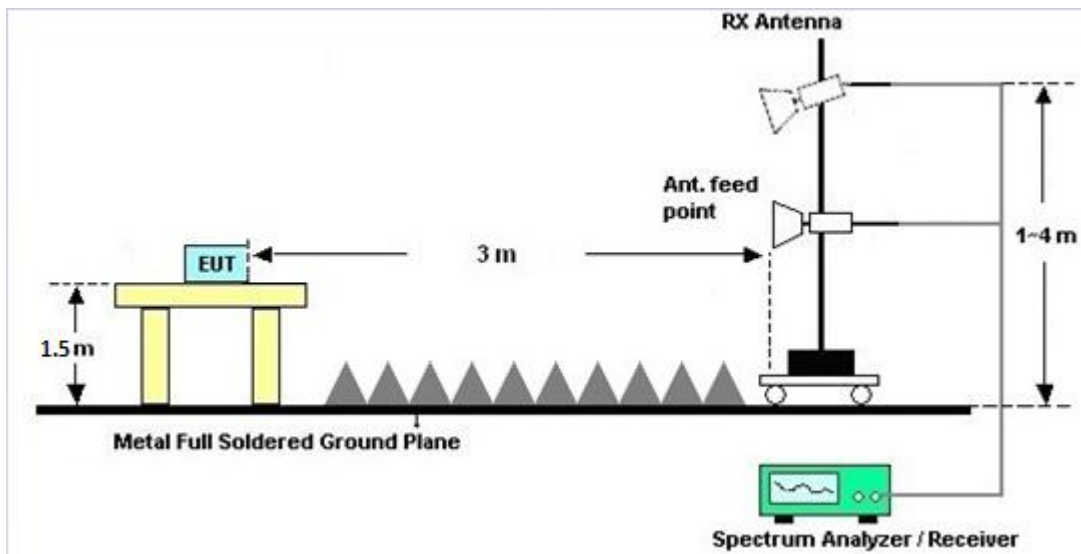



3.4.5 Test Results of Radiated Spurious Emissions (9 kHz ~ 30 MHz)

The low frequency, which started from 9 kHz to 30MHz, was pre-scanned and the result which was 20dB lower than the limit line was not reported.

There is a comparison data of both open-field test site and semi-Anechoic chamber, and the result came out very similar.

3.4.6 Test Result of Radiated Spurious at Band Edges

Please refer to Appendix C.

3.4.7 Duty Cycle

Please refer to Appendix D.

3.4.8 Test Result of Radiated Spurious Emissions (30MHz ~ 10th Harmonic)

Please refer to Appendix C.



3.5 AC Conducted Emission Measurement

3.5.1 Limit of AC Conducted Emission

For equipment that is designed to be connected to the public utility (AC) power line, the radio frequency voltage that is conducted back onto the AC power line on any frequency or frequencies within the band 150 kHz to 30 MHz shall not exceed the limits in the following table.

Frequency of emission (MHz)	Conducted limit (dBµV)	
	Quasi-peak	Average
0.15-0.5	66 to 56*	56 to 46*
0.5-5	56	46
5-30	60	50

*Decreases with the logarithm of the frequency.

3.5.2 Measuring Instruments

The measuring equipment is listed in the section 4 of this test report.

3.5.3 Test Procedures

1. The EUT was placed 0.4 meter from the conducting wall of the shielding room was kept at least 80 centimeters from any other grounded conducting surface.
2. Connect EUT to the power mains through a line impedance stabilization network (LISN).
3. All the support units are connecting to the other LISN.
4. The LISN provides 50 ohm coupling impedance for the measuring instrument.
5. The FCC states that a 50 ohm, 50 microhenry LISN should be used.
6. Both sides of AC line were checked for maximum conducted interference.
7. The frequency range from 150 kHz to 30 MHz was searched.
8. Set the test-receiver system to Peak Detect Function and specified bandwidth with Maximum Hold Mode.

3.5.4 Test Setup

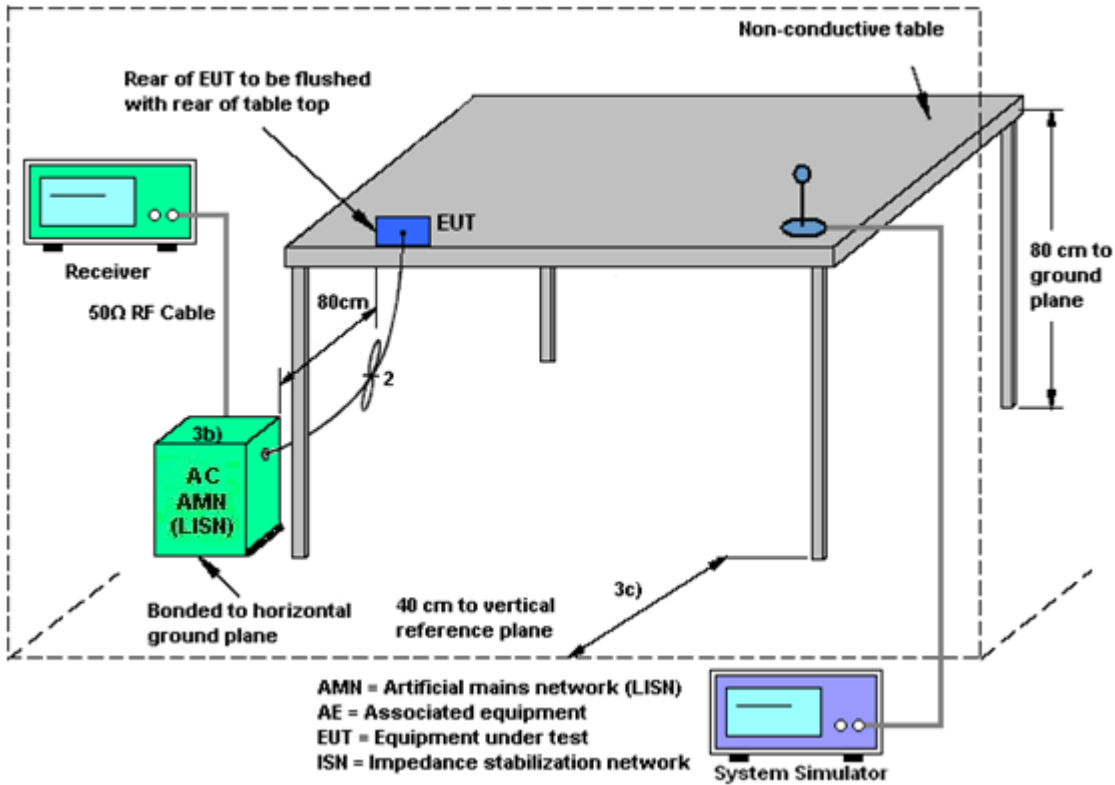

3.5.5 Test Result of AC Conducted Emission

Please refer to Appendix B.



3.6 Automatically Discontinue Transmission

3.6.1 Limit of Automatically Discontinue Transmission

The device shall automatically discontinue transmission in case of either absence of information to transmit or operational failure. These provisions are not intended to preclude the transmission of control or signaling information or the use of repetitive codes used by certain digital technologies to complete frame or burst intervals. Applicants shall include in their application for equipment authorization to describe how this requirement is met.

3.6.2 Measuring Instruments

The measuring equipment is listed in the section 4 of this test report.

3.6.3 Test Result of Automatically Discontinue Transmission

While the EUT is not transmitting any information, the EUT can automatically discontinue transmission and become standby mode for power saving. The EUT can detect the controlling signal of ACK message transmitting from remote device and verify whether it shall resend or discontinue transmission.



3.7 Antenna Requirements

3.7.1 Standard Applicable

If transmitting antenna directional gain is greater than 6 dBi, both the peak transmit power and the peak power spectral density shall be reduced by the amount in dB that the directional gain of the antenna exceeds 6 dBi.

3.7.2 Antenna Anti-Replacement Construction

An embedded-in antenna design is used.

3.7.3 Antenna Gain

The antenna peak gain of EUT is less than 6 dBi. Therefore, it is not necessary to reduce maximum peak output power limit.



4 List of Measuring Equipment

Instrument	Manufacturer	Model No.	Serial No.	Characteristics	Calibration Date	Test Date	Due Date	Remark
Spectrum Analyzer	R&S	FSV40	101040	10Hz~40GHz	Aug. 07, 2018	Jul. 05, 2019	Aug. 06, 2019	Conducted (TH01-KS)
Pulse Power Sensor	Anritsu	MA2411B	0917070	300MHz~40GHz	Jan. 14, 2019	Jul. 05, 2019	Jan. 13, 2020	Conducted (TH01-KS)
Power Meter	Anritsu	ML2495A	1005002	50MHz Bandwidth	Jan. 14, 2019	Jul. 05, 2019	Jan. 13, 2020	Conducted (TH01-KS)
EMI Test Receiver	Keysight	N9038A	MY56400004	3Hz~8.5GHz; Max 30dBm	Oct. 12, 2018	Aug. 02, 2019	Oct. 11, 2019	Radiation (03CH05-KS)
EXA Spectrum Analyzer	Keysight	N9010A	MY55370528	10Hz~44GHz	Oct. 09, 2018	Aug. 02, 2019	Oct. 08, 2019	Radiation (03CH05-KS)
Loop Antenna	R&S	HFH2-Z2	100321	9kHz~30MHz	Oct. 19, 2018	Aug. 02, 2019	Oct. 18, 2019	Radiation (03CH05-KS)
Bilog Antenna	TeseQ	CBL6111D	44483	30MHz~1GHz	Dec. 28, 2018	Aug. 02, 2019	Dec. 27, 2019	Radiation (03CH05-KS)
Double Ridge Horn Antenna	ETS-Lindgren	3117	75959	1GHz~18GHz	Jan. 27, 2019	Aug. 02, 2019	Jan. 26, 2020	Radiation (03CH05-KS)
SHF-EHF Horn	Com-power	AH-840	101070	18GHz~40GHz	Jan. 05, 2019	Aug. 02, 2019	Jan. 04, 2020	Radiation (03CH05-KS)
Amplifier	SONOMA	310N	187289	9KHz~1GHz	Aug. 06, 2018	Aug. 02, 2019	Aug. 05, 2019	Radiation (03CH05-KS)
Amplifier	MITEQ	TTA1840-35-HG	2014749	18~40GHz	Jan. 14, 2019	Aug. 02, 2019	Jan. 13, 2020	Radiation (03CH05-KS)
high gain Amplifier	MITEQ	AMF-7D-0010 1800-30-10P	2025788	1GHz~18GHz	Aug. 17, 2018	Aug. 02, 2019	Aug. 16, 2019	Radiation (03CH05-KS)
Amplifier	Keysight	83017A	MY53270316	500MHz~26.5GHz	Dec. 22, 2018	Aug. 02, 2019	Dec. 21, 2019	Radiation (03CH05-KS)
AC Power Source	Chroma	61601	F104090004	N/A	NCR	Aug. 02, 2019	NCR	Radiation (03CH05-KS)
Turn Table	ChamPro	EM 1000-T	060762-T	0~360 degree	NCR	Aug. 02, 2019	NCR	Radiation (03CH05-KS)
Antenna Mast	ChamPro	EM 1000-A	060762-A	1 m~4 m	NCR	Aug. 02, 2019	NCR	Radiation (03CH05-KS)
EMI Receiver	R&S	ESCI7	100768	9kHz~7GHz;	Apr. 16, 2019	Jul. 09, 2019	Apr. 15, 2020	Conduction (CO01-KS)
AC LISN	MessTec	AN3016	060103	9kHz~30MHz	Oct. 12, 2018	Jul. 09, 2019	Oct. 11, 2019	Conduction (CO01-KS)
AC LISN (for auxiliary equipment)	MessTec	AN3016	060105	9kHz~30MHz	Nov. 19, 2018	Jul. 09, 2019	Nov. 18, 2019	Conduction (CO01-KS)
AC Power Source	Chroma	61602	ABP000000811	AC 0V~300V, 45Hz~1000Hz	Oct. 12, 2018	Jul. 09, 2019	Oct. 11, 2019	Conduction (CO01-KS)

NCR: No Calibration Required



5 Uncertainty of Evaluation

The measurement uncertainties shown below were calculated in accordance with the requirements of ANSI 63.10-2013. All the measurement uncertainty value were shown with a coverage K=2 to indicate 95% level of confidence. The measurement data show herein meets or exceeds the CISPR measurement uncertainty values specified in CISPR 16-4-2 and can be compared directly to specified limit to determine compliance.

Uncertainty of Conducted Emission Measurement (150kHz ~ 30MHz)

Measuring Uncertainty for a Level of Confidence of 95% (U = 2Uc(y))	2.9 dB
---	--------

Uncertainty of Radiated Emission Measurement (30 MHz ~ 1000 MHz)

Measuring Uncertainty for a Level of Confidence of 95% (U = 2Uc(y))	5.0dB
---	-------

Uncertainty of Radiated Emission Measurement (1000 MHz ~ 18000 MHz)

Measuring Uncertainty for a Level of Confidence of 95% (U = 2Uc(y))	5.0dB
---	-------

Uncertainty of Radiated Emission Measurement (18000 MHz ~ 40000 MHz)

Measuring Uncertainty for a Level of Confidence of 95% (U = 2Uc(y))	5.0dB
---	-------



Appendix A. Conducted Test Results

Test Engineer:	Lex wu	Temperature:	21~25	°C
Test Date:	2019/7/5	Relative Humidity:	51~54	%

TEST RESULTS DATA
26dB and 99% OBW

Band I										
Mod.	Data Rate	Ntx	CH.	Freq. (MHz)	99% Bandwidth (MHz)	26 dB Bandwidth (MHz)	IC 99% Bandwidth Power Limit (dBm)	IC 99% Bandwidth EIRP Limit (dBm)		
11a	6Mbps	1	36	5180	17.43	23.78	-	22.41		
11a	6Mbps	1	44	5220	17.43	24.08	-	22.41		
11a	6Mbps	1	48	5240	17.43	23.88	-	22.41		
HT20	MCS0	1	36	5180	18.63	25.03	-	22.70		
HT20	MCS0	1	44	5220	18.63	24.88	-	22.70		
HT20	MCS0	1	48	5240	18.63	25.03	-	22.70		
VHT40	MCS0	1	38	5190	36.36	41.54	-	23.01		
VHT40	MCS0	1	46	5230	36.46	41.54	-	23.01		
VHT80	MCS0	1	42	5210	75.64	83.44	-	23.01		

TEST RESULTS DATA
Average Power Table

FCC Band I										
Mod.	Data Rate	Ntx	CH.	Freq. (MHz)	Duty Factor (dB)	Average Conducted Power (dBm)	FCC Conducted Power Limit (dBm)	DG (dBi)		Pass/Fail
11a	6Mbps	1	36	5180	0.08	15.43	24.00	-1.10		Pass
11a	6Mbps	1	44	5220	0.08	15.60	24.00	-1.10		Pass
11a	6Mbps	1	48	5240	0.08	15.67	24.00	-1.10		Pass
HT20	MCS0	1	36	5180	0.08	14.87	24.00	-1.10		Pass
HT20	MCS0	1	44	5220	0.08	14.89	24.00	-1.10		Pass
HT20	MCS0	1	48	5240	0.08	14.96	24.00	-1.10		Pass
HT40	MCS0	1	38	5190	0.16	12.93	24.00	-1.10		Pass
HT40	MCS0	1	46	5230	0.16	13.06	24.00	-1.10		Pass
VHT20	MCS0	1	36	5180	0.10	14.39	24.00	-1.10		Pass
VHT20	MCS0	1	44	5220	0.10	14.47	24.00	-1.10		Pass
VHT20	MCS0	1	48	5240	0.10	14.69	24.00	-1.10		Pass
VHT40	MCS0	1	38	5190	0.16	12.88	24.00	-1.10		Pass
VHT40	MCS0	1	46	5230	0.16	13.50	24.00	-1.10		Pass
VHT80	MCS0	1	42	5210	0.31	10.18	24.00	-1.10		Pass

TEST RESULTS DATA
Power Spectral Density

FCC Band I										
Mod.	Data Rate	NTX	CH.	Freq. (MHz)	Duty Factor (dB)	Average Power Density (dBm/MHz)	Average PSD Limit (dBm/MHz)	DG (dBi)	-	Pass/Fail
11a	6Mbps	1	36	5180	0.08	5.30	11.00	-1.10		Pass
11a	6Mbps	1	44	5220	0.08	5.29	11.00	-1.10		Pass
11a	6Mbps	1	48	5240	0.08	5.07	11.00	-1.10		Pass
HT20	MCS0	1	36	5180	0.08	4.85	11.00	-1.10		Pass
HT20	MCS0	1	44	5220	0.08	5.26	11.00	-1.10		Pass
HT20	MCS0	1	48	5240	0.08	5.52	11.00	-1.10		Pass
VHT40	MCS0	1	38	5190	0.16	0.23	11.00	-1.10		Pass
VHT40	MCS0	1	46	5230	0.16	1.06	11.00	-1.10		Pass
VHT80	MCS0	1	42	5210	0.31	-5.22	11.00	-1.10		Pass

TEST RESULTS DATA
26dB and 99% OBW

Band II										
Mod.	Data Rate	NTX	CH.	Freq. (MHz)	99% Bandwidth (MHz)	26 dB Bandwidth (MHz)	IC 99% Bandwidth Power Limit (dBm)	IC 99% Bandwidth EIRP Limit (dBm)	FCC 26dB Bandwidth Power Limit (dBm)	Note
11a	6M bps	1	52	5260	17.43	24.18	23.41	29.41	23.98	
11a	6M bps	1	60	5300	17.53	23.53	23.44	29.44	23.98	
11a	6M bps	1	64	5320	17.43	23.73	23.41	29.41	23.98	
HT20	MCS 0	1	52	5260	18.58	25.03	23.69	29.69	23.98	
HT20	MCS 0	1	60	5300	18.68	24.68	23.71	29.71	23.98	
HT20	MCS 0	1	64	5320	18.58	24.78	23.69	29.69	23.98	
VHT40	MCS 0	1	54	5270	36.36	41.54	23.98	30.00	23.98	
VHT40	MCS 0	1	62	5310	36.46	41.54	23.98	30.00	23.98	
VHT80	MCS 0	1	58	5290	75.76	83.76	23.98	30.00	23.98	

TEST RESULTS DATA
Average Power Table

FCC Band II										
Mod.	Data Rate	NTX	CH.	Freq. (MHz)	Duty Factor (dB)	Average Conducted Power (dBm)	FCC Conducted Power Limit (dBm)	DG (dBi)	EIRP Power Limit (dBm)	Pass/Fail
11a	6M bps	1	52	5260	0.08	15.12	23.98	-0.40	26.99	Pass
11a	6M bps	1	60	5300	0.08	15.23	23.98	-0.40	26.99	Pass
11a	6M bps	1	64	5320	0.08	15.56	23.98	-0.40	26.99	Pass
HT20	MCS 0	1	52	5260	0.08	14.97	23.98	-0.40	26.99	Pass
HT20	MCS 0	1	60	5300	0.08	15.20	23.98	-0.40	26.99	Pass
HT20	MCS 0	1	64	5320	0.08	15.38	23.98	-0.40	26.99	Pass
HT40	MCS 0	1	54	5270	0.16	13.03	23.98	-0.40	26.99	Pass
HT40	MCS 0	1	62	5310	0.16	13.27	23.98	-0.40	26.99	Pass
VHT20	MCS 0	1	52	5260	0.10	14.59	23.98	-0.40	26.99	Pass
VHT20	MCS 0	1	60	5300	0.10	14.77	23.98	-0.40	26.99	Pass
VHT20	MCS 0	1	64	5320	0.10	15.05	23.98	-0.40	26.99	Pass
VHT40	MCS 0	1	54	5270	0.16	13.49	23.98	-0.40	26.99	Pass
VHT40	MCS 0	1	62	5310	0.16	13.75	23.98	-0.40	26.99	Pass
VHT80	MCS 0	1	58	5290	0.31	10.16	23.98	-0.40	26.99	Pass

TEST RESULTS DATA
Power Spectral Density

Band II										
Mod.	Data Rate	NTX	CH.	Freq. (MHz)	Duty Factor (dB)	Average Power Density (dBm/MHz)	Average PSD Limit (dBm/MHz)	DG (dBi)		Pass/Fail
11a	6M bps	1	52	5260	0.08	5.47	11.00	-0.40		Pass
11a	6M bps	1	60	5300	0.08	4.96	11.00	-0.40		Pass
11a	6M bps	1	64	5320	0.08	5.70	11.00	-0.40		Pass
HT20	MCS 0	1	52	5260	0.08	4.70	11.00	-0.40		Pass
HT20	MCS 0	1	60	5300	0.08	5.23	11.00	-0.40		Pass
HT20	MCS 0	1	64	5320	0.08	5.50	11.00	-0.40		Pass
VHT40	MCS 0	1	54	5270	0.16	0.07	11.00	-0.40		Pass
VHT40	MCS 0	1	62	5310	0.16	0.96	11.00	-0.40		Pass
VHT80	MCS 0	1	58	5290	0.31	-5.92	11.00	-0.40		Pass

TEST RESULTS DATA
26dB and 99% OBW

Band III										
Mod.	Data Rate	NTX	CH.	Freq. (MHz)	99% Bandwidth (MHz)	26 dB Bandwidth (MHz)	IC 99% Bandwidth Power Limit (dBm)	IC 99% Bandwidth EIRP Limit (dBm)	FCC 26dB Bandwidth Power Limit (dBm)	Note
11a	6M bps	1	100	5500	17.43	23.28	23.41	29.41	23.98	
11a	6M bps	1	116	5580	17.43	23.88	23.41	29.41	23.98	
11a	6M bps	1	140	5700	17.48	23.78	23.43	29.43	23.98	
11a	6Mbps	1	144	5720	17.48	23.83	23.43	29.43	23.98	
HT20	MCS 0	1	100	5500	18.63	23.88	23.70	29.70	23.98	
HT20	MCS 0	1	116	5580	18.63	24.83	23.70	29.70	23.98	
HT20	MCS 0	1	140	5700	18.68	24.83	23.71	29.71	23.98	
HT20	MCS0	1	144	5720	18.63	24.83	23.70	29.70	23.98	
VHT40	MCS 0	1	102	5510	36.56	41.72	23.98	30.00	23.98	
VHT40	MCS 0	1	110	5550	36.46	41.54	23.98	30.00	23.98	
VHT40	MCS 0	1	134	5670	36.36	41.63	23.98	30.00	23.98	
VHT40	MCS0	1	142	5710	36.36	41.63	23.98	30.00	23.98	
VHT80	MCS 0	1	106	5530	75.64	83.12	23.98	30.00	23.98	
VHT80	MCS 0	1	122	5610	75.76	83.92	23.98	30.00	23.98	
VHT80	MCS0	1	138	5690	75.64	83.76	23.98	30.00	23.98	

TEST RESULTS DATA
Average Power Table

FCC Band III										
Mod.	Data Rate	NTX	CH.	Freq. (MHz)	Duty Factor (dB)	Average Conducted Power (dBm)	FCC Conducted Power Limit (dBm)	DG (dBi)	EIRP Power Limit (dBm)	Pass/Fail
11a	6M bps	1	100	5500	0.08	15.31	23.98	-0.30	26.99	Pass
11a	6M bps	1	116	5580	0.08	15.27	23.98	-0.30	26.99	Pass
11a	6M bps	1	140	5700	0.08	14.89	23.98	-0.30	26.99	Pass
11a	6Mbps	1	144	5720	0.08	15.16	23.98	-0.30	26.99	Pass
HT20	MCS 0	1	100	5500	0.08	15.07	23.98	-0.30	26.99	Pass
HT20	MCS 0	1	116	5580	0.08	15.10	23.98	-0.30	26.99	Pass
HT20	MCS 0	1	140	5700	0.08	14.40	23.98	-0.30	26.99	Pass
HT20	MCS 0	1	144	5720	0.08	14.96	23.98	-0.30	26.99	Pass
HT40	MCS 0	1	102	5510	0.16	12.62	23.98	-0.30	26.99	Pass
HT40	MCS 0	1	110	5550	0.16	12.90	23.98	-0.30	26.99	Pass
HT40	MCS 0	1	134	5670	0.16	12.32	23.98	-0.30	26.99	Pass
HT40	MCS 0	1	142	5710	0.16	12.48	23.98	-0.30	26.99	Pass
VHT20	MCS 0	1	100	5500	0.10	14.27	23.98	-0.30	26.99	Pass
VHT20	MCS 0	1	116	5580	0.10	14.26	23.98	-0.30	26.99	Pass
VHT20	MCS 0	1	140	5700	0.10	14.20	23.98	-0.30	26.99	Pass
VHT20	MCS0	1	144	5720	0.10	14.40	23.98	-0.30	26.99	Pass
VHT40	MCS 0	1	102	5510	0.16	12.98	23.98	-0.30	26.99	Pass
VHT40	MCS 0	1	110	5550	0.16	13.35	23.98	-0.30	26.99	Pass
VHT40	MCS 0	1	134	5670	0.16	12.80	23.98	-0.30	26.99	Pass
VHT40	MCS0	1	142	5710	0.16	12.96	23.98	-0.30	26.99	Pass
VHT80	MCS 0	1	106	5530	0.31	10.34	23.98	-0.30	26.99	Pass
VHT80	MCS 0	1	122	5610	0.31	10.00	23.98	-0.30	26.99	Pass
VHT80	MCS0	1	138	5690	0.31	10.19	23.98	-0.30	26.99	Pass

TEST RESULTS DATA
Power Spectral Density

Band III										
Mod.	Data Rate	NTX	CH.	Freq. (MHz)	Duty Factor (dB)	Average Power Density (dBm/MHz)	Average PSD Limit (dBm/MHz)	DG (dBi)		Pass/Fail
11a	6M bps	1	100	5500	0.08	6.02	11.00	-0.30		Pass
11a	6M bps	1	116	5580	0.08	5.78	11.00	-0.30		Pass
11a	6M bps	1	140	5700	0.08	4.78	11.00	-0.30		Pass
11a	6Mbps	1	144	5720	0.08	5.47	11.00	-0.30		Pass
HT20	MCS 0	1	100	5500	0.08	5.03	11.00	-0.30		Pass
HT20	MCS 0	1	116	5580	0.08	5.35	11.00	-0.30		Pass
HT20	MCS 0	1	140	5700	0.08	4.58	11.00	-0.30		Pass
HT20	MCS0	1	144	5720	0.08	4.65	11.00	-0.30		Pass
VHT40	MCS 0	1	102	5510	0.16	0.18	11.00	-0.30		Pass
VHT40	MCS 0	1	110	5550	0.16	0.74	11.00	-0.30		Pass
VHT40	MCS 0	1	134	5670	0.16	0.41	11.00	-0.30		Pass
VHT40	MCS0	1	142	5710	0.16	-0.19	11.00	-0.30		Pass
VHT80	MCS 0	1	106	5530	0.31	-5.68	11.00	-0.30		Pass
VHT80	MCS 0	1	122	5610	0.31	-6.09	11.00	-0.30		Pass
VHT80	MCS0	1	138	5690	0.31	-6.29	11.00	-0.30		Pass



Appendix B. AC Conducted Emission Test Results

Test Engineer :	Amos Zhang	Temperature :	25.3~26.2 °C
		Relative Humidity :	38~40%
Test Voltage :	120Vac / 60Hz	Phase :	Line

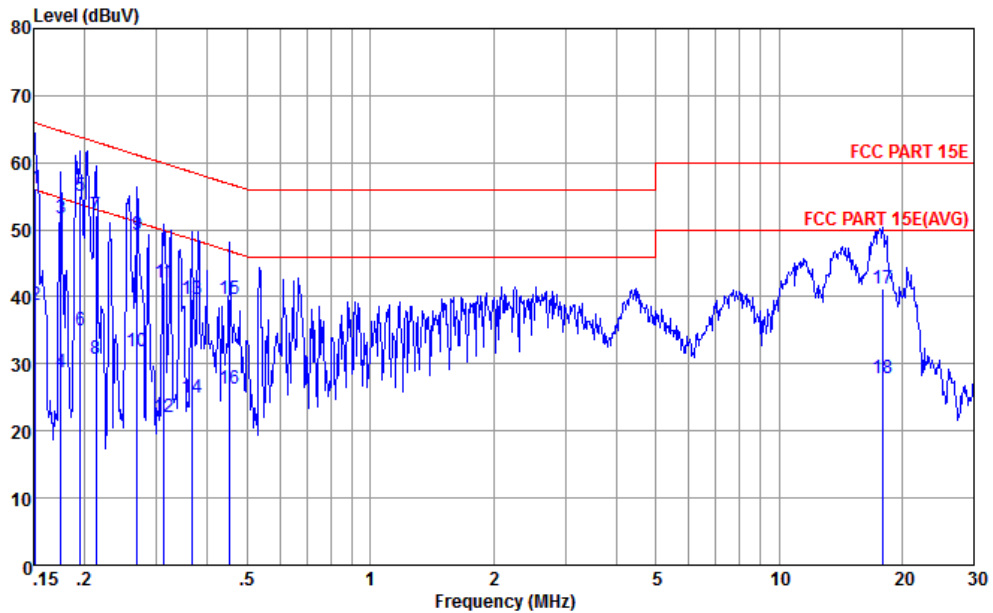

Site : CO01-KS
Condition : FCC PART 15E LISN-L-181119-060105 LINE

	Freq	Level	Over	Limit	Read	LISN	Cable	Remark
	MHz	dBuV	Limit	Line	Level	Factor	Loss	
			dB	dBuV	dBuV	dB	dB	
1	0.152	56.07	-9.84	65.91	45.50	0.09	10.48	QP
2	0.152	38.77	-17.14	55.91	28.20	0.09	10.48	Average
3	0.175	51.72	-13.00	64.72	41.19	0.11	10.42	QP
4	0.175	28.72	-26.00	54.72	18.19	0.11	10.42	Average
5 *	0.195	54.99	-8.81	63.80	44.50	0.12	10.37	QP
6	0.195	34.99	-18.81	53.80	24.50	0.12	10.37	Average
7	0.213	52.08	-11.02	63.10	41.60	0.12	10.36	QP
8	0.213	30.78	-22.32	53.10	20.30	0.12	10.36	Average
9	0.269	49.36	-11.80	61.16	38.90	0.14	10.32	QP
10	0.269	31.76	-19.40	51.16	21.30	0.14	10.32	Average
11	0.313	42.05	-17.83	59.88	31.61	0.14	10.30	QP
12	0.313	22.05	-27.83	49.88	11.61	0.14	10.30	Average
13	0.365	39.73	-18.88	58.61	29.30	0.15	10.28	QP
14	0.365	24.93	-23.68	48.61	14.50	0.15	10.28	Average
15	0.454	39.71	-17.09	56.80	29.30	0.16	10.25	QP
16	0.454	26.31	-20.49	46.80	15.90	0.16	10.25	Average
17	17.944	41.27	-18.73	60.00	30.60	0.21	10.46	QP
18	17.944	27.77	-22.23	50.00	17.10	0.21	10.46	Average



Test Engineer :	Amos Zhang	Temperature :	25.3~26.2 °C
		Relative Humidity :	38~40%
Test Voltage :	120Vac / 60Hz	Phase :	Neutral

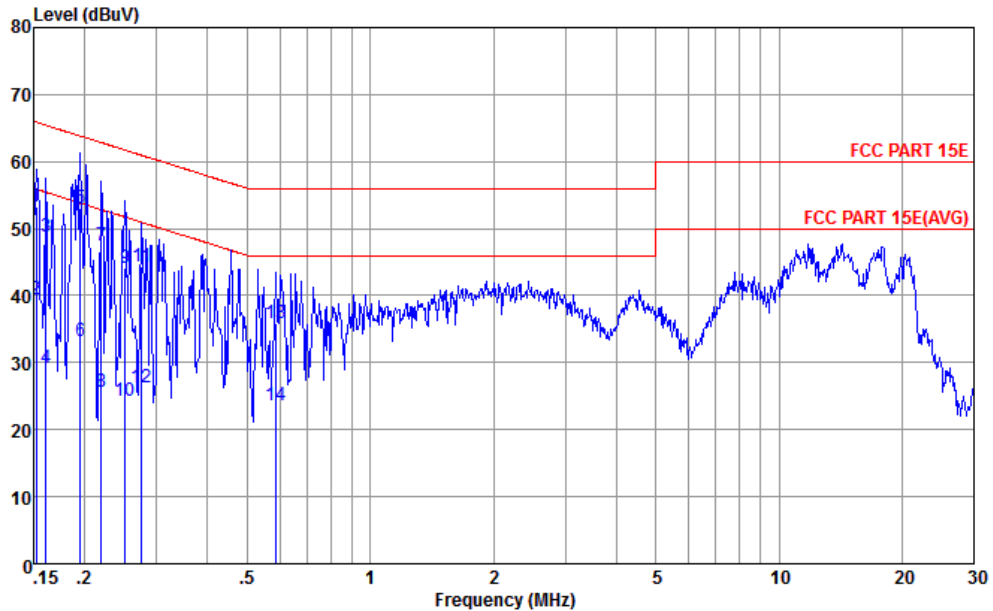

Site : CO01-KS
 Condition : FCC PART 15E LISN-N-181119-060105 NEUTRAL

	Freq	Level	Over	Limit	Read	LISN	Cable	Remark
	MHz	dBuV	Limit	Line	Level	Factor	Loss	
			dB	dBuV	dBuV	dB	dB	
1	0.152	53.25	-12.62	65.87	42.60	0.18	10.47	QP
2	0.152	39.55	-16.32	55.87	28.90	0.18	10.47	Average
3	0.161	48.83	-16.60	65.43	38.20	0.18	10.45	QP
4	0.161	29.23	-26.20	55.43	18.60	0.18	10.45	Average
5 *	0.195	53.05	-10.75	63.80	42.51	0.17	10.37	QP
6	0.195	33.15	-20.65	53.80	22.61	0.17	10.37	Average
7	0.220	47.42	-15.41	62.83	36.90	0.17	10.35	QP
8	0.220	25.72	-27.11	52.83	15.20	0.17	10.35	Average
9	0.251	44.10	-17.63	61.73	33.60	0.17	10.33	QP
10	0.251	24.30	-27.43	51.73	13.80	0.17	10.33	Average
11	0.276	44.28	-16.66	60.94	33.80	0.16	10.32	QP
12	0.276	26.28	-24.66	50.94	15.80	0.16	10.32	Average
13	0.585	35.88	-20.12	56.00	25.50	0.14	10.24	QP
14	0.585	23.68	-22.32	46.00	13.30	0.14	10.24	Average



Appendix C. Radiated Spurious Emission

Band 1 - 5150~5250MHz

WIFI 802.11a (Band Edge @ 3m)

WIFI	Note	Frequency	Level	Over	Limit	Read	Antenna	Cable	Preamp	Ant	Table	Peak	Pol.
Ant.				Limit	Line	Level	Factor	Loss	Factor	Pos	Pos	Avg.	
1		(MHz)	(dBμV/m)	(dB)	(dBμV/m)	(dBμV)	(dB/m)	(dB)	(dB)	(cm)	(deg)	(P/A)	(H/V)
802.11a CH 36 5180MHz		5148.96	61	-13	74	49.47	35.06	8.14	31.67	100	112	P	H
		5149.44	49.78	-4.22	54	38.25	35.06	8.14	31.67	100	112	A	H
	*	5176	108.07	-	-	96.48	35.08	8.17	31.66	100	112	P	H
		5176	99.88	-	-	88.29	35.08	8.17	31.66	100	112	A	H
		5147.68	60.63	-13.37	74	49.1	35.06	8.14	31.67	186	167	P	V
		5149.98	49.61	-4.39	54	38.08	35.06	8.14	31.67	186	167	A	V
	*	5182	108.87	-	-	97.28	35.08	8.17	31.66	186	167	P	V
		5182	100.85	-	-	89.26	35.08	8.17	31.66	186	167	A	V
Remark	<ol style="list-style-type: none"> No other spurious found. All results are PASS against Peak and Average limit line. 												



band 1 5150~5250MHz
WIFI 802.11a (Harmonic @ 3m)

Table with 14 columns: WIFI, Note, Frequency, Level, Over, Limit, Read, Antenna, Cable, Preamp, Ant, Table, Peak, Pol. It contains test results for three channels (36, 44, 48) across various frequencies and antenna positions.



band 1 5150~5250MHz
WIFI 802.11n HT20 (Band Edge @ 3m)

Table with 14 columns: WIFI, Note, Frequency, Level, Over, Limit, Read, Antenna, Cable, Preamp, Ant, Table, Peak, Pol. It contains test data for 802.11n HT20 CH 36 5180MHz and a Remark section.



band 1 5150~5250MHz
WIFI 802.11n HT20 (Harmonic @ 3m)

WIFI	Note	Frequency	Level	Over	Limit	Read	Antenna	Cable	Preamp	Ant	Table	Peak	Pol.
Ant.				Limit	Line	Level	Factor	Loss	Factor	Pos	Pos	Avg.	
1		(MHz)	(dBμV/m)	(dB)	(dBμV/m)	(dBμV)	(dB/m)	(dB)	(dB)	(cm)	(deg)	(P/A)	(H/V)
802.11n		10360	45.83	-22.47	68.3	59.55	37.47	11.87	63.06	100	360	P	H
HT20		15528	52.17	-21.83	74	59.39	40.77	15.27	63.26	212	268	P	H
CH 36		15528	42.33	-11.67	54	49.55	40.77	15.27	63.26	212	268	A	H
5180MHz		10360	44.03	-24.27	68.3	57.75	37.47	11.87	63.06	100	360	P	V
802.11n		10440	45.01	-23.29	68.3	58.62	37.5	11.93	63.04	100	360	P	H
HT20		15654	58.54	-15.46	74	65.72	40.83	15.31	63.32	236	177	P	H
CH 44		15654	46.23	-7.77	54	53.41	40.83	15.31	63.32	236	177	A	H
5220MHz		10440	43.69	-24.61	68.3	57.3	37.5	11.93	63.04	100	360	P	V
802.11n		10480	43.78	-24.52	68.3	57.31	37.53	11.97	63.03	100	360	P	H
HT20		15726	54.22	-19.78	74	61.36	40.86	15.34	63.34	208	187	P	H
CH 48		15726	45.52	-8.48	54	52.66	40.86	15.34	63.34	208	187	A	H
5240MHz		10480	43	-25.3	68.3	56.53	37.53	11.97	63.03	100	360	P	V
Remark	1. No other spurious found. 2. All results are PASS against Peak and Average limit line.												



band 1 5150~5250MHz
WIFI 802.11ac VHT40 (Band Edge @ 3m)

Table with 14 columns: WIFI, Note, Frequency, Level, Over, Limit, Read, Antenna, Cable, Preamp, Ant, Table, Peak, Pol. It contains test data for 802.11ac VHT40 CH 38 5190MHz and a Remark section.



band 1 5150~5250MHz

WIFI 802.11ac VHT40 (Harmonic @ 3m)

WIFI	Note	Frequency	Level	Over	Limit	Read	Antenna	Cable	Preamp	Ant	Table	Peak	Pol.
Ant.				Limit	Line	Level	Factor	Loss	Factor	Pos	Pos	Avg.	
1		(MHz)	(dBμV/m)	(dB)	(dBμV/m)	(dBμV)	(dB/m)	(dB)	(dB)	(cm)	(deg)	(P/A)	(H/V)
802.11ac VHT40 CH 38 5190MHz		10380	42.1	-26.2	68.3	55.77	37.48	11.9	63.05	100	360	P	H
802.11ac VHT40 CH 46 5230MHz		10460	42.69	-25.61	68.3	56.25	37.51	11.97	63.04	100	360	P	H
		10460	42.19	-26.11	68.3	55.75	37.51	11.97	63.04	100	0	P	V
Remark	1. No other spurious found. 2. All results are PASS against Peak and Average limit line.												



band 1 5150~5250MHz
WIFI 802.11ac VHT80 (Band Edge @ 3m)

Table with 14 columns: WIFI, Note, Frequency, Level, Over, Limit, Read, Antenna, Cable, Preamp, Ant, Table, Peak, Pol. It contains test data for 802.11ac VHT80 CH 42 5210MHz and a Remark section.



band 1 5150~5250MHz

WIFI 802.11ac VHT80 (Harmonic @ 3m)

WIFI	Note	Frequency	Level	Over	Limit	Read	Antenna	Cable	Preamp	Ant	Table	Peak	Pol.
Ant.				Limit	Line	Level	Factor	Loss	Factor	Pos	Pos	Avg.	
1		(MHz)	(dBμV/m)	(dB)	(dBμV/m)	(dBμV)	(dB/m)	(dB)	(dB)	(cm)	(deg)	(P/A)	(H/V)
802.11ac VHT80		10420	42.03	-26.27	68.3	55.65	37.5	11.93	63.05	100	360	P	H
CH 42 5210MHz		10420	42.99	-25.31	68.3	56.61	37.5	11.93	63.05	100	360	P	V

Remark	1. No other spurious found. 2. All results are PASS against Peak and Average limit line.												
--------	---	--	--	--	--	--	--	--	--	--	--	--	--



Band 2 - 5250~5350MHz
WIFI 802.11a (Band Edge @ 3m)

Table with 14 columns: WIFI, Note, Frequency, Level, Over, Limit, Read, Antenna, Cable, Preamp, Ant, Table, Peak, Pol. It contains 8 rows of test data for 802.11a CH 64 at 5320MHz.

Remark
1. No other spurious found.
2. All results are PASS against Peak and Average limit line.



band 2 5250~5350MHz
WIFI 802.11a (Harmonic @ 3m)

WIFI	Note	Frequency	Level	Over	Limit	Read	Antenna	Cable	Preamp	Ant	Table	Peak	Pol.
Ant.				Limit	Line	Level	Factor	Loss	Factor	Pos	Pos	Avg.	
1		(MHz)	(dBμV/m)	(dB)	(dBμV/m)	(dBμV)	(dB/m)	(dB)	(dB)	(cm)	(deg)	(P/A)	(H/V)
802.11a		10520	44.59	-23.71	68.3	58.08	37.54	12	63.03	100	360	P	H
CH 52 5260MHz		10520	41.55	-26.75	68.3	55.04	37.54	12	63.03	100	0	P	V
802.11a		10600	44	-30	74	57.37	37.58	12.06	63.01	100	360	P	H
CH 60 5300MHz		10600	41.32	-32.68	74	54.69	37.58	12.06	63.01	100	0	P	V
802.11a		10640	42.87	-31.13	74	56.18	37.6	12.09	63	100	360	P	H
CH 64 5320MHz		10640	43.31	-30.69	74	56.62	37.6	12.09	63	100	360	P	V
Remark	1. No other spurious found. 2. All results are PASS against Peak and Average limit line.												



band 2 5250~5350MHz
WIFI 802.11n HT20 (Band Edge @ 3m)

Table with 14 columns: WIFI, Note, Frequency, Level, Over, Limit, Read, Antenna, Cable, Preamp, Ant, Table, Peak, Pol. It contains test results for 802.11n HT20 CH 64 5320MHz across various frequencies and parameters.



band 2 5250~5350MHz

WIFI 802.11n HT20 (Harmonic @ 3m)

WIFI	Note	Frequency	Level	Over	Limit	Read	Antenna	Cable	Preamp	Ant	Table	Peak	Pol.
Ant.				Limit	Line	Level	Factor	Loss	Factor	Pos	Pos	Avg.	
1		(MHz)	(dBμV/m)	(dB)	(dBμV/m)	(dBμV)	(dB/m)	(dB)	(dB)	(cm)	(deg)	(P/A)	(H/V)
802.11n HT20 CH 52 5260MHz		10520	44.55	-23.75	68.3	58.04	37.54	12	63.03	100	360	P	H
		10520	42.6	-25.7	68.3	56.09	37.54	12	63.03	100	0	P	V
802.11n HT20 CH 60 5300MHz		10600	44.4	-29.6	74	57.77	37.58	12.06	63.01	100	0	P	H
		15900	53.51	-20.49	74	60.59	40.95	15.39	63.42	268	177	P	H
		15900	41.62	-12.38	54	48.7	40.95	15.39	63.42	268	177	A	H
		10600	43.56	-30.44	74	56.93	37.58	12.06	63.01	300	0	P	V
802.11n HT20 CH 64 5320MHz		10640	44.58	-29.42	74	57.89	37.6	12.09	63	100	360	P	H
		10640	42.86	-31.14	74	56.17	37.6	12.09	63	100	360	P	V
Remark	1. No other spurious found. 2. All results are PASS against Peak and Average limit line.												



band 2 5250~5350MHz
WIFI 802.11ac VHT40 (Band Edge @ 3m)

WIFI	Note	Frequency	Level	Over	Limit	Read	Antenna	Cable	Preamp	Ant	Table	Peak	Pol.
Ant.				Limit	Line	Level	Factor	Loss	Factor	Pos	Pos	Avg.	
1		(MHz)	(dBμV/m)	(dB)	(dBμV/m)	(dBμV)	(dB/m)	(dB)	(dB)	(cm)	(deg)	(P/A)	(H/V)
802.11ac VHT40 CH 62 5310MHz		5116	53.81	-20.19	74	42.32	35.05	8.14	31.7	100	113	P	H
		5128.64	44.19	-9.81	54	32.68	35.06	8.14	31.69	100	113	A	H
	*	5320	99.17	-	-	87.34	35.15	8.27	31.59	100	113	P	H
		5320	91.62	-	-	79.79	35.15	8.27	31.59	100	113	A	H
		5355.2	56.39	-17.61	74	44.5	35.16	8.3	31.57	100	113	P	H
		5350	48	-6	54	36.11	35.16	8.3	31.57	100	113	A	H
		5125.28	54.18	-19.82	74	42.67	35.06	8.14	31.69	189	165	P	V
		5102.24	44.35	-9.65	54	32.91	35.04	8.1	31.7	189	165	A	V
	*	5314	101.8	-	-	89.97	35.15	8.27	31.59	189	165	P	V
		5314	94.11	-	-	82.28	35.15	8.27	31.59	189	165	A	V
	5351	59.23	-14.77	74	47.34	35.16	8.3	31.57	189	165	P	V	
	5350.3	49.94	-4.06	54	38.05	35.16	8.3	31.57	189	165	A	V	
Remark	1. No other spurious found. 2. All results are PASS against Peak and Average limit line.												



band 2 5250~5350MHz

WIFI 802.11ac VHT40 (Harmonic @ 3m)

WIFI	Note	Frequency	Level	Over	Limit	Read	Antenna	Cable	Preamp	Ant	Table	Peak	Pol.
Ant.				Limit	Line	Level	Factor	Loss	Factor	Pos	Pos	Avg.	
1		(MHz)	(dBμV/m)	(dB)	(dBμV/m)	(dBμV)	(dB/m)	(dB)	(dB)	(cm)	(deg)	(P/A)	(H/V)
802.11ac VHT40		10540	44.26	-24.04	68.3	57.7	37.55	12.03	63.02	100	360	P	H
CH 54 5270MHz		10540	42.54	-25.76	68.3	55.98	37.55	12.03	63.02	100	360	P	V
802.11ac VHT40		10620	41.49	-32.51	74	54.82	37.59	12.09	63.01	100	360	P	H
CH 62 5310MHz		10620	43.21	-30.79	74	56.54	37.59	12.09	63.01	100	360	P	V
Remark	1. No other spurious found. 2. All results are PASS against Peak and Average limit line.												



band 2 5250~5350MHz
WIFI 802.11ac VHT80 (Band Edge @ 3m)

WIFI	Note	Frequency	Level	Over	Limit	Read	Antenna	Cable	Preamp	Ant	Table	Peak	Pol.
Ant.				Limit	Line	Level	Factor	Loss	Factor	Pos	Pos	Avg.	
1		(MHz)	(dBμV/m)	(dB)	(dBμV/m)	(dBμV)	(dB/m)	(dB)	(dB)	(cm)	(deg)	(P/A)	(H/V)
802.11ac VHT80 CH 58 5290MHz		5130.88	53.77	-20.23	74	42.26	35.06	8.14	31.69	100	113	P	H
		5126.24	44.71	-9.29	54	33.2	35.06	8.14	31.69	100	113	A	H
	*	5278	95.49	-	-	83.72	35.13	8.25	31.61	100	113	P	H
		5278	87.86	-	-	76.09	35.13	8.25	31.61	100	113	A	H
		5359.4	58.15	-15.85	74	46.26	35.16	8.3	31.57	100	113	P	H
		5350.1	49.39	-4.61	54	37.5	35.16	8.3	31.57	100	113	A	H
		5122.24	54.34	-19.66	74	42.84	35.05	8.14	31.69	192	166	P	V
		5102.72	44.7	-9.3	54	33.26	35.04	8.1	31.7	192	166	A	V
	*	5278	97.4	-	-	85.63	35.13	8.25	31.61	192	166	P	V
		5278	89.86	-	-	78.09	35.13	8.25	31.61	192	166	A	V
		5351.1	59.51	-14.49	74	47.62	35.16	8.3	31.57	192	166	P	V
	5350.5	50.41	-3.59	54	38.52	35.16	8.3	31.57	192	166	A	V	
Remark	1. No other spurious found. 2. All results are PASS against Peak and Average limit line.												



band 2 5250~5350MHz

WIFI 802.11ac VHT80 (Harmonic @ 3m)

WIFI	Note	Frequency	Level	Over	Limit	Read	Antenna	Cable	Preamp	Ant	Table	Peak	Pol.
Ant.				Limit	Line	Level	Factor	Loss	Factor	Pos	Pos	Avg.	
1		(MHz)	(dBμV/m)	(dB)	(dBμV/m)	(dBμV)	(dB/m)	(dB)	(dB)	(cm)	(deg)	(P/A)	(H/V)
802.11ac VHT80		10580	42.88	-25.42	68.3	56.25	37.58	12.06	63.01	100	360	P	H
CH 58 5290MHz		10580	42.25	-26.05	68.3	55.62	37.58	12.06	63.01	100	360	P	V
Remark	1. No other spurious found. 2. All results are PASS against Peak and Average limit line.												



Band 3 - 5470~5725MHz
WIFI 802.11a (Band Edge @ 3m)

WIFI	Note	Frequency	Level	Over	Limit	Read	Antenna	Cable	Preamp	Ant	Table	Peak	Pol.
Ant.				Limit	Line	Level	Factor	Loss	Factor	Pos	Pos	Avg.	
1		(MHz)	(dBμV/m)	(dB)	(dBμV/m)	(dBμV)	(dB/m)	(dB)	(dB)	(cm)	(deg)	(P/A)	(H/V)
802.11a CH 100 5500MHz		5456.4	54.57	-19.43	74	42.51	35.21	8.36	31.51	100	109	P	H
		5469.2	57.88	-10.42	68.3	45.77	35.22	8.4	31.51	100	109	P	H
		5459.92	44.67	-9.33	54	32.61	35.21	8.36	31.51	100	109	A	H
	*	5500	104.97	-	-	92.83	35.24	8.4	31.5	100	109	P	H
		5500	98.61	-	-	86.47	35.24	8.4	31.5	100	109	A	H
		5459.6	56.52	-17.48	74	44.46	35.21	8.36	31.51	211	174	P	V
		5468.72	60.55	-7.75	68.3	48.44	35.22	8.4	31.51	211	174	P	V
		5459.98	47.69	-6.31	54	35.63	35.21	8.36	31.51	211	174	A	V
	*	5500	109.65	-	-	97.51	35.24	8.4	31.5	211	174	P	V
		5500	102.35	-	-	90.21	35.24	8.4	31.5	211	174	A	V
802.11a CH 140 5700MHz	*	5698	105.47	-	-	93.13	35.25	8.58	31.49	100	114	P	H
		5698	98.84	-	-	86.5	35.25	8.58	31.49	100	114	A	H
		5726.12	60.46	-7.84	68.3	48.15	35.22	8.61	31.52	100	114	P	H
	*	5698	111.39	-	-	99.05	35.25	8.58	31.49	212	163	P	V
		5698	103.91	-	-	91.57	35.25	8.58	31.49	212	163	A	V
		5726.2	64.95	-3.35	68.3	52.64	35.22	8.61	31.52	212	163	P	V
Remark	1. No other spurious found. 2. All results are PASS against Peak and Average limit line.												



band 3 - 5470~5725MHz
WIFI 802.11a (Harmonic @ 3m)

WIFI	Note	Frequency	Level	Over	Limit	Read	Antenna	Cable	Preamp	Ant	Table	Peak	Pol.
Ant.				Limit	Line	Level	Factor	Loss	Factor	Pos	Pos	Avg.	
1		(MHz)	(dBμV/m)	(dB)	(dBμV/m)	(dBμV)	(dB/m)	(dB)	(dB)	(cm)	(deg)	(P/A)	(H/V)
802.11a CH 100		11000	42.51	-31.49	74	55.31	37.76	12.37	62.93	100	360	P	H
5500MHz		11000	42.05	-31.95	74	54.85	37.76	12.37	62.93	100	360	P	V
802.11a CH 116		11160	42.25	-31.75	74	54.8	37.84	12.51	62.9	100	360	P	H
5580MHz		11160	43.25	-30.75	74	55.8	37.84	12.51	62.9	100	360	P	V
802.11a CH 140		11400	42.53	-31.47	74	54.75	37.95	12.68	62.85	100	360	P	H
5700MHz		11400	42.12	-31.88	74	54.34	37.95	12.68	62.85	100	360	P	V
Remark	1. No other spurious found. 2. All results are PASS against Peak and Average limit line.												



band 3 - 5470~5725MHz
WIFI 802.11n HT20 (Band Edge @ 3m)

WIFI	Note	Frequency	Level	Over	Limit	Read	Antenna	Cable	Preamp	Ant	Table	Peak	Pol.
Ant.				Limit	Line	Level	Factor	Loss	Factor	Pos	Pos	Avg.	
1		(MHz)	(dBμV/m)	(dB)	(dBμV/m)	(dBμV)	(dB/m)	(dB)	(dB)	(cm)	(deg)	(P/A)	(H/V)
802.11n HT20 CH 100 5500MHz		5437.84	52.63	-21.37	74	40.6	35.2	8.36	31.53	100	108	P	H
		5469.04	57.68	-10.62	68.3	45.57	35.22	8.4	31.51	100	108	P	H
		5459.98	44.27	-9.73	54	32.21	35.21	8.36	31.51	100	108	A	H
		5500	105.12	-	-	92.98	35.24	8.4	31.5	100	108	P	H
		5500	98.48	-	-	86.34	35.24	8.4	31.5	100	108	A	H
		5458.8	57.39	-16.61	74	45.33	35.21	8.36	31.51	225	174	P	V
		5466.96	61.64	-6.66	68.3	49.53	35.22	8.4	31.51	225	174	P	V
		5459.98	46.88	-7.12	54	34.82	35.21	8.36	31.51	225	174	A	V
		5500	109.05	-	-	96.91	35.24	8.4	31.5	225	174	P	V
	5500	101.6	-	-	89.46	35.24	8.4	31.5	225	174	A	V	
802.11n HT20 CH 140 5700MHz		5725	63.62	-4.68	68.3	51.31	35.22	8.61	31.52	100	114	P	H
		5698	106.01	-	-	93.67	35.25	8.58	31.49	100	114	A	H
		5698	98.62	-	-	86.28	35.25	8.58	31.49	100	114	P	H
		5725.24	64.59	-3.71	68.3	52.28	35.22	8.61	31.52	210	163	P	V
		5704	110.66	-	-	98.3	35.24	8.61	31.49	210	163	A	V
	5704	103.3	-	-	90.94	35.24	8.61	31.49	210	163	P	V	
Remark	1. No other spurious found. 2. All results are PASS against Peak and Average limit line.												



band 3 - 5470~5725MHz
WIFI 802.11n HT20 (Harmonic @ 3m)

Table with 14 columns: WIFI, Note, Frequency, Level, Over, Limit, Read, Antenna, Cable, Preamp, Ant, Table, Peak, Pol. It contains test results for three channels (CH 100, CH 116, CH 140) and a final Remark section.



band 3 - 5470~5725MHz
WIFI 802.11ac VHT40 (Band Edge @ 3m)

WIFI	Note	Frequency	Level	Over	Limit	Read	Antenna	Cable	Preamp	Ant	Table	Peak	Pol.
Ant.				Limit	Line	Level	Factor	Loss	Factor	Pos	Pos	Avg.	
1		(MHz)	(dBμV/m)	(dB)	(dBμV/m)	(dBμV)	(dB/m)	(dB)	(dB)	(cm)	(deg)	(P/A)	(H/V)
802.11ac VHT40 CH 102 5510MHz		5459.98	55.11	-18.89	74	43.05	35.21	8.36	31.51	103	110	P	H
		5470	61.16	-7.14	68.3	49.05	35.22	8.4	31.51	103	110	P	H
		5459.98	47.36	-6.64	54	35.3	35.21	8.36	31.51	103	110	A	H
	*	5512	99.61	-	-	87.42	35.24	8.44	31.49	103	110	P	H
		5512	92.08	-	-	79.89	35.24	8.44	31.49	103	110	A	H
		5758.52	53.55	-14.75	68.3	41.3	35.19	8.64	31.58	103	110	P	H
		5459.6	59.11	-14.89	74	47.05	35.21	8.36	31.51	222	175	P	V
		5470	64.6	-3.7	68.3	52.49	35.22	8.4	31.51	222	175	P	V
		5459.98	50.85	-3.15	54	38.79	35.21	8.36	31.51	222	175	A	V
	*	5512	105.32	-	-	93.13	35.24	8.44	31.49	222	175	P	V
		5512	97.3	-	-	85.11	35.24	8.44	31.49	222	175	A	V
	5761.56	53.55	-14.75	68.3	41.3	35.19	8.64	31.58	222	175	P	V	
802.11ac VHT40 CH 134 5670MHz		5352.56	51.98	-22.02	74	40.09	35.16	8.3	31.57	100	115	P	H
		5467.76	51.51	-16.79	68.3	39.4	35.22	8.4	31.51	100	115	P	H
		5456.08	42.83	-11.17	54	30.77	35.21	8.36	31.51	100	115	A	H
	*	5668	102.67	-	-	90.27	35.27	8.58	31.45	100	115	P	H
		5668	95.27	-	-	82.87	35.27	8.58	31.45	100	115	A	H
		5733.64	58.55	-9.75	68.3	46.27	35.22	8.61	31.55	100	115	P	H
		5449.52	52.25	-21.75	74	40.21	35.21	8.36	31.53	198	161	P	V
		5469.52	51.91	-16.39	68.3	39.8	35.22	8.4	31.51	198	161	P	V
		5457.84	42.98	-11.02	54	30.92	35.21	8.36	31.51	198	161	A	V
	*	5674	108.5	-	-	96.1	35.27	8.58	31.45	198	161	P	V
		5674	100.39	-	-	87.99	35.27	8.58	31.45	198	161	A	V
	5728.2	64.4	-3.9	68.3	52.09	35.22	8.61	31.52	198	161	P	V	
Remark	1. No other spurious found. 2. All results are PASS against Peak and Average limit line.												



band 3 - 5470~5725MHz
WIFI 802.11ac VHT40 (Harmonic @ 3m)

Table with 14 columns: WIFI, Note, Frequency, Level, Over, Limit, Read, Antenna, Cable, Preamp, Ant, Table, Peak, Pol. It contains test results for three channels (102, 110, 134) and a remark section.



band 3 5470~5725MHz
WIFI 802.11ac VHT80 (Band Edge @ 3m)

WIFI	Note	Frequency	Level	Over	Limit	Read	Antenna	Cable	Preamp	Ant	Table	Peak	Pol.
Ant.				Limit	Line	Level	Factor	Loss	Factor	Pos	Pos	Avg.	
1		(MHz)	(dBμV/m)	(dB)	(dBμV/m)	(dBμV)	(dB/m)	(dB)	(dB)	(cm)	(deg)	(P/A)	(H/V)
802.11ac VHT80 CH 106 5530MHz		5444.4	54.82	-19.18	74	42.79	35.2	8.36	31.53	100	104	P	H
		5468.4	59.68	-8.62	68.3	47.57	35.22	8.4	31.51	100	104	P	H
		5457.36	47.49	-6.51	54	35.43	35.21	8.36	31.51	100	104	A	H
	*	5536	93.18	-	-	80.96	35.25	8.44	31.47	100	104	P	H
		5536	86.32	-	-	74.1	35.25	8.44	31.47	100	104	A	H
		5736.28	54.11	-14.19	68.3	41.84	35.21	8.61	31.55	100	104	P	H
		5452.08	60.11	-13.89	74	48.05	35.21	8.36	31.51	208	164	P	V
		5461.36	61.43	-6.87	68.3	49.37	35.21	8.36	31.51	208	164	P	V
		5459.76	50.8	-3.2	54	38.74	35.21	8.36	31.51	208	164	A	V
	*	5536	100.05	-	-	87.83	35.25	8.44	31.47	208	164	P	V
		5536	92.37	-	-	80.15	35.25	8.44	31.47	208	164	A	V
	5726.52	53.81	-14.49	68.3	41.5	35.22	8.61	31.52	208	164	P	V	
802.11ac VHT80 CH 122 5610MHz		5411.76	51.87	-22.13	74	39.9	35.19	8.32	31.54	101	115	P	H
		5467.28	51.57	-16.73	68.3	39.46	35.22	8.4	31.51	101	115	P	H
		5457.2	43.41	-10.59	54	31.35	35.21	8.36	31.51	101	115	A	H
	*	5620	97.47	-	-	85.09	35.29	8.52	31.43	101	115	P	H
		5620	89.88	-	-	77.5	35.29	8.52	31.43	101	115	A	H
		5756.52	54.08	-14.22	68.3	41.83	35.19	8.64	31.58	101	115	P	H
		5430.48	52.65	-21.35	74	40.62	35.2	8.36	31.53	214	161	P	V
		5469.36	51.52	-16.78	68.3	39.41	35.22	8.4	31.51	214	161	P	V
		5455.12	43.49	-10.51	54	31.43	35.21	8.36	31.51	214	161	A	V
	*	5614	102.16	-	-	89.79	35.28	8.52	31.43	214	161	P	V
		5614	95.23	-	-	82.86	35.28	8.52	31.43	214	161	A	V
	5731.48	57.87	-10.43	68.3	45.59	35.22	8.61	31.55	214	161	P	V	
Remark	1. No other spurious found. 2. All results are PASS against Peak and Average limit line.												



band 3 5470~5725MHz

WIFI 802.11ac VHT80 (Harmonic @ 3m)

WIFI	Note	Frequency	Level	Over	Limit	Read	Antenna	Cable	Preamp	Ant	Table	Peak	Pol.
Ant.				Limit	Line	Level	Factor	Loss	Factor	Pos	Pos	Avg.	
1		(MHz)	(dBμV/m)	(dB)	(dBμV/m)	(dBμV)	(dB/m)	(dB)	(dB)	(cm)	(deg)	(P/A)	(H/V)
802.11ac VHT80 CH 106 5530MHz		11060	41.57	-32.43	74	54.27	37.8	12.42	62.92	100	360	P	H
802.11ac VHT80 CH 122 5610MHz		11220	42.46	-31.54	74	54.94	37.87	12.54	62.89	100	360	P	H
		11220	41.84	-32.16	74	54.32	37.87	12.54	62.89	100	0	P	V
Remark	1. No other spurious found. 2. All results are PASS against Peak and Average limit line.												



Band 3 - Straddle Channel
WIFI 802.11a (Band Edge @ 3m)

Table with 14 columns: WIFI, Note, Frequency, Level, Over, Limit, Read, Antenna, Cable, Preamp, Ant, Table, Peak, Pol. It contains test data for 802.11a CH 144 at 5720MHz and a Remark section.



band 3 - Straddle Channel
WIFI 802.11a (Harmonic @ 3m)

Table with 14 columns: WIFI, Note, Frequency, Level, Over, Limit, Read, Antenna, Cable, Preamp, Ant, Table, Peak, Pol. It contains two rows of test data for 802.11a CH 144 at 5720MHz and a Remark section with two points.



band 3 - Straddle Channel
WIFI 802.11n HT20 (Band Edge @ 3m)

Table with 14 columns: WIFI, Note, Frequency, Level, Over, Limit, Read, Antenna, Cable, Preamp, Ant, Table, Peak, Pol. It contains test data for 802.11n HT20 and CH 144 at 5720MHz, and a Remark section stating 'No other spurious found' and 'All results are PASS against Peak and Average limit line.'



band 3 - Straddle Channel
WIFI 802.11n HT20 (Harmonic @ 3m)

Table with 14 columns: WIFI, Note, Frequency, Level, Over, Limit, Read, Antenna, Cable, Preamp, Ant, Table, Peak, Pol. It contains two rows of test data for 802.11n HT20 CH 144 at 5720MHz.

Remark
1. No other spurious found.
2. All results are PASS against Peak and Average limit line.



band 3 - Straddle Channel
WIFI 802.11ac VHT40 (Band Edge @ 3m)

Table with 14 columns: WIFI, Note, Frequency, Level, Over, Limit, Read, Antenna, Cable, Preamp, Ant, Table, Peak, Pol. It contains four rows of test data for 802.11ac VHT40 and CH 142 at 5716 MHz and 5704 MHz.

Remark
1. No other spurious found.
2. All results are PASS against Peak and Average limit line.



band 3 - Straddle Channel
WIFI 802.11ac VHT40 (Harmonic @ 3m)

Table with 14 columns: WIFI, Note, Frequency, Level, Over, Limit, Read, Antenna, Cable, Preamp, Ant, Table, Peak, Pol. It contains two rows of test data for 802.11ac VHT40 CH 142 at 5710MHz.

Remark
1. No other spurious found.
2. All results are PASS against Peak and Average limit line.



band 3 - Straddle Channel
WIFI 802.11ac VHT80 (Band Edge @ 3m)

Table with 14 columns: WIFI, Note, Frequency, Level, Over, Limit, Read, Antenna, Cable, Preamp, Ant, Table, Peak, Pol. It contains test data for 802.11ac VHT80 and CH 138 at 5690MHz, and a Remark section stating 'No other spurious found' and 'All results are PASS against Peak and Average limit line.'



band 3 - Straddle Channel
WIFI 802.11ac VHT80 (Harmonic @ 3m)

Table with 14 columns: WIFI, Note, Frequency, Level, Over, Limit, Read, Antenna, Cable, Preamp, Ant, Table, Peak, Pol. It contains two rows of test data for 802.11ac VHT80 and CH 138 at 11380 MHz, and a Remark section with two points.



Emission below 1GHz

WIFI 802.11ac VHT40 (LF @ 3m)

WIFI	Note	Frequency	Level	Over	Limit	Read	Antenna	Cable	Preamp	Ant	Table	Peak	Pol.
Ant.				Limit	Line	Level	Factor	Loss	Factor	Pos	Pos	Avg.	
1		(MHz)	(dB μ V/m)	(dB)	(dB μ V/m)	(dB μ V)	(dB/m)	(dB)	(dB)	(cm)	(deg)	(P/A)	(H/V)
802.11ac VHT40 LF		36.79	17.12	-22.88	40	27.22	21.14	0.72	31.96	-	-	P	H
		65.89	12.07	-27.93	40	30.73	12.28	0.99	31.93	-	-	P	H
		128.94	17.82	-25.68	43.5	31.7	16.78	1.28	31.94	-	-	P	H
		157.07	16.36	-27.14	43.5	29.91	16.91	1.47	31.93	-	-	P	H
		853.53	27.05	-18.95	46	26.16	29.29	3.36	31.76	-	-	P	H
		954.41	28.7	-17.3	46	25.23	30.86	3.55	30.94	100	0	P	H
		42.61	22.78	-17.22	40	35.91	18.08	0.74	31.95	-	-	P	V
		66.86	23.56	-16.44	40	42.14	12.36	0.99	31.93	100	0	P	V
		795.33	26.41	-19.59	46	27.05	28.23	3.26	32.13	-	-	P	V
		931.13	28.21	-17.79	46	25.6	30.27	3.51	31.17	-	-	P	V
		951.5	28.27	-17.73	46	24.81	30.88	3.55	30.97	-	-	P	V
	971.87	28.34	-25.66	54	24.83	30.72	3.57	30.78	-	-	P	V	
Remark	1. No other spurious found. 2. All results are PASS against limit line.												



Note symbol

*	Fundamental Frequency which can be ignored. However, the level of any unwanted emissions shall not exceed the level of the fundamental frequency per 15.209(c).
!	Test result is over limit line.
P/A	Peak or Average
H/V	Horizontal or Vertical



A calculation example for radiated spurious emission is shown as below:

WIFI	Note	Frequency	Level	Over	Limit	Read	Antenna	Cable	Preamp	Ant	Table	Peak	Pol.
Ant.				Limit	Line	Level	Factor	Loss	Factor	Pos	Pos	Avg.	
1		(MHz)	(dBμV/m)	(dB)	(dBμV/m)	(dBμV)	(dB/m)	(dB)	(dB)	(cm)	(deg)	(P/A)	(H/V)
802.11b		2390	55.45	-18.55	74	54.51	32.22	4.58	35.86	103	308	P	H
CH 01		2390	43.54	-10.46	54	42.6	32.22	4.58	35.86	103	308	A	H
2412MHz													

- Level(dBμV/m) =
Antenna Factor(dB/m) + Cable Loss(dB) + Read Level(dBμV) - Preamp Factor(dB)
- Over Limit(dB) = Level(dBμV/m) – Limit Line(dBμV/m)

For Peak Limit @ 2390MHz:

- Level(dBμV/m)
= Antenna Factor(dB/m) + Cable Loss(dB) + Read Level(dBμV) - Preamp Factor(dB)
= 32.22(dB/m) + 4.58(dB) + 54.51(dBμV) – 35.86 (dB)
= 55.45 (dBμV/m)
- Over Limit(dB)
= Level(dBμV/m) – Limit Line(dBμV/m)
= 55.45(dBμV/m) – 74(dBμV/m)
= -18.55(dB)

For Average Limit @ 2390MHz:

- Level(dBμV/m)
= Antenna Factor(dB/m) + Cable Loss(dB) + Read Level(dBμV) - Preamp Factor(dB)
= 32.22(dB/m) + 4.58(dB) + 42.6(dBμV) – 35.86 (dB)
= 43.54 (dBμV/m)
- Over Limit(dB)
= Level(dBμV/m) – Limit Line(dBμV/m)
= 43.54(dBμV/m) – 54(dBμV/m)
= -10.46(dB)

Both peak and average measured complies with the limit line, so test result is “PASS”.



Appendix D. Duty Cycle Plots

Band	Duty Cycle(%)	T(ms)	1/T(kHz)	VBW Setting
802.11a	98.28	-	-	10Hz
802.11n HT20	98.16	-	-	10Hz
802.11ac VHT40	96.32	0.949	1.053	1.1KHz
802.11ac VHT80	93.02	0.464	2.156	2.2KHz

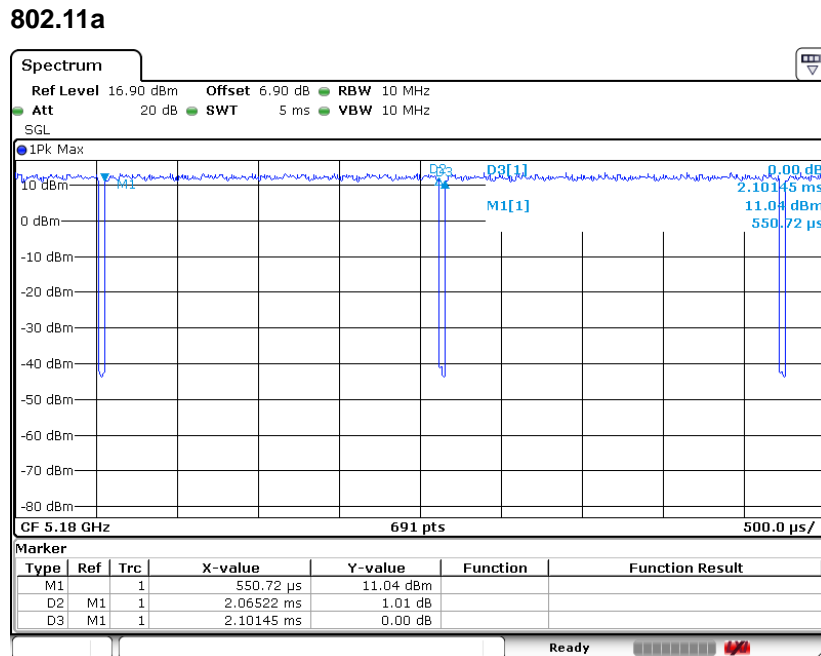



802.11n HT20

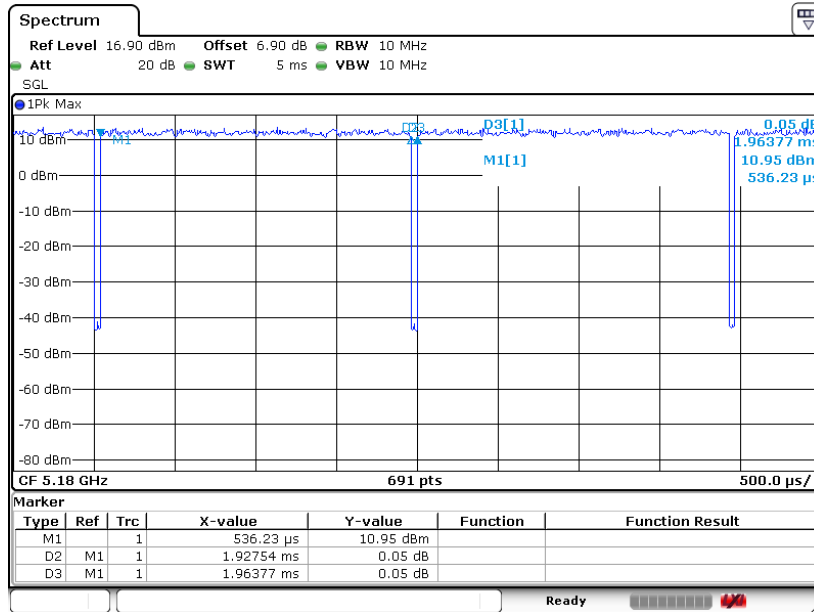

802.11ac VHT40

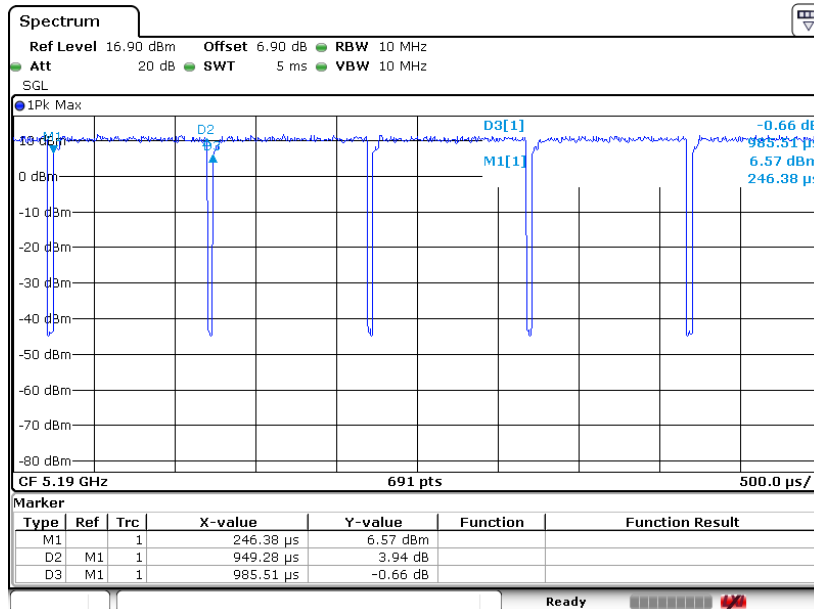



802.11ac VHT80

