



FCC RF Test Report

APPLICANT : Motorola Mobility LLC
EQUIPMENT : Mobile Cellular Phone
BRAND NAME : Motorola
MODEL NAME : XT2015-2, XT2016-2
FCC ID : IHDT56YF2
STANDARD : 47 CFR Part 2, 22(H), 24(E), 27(L)
CLASSIFICATION : PCS Licensed Transmitter Held to Ear (PCE)

The product was received on Jun. 04, 2019 and completely tested on Jul. 03, 2019. We, Sporton International (Kunshan) Inc., would like to declare that the tested sample has been evaluated in accordance with the procedures given in ANSI C63.26-2015 and shown compliance with the applicable technical standards.

The test results in this report apply exclusively to the tested model / sample. Without written approval of Sporton International (Kunshan) Inc., the test report shall not be reproduced except in full.

Reviewed by: Jason Jia / Supervisor

Approved by: James Huang / Manager



Sporton International (Kunshan) Inc.

**No. 1098, Pengxi North Road, Kunshan Economic Development Zone Jiangsu Province 215300
People's Republic of China**



TABLE OF CONTENTS

REVISION HISTORY..... 3

SUMMARY OF TEST RESULT 4

1 GENERAL DESCRIPTION 5

 1.1 Applicant..... 5

 1.2 Manufacturer 5

 1.3 Product Feature of Equipment Under Test 5

 1.4 Product Specification of Equipment Under Test 6

 1.5 Specification of Accessory 7

 1.6 Modification of EUT 8

 1.7 Maximum ERP/EIRP Power, Frequency Tolerance, and Emission Designator 9

 1.8 Testing Location 9

 1.9 Applicable Standards 10

2 TEST CONFIGURATION OF EQUIPMENT UNDER TEST 11

 2.1 Test Mode..... 11

 2.2 Connection Diagram of Test System 12

 2.3 Support Unit used in test configuration 12

 2.4 Measurement Results Explanation Example 12

 2.5 Frequency List of Low/Middle/High Channels..... 13

3 CONDUCTED TEST RESULT..... 14

 3.1 Measuring Instruments..... 14

 3.2 Test Setup 14

 3.3 Test Result of Conducted Test..... 14

 3.4 Conducted Output Power and ERP/EIRP 15

 3.5 Peak-to-Average Ratio 16

 3.6 99% Occupied Bandwidth and 26dB Bandwidth Measurement..... 17

 3.7 Conducted Band Edge 18

 3.8 Conducted Spurious Emission 19

 3.9 Frequency Stability..... 20

4 RADIATED TEST ITEMS 21

 4.1 Measuring Instruments..... 21

 4.2 Test Setup 21

 4.3 Test Result of Radiated Test..... 21

 4.4 Field Strength of Spurious Radiation Measurement 22

5 LIST OF MEASURING EQUIPMENT 23

6 UNCERTAINTY OF EVALUATION 24

APPENDIX A. TEST RESULTS OF CONDUCTED TEST

APPENDIX B. TEST RESULTS OF RADIATED TEST

APPENDIX C. TEST SETUP PHOTOGRAPHS



REVISION HISTORY

| REPORT NO. | VERSION | DESCRIPTION | ISSUED DATE |
|------------|---------|--|---------------|
| FG960403A | Rev. 01 | Initial issue of report | Jul. 31, 2019 |
| FG960403A | Rev. 02 | Add the model XT2016-2 for market segmentation | Aug. 15, 2019 |
| | | | |
| | | | |
| | | | |
| | | | |
| | | | |
| | | | |
| | | | |
| | | | |
| | | | |
| | | | |
| | | | |
| | | | |
| | | | |
| | | | |
| | | | |



SUMMARY OF TEST RESULT

| Report Section | FCC Rule | Description | Limit | Result | Remark |
|----------------|--|---|------------------------|--------|-------------------------------------|
| 3.4 | §2.1046 | Conducted Output Power | Reporting Only | PASS | - |
| | §22.913(a)(5) | Effective Radiated Power | < 7 Watts | PASS | - |
| | §24.232(c) | Equivalent Isotropic Radiated Power | < 2 Watts | PASS | - |
| | §27.50(d)(4) | Equivalent Isotropic Radiated Power | < 1 Watts | PASS | - |
| 3.5 | §24.232(d) | Peak-to-Average Ratio | < 13 dB | PASS | - |
| 3.6 | §2.1049 | Occupied Bandwidth | Reporting Only | PASS | - |
| 3.7 | §2.1051 §22.917(a) §24.238(a) §27.53(h) | Band Edge Measurement | < 43+10log10(P[Watts]) | PASS | - |
| 3.8 | §2.1051 §22.917(a) §24.238(a) §27.53(h) | Conducted Emission | < 43+10log10(P[Watts]) | PASS | - |
| 3.9 | §2.1055 §22.355 | Frequency Stability for Temperature & Voltage | < 2.5 ppm for Part 22H | PASS | - |
| | §2.1055 §24.235 §27.54 | | Within Authorized Band | | |
| 4.4 | §2.1053 §22.917(a) §24.238(a) §27.53(h) | Field Strength of Spurious Radiation | < 43+10log10(P[Watts]) | PASS | Under limit 26.61 dB at 5640.00 MHz |



1 General Description

1.1 Applicant

Motorola Mobility LLC
222 W, Merchandise Mart Plaza, Chicago IL 60654 USA

1.2 Manufacturer

Motorola Mobility LLC
222 W, Merchandise Mart Plaza, Chicago IL 60654 USA

1.3 Product Feature of Equipment Under Test

| Product Feature | |
|---------------------------------|--|
| Equipment | Mobile Cellular Phone |
| Brand Name | Motorola |
| Model Name | XT2015-2, XT2016-2 |
| FCC ID | IHDT56YF2 |
| EUT supports Radios application | GSM/WCDMA/LTE/FM Receiver/GNSS WLAN 2.4GHz 802.11b/g/n HT20 Bluetooth BR/EDR/LE |
| IMEI Code | Conducted: 357205100005796/357205100005778/357205100005804/3 57205100005878 Radiation:357205100007396/357205100007404 |
| HW Version | DVT2 |
| SW Version | PMD29.56 |
| EUT Stage | Identical Prototype |

Remark: The above EUT's information was declared by manufacturer. Please refer to the specifications or user's manual for more detailed description.



1.4 Product Specification of Equipment Under Test

| Standards-related Product Specification | |
|---|--|
| Tx Frequency | GSM/GPRS/EDGE: 850: 824.2 MHz ~ 848.8 MHz 1900: 1850.2 MHz ~ 1909.8MHz WCDMA: Band V: 826.4 MHz ~ 846.6 MHz Band II: 1852.4 MHz ~ 1907.6 MHz Band IV: 1712.4 MHz ~ 1752.6 MHz |
| Rx Frequency | GSM/GPRS/EDGE: 850: 869.2 MHz ~ 893.8 MHz 1900: 1930.2 MHz ~ 1989.8 MHz WCDMA: Band V: 871.4 MHz ~ 891.6 MHz Band II: 1932.4 MHz ~ 1987.6 MHz Band IV: 2112.4 MHz ~ 2152.6 MHz |
| Maximum Output Power to Antenna | GSM/GPRS/EDGE: 850: 32.74 dBm 1900: 29.42 dBm WCDMA: Band V: 23.21 dBm Band II: 23.36 dBm Band IV: 22.91 dBm |
| Antenna Type | PIFA Antenna |
| Antenna Gain | Cellular Band: -3.30 dBi PCS Band: -1.11 dBi AWS Band: -0.06 dBi |
| Type of Modulation | GSM: GMSK GPRS: GMSK EDGE: GMSK / 8PSK WCDMA : BPSK (Uplink) HSDPA/DC-HSDPA : QPSK (Uplink) HSUPA : QPSK (Uplink) HSPA+ : 16QAM DC-HSDPA : 64QAM |

Note: The Maximum ERP/EIRP is calculated from Max Output power and Max antenna gain.



1.5 Specification of Accessory

| Specification of Accessory | | | |
|-----------------------------|------------------|---|----------------------------|
| AC Adapter 1(US) | Brand Name | Motorola (Salom) | Model Name SC-41 |
| | Power Rating | I/P: 100-240 Vac ~ 50/60Hz, 0.3A; O/P: 5Vdc,2A | |
| AC Adapter 1(EU) | Brand Name | Motorola (Salom) | Model Name SC-42 |
| | Power Rating | I/P: 100-240 Vac ~ 50/60Hz, 0.3A; O/P: 5Vdc,2A | |
| AC Adapter 1(UK) | Brand Name | Motorola (Salom) | Model Name SC-43 |
| | Power Rating | I/P: 100-240 Vac ~ 50/60Hz, 0.3A; O/P: 5Vdc,2A | |
| AC Adapter 1(IN) | Brand Name | Motorola (Salom) | Model Name SC-44 |
| | Power Rating | I/P: 100-240 Vac ~ 50/60Hz, 0.3A; O/P: 5Vdc,2A | |
| AC Adapter 1(AU) | Brand Name | Motorola (Salom) | Model Name SC-45 |
| | Power Rating | I/P: 100-240 Vac ~ 50/60Hz, 0.3A; O/P: 5Vdc,2A | |
| AC Adapter 1(AR) | Brand Name | Motorola (Salom) | Model Name SC-46 |
| | Power Rating | I/P: 100-240 Vac ~ 50/60Hz, 0.3A; O/P: 5Vdc,2A | |
| AC Adapter 1(BR) | Brand Name | Motorola (Salom) | Model Name SC-47 |
| | Power Rating | I/P: 100-240 Vac ~ 50/60Hz, 0.3A; O/P: 5Vdc,2A | |
| AC Adapter 1(Chile) | Brand Name | Motorola (Salom) | Model Name SC-42 |
| | Power Rating | I/P: 100-240 Vac ~ 50/60Hz, 0.3A; O/P: 5Vdc,2A | |
| AC Adapter 2(US) | Brand Name | Motorola (Acbel) | Model Name SC-41 |
| | Power Rating | I/P: 100-240 Vac ~ 50/60Hz, 0.3A; O/P: 5Vdc,2A | |
| AC Adapter 2(EU) | Brand Name | Motorola (Acbel) | Model Name SC-42 |
| | Power Rating | I/P: 100-240 Vac ~ 50/60Hz, 0.3A; O/P: 5Vdc,2A | |
| AC Adapter 2(UK) | Brand Name | Motorola (Acbel) | Model Name SC-43 |
| | Power Rating | I/P: 100-240 Vac ~ 50/60Hz, 0.3A; O/P: 5Vdc,2A | |
| AC Adapter 2(AU) | Brand Name | Motorola (Acbel) | Model Name SC-45 |
| | Power Rating | I/P: 100-240 Vac ~ 50/60Hz, 0.3A; O/P: 5Vdc,2A | |
| AC Adapter 2(AR) | Brand Name | Motorola (Acbel) | Model Name SC-46 |
| | Power Rating | I/P: 100-240 Vac ~ 50/60Hz, 0.3A; O/P: 5Vdc,2A | |
| AC Adapter 3(BR) | Brand Name | Motorola(Cliptech/Tenpao) | Model Name SC-47 |
| | Power Rating | I/P: 100-240 Vac ~ 50/60Hz, 0.3A; O/P: 5Vdc,2A | |
| AC Adapter 4(BR) | Brand Name | Motorola (Salom/Flex) | Model Name SC-47 |
| | Power Rating | I/P: 100-240 Vac ~ 50/60Hz, 0.3A; O/P: 5Vdc,2A | |
| Battery | Brand Name | Motorola (ATL) | Model Name KG40 |
| | Power Rating | 3.8Vdc, 3760/4000mAh | Type Li-ion |
| Earphone 1 | Brand Name | Huizhou New Leader Industry Co., Ltd. | Model Name NLD-EM307K-01SF |
| | Signal Line Type | 1.1 meter, non-shielded cable, without ferrite core | |
| Earphone 2 (Local Build) | Brand Name | Lianyun | Model Name SH38C37773 |
| | Signal Line Type | 1.1 meter, non-shielded cable, without ferrite core | |



| | | | | |
|-------------|------------------|---|------------|------------|
| USB Cable 1 | Brand Name | Motorola (SaiBao) | Model Name | SWT-A096A |
| | Signal Line Type | 1.0 meter, shielded cable, without ferrite core | | |
| USB Cable 2 | Brand Name | Motorola (LiQi) | Model Name | LQ025289 |
| | Signal Line Type | 1.0 meter, shielded cable, without ferrite core | | |
| USB Cable 3 | Brand Name | Motorola (I SHENG) | Model Name | SC18C28955 |
| | Signal Line Type | 1.0 meter, shielded cable, without ferrite core | | |

1.6 Modification of EUT

No modifications are made to the EUT during all test items.



1.7 Maximum ERP/EIRP Power, Frequency Tolerance, and Emission Designator

| FCC Rule | System | Type of Modulation | Maximum ERP/EIRP (W) | Frequency Tolerance (ppm) | Emission Designator |
|----------|----------------------------|--------------------|----------------------|---------------------------|---------------------|
| Part 22H | GSM850 GSM | GMSK | 0.5358 | 0.0574 ppm | 245KGXW |
| Part 22H | GSM850 EDGE class 8 | 8PSK | 0.1479 | 0.0538 ppm | 247KG7W |
| Part 22H | WCDMA Band V RMC 12.2Kbps | BPSK | 0.0597 | 0.0442 ppm | 4M17F9W |
| Part 24E | GSM1900 GSM | GMSK | 0.6776 | 0.0218 ppm | 245KGXW |
| Part 24E | GSM1900 EDGE class 8 | 8PSK | 0.3184 | 0.0255 ppm | 245KG7W |
| Part 24E | WCDMA Band II RMC 12.2Kbps | BPSK | 0.1679 | 0.0239 ppm | 4M17F9W |
| Part 27L | WCDMA Band IV RMC 12.2Kbps | BPSK | 0.1928 | 0.0167 ppm | 4M17F9W |

1.8 Testing Location

Sporton International (Kunshan) Inc. is accredited to ISO/IEC 17025:2017 by American Association for Laboratory Accreditation with Certificate Number 5145.02.

| | | | |
|---------------------------|--|----------------------------|---------------------------------------|
| Test Firm | Sporton International (Kunshan) Inc. | | |
| Test Site Location | No. 1098, Pengxi North Road, Kunshan Economic Development Zone Jiangsu Province 215300 People's Republic of China TEL : +86-512-57900158 FAX : +86-512-57900958 | | |
| Test Site No. | Sporton Site No. | FCC Designation No. | FCC Test Firm Registration No. |
| | TH01-KS 03CH04-KS | CN1257 | 314309 |



1.9 Applicable Standards

According to the specifications of the manufacturer, the EUT must comply with the requirements of the following standards:

- ♦ 47 CFR Part 2, 22(H), 24(E), 27(L)
- ♦ ANSI C63.26-2015
- ♦ FCC KDB 971168 D01 Power Meas. License Digital Systems v03r01
- ♦ FCC KDB 412172 D01 Determining ERP and EIRP v01r01

Remark:

1. All test items were verified and recorded according to the standards and without any deviation during the test.
2. This EUT has also been tested and complied with the requirements of FCC Part 15, Subpart B, recorded in a separate test report.



2 Test Configuration of Equipment Under Test

2.1 Test Mode

Antenna port conducted and radiated test items were performed according to KDB 971168 D01 Power Meas. License Digital Systems v03r01 with maximum output power.

Radiated measurements were performed with rotating EUT in different three orthogonal test planes to find the maximum emission.

Radiated emissions were investigated as following frequency range:

1. 30 MHz to 10th harmonic for GSM850 and WCDMA Band V.
2. 30 MHz to 10th harmonic for WCDMA Band IV.
3. 30 MHz to 10th harmonic for GSM1900 and WCDMA Band II.

All modes and data rates and positions were investigated.

Test modes are chosen to be reported as the worst case configuration below:

| Test Modes | | |
|---------------|---|---|
| Band | Radiated TCs | Conducted TCs |
| GSM 850 | <ul style="list-style-type: none"> ■ GSM Link ■ EDGE class 8 Link | <ul style="list-style-type: none"> ■ GSM Link ■ EDGE class 8 Link |
| GSM 1900 | <ul style="list-style-type: none"> ■ GSM Link ■ EDGE class 8 Link | <ul style="list-style-type: none"> ■ GSM Link ■ EDGE class 8 Link |
| WCDMA Band V | <ul style="list-style-type: none"> ■ RMC 12.2Kbps Link | <ul style="list-style-type: none"> ■ RMC 12.2Kbps Link |
| WCDMA Band II | <ul style="list-style-type: none"> ■ RMC 12.2Kbps Link | <ul style="list-style-type: none"> ■ RMC 12.2Kbps Link |
| WCDMA Band IV | <ul style="list-style-type: none"> ■ RMC 12.2Kbps Link | <ul style="list-style-type: none"> ■ RMC 12.2Kbps Link |

2.2 Connection Diagram of Test System

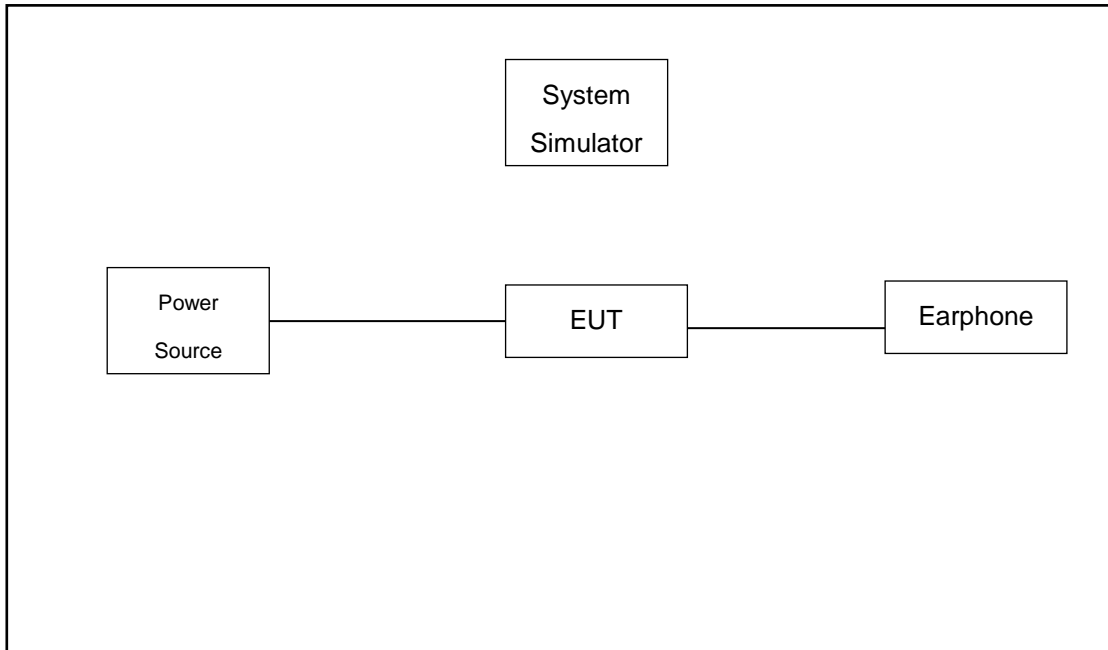

2.3 Support Unit used in test configuration

| Item | Equipment | Trade Name | Model No. | FCC ID | Data Cable | Power Cord |
|------|------------------|------------|-----------|--------|------------|-------------------|
| 1. | System Simulator | Anritsu | MT8820C | N/A | N/A | Unshielded, 1.8 m |
| 2. | DC Power Supply | GW INSTEK | GPS-3030D | N/A | N/A | Unshielded, 1.8 m |

2.4 Measurement Results Explanation Example

For all conducted test items:

The offset level is set in the spectrum analyzer to compensate the RF cable loss and attenuator factor between RF conducted output port and spectrum analyzer. With the offset compensation, the spectrum analyzer reading level will be exactly the RF output level.

The spectrum analyzer offset is derived from RF cable loss and attenuator factor.

Offset = RF cable loss + attenuator factor.

The following shows an offset computation example with RF cable loss 5.40 dB and a 10dB attenuator.

Example :

$$\begin{aligned}
 \text{Offset(dB)} &= \text{RF cable loss(dB)} + \text{attenuator factor(dB)}. \\
 &= 5.40 + 10 = 15.40 \text{ (dB)}
 \end{aligned}$$



2.5 Frequency List of Low/Middle/High Channels

| Frequency List | | | | |
|------------------|------------------------|--------|--------|---------|
| Band | Channel/Frequency(MHz) | Lowest | Middle | Highest |
| GSM850 | Channel | 128 | 189 | 251 |
| | Frequency | 824.2 | 836.4 | 848.8 |
| WCDMA Band V | Channel | 4132 | 4182 | 4233 |
| | Frequency | 826.4 | 836.4 | 846.6 |
| GSM1900 | Channel | 512 | 661 | 810 |
| | Frequency | 1850.2 | 1880.0 | 1909.8 |
| WCDMA Band II | Channel | 9262 | 9400 | 9538 |
| | Frequency | 1852.4 | 1880.0 | 1907.6 |
| WCDMA Band IV | Channel | 1312 | 1413 | 1513 |
| | Frequency | 1712.4 | 1732.6 | 1752.6 |

3 Conducted Test Result

3.1 Measuring Instruments

See list of measuring instruments of this test report.

3.2 Test Setup

3.2.1 Conducted Output Power

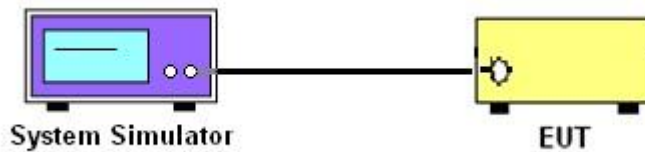

3.2.2 Peak-to-Average Ratio, Occupied Bandwidth, Conducted Band-Edge and Conducted Spurious Emission

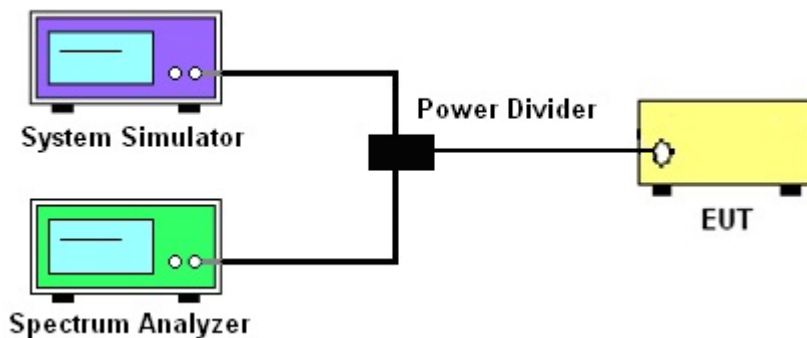

3.2.3 Frequency Stability

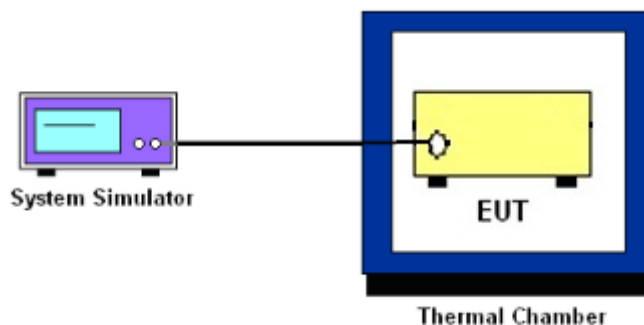

3.3 Test Result of Conducted Test

Please refer to Appendix A.



3.4 Conducted Output Power and ERP/EIRP

3.4.1 Description of the Conducted Output Power and ERP/EIRP

A system simulator was used to establish communication with the EUT. Its parameters were set to enforce EUT transmitting at the maximum power. The measured power in the radio frequency on the transmitter output terminals shall be reported.

The ERP of mobile transmitters must not exceed 7 Watts for GSM850 and WCDMA Band V.

The EIRP of mobile transmitters must not exceed 2 Watts for GSM1900 and WCDMA Band II.

The EIRP of mobile transmitters must not exceed 1 Watts for WCDMA Band IV.

According to KDB 412172 D01 Power Approach,

$EIRP = P_T + G_T - L_C$, $ERP = EIRP - 2.15$, where

P_T = transmitter output power in dBm

G_T = gain of the transmitting antenna in dBi

L_C = signal attenuation in the connecting cable between the transmitter and antenna in dB

3.4.2 Test Procedures

1. The testing follows ANSI C63.26 Section 5.2
2. The transmitter output port was connected to the system simulator.
3. Set EUT at maximum power through the system simulator.
4. Select lowest, middle, and highest channels for each band and different modulation.
5. Measure and record the power level from the system simulator.



3.5 Peak-to-Average Ratio

3.5.1 Description of the PAR Measurement

The peak-to-average ratio (PAR) of the transmission may not exceed 13 dB.

3.5.2 Test Procedures

1. The testing follows ANSI C63.26 Section 5.2.3.4 (CCDF).
2. The EUT was connected to spectrum and system simulator via a power divider.
3. Set the CCDF (Complementary Cumulative Distribution Function) option in spectrum analyzer.
4. The highest RF powers were measured and recorded the maximum PAPR level associated with a probability of 0.1 %.
5. Record the deviation as Peak to Average Ratio.



3.6 99% Occupied Bandwidth and 26dB Bandwidth Measurement

3.6.1 Description of 99% Occupied Bandwidth and 26dB Bandwidth Measurement

The occupied bandwidth is the width of a frequency band such that, below the lower and above the upper frequency limits, the mean powers emitted are each equal to a specified percentage 0.5% of the total mean transmitted power.

The 26 dB emission bandwidth is defined as the frequency range between two points, one above and one below the carrier frequency, at which the spectral density of the emission is attenuated 26 dB below the maximum in-band spectral density of the modulated signal. Spectral density (power per unit bandwidth) is to be measured with a detector of resolution bandwidth equal to approximately 1.0% of the emission bandwidth.

3.6.2 Test Procedures

1. The testing follows ANSI C63.26 Section 5.4
2. The EUT was connected to spectrum analyzer and system simulator via a power divider.
3. The spectrum analyzer center frequency is set to the nominal EUT channel center frequency. The span range for the spectrum analyzer shall be between two and five times the anticipated OBW.
4. The nominal resolution bandwidth (RBW) shall be in the range of 1 to 5 % of the anticipated OBW, and the VBW shall be at least 3 times the RBW.
5. Set the detection mode to peak, and the trace mode to max hold.
6. Determine the reference value: Set the EUT to transmit a modulated signal. Allow the trace to stabilize. Set the spectrum analyzer marker to the highest level of the displayed trace.
(this is the reference value)
7. Determine the “-26 dB down amplitude” as equal to (Reference Value – X).
8. Place two markers, one at the lowest and the other at the highest frequency of the envelope of the spectral display such that each marker is at or slightly below the “-X dB down amplitude” determined in step 6. If a marker is below this “-X dB down amplitude” value it shall be placed as close as possible to this value. The OBW is the positive frequency difference between the two markers.
9. Use the 99 % power bandwidth function of the spectrum analyzer and report the measured bandwidth.



3.7 Conducted Band Edge

3.7.1 Description of Conducted Band Edge Measurement

The power of any emission outside of the authorized operating frequency ranges must be lower than the transmitter power (P) by a factor of at least $43 + 10 \log (P)$ dB.

3.7.2 Test Procedures

1. The testing follows ANSI C63.26 section 5.7
2. The EUT was connected to the spectrum analyzer and system simulator via a power divider.
3. The RF output of EUT was connected to the spectrum analyzer by an RF cable and attenuator. The path loss was compensated to the results for each measurement.
4. The band edges of low and high channels for the highest RF powers were measured.
5. The RF fundamental frequency should be excluded against the limit line in the operating frequency band.
6. The limit line is derived from $43 + 10\log(P)$ dB below the transmitter power P(Watts)



3.8 Conducted Spurious Emission

3.8.1 Description of Conducted Spurious Emission Measurement

The power of any emission outside of the authorized operating frequency ranges must be lower than the transmitter power (P) by a factor of at least $43 + 10 \log (P)$ dB.

It is measured by means of a calibrated spectrum analyzer and scanned from 30 MHz up to a frequency including its 10th harmonic.

3.8.2 Test Procedures

1. The testing follows ANSI C63.26 section 5.7
2. The EUT was connected to the spectrum analyzer and system simulator via a power divider.
3. The RF output of EUT was connected to the spectrum analyzer by an RF cable and attenuator. The path loss was compensated to the results for each measurement.
4. The middle channel for the highest RF power within the transmitting frequency was measured.
5. The conducted spurious emission for the whole frequency range was taken.
6. The RF fundamental frequency should be excluded against the limit line in the operating frequency band.
7. The limit line is derived from $43 + 10\log(P)$ dB below the transmitter power P(Watts)



3.9 Frequency Stability

3.9.1 Description of Frequency Stability Measurement

The frequency stability shall be measured by variation of ambient temperature and variation of primary supply voltage to ensure that the fundamental emission stays within the authorized frequency block. The frequency stability of the transmitter shall be maintained within $\pm 0.00025\%$ ($\pm 2.5\text{ppm}$) of the center frequency.

3.9.2 Test Procedures for Temperature Variation

1. The testing follows ANSI C63.26 section 5.6.4
2. The EUT was set up in the thermal chamber and connected with the system simulator.
3. With power OFF, the temperature was decreased to -30°C and the EUT was stabilized before testing. Power was applied and the maximum change in frequency was recorded within one minute.
4. With power OFF, the temperature was raised in 10°C step up to 50°C . The EUT was stabilized at each step for at least half an hour. Power was applied and the maximum frequency change was recorded within one minute.

3.9.3 Test Procedures for Voltage Variation

1. The testing follows ANSI C63.26 section 5.6.5
2. The EUT was placed in a temperature chamber at $20\pm 5^{\circ}\text{C}$ and connected with the system simulator.
3. The power supply voltage to the EUT was varied from 85% to 115% of the nominal value for other than hand carried battery equipment.
4. For hand carried, battery powered equipment, reduce the primary ac or dc supply voltage to the battery operating end point, which shall be specified by the manufacturer.
5. The variation in frequency was measured for the worst case.

4 Radiated Test Items

4.1 Measuring Instruments

See list of measuring instruments of this test report.

4.2 Test Setup

4.2.1 For radiated test from 30MHz to 1GHz

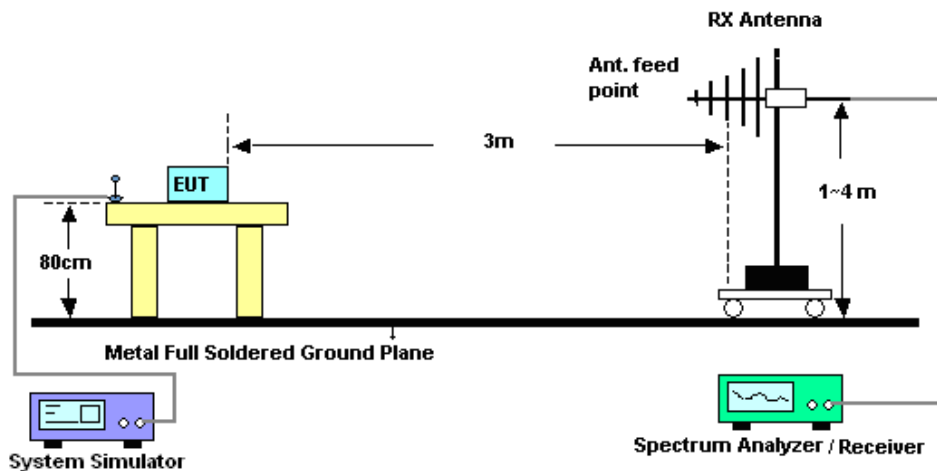

4.2.2 For radiated test above 1GHz

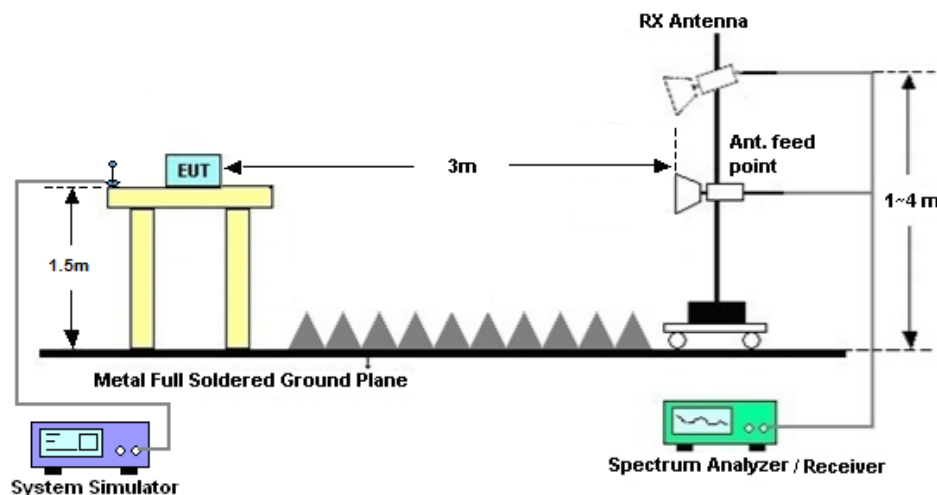

4.3 Test Result of Radiated Test

Please refer to Appendix B.



4.4 Field Strength of Spurious Radiation Measurement

4.4.1 Description of Field Strength of Spurious Radiated Measurement

The power of any emission outside of the authorized operating frequency ranges must be attenuated below the transmitter power (P) by a factor of at least $43 + 10 \log (P)$ dB. The spectrum is scanned from 30 MHz up to a frequency including its 10th harmonic.

4.4.2 Test Procedures

1. The testing follows ANSI C63.26 Section 5.5
2. The EUT was placed on a rotatable wooden table 0.8 meters for frequency below 1GHz and 1.5 meter for frequency above 1GHz above the ground.
3. The EUT was set 3 meters from the receiving antenna, which was mounted on the antenna tower.
4. The table was rotated 360 degrees to determine the position of the highest spurious emission.
5. The height of the receiving antenna is varied between one meter and four meters to search for the maximum spurious emission for both horizontal and vertical polarizations.
6. Make the measurement with the spectrum analyzer's RBW = 1MHz, VBW = 3MHz, taking record of maximum spurious emission.
7. A horn antenna was substituted in place of the EUT and was driven by a signal generator.
8. Tune the output power of signal generator to the same emission level with EUT maximum spurious emission.
9. Taking the record of output power at antenna port.
10. Repeat step 7 to step 8 for another polarization.
11. $EIRP \text{ (dBm)} = S.G. \text{ Power} - Tx \text{ Cable Loss} + Tx \text{ Antenna Gain}$
12. $ERP \text{ (dBm)} = EIRP - 2.15$
13. The RF fundamental frequency should be excluded against the limit line in the operating frequency band.
14. The limit line is derived from $43 + 10\log(P)$ dB below the transmitter power P(Watts)



5 List of Measuring Equipment

| Instrument | Manufacturer | Model No. | Serial No. | Characteristics | Calibration Date | Test Date | Due Date | Remark |
|-----------------------|--------------|--------------------------------|------------|----------------------|------------------|---------------------------------|---------------|-----------------------|
| Spectrum Analyzer | R&S | FSV40 | 101040 | 10Hz~40GHz | Aug. 07, 2018 | Jun. 20, 2019~ Jul. 03, 2019 | Aug. 06, 2019 | Conducted (TH01-KS) |
| Thermal Chamber | Ten Billion | TTC-B3S | TBN-960502 | -40~+150°C | Nov. 19, 2018 | Jun. 20, 2019~ Jul. 03, 2019 | Nov. 18, 2019 | Conducted (TH01-KS) |
| EXA Spectrum Analyzer | Keysight | N9010A | MY55150244 | 10Hz-44G,MAX 30dB | Apr.16, 2019 | Jun. 18, 2019~ Jun. 19, 2019 | Apr. 15, 2020 | Radiation (03CH04-KS) |
| Bilog Antenna | TeseQ | CBL6111D | 44483 | 30MHz-1GHz | Dec. 28, 2018 | Jun. 18, 2019~ Jun. 19, 2019 | Dec. 27, 2019 | Radiation (03CH04-KS) |
| Horn Antenna | Schwarzbeck | BBHA9120D | 1648 | 1GHz~18GHz | Jan. 27, 2019 | Jun. 18, 2019~ Jun. 19, 2019 | Jan. 26, 2020 | Radiation (03CH04-KS) |
| SHF-EHF Horn | Com-power | AH-840 | 101070 | 18GHz~40GHz | Jan. 05, 2019 | Jun. 18, 2019~ Jun. 19, 2019 | Jan. 04, 2020 | Radiation (03CH04-KS) |
| Amplifier | SONOMA | 310N | 187289 | 9KHz-1GHz | Aug..06.2018 | Jun. 18, 2019~ Jun. 19, 2019 | Aug. 05, 2019 | Radiation (03CH04-KS) |
| Amplifier | MITEQ | TTA1840-35 -HG | 2014749 | 18~40GHz | Jan. 14, 2019 | Jun. 18, 2019~ Jun. 19, 2019 | Jan.13, 2020 | Radiation (03CH04-KS) |
| high gain Amplifier | MITEQ | AMF-7D-00 101800-30-1 0P | 2025788 | 1Ghz-18Ghz | Aug.16.2018 | Jun. 18, 2019~ Jun. 19, 2019 | Aug.15,2019 | Radiation (03CH04-KS) |
| Amplifier | Keysight | 83017A | MY53270319 | 500MHz~26.5GHz | Oct. 12, 2018 | Jun. 18, 2019~ Jun. 19, 2019 | Oct. 11, 2019 | Radiation (03CH04-KS) |
| AC Power Source | Chroma | 61601 | F104090004 | N/A | NCR | Jun. 18, 2019~ Jun. 19, 2019 | NCR | Radiation (03CH04-KS) |
| Turn Table | ChamPro | EM 1000-T | 060762-T | 0~360 degree | NCR | Jun. 18, 2019~ Jun. 19, 2019 | NCR | Radiation (03CH04-KS) |
| Antenna Mast | ChamPro | EM 1000-A | 060762-A | 1 m~4 m | NCR | Jun. 18, 2019~ Jun. 19, 2019 | NCR | Radiation (03CH04-KS) |

NCR: No Calibration Required



6 Uncertainty of Evaluation

The measurement uncertainties shown below were calculated in accordance with the requirements of ANSI 63.26-2015. All the measurement uncertainty value were shown with a coverage K=2 to indicate 95% level of confidence. The measurement data show herein meets or exceeds the CISPR measurement uncertainty values specified in CISPR 16-4-2 and can be compared directly to specified limit to determine compliance.

Uncertainty of Radiated Emission Measurement (30 MHz ~ 1000 MHz)

| | |
|---|-------|
| Measuring Uncertainty for a Level of Confidence of 95% (U = 2Uc(y)) | 3.3dB |
|---|-------|

Uncertainty of Radiated Emission Measurement (1 GHz ~ 18 GHz)

| | |
|---|-------|
| Measuring Uncertainty for a Level of Confidence of 95% (U = 2Uc(y)) | 2.8dB |
|---|-------|

Uncertainty of Radiated Emission Measurement (18 GHz ~ 40 GHz)

| | |
|---|-------|
| Measuring Uncertainty for a Level of Confidence of 95% (U = 2Uc(y)) | 2.8dB |
|---|-------|



Appendix A. Test Results of Conducted Test

Conducted Output Power(Average power)

| Conducted Power (*Unit: dBm) | | | | | | |
|------------------------------|--------|-------|-------|---------|--------|--------|
| Band | GSM850 | | | GSM1900 | | |
| Channel | 128 | 189 | 251 | 512 | 661 | 810 |
| Frequency | 824.2 | 836.4 | 848.8 | 1850.2 | 1880.0 | 1909.8 |
| GSM | 32.51 | 32.71 | 32.74 | 29.39 | 29.42 | 29.29 |
| GPRS class 8 | 32.50 | 32.70 | 32.73 | 29.38 | 29.41 | 29.28 |
| GPRS class 10 | 29.21 | 29.43 | 29.47 | 26.21 | 26.20 | 26.10 |
| GPRS class 11 | 27.12 | 27.38 | 27.46 | 24.22 | 24.21 | 24.11 |
| GPRS class 12 | 26.09 | 26.36 | 26.46 | 23.23 | 23.26 | 23.19 |
| EGPRS class 8 | 27.15 | 27.05 | 27.10 | 26.14 | 26.12 | 26.13 |
| EGPRS class 10 | 27.10 | 26.96 | 27.05 | 26.05 | 26.01 | 26.04 |
| EGPRS class 11 | 25.45 | 25.29 | 25.31 | 24.15 | 24.12 | 24.14 |
| EGPRS class 12 | 24.21 | 24.06 | 24.08 | 22.62 | 22.63 | 22.71 |



| Conducted Power (*Unit: dBm) | | | | | | | | | |
|------------------------------|--------------|-------|-------|---------------|-------|--------|---------------|--------|--------|
| Band | WCDMA Band V | | | WCDMA Band II | | | WCDMA Band IV | | |
| Channel | 4132 | 4182 | 4233 | 9262 | 9400 | 9538 | 1312 | 1413 | 1513 |
| Frequency | 826.4 | 836.4 | 846.6 | 1852.4 | 1880 | 1907.6 | 1712.4 | 1732.6 | 1752.6 |
| AMR 12.2K | 22.90 | 22.96 | 23.20 | 23.20 | 23.34 | 23.25 | 22.87 | 22.89 | 22.79 |
| RMC 12.2K | 22.91 | 22.97 | 23.21 | 23.21 | 23.36 | 23.27 | 22.89 | 22.91 | 22.80 |
| HSDPA Subtest-1 | 22.12 | 22.17 | 22.42 | 22.25 | 22.47 | 22.34 | 22.07 | 22.13 | 22.02 |
| HSDPA Subtest-2 | 22.13 | 22.19 | 22.41 | 22.24 | 22.37 | 22.29 | 22.06 | 22.10 | 22.03 |
| HSDPA Subtest-3 | 21.62 | 21.81 | 21.90 | 21.70 | 21.90 | 21.79 | 21.52 | 21.61 | 21.66 |
| HSDPA Subtest-4 | 21.64 | 21.72 | 21.86 | 21.75 | 21.89 | 21.77 | 21.54 | 21.59 | 21.60 |
| DC-HSDPA Subtest-1 | 22.16 | 22.38 | 22.25 | 22.03 | 22.08 | 22.33 | 21.98 | 22.04 | 21.93 |
| DC-HSDPA Subtest-2 | 22.15 | 22.28 | 22.20 | 22.04 | 22.10 | 22.32 | 21.97 | 22.01 | 21.94 |
| DC-HSDPA Subtest-3 | 21.61 | 21.81 | 21.70 | 21.53 | 21.72 | 21.81 | 21.43 | 21.52 | 21.57 |
| DC-HSDPA Subtest-4 | 21.66 | 21.80 | 21.68 | 21.55 | 21.63 | 21.77 | 21.45 | 21.50 | 21.51 |
| HSUPA Subtest-1 | 20.12 | 20.18 | 20.39 | 20.38 | 20.39 | 20.37 | 20.35 | 20.37 | 20.35 |
| HSUPA Subtest-2 | 20.03 | 20.19 | 20.40 | 20.20 | 20.30 | 20.28 | 20.21 | 20.25 | 20.21 |
| HSUPA Subtest-3 | 21.11 | 21.31 | 21.43 | 21.27 | 21.25 | 21.32 | 21.01 | 21.05 | 21.09 |
| HSUPA Subtest-4 | 19.63 | 19.70 | 19.90 | 19.98 | 19.91 | 20.05 | 19.80 | 19.81 | 19.92 |
| HSUPA Subtest-5 | 21.10 | 21.10 | 21.40 | 22.50 | 22.41 | 22.45 | 22.10 | 22.15 | 22.21 |
| HSPA+ (16QAM) Subtest-1 | 20.55 | 20.52 | 20.60 | 21.14 | 21.30 | 21.23 | 20.78 | 20.70 | 20.65 |



ERP/EIRP

| GSM850 (G_T - L_C= -3.30 dB) | | | |
|---|--------------|--------------|---------------|
| Channel | 128 | 189 | 251 |
| | (Low) | (Mid) | (High) |
| Frequency | 824.2 | 836.4 | 848.8 |
| (MHz) | | | |
| Conducted Power (dBm) | 32.51 | 32.71 | 32.74 |
| Conducted Power (Watts) | 1.7824 | 1.8664 | 1.8793 |
| ERP(dBm) | 27.06 | 27.26 | 27.29 |
| ERP(Watts) | 0.5082 | 0.5321 | 0.5358 |

| EDGE850 (G_T - L_C= -3.30 dB) | | | |
|--|--------------|--------------|---------------|
| Channel | 128 | 189 | 251 |
| | (Low) | (Mid) | (High) |
| Frequency | 824.2 | 836.4 | 848.8 |
| (MHz) | | | |
| Conducted Power (dBm) | 27.15 | 27.05 | 27.10 |
| Conducted Power (Watts) | 0.5188 | 0.5070 | 0.5129 |
| ERP(dBm) | 21.70 | 21.60 | 21.65 |
| ERP(Watts) | 0.1479 | 0.1445 | 0.1462 |



| GSM1900 (G _T - L _C = -1.11 dB) | | | |
|--|--------|--------|--------|
| Channel | 512 | 661 | 810 |
| | (Low) | (Mid) | (High) |
| Frequency | 1850.2 | 1880 | 1909.8 |
| (MHz) | | | |
| Conducted Power (dBm) | 29.39 | 29.42 | 29.29 |
| Conducted Power (Watts) | 0.8690 | 0.8750 | 0.8492 |
| EIRP(dBm) | 28.28 | 28.31 | 28.18 |
| EIRP(Watts) | 0.6730 | 0.6776 | 0.6577 |

| EDGE1900 (G _T - L _C = -1.11 dB) | | | |
|---|--------|--------|--------|
| Channel | 512 | 661 | 810 |
| | (Low) | (Mid) | (High) |
| Frequency | 1850.2 | 1880 | 1909.8 |
| (MHz) | | | |
| Conducted Power (dBm) | 26.14 | 26.12 | 26.13 |
| Conducted Power (Watts) | 0.4111 | 0.4093 | 0.4102 |
| EIRP(dBm) | 25.03 | 25.01 | 25.02 |
| EIRP(Watts) | 0.3184 | 0.3170 | 0.3177 |



| WCDMA Band V ($G_T - L_C = -3.30$ dB) | | | |
|--|--------|--------|--------|
| Channel | 4132 | 4182 | 4233 |
| | (Low) | (Mid) | (High) |
| Frequency | 826.4 | 836.4 | 846.6 |
| (MHz) | | | |
| Conducted Power (dBm) | 22.91 | 22.97 | 23.21 |
| Conducted Power (Watts) | 0.1954 | 0.1982 | 0.2094 |
| ERP(dBm) | 17.46 | 17.52 | 17.76 |
| ERP(Watts) | 0.0557 | 0.0565 | 0.0597 |

| WCDMA Band II ($G_T - L_C = -1.11$ dB) | | | |
|---|--------|--------|--------|
| Channel | 9262 | 9400 | 9538 |
| | (Low) | (Mid) | (High) |
| Frequency | 1852.4 | 1880 | 1907.6 |
| (MHz) | | | |
| Conducted Power (dBm) | 23.21 | 23.36 | 23.27 |
| Conducted Power (Watts) | 0.2094 | 0.2168 | 0.2123 |
| EIRP(dBm) | 22.10 | 22.25 | 22.16 |
| EIRP(Watts) | 0.1622 | 0.1679 | 0.1644 |

| WCDMA Band IV ($G_T - L_C = -0.06$ dB) | | | |
|---|--------|--------|--------|
| Channel | 1312 | 1413 | 1513 |
| | (Low) | (Mid) | (High) |
| Frequency | 1712.4 | 1732.6 | 1752.6 |
| (MHz) | | | |
| Conducted Power (dBm) | 22.89 | 22.91 | 22.80 |
| Conducted Power (Watts) | 0.1945 | 0.1954 | 0.1905 |
| EIRP(dBm) | 22.83 | 22.85 | 22.74 |
| EIRP(Watts) | 0.1919 | 0.1928 | 0.1879 |



Peak-to-Average Ratio

| Mode | GSM850 | | Limit: 13dB |
|------------|--------|--------------|-------------|
| Mod. | GSM | EDGE class 8 | Result |
| Lowest CH | 0.12 | 3.13 | PASS |
| Middle CH | 0.12 | 3.28 | |
| Highest CH | 0.12 | 3.16 | |

| Mode | GSM1900 | | Limit: 13dB |
|------------|---------|--------------|-------------|
| Mod. | GSM | EDGE class 8 | Result |
| Lowest CH | 0.14 | 3.39 | PASS |
| Middle CH | 0.12 | 3.25 | |
| Highest CH | 0.12 | 3.30 | |

| Mode | WCDMA Band V | WCDMA Band II | WCDMA Band IV | Limit: 13dB |
|------------|--------------|---------------|---------------|-------------|
| Mod. | RMC 12.2Kbps | RMC 12.2Kbps | RMC 12.2Kbps | Result |
| Lowest CH | 3.22 | 3.07 | 2.99 | PASS |
| Middle CH | 3.07 | 3.07 | 2.99 | |
| Highest CH | 3.10 | 3.16 | 2.93 | |

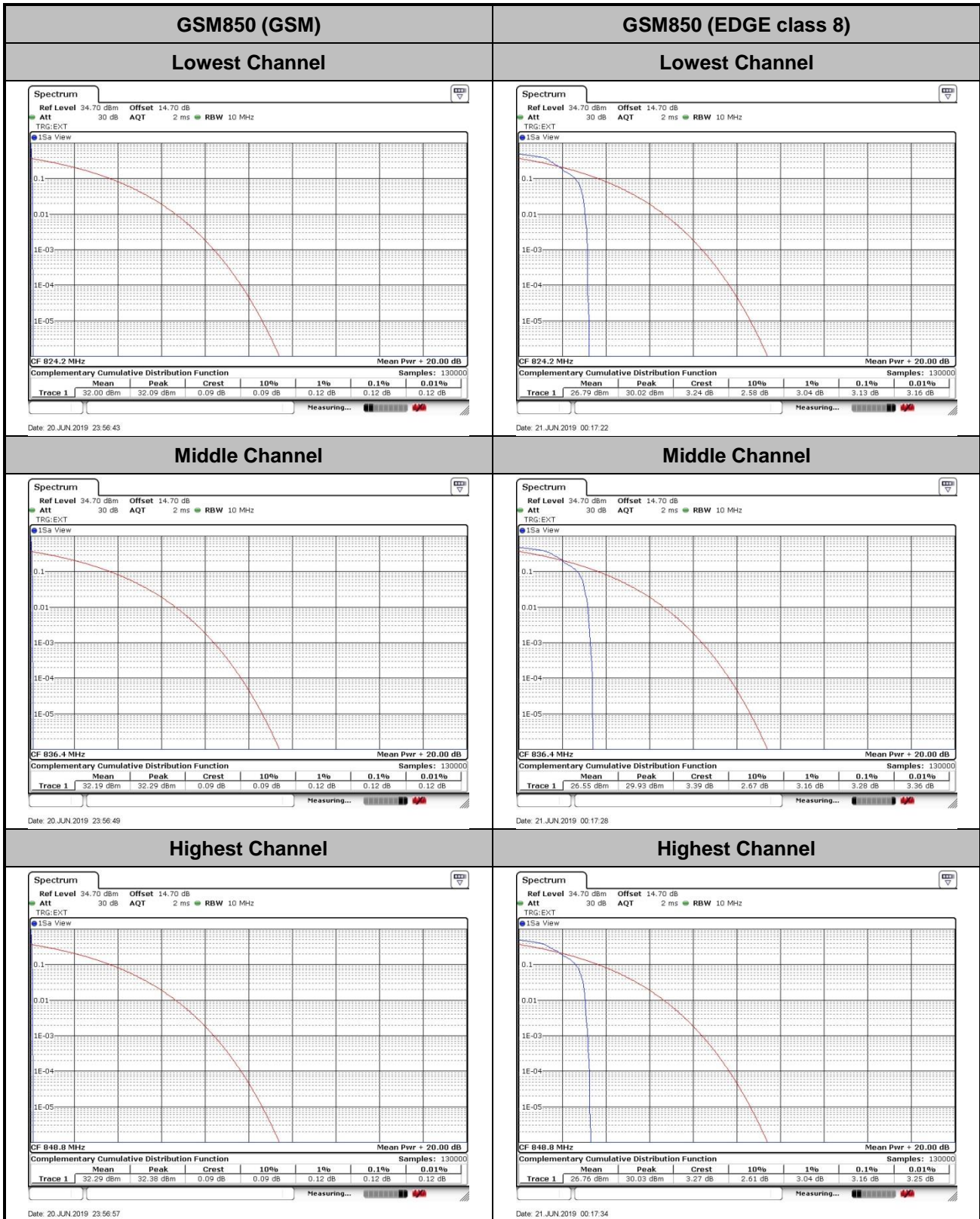

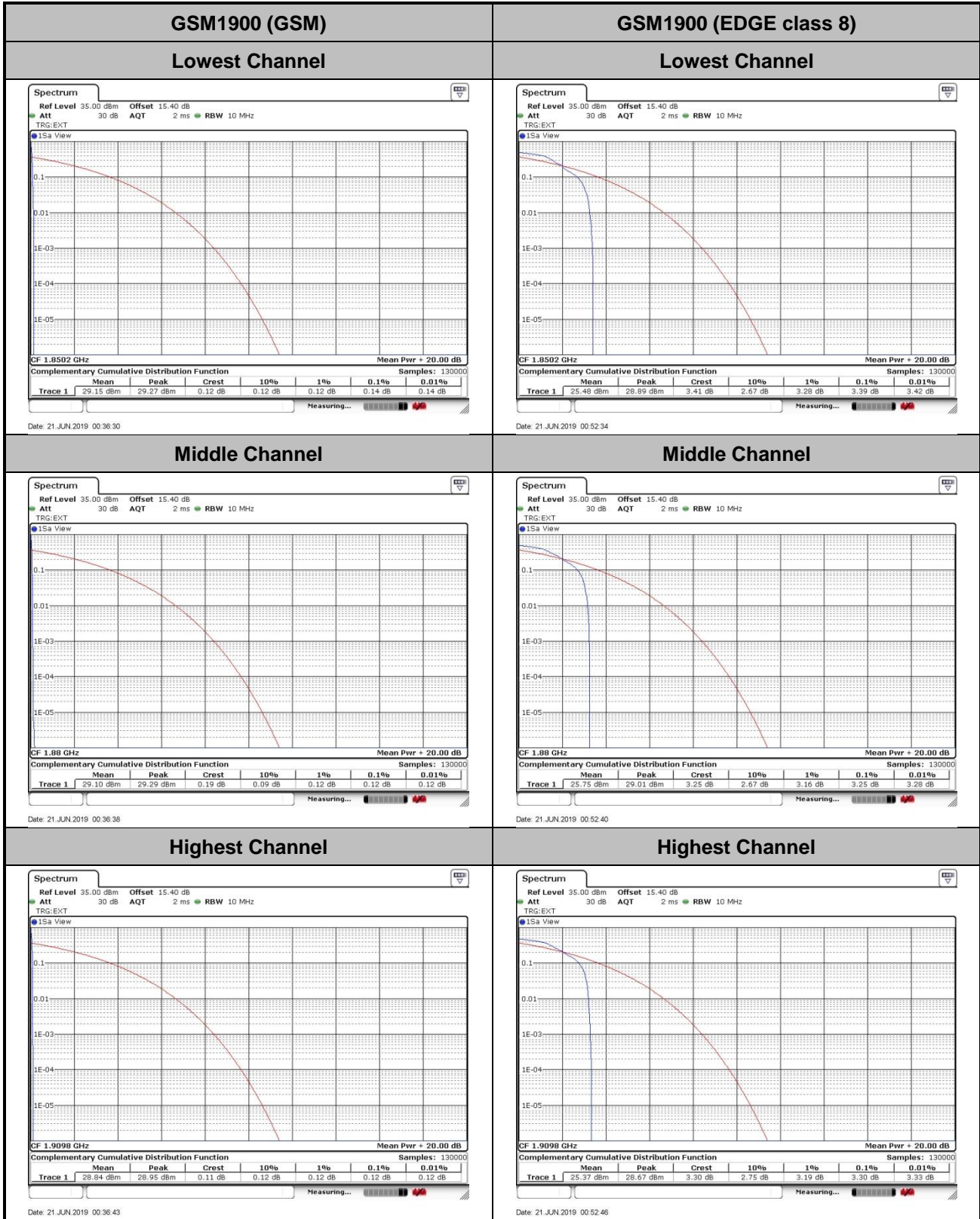

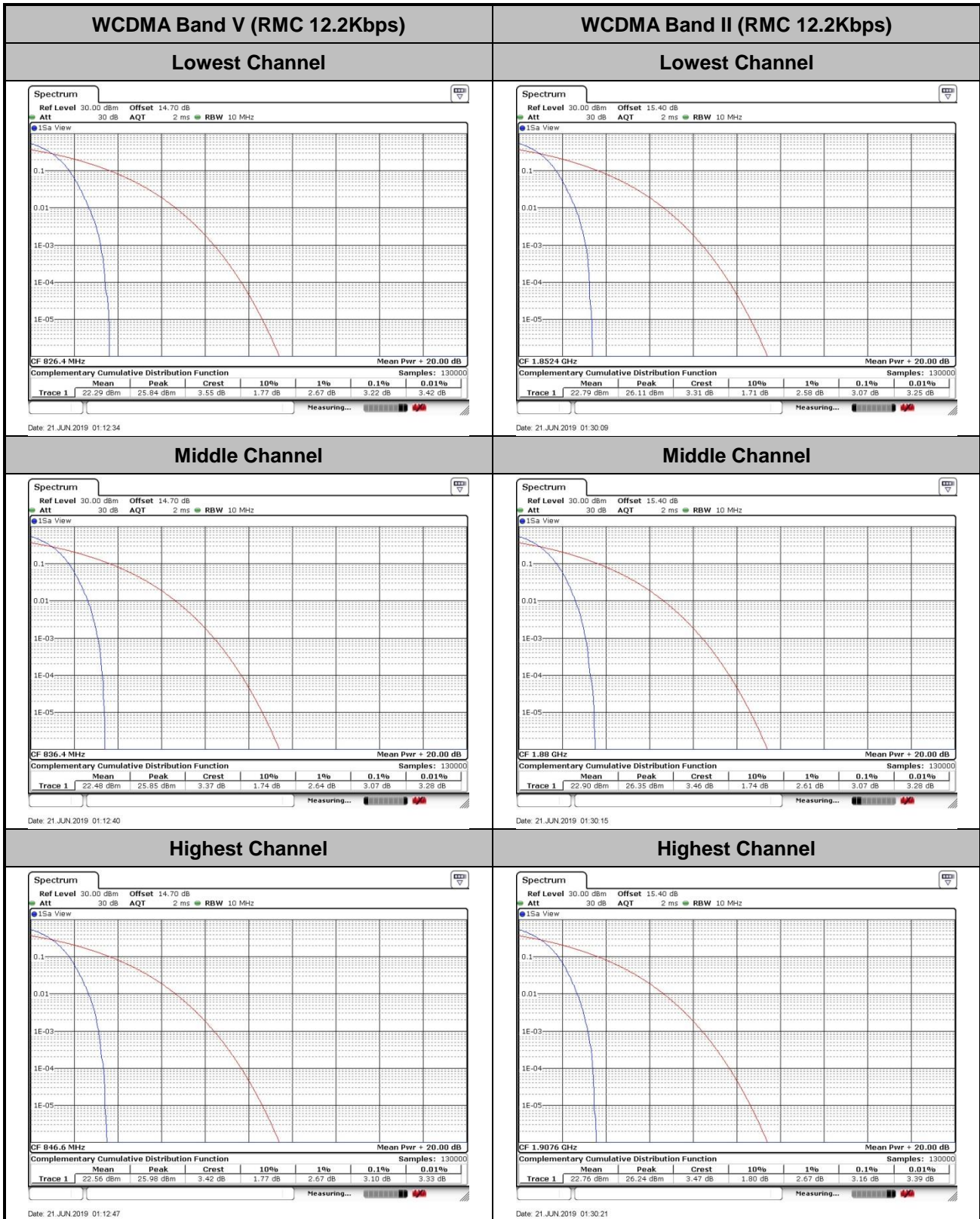

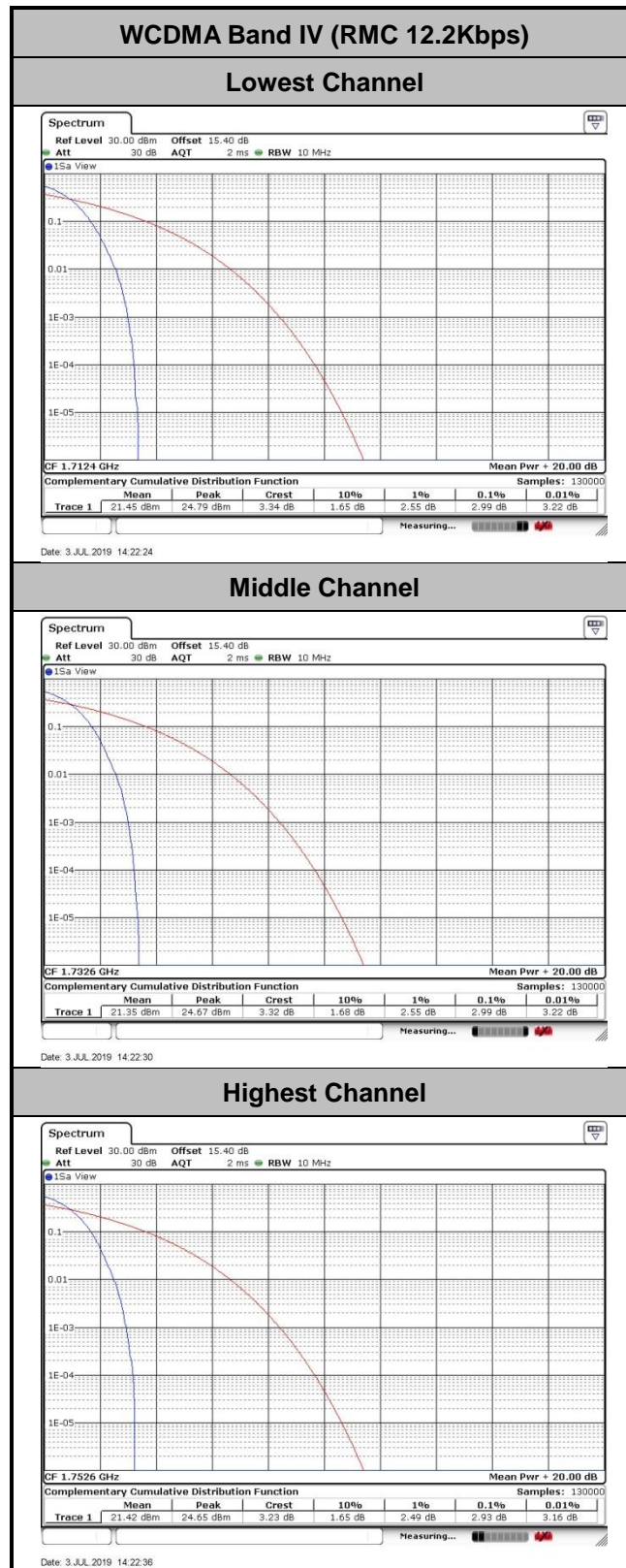



26dB Bandwidth

| Mode | GSM850 | |
|------------|--------|--------------|
| Mod. | GSM | EDGE class 8 |
| Lowest CH | 0.316 | 0.313 |
| Middle CH | 0.316 | 0.315 |
| Highest CH | 0.317 | 0.311 |

| Mode | GSM1900 | |
|------------|---------|--------------|
| Mod. | GSM | EDGE class 8 |
| Lowest CH | 0.315 | 0.313 |
| Middle CH | 0.315 | 0.312 |
| Highest CH | 0.317 | 0.315 |

| Mode | WCDMA Band V | WCDMA Band II | WCDMA Band IV |
|------------|--------------|---------------|---------------|
| Mod. | RMC 12.2Kbps | RMC 12.2Kbps | RMC 12.2Kbps |
| Lowest CH | 4.695 | 4.705 | 4.695 |
| Middle CH | 4.695 | 4.705 | 4.705 |
| Highest CH | 4.705 | 4.695 | 4.705 |



GSM850 (GSM)

Lowest Channel



Date: 20 JUN 2019 23:42:09

GSM850 (EDGE class 8)

Lowest Channel

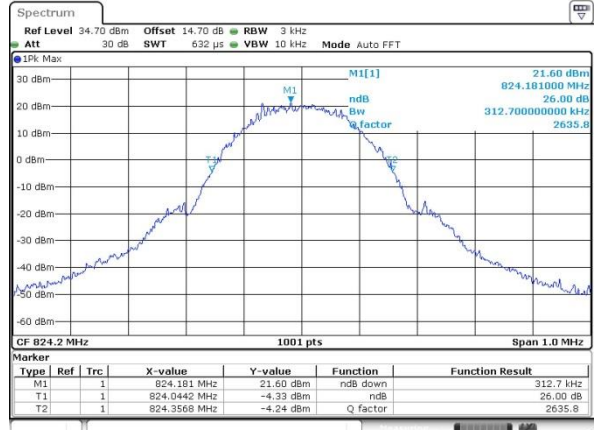

Date: 21 JUN 2019 00:00:11

Middle Channel

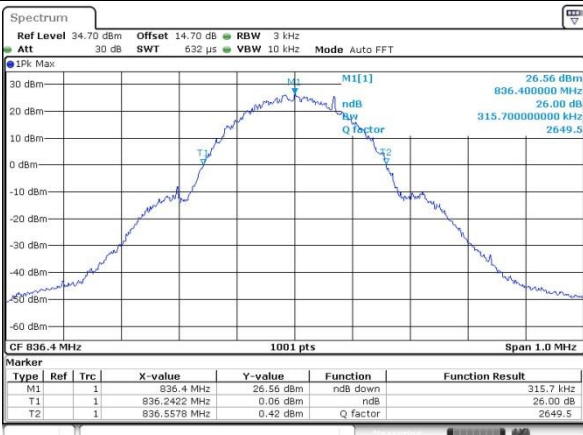

Date: 20 JUN 2019 23:42:46

Middle Channel

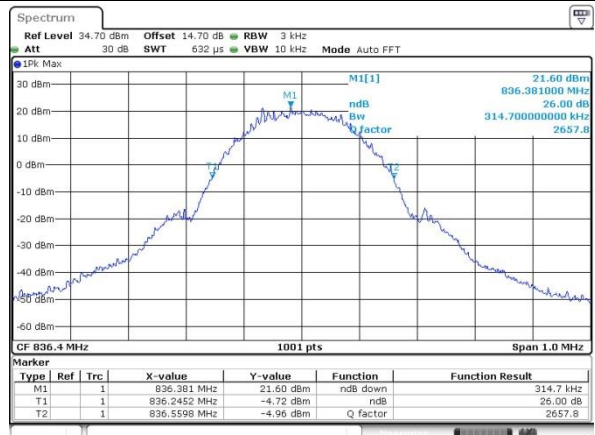

Date: 21 JUN 2019 00:04:45

Highest Channel



Date: 20 JUN 2019 23:43:19

Highest Channel

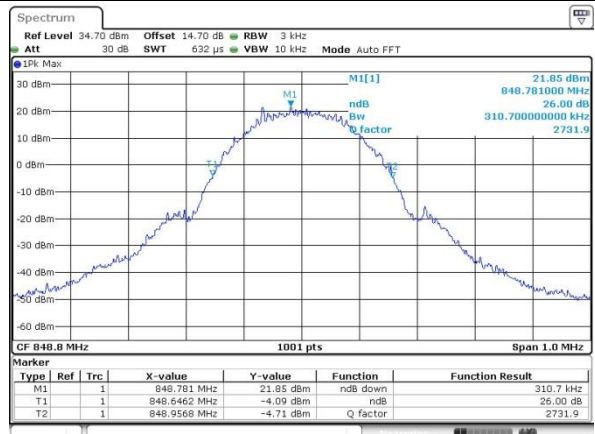

Date: 21 JUN 2019 00:05:16



GSM1900 (GSM)

Lowest Channel

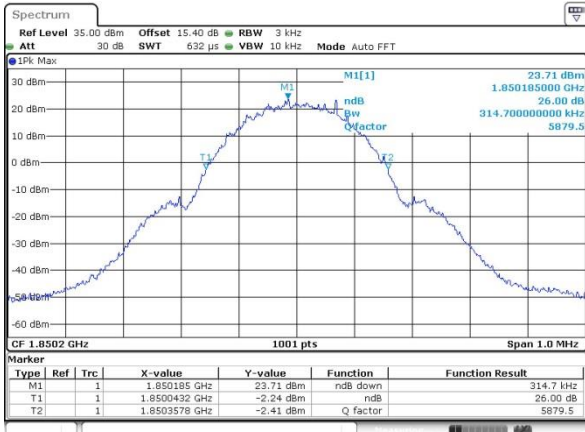

Date: 21 JUN 2019 00:19:58

GSM1900 (EDGE class 8)

Lowest Channel

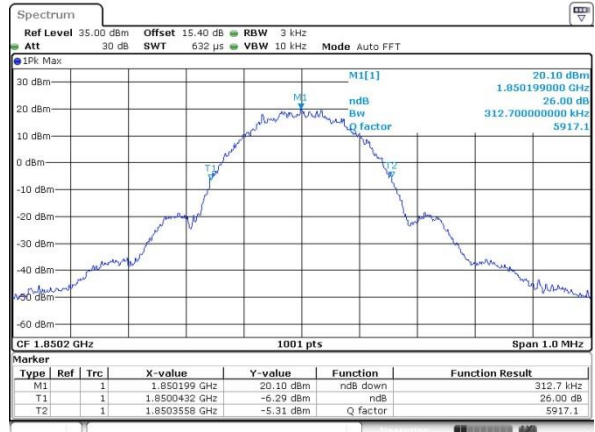

Date: 21 JUN 2019 00:38:50

Middle Channel

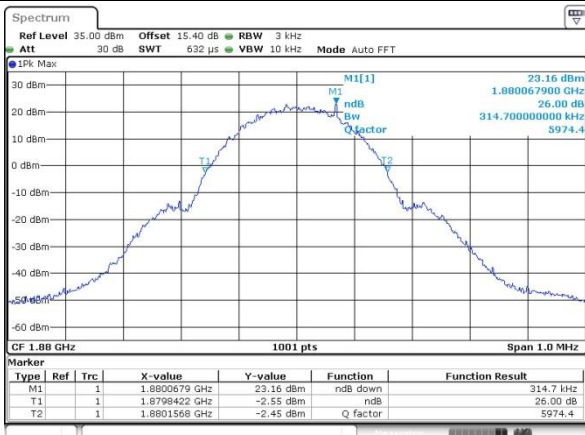

Date: 21 JUN 2019 00:20:30

Middle Channel

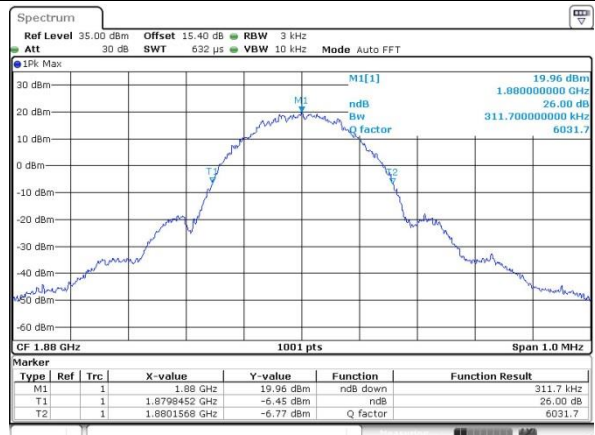

Date: 21 JUN 2019 00:39:20

Highest Channel

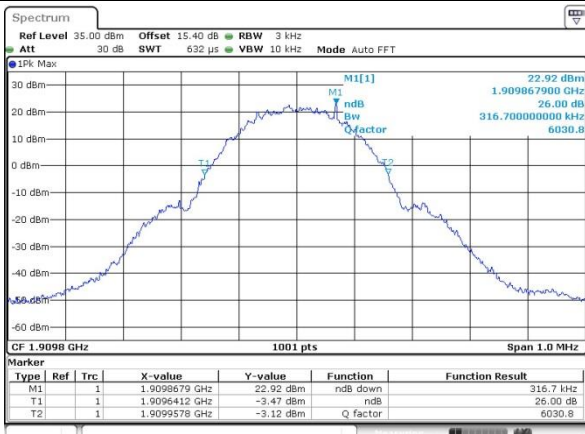

Date: 21 JUN 2019 00:21:02

Highest Channel

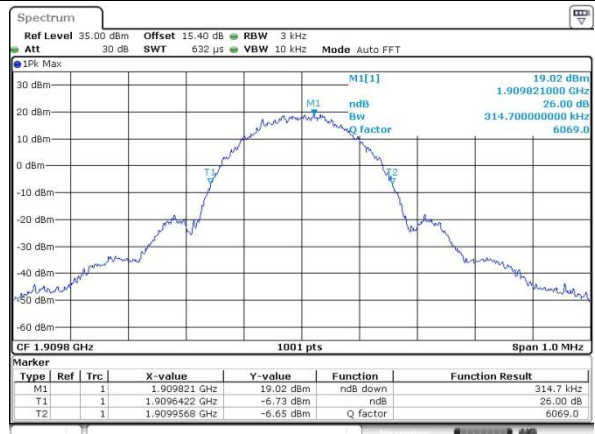

Date: 21 JUN 2019 00:39:52



WCDMA Band V (RMC 12.2Kbps)

Lowest Channel

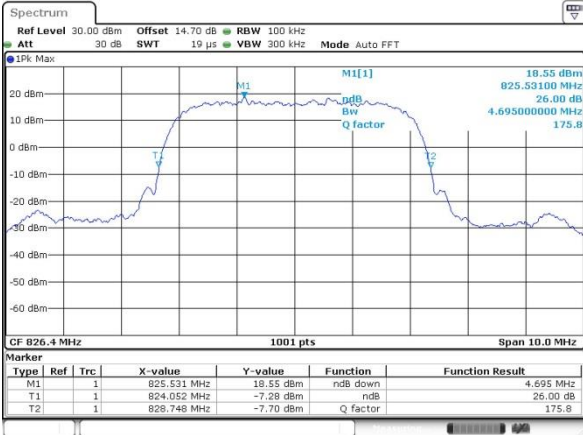

Date: 21 JUN 2019 00:56:11

WCDMA Band II (RMC 12.2Kbps)

Lowest Channel

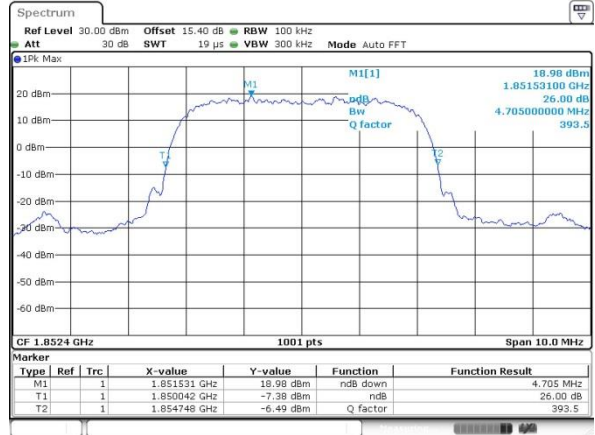

Date: 21 JUN 2019 01:14:12

Middle Channel

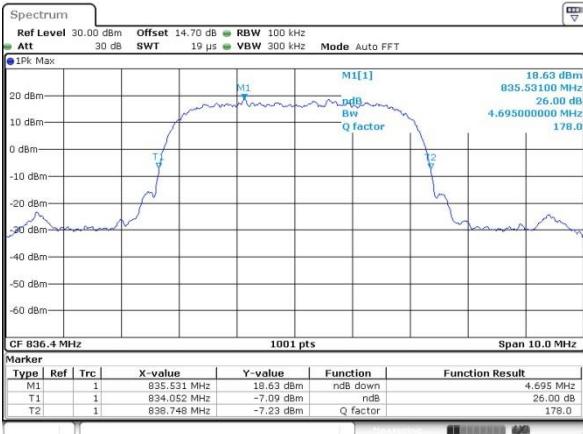

Date: 21 JUN 2019 00:56:52

Middle Channel

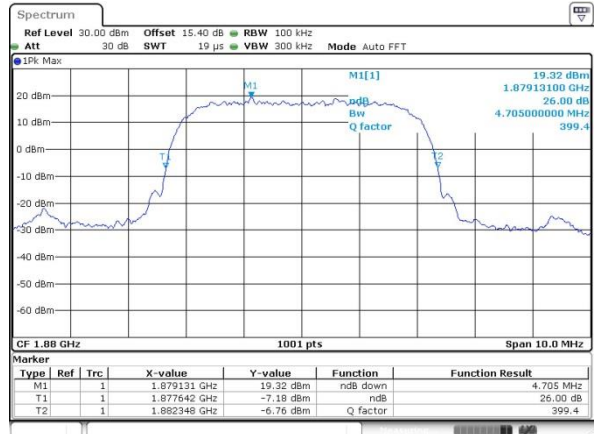

Date: 21 JUN 2019 01:14:45

Highest Channel

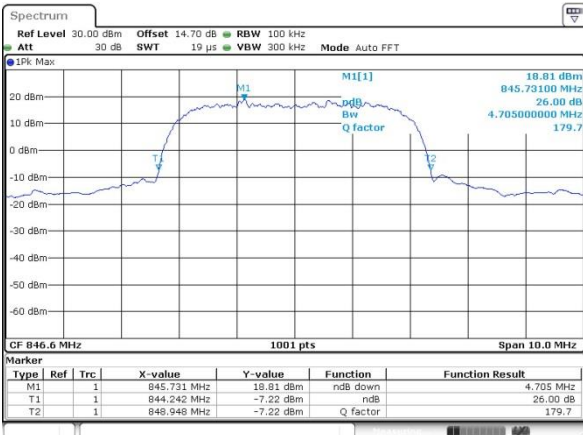

Date: 21 JUN 2019 00:57:25

Highest Channel

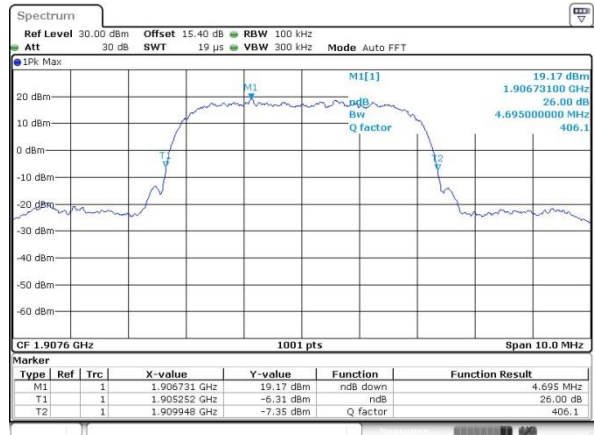

Date: 21 JUN 2019 01:15:15

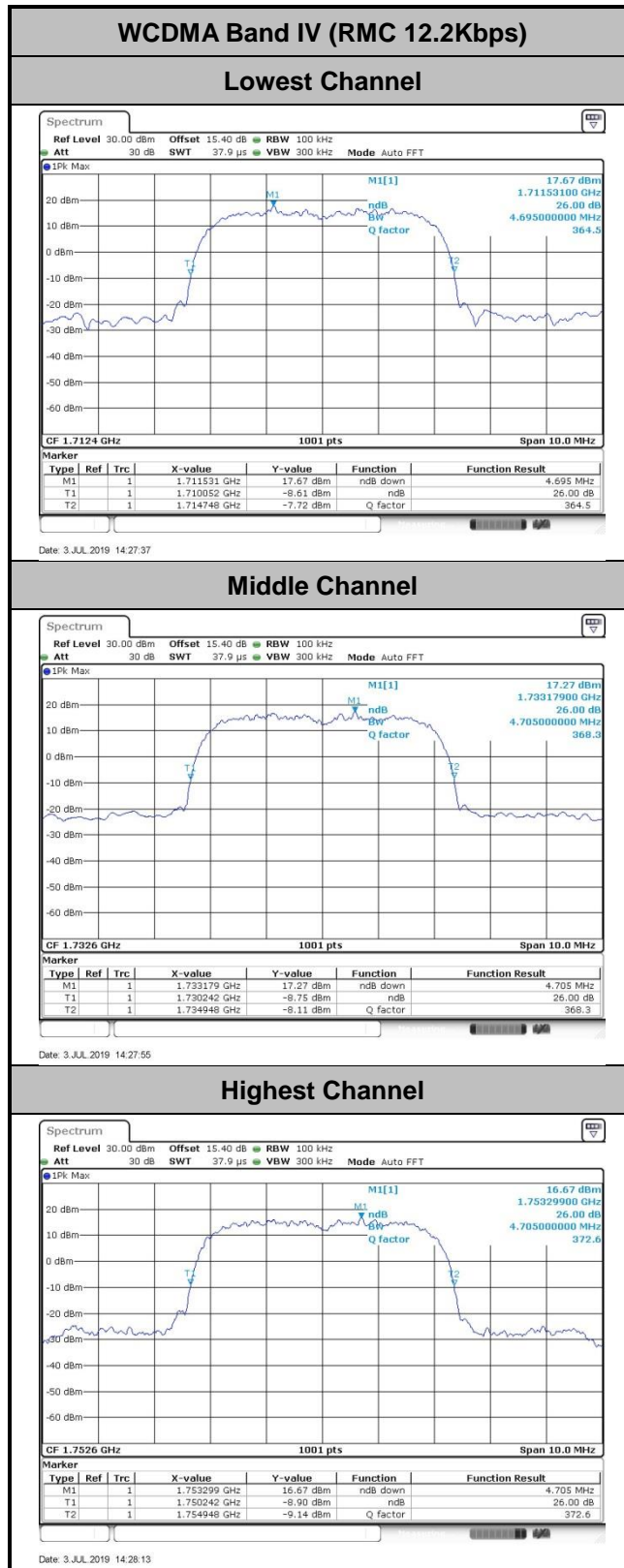



Occupied Bandwidth

| Mode | GSM850 | |
|------------|--------|--------------|
| Mod. | GSM | EDGE class 8 |
| Lowest CH | 0.244 | 0.244 |
| Middle CH | 0.245 | 0.247 |
| Highest CH | 0.242 | 0.246 |

| Mode | GSM1900 | |
|------------|---------|--------------|
| Mod. | GSM | EDGE class 8 |
| Lowest CH | 0.244 | 0.245 |
| Middle CH | 0.244 | 0.245 |
| Highest CH | 0.245 | 0.241 |

| Mode | WCDMA Band V | WCDMA Band II | WCDMA Band IV |
|------------|--------------|---------------|---------------|
| Mod. | RMC 12.2Kbps | RMC 12.2Kbps | RMC 12.2Kbps |
| Lowest CH | 4.156 | 4.156 | 4.166 |
| Middle CH | 4.156 | 4.166 | 4.156 |
| Highest CH | 4.166 | 4.166 | 4.166 |



GSM850 (GSM)

Lowest Channel

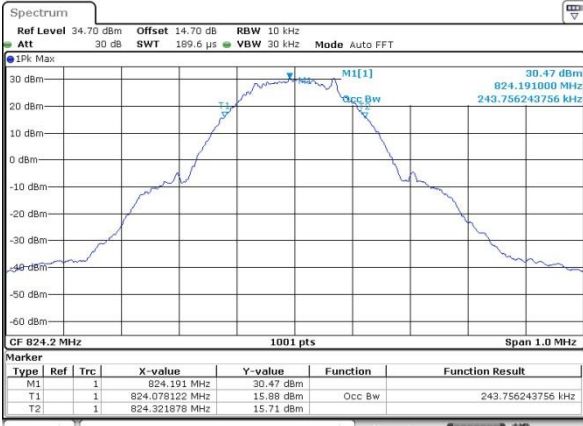

Date: 20 JUN 2019 23:46:26

GSM850 (EDGE class 8)

Lowest Channel

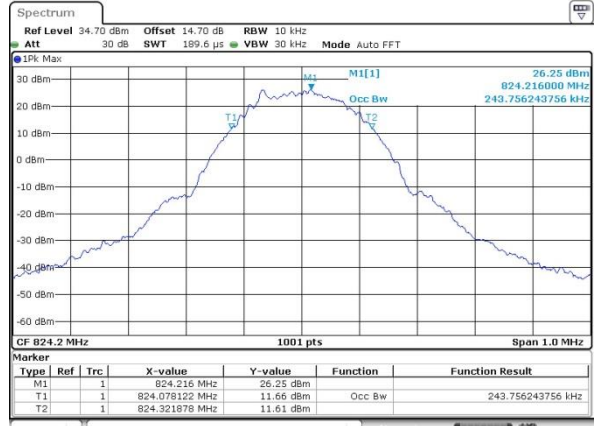

Date: 21 JUN 2019 00:07:40

Middle Channel

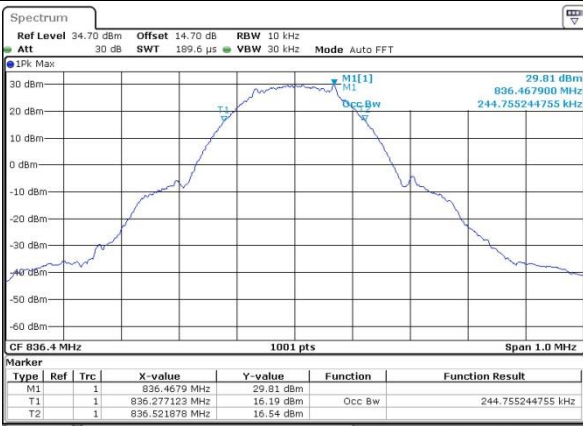

Date: 20 JUN 2019 23:46:58

Middle Channel

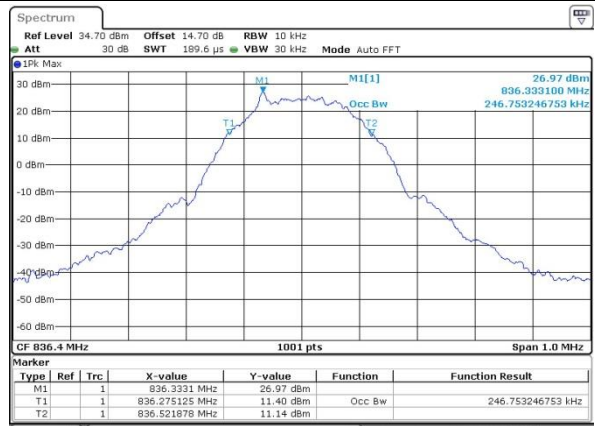

Date: 21 JUN 2019 00:08:10

Highest Channel

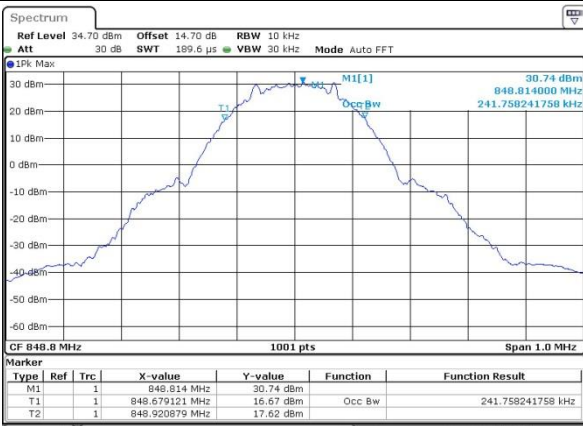

Date: 20 JUN 2019 23:47:37

Highest Channel

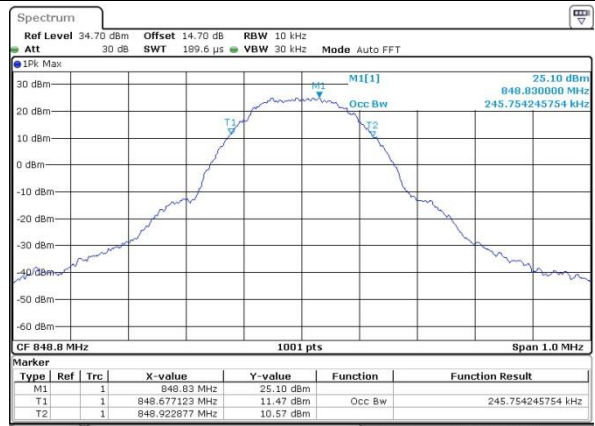

Date: 21 JUN 2019 00:08:39



GSM1900 (GSM)

Lowest Channel

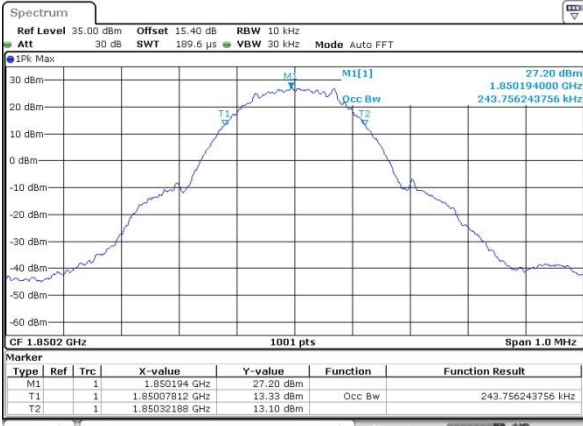

Date: 21 JUN 2019 00:23:13

GSM1900 (EDGE class 8)

Lowest Channel

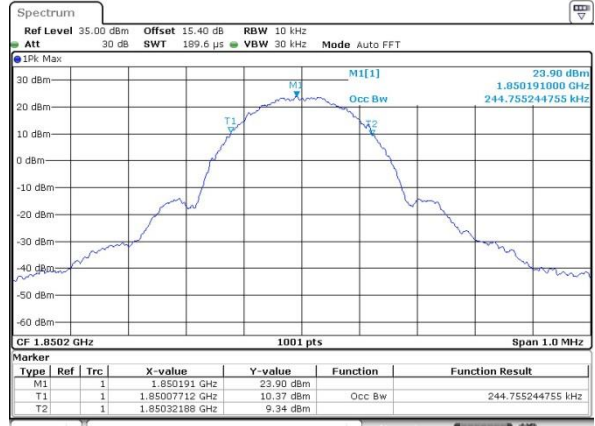

Date: 21 JUN 2019 00:42:39

Middle Channel

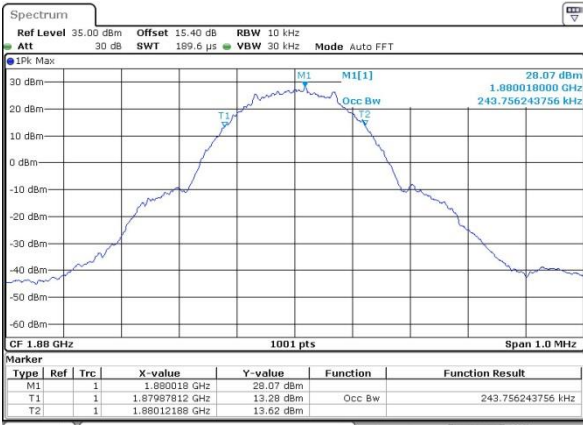

Date: 21 JUN 2019 00:23:44

Middle Channel

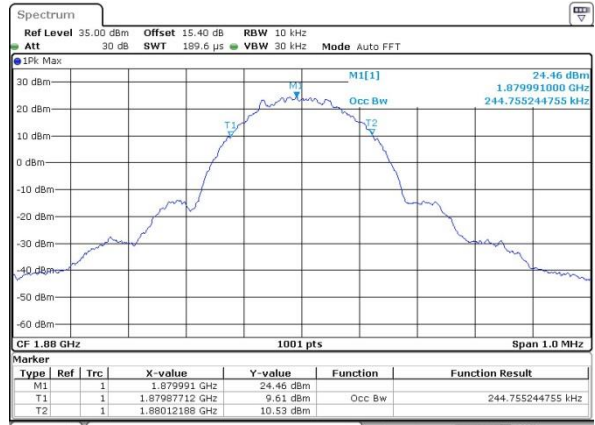

Date: 21 JUN 2019 00:43:08

Highest Channel

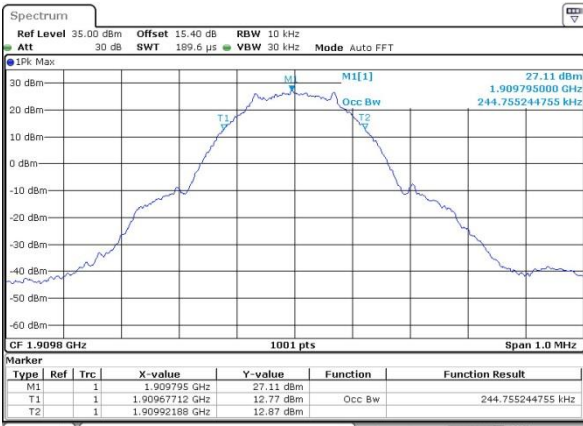

Date: 21 JUN 2019 00:24:13

Highest Channel

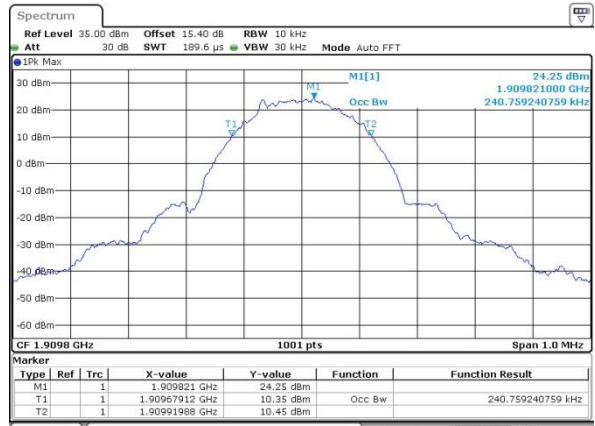

Date: 21 JUN 2019 00:43:37



WCDMA Band V (RMC 12.2Kbps)

Lowest Channel

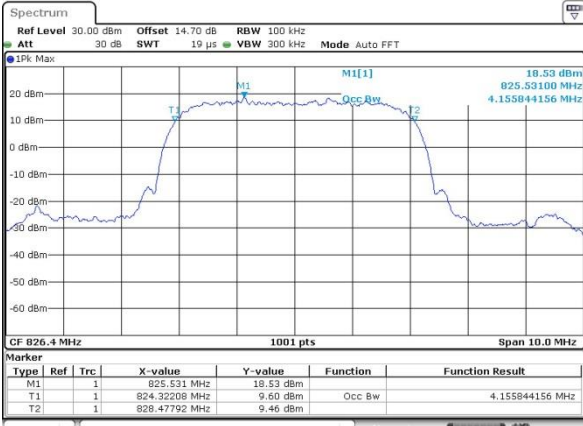

Date: 21 JUN 2019 00:58:01

WCDMA Band II (RMC 12.2Kbps)

Lowest Channel

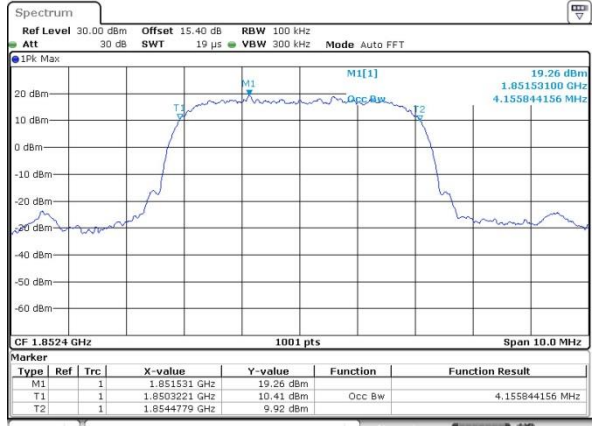

Date: 21 JUN 2019 01:17:36

Middle Channel

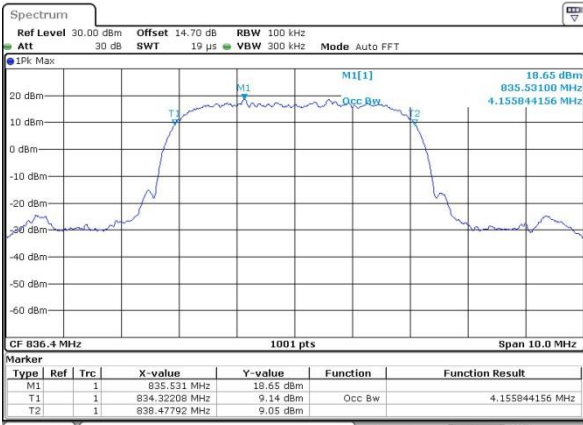

Date: 21 JUN 2019 00:58:31

Middle Channel

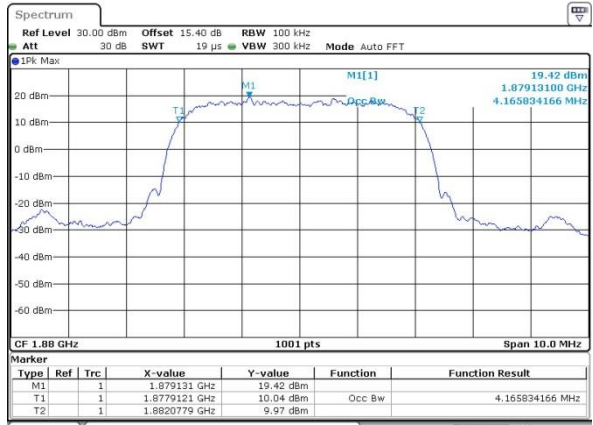

Date: 21 JUN 2019 01:18:11

Highest Channel

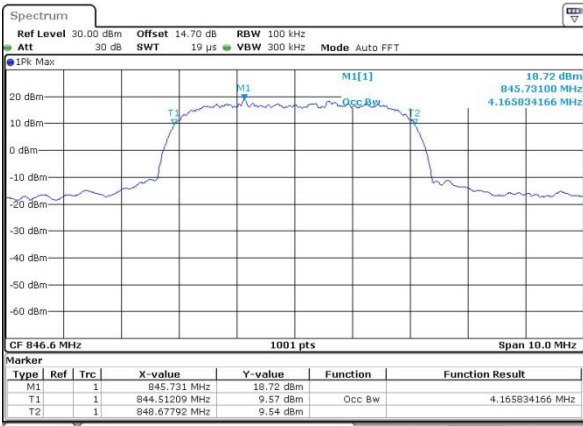

Date: 21 JUN 2019 00:59:01

Highest Channel

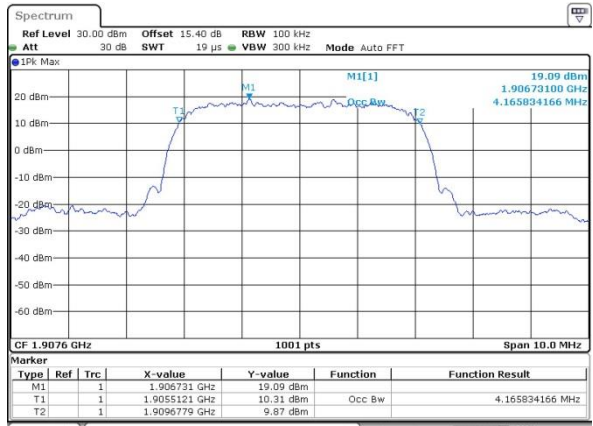

Date: 21 JUN 2019 01:18:40

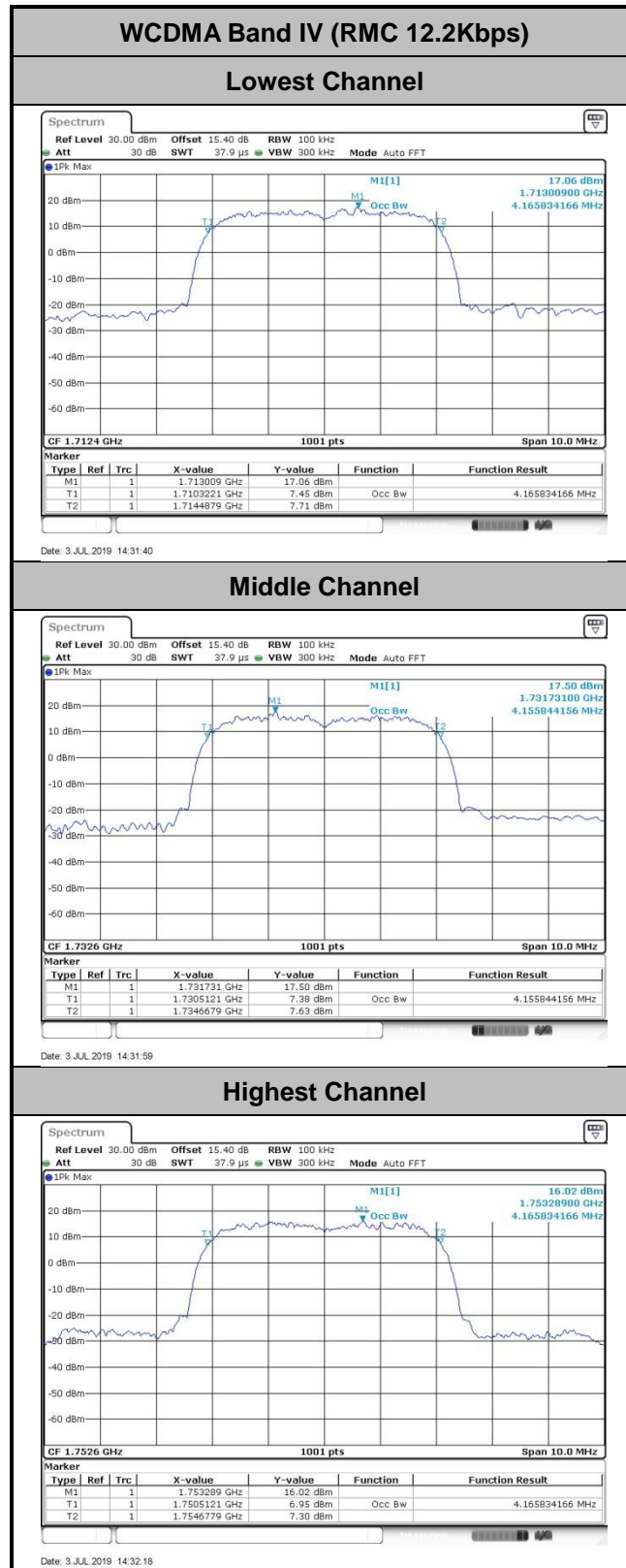



Conducted Band Edge

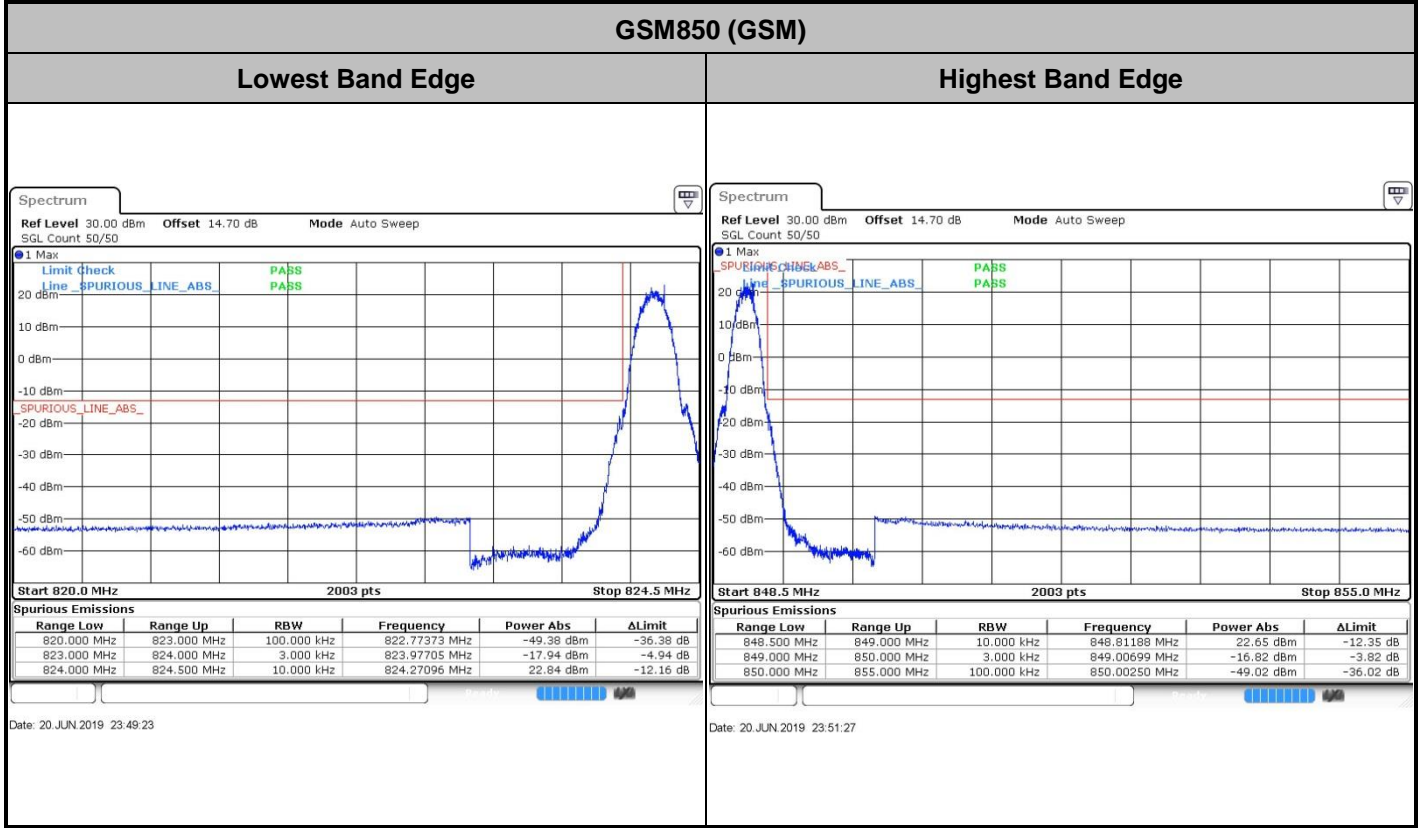

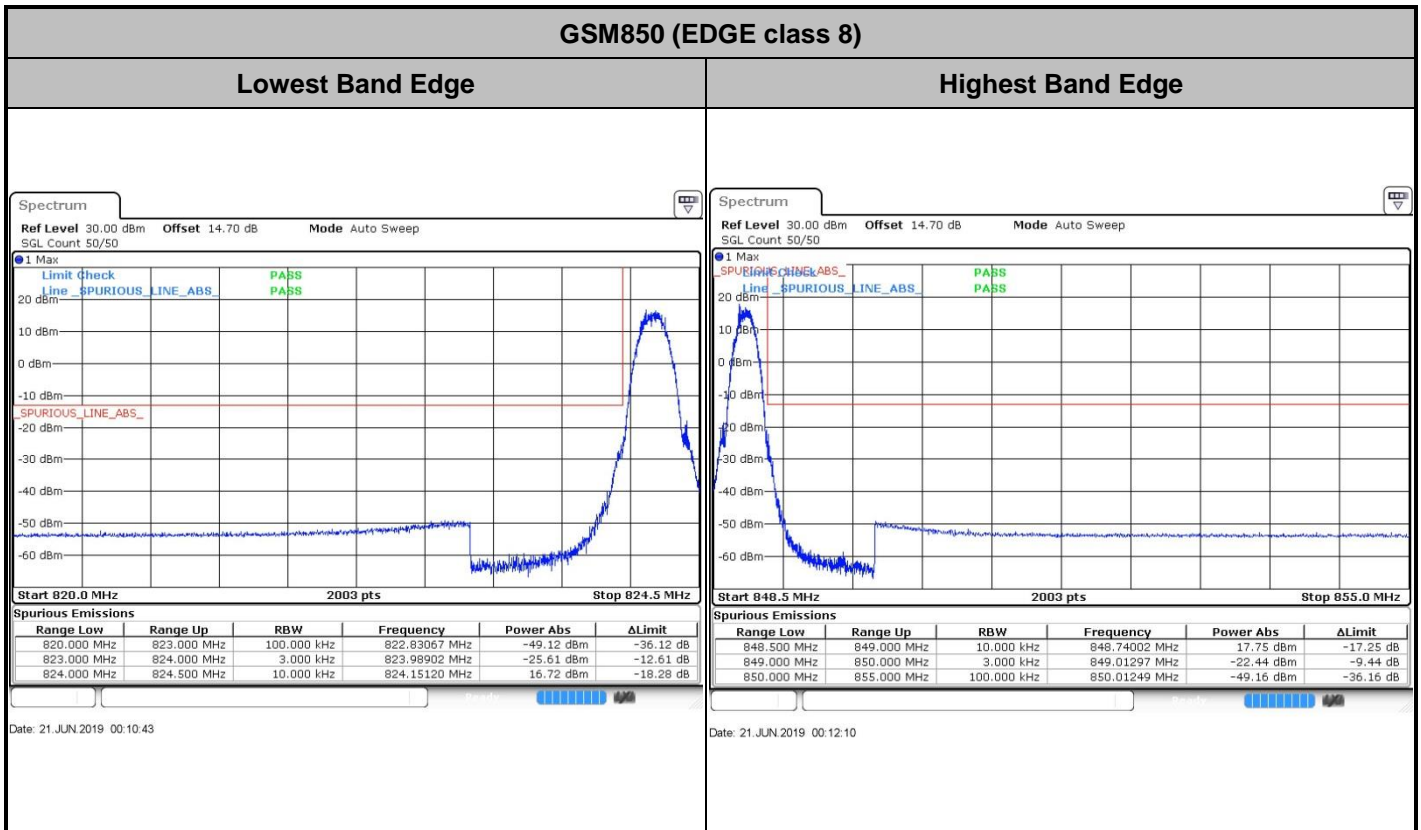

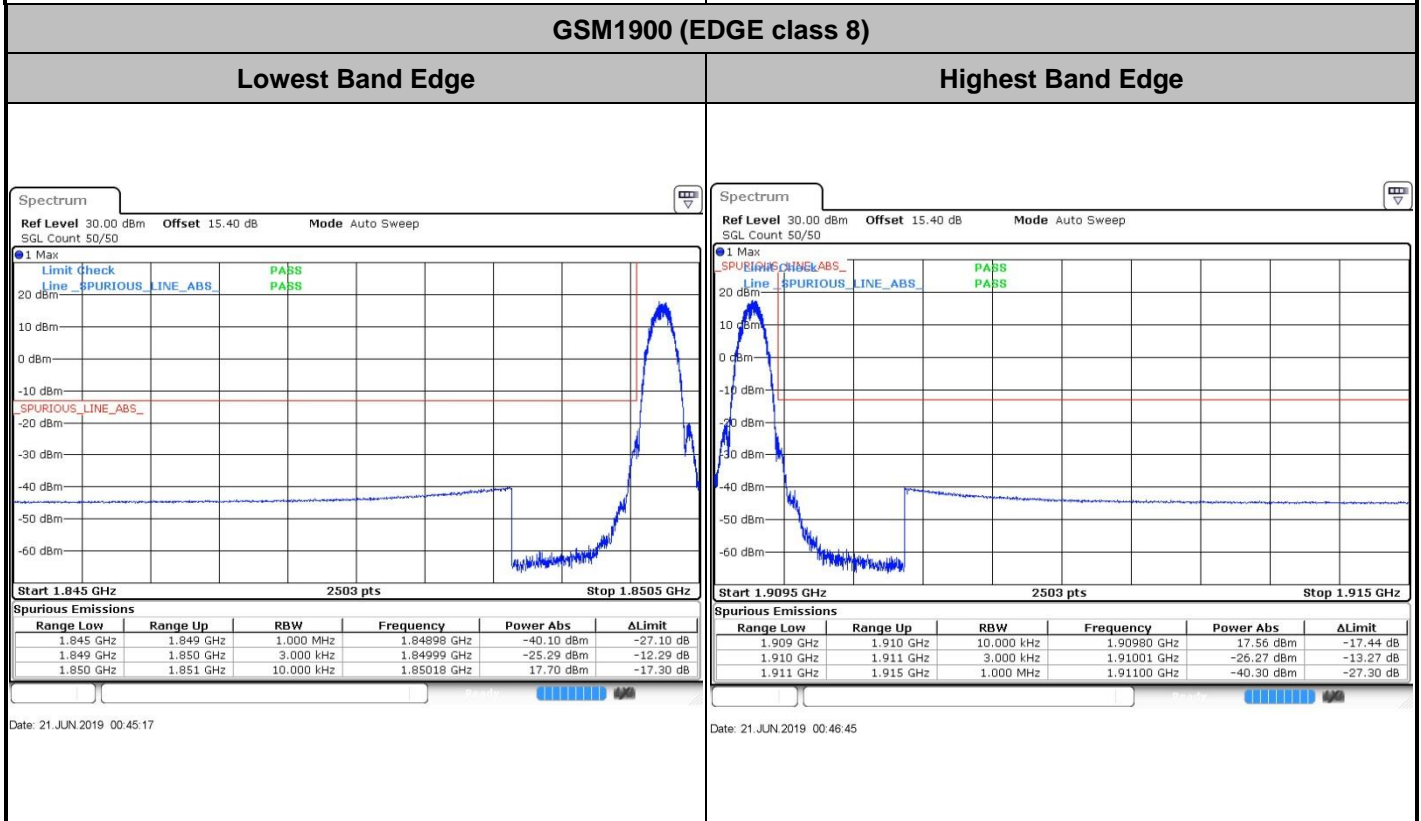
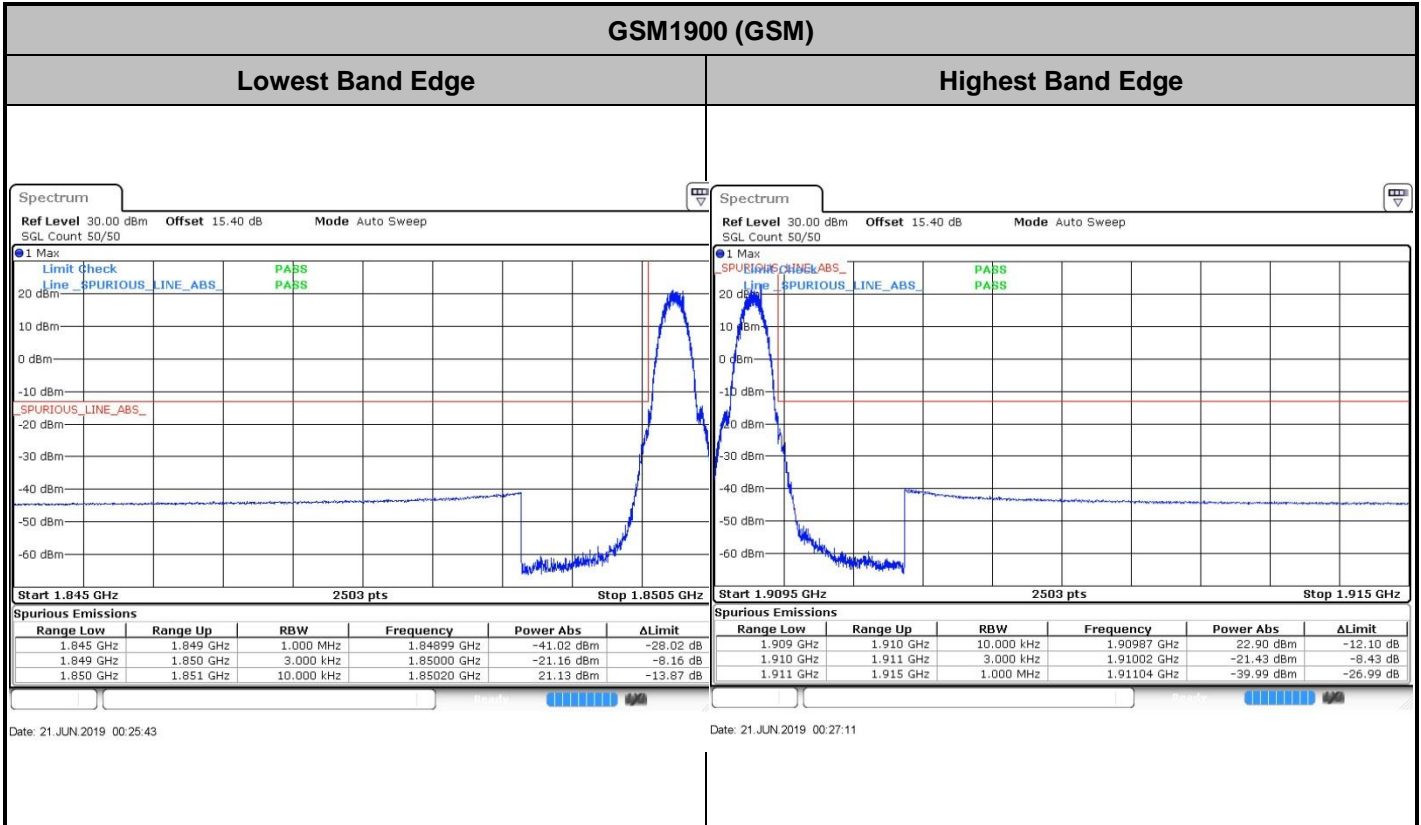



WCDMA Band V (RMC 12.2Kbps)

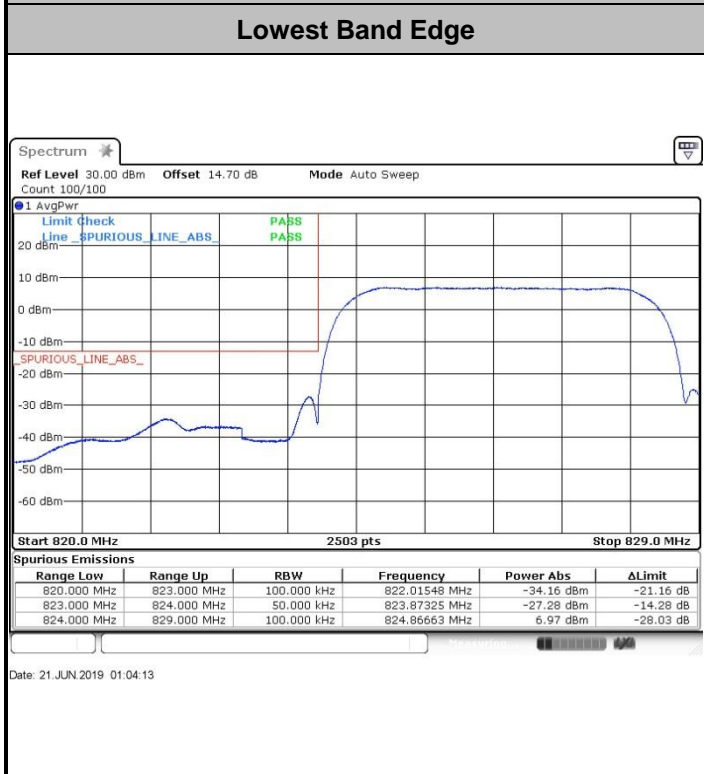

WCDMA Band II (RMC 12.2Kbps)

