



FCC RF Test Report

APPLICANT : Motorola Mobility LLC
EQUIPMENT : Mobile Cellular Phone
BRAND NAME : Motorola
MODEL NAME : XT2013-1
FCC ID : IHDT56YD1
STANDARD : FCC Part 15 Subpart E §15.407
CLASSIFICATION : (NII) Unlicensed National Information Infrastructure

The product was received on Mar. 29, 2019 and testing was completed on May 29, 2019. We, Sporton International (Kunshan) Inc., would like to declare that the tested sample has been evaluated in accordance with the test procedures and has been in compliance with the applicable technical standards.

The test results in this report apply exclusively to the tested model / sample. Without written approval of Sporton International (Kunshan) Inc., the test report shall not be reproduced except in full.

Jason Jia

Reviewed by: Jason Jia / Supervisor

James Huang

Approved by: James Huang / Manager



Sporton International (Kunshan) Inc.

**No. 1098, Pengxi North Road, Kunshan Economic Development Zone Jiangsu Province 215300
People's Republic of China**



TABLE OF CONTENTS

REVISION HISTORY..... 3

SUMMARY OF TEST RESULT 4

1 GENERAL DESCRIPTION 5

 1.1 Applicant 5

 1.2 Product Feature of Equipment Under Test..... 5

 1.3 Product Specification of Equipment Under Test..... 6

 1.4 Modification of EUT 7

 1.5 Specification of Accessory..... 7

 1.6 Testing Location 9

 1.7 Applicable Standards..... 9

2 TEST CONFIGURATION OF EQUIPMENT UNDER TEST 10

 2.1 Carrier Frequency and Channel 10

 2.2 Test Mode 12

 2.3 Connection Diagram of Test System..... 14

 2.4 Support Unit used in test configuration and system 14

 2.5 EUT Operation Test Setup 15

 2.6 Measurement Results Explanation Example..... 15

3 TEST RESULT..... 16

 3.1 26dB & 99% Occupied Bandwidth Measurement 16

 3.2 Maximum Conducted Output Power Measurement 18

 3.3 Power Spectral Density Measurement 20

 3.4 Unwanted Emissions Measurement 23

 3.5 AC Conducted Emission Measurement..... 28

 3.6 Automatically Discontinue Transmission 30

 3.7 Antenna Requirements..... 31

4 LIST OF MEASURING EQUIPMENT 32

5 UNCERTAINTY OF EVALUATION 33

APPENDIX A. CONDUCTED TEST RESULTS

APPENDIX B. AC CONDUCTED EMISSION TEST RESULT

APPENDIX C. RADIATED SPURIOUS EMISSION

APPENDIX D. DUTY CYCLE PLOTS

APPENDIX E. SETUP PHOTOGRAPHS



SUMMARY OF TEST RESULT

Report Section	FCC Rule	Description	Limit	Result	Remark
3.1	2.1049 & 15.403(i)	26dB & 99% Bandwidth	-	Pass	-
3.2	15.407(a)	Maximum Conducted Output Power	≤ 24 dBm	Pass	-
3.3	15.407(a)	Power Spectral Density	≤ 11 dBm	Pass	-
3.4	15.407(b)	Unwanted Emissions	15.407(b) & 15.209(a)	Pass	Under limit 3.05 dB at 5469.200 MHz
3.5	15.207	AC Conducted Emission	15.207(a)	Pass	Under limit 10.99 dB at 0.527 MHz
3.6	15.407(c)	Automatically Discontinue Transmission	Discontinue Transmission	Pass	-
3.7	15.203 & 15.407(a)	Antenna Requirement	N/A	Pass	-



1 General Description

1.1 Applicant

Motorola Mobility LLC
222 W,Merchandise Mart Plaza, Chicago IL 60654 USA

1.2 Product Feature of Equipment Under Test

Product Feature	
Equipment	Mobile Cellular Phone
Brand Name	Motorola
Model Name	XT2013-1
FCC ID	IHDT56YD1
EUT supports Radios application	GSM/WCDMA/LTE/ WLAN 2.4GHz 802.11b/g/n HT20 WLAN 5GHz 802.11a/n HT20/HT40 WLAN 5GHz 802.11ac VHT20/VHT40/VHT80 Bluetooth BR/EDR/LE FM Receiver/GNSS/NFC
IMEI Code	Conducted: 354142100019852/354142100019860 Conduction: 354142100011792/354142100011800 Radiation: 354142100011818/354142100011826
HW Version	DVT2
SW Version	PSB29.21
EUT Stage	Identical Prototype

Remark: The above EUT's information was declared by manufacturer. Please refer to the specifications or user's manual for more detailed description.



1.3 Product Specification of Equipment Under Test

Standards-related Product Specification	
Tx/Rx Frequency Range	5180 MHz ~ 5240 MHz 5260 MHz ~ 5320 MHz 5500 MHz ~ 5720 MHz
Maximum Output Power to Antenna	<p><5180 MHz ~ 5240 MHz> 802.11a : 18.97 dBm / 0.0789 W 802.11n HT20 : 19.11 dBm / 0.0815 W 802.11n HT40 : 18.14 dBm / 0.0652 W 802.11ac VHT20 : 19.01 dBm / 0.0796 W 802.11ac VHT40 : 18.07 dBm / 0.0641 W 802.11ac VHT80 : 15.54 dBm / 0.0358 W</p> <p><5260 MHz ~ 5320 MHz> 802.11a : 18.57 dBm / 0.0719 W 802.11n HT20 : 18.94 dBm / 0.0783 W 802.11n HT40 : 18.44 dBm / 0.0698 W 802.11ac VHT20 : 18.93 dBm / 0.0782 W 802.11ac VHT40 : 18.44 dBm / 0.0698 W 802.11ac VHT80 : 16.62 dBm / 0.0459 W</p> <p><5500 MHz ~ 5720 MHz > 802.11a : 18.55 dBm / 0.0716 W 802.11n HT20 : 18.91 dBm / 0.0778 W 802.11n HT40 : 18.66 dBm / 0.0735 W 802.11ac VHT20 : 18.89 dBm / 0.0774 W 802.11ac VHT40 : 18.54 dBm / 0.0714 W 802.11ac VHT80 : 16.50 dBm / 0.0447 W</p>
99% Occupied Bandwidth	<p><5180 MHz ~ 5240 MHz> 802.11a : 17.33 MHz 802.11n HT20 : 18.38 MHz 802.11n HT40 : 38.96 MHz 802.11ac VHT80 : 76.96 MHz</p> <p><5260 MHz ~ 5320 MHz> 802.11a : 17.33 MHz 802.11n HT20 : 18.43 MHz 802.11n HT40 : 38.96 MHz 802.11ac VHT80 : 77.08 MHz</p> <p><5500 MHz ~ 5720 MHz > 802.11a : 17.33 MHz 802.11n HT20 : 18.63 MHz 802.11n HT40 : 38.96 MHz 802.11ac VHT80 : 77.32 MHz</p>
Antenna Type / Gain	<p><5150 MHz ~ 5250 MHz> Fixed Internal Monopole Antenna with gain -1.00 dBi</p> <p><5250 MHz ~ 5350 MHz> Fixed Internal Monopole Antenna with gain -1.20 dBi</p> <p><5470 MHz ~ 5725 MHz> Fixed Internal Monopole Antenna with gain -1.20 dBi</p>
Type of Modulation	802.11a/n : OFDM (BPSK / QPSK / 16QAM / 64QAM) 802.11ac : OFDM (BPSK / QPSK / 16QAM / 64QAM / 256QAM)

Note: For 802.11n HT20 / ac VHT20 and 802.11n HT40 / ac VHT40 mode, the whole testing have



assessed only 802.11an HT20/HT40 by referring to their maximum conducted power..

1.4 Modification of EUT

No modifications are made to the EUT during all test items.

1.5 Specification of Accessory

Specification of Accessory				
AC Adapter 1(IN)	Brand Name	Motorola (Salom)	Model Name	SC-44
	Power Rating	I/P: 100-240 Vac, 300mA ,50/60HZ O/P: 5Vdc 2000mA		
AC Adapter 1(AU)	Brand Name	Motorola (Salom)	Model Name	SC-45
	Power Rating	I/P: 100-240 Vac, 300mA ,50/60HZ O/P: 5Vdc 2000mA		
AC Adapter 1(BR)	Brand Name	Motorola (Salom)	Model Name	SC-47
	Power Rating	I/P: 100-240 Vac, 300mA ,50/60HZ O/P: 5Vdc 2000mA		
AC Adapter 1(US)	Brand Name	Motorola (Salom)	Model Name	SC-41
	Power Rating	I/P: 100-240 Vac, 300mA ,50/60HZ O/P: 5Vdc 2000mA		
AC Adapter 1(UK)	Brand Name	Motorola (Salom)	Model Name	SC-43
	Power Rating	I/P: 100-240 Vac, 300mA ,50/60HZ O/P: 5Vdc 2000mA		
AC Adapter 1(EU)	Brand Name	Motorola (Salom)	Model Name	SC-42
	Power Rating	I/P: 100-240 Vac, 300mA ,50/60HZ O/P: 5Vdc 2000mA		
AC Adapter 1 (Chile)	Brand Name	Motorola (Salom)	Model Name	SC-42
	Power Rating	I/P: 100-240 Vac, 300mA ,50/60HZ O/P: 5Vdc 2000mA		
AC Adapter 1(AR)	Brand Name	Motorola (Salom)	Model Name	SC-46
	Power Rating	I/P: 100-240 Vac, 300mA ,50/60HZ O/P: 5Vdc 2000mA		
AC Adapter 2(AU)	Brand Name	Motorola (Acbel)	Model Name	SC-45
	Power Rating	I/P: 100-240 Vac, 300mA ,50/60HZ O/P: 5Vdc 2000mA		
AC Adapter 2(US)	Brand Name	Motorola (Acbel)	Model Name	SC-41
	Power Rating	I/P: 100-240 Vac, 300mA ,50/60HZ O/P: 5Vdc 2000mA		
AC Adapter 2(EU)	Brand Name	Motorola (Acbel)	Model Name	SC-42
	Power Rating	I/P: 100-240 Vac, 300mA ,50/60HZ O/P: 5Vdc 2000mA		
AC Adapter 2(UK)	Brand Name	Motorola (Acbel)	Model Name	SC-43
	Power Rating	I/P: 100-240 Vac, 300mA ,50/60HZ O/P: 5Vdc 2000mA		
AC Adapter 2(AR)	Brand Name	Motorola (Acbel)	Model Name	SC-46
	Power Rating	I/P: 100-240 Vac, 300mA ,50/60HZ O/P: 5Vdc 2000mA		
AC Adapter 3(BR)	Brand Name	Motorola (Cliptech/Tenpao)	Model Name	SC-47
	Power Rating	I/P: 100-240 Vac, 300mA ,50/60HZ O/P: 5Vdc 2000mA		
AC Adapter 4(BR)	Brand Name	Motorola (Salom/Flex)	Model Name	SC-47
	Power Rating	I/P: 100-240 Vac, 300mA ,50/60HZ O/P: 5Vdc 2000mA		



Battery	Brand Name	Motorola (ATL)	Model Name	KR40
	Power Rating	3.8Vdc,3500mAh	Type	Li-ion, Polymer
Earphone 1	Brand Name	Motorola (Lyand)	Model Name	SH38C37773
	Signal Line Type	1.1 meter, non-shielded cable, without ferrite core		
Earphone 2	Brand Name	Motorola (jiahe)	Model Name	SH38C44959
	Signal Line Type	1.1 meter, non-shielded cable, without ferrite core		
USB Cable 1	Brand Name	Motorola (LiQi)	Model Name	L32B-053000100/L32B-053000100L
	Signal Line Type	1.0 meter, shielded cable, without ferrite core		
USB Cable 2	Brand Name	Motorola (SaiBao)	Model Name	S32B-053000100/S32B-053000100L
	Signal Line Type	1.0 meter, shielded cable, without ferrite core		
USB Cable 3	Brand Name	Motorola (I SHENG)	Model Name	SC18C28955
	Signal Line Type	1.0 meter, shielded cable, without ferrite core		



1.6 Testing Location

<FCC>

Sporton International (Kunshan) Inc. is accredited to ISO/IEC 17025:2017 by American Association for Laboratory Accreditation with Certificate Number 5145.02.

Test Firm	Sporton International (Kunshan) Inc.		
Test Site Location	No. 1098, Pengxi North Road, Kunshan Economic Development Zone Jiangsu Province 215300 People's Republic of China TEL : +86-512-57900158 FAX : +86-512-57900958		
Test Site No.	Sporton Site No.	FCC Designation No.	FCC Test Firm Registration No.
	CO01-KS 03CH04-KS TH01-KS	CN1257	314309

1.7 Applicable Standards

According to the specifications of the manufacturer, the EUT must comply with the requirements of the following standards:

- ♦ 47 CFR Part 15 Subpart E
- ♦ FCC KDB 789033 D02 General UNII Test Procedures New Rules v02r01.
- ♦ ANSI C63.10-2013

Remark:

1. All test items were verified and recorded according to the standards and without any deviation during the test.
2. This EUT has also been tested and complied with the requirements of FCC Part 15, Subpart B, recorded in a separate test report.



2 Test Configuration of Equipment Under Test

- a. The EUT has been associated with peripherals and configuration operated in a manner tended to maximize its emission characteristics in a typical application. Frequency range investigated: conduction emission (150 kHz to 30 MHz), radiation emission (9 kHz to the 10th harmonic of the highest fundamental frequency or to 40 GHz, whichever is lower). For radiated measurement, pre-scanned in three orthogonal panels, X, Y, Z. The worst cases (Y plane) were recorded in this report.
- b. AC power line Conducted Emission was tested under maximum output power.

2.1 Carrier Frequency and Channel

Frequency Band	Channel	Freq. (MHz)	Channel	Freq. (MHz)
5150-5250 MHz Band 1 (U-NII-1)	36	5180	44	5220
	38*	5190	46*	5230
	40	5200	48	5240
	42 [#]	5210		

Frequency Band	Channel	Freq. (MHz)	Channel	Freq. (MHz)
5250-5350 MHz Band 2 (U-NII-2A)	52	5260	60	5300
	54*	5270	62*	5310
	56	5280	64	5320
	58 [#]	5290		

Frequency Band	Channel	Freq. (MHz)	Channel	Freq. (MHz)
5470-5725 MHz Band 3 (U-NII-2C)	100	5500	112	5560
	102*	5510	116	5580
	104	5520	132	5660
	106 [#]	5530	134*	5670
	108	5540	136	5680
	110*	5550	140	5700



Frequency Band	Channel	Freq. (MHz)	Channel	Freq. (MHz)
TDWR Channel	118*	5590	124	5620
	120	5600	126*	5630
	122 [#]	5610	128	5640

Frequency Band	Channel	Freq. (MHz)	Channel	Freq. (MHz)
Straddle Channel	138 [#]	5690	144	5720
	142*	5710		

Note:

1. The above Frequency and Channel in "*" were 802.11n HT40 and 802.11ac VHT40.
2. The above Frequency and Channel in "[#]" were 802.11ac VHT80.



2.2 Test Mode

Final test modes are considering the modulation and worse data rates as below table.

Modulation	Data Rate
802.11a	6 Mbps
802.11n HT20	MCS0
802.11n HT40	MCS0
802.11ac VHT80	MCS0

Test Cases	
AC Conducted Emission	Mode 1 : GSM 850 Idle + Bluetooth Link + WLAN Link (5G) + Earphone 1 + USB Cable 1(Charging from adapter 1)
Remark: For Radiated Test Cases, The tests were performance with Adapter 1, Earphone 1, USB Cable 1	



Ch. #		Band I : 5150-5250 MHz	Band II : 5250-5350 MHz	Band III : 5470-5725MHz
		802.11a	802.11a	802.11a
L	Low	36	52	100
M	Middle	44	60	116
H	High	48	64	140
Straddle		-	-	144

Ch. #		Band I : 5150-5250 MHz	Band II : 5250-5350 MHz	Band III : 5470-5725MHz
		802.11n HT20	802.11n HT20	802.11n HT20
L	Low	36	52	100
M	Middle	44	60	116
H	High	48	64	140
Straddle		-	-	144

Ch. #		Band I : 5150-5250 MHz	Band II : 5250-5350 MHz	Band III : 5470-5725MHz
		802.11n HT40	802.11n HT40	802.11n HT40
L	Low	38	54	102
M	Middle	-	-	110
H	High	46	62	134
Straddle		-	-	142

Ch. #		Band I : 5150-5250 MHz	Band II : 5250-5350 MHz	Band III : 5470-5725MHz
		802.11ac VHT80	802.11ac VHT80	802.11ac VHT80
L	Low	-	-	106
M	Middle	42	58	-
H	High	-	-	-
Straddle		-	-	138

2.3 Connection Diagram of Test System

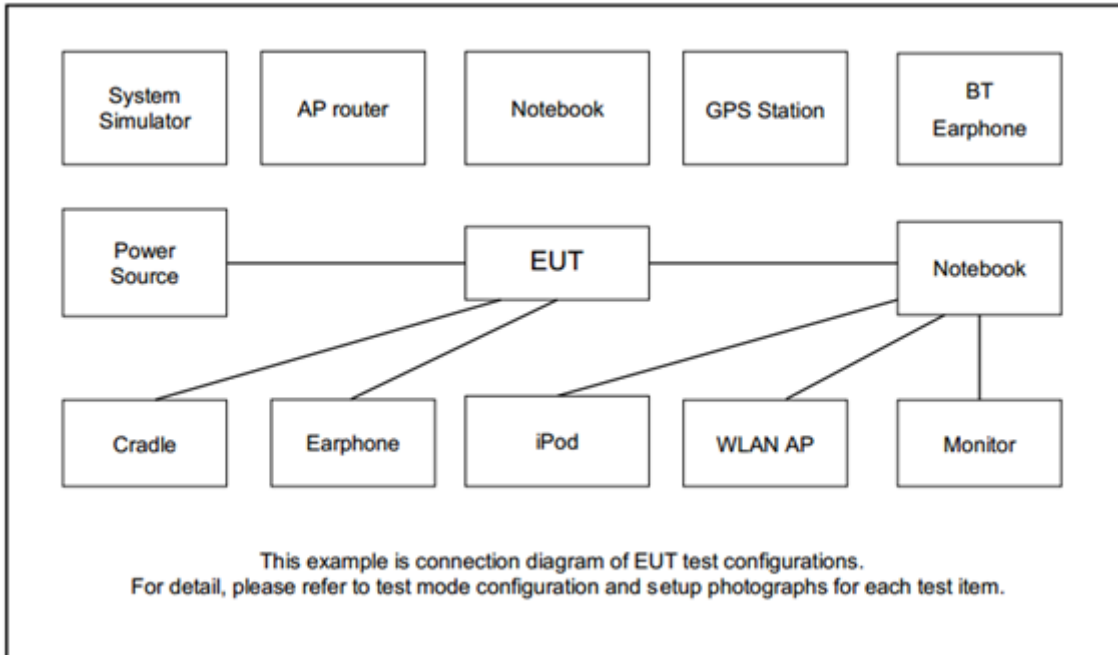

2.4 Support Unit used in test configuration and system

Item	Equipment	Trade Name	Model Name	FCC ID	Data Cable	Power Cord
1.	LTE Base Station	Anritsu	MT8820C	N/A	N/A	Unshielded,1.8m
2.	Bluetooth Earphone	Lenovo	LBH308	N/A	N/A	N/A
3.	Notebook	Lenovo	G480	PRC4	N/A	AC I/P: Unshielded, 1.8 m DC O/P: Shielded, 1.8 m
4.	WLAN AP	D-link	DIR-855	KA2DIR855A2	N/A	Unshielded,1.8m
5.	SD Card	Kingston	8GB	N/A	N/A	N/A



2.5 EUT Operation Test Setup

For WLAN RF test items, an engineering test program was provided and enabled to make EUT continuously transmit/receive.

For AC power line conducted emissions, the EUT was set to connect with the Notebook under large package sizes transmission.

2.6 Measurement Results Explanation Example

For all conducted test items:

The offset level is set in the spectrum analyzer to compensate the RF cable loss between EUT conducted output port and spectrum analyzer. With the offset compensation, the spectrum analyzer reading level is exactly the EUT RF output level.

Example :

The spectrum analyzer offset is derived from RF cable loss .

Offset = RF cable loss + attenuator factor.

Following shows an offset computation example with cable loss 6.8 dB.

$$\begin{aligned} \text{Offset(dB)} &= \text{RF cable loss(dB)}. \\ &= 6.8 \text{ (dB)} \end{aligned}$$

3 Test Result

3.1 26dB & 99% Occupied Bandwidth Measurement

3.1.1 Description of 26dB & 99% Occupied Bandwidth

This section is for reporting purpose only.

There is no restriction limits for bandwidth.

For Straddle Channel, According to KDB 789033 D02 General UNII Test Procedures New Rules v02r01, If the power and PSD of the devices are uniform and comply with the lower limits specified for the U-NII-2 bands, a single measurement over the entire emission bandwidth can be performed to show compliance.

3.1.2 Measuring Instruments

The measuring equipment is listed in the section 4 of this test report.

3.1.3 Test Procedures

1. The testing follows FCC KDB 789033 D02 General UNII Test Procedures New Rules v02r01. Section C) Emission bandwidth
2. Set RBW = approximately 1% of the emission bandwidth.
3. Set the VBW > RBW.
4. Detector = Peak.
5. Trace mode = max hold
6. Measure the maximum width of the emission that is 26 dB down from the peak of the emission. Compare this with the RBW setting of the analyzer. Readjust RBW and repeat measurement as needed until the RBW/EBW ratio is approximately 1%.
7. For 99% Bandwidth Measurement, the spectrum analyzer's resolution bandwidth (RBW) is set 1MHz and set the Video bandwidth (VBW) $\geq 3 * RBW$.
8. Measure and record the results in the test report.

3.1.4 Test Setup

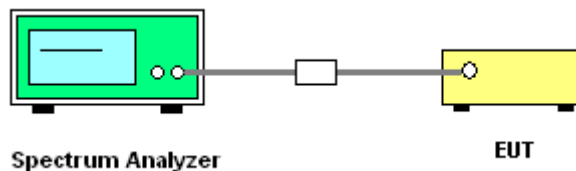

3.1.5 Test Result of 26dB & 99% Occupied Bandwidth

Please refer to Appendix A.

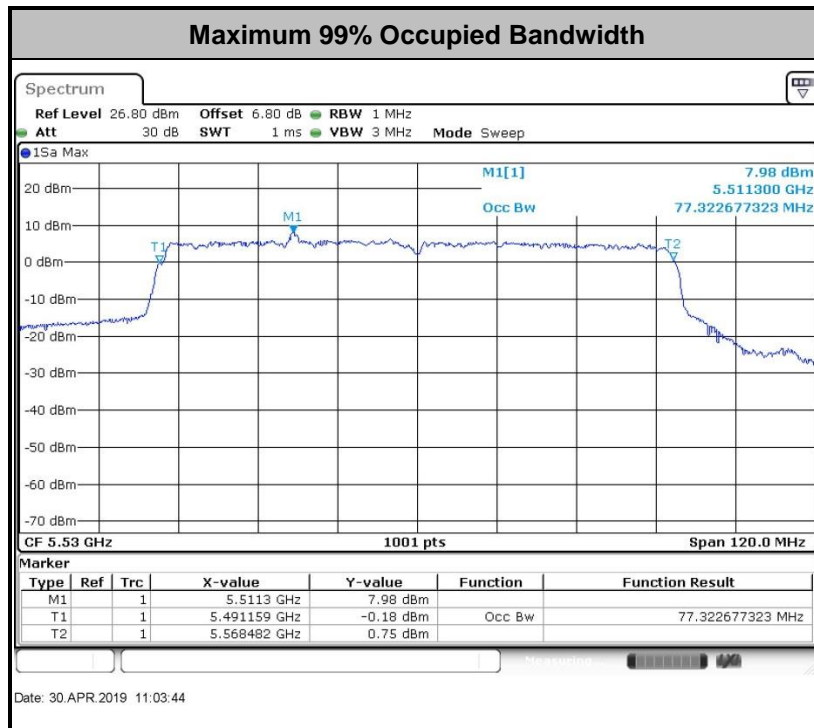
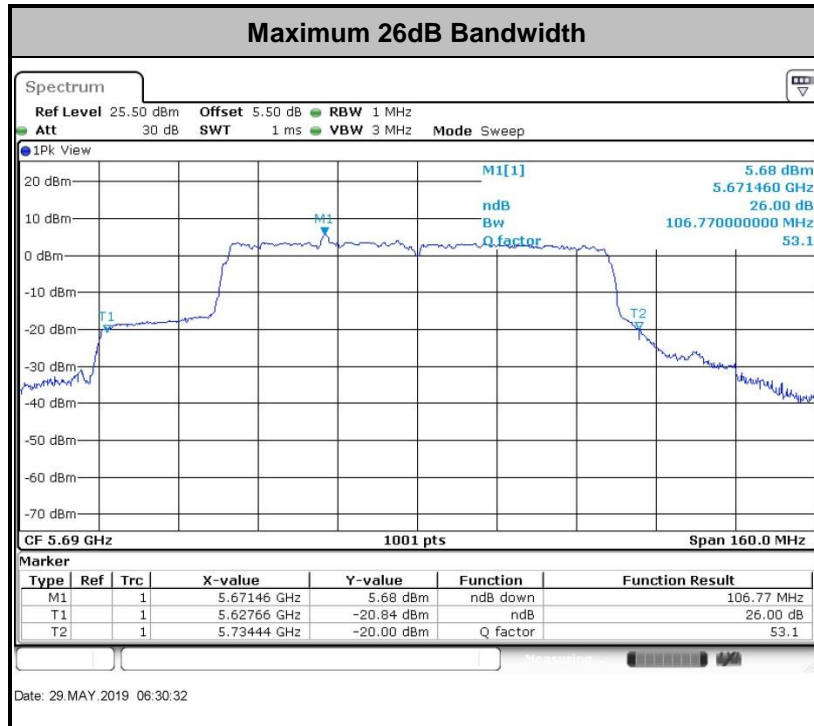

Note: The occupied channel bandwidth is maintained within the band of operation for all of the modulations.



3.2 Maximum Conducted Output Power Measurement

3.2.1 Limit of Maximum Conducted Output Power

<FCC 14-30 CFR 15.407>

For mobile and portable client devices in the 5.15–5.25 GHz band, the maximum conducted output power over the frequency band of operation shall not exceed 250 mW.

For the 5.25–5.725 GHz bands, the maximum conducted output power over the frequency bands of operation shall not exceed the lesser of 250 mW or $11 + 10 \log B$, dBm, where B is the 26 dB emission bandwidth in megahertz.

For the 5.47–5.6 GHz and 5.65–5.725 GHz band, the maximum conducted output power shall not exceed 250 mW or $11 + 10 \log_{10} B$, dBm, whichever power is less. The maximum e.i.r.p. shall not exceed 1.0 W or $17 + 10 \log_{10} B$, dBm, whichever is less. B is the 99% emission bandwidth in megahertz.

For Straddle Channel, According to KDB 789033 D02 General UNII Test Procedures New Rules v02r01, If the power and PSD of the devices are uniform and comply with the lower limits specified for the U-NII-2 bands, a single measurement over the entire emission bandwidth can be performed to show compliance.

If transmitting antennas of directional gain greater than 6 dBi are used, the peak output power shall be reduced by the amount in dB that the directional gain of the antenna exceeds 6 dBi.

Note that U-NII-2 band, devices with a maximum e.i.r.p. greater than 500 mW shall implement TPC in order to have the capability to operate at least 6 dB below the maximum permitted e.i.r.p. of 1 W.

3.2.2 Measuring Instruments

The measuring equipment is listed in the section 4 of this test report.

3.2.3 Test Procedures

The testing follows Method PM of FCC KDB 789033 D02 General UNII Test Procedures New Rules v02r01.

Method PM (Measurement using an RF average power meter):

1. Measurement is performed using a wideband RF power meter.
2. The EUT is configured to transmit continuously with a consistent duty cycle at its maximum power control level.
3. Measure the average power of the transmitter, and the average power is corrected with duty factor, $10 \log(1/x)$, where x is the duty cycle.

For Straddle Channel, According to KDB 789033 D02 General UNII Test Procedures New Rules v02r01, If the power and PSD of the devices are uniform and comply with the lower limits specified for the U-NII-2 bands, a single measurement over the entire emission bandwidth can be performed to show compliance.

3.2.4 Test Setup

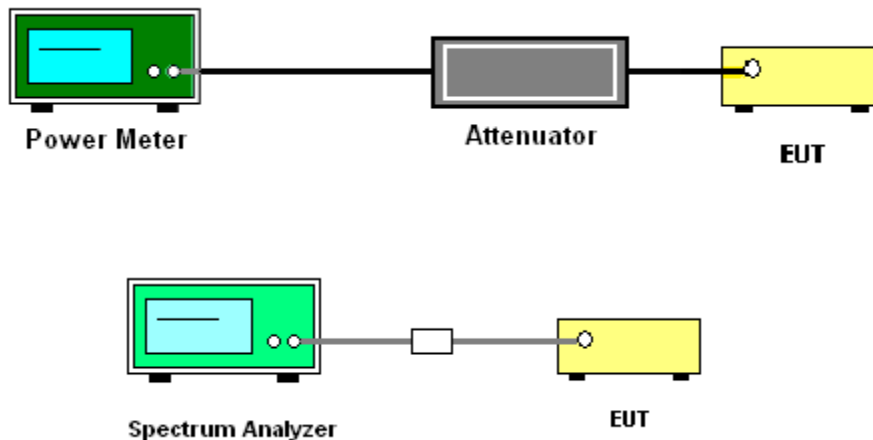

3.2.5 Test Result of Maximum Conducted Output Power

Please refer to Appendix A.



3.3 Power Spectral Density Measurement

3.3.1 Limit of Power Spectral Density

<FCC 14-30 CFR 15.407>

For mobile and portable client devices in the 5.15–5.25 GHz band, the maximum power spectral density shall not exceed 11dBm in any 1 megahertz band.

For the 5.25–5.725 GHz bands, the maximum power spectral density shall not exceed 11 dBm in any 1 megahertz band.

For Straddle Channel, According to KDB 789033 D02 General UNII Test Procedures New Rules v02r01, If the power and PSD of the devices are uniform and comply with the lower limits specified for the U-NII-2 bands, a single measurement over the entire emission bandwidth can be performed to show compliance.

If transmitting antennas of directional gain greater than 6 dBi are used, the peak output power shall be reduced by the amount in dB that the directional gain of the antenna exceeds 6 dBi.

3.3.2 Measuring Instruments

The measuring equipment is listed in the section 4 of this test report.

3.3.3 Test Procedures

The testing follows FCC KDB 789033 D02 General UNII Test Procedures New Rules v02r01.
Section F) Maximum power spectral density.

Method SA-2

(trace averaging across on and off times of the EUT transmissions, followed by duty cycle correction).

- Measure the duty cycle.
 - Set span to encompass the entire emission bandwidth (EBW) of the signal.
 - Set RBW = 1 MHz.
 - Set VBW \geq 3 MHz.
 - Number of points in sweep \geq 2 Span / RBW.
 - Sweep time = auto.
 - Detector = RMS
 - Trace average at least 100 traces in power averaging mode.
 - Add $10 \log(1/x)$, where x is the duty cycle, to the measured power in order to compute the average power during the actual transmission times. For example, add $10 \log(1/0.25) = 6$ dB if the duty cycle is 25 percent.
1. The RF output of EUT was connected to the spectrum analyzer by a low loss cable.
 2. Each plot has already offset with cable loss, and attenuator loss. Measure the PPSD and record it.

3.3.4 Test Setup

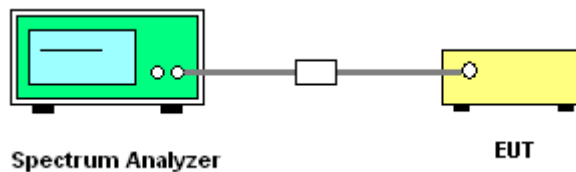



3.3.5 Test Result of Power Spectral Density

Please refer to Appendix A.

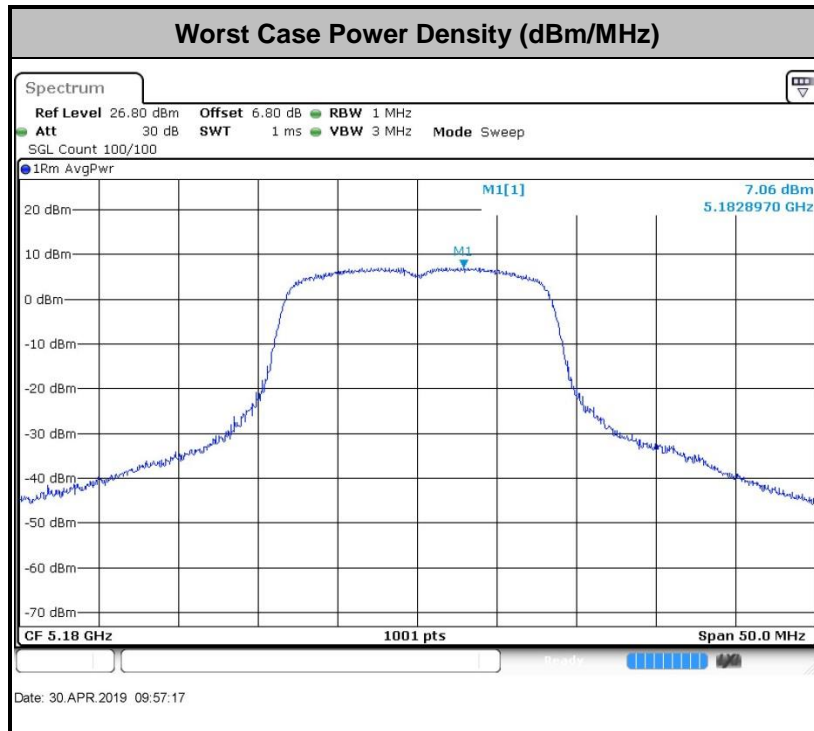

Remark: Average power density = Conducted measure + Duty Factor



3.4 Unwanted Emissions Measurement

This section is to measure unwanted emissions through radiated measurement for band edge spurious emissions and out of band emissions measurement.

3.4.1 Limit of Unwanted Emissions

- (1) For transmitters operating in the 5150-5250 MHz band: all emissions outside of the 5150-5350 MHz band shall not exceed an EIRP of -27dBm/MHz.

For transmitters operating in the 5250-5350 MHz band: all emissions outside of the 5150-5350 MHz band shall not exceed an EIRP of -27 dBm/MHz. Devices operating in the 5250-5350 MHz band that generate emissions in the 5150-5250 MHz band must meet all applicable technical requirements for operation in the 5150-5250 MHz band (including indoor use) or alternatively meet an out-of-band emission EIRP limit of -27 dBm/MHz in the 5150-5250 MHz band.

For transmitters operating in the 5470-5600 MHz and 5650-5725MHz band: all emissions outside of the 5470-5600 MHz and 5650-5725MHz band shall not exceed an EIRP of -27 dBm/MHz.

- (2) Unwanted spurious emissions fallen in restricted bands shall comply with the general field strength limits as below table,

Frequency (MHz)	Field Strength (microvolts/meter)	Measurement Distance (meters)
0.009 – 0.490	2400/F(kHz)	300
0.490 – 1.705	24000/F(kHz)	30
1.705 – 30.0	30	30
30 – 88	100	3
88 – 216	150	3
216 - 960	200	3
Above 960	500	3



EIRP (dBm)	Field Strength at 3m (dBµV/m)
- 27	68.2

Note: The following formula is used to convert the EIRP to field strength.

$$EIRP = E_{Meas} + 20\log (d_{Meas}) - 104.7$$

where

EIRP is the equivalent isotropically radiated power, in dBm

E_{Meas} is the field strength of the emission at the measurement distance, in dBµV/m

d_{Meas} is the measurement distance, in m

3.4.2 Measuring Instruments

The measuring equipment is listed in the section 4 of this test report.



3.4.3 Test Procedures

1. The testing follows FCC KDB 789033 D02 General UNII Test Procedures New Rules v02r01. Section G) Unwanted emissions measurement.
 - (1) Procedure for Unwanted Emissions Measurements Below 1000MHz
 - RBW = 120 kHz
 - VBW = 300 kHz
 - Detector = Peak
 - Trace mode = max hold
 - (2) Procedure for Peak Unwanted Emissions Measurements Above 1000 MHz
 - RBW = 1 MHz
 - VBW \geq 3 MHz
 - Detector = Peak
 - Sweep time = auto
 - Trace mode = max hold
 - (3) Procedures for Average Unwanted Emissions Measurements Above 1000MHz
 - RBW = 1 MHz
 - VBW = 10 Hz, when duty cycle is no less than 98 percent.
 - VBW \geq 1/T, when duty cycle is less than 98 percent where T is the minimum transmission duration over which the transmitter is on and is transmitting at its maximum power control level for the tested mode of operation.
2. The EUT was placed on a turntable with 0.8 meter for frequency below 1GHz and 1.5 meter for frequency above 1GHz respectively above ground.
3. The EUT was set 3 meters from the interference receiving antenna which was mounted on the top of a variable height antenna tower.
4. The antenna is a broadband antenna and its height is adjusted between one meter and four meters above ground to find the maximum value of the field strength for both horizontal polarization and vertical polarization of the antenna.
5. For each suspected emission, the EUT was arranged to its worst case and then adjust the antenna tower (from 1 m to 4 m) and turntable (from 0 degree to 360 degrees) to find the maximum reading.
6. For testing below 1GHz, if the emission level of the EUT in peak mode was 3 dB lower than the limit specified, then peak values of EUT will be reported, otherwise, the emissions will be repeated one by one using the CISPR quasi-peak method and reported.
7. For testing above 1GHz, the emission level of the EUT in peak mode was 20dB lower than average limit (that means the emission level in average mode also complies with the limit in average mode), then peak values of EUT will be reported, otherwise, the emissions will be measured in average mode again and reported.

3.4.4 Test Setup

For radiated emissions below 30MHz

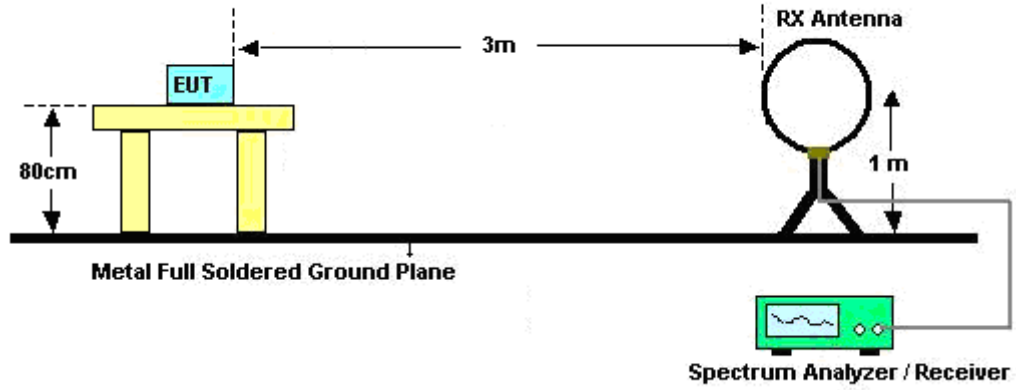

For radiated emissions from 30MHz to 1GHz

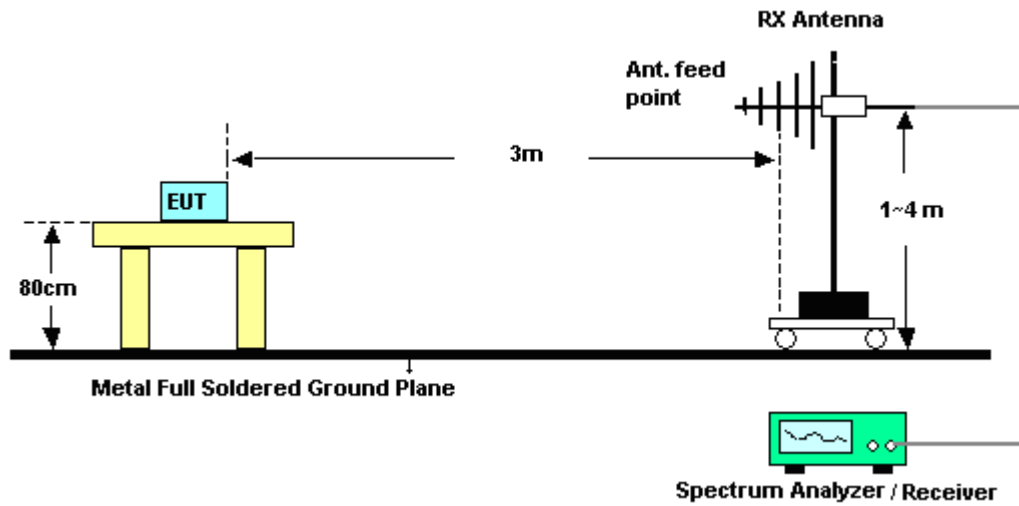

For radiated emissions above 1GHz

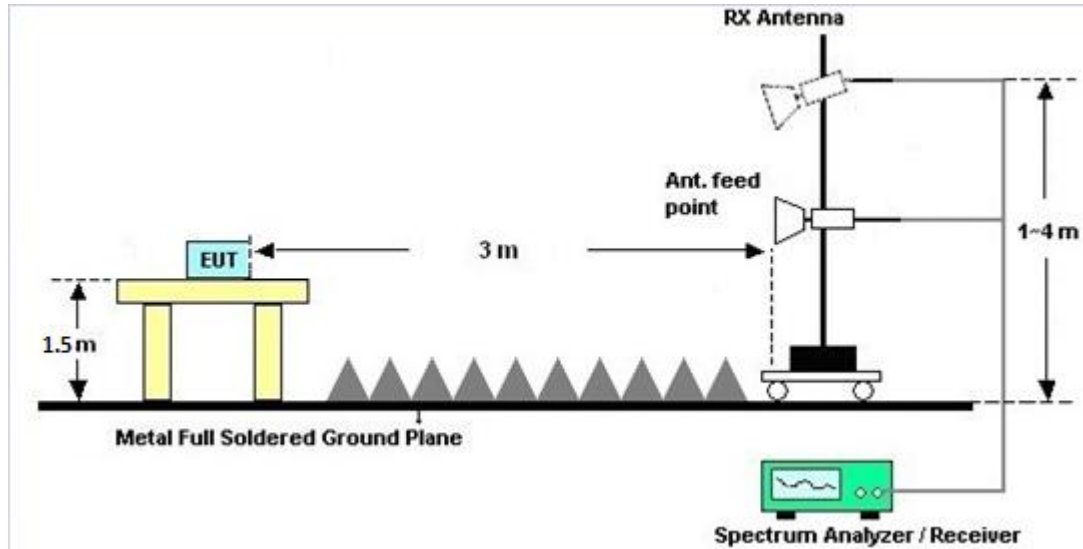

3.4.5 Test Results of Radiated Spurious Emissions (9 kHz ~ 30 MHz)

The low frequency, which started from 9 kHz to 30MHz, was pre-scanned and the result which was 20dB lower than the limit line was not reported.

There is a comparison data of both open-field test site and semi-Anechoic chamber, and the result came out very similar.

3.4.6 Test Result of Radiated Spurious at Band Edges

Please refer to Appendix C.

3.4.7 Duty Cycle

Please refer to Appendix D.

3.4.8 Test Result of Radiated Spurious Emissions (30MHz ~ 10th Harmonic)

Please refer to Appendix C.



3.5 AC Conducted Emission Measurement

3.5.1 Limit of AC Conducted Emission

For equipment that is designed to be connected to the public utility (AC) power line, the radio frequency voltage that is conducted back onto the AC power line on any frequency or frequencies within the band 150 kHz to 30 MHz shall not exceed the limits in the following table.

Frequency of emission (MHz)	Conducted limit (dBµV)	
	Quasi-peak	Average
0.15-0.5	66 to 56*	56 to 46*
0.5-5	56	46
5-30	60	50

*Decreases with the logarithm of the frequency.

3.5.2 Measuring Instruments

The measuring equipment is listed in the section 4 of this test report.

3.5.3 Test Procedures

1. The EUT was placed 0.4 meter from the conducting wall of the shielding room was kept at least 80 centimeters from any other grounded conducting surface.
2. Connect EUT to the power mains through a line impedance stabilization network (LISN).
3. All the support units are connecting to the other LISN.
4. The LISN provides 50 ohm coupling impedance for the measuring instrument.
5. The FCC states that a 50 ohm, 50 microhenry LISN should be used.
6. Both sides of AC line were checked for maximum conducted interference.
7. The frequency range from 150 kHz to 30 MHz was searched.
8. Set the test-receiver system to Peak Detect Function and specified bandwidth with Maximum Hold Mode.

3.5.4 Test Setup



3.5.5 Test Result of AC Conducted Emission

Please refer to Appendix B.



3.6 Automatically Discontinue Transmission

3.6.1 Limit of Automatically Discontinue Transmission

The device shall automatically discontinue transmission in case of either absence of information to transmit or operational failure. These provisions are not intended to preclude the transmission of control or signaling information or the use of repetitive codes used by certain digital technologies to complete frame or burst intervals. Applicants shall include in their application for equipment authorization to describe how this requirement is met.

3.6.2 Measuring Instruments

The measuring equipment is listed in the section 4 of this test report.

3.6.3 Test Result of Automatically Discontinue Transmission

While the EUT is not transmitting any information, the EUT can automatically discontinue transmission and become standby mode for power saving. The EUT can detect the controlling signal of ACK message transmitting from remote device and verify whether it shall resend or discontinue transmission.



3.7 Antenna Requirements

3.7.1 Standard Applicable

If transmitting antenna directional gain is greater than 6 dBi, both the peak transmit power and the peak power spectral density shall be reduced by the amount in dB that the directional gain of the antenna exceeds 6 dBi.

3.7.2 Antenna Anti-Replacement Construction

An embedded-in antenna design is used.

3.7.3 Antenna Gain

The antenna peak gain of EUT is less than 6 dBi. Therefore, it is not necessary to reduce maximum peak output power limit.



4 List of Measuring Equipment

Instrument	Manufacturer	Model No.	Serial No.	Characteristics	Calibration Date	Test Date	Due Date	Remark
Spectrum Analyzer	R&S	FSV40	101040	10Hz~40GHz	Aug. 07, 2018	Apr. 30, 2019~ May 29, 2019	Aug. 06, 2019	Conducted (TH01-KS)
Pulse Power Sensor	Anritsu	MA2411B	0917070	300MHz~40GHz	Jan. 14, 2019	Apr. 30, 2019~ May 29, 2019	Jan. 13, 2020	Conducted (TH01-KS)
Power Meter	Anritsu	ML2495A	1005002	50MHz Bandwidth	Jan. 14, 2019	Apr. 30, 2019~ May 29, 2019	Jan. 13, 2020	Conducted (TH01-KS)
Thermal Chamber	Ten Billion	TTC-B3S	TBN-960502	-40~+150°C	Nov. 19, 2018	Apr. 30, 2019~ May 29, 2019	Nov. 18, 2019	Conducted (TH01-KS)
EMI Test Receiver	Keysight	N9038A	MY56400004	3Hz~8.5GHz;Max 30dBm	Oct. 12, 2018	May 22, 2019	Oct. 11, 2019	Radiation (03CH04-KS)
EXA Spectrum Analyzer	Keysight	N9010A	MY55150244	10Hz~44G,MAX 30dB	Apr. 16, 2019	May 22, 2019	Apr. 15, 2020	Radiation (03CH04-KS)
Loop Antenna	R&S	HFH2-Z2	100321	9kHz~30MHz	Oct. 19, 2018	May 22, 2019	Oct. 17, 2019	Radiation (03CH04-KS)
Bilog Antenna	TeseQ	CBL6111D	44483	30MHz~1GHz	Dec. 28, 2018	May 22, 2019	Dec. 27, 2019	Radiation (03CH04-KS)
Horn Antenna	Schwarzbeck	BBHA9120D	1648	1GHz~18GHz	Jan. 27, 2019	May 22, 2019	Jan. 26, 2020	Radiation (03CH04-KS)
SHF-EHF Horn	Com-power	AH-840	101070	18GHz~40GHz	Jan. 05, 2019	May 22, 2019	Jan. 04, 2020	Radiation (03CH04-KS)
Amplifier	Burgeon	BPA-530	102219	0.01MHz~3000MHz	Nov. 19, 2018	May 22, 2019	Nov. 18, 2019	Radiation (03CH04-KS)
Amplifier	MITEQ	TTA1840-35-HG	2014749	18~40GHz	Jan. 14, 2019	May 22, 2019	Jan. 13, 2020	Radiation (03CH04-KS)
high gain Amplifier	MITEQ	AMF-7D-00101800-30-10P	2025788	1Ghz-18Ghz	Apr. 17, 2019	May 22, 2019	Apr. 16, 2020	Radiation (03CH04-KS)
Amplifier	Keysight	83017A	MY53270319	500MHz~26.5GHz	Oct. 12, 2018	May 22, 2019	Oct. 11, 2019	Radiation (03CH04-KS)
AC Power Source	Chroma	61601	F104090004	N/A	NCR	May 22, 2019	NCR	Radiation (03CH04-KS)
Turn Table	ChamPro	EM 1000-T	060762-T	0~360 degree	NCR	May 22, 2019	NCR	Radiation (03CH04-KS)
Antenna Mast	ChamPro	EM 1000-A	060762-A	1 m~4 m	NCR	May 22, 2019	NCR	Radiation (03CH04-KS)
EMI Receiver	R&S	ESCI7	100768	9kHz~7GHz;	Apr. 19, 2018	Apr. 13, 2019	Apr. 18, 2019	Conduction (CO01-KS)
AC LISN	MessTec	AN3016	060103	9kHz~30MHz	Oct. 12, 2018	Apr. 13, 2019	Oct. 11, 2019	Conduction (CO01-KS)
AC LISN (for auxiliary equipment)	MessTec	AN3016	060105	9kHz~30MHz	Nov. 19, 2018	Apr. 13, 2019	Nov. 18, 2019	Conduction (CO01-KS)
AC Power Source	Chroma	61602	ABP00000811	AC 0V~300V, 45Hz~1000Hz	Oct. 12, 2018	Apr. 13, 2019	Oct. 11, 2019	Conduction (CO01-KS)

NCR: No Calibration Required



5 Uncertainty of Evaluation

The measurement uncertainties shown below were calculated in accordance with the requirements of ANSI 63.10-2013. All the measurement uncertainty value were shown with a coverage K=2 to indicate 95% level of confidence. The measurement data show herein meets or exceeds the CISPR measurement uncertainty values specified in CISPR 16-4-2 and can be compared directly to specified limit to determine compliance.

Uncertainty of Conducted Emission Measurement (150kHz ~ 30MHz)

Measuring Uncertainty for a Level of Confidence of 95% (U = 2Uc(y))	2.9dB
---	-------

Uncertainty of Radiated Emission Measurement (30 MHz ~ 1000 MHz)

Measuring Uncertainty for a Level of Confidence of 95% (U = 2Uc(y))	5.0dB
---	-------

Uncertainty of Radiated Emission Measurement (1000 MHz ~ 18000 MHz)

Measuring Uncertainty for a Level of Confidence of 95% (U = 2Uc(y))	5.1dB
---	-------

Uncertainty of Radiated Emission Measurement (18000 MHz ~ 40000 MHz)

Measuring Uncertainty for a Level of Confidence of 95% (U = 2Uc(y))	5.1dB
---	-------

Test Engineer:	Asa Cheng	Temperature:	21~25	°C
Test Date:	2019/4/30	Relative Humidity:	51~54	%

TEST RESULTS DATA
26dB and 99% OBW

Band I										
Mod.	Data Rate	NTX	CH.	Freq. (MHz)	99% Bandwidth (MHz)	26 dB Bandwidth (MHz)	IC 99% Bandwidth Power Limit (dBm)	IC 99% Bandwidth EIRP Limit (dBm)		
11a	6Mbps	1	36	5180	17.33	22.28	-	22.39		
11a	6Mbps	1	44	5220	17.28	22.38	-	22.38		
11a	6Mbps	1	48	5240	17.33	22.23	-	22.39		
HT20	MCS0	1	36	5180	18.38	22.38	-	22.64		
HT20	MCS0	1	44	5220	18.28	23.08	-	22.62		
HT20	MCS0	1	48	5240	18.33	22.93	-	22.63		
HT40	MCS0	1	38	5190	38.96	47.74	-	23.01		
HT40	MCS0	1	46	5230	38.56	47.29	-	23.01		
VHT80	MCS0	1	42	5210	76.96	85.99	-	23.01		

TEST RESULTS DATA
Average Power Table

FCC Band I										
Mod.	Data Rate	NTX	CH.	Freq. (MHz)	Duty Factor (dB)	Average Conducted Power (dBm)	FCC Conducted Power Limit (dBm)	DG (dBi)		Pass/Fail
11a	6Mbps	1	36	5180	0.19	17.64	23.98	-1.00		Pass
11a	6Mbps	1	44	5220	0.19	18.21	23.98	-1.00		Pass
11a	6Mbps	1	48	5240	0.19	18.97	23.98	-1.00		Pass
HT20	MCS0	1	36	5180	0.23	17.87	23.98	-1.00		Pass
HT20	MCS0	1	44	5220	0.23	18.62	23.98	-1.00		Pass
HT20	MCS0	1	48	5240	0.23	19.11	23.98	-1.00		Pass
HT40	MCS0	1	38	5190	0.57	17.56	23.98	-1.00		Pass
HT40	MCS0	1	46	5230	0.57	18.14	23.98	-1.00		Pass
VHT20	MCS0	1	36	5180	0.20	17.64	23.98	-1.00		Pass
VHT20	MCS0	1	44	5220	0.20	18.53	23.98	-1.00		Pass
VHT20	MCS0	1	48	5240	0.20	19.01	23.98	-1.00		Pass
VHT40	MCS0	1	38	5190	0.51	17.25	23.98	-1.00		Pass
VHT40	MCS0	1	46	5230	0.51	18.07	23.98	-1.00		Pass
VHT80	MCS0	1	42	5210	1.16	15.54	23.98	-1.00		Pass

TEST RESULTS DATA
Power Spectral Density

FCC Band I										
Mod.	Data Rate	NTX	CH.	Freq. (MHz)	Duty Factor (dB)	Average Power Density (dBm/MHz)	Average PSD Limit (dBm/MHz)	DG (dBi)	-	Pass/Fail
11a	6Mbps	1	36	5180	0.19	7.25	11.00	-1.00		Pass
11a	6Mbps	1	44	5220	0.19	6.17	11.00	-1.00		Pass
11a	6Mbps	1	48	5240	0.19	6.66	11.00	-1.00		Pass
HT20	MCS0	1	36	5180	0.23	7.22	11.00	-1.00		Pass
HT20	MCS0	1	44	5220	0.23	6.38	11.00	-1.00		Pass
HT20	MCS0	1	48	5240	0.23	6.91	11.00	-1.00		Pass
HT40	MCS0	1	38	5190	0.57	2.77	11.00	-1.00		Pass
HT40	MCS0	1	46	5230	0.57	2.28	11.00	-1.00		Pass
VHT80	MCS0	1	42	5210	1.16	-1.52	11.00	-1.00		Pass

TEST RESULTS DATA
26dB and 99% OBW

Band II										
Mod.	Data Rate	NTX	CH.	Freq. (MHz)	99% Bandwidth (MHz)	26 dB Bandwidth (MHz)	IC 99% Bandwidth Power Limit (dBm)	IC 99% Bandwidth EIRP Limit (dBm)	FCC 26dB Bandwidth Power Limit (dBm)	Note
11a	6M bps	1	52	5260	17.28	22.38	23.38	29.38	23.98	
11a	6M bps	1	60	5300	17.28	22.28	23.38	29.38	23.98	
11a	6M bps	1	64	5320	17.33	22.33	23.39	29.39	23.98	
HT20	MCS 0	1	52	5260	18.38	22.98	23.64	29.64	23.98	
HT20	MCS 0	1	60	5300	18.43	22.78	23.66	29.66	23.98	
HT20	MCS 0	1	64	5320	18.43	23.03	23.66	29.66	23.98	
HT40	MCS 0	1	54	5270	38.96	48.55	23.98	30.00	23.98	
HT40	MCS 0	1	62	5310	38.86	49.00	23.98	30.00	23.98	
VHT80	MCS 0	1	58	5290	77.08	92.55	23.98	30.00	23.98	

TEST RESULTS DATA
Average Power Table

FCC Band II										
Mod.	Data Rate	NTX	CH.	Freq. (MHz)	Duty Factor (dB)	Average Conducted Power (dBm)	FCC Conducted Power Limit (dBm)	DG (dBi)	EIRP Power Limit (dBm)	Pass/Fail
11a	6M bps	1	52	5260	0.19	18.20	23.98	-1.20	26.99	Pass
11a	6M bps	1	60	5300	0.19	18.42	23.98	-1.20	26.99	Pass
11a	6M bps	1	64	5320	0.19	18.57	23.98	-1.20	26.99	Pass
HT20	MCS 0	1	52	5260	0.23	18.61	23.98	-1.20	26.99	Pass
HT20	MCS 0	1	60	5300	0.23	18.78	23.98	-1.20	26.99	Pass
HT20	MCS 0	1	64	5320	0.23	18.94	23.98	-1.20	26.99	Pass
HT40	MCS 0	1	54	5270	0.57	18.15	23.98	-1.20	26.99	Pass
HT40	MCS 0	1	62	5310	0.57	18.44	23.98	-1.20	26.99	Pass
VHT20	MCS 0	1	52	5260	0.20	18.54	23.98	-1.20	26.99	Pass
VHT20	MCS 0	1	60	5300	0.20	18.75	23.98	-1.20	26.99	Pass
VHT20	MCS 0	1	64	5320	0.20	18.93	23.98	-1.20	26.99	Pass
VHT40	MCS 0	1	54	5270	0.51	18.09	23.98	-1.20	26.99	Pass
VHT40	MCS 0	1	62	5310	0.51	18.44	23.98	-1.20	26.99	Pass
VHT80	MCS 0	1	58	5290	1.16	16.62	23.98	-1.20	26.99	Pass

TEST RESULTS DATA
Power Spectral Density

Band II										
Mod.	Data Rate	NTX	CH.	Freq. (MHz)	Duty Factor (dB)	Average Power Density (dBm/MHz)	Average PSD Limit (dBm/MHz)	DG (dBi)		Pass/Fail
11a	6M bps	1	52	5260	0.19	6.69	11.00	-1.20		Pass
11a	6M bps	1	60	5300	0.19	5.76	11.00	-1.20		Pass
11a	6M bps	1	64	5320	0.19	6.48	11.00	-1.20		Pass
HT20	MCS 0	1	52	5260	0.23	7.06	11.00	-1.20		Pass
HT20	MCS 0	1	60	5300	0.23	6.04	11.00	-1.20		Pass
HT20	MCS 0	1	64	5320	0.23	6.82	11.00	-1.20		Pass
HT40	MCS 0	1	54	5270	0.57	2.07	11.00	-1.20		Pass
HT40	MCS 0	1	62	5310	0.57	1.80	11.00	-1.20		Pass
VHT80	MCS 0	1	58	5290	1.16	-2.04	11.00	-1.20		Pass

TEST RESULTS DATA
Average Power Table

FCC Band III										
Mod.	Data Rate	N _{TX}	CH.	Freq. (MHz)	Duty Factor (dB)	Average Conducted Power (dBm)	FCC Conducted Power Limit (dBm)	DG (dBi)	EIRP Power Limit (dBm)	Pass/Fail
11a	6M bps	1	100	5500	0.19	18.40	23.98	-1.20	26.99	Pass
11a	6M bps	1	116	5580	0.19	18.55	23.98	-1.20	26.99	Pass
11a	6M bps	1	140	5700	0.19	17.96	23.98	-1.20	26.99	Pass
11a	6Mbps	1	144	5720	0.19	17.44	23.98	-1.20	26.99	Pass
HT20	MCS 0	1	100	5500	0.23	18.88	23.98	-1.20	26.99	Pass
HT20	MCS 0	1	116	5580	0.23	18.91	23.98	-1.20	26.99	Pass
HT20	MCS 0	1	140	5700	0.23	18.03	23.98	-1.20	26.99	Pass
HT20	MCS0	1	144	5720	0.23	17.41	23.98	-1.20	26.99	Pass
HT40	MCS 0	1	102	5510	0.57	18.66	23.98	-1.20	26.99	Pass
HT40	MCS 0	1	110	5550	0.57	18.58	23.98	-1.20	26.99	Pass
HT40	MCS 0	1	134	5670	0.57	17.30	23.98	-1.20	26.99	Pass
HT40	MCS0	1	142	5710	0.57	17.16	23.98	-1.20	26.99	Pass
VHT20	MCS 0	1	100	5500	0.20	18.85	23.98	-1.20	26.99	Pass
VHT20	MCS 0	1	116	5580	0.20	18.89	23.98	-1.20	26.99	Pass
VHT20	MCS 0	1	140	5700	0.20	17.96	23.98	-1.20	26.99	Pass
VHT20	MCS 0	1	144	5720	0.20	17.40	23.98	-1.20	26.99	Pass
VHT40	MCS 0	1	102	5510	0.51	18.54	23.98	-1.20	26.99	Pass
VHT40	MCS 0	1	110	5550	0.51	18.53	23.98	-1.20	26.99	Pass
VHT40	MCS 0	1	134	5670	0.51	17.29	23.98	-1.20	26.99	Pass
VHT40	MCS0	1	142	5710	0.51	16.98	23.98	-1.20	26.99	Pass
VHT80	MCS 0	1	106	5530	1.16	16.50	23.98	-1.20	26.99	Pass
VHT80	MCS 0	1	122	5610	1.16	16.32	23.98	-1.20	26.99	Pass
VHT80	MCS0	1	138	5690	1.16	14.98	23.98	-1.20	26.99	Pass

TEST RESULTS DATA
26dB and 99% OBW

Band III										
Mod.	Data Rate	N _{TX}	CH.	Freq. (MHz)	99% Bandwidth (MHz)	26 dB Bandwidth (MHz)	IC 99% Bandwidth Power Limit (dBm)	IC 99% Bandwidth EIRP Limit (dBm)	FCC 26dB Bandwidth Power Limit (dBm)	Note
11a	6M bps	1	100	5500	17.33	22.43	23.39	29.39	23.98	
11a	6M bps	1	116	5580	17.23	22.23	23.36	29.36	23.98	
11a	6M bps	1	140	5700	17.33	22.68	23.39	29.39	23.98	
11a	6Mbps	1	144	5720	17.18	22.18	23.35	29.35	23.98	
HT20	MCS 0	1	100	5500	18.43	23.18	23.66	29.66	23.98	
HT20	MCS 0	1	116	5580	18.48	23.18	23.67	29.67	23.98	
HT20	MCS 0	1	140	5700	18.63	23.78	23.70	29.70	23.98	
HT20	MCS0	1	144	5720	18.33	22.88	23.63	29.63	23.98	
HT40	MCS 0	1	102	5510	38.96	47.92	23.98	30.00	23.98	
HT40	MCS 0	1	110	5550	38.76	56.64	23.98	30.00	23.98	
HT40	MCS 0	1	134	5670	38.86	50.62	23.98	30.00	23.98	
HT40	MCS 0	1	142	5710	38.46	48.55	23.98	30.00	23.98	
VHT80	MCS 0	1	106	5530	77.32	93.19	23.98	30.00	23.98	
VHT80	MCS 0	1	122	5610	77.20	89.83	23.98	30.00	23.98	
VHT80	MCS0	1	138	5690	77.32	106.77	23.98	30.00	23.98	

TEST RESULTS DATA
Power Spectral Density

Band III										
Mod.	Data Rate	N _{TX}	CH.	Freq. (MHz)	Duty Factor (dB)	Average Power Density (dBm/MHz)	Average PSD Limit (dBm/MHz)	DG (dBi)		Pass/Fail
11a	6M bps	1	100	5500	0.19	6.36	11.00	-1.20		Pass
11a	6M bps	1	116	5580	0.19	6.16	11.00	-1.20		Pass
11a	6M bps	1	140	5700	0.19	6.34	11.00	-1.20		Pass
11a	6Mbps	1	144	5720	0.19	3.65	11.00	-1.20		Pass
HT20	MCS 0	1	100	5500	0.23	6.64	11.00	-1.20		Pass
HT20	MCS 0	1	116	5580	0.23	6.55	11.00	-1.20		Pass
HT20	MCS 0	1	140	5700	0.23	6.38	11.00	-1.20		Pass
HT20	MCS0	1	144	5720	0.23	3.95	11.00	-1.20		Pass
HT40	MCS 0	1	102	5510	0.57	2.40	11.00	-1.20		Pass
HT40	MCS 0	1	110	5550	0.57	2.12	11.00	-1.20		Pass
HT40	MCS 0	1	134	5670	0.57	1.29	11.00	-1.20		Pass
HT40	MCS 0	1	142	5710	0.57	-0.59	11.00	-1.20		Pass
VHT80	MCS 0	1	106	5530	1.16	-1.62	11.00	-1.20		Pass
VHT80	MCS 0	1	122	5610	1.16	-2.19	11.00	-1.20		Pass
VHT80	MCS0	1	138	5690	1.16	-3.35	11.00	-1.20		Pass



Appendix B. AC Conducted Emission Test Results

Test Engineer :	Amos Zhang	Temperature :	25.3~26.2°C
		Relative Humidity :	38~40%
Test Voltage :	120Vac / 60Hz	Phase :	Line
Remark :	All emissions not reported here are more than 10 dB below the prescribed limit.		

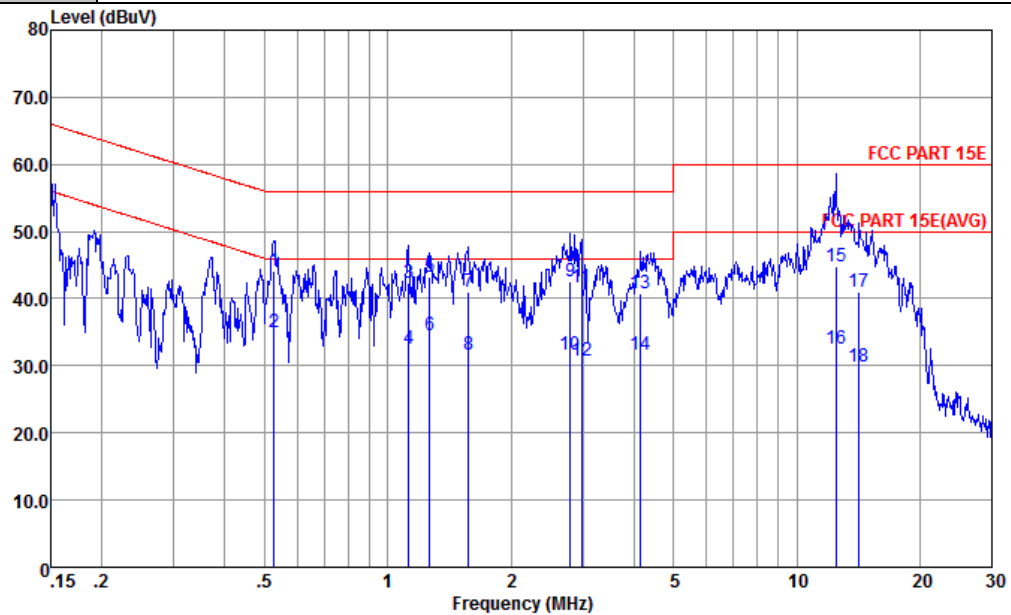

Site : CO01-KS
 Condition : FCC PART 15E LISN-L-181119-060105 LINE
 mode : Mode 1
 : 354142100011792/354142100011800 #8

	Freq	Level	Over Limit	Limit Line	Read Level	LISN Factor	Cable Loss	Remark
	MHz	dBuV	dB	dBuV	dBuV	dB	dB	
1	0.527	44.21	-11.79	56.00	33.80	0.17	10.24	QP
2 *	0.527	35.01	-10.99	46.00	24.60	0.17	10.24	Average
3	1.123	42.34	-13.66	56.00	31.91	0.20	10.23	QP
4	1.123	32.54	-13.46	46.00	22.11	0.20	10.23	Average
5	1.269	43.34	-12.66	56.00	32.90	0.21	10.23	QP
6	1.269	34.64	-11.36	46.00	24.20	0.21	10.23	Average
7	1.577	41.04	-14.96	56.00	30.60	0.21	10.23	QP
8	1.577	31.64	-14.36	46.00	21.20	0.21	10.23	Average
9	2.794	42.67	-13.33	56.00	32.20	0.23	10.24	QP
10	2.794	31.57	-14.43	46.00	21.10	0.23	10.24	Average
11	2.978	41.77	-14.23	56.00	31.30	0.23	10.24	QP
12	2.978	30.77	-15.23	46.00	20.30	0.23	10.24	Average
13	4.158	40.80	-15.20	56.00	30.31	0.24	10.25	QP
14	4.158	31.70	-14.30	46.00	21.21	0.24	10.25	Average
15	12.449	44.80	-15.20	60.00	34.20	0.23	10.37	QP
16	12.449	32.50	-17.50	50.00	21.90	0.23	10.37	Average
17	14.213	41.11	-18.89	60.00	30.50	0.22	10.39	QP
18	14.213	29.91	-20.09	50.00	19.30	0.22	10.39	Average



Test Engineer :	Amos Zhang	Temperature :	25.3~26.2°C
		Relative Humidity :	38~40%
Test Voltage :	120Vac / 60Hz	Phase :	Neutral
Remark :	All emissions not reported here are more than 10 dB below the prescribed limit.		

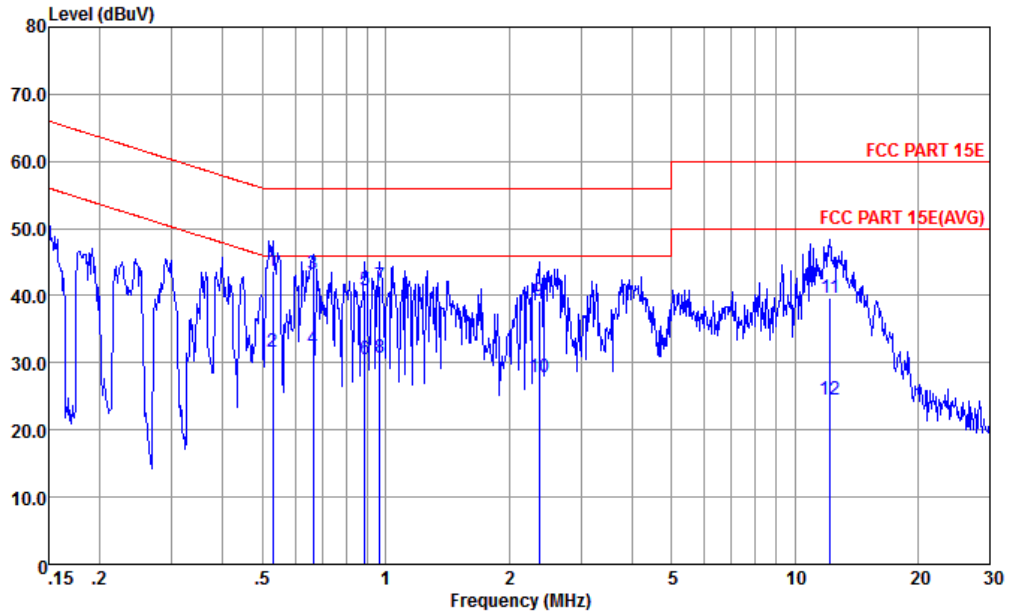

Site : CO01-KS
 Condition : FCC PART 15E LISN-N-181119-060105 NEUTRAL
 mode : Mode 1
 : 354142100011792/354142100011800 #8

	Freq	Level	Over Limit	Limit	Read	LISN	Cable	Loss	Remark
	MHz	dBuV		dB	dBuV	dBuV	dB	dB	
1 *	0.529	43.58	-12.42	56.00	33.19	0.15	10.24	QP	
2	0.529	31.68	-14.32	46.00	21.29	0.15	10.24	Average	
3	0.665	43.28	-12.72	56.00	32.90	0.14	10.24	QP	
4	0.665	31.98	-14.02	46.00	21.60	0.14	10.24	Average	
5	0.890	40.87	-15.13	56.00	30.50	0.13	10.24	QP	
6	0.890	30.47	-15.53	46.00	20.10	0.13	10.24	Average	
7	0.968	41.47	-14.53	56.00	31.11	0.13	10.23	QP	
8	0.968	30.67	-15.33	46.00	20.31	0.13	10.23	Average	
9	2.371	39.29	-16.71	56.00	28.90	0.16	10.23	QP	
10	2.371	27.89	-18.11	46.00	17.50	0.16	10.23	Average	
11	12.188	39.71	-20.29	60.00	29.19	0.15	10.37	QP	
12	12.188	24.61	-25.39	50.00	14.09	0.15	10.37	Average	



Appendix C. Radiated Spurious Emission

Band 1 - 5150~5250MHz
WIFI 802.11a (Band Edge @ 3m)

WIFI Ant.	Note	Frequency	Level	Over Limit	Limit Line	Read Level	Antenna Factor	Cable Loss	Preamp Factor	Ant Pos	Table Pos	Peak Avg.	Pol.
1		(MHz)	(dBμV/m)	(dB)	(dBμV/m)	(dBμV)	(dB/m)	(dB)	(dB)	(cm)	(deg)	(P/A)	(H/V)
802.11a CH 36 5180MHz		5148.96	52.27	-21.73	74	44.31	31.16	8.47	31.67	242	239	P	H
		5150	42.21	-11.79	54	34.25	31.16	8.47	31.67	242	239	A	H
	*	5184	101.89	-	-	93.97	31.1	8.48	31.66	242	239	P	H
	*	5184	94.32	-	-	86.4	31.1	8.48	31.66	242	239	A	H
		5111.84	50.25	-23.75	74	42.27	31.22	8.46	31.7	127	150	P	V
		5149.76	40.91	-13.09	54	32.95	31.16	8.47	31.67	127	150	A	V
	*	5182	97.42	-	-	89.5	31.1	8.48	31.66	127	150	P	V
	*	5182	89.92	-	-	82	31.1	8.48	31.66	127	150	A	V
Remark	1. No other spurious found. 2. All results are PASS against Peak and Average limit line.												



Band 1 5150~5250MHz

WIFI 802.11a (Harmonic @ 3m)

WIFI Ant. 1	Note	Frequency (MHz)	Level (dBμV/m)	Over Limit (dB)	Limit Line (dBμV/m)	Read Level (dBμV)	Antenna Factor (dB/m)	Cable Loss (dB)	Preamp Factor (dB)	Ant Pos (cm)	Table Pos (deg)	Peak Avg. (P/A)	Pol. (H/V)
802.11a CH 36		10360	41.48	-26.82	68.3	56.22	38.04	12.29	65.07	100	0	P	H
5180MHz		10360	41.22	-27.08	68.3	55.96	38.04	12.29	65.07	100	0	P	V
802.11a CH 44		10440	42.81	-25.49	68.3	57.41	38.14	12.35	65.09	100	0	P	H
5220MHz		10440	43.28	-25.02	68.3	57.88	38.14	12.35	65.09	100	0	P	V
802.11a CH 48		10480	43	-25.3	68.3	57.49	38.22	12.4	65.11	100	360	P	H
5240MHz		10480	42.6	-25.7	68.3	57.09	38.22	12.4	65.11	100	360	P	V
Remark	1. No other spurious found. 2. All results are PASS against Peak and Average limit line.												



Band 1 5150~5250MHz
WIFI 802.11n HT20 (Band Edge @ 3m)

Table with 14 columns: WIFI Ant. 1, Note, Frequency (MHz), Level (dBµV/m), Over Limit (dB), Limit Line (dBµV/m), Read Level (dBµV), Antenna Factor (dB/m), Cable Loss (dB), Preamp Factor (dB), Ant Pos (cm), Table Pos (deg), Peak Avg. (P/A), Pol. (H/V). Rows include test results for 802.11n HT20 CH 36 5180MHz and a Remark section.



Band 1 5150~5250MHz
WIFI 802.11n HT20 (Harmonic @ 3m)

Table with 14 columns: WIFI Ant. 1, Note, Frequency (MHz), Level (dBµV/m), Over Limit (dB), Limit Line (dBµV/m), Read Level (dBµV), Antenna Factor (dB/m), Cable Loss (dB), Preamp Factor (dB), Ant Pos (cm), Table Pos (deg), Peak Avg. (P/A), Pol. (H/V). Rows include data for 802.11n HT20 CH 36 (5180MHz), CH 44 (5220MHz), and CH 48 (5240MHz). A Remark section at the bottom states: '1. No other spurious found. 2. All results are PASS against Peak and Average limit line.'



Band 1 5150~5250MHz
WIFI 802.11n HT40 (Band Edge @ 3m)

Table with 14 columns: WIFI Ant. 1, Note, Frequency (MHz), Level (dBµV/m), Over Limit (dB), Limit Line (dBµV/m), Read Level (dBµV), Antenna Factor (dB/m), Cable Loss (dB), Preamp Factor (dB), Ant Pos (cm), Table Pos (deg), Peak Avg. (P/A), Pol. (H/V). Rows include test data for 802.11n HT40 CH 38 5190MHz and a Remark section.



Band 1 5150~5250MHz
WIFI 802.11n HT40 (Harmonic @ 3m)

Table with 14 columns: WIFI Ant. 1, Note, Frequency (MHz), Level (dBµV/m), Over Limit (dB), Limit Line (dBµV/m), Read Level (dBµV), Antenna Factor (dB/m), Cable Loss (dB), Preamp Factor (dB), Ant Pos (cm), Table Pos (deg), Peak Avg. (P/A), Pol. (H/V). Rows include data for 802.11n HT40 CH 38 5190MHz and CH 46 5230MHz, plus a Remark section.



Band 1 5150~5250MHz
WIFI 802.11ac VHT80 (Band Edge @ 3m)

Table with 14 columns: WIFI Ant. 1, Note, Frequency (MHz), Level (dBµV/m), Over Limit (dB), Limit Line (dBµV/m), Read Level (dBµV), Antenna Factor (dB/m), Cable Loss (dB), Preamp Factor (dB), Ant Pos (cm), Table Pos (deg), Peak Avg. (P/A), Pol. (H/V). Rows include test results for frequencies like 5149.6, 5148.64, 5200, 5200, 5366.16, 5350.86, 5147.68, 5148.8, 5192, 5192, 5374.08, 5370.3.

Remark

- 1. No other spurious found.
2. All results are PASS against Peak and Average limit line.



Band 1 5150~5250MHz

WIFI 802.11ac VHT80 (Harmonic @ 3m)

WIFI Ant. 1	Note	Frequency (MHz)	Level (dBμV/m)	Over Limit (dB)	Limit Line (dBμV/m)	Read Level (dBμV)	Antenna Factor (dB/m)	Cable Loss (dB)	Preamp Factor (dB)	Ant Pos (cm)	Table Pos (deg)	Peak Avg. (P/A)	Pol. (H/V)
802.11ac VHT80		10420	41.13	-27.17	68.3	55.76	38.12	12.34	65.09	300	0	P	H
CH 42 5210MHz		10420	40.03	-28.27	68.3	54.66	38.12	12.34	65.09	300	360	P	V
Remark	1. No other spurious found. 2. All results are PASS against Peak and Average limit line.												



Band 2 - 5250~5350MHz
WIFI 802.11a (Band Edge @ 3m)

Table with 14 columns: WIFI, Note, Frequency, Level, Over, Limit, Read, Antenna, Cable, Preamp, Ant, Table, Peak, Pol. It contains 8 rows of test data for 802.11a CH 64 at 5320MHz and a Remark section at the bottom.



Band 2 5250~5350MHz

WIFI 802.11a (Harmonic @ 3m)

WIFI Ant. 1	Note	Frequency (MHz)	Level (dBμV/m)	Over Limit (dB)	Limit Line (dBμV/m)	Read Level (dBμV)	Antenna Factor (dB/m)	Cable Loss (dB)	Preamp Factor (dB)	Ant Pos (cm)	Table Pos (deg)	Peak Avg. (P/A)	Pol. (H/V)
802.11a CH 52		10520	42.8	-25.5	68.3	57.22	38.27	12.43	65.12	150	360	P	H
5260MHz		10520	41.39	-26.91	68.3	55.81	38.27	12.43	65.12	150	0	P	V
802.11a CH 60		10600	43.09	-30.91	74	57.33	38.39	12.52	65.15	100	360	P	H
5300MHz		10600	43.67	-30.33	74	57.91	38.39	12.52	65.15	100	360	P	V
802.11a CH 64		10640	42.35	-31.65	74	56.52	38.44	12.55	65.16	100	360	P	H
5320MHz		10640	43.39	-30.61	74	57.56	38.44	12.55	65.16	100	0	P	V
Remark	1. No other spurious found. 2. All results are PASS against Peak and Average limit line.												



Band 2 5250~5350MHz
WIFI 802.11n HT20 (Band Edge @ 3m)

Table with 14 columns: WIFI Ant. 1, Note, Frequency (MHz), Level (dBµV/m), Over Limit (dB), Limit Line (dBµV/m), Read Level (dBµV), Antenna Factor (dB/m), Cable Loss (dB), Preamp Factor (dB), Ant Pos (cm), Table Pos (deg), Peak Avg. (P/A), Pol. (H/V). Rows include test results for 802.11n HT20 CH 64 5320MHz and a Remark section.



Band 2 5250~5350MHz
WIFI 802.11n HT20 (Harmonic @ 3m)

Table with 14 columns: WIFI Ant. 1, Note, Frequency (MHz), Level (dBµV/m), Over Limit (dB), Limit Line (dBµV/m), Read Level (dBµV), Antenna Factor (dB/m), Cable Loss (dB), Preamp Factor (dB), Ant Pos (cm), Table Pos (deg), Peak Avg. (P/A), Pol. (H/V). Rows include test results for channels 52, 60, and 64 at various frequencies.



Band 2 5250~5350MHz
WIFI 802.11n HT40 (Band Edge @ 3m)

WIFI Ant. 1	Note	Frequency (MHz)	Level (dBμV/m)	Over Limit (dB)	Limit Line (dBμV/m)	Read Level (dBμV)	Antenna Factor (dB/m)	Cable Loss (dB)	Preamp Factor (dB)	Ant Pos (cm)	Table Pos (deg)	Peak Avg. (P/A)	Pol. (H/V)
802.11n HT40 CH 62 5310MHz		5124	50.99	-23.01	74	43.02	31.19	8.47	31.69	140	239	P	H
		5117.12	40.61	-13.39	54	32.63	31.22	8.46	31.7	140	239	A	H
	*	5320	96.74	-	-	88.85	30.86	8.62	31.59	140	239	P	H
		5320	89.39	-	-	81.5	30.86	8.62	31.59	140	239	A	H
		5361.8	62.75	-11.25	74	54.86	30.78	8.68	31.57	140	239	P	H
		5350.189	46.33	-7.67	54	38.43	30.81	8.66	31.57	140	239	A	H
		5110.08	49.29	-24.71	74	41.31	31.22	8.46	31.7	293	83	P	V
		5105.28	40.69	-13.31	54	32.68	31.25	8.46	31.7	293	83	A	V
	*	5320	90.99	-	-	83.1	30.86	8.62	31.59	293	83	P	V
		5320	83.67	-	-	75.78	30.86	8.62	31.59	293	83	A	V
		5360.9	56.45	-17.55	74	48.56	30.78	8.68	31.57	293	83	P	V
		5350.3	42.21	-11.79	54	34.31	30.81	8.66	31.57	293	83	A	V
Remark	1. No other spurious found. 2. All results are PASS against Peak and Average limit line.												



Band 2 5250~5350MHz
WIFI 802.11n HT40 (Harmonic @ 3m)

Table with 14 columns: WIFI Ant. 1, Note, Frequency (MHz), Level (dBµV/m), Over Limit (dB), Limit Line (dBµV/m), Read Level (dBµV), Antenna Factor (dB/m), Cable Loss (dB), Preamp Factor (dB), Ant Pos (cm), Table Pos (deg), Peak Avg. (P/A), Pol. (H/V). Rows include data for 802.11n HT40 CH 54 at 10540MHz and CH 62 at 10620MHz.

Remark

- 1. No other spurious found.
2. All results are PASS against Peak and Average limit line.



Band 2 5250~5350MHz
WIFI 802.11ac VHT80 (Band Edge @ 3m)

WIFI Ant. 1	Note	Frequency (MHz)	Level (dBμV/m)	Over Limit (dB)	Limit Line (dBμV/m)	Read Level (dBμV)	Antenna Factor (dB/m)	Cable Loss (dB)	Preamp Factor (dB)	Ant Pos (cm)	Table Pos (deg)	Peak Avg. (P/A)	Pol. (H/V)
802.11ac VHT80 CH 58 5290MHz		5124.64	50.51	-23.49	74	42.54	31.19	8.47	31.69	106	230	P	H
		5105.92	41.22	-12.78	54	33.24	31.22	8.46	31.7	106	230	A	H
	*	5304	91.06	-	-	83.16	30.89	8.6	31.59	106	230	P	H
		5304	83.87	-	-	75.97	30.89	8.6	31.59	106	230	A	H
		5350.7	58.39	-15.61	74	50.49	30.81	8.66	31.57	106	230	P	H
		5350.6	45.87	-8.13	54	37.97	30.81	8.66	31.57	106	230	A	H
		5114.24	50.05	-23.95	74	42.07	31.22	8.46	31.7	242	94	P	V
		5119.52	41.13	-12.87	54	33.14	31.22	8.46	31.69	242	94	A	V
	*	5298	86.3	-	-	78.4	30.89	8.6	31.59	242	94	P	V
		5298	79.02	-	-	71.12	30.89	8.6	31.59	242	94	A	V
		5350.7	54.06	-19.94	74	46.16	30.81	8.66	31.57	242	94	P	V
		5350.6	42.04	-11.96	54	34.14	30.81	8.66	31.57	242	94	A	V
Remark	1. No other spurious found. 2. All results are PASS against Peak and Average limit line.												



Band 2 5250~5350MHz

WIFI 802.11ac VHT80 (Harmonic @ 3m)

WIFI Ant. 1	Note	Frequency (MHz)	Level (dBμV/m)	Over Limit (dB)	Limit Line (dBμV/m)	Read Level (dBμV)	Antenna Factor (dB/m)	Cable Loss (dB)	Preamp Factor (dB)	Ant Pos (cm)	Table Pos (deg)	Peak Avg. (P/A)	Pol. (H/V)
802.11ac VHT80		10580	42.24	-26.06	68.3	56.51	38.37	12.50	65.14	100	360	P	H
CH 58 5290MHz		10580	41.74	-26.56	68.3	56.01	38.37	12.50	65.14	100	0	P	V
Remark	1. No other spurious found. 2. All results are PASS against Peak and Average limit line.												



Band 3 - 5470~5725MHz
WIFI 802.11a (Band Edge @ 3m)

WIFI	Note	Frequency	Level	Over	Limit	Read	Antenna	Cable	Preamp	Ant	Table	Peak	Pol.
Ant.				Limit	Line	Level	Factor	Loss	Factor	Pos	Pos	Avg.	
1		(MHz)	(dBμV/m)	(dB)	(dBμV/m)	(dBμV)	(dB/m)	(dB)	(dB)	(cm)	(deg)	(P/A)	(H/V)
802.11a CH 100 5500MHz		5457.84	53.65	-20.35	74	45.76	30.63	8.77	31.51	100	230	P	H
		5469.52	58.72	-9.58	68.3	50.85	30.6	8.78	31.51	100	230	P	H
		5460	42.94	-11.06	54	35.05	30.63	8.77	31.51	100	230	A	H
	*	5498	104.23	-	-	96.38	30.54	8.81	31.5	100	230	P	H
		5498	96.95	-	-	89.1	30.54	8.81	31.5	100	230	A	H
		5442	48.89	-25.11	74	41.01	30.66	8.75	31.53	100	208	P	V
		5468.08	55.48	-12.82	68.3	47.61	30.6	8.78	31.51	100	208	P	V
		5460	40.42	-13.58	54	32.53	30.63	8.77	31.51	100	208	A	V
	*	5504	100.04	-	-	92.18	30.54	8.81	31.49	100	208	P	V
		5504	92.66	-	-	84.8	30.54	8.81	31.49	100	208	A	V
802.11a CH 140 5700MHz	*	5698	105.28	-	-	97.07	30.72	8.98	31.49	223	294	P	H
		5698	98.11	-	-	89.9	30.72	8.98	31.49	223	294	A	H
		5725.8	59.81	-8.49	68.3	51.33	30.99	9.01	31.52	223	294	P	H
	*	5696	100.1	-	-	91.89	30.72	8.98	31.49	100	208	P	V
		5696	93.01	-	-	84.8	30.72	8.98	31.49	100	208	A	V
		5725.24	61.24	-7.06	68.3	52.76	30.99	9.01	31.52	100	208	P	V
Remark	1. No other spurious found. 2. All results are PASS against Peak and Average limit line.												



Band 3 - 5470~5725MHz
WIFI 802.11a (Harmonic @ 3m)

Table with 14 columns: WIFI Ant. 1, Note, Frequency (MHz), Level (dBµV/m), Over Limit (dB), Limit Line (dBµV/m), Read Level (dBµV), Antenna Factor (dB/m), Cable Loss (dB), Preamp Factor (dB), Ant Pos (cm), Table Pos (deg), Peak Avg. (P/A), Pol. (H/V). Rows include channels 100, 116, and 140 at various frequencies.

Remark
1. No other spurious found.
2. All results are PASS against Peak and Average limit line.



Band 3 - 5470~5725MHz
WIFI 802.11n HT20 (Band Edge @ 3m)

Table with 14 columns: WIFI Ant. 1, Note, Frequency (MHz), Level (dBµV/m), Over Limit (dB), Limit Line (dBµV/m), Read Level (dBµV), Antenna Factor (dB/m), Cable Loss (dB), Preamp Factor (dB), Ant Pos (cm), Table Pos (deg), Peak Avg. (P/A), Pol. (H/V). Rows include test data for 802.11n HT20 CH 100 (5500MHz) and CH 140 (5700MHz), and a Remark section.



Band 3 - 5470~5725MHz
WIFI 802.11n HT20 (Harmonic @ 3m)

Table with 14 columns: WIFI Ant. 1, Note, Frequency (MHz), Level (dBµV/m), Over Limit (dB), Limit Line (dBµV/m), Read Level (dBµV), Antenna Factor (dB/m), Cable Loss (dB), Preamp Factor (dB), Ant Pos (cm), Table Pos (deg), Peak Avg. (P/A), Pol. (H/V). Rows include data for channels 100, 116, and 140 at various frequencies.



Band 3 - 5470~5725MHz
WIFI 802.11n HT40 (Band Edge @ 3m)

Table with 14 columns: WIFI Ant. 1, Note, Frequency (MHz), Level (dBµV/m), Over Limit (dB), Limit Line (dBµV/m), Read Level (dBµV), Antenna Factor (dB/m), Cable Loss (dB), Preamp Factor (dB), Ant Pos (cm), Table Pos (deg), Peak Avg. (P/A), Pol. (H/V). Rows include data for 802.11n HT40 CH 102 (5510MHz) and 802.11n HT40 CH 134 (5670MHz).

Remark
1. No other spurious found.
2. All results are PASS against Peak and Average limit line.



Band 3 - 5470~5725MHz
WIFI 802.11n HT40 (Harmonic @ 3m)

Table with 14 columns: WIFI Ant. 1, Note, Frequency (MHz), Level (dBµV/m), Over Limit (dB), Limit Line (dBµV/m), Read Level (dBµV), Antenna Factor (dB/m), Cable Loss (dB), Preamp Factor (dB), Ant Pos (cm), Table Pos (deg), Peak Avg. (P/A), Pol. (H/V). Rows include data for channels 102, 110, and 134 at various frequencies.



Band 3 - 5470~5725MHz
WIFI 802.11ac VHT80 (Band Edge @ 3m)

WIFI Ant. 1	Note	Frequency (MHz)	Level (dBμV/m)	Over Limit (dB)	Limit Line (dBμV/m)	Read Level (dBμV)	Antenna Factor (dB/m)	Cable Loss (dB)	Preamp Factor (dB)	Ant Pos (cm)	Table Pos (deg)	Peak Avg. (P/A)	Pol. (H/V)
802.11ac VHT80 CH 106 5530MHz		5451.28	52.31	-21.69	74	44.42	30.63	8.77	31.51	155	242	P	H
		5469.2	65.25	-3.05	68.3	57.38	30.6	8.78	31.51	155	242	P	H
		5455.28	42.72	-11.28	54	34.83	30.63	8.77	31.51	155	242	A	H
	*	5512	90.78	-	-	82.92	30.54	8.81	31.49	155	242	P	H
		5512	81.97	-	-	74.11	30.54	8.81	31.49	155	242	A	H
		5735.4	48.24	-20.06	68.3	39.63	31.13	9.03	31.55	155	242	P	H
		5455.28	50.53	-23.47	74	42.64	30.63	8.77	31.51	327	83	P	V
		5469.84	60.24	-8.06	68.3	52.37	30.6	8.78	31.51	327	83	P	V
		5455.12	40.53	-13.47	54	32.64	30.63	8.77	31.51	327	83	A	V
	*	5536	83.69	-	-	75.84	30.48	8.84	31.47	327	83	P	V
		5536	76.88	-	-	69.03	30.48	8.84	31.47	327	83	A	V
		5737.24	48.46	-19.84	68.3	39.85	31.13	9.03	31.55	327	83	P	V
802.11ac VHT80 CH 122 5610MHz		5354.96	48.66	-25.34	74	40.76	30.81	8.66	31.57	100	218	P	H
		5464.56	48.46	-19.84	68.3	40.59	30.6	8.78	31.51	100	218	P	H
		5450.16	40.56	-13.44	54	32.67	30.63	8.77	31.51	100	218	A	H
	*	5592	93.1	-	-	85.28	30.39	8.88	31.45	100	218	P	H
		5592	85.25	-	-	77.43	30.39	8.88	31.45	100	218	A	H
		5738.04	48.98	-19.32	68.3	40.37	31.13	9.03	31.55	100	218	P	H
		5410.64	48.18	-25.82	74	40.28	30.72	8.72	31.54	262	83	P	V
		5466.96	47.31	-20.99	68.3	39.44	30.6	8.78	31.51	262	83	P	V
		5450.16	39.49	-14.51	54	31.6	30.63	8.77	31.51	262	83	A	V
	*	5598	87.94	-	-	80.12	30.39	8.88	31.45	262	83	P	V
	5598	80.64	-	-	72.82	30.39	8.88	31.45	262	83	A	V	
	5728.36	49.02	-19.28	68.3	40.54	30.99	9.01	31.52	262	83	P	V	
Remark	1. No other spurious found. 2. All results are PASS against Peak and Average limit line.												



Band 3 5470~5725MHz

WIFI 802.11ac VHT80 (Harmonic @ 3m)

WIFI Ant. 1	Note	Frequency (MHz)	Level (dBμV/m)	Over Limit (dB)	Limit Line (dBμV/m)	Read Level (dBμV)	Antenna Factor (dB/m)	Cable Loss (dB)	Preamp Factor (dB)	Ant Pos (cm)	Table Pos (deg)	Peak Avg. (P/A)	Pol. (H/V)
802.11ac VHT80		11060	42.25	-31.75	74	55.53	39.06	12.95	65.29	100	0	P	H
CH 106 5530MHz		11060	39.99	-34.01	74	53.27	39.06	12.95	65.29	100	0	P	V
802.11ac VHT80		11220	42.82	-31.18	74	55.77	39.28	13.1	65.33	100	360	P	H
CH 122 5610MHz		11220	42.55	-31.45	74	55.5	39.28	13.1	65.33	100	360	P	V
Remark	1. No other spurious found. 2. All results are PASS against Peak and Average limit line.												



Band 3 - 5470~5725MHz

WWAN+WIFI 802.11ac VHT80 (Band Edge @ 3m)

WIFI Ant. 1	Note	Frequency (MHz)	Level (dBμV/m)	Over Limit (dB)	Limit Line (dBμV/m)	Read Level (dBμV)	Antenna Factor (dB/m)	Cable Loss (dB)	Preamp Factor (dB)	Ant Pos (cm)	Table Pos (deg)	Peak Avg. (P/A)	Pol. (H/V)
802.11ac VHT80 CH 106 5530MHz		5453.52	49.91	-24.09	74	42.02	30.63	8.77	31.51	129	251	P	H
		5469.68	64.92	-3.38	68.3	57.05	30.6	8.78	31.51	129	251	P	H
		5455.12	41.25	-12.75	54	33.36	30.63	8.77	31.51	129	251	A	H
	*	5542	88.95	-	-	81.1	30.48	8.84	31.47	129	251	P	H
		5542	81.96	-	-	74.11	30.48	8.84	31.47	129	251	A	H
		5741.56	48.81	-19.49	68.3	40.2	31.13	9.03	31.55	129	251	P	H
		5422.8	48.74	-25.26	74	40.85	30.69	8.74	31.54	238	262	P	V
		5467.28	59.5	-8.8	68.3	51.63	30.6	8.78	31.51	238	262	P	V
		5455.6	39.79	-14.21	54	31.9	30.63	8.77	31.51	238	262	A	V
	*	5516	83.68	-	-	75.84	30.51	8.82	31.49	238	262	P	V
		5516	76.29	-	-	68.45	30.51	8.82	31.49	238	262	A	V
		5754.28	48.03	-20.27	68.3	39.26	31.27	9.05	31.55	238	262	P	V
Remark	3. No other spurious found. 4. All results are PASS against Peak and Average limit line.												



Band 3 5470~5725MHz

WWAN+WIFI 802.11ac VHT80 (Harmonic @ 3m)

WIFI Ant. 1	Note	Frequency (MHz)	Level (dBμV/m)	Over Limit (dB)	Limit Line (dBμV/m)	Read Level (dBμV)	Antenna Factor (dB/m)	Cable Loss (dB)	Preamp Factor (dB)	Ant Pos (cm)	Table Pos (deg)	Peak Avg. (P/A)	Pol. (H/V)
802.11ac VHT80		11060	43.52	-30.48	74	56.8	39.06	12.95	65.29	100	360	P	H
CH 106 5530MHz		11060	43.1	-30.9	74	56.38	39.06	12.95	65.29	100	0	P	V
Remark	3. No other spurious found. 4. All results are PASS against Peak and Average limit line.												



Band 3 - 5470~5725MHz

BT4.0+WIFI 802.11ac VHT80 (Band Edge @ 3m)

WIFI Ant. 1	Note	Frequency (MHz)	Level (dBμV/m)	Over Limit (dB)	Limit Line (dBμV/m)	Read Level (dBμV)	Antenna Factor (dB/m)	Cable Loss (dB)	Preamp Factor (dB)	Ant Pos (cm)	Table Pos (deg)	Peak Avg. (P/A)	Pol. (H/V)
802.11ac VHT80 CH 106 5530MHz		5456.72	49.33	-24.67	74	41.44	30.63	8.77	31.51	103	247	P	H
		5468.4	62.42	-5.88	68.3	54.55	30.6	8.78	31.51	103	247	P	H
		5459.44	41.08	-12.92	54	33.19	30.63	8.77	31.51	103	247	A	H
	*	5530	86.41	-	-	78.55	30.51	8.82	31.47	103	247	P	H
		5530	79.36	-	-	71.5	30.51	8.82	31.47	103	247	A	H
		5742.92	48.99	-19.31	68.3	40.38	31.13	9.03	31.55	103	247	P	H
		5466	54.32	-13.98	68.3	46.45	30.6	8.78	31.51	184	26	P	V
		5459.12	39.66	-14.34	54	31.77	30.63	8.77	31.51	184	26	P	V
		5526	81.33	-	-	73.49	30.51	8.82	31.49	184	26	A	V
	*	5526	74.14	-	-	66.3	30.51	8.82	31.49	184	26	P	V
	5757.08	48.67	-19.63	68.3	39.93	31.27	9.05	31.58	184	26	A	V	
	5466	54.32	-13.98	68.3	46.45	30.6	8.78	31.51	184	26	P	V	
Remark	5. No other spurious found. 6. All results are PASS against Peak and Average limit line.												



Band 3 5470~5725MHz

BT4.0+WIFI 802.11ac VHT80 (Harmonic @ 3m)

WIFI Ant. 1	Note	Frequency (MHz)	Level (dBμV/m)	Over Limit (dB)	Limit Line (dBμV/m)	Read Level (dBμV)	Antenna Factor (dB/m)	Cable Loss (dB)	Preamp Factor (dB)	Ant Pos (cm)	Table Pos (deg)	Peak Avg. (P/A)	Pol. (H/V)
802.11ac VHT80		11060	45.15	-28.85	74	58.43	39.06	12.95	65.29	100	0	P	H
CH 106 5530MHz		11060	42.9	-31.1	74	56.18	39.06	12.95	65.29	100	360	P	V
Remark	5. No other spurious found. 6. All results are PASS against Peak and Average limit line.												



Band 3 - Straddle Channel
WIFI 802.11a (Band Edge @ 3m)

Table with 14 columns: WIFI, Note, Frequency, Level, Over, Limit, Read, Antenna, Cable, Preamp, Ant, Table, Peak, Pol. It contains test data for 802.11a CH 144 at 5720MHz and a Remark section.



Band 3 - Straddle Channel
WIFI 802.11a (Harmonic @ 3m)

Table with 14 columns: WIFI Ant., Note, Frequency (MHz), Level (dBµV/m), Over Limit (dB), Limit Line (dBµV/m), Read Level (dBµV), Antenna Factor (dB/m), Cable Loss (dB), Preamp Factor (dB), Ant Pos (cm), Table Pos (deg), Peak Avg. (P/A), Pol. (H/V). Rows include data for 802.11a CH 144 at 5720MHz and a Remark section.



Band 3 - Straddle Channel
WIFI 802.11n HT20 (Band Edge @ 3m)

Table with 14 columns: WIFI Ant. 1, Note, Frequency (MHz), Level (dBµV/m), Over Limit (dB), Limit Line (dBµV/m), Read Level (dBµV), Antenna Factor (dB/m), Cable Loss (dB), Preamp Factor (dB), Ant Pos (cm), Table Pos (deg), Peak Avg. (P/A), Pol. (H/V). Rows include data for 802.11n HT20 and CH 144 5720MHz, and a Remark section.



Band 3 - Straddle Channel
WIFI 802.11n HT20 (Harmonic @ 3m)

Table with 14 columns: WIFI Ant. 1, Note, Frequency (MHz), Level (dBµV/m), Over Limit (dB), Limit Line (dBµV/m), Read Level (dBµV), Antenna Factor (dB/m), Cable Loss (dB), Preamp Factor (dB), Ant Pos (cm), Table Pos (deg), Peak Avg. (P/A), Pol. (H/V). Rows include test data for 802.11n HT20 CH 144 and a Remark section.



Band 3 - Straddle Channel
WIFI 802.11n HT40 (Band Edge @ 3m)

Table with 14 columns: WIFI Ant. 1, Note, Frequency (MHz), Level (dBµV/m), Over Limit (dB), Limit Line (dBµV/m), Read Level (dBµV), Antenna Factor (dB/m), Cable Loss (dB), Preamp Factor (dB), Ant Pos (cm), Table Pos (deg), Peak Avg. (P/A), Pol. (H/V). Rows include 802.11n HT40 and CH 142 5710MHz with various test results.

Remark
1. No other spurious found.
2. All results are PASS against Peak and Average limit line.



Band 3 - Straddle Channel
WIFI 802.11n HT40 (Harmonic @ 3m)

Table with 14 columns: WIFI Ant. 1, Note, Frequency (MHz), Level (dBµV/m), Over Limit (dB), Limit Line (dBµV/m), Read Level (dBµV), Antenna Factor (dB/m), Cable Loss (dB), Preamp Factor (dB), Ant Pos (cm), Table Pos (deg), Peak Avg. (P/A), Pol. (H/V). It contains two rows of test data and a Remark section.



Band 3 - Straddle Channel
WIFI 802.11ac VHT80 (Band Edge @ 3m)

Table with 14 columns: WIFI Ant. 1, Note, Frequency (MHz), Level (dBµV/m), Over Limit (dB), Limit Line (dBµV/m), Read Level (dBµV), Antenna Factor (dB/m), Cable Loss (dB), Preamp Factor (dB), Ant Pos (cm), Table Pos (deg), Peak Avg. (P/A), Pol. (H/V). Rows include 802.11ac VHT80, CH 138, and 5690MHz.

Remark
1. No other spurious found.
2. All results are PASS against Peak and Average limit line.



Band 3 - Straddle Channel
WIFI 802.11ac VHT80 (Harmonic @ 3m)

Table with 14 columns: WIFI Ant. 1, Note, Frequency (MHz), Level (dBµV/m), Over Limit (dB), Limit Line (dBµV/m), Read Level (dBµV), Antenna Factor (dB/m), Cable Loss (dB), Preamp Factor (dB), Ant Pos (cm), Table Pos (deg), Peak Avg. (P/A), Pol. (H/V). Rows include 802.11ac VHT80 CH 138 5690MHz and a Remark section.



Emission below 1GHz

WIFI 802.11ac VHT80 (LF @ 3m)

WIFI	Note	Frequency	Level	Over	Limit	Read	Antenna	Cable	Preamp	Ant	Table	Peak	Pol.
Ant.				Limit	Line	Level	Factor	Loss	Factor	Pos	Pos	Avg.	
1		(MHz)	(dBμV/m)	(dB)	(dBμV/m)	(dBμV)	(dB/m)	(dB)	(dB)	(cm)	(deg)	(P/A)	(H/V)
802.11ac VHT80 LF		30	21.26	-18.74	40	29.58	24.2	0.46	32.98	100	0	P	H
		96.93	20.62	-22.88	43.5	36.49	16.1	0.96	32.93	-	-	P	H
		290.93	21.74	-24.26	46	33.9	19.07	1.78	33.01	-	-	P	H
		508.21	20.96	-25.04	46	28.35	23.49	2.37	33.25	-	-	P	H
		698.33	23.13	-22.87	46	28.65	24.89	2.87	33.28	-	-	P	H
		896.21	25.44	-20.56	46	27.96	26.48	3.34	32.34	-	-	P	H
		35.82	28.07	-11.93	40	39.68	20.84	0.51	32.96	100	360	P	V
		96.93	27.17	-16.33	43.5	43.04	16.1	0.96	32.93	-	-	P	V
		262.8	16.78	-29.22	46	28.17	19.93	1.68	33	-	-	P	V
		494.63	21.63	-24.37	46	29.23	23.3	2.34	33.24	-	-	P	V
		675.05	23.03	-22.97	46	28.7	24.82	2.8	33.29	-	-	P	V
		956.35	25.7	-20.3	46	26.88	27.01	3.46	31.65	-	-	P	V
Remark	1. No other spurious found. 2. All results are PASS against limit line.												



Note symbol

*	Fundamental Frequency which can be ignored. However, the level of any unwanted emissions shall not exceed the level of the fundamental frequency.
!	Test result is over limit line.
P/A	Peak or Average
H/V	Horizontal or Vertical



A calculation example for radiated spurious emission is shown as below:

WIFI	Note	Frequency	Level	Over	Limit	Read	Antenna	Cable	Preamp	Ant	Table	Peak	Pol.
Ant.				Limit	Line	Level	Factor	Loss	Factor	Pos	Pos	Avg.	
1		(MHz)	(dBμV/m)	(dB)	(dBμV/m)	(dBμV)	(dB/m)	(dB)	(dB)	(cm)	(deg)	(P/A)	(H/V)
802.11b		2390	55.45	-18.55	74	54.51	32.22	4.58	35.86	103	308	P	H
CH 01													
2412MHz		2390	43.54	-10.46	54	42.6	32.22	4.58	35.86	103	308	A	H

- Level(dBμV/m) =
Antenna Factor(dB/m) + Cable Loss(dB) + Read Level(dBμV) - Preamp Factor(dB)
- Over Limit(dB) = Level(dBμV/m) – Limit Line(dBμV/m)

For Peak Limit @ 2390MHz:

- Level(dBμV/m)
= Antenna Factor(dB/m) + Cable Loss(dB) + Read Level(dBμV) - Preamp Factor(dB)
= 32.22(dB/m) + 4.58(dB) + 54.51(dBμV) – 35.86 (dB)
= 55.45 (dBμV/m)
- Over Limit(dB)
= Level(dBμV/m) – Limit Line(dBμV/m)
= 55.45(dBμV/m) – 74(dBμV/m)
= -18.55(dB)

For Average Limit @ 2390MHz:

- Level(dBμV/m)
= Antenna Factor(dB/m) + Cable Loss(dB) + Read Level(dBμV) - Preamp Factor(dB)
= 32.22(dB/m) + 4.58(dB) + 42.6(dBμV) – 35.86 (dB)
= 43.54 (dBμV/m)
- Over Limit(dB)
= Level(dBμV/m) – Limit Line(dBμV/m)
= 43.54(dBμV/m) – 54(dBμV/m)
= -10.46(dB)

Both peak and average measured complies with the limit line, so test result is “PASS”.



Appendix D. Duty Cycle Plots

Band	Duty Cycle(%)	T(ms)	1/T(kHz)	VBW Setting
802.11a	95.63	1.428	0.701	0.75kHz
5GHz 802.11n HT20	94.84	1.333	0.750	0.82kHz
5GHz 802.11n HT40	87.74	0.664	1.507	1.6kHz
5GHz 802.11n VHT80	76.51	0.330	3.026	3.3kHz

802.11a

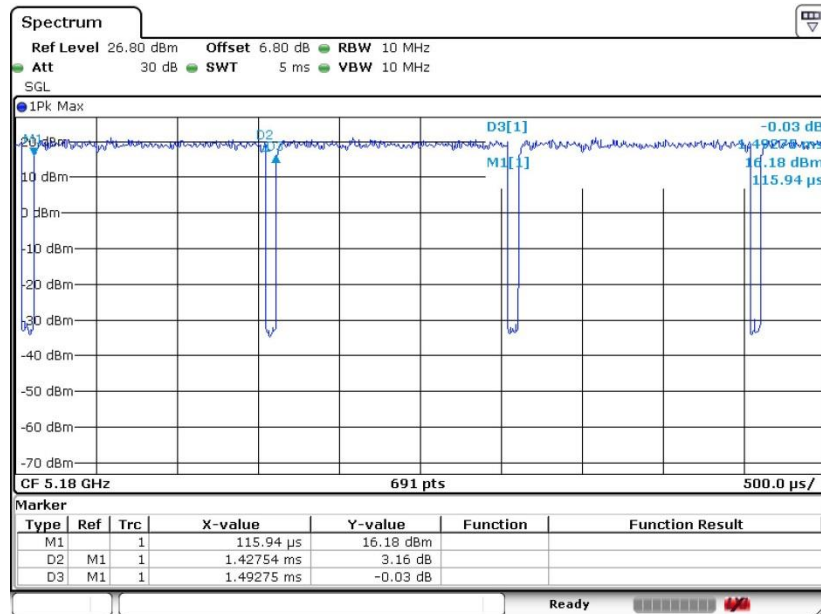



802.11n HT20

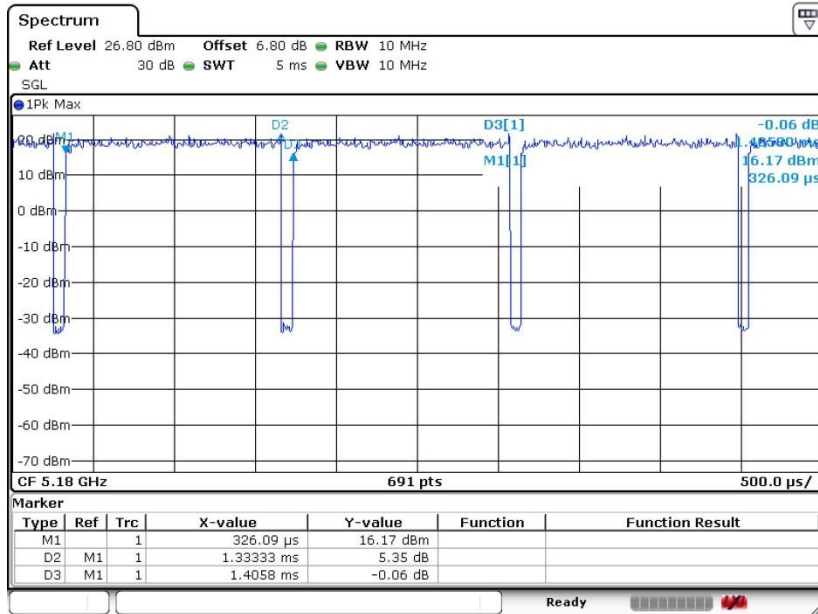

802.11n HT40

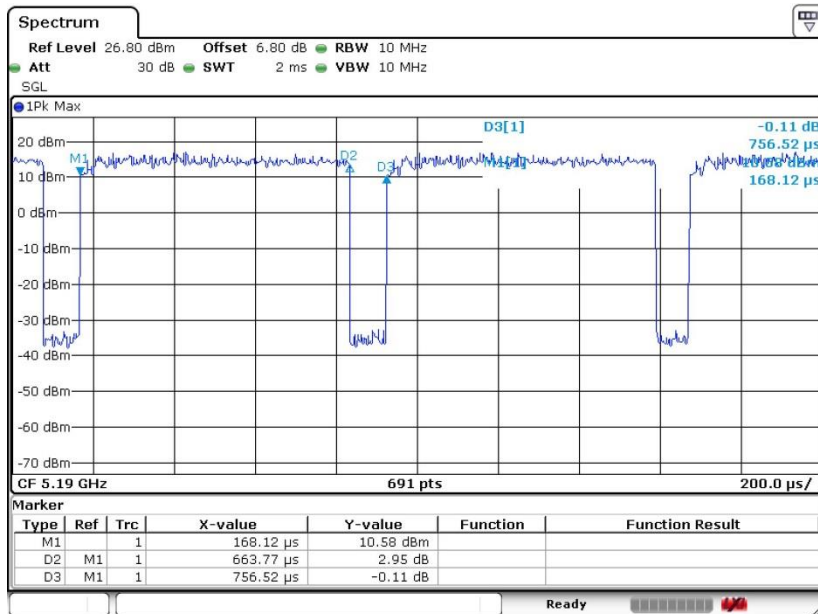



802.11ac VHT80

