



FCC RADIO TEST REPORT

FCC ID : IHDT56YC1
Equipment : Mobile Cellular Phone
Brand Name : Motorola
Model Name : XT2010-1
Applicant : Motorola Mobility LLC
222 W,Merchandise Mart Plaza, Chicago IL
60654 USA
Manufacturer : Motorola Mobility LLC
222 W,Merchandise Mart Plaza, Chicago IL
60654 USA
Standard : FCC Part 15 Subpart C §15.247

The product was received on Apr. 26, 2019 and testing was started from May 07, 2019 and completed on May 27, 2019. We, SPORTON INTERNATIONAL INC., EMC & Wireless Communications Laboratory, would like to declare that the tested sample has been evaluated in accordance with the test procedures and has been in compliance with the applicable technical standards.

The report must not be used by the client to claim product certification, approval, or endorsement by TAF or any agency of government.

The test results in this report apply exclusively to the tested model / sample. Without written approval of SPORTON INTERNATIONAL INC. EMC & Wireless Communications Laboratory, the test report shall not be reproduced except in full.

Approved by: Jones Tsai

SPORTON INTERNATIONAL INC. EMC & Wireless Communications Laboratory
No. 52, Huaya 1st Rd., Guishan Dist., Taoyuan City, Taiwan (R.O.C.)



Table of Contents

History of this test report.....	3
Summary of Test Result.....	4
1 General Description	5
1.1 Product Feature of Equipment Under Test.....	5
1.2 Product Specification of Equipment Under Test.....	7
1.3 Modification of EUT	7
1.4 Testing Location	7
1.5 Applicable Standards.....	8
2 Test Configuration of Equipment Under Test	9
2.1 Carrier Frequency and Channel	9
2.2 Test Mode.....	9
2.3 Connection Diagram of Test System.....	10
2.4 Support Unit used in test configuration and system	11
2.5 EUT Operation Test Setup	11
2.6 Measurement Results Explanation Example.....	11
3 Test Result	12
3.1 6dB and 99% Bandwidth Measurement	12
3.2 Output Power Measurement.....	14
3.3 Power Spectral Density Measurement	15
3.4 Conducted Band Edges and Spurious Emission Measurement	17
3.5 Radiated Band Edges and Spurious Emission Measurement	27
3.6 AC Conducted Emission Measurement.....	31
3.7 Antenna Requirements	33
4 List of Measuring Equipment.....	34
5 Uncertainty of Evaluation	36
Appendix A. Conducted Test Results	
Appendix B. AC Conducted Emission Test Result	
Appendix C. Radiated Spurious Emission	
Appendix D. Radiated Spurious Emission Plots	
Appendix E. Duty Cycle Plots	



Summary of Test Result

Report Clause	Ref Std. Clause	Test Items	Result (PASS/FAIL)	Remark
3.1	15.247(a)(2)	6dB Bandwidth	Pass	-
3.1	2.1049	99% Occupied Bandwidth	Reporting only	-
3.2	15.247(b)	Power Output Measurement	Pass	-
3.3	15.247(e)	Power Spectral Density	Pass	-
3.4	15.247(d)	Conducted Band Edges	Pass	-
		Conducted Spurious Emission	Pass	-
3.5	15.247(d)	Radiated Band Edges and Radiated Spurious Emission	Pass	Under limit 6.41 dB at 2390.000 MHz
3.6	15.207	AC Conducted Emission	Pass	Under limit 5.70 dB at 0.175 MHz
3.7	15.203 & 15.247(b)	Antenna Requirement	Pass	-

Declaration of Conformity:

The test results with all measurement uncertainty excluded are presented in accordance with the regulation limits or requirements declared by manufacturers.

Comments and Explanations:

The declared of product specification for EUT presented in the report are provided by the manufacturer, and the manufacturer takes all the responsibilities for the accuracy of product specification.

Reviewed by: Wii Chang

Report Producer: Dara Chiu



1 General Description

1.1 Product Feature of Equipment Under Test

Product Feature	
Equipment	Mobile Cellular Phone
Brand Name	Motorola
Model Name	XT2010-1
FCC ID	IHDT56YC1
Sample 1	Single SIM
Sample 2	Dual SIM
IMEI Code	Conducted : IMEI: 354156100004763 Conduction : IMEI: 354156100005315 Radiation : IMEI: 354156100005364
EUT supports Radios application	GSM/EGPRS/WCDMA/HSPA/LTE/GNSS/NFC/FM WLAN 11b/g/n HT20 WLAN 11a/n HT20/HT40 WLAN 11ac VHT20/VHT40/VHT80 Bluetooth BR/EDR/LE
HW Version	DVT2A
EUT Stage	Identical Prototype

Remark: The above EUT's information was declared by manufacturer.



Accessory List	
AC Adapter 1 (US)	Brand Name : Motorola
	Model Name : SC-51
	Manufacturer : Salom
AC Adapter 1 (EU)	Brand Name : Motorola
	Model Name : SC-52
	Manufacturer : Salom
AC Adapter 1 (UK)	Brand Name : Motorola
	Model Name : SC-53
	Manufacturer : Salom
AC Adapter 1 (AR)	Brand Name : Motorola
	Model Name : SC-56
	Manufacturer : Salom
AC Adapter 1 (BR)	Brand Name : Motorola
	Model Name : SC-57
	Manufacturer : Salom
AC Adapter 2 (US)	Brand Name : Motorola
	Model Name : SC-51
	Manufacturer : Chenyang
AC Adapter 2 (EU)	Brand Name : Motorola
	Model Name : SC-52
	Manufacturer : Chenyang
AC Adapter 2 (UK)	Brand Name : Motorola
	Model Name : SC-53
	Manufacturer : Chenyang
AC Adapter 2 (AR)	Brand Name : Motorola
	Model Name : SC-56
	Manufacturer : Chenyang
AC Adapter 3 (BR)	Brand Name : Motorola
	Model Name : SC-57
	Manufacturer : Flex
AC Adapter 4 (BR)	Brand Name : Motorola
	Model Name : SC-57
	Manufacturer : Cliptech
Battery 1	Brand Name : Motorola
	Model Name : KP50
	Manufacturer : SCUD
Earphone 1	Brand Name : Motorola
	Model Name : SH38C37773
	Manufacturer : Lianyun
Earphone 2	Brand Name : Motorola
	Model Name : SH38C44959
	Manufacturer : Cosonic
USB Cable 1	Brand Name : Luxshare
	Model Name : SC18C24368
USB Cable 2	Brand Name : Saibao
	Model Name : SC18C24367



1.2 Product Specification of Equipment Under Test

Standards-related Product Specification	
Tx/Rx Channel Frequency Range	2412 MHz ~ 2462 MHz
Maximum Output Power to antenna	802.11b : 18.90 dBm (0.0776 W) 802.11g : 16.80 dBm (0.0479 W) 802.11n HT20 : 16.90 dBm (0.0490 W)
99% Occupied Bandwidth	802.11b : 13.95MHz 802.11g : 16.85MHz 802.11n HT20 : 18.00MHz
Antenna Type / Gain	Loop Antenna type with gain -8.00 dBi
Type of Modulation	802.11b : DSSS (DBPSK / DQPSK / CCK) 802.11g/n : OFDM (BPSK / QPSK / 16QAM / 64QAM)

1.3 Modification of EUT

No modifications are made to the EUT during all test items.

1.4 Testing Location

Test Site	SPORTON INTERNATIONAL INC.	
Test Site Location	No.52, Huaya 1st Rd., Guishan Dist., Taoyuan City, Taiwan (R.O.C.) TEL: +886-3-327-3456 FAX: +886-3-328-4978	
Test Site No.	Sporton Site No.	
	TH05-HY	CO05-HY

Note: The test site complies with ANSI C63.4 2014 requirement.

Test Site	SPORTON INTERNATIONAL INC.	
Test Site Location	No.58, Aly. 75, Ln. 564, Wenhua 3rd, Rd., Guishan Dist., Taoyuan City, Taiwan (R.O.C.) TEL: +886-3-327-0868 FAX: +886-3-327-0855	
Test Site No.	Sporton Site No.	
	03CH11-HY	

Note: The test site complies with ANSI C63.4 2014 requirement.

FCC designation No.: TW1190 and TW0007



1.5 Applicable Standards

According to the specifications of the manufacturer, the EUT must comply with the requirements of the following standards:

- ♦ FCC Part 15 Subpart C §15.247
- ♦ FCC KDB Publication No. 558074 D01 DTS Meas. Guidance v05r02
- ♦ FCC KDB 414788 D01 Radiated Test Site v01r01.
- ♦ ANSI C63.10-2013

Remark:

1. All test items were verified and recorded according to the standards and without any deviation during the test.
2. This EUT has also been tested and complied with the requirements of FCC Part 15, Subpart B, recorded in a separate test report.



2 Test Configuration of Equipment Under Test

- a. The EUT has been associated with peripherals and configuration operated in a manner tended to maximize its emission characteristics in a typical application. Frequency range investigated: conduction emission (150 kHz to 30 MHz), radiation emission (9 kHz to the 10th harmonic of the highest fundamental frequency or to 40 GHz, whichever is lower). For radiated measurement, pre-scanned in three orthogonal panels, X, Y, Z. The worst cases (Z plane) were recorded in this report.
- b. AC power line Conducted Emission was tested under maximum output power.

2.1 Carrier Frequency and Channel

Frequency Band	Channel	Freq. (MHz)	Channel	Freq. (MHz)
2400-2483.5 MHz	1	2412	7	2442
	2	2417	8	2447
	3	2422	9	2452
	4	2427	10	2457
	5	2432	11	2462
	6	2437		

2.2 Test Mode

Final test modes are considering the modulation and worse data rates as below table.

Modulation	Data Rate
802.11b	1 Mbps
802.11g	6 Mbps
802.11n HT20	MCS0

Test Cases	
AC Conducted Emission	Mode 1: LTE Band 12 Low Channel Idle + Bluetooth Link + WLAN (2.4GHz) Link + Camera (Back) + Battery + USB Cable 2 + Earphone 2 + AC Adapter 4 (Cliptech_BR) for Sample 1
Remark: For Radiated Test Cases, the tests were performed with AC Adapter 1 (Salom_US), Earphone 1, USB Cable 1, and Sample 1	

2.3 Connection Diagram of Test System

<WLAN Tx Mode>

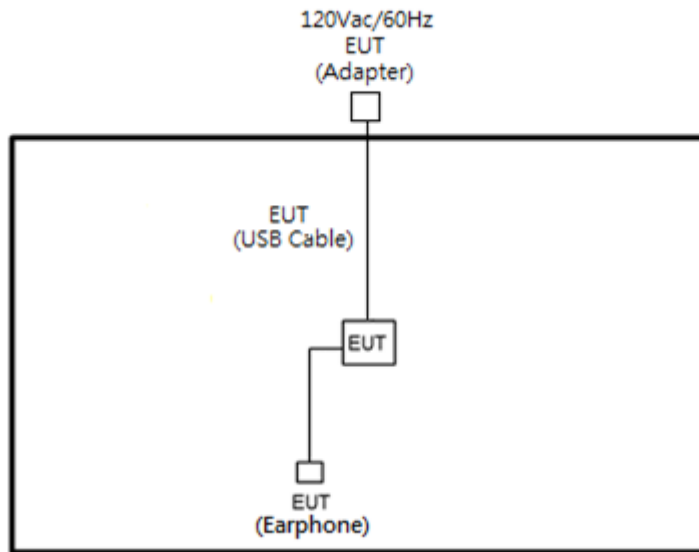

<AC Conducted Emission Mode>

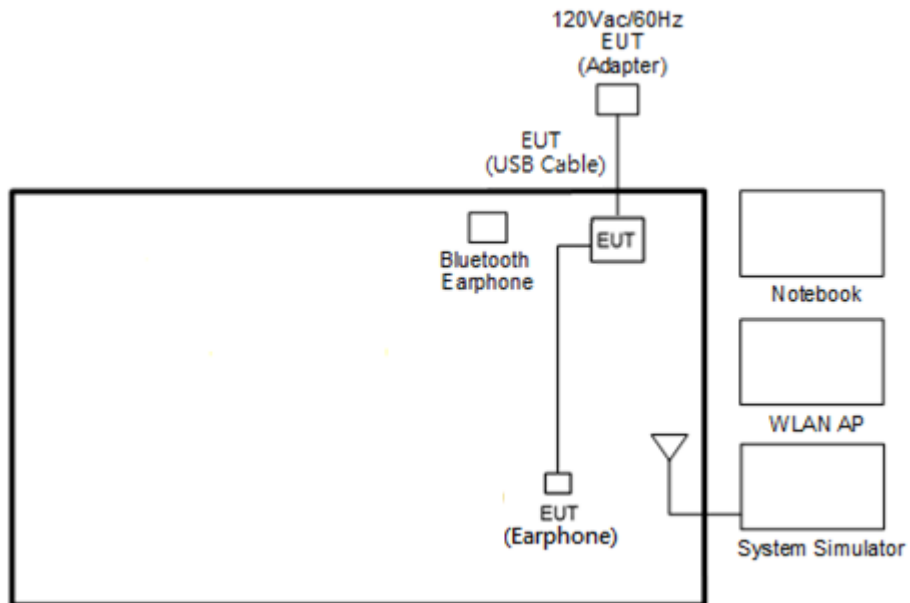

2.4 Support Unit used in test configuration and system

Item	Equipment	Trade Name	Model Name	FCC ID	Data Cable	Power Cord
1.	System Simulator	Anritsu	MT8820C	N/A	N/A	Unshielded, 1.8 m
2.	Bluetooth Earphone	Sony Ericsson	MW600	PY7DDA-2029	N/A	N/A
3.	WLAN AP	ASUS	RT-AC66U	MSQ-RTAC66U	N/A	Unshielded, 1.8 m
4.	Notebook	DELL	Latitude E6320	FCC DoC/ Contains FCC ID: QDS-BRCM1054	N/A	AC I/P: Unshielded, 1.2 m DC O/P: Shielded, 1.8 m
5.	SD Card	SanDisk	MicroSD HC	FCC DoC	N/A	N/A

2.5 EUT Operation Test Setup

The RF test items, utility “QDART_WIN_4_8_Installer_00064_1 qpst.win.2.7_installer_00471.4” was installed in Notebook which was programmed in order to make the EUT get into the engineering modes to provide channel selection, power level, data rate and the application type and for continuous transmitting signals.

2.6 Measurement Results Explanation Example

For all conducted test items:

The offset level is set in the spectrum analyzer to compensate the RF cable loss and attenuator factor between EUT conducted output port and spectrum analyzer. With the offset compensation, the spectrum analyzer reading level is exactly the EUT RF output level.

Example:

The spectrum analyzer offset is derived from RF cable loss and attenuator factor.

Offset = RF cable loss + attenuator factor.

Following shows an offset computation example with cable loss 4.2 dB and 10dB attenuator.

$$\begin{aligned} \text{Offset(dB)} &= \text{RF cable loss(dB)} + \text{attenuator factor(dB)}. \\ &= 4.2 + 10 = 14.2 \text{ (dB)} \end{aligned}$$

3 Test Result

3.1 6dB and 99% Bandwidth Measurement

3.1.1 Limit of 6dB and 99% Bandwidth

The minimum 6 dB bandwidth shall be at least 500 kHz.

3.1.2 Measuring Instruments

See list of measuring equipment of this test report.

3.1.3 Test Procedures

1. The testing follows the ANSI C63.10 Section 6.9.3 (OBW) and 11.8.1 (6dB BW).
2. The RF output of EUT was connected to the spectrum analyzer by RF cable and attenuator. The path loss was compensated to the results for each measurement.
3. Set to the maximum power setting and enable the EUT transmit continuously.
4. Make the measurement with the spectrum analyzer's resolution bandwidth (RBW) = 100 kHz. Set the Video bandwidth (VBW) = 300 kHz. In order to make an accurate measurement. The 6 dB bandwidth must be greater than 500 kHz.
5. For 99% Bandwidth Measurement, the spectrum analyzer's resolution bandwidth (RBW) is set 1-5% of the emission bandwidth and set the Video bandwidth (VBW) $\geq 3 * RBW$.
6. Measure and record the results in the test report.

3.1.4 Test Setup

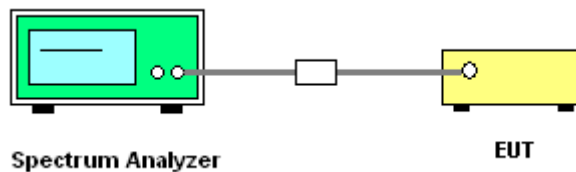



3.1.5 Test Result of 6dB and 99% Occupied Bandwidth

Please refer to Appendix A.

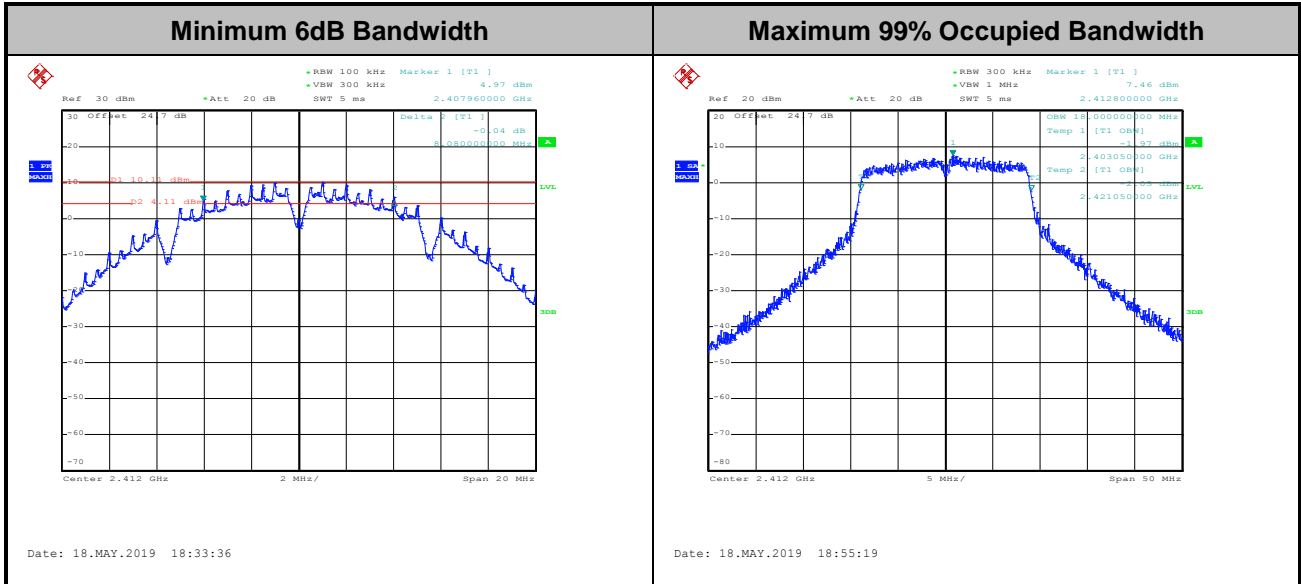

Note: The occupied channel bandwidth is maintained within the band of operation for all of the modulations.

3.2 Output Power Measurement

3.2.1 Limit of Output Power

For systems using digital modulation in the 2400-2483.5MHz, the limit for peak output power is 30dBm. If transmitting antenna with directional gain greater than 6dBi is used, the peak output power from the intentional radiator shall be reduced below the above stated value by the amount in dB that the directional gain of the antenna exceeds 6 dBi. In case of point-to-point operation, the limit has to be reduced by 1dB for every 3dB that the directional gain of the antenna exceeds 6dBi.

3.2.2 Measuring Instruments

See list of measuring equipment of this test report.

3.2.3 Test Procedures

1. For Average Power, the testing follows ANSI C63.10 Section 11.9.2.3.2 Method AVGPM-G
2. The RF output of EUT was connected to the power meter by RF cable and attenuator. The path loss was compensated to the results for each measurement.
3. Set to the maximum power setting and enable the EUT transmit continuously.
4. Measure the conducted output power and record the results in the test report.

3.2.4 Test Setup

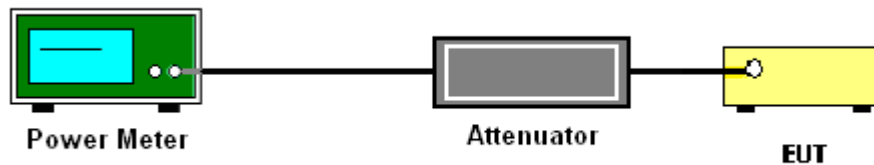

3.2.5 Test Result of Average Output Power

Please refer to Appendix A.

3.3 Power Spectral Density Measurement

3.3.1 Limit of Power Spectral Density

The peak power spectral density shall not be greater than 8dBm in any 3kHz band at any time interval of continuous transmission.

3.3.2 Measuring Instruments

See list of measuring equipment of this test report.

3.3.3 Test Procedures

1. The testing follows the ANSI C63.10 Section 11.10.2 Method PKPSD.
2. The RF output of EUT was connected to the spectrum analyzer by RF cable and attenuator. The path loss was compensated to the results for each measurement.
3. Set to the maximum power setting and enable the EUT transmit continuously.
4. Make the measurement with the spectrum analyzer's resolution bandwidth (RBW) = 3 kHz. Video bandwidth VBW = 10 kHz In order to make an accurate measurement, set the span to 1.5 times DTS Channel Bandwidth. (6dB BW)
5. Detector = peak, Sweep time = auto couple, Trace mode = max hold, Allow trace to fully stabilize. Use the peak marker function to determine the maximum power level.
6. Measure and record the results in the test report.

3.3.4 Test Setup

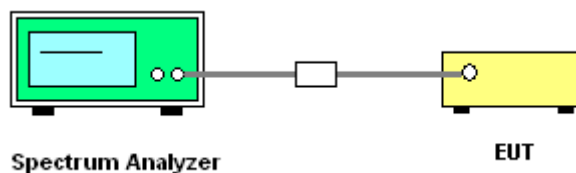



3.3.5 Test Result of Power Spectral Density

Please refer to Appendix A.

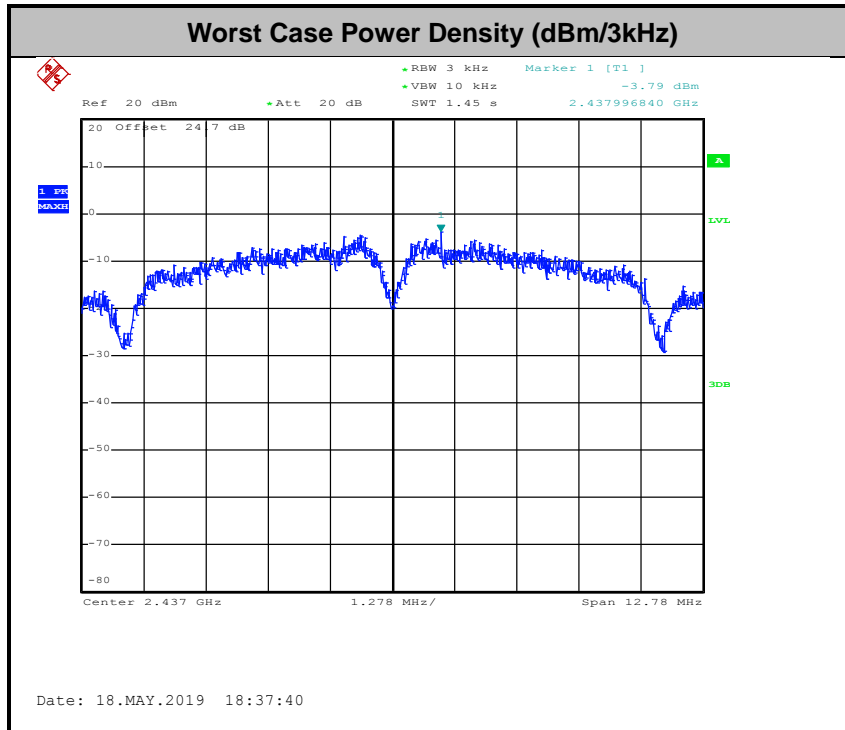

3.4 Conducted Band Edges and Spurious Emission Measurement

3.4.1 Limit of Conducted Band Edges and Spurious Emission Measurement

In any 100 kHz bandwidth outside of the authorized frequency band, the emissions which fall in the non-restricted bands shall be attenuated at least 20 dB / 30dB relative to the maximum PSD level in 100 kHz by RF conducted measurement.

3.4.2 Measuring Instruments

See list of measuring equipment of this test report.

3.4.3 Test Procedures

1. The testing follows the ANSI C63.10 Section 11.11.3 Emission level measurement.
2. The RF output of EUT was connected to the spectrum analyzer by RF cable and attenuator. The path loss was compensated to the results for each measurement.
3. Set to the maximum power setting and enable the EUT transmit continuously.
4. Set RBW = 100 kHz, VBW=300 kHz, Peak Detector. Unwanted Emissions measured in any 100 kHz bandwidth outside of the authorized frequency band shall be attenuated by at least 20 dB relative to the maximum in-band peak PSD level in 100 kHz when maximum peak conducted output power procedure is used. If the transmitter complies with the conducted power limits based on the use of RMS averaging over a time interval, the attenuation required under this paragraph shall be 30 dB instead of 20 dB per 15.247(d).
5. Measure and record the results in the test report.
6. The RF fundamental frequency should be excluded against the limit line in the operating frequency band.

3.4.4 Test Setup

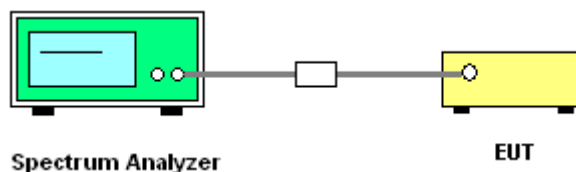



3.4.5 Test Result of Conducted Band Edges and Spurious Emission

Test Engineer : Rebecca Li	Temperature :	21~25°C
	Relative Humidity :	51~54%

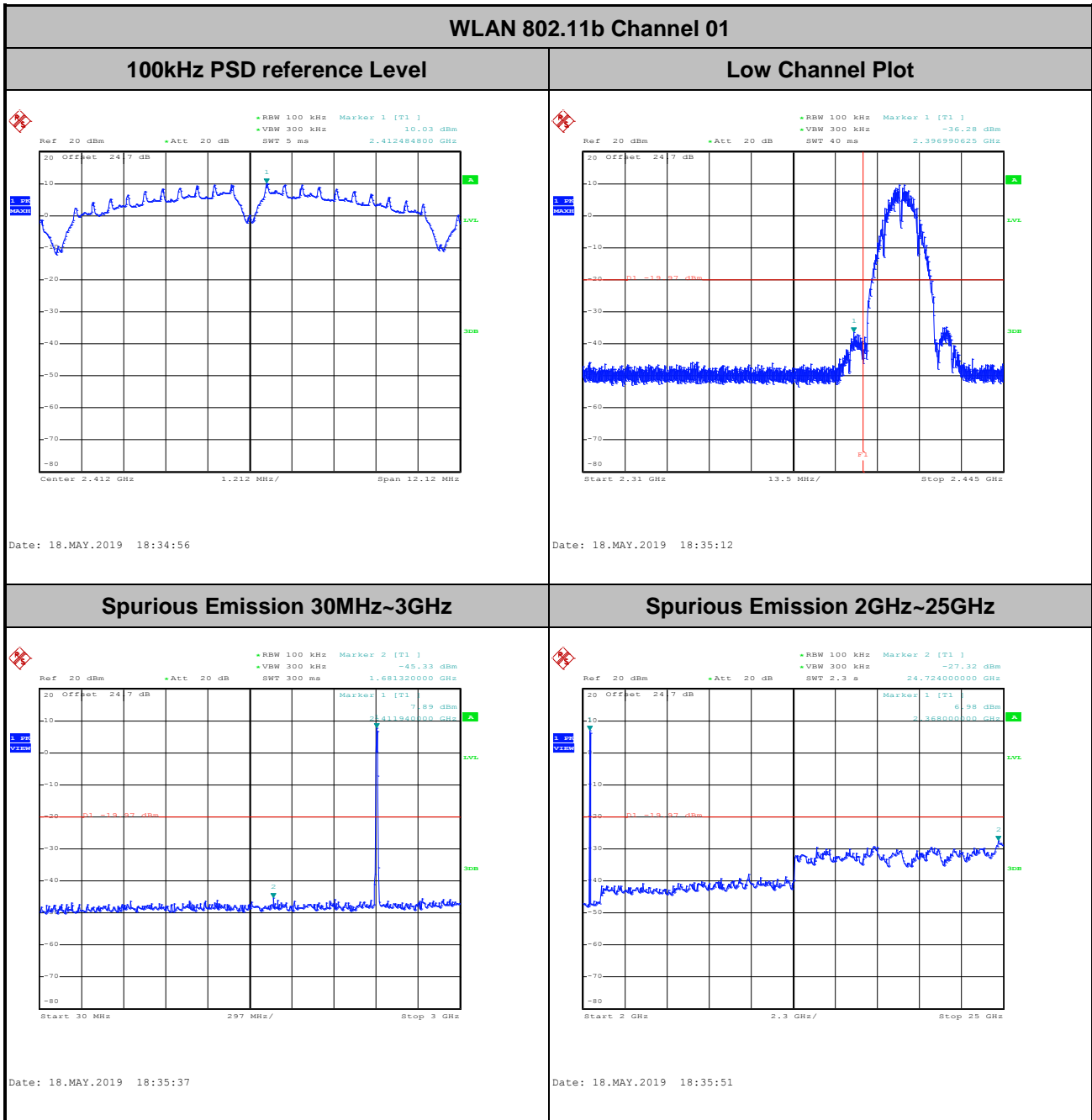



WLAN 802.11b Channel 11

100kHz PSD reference Level

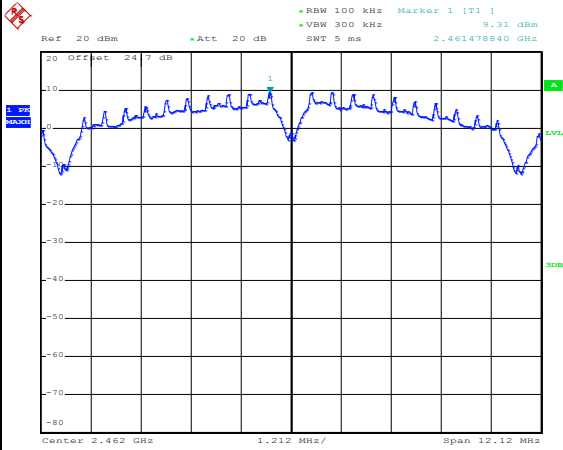

Date: 18.MAY.2019 18:40:46

High Channel Plot

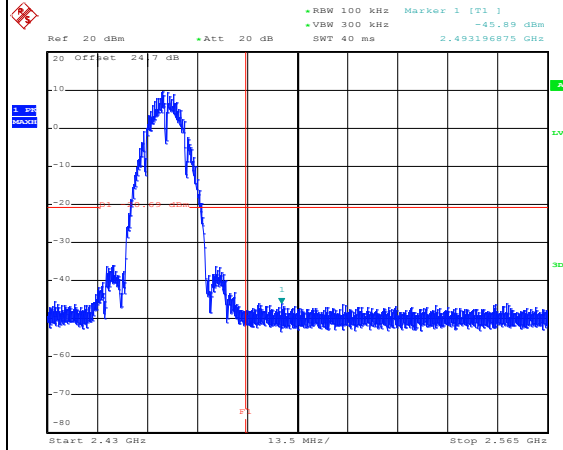

Date: 18.MAY.2019 18:41:20

Spurious Emission 30MHz~3GHz

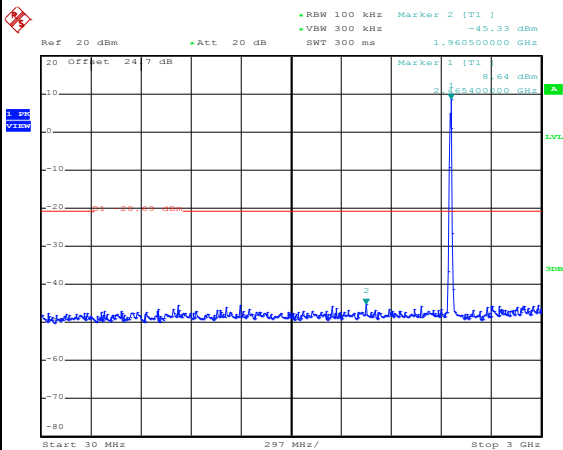

Date: 18.MAY.2019 18:41:37

Spurious Emission 2GHz~25GHz

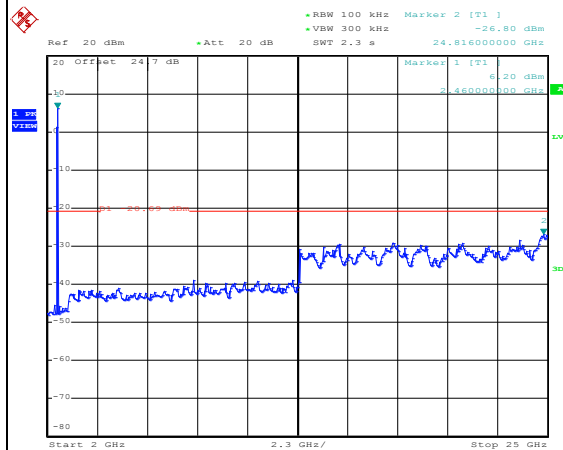

Date: 18.MAY.2019 18:41:51



WLAN 802.11g Channel 01

100kHz PSD reference Level

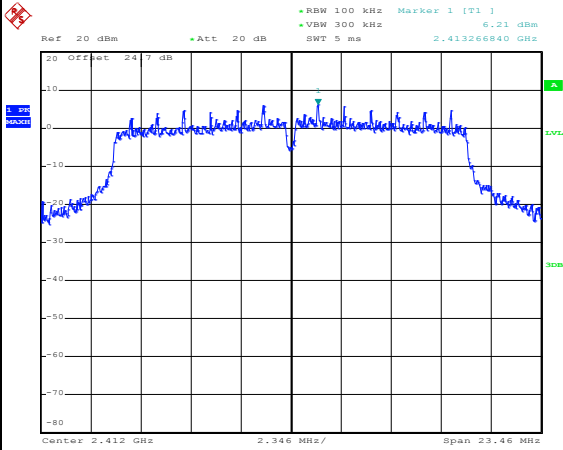

Date: 18.MAY.2019 18:45:23

Low Channel Plot

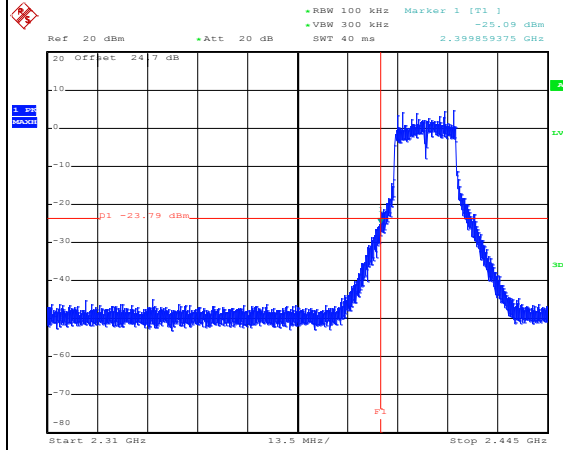

Date: 18.MAY.2019 18:45:39

Spurious Emission 30MHz~3GHz

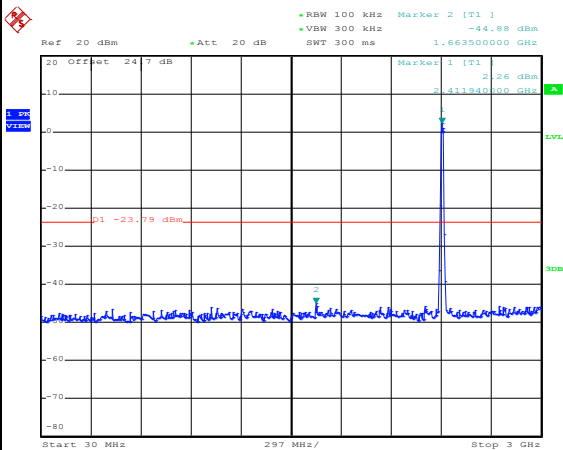

Date: 18.MAY.2019 18:46:03

Spurious Emission 2GHz~25GHz

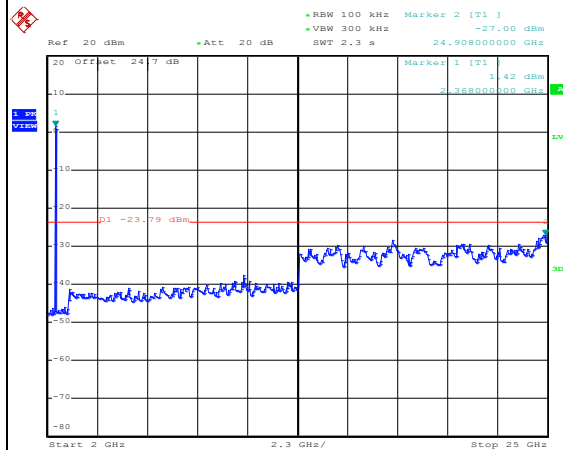

Date: 18.MAY.2019 18:46:16



WLAN 802.11g Channel 06

100kHz PSD reference Level

Mid Channel Plot

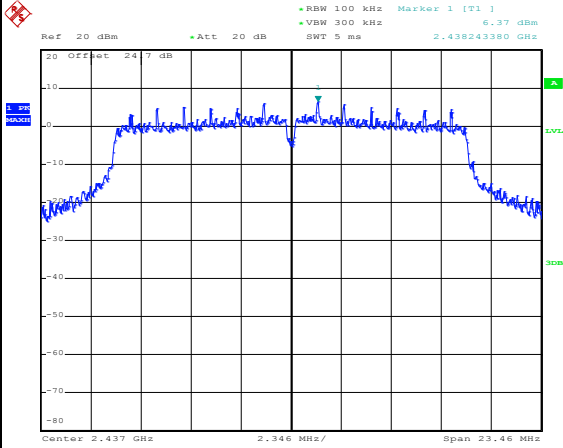

Date: 18.MAY.2019 18:48:22

Spurious Emission 30MHz~3GHz

Spurious Emission 2GHz~25GHz

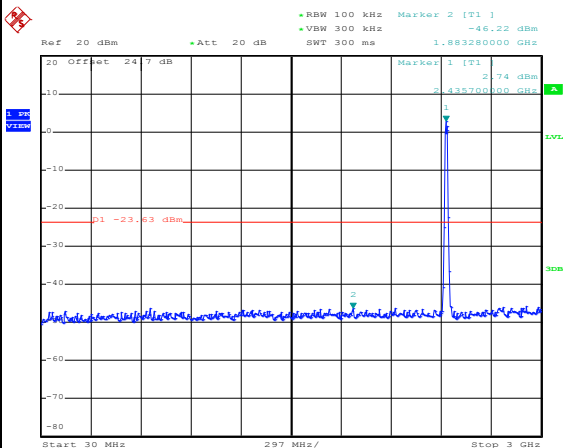

Date: 18.MAY.2019 18:49:08

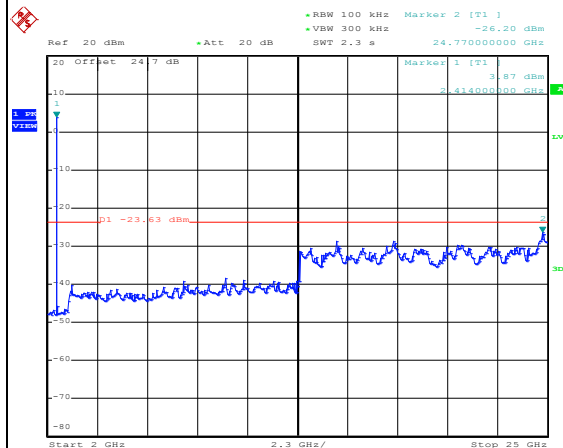

Date: 18.MAY.2019 18:49:21



WLAN 802.11g Channel 11

100kHz PSD reference Level

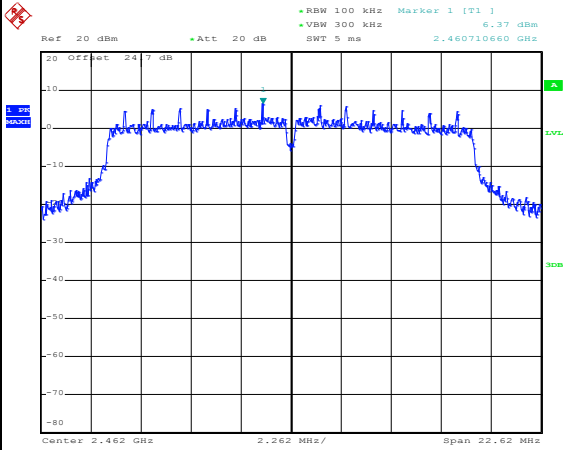

Date: 18.MAY.2019 18:51:03

High Channel Plot

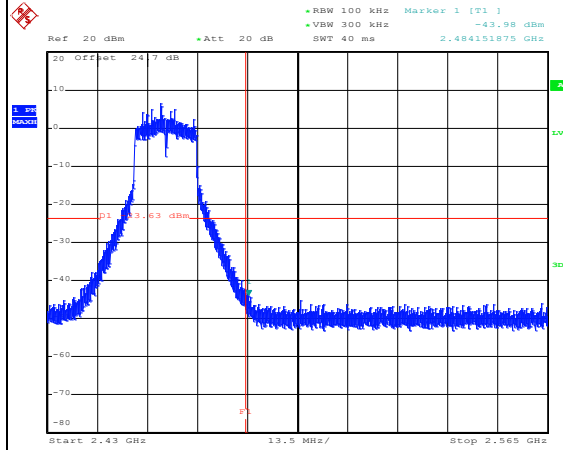

Date: 18.MAY.2019 18:51:17

Spurious Emission 30MHz~3GHz

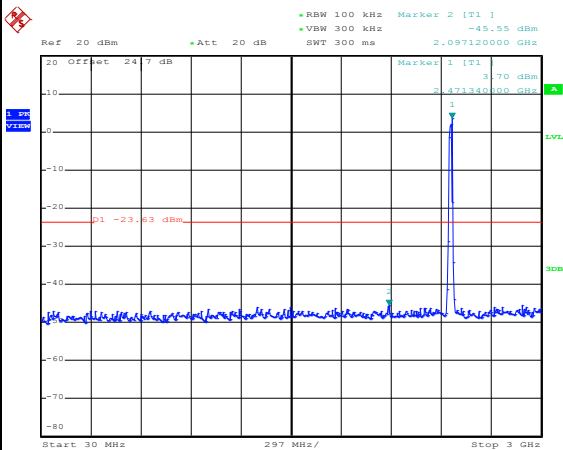

Date: 18.MAY.2019 18:52:00

Spurious Emission 2GHz~25GHz

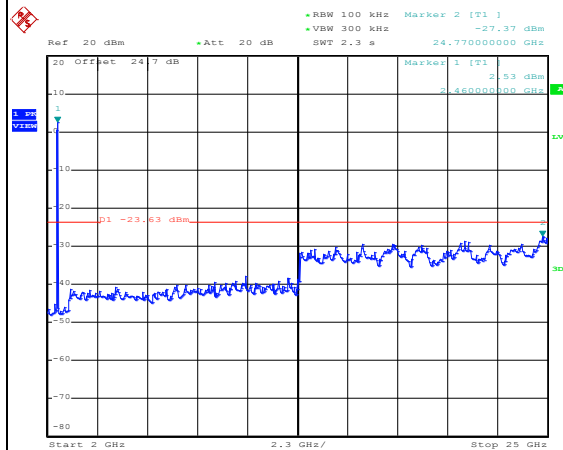

Date: 18.MAY.2019 18:52:14



WLAN 802.11n HT20 Channel 01

100kHz PSD reference Level

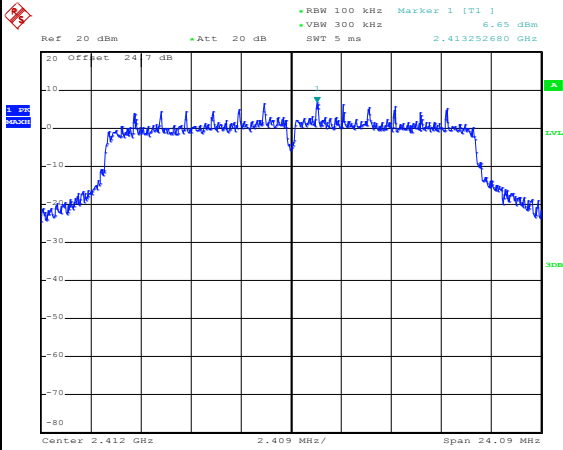

Date: 18.MAY.2019 18:54:14

Low Channel Plot

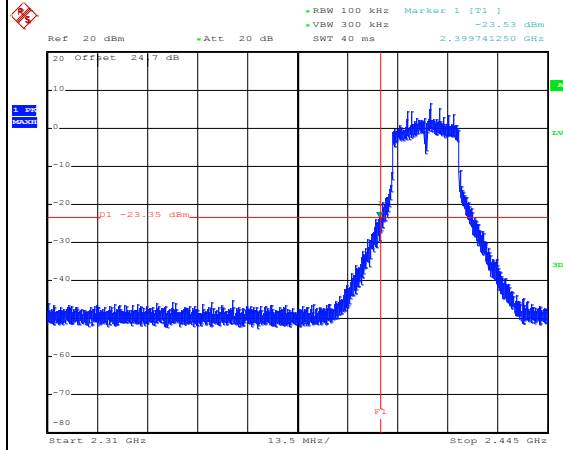

Date: 18.MAY.2019 18:54:28

Spurious Emission 30MHz~3GHz

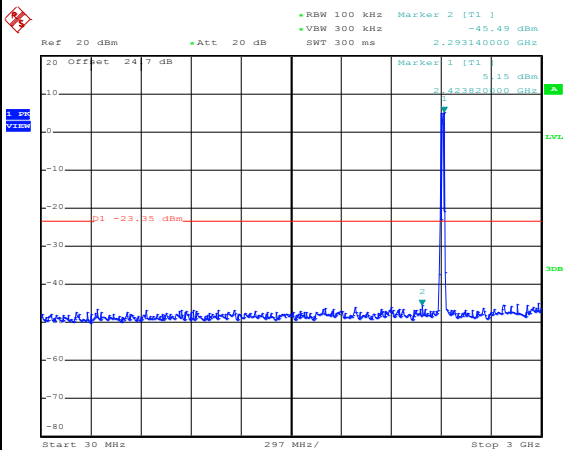

Date: 18.MAY.2019 18:54:52

Spurious Emission 2GHz~25GHz

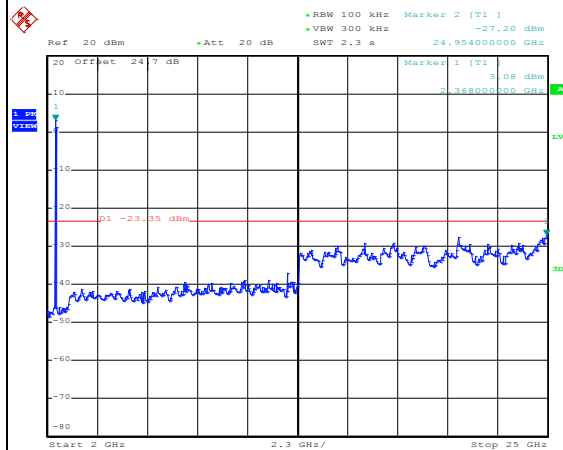

Date: 18.MAY.2019 18:55:06

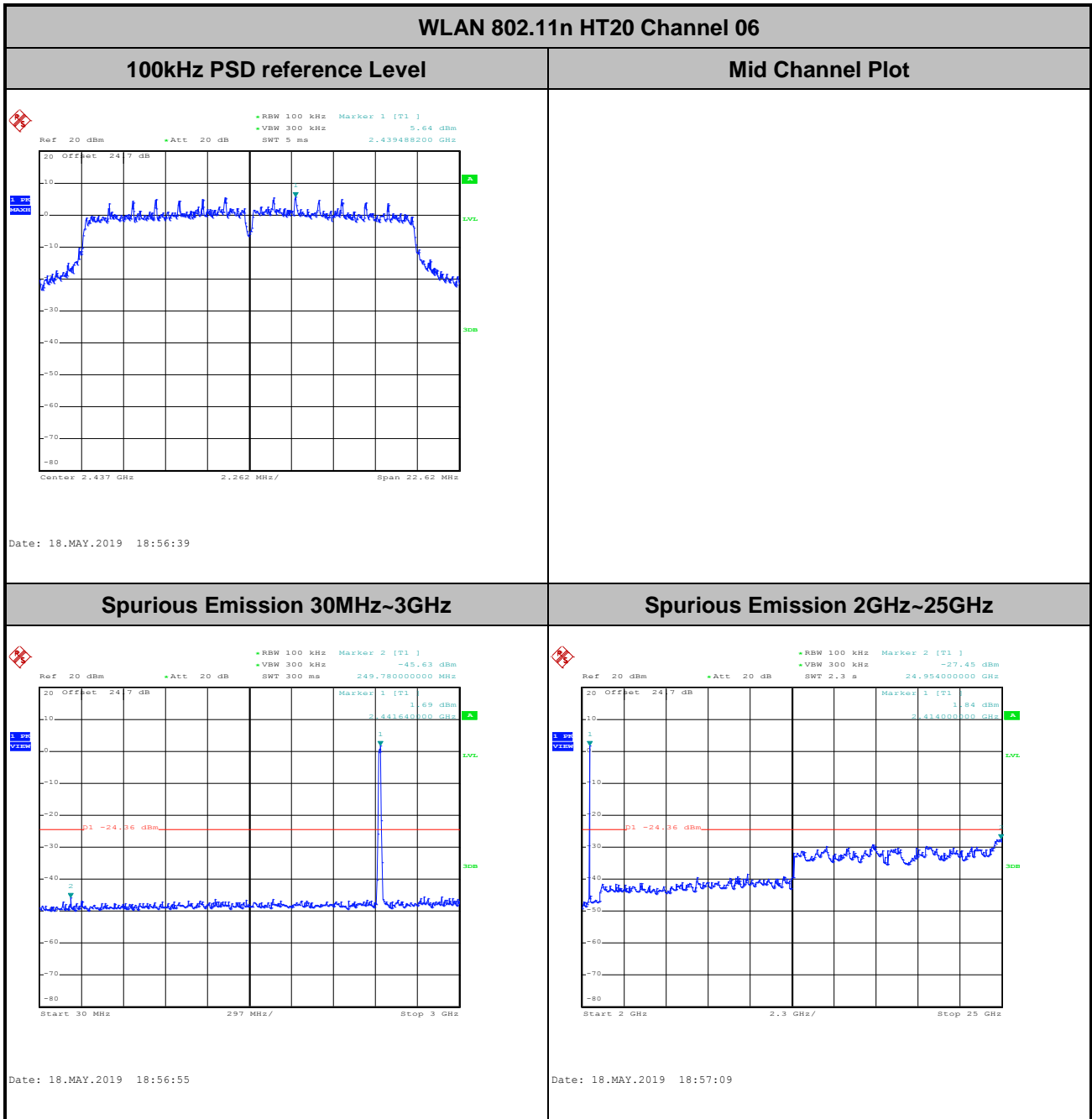



WLAN 802.11n HT20 Channel 11

100kHz PSD reference Level

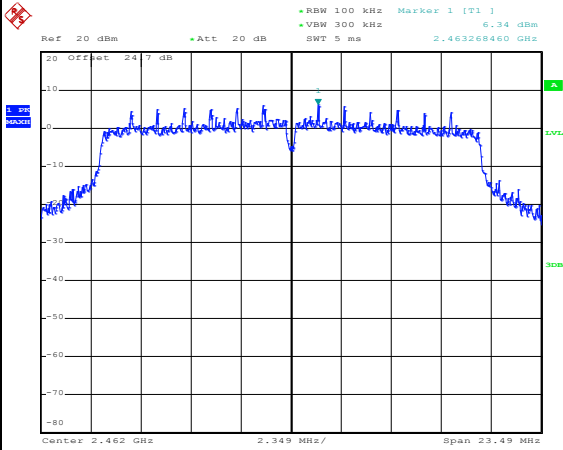

Date: 18.MAY.2019 18:58:55

High Channel Plot

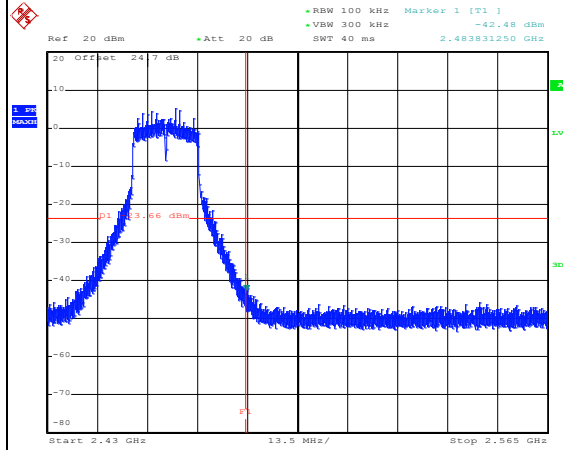

Date: 18.MAY.2019 18:59:11

Spurious Emission 30MHz~3GHz

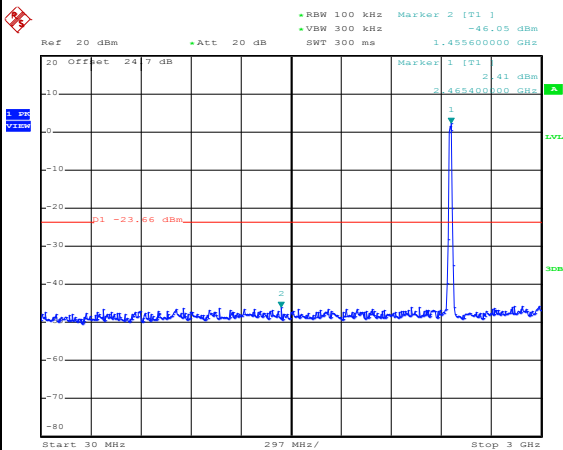

Date: 18.MAY.2019 18:59:28

Spurious Emission 2GHz~25GHz

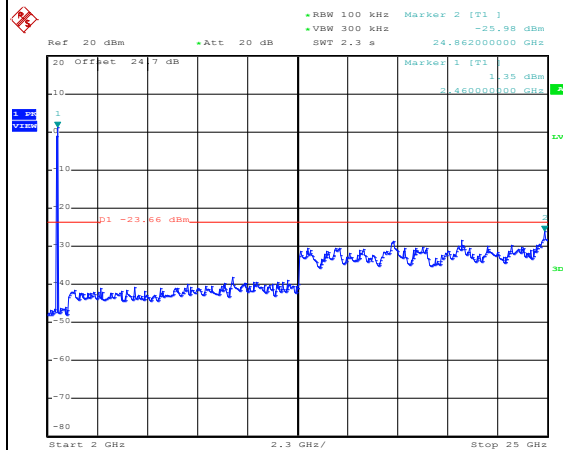

Date: 18.MAY.2019 18:59:42



3.5 Radiated Band Edges and Spurious Emission Measurement

3.5.1 Limit of Radiated band edge and Spurious Emission Measurement

In any 100 kHz bandwidth outside the intentional radiator frequency band, all harmonics/spurious must be at least 20 dB below the highest emission level within the authorized band. If the output power of this device was measured by spectrum analyzer, the attenuation under this paragraph shall be 30 dB instead of 20 dB. In addition, radiated emissions which fall in the restricted bands must also comply with the limits as below.

Frequency (MHz)	Field Strength (microvolts/meter)	Measurement Distance (meters)
0.009 – 0.490	2400/F(kHz)	300
0.490 – 1.705	24000/F(kHz)	30
1.705 – 30.0	30	30
30 – 88	100	3
88 – 216	150	3
216 - 960	200	3
Above 960	500	3

3.5.2 Measuring Instruments

See list of measuring equipment of this test report.



3.5.3 Test Procedures

1. The testing follows the ANSI C63.10 Section 11.12.1 Radiated emission measurements.
2. The EUT was arranged to its worst case and then tune the antenna tower (from 1 m to 4 m) and turntable (from 0 degree to 360 degrees) to find the maximum reading. A pre-amp and a high pass filter are used for the test in order to get better signal level.
3. The EUT was placed on a turntable with 0.8 meter for frequency below 1GHz and 1.5 meter for frequency above 1GHz respectively above ground.
4. The EUT was set 3 meters from the interference receiving antenna, which was mounted on the top of a variable height antenna tower.
5. Corrected Reading: Antenna Factor + Cable Loss + Read Level - Preamp Factor = Level
6. For testing below 1GHz, if the emission level of the EUT in peak mode was 3 dB lower than the limit specified, then peak values of EUT will be reported, otherwise, the emissions will be repeated one by one using the CISPR quasi-peak method and reported.
7. For testing above 1GHz, the emission level of the EUT in peak mode was 20dB lower than average limit (that means the emission level in average mode also complies with the limit in average mode), then peak values of EUT will be reported, otherwise, the emissions will be measured in average mode again and reported.
8. Use the following spectrum analyzer settings:
 - (1) Span shall wide enough to fully capture the emission being measured;
 - (2) Set RBW=100 kHz for $f < 1$ GHz; $VBW \geq RBW$; Sweep = auto; Detector function = peak; Trace = max hold;
 - (3) Set RBW = 1 MHz, VBW= 3MHz for $f \geq 1$ GHz for peak measurement.
For average measurement:
 - $VBW = 10$ Hz, when duty cycle is no less than 98 percent.
 - $VBW \geq 1/T$, when duty cycle is less than 98 percent where T is the minimum transmission duration over which the transmitter is on and is transmitting at its maximum power control level for the tested mode of operation.

3.5.4 Test Setup

For radiated emissions below 30MHz

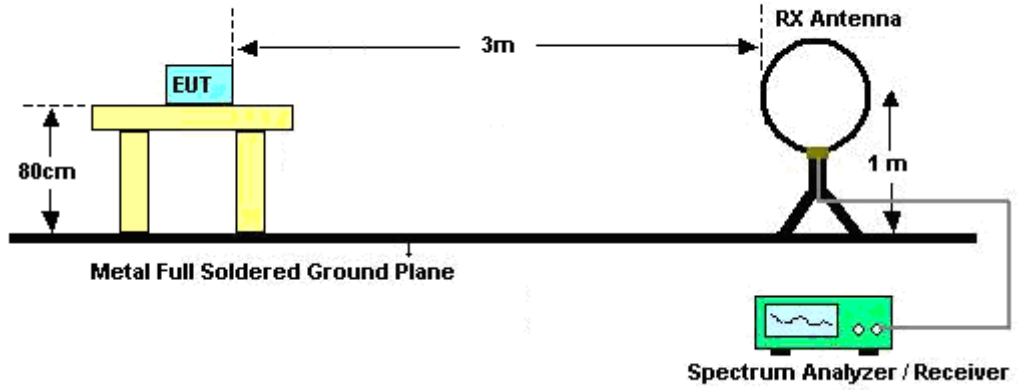

For radiated emissions from 30MHz to 1GHz

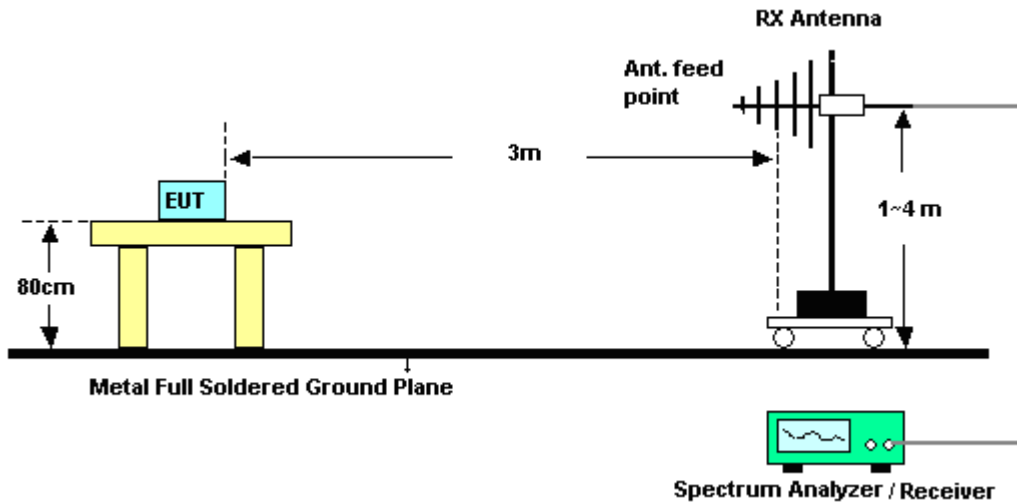

For radiated emissions above 1GHz

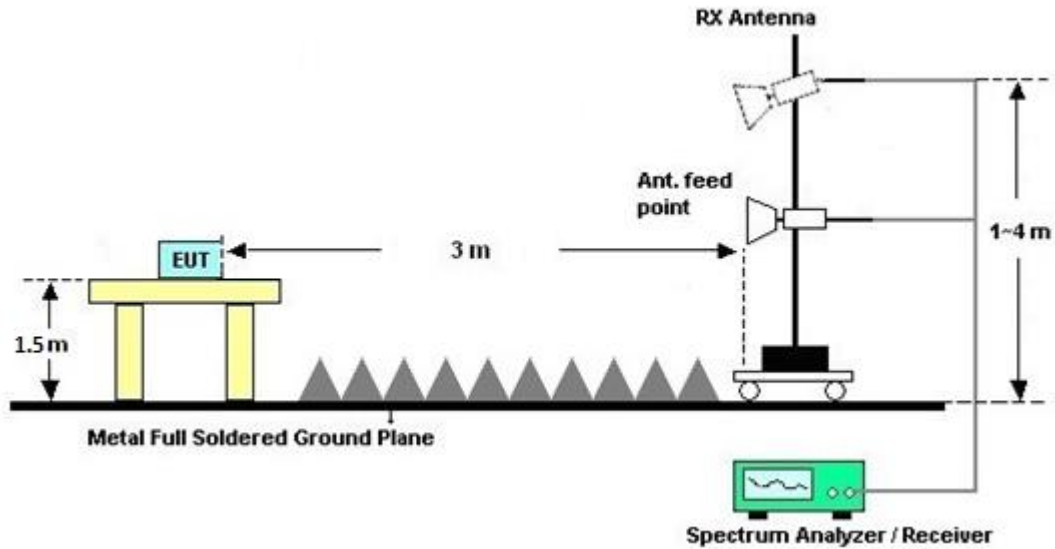

3.5.5 Test Results of Radiated Spurious Emissions (9kHz ~ 30MHz)

The low frequency, which started from 9 kHz to 30MHz, was pre-scanned and the result which was 20dB lower than the limit line was not reported.

There is a comparison data of both open-field test site and alternative test site - semi-Anechoic chamber according to 414788 D01 Radiated Test Site v01r01, and the result came out very similar.

3.5.6 Test Result of Radiated Spurious at Band Edges

Please refer to Appendix C and D.

3.5.7 Duty Cycle

Please refer to Appendix E.

3.5.8 Test Result of Radiated Spurious Emission (30MHz ~ 10th Harmonic)

Please refer to Appendix C and D.



3.6 AC Conducted Emission Measurement

3.6.1 Limit of AC Conducted Emission

For equipment that is designed to be connected to the public utility (AC) power line, the radio frequency voltage that is conducted back onto the AC power line on any frequency or frequencies within the band 150 kHz to 30 MHz shall not exceed the limits in the following table.

Frequency of Emission (MHz)	Conducted Limit (dBµV)	
	Quasi-Peak	Average
0.15-0.5	66 to 56*	56 to 46*
0.5-5	56	46
5-30	60	50

*Decreases with the logarithm of the frequency.

3.6.2 Measuring Instruments

See list of measuring equipment of this test report.

3.6.3 Test Procedures

1. The EUT was placed 0.4 meter from the conducting wall of the shielding room, and it was kept at least 80 centimeters from any other grounded conducting surface.
2. Connect EUT to the power mains through a line impedance stabilization network (LISN).
3. All the support units are connecting to the other LISN.
4. The LISN provides 50 ohm coupling impedance for the measuring instrument.
5. The FCC states that a 50 ohm, 50 microhenry LISN should be used.
6. Both sides of AC line were checked for maximum conducted interference.
7. The frequency range from 150 kHz to 30 MHz was searched.
8. Set the test-receiver system to Peak Detect Function and specified bandwidth (IF bandwidth = 9kHz) with Maximum Hold Mode.

3.6.4 Test Setup

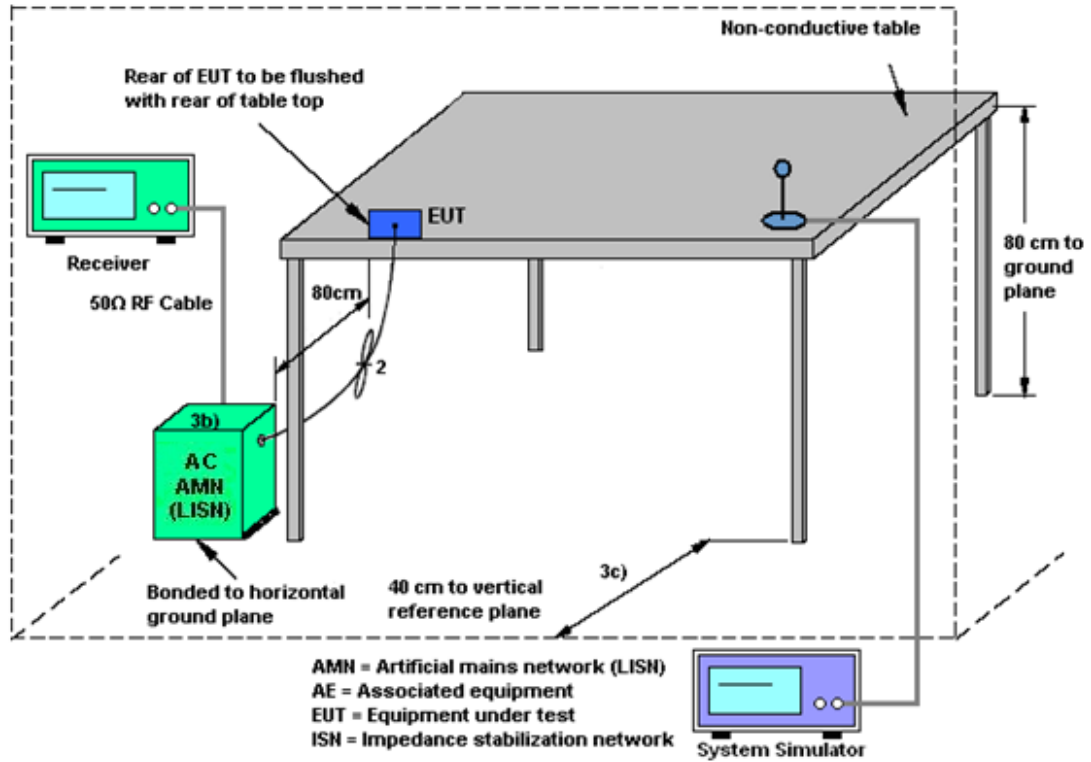

3.6.5 Test Result of AC Conducted Emission

Please refer to Appendix B.



3.7 Antenna Requirements

3.7.1 Standard Applicable

If directional gain of transmitting Antennas is greater than 6dBi, the power shall be reduced by the same level in dB comparing to gain minus 6dBi. The use of a permanently attached Antenna or of an Antenna that uses a unique coupling to the intentional radiator shall be considered sufficient to comply with the rule.

3.7.2 Antenna Anti-Replacement Construction

An embedded-in antenna design is used.

3.7.3 Antenna Gain

The antenna peak gain of EUT is less than 6 dBi. Therefore, it is not necessary to reduce maximum peak output power limit.



4 List of Measuring Equipment

Instrument	Manufacturer	Model No.	Serial No.	Characteristics	Calibration Date	Test Date	Due Date	Remark
Hygrometer	Testo	DTM-303A	TP157075	N/A	Nov. 05, 2018	May 07, 2019~ May 20, 2019	Nov. 04, 2019	Conducted (TH05-HY)
Power Sensor	DARE	RPR3006W	13100030S NO32	9kHz~6GHz	Dec. 03, 2018	May 07, 2019~ May 20, 2019	Dec. 02, 2019	Conducted (TH05-HY)
Spectrum Analyzer	Rohde & Schwarz	FSP40	100057	9kHz-40GHz	Nov. 21, 2018	May 07, 2019~ May 20, 2019	Nov. 20, 2019	Conducted (TH05-HY)
Switch Box & RF Cable	Burgeon	ETF-058	EC120838 2	N/A	Mar. 27, 2019	May 07, 2019~ May 20, 2019	Mar. 26, 2020	Conducted (TH05-HY)
AC Power Source	ChainTek	APC-1000W	N/A	N/A	N/A	May 27, 2019	N/A	Conduction (CO05-HY)
EMI Test Receiver	Rohde & Schwarz	ESR3	102388	9KHz~3.6GHz	Nov. 12, 2018	May 27, 2019	Nov. 11, 2019	Conduction (CO05-HY)
Hygrometer	Testo	608-H1	34913912	N/A	Mar. 19, 2019	May 27, 2019	Mar. 18, 2020	Conduction (CO05-HY)
LISN	Rohde & Schwarz	ENV216	100080	9kHz~30MHz	Nov. 14, 2018	May 27, 2019	Nov. 13, 2019	Conduction (CO05-HY)
LISN	Rohde & Schwarz	ENV216	100081	9kHz~30MHz	Nov. 09, 2018	May 27, 2019	Nov. 08, 2019	Conduction (CO05-HY)
Software	Rohde & Schwarz	EMC32 V10.30	N/A	N/A	N/A	May 27, 2019	N/A	Conduction (CO05-HY)
LF Cable	HUBER + SUHNER	RG-214/U	LF01	N/A	Dec. 31, 2018	May 27, 2019	Dec. 30, 2019	Conduction (CO05-HY)
Pulse Limiter	Rohde & Schwarz	ESH3-Z2	100851	N/A	Dec. 31, 2018	May 27, 2019	Dec. 30, 2019	Conduction (CO05-HY)
Amplifier	MITEQ	TTA1840-35- HG	1871923	18GHz~40GHz, VSWR : 2.5:1 max	Jul. 16, 2018	May 09, 2019~ May 10, 2019	Jul. 15, 2019	Radiation (03CH11-HY)
Amplifier	SONOMA	310N	187312	9kHz~1GHz	Dec. 04, 2018	May 09, 2019~ May 10, 2019	Dec. 03, 2019	Radiation (03CH11-HY)
Bilog Antenna	TESEQ	CBL 6111D&N-6-0 6	35414&AT- N0602	30MHz~1GHz	Oct. 13, 2018	May 09, 2019~ May 10, 2019	Oct. 12, 2019	Radiation (03CH11-HY)
Horn Antenna	SCHWARZBE CK	BBHA 9120 D	9120D-132 6	1GHz ~ 18GHz	Oct. 30, 2018	May 09, 2019~ May 10, 2019	Oct. 29, 2019	Radiation (03CH11-HY)
Loop Antenna	Rohde & Schwarz	HFH2-Z2	100488	9 kHz~30 MHz	Nov. 22, 2018	May 09, 2019~ May 10, 2019	Nov. 21, 2019	Radiation (03CH11-HY)
Preamplifier	Keysight	83017A	MY532700 80	1GHz~26.5GHz	Nov. 14, 2018	May 09, 2019~ May 10, 2019	Nov. 13, 2020	Radiation (03CH11-HY)



Instrument	Manufacturer	Model No.	Serial No.	Characteristics	Calibration Date	Test Date	Due Date	Remark
Spectrum Analyzer	Keysight	N9010A	MY54200486	10Hz ~ 44GHz	Oct. 19, 2018	May 09, 2019~ May 10, 2019	Oct. 18, 2019	Radiation (03CH11-HY)
Controller	EMEC	EM 1000	N/A	Control Turn table & Ant Mast	N/A	May 09, 2019~ May 10, 2019	N/A	Radiation (03CH11-HY)
Antenna Mast	EMEC	AM-BS-4500- B	N/A	1~4m	N/A	May 09, 2019~ May 10, 2019	N/A	Radiation (03CH11-HY)
Turn Table	EMEC	TT 2000	N/A	0~360 Degree	N/A	May 09, 2019~ May 10, 2019	N/A	Radiation (03CH11-HY)
Preamplifier	Jet-Power	JPA0118-55-3 03	171000180 0055007	1GHz~18GHz	Apr. 01, 2019	May 09, 2019~ May 10, 2019	Mar. 31, 2020	Radiation (03CH11-HY)
SHF-EHF Horn Antenna	SCHWARZBE CK	BBHA 9170	BBHA9170 584	18GHz- 40GHz	Dec. 05, 2018	May 09, 2019~ May 10, 2019	Dec. 04, 2019	Radiation (03CH11-HY)
EMI Test Receiver	Keysight	N9038A(MXE)	MY541300 85	N/A	Nov. 01, 2018	May 09, 2019~ May 10, 2019	Oct. 31, 2019	Radiation (03CH11-HY)
Software	Audix	E3 6.2009-8-24	RK-00104 2	N/A	N/A	May 09, 2019~ May 10, 2019	N/A	Radiation (03CH11-HY)
RF Cable	HUBER + SUHNER	SUCOFLEX 104	MY9837/4 PE	9kHz-30MHz	Mar. 13, 2019	May 09, 2019~ May 10, 2019	Mar. 12, 2020	Radiation (03CH11-HY)
RF Cable	HUBER + SUHNER	SUCOFLEX 102	MY2859/2	30MHz-40GHz	Mar. 13, 2019	May 09, 2019~ May 10, 2019	Mar. 12, 2020	Radiation (03CH11-HY)
RF Cable	HUBER + SUHNER	SUCOFLEX 104	MY9837/4 PE	30M-18G	Mar. 13, 2019	May 09, 2019~ May 10, 2019	Mar. 12, 2020	Radiation (03CH11-HY)
RF Cable	HUBER + SUHNER	SUCOFLEX 102	MY4274/2	30MHz-40GHz	Mar. 13, 2019	May 09, 2019~ May 10, 2019	Mar. 12, 2020	Radiation (03CH11-HY)
Filter	Wainwright	WLK4-1000-1 530-8000-40S S	SN11	1G Low Pass	Sep. 16, 2018	May 09, 2019~ May 10, 2019	Sep. 17, 2019	Radiation (03CH11-HY)
Filter	Wainwright	WHKX12-270 0-3000-18000 -60SS	SN3	2.7G High Pass	Sep. 17, 2018	May 09, 2019~ May 10, 2019	Sep. 16, 2019	Radiation (03CH11-HY)
Hygrometer	TECEPEL	DTM-303B	TP161237	N/A	Oct. 22, 2018	May 09, 2019~ May 10, 2019	Oct. 21, 2019	Radiation (03CH11-HY)



5 Uncertainty of Evaluation

Uncertainty of Conducted Emission Measurement (150kHz ~ 30MHz)

Measuring Uncertainty for a Level of Confidence of 95% ($U = 2Uc(y)$)	2.20
---	------

Uncertainty of Radiated Emission Measurement (30 MHz ~ 1000 MHz)

Measuring Uncertainty for a Level of Confidence of 95% ($U = 2Uc(y)$)	5.20
---	------

Uncertainty of Radiated Emission Measurement (1000 MHz ~ 18000 MHz)

Measuring Uncertainty for a Level of Confidence of 95% ($U = 2Uc(y)$)	5.50
---	------

Uncertainty of Radiated Emission Measurement (18000 MHz ~ 40000 MHz)

Measuring Uncertainty for a Level of Confidence of 95% ($U = 2Uc(y)$)	5.20
---	------

Appendix A. Test Result of Conducted Test Items

Test Engineer:	Rebecca Li	Temperature:	21~25	°C
Test Date:	2019/05/07 ~ 2019/05/20	Relative Humidity:	51~54	%

TEST RESULTS DATA
6dB and 99% Occupied Bandwidth

2.4GHz Band										
Mod.	Data Rate	NTX	CH.	Freq. (MHz)	99% Occupied BW (MHz)		6dB BW (MHz)		6dB BW Limit (MHz)	Pass/Fail
					Ant 1	Ant 2	Ant 1	Ant 2		
11b	1Mbps	1	1	2412	13.95	-	8.08	-	0.50	Pass
11b	1Mbps	1	6	2437	13.95	-	8.52	-	0.50	Pass
11b	1Mbps	1	11	2462	13.95	-	8.08	-	0.50	Pass
11g	6Mbps	1	1	2412	16.85	-	15.64	-	0.50	Pass
11g	6Mbps	1	6	2437	16.85	-	15.64	-	0.50	Pass
11g	6Mbps	1	11	2462	16.80	-	15.08	-	0.50	Pass
HT20	MCS0	1	1	2412	18.00	-	16.06	-	0.50	Pass
HT20	MCS0	1	6	2437	18.00	-	15.08	-	0.50	Pass
HT20	MCS0	1	11	2462	17.90	-	15.66	-	0.50	Pass

TEST RESULTS DATA
Average Output Power

2.4GHz Band																
Mod.	Data Rate	NTX	CH.	Freq. (MHz)	Average Conducted Power (dBm)			Conducted Power Limit (dBm)		DG (dBi)		EIRP Power (dBm)		EIRP Power Limit (dBm)		Pass /Fail
					Ant 1	Ant 2	SUM	Ant 1	Ant 2	Ant 1	Ant 2	Ant 1	Ant 2	Ant 1	Ant 2	
11b	1Mbps	1	1	2412	18.70	-	-	30.00	-	-8.00	-	10.70	-	36.00	-	Pass
11b	1Mbps	1	6	2437	18.90	-		30.00	-	-8.00	-	10.90	-	36.00	-	Pass
11b	1Mbps	1	11	2462	18.60	-		30.00	-	-8.00	-	10.60	-	36.00	-	Pass
11g	6Mbps	1	1	2412	16.60	-		30.00	-	-8.00	-	8.60	-	36.00	-	Pass
11g	6Mbps	1	6	2437	16.80	-		30.00	-	-8.00	-	8.80	-	36.00	-	Pass
11g	6Mbps	1	11	2462	16.80	-		30.00	-	-8.00	-	8.80	-	36.00	-	Pass
HT20	MCS0	1	1	2412	16.90	-		30.00	-	-8.00	-	8.90	-	36.00	-	Pass
HT20	MCS0	1	6	2437	16.70	-		30.00	-	-8.00	-	8.70	-	36.00	-	Pass
HT20	MCS0	1	11	2462	16.80	-		30.00	-	-8.00	-	8.80	-	36.00	-	Pass

Note: Measured power (dBm) has offset with cable loss.

TEST RESULTS DATA
Peak Power Spectral Density

2.4GHz Band												
Mod.	Data Rate	NTX	CH.	Freq. (MHz)	Peak PSD (dBm/3kHz)			DG (dBi)		Peak PSD Limit (dBm/3kHz)		Pass/Fail
					Ant 1	Ant 2	Worse + 3.01	Ant 1	Ant 2	Ant 1	Ant 2	
11b	1Mbps	1	1	2412	-5.00	-	-	-8.00	-	8.00	-	Pass
11b	1Mbps	1	6	2437	-3.79	-	-	-8.00	-	8.00	-	Pass
11b	1Mbps	1	11	2462	-4.34	-	-	-8.00	-	8.00	-	Pass
11g	6Mbps	1	1	2412	-9.85	-	-	-8.00	-	8.00	-	Pass
11g	6Mbps	1	6	2437	-8.03	-	-	-8.00	-	8.00	-	Pass
11g	6Mbps	1	11	2462	-8.46	-	-	-8.00	-	8.00	-	Pass
HT20	MCS0	1	1	2412	-9.01	-	-	-8.00	-	8.00	-	Pass
HT20	MCS0	1	6	2437	-9.25	-	-	-8.00	-	8.00	-	Pass
HT20	MCS0	1	11	2462	-9.69	-	-	-8.00	-	8.00	-	Pass

Measured power density (dBm) has offset with cable loss.



Appendix B. AC Conducted Emission Test Results

Test Engineer :	Eric Jeng · Jimmy Chang	Temperature :	22~25°C
		Relative Humidity :	52~55%

EUT Information

Report NO : 942629
 Test Mode : Mode 1
 Test Voltage : 120Vac/60Hz
 Phase : Line

Full Spectrum

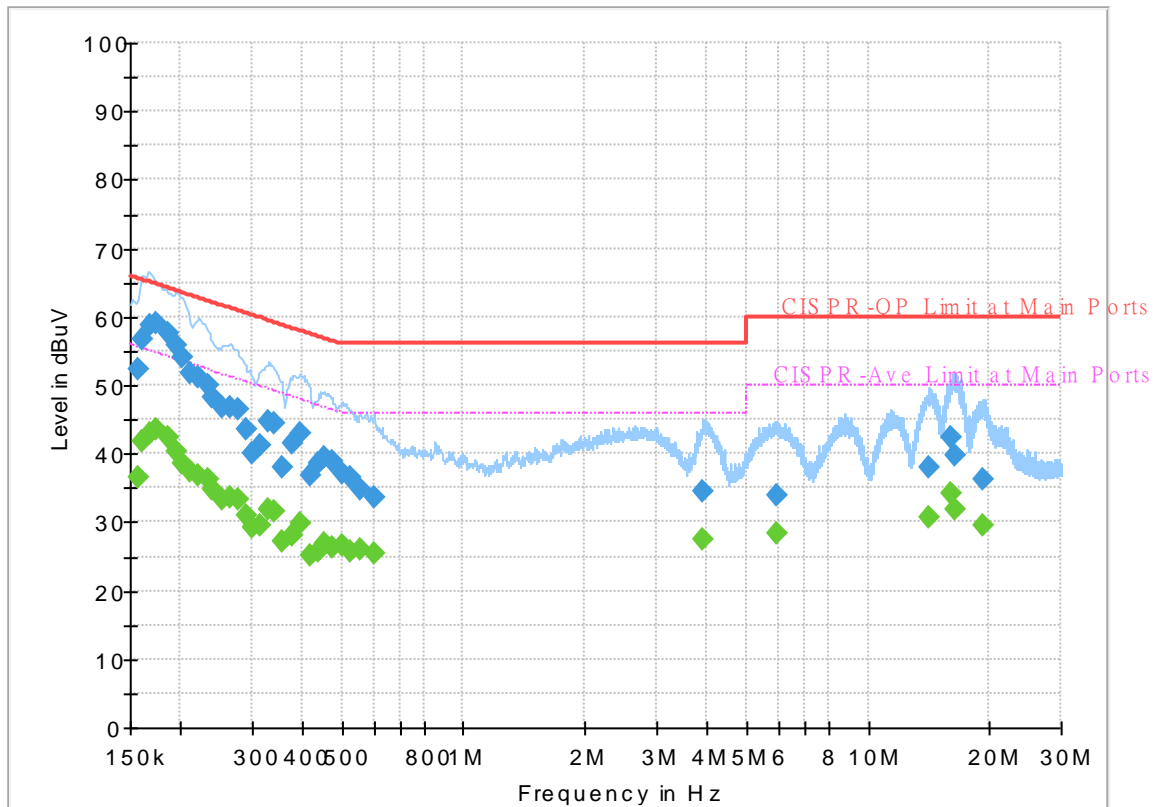

Final_Result

Frequency (MHz)	QuasiPeak (dBuV)	CAverage (dBuV)	Limit (dBuV)	Margin (dB)	Line	Filter	Corr. (dB)
0.156750	---	36.68	55.63	18.95	L1	OFF	19.5
0.156750	52.21	---	65.63	13.42	L1	OFF	19.5
0.161250	---	41.87	55.40	13.53	L1	OFF	19.5
0.161250	56.86	---	65.40	8.54	L1	OFF	19.5
0.168000	---	42.94	55.06	12.12	L1	OFF	19.5
0.168000	58.68	---	65.06	6.38	L1	OFF	19.5
0.174750	---	43.61	54.73	11.12	L1	OFF	19.5
0.174750	59.03	---	64.73	5.70	L1	OFF	19.5
0.186000	---	42.49	54.21	11.72	L1	OFF	19.5
0.186000	57.53	---	64.21	6.68	L1	OFF	19.5
0.195000	---	40.21	53.82	13.61	L1	OFF	19.5
0.195000	55.86	---	63.82	7.96	L1	OFF	19.5
0.201750	---	38.68	53.54	14.86	L1	OFF	19.5
0.201750	54.11	---	63.54	9.43	L1	OFF	19.5
0.210750	---	37.49	53.18	15.69	L1	OFF	19.5
0.210750	51.62	---	63.18	11.56	L1	OFF	19.5
0.219750	---	36.92	52.83	15.91	L1	OFF	19.5
0.219750	51.06	---	62.83	11.77	L1	OFF	19.5
0.233250	---	36.16	52.33	16.17	L1	OFF	19.5
0.233250	49.90	---	62.33	12.43	L1	OFF	19.5
0.240000	---	34.93	52.10	17.17	L1	OFF	19.5

0.240000	48.39	---	62.10	13.71	L1	OFF	19.5
0.253500	---	33.34	51.64	18.30	L1	OFF	19.5
0.253500	46.74	---	61.64	14.90	L1	OFF	19.5
0.264750	---	33.56	51.28	17.72	L1	OFF	19.5
0.264750	46.82	---	61.28	14.46	L1	OFF	19.5
0.276000	---	33.48	50.94	17.46	L1	OFF	19.5
0.276000	46.52	---	60.94	14.42	L1	OFF	19.5
0.289500	---	31.00	50.54	19.54	L1	OFF	19.5
0.289500	43.61	---	60.54	16.93	L1	OFF	19.5
0.300750	---	29.24	50.22	20.98	L1	OFF	19.5
0.300750	40.01	---	60.22	20.21	L1	OFF	19.5
0.314250	---	29.41	49.86	20.45	L1	OFF	19.5
0.314250	41.22	---	59.86	18.64	L1	OFF	19.5
0.330000	---	31.82	49.45	17.63	L1	OFF	19.5
0.330000	44.61	---	59.45	14.84	L1	OFF	19.5
0.339000	---	31.53	49.23	17.70	L1	OFF	19.5
0.339000	44.39	---	59.23	14.84	L1	OFF	19.5
0.354750	---	27.16	48.85	21.69	L1	OFF	19.5
0.354750	38.14	---	58.85	20.71	L1	OFF	19.5
0.377250	---	28.11	48.34	20.23	L1	OFF	19.5
0.377250	41.59	---	58.34	16.75	L1	OFF	19.5
0.395250	---	29.80	47.95	18.15	L1	OFF	19.5
0.395250	42.94	---	57.95	15.01	L1	OFF	19.5
0.417750	---	25.20	47.49	22.29	L1	OFF	19.5
0.417750	36.76	---	57.49	20.73	L1	OFF	19.5
0.435750	---	25.64	47.14	21.50	L1	OFF	19.5
0.435750	38.51	---	57.14	18.63	L1	OFF	19.5
0.451500	---	26.83	46.85	20.02	L1	OFF	19.5
0.451500	39.61	---	56.85	17.24	L1	OFF	19.5
0.471750	---	26.19	46.48	20.29	L1	OFF	19.5
0.471750	38.96	---	56.48	17.52	L1	OFF	19.5
0.503250	---	26.50	46.00	19.50	L1	OFF	19.5
0.503250	37.23	---	56.00	18.77	L1	OFF	19.5
0.528000	---	25.80	46.00	20.20	L1	OFF	19.5
0.528000	36.50	---	56.00	19.50	L1	OFF	19.5
0.555000	---	25.88	46.00	20.12	L1	OFF	19.5
0.555000	34.87	---	56.00	21.13	L1	OFF	19.5
0.602250	---	25.56	46.00	20.44	L1	OFF	19.6
0.602250	33.57	---	56.00	22.43	L1	OFF	19.6
3.916500	---	27.58	46.00	18.42	L1	OFF	19.7
3.916500	34.47	---	56.00	21.53	L1	OFF	19.7
5.973000	---	28.39	50.00	21.61	L1	OFF	19.8
5.973000	33.91	---	60.00	26.09	L1	OFF	19.8
14.084250	---	30.79	50.00	19.21	L1	OFF	20.1
14.084250	37.88	---	60.00	22.12	L1	OFF	20.1
16.064250	---	34.15	50.00	15.85	L1	OFF	20.1
16.064250	42.39	---	60.00	17.61	L1	OFF	20.1
16.455750	---	31.93	50.00	18.07	L1	OFF	20.1
16.455750	39.75	---	60.00	20.25	L1	OFF	20.1
19.279500	---	29.47	50.00	20.53	L1	OFF	20.2
19.279500	36.27	---	60.00	23.73	L1	OFF	20.2

EUT Information

Report NO : 942629
 Test Mode : Mode 1
 Test Voltage : 120Vac/60Hz
 Phase : Neutral

Full Spectrum

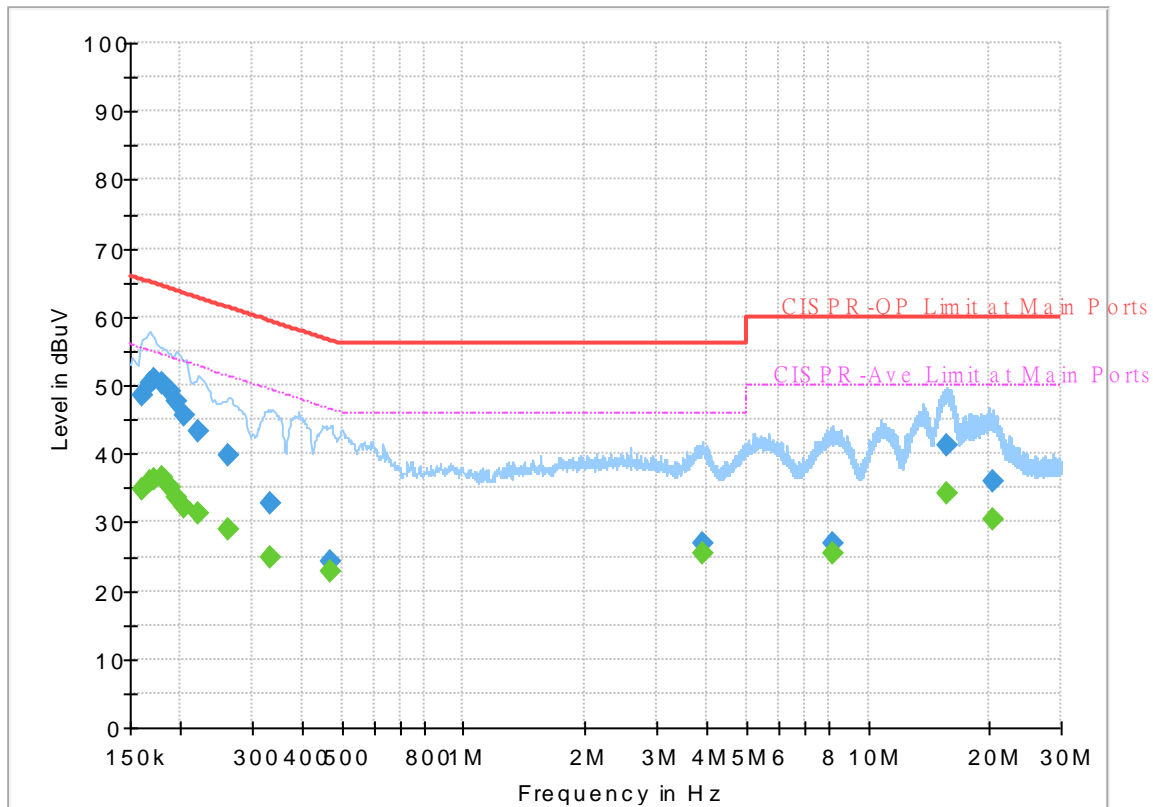

Final_Result

Frequency (MHz)	QuasiPeak (dBuV)	CAverage (dBuV)	Limit (dBuV)	Margin (dB)	Line	Filter	Corr. (dB)
0.161250	---	34.94	55.40	20.46	N	OFF	19.5
0.161250	48.47	---	65.40	16.93	N	OFF	19.5
0.168000	---	36.07	55.06	18.99	N	OFF	19.5
0.168000	50.32	---	65.06	14.74	N	OFF	19.5
0.172500	---	36.28	54.84	18.56	N	OFF	19.5
0.172500	50.88	---	64.84	13.96	N	OFF	19.5
0.179250	---	36.47	54.52	18.05	N	OFF	19.5
0.179250	50.41	---	64.52	14.11	N	OFF	19.5
0.188250	---	35.11	54.11	19.00	N	OFF	19.5
0.188250	49.06	---	64.11	15.05	N	OFF	19.5
0.195000	---	33.65	53.82	20.17	N	OFF	19.5
0.195000	47.74	---	63.82	16.08	N	OFF	19.5
0.204000	---	32.10	53.45	21.35	N	OFF	19.5
0.204000	45.66	---	63.45	17.79	N	OFF	19.5
0.222000	---	31.14	52.74	21.60	N	OFF	19.5
0.222000	43.26	---	62.74	19.48	N	OFF	19.5
0.262500	---	28.92	51.35	22.43	N	OFF	19.5
0.262500	39.84	---	61.35	21.51	N	OFF	19.5
0.332250	---	24.94	49.40	24.46	N	OFF	19.5
0.332250	32.75	---	59.40	26.65	N	OFF	19.5
0.467250	---	22.70	46.56	23.86	N	OFF	19.5

0.467250	24.22	---	56.56	32.34	N	OFF	19.5
3.898500	---	25.33	46.00	20.67	N	OFF	19.7
3.898500	26.98	---	56.00	29.02	N	OFF	19.7
8.153250	---	25.47	50.00	24.53	N	OFF	19.8
8.153250	26.77	---	60.00	33.23	N	OFF	19.8
15.605250	---	34.09	50.00	15.91	N	OFF	20.1
15.605250	41.29	---	60.00	18.71	N	OFF	20.1
20.379750	---	30.48	50.00	19.52	N	OFF	20.3
20.379750	35.97	---	60.00	24.03	N	OFF	20.3



Appendix C. Radiated Spurious Emission

Test Engineer :	Hao Shu, Ken Wu, and Fu Chen	Temperature :	20~24°C
		Relative Humidity :	51~56%

**2.4GHz 2400~2483.5MHz
WIFI 802.11b (Band Edge @ 3m)**

WIFI Ant. 1	Note	Frequency (MHz)	Level (dBμV/m)	Over Limit (dB)	Limit Line (dBμV/m)	Read Level (dBμV)	Antenna Factor (dB/m)	Path Loss (dB)	Preamp Factor (dB)	Ant Pos (cm)	Table Pos (deg)	Peak Avg. (P/A)	Pol. (H/V)	
802.11b CH 01 2412MHz		2360.715	52.64	-21.36	74	42.12	27.56	16.6	33.64	100	136	P	H	
		2379.825	42.24	-11.76	54	31.76	27.48	16.63	33.63	100	136	A	H	
	*	2412	102.52	-	-	92.1	27.38	16.66	33.62	100	136	P	H	
	*	2412	99.45	-	-	89.03	27.38	16.66	33.62	100	136	A	H	
													H	
														H
			2388.75	52.8	-21.2	74	42.35	27.44	16.64	33.63	100	202	P	V
			2389.905	41.74	-12.26	54	31.29	27.44	16.64	33.63	100	202	A	V
	*		2412	102.97	-	-	92.55	27.38	16.66	33.62	100	202	P	V
	*		2412	99.95	-	-	89.53	27.38	16.66	33.62	100	202	A	V
														V
														V
802.11b CH 06 2437MHz		2353.2	52.16	-21.84	74	41.61	27.59	16.6	33.64	100	136	P	H	
		2389.84	41.57	-12.43	54	31.12	27.44	16.64	33.63	100	136	A	H	
	*	2437	103.52	-	-	93.11	27.33	16.69	33.61	100	136	P	H	
	*	2437	100.35	-	-	89.94	27.33	16.69	33.61	100	136	A	H	
			2485.68	51.85	-22.15	74	41.41	27.3	16.74	33.6	100	136	P	H
			2483.52	41.85	-12.15	54	31.41	27.3	16.74	33.6	100	136	A	H
			2381.36	52.37	-21.63	74	41.9	27.47	16.63	33.63	104	289	P	V
			2314.32	41.59	-12.41	54	30.96	27.74	16.55	33.66	104	289	A	V
	*		2437	103.13	-	-	92.72	27.33	16.69	33.61	104	289	P	V
	*		2437	99.91	-	-	89.5	27.33	16.69	33.61	104	289	A	V
			2491.84	52.13	-21.87	74	41.67	27.3	16.75	33.59	104	289	P	V
			2483.76	41.69	-12.31	54	31.25	27.3	16.74	33.6	104	289	A	V



802.11b CH 11 2462MHz	*	2462	102.38	-	-	91.96	27.3	16.72	33.6	100	137	P	H
	*	2462	99.11	-	-	88.69	27.3	16.72	33.6	100	137	A	H
		2488.04	53.89	-20.11	74	43.44	27.3	16.74	33.59	100	137	P	H
		2493.48	42.19	-11.81	54	31.73	27.3	16.75	33.59	100	137	A	H
													H
													H
	*	2462	103.22	-	-	92.8	27.3	16.72	33.6	100	291	P	V
	*	2462	100	-	-	89.58	27.3	16.72	33.6	100	291	A	V
		2483.92	52.81	-21.19	74	42.37	27.3	16.74	33.6	100	291	P	V
		2483.92	41.82	-12.18	54	31.38	27.3	16.74	33.6	100	291	A	V
													V
													V
Remark	1. No other spurious found. 2. All results are PASS against Peak and Average limit line.												



**2.4GHz 2400~2483.5MHz
WIFI 802.11b (Harmonic @ 3m)**

WIFI Ant. 1	Note	Frequency (MHz)	Level (dBμV/m)	Over Limit (dB)	Limit Line (dBμV/m)	Read Level (dBμV)	Antenna Factor (dB/m)	Path Loss (dB)	Preamp Factor (dB)	Ant Pos (cm)	Table Pos (deg)	Peak Avg. (P/A)	Pol. (H/V)
802.11b CH 01 2412MHz		4824	41.96	-32.04	74	59	31.1	11.02	59.16	100	0	P	H
													H
													H
													H
		4824	42.28	-31.72	74	59.32	31.1	11.02	59.16	100	0	P	V
													V
													V
802.11b CH 06 2437MHz		4874	41.61	-32.39	74	58.67	31.05	11.06	59.17	100	0	P	H
		7311	41.46	-32.54	74	50.46	36.52	13.66	59.18	100	0	P	H
													H
													H
		4874	40.96	-33.04	74	58.02	31.05	11.06	59.17	100	0	P	V
		7311	42.09	-31.91	74	51.09	36.52	13.66	59.18	100	0	P	V
													V
802.11b CH 11 2462MHz		4924	40.8	-33.2	74	57.75	31.14	11.09	59.18	100	0	P	H
		7386	40.83	-33.17	74	49.94	36.46	13.58	59.15	100	0	P	H
													H
													H
		4924	42.73	-31.27	74	59.68	31.14	11.09	59.18	100	0	P	V
		7386	40.22	-33.78	74	49.33	36.46	13.58	59.15	100	0	P	V
													V
Remark	1. No other spurious found.												
	2. All results are PASS against Peak and Average limit line.												



**2.4GHz 2400~2483.5MHz
WIFI 802.11g (Band Edge @ 3m)**

WIFI Ant. 1	Note	Frequency (MHz)	Level (dBμV/m)	Over Limit (dB)	Limit Line (dBμV/m)	Read Level (dBμV)	Antenna Factor (dB/m)	Path Loss (dB)	Preamp Factor (dB)	Ant Pos (cm)	Table Pos (deg)	Peak Avg. (P/A)	Pol. (H/V)	
802.11g CH 01 2412MHz		2389.17	53.31	-20.69	74	42.86	27.44	16.64	33.63	100	136	P	H	
		2390	44.56	-9.44	54	34.11	27.44	16.64	33.63	100	136	A	H	
	*	2412	102.01	-	-	91.59	27.38	16.66	33.62	100	136	P	H	
	*	2412	94.42	-	-	84	27.38	16.66	33.62	100	136	A	H	
													H	
														H
			2390	54.16	-19.84	74	43.71	27.44	16.64	33.63	103	202	P	V
			2390	45.14	-8.86	54	34.69	27.44	16.64	33.63	103	202	A	V
	*		2414	102.28	-	-	91.87	27.37	16.66	33.62	103	202	P	V
	*		2412	94.81	-	-	84.39	27.38	16.66	33.62	103	202	A	V
														V
														V
802.11g CH 06 2437MHz		2344.24	53.14	-20.86	74	42.58	27.62	16.59	33.65	130	61	P	H	
		2317.36	42.61	-11.39	54	31.99	27.73	16.55	33.66	130	61	A	H	
	*	2437	101.69	-	-	91.28	27.33	16.69	33.61	130	61	P	H	
	*	2437	93.7	-	-	83.29	27.33	16.69	33.61	130	61	A	H	
			2485.28	52.32	-21.68	74	41.88	27.3	16.74	33.6	130	61	P	H
			2485.12	42.95	-11.05	54	32.51	27.3	16.74	33.6	130	61	A	H
			2376.08	53.59	-20.41	74	43.1	27.5	16.62	33.63	100	289	P	V
			2387.28	42.54	-11.46	54	32.08	27.45	16.64	33.63	100	289	A	V
	*		2437	102.85	-	-	92.44	27.33	16.69	33.61	100	289	P	V
	*		2437	95.29	-	-	84.88	27.33	16.69	33.61	100	289	A	V
			2486.96	52.4	-21.6	74	41.95	27.3	16.74	33.59	100	289	P	V
			2484.24	42.79	-11.21	54	32.35	27.3	16.74	33.6	100	289	A	V



802.11g CH 11 2462MHz	*	2462	102.68	-	-	92.26	27.3	16.72	33.6	100	60	P	H
	*	2462	95.17	-	-	84.75	27.3	16.72	33.6	100	60	A	H
		2483.52	53.82	-20.18	74	43.38	27.3	16.74	33.6	100	60	P	H
		2483.56	44.32	-9.68	54	33.88	27.3	16.74	33.6	100	60	A	H
													H
													H
	*	2462	103.29	-	-	92.87	27.3	16.72	33.6	123	302	P	V
	*	2462	95.52	-	-	85.1	27.3	16.72	33.6	123	302	A	V
		2485.28	52.76	-21.24	74	42.32	27.3	16.74	33.6	123	302	P	V
		2483.68	43.79	-10.21	54	33.35	27.3	16.74	33.6	123	302	A	V
													V
													V
Remark	1. No other spurious found. 2. All results are PASS against Peak and Average limit line.												



**2.4GHz 2400~2483.5MHz
WIFI 802.11g (Harmonic @ 3m)**

WIFI Ant. 1	Note	Frequency (MHz)	Level (dBμV/m)	Over Limit (dB)	Limit Line (dBμV/m)	Read Level (dBμV)	Antenna Factor (dB/m)	Path Loss (dB)	Preamp Factor (dB)	Ant Pos (cm)	Table Pos (deg)	Peak Avg. (P/A)	Pol. (H/V)
802.11g CH 01 2412MHz		4824	37.31	-36.69	74	54.35	31.1	11.02	59.16	100	0	P	H
													H
													H
													H
		4824	37.97	-36.03	74	55.01	31.1	11.02	59.16	100	0	P	V
													V
													V
802.11g CH 06 2437MHz		4874	37.76	-36.24	74	54.82	31.05	11.06	59.17	100	0	P	H
		7311	41.34	-32.66	74	50.34	36.52	13.66	59.18	100	0	P	H
													H
													H
		4874	37.26	-36.74	74	54.32	31.05	11.06	59.17	100	0	P	V
		7311	40.57	-33.43	74	49.57	36.52	13.66	59.18	100	0	P	V
													V
802.11g CH 11 2462MHz		4924	37.12	-36.88	74	54.07	31.14	11.09	59.18	100	0	P	H
		7386	41.27	-32.73	74	50.38	36.46	13.58	59.15	100	0	P	H
													H
													H
		4924	37.65	-36.35	74	54.6	31.14	11.09	59.18	100	0	P	V
		7386	40.83	-33.17	74	49.94	36.46	13.58	59.15	100	0	P	V
													V
Remark	1. No other spurious found.												
	2. All results are PASS against Peak and Average limit line.												



**2.4GHz 2400~2483.5MHz
WIFI 802.11n HT20 (Band Edge @ 3m)**

WIFI Ant. 1	Note	Frequency (MHz)	Level (dBμV/m)	Over Limit (dB)	Limit Line (dBμV/m)	Read Level (dBμV)	Antenna Factor (dB/m)	Path Loss (dB)	Preamp Factor (dB)	Ant Pos (cm)	Table Pos (deg)	Peak Avg. (P/A)	Pol. (H/V)	
802.11n HT20 CH 01 2412MHz		2389.695	58.26	-15.74	74	47.81	27.44	16.64	33.63	100	136	P	H	
		2390	47.59	-6.41	54	37.14	27.44	16.64	33.63	100	136	A	H	
	*	2412	102.59	-	-	92.17	27.38	16.66	33.62	100	136	P	H	
	*	2412	94.59	-	-	84.17	27.38	16.66	33.62	100	136	A	H	
													H	
														H
			2390	56.82	-17.18	74	46.37	27.44	16.64	33.63	103	202	P	V
			2389.905	47.35	-6.65	54	36.9	27.44	16.64	33.63	103	202	A	V
		*	2412	102.43	-	-	92.01	27.38	16.66	33.62	103	202	P	V
		*	2412	94.93	-	-	84.51	27.38	16.66	33.62	103	202	A	V
													V	
													V	
802.11n HT20 CH 06 2437MHz		2347.44	52.3	-21.7	74	41.74	27.61	16.59	33.64	112	138	P	H	
		2387.28	42.66	-11.34	54	32.2	27.45	16.64	33.63	112	138	A	H	
	*	2437	102.56	-	-	92.15	27.33	16.69	33.61	112	138	P	H	
	*	2437	95.25	-	-	84.84	27.33	16.69	33.61	112	138	A	H	
			2486.96	52.79	-21.21	74	42.34	27.3	16.74	33.59	112	138	P	H
			2483.6	43.22	-10.78	54	32.78	27.3	16.74	33.6	112	138	A	H
			2370.48	52.43	-21.57	74	41.93	27.52	16.62	33.64	110	289	P	V
			2344.08	42.58	-11.42	54	32.02	27.62	16.59	33.65	110	289	A	V
		*	2437	102.49	-	-	92.08	27.33	16.69	33.61	110	289	P	V
		*	2437	94.87	-	-	84.46	27.33	16.69	33.61	110	289	A	V
		2494.64	52.35	-21.65	74	41.89	27.3	16.75	33.59	110	289	P	V	
		2484	42.79	-11.21	54	32.35	27.3	16.74	33.6	110	289	A	V	



802.11n HT20 CH 11 2462MHz	*	2462	101.43	-	-	91.01	27.3	16.72	33.6	113	136	P	H
	*	2462	94.1	-	-	83.68	27.3	16.72	33.6	113	136	A	H
		2486.04	53.76	-20.24	74	43.32	27.3	16.74	33.6	113	136	P	H
		2483.52	44.89	-9.11	54	34.45	27.3	16.74	33.6	113	136	A	H
													H
													H
	*	2462	102.73	-	-	92.31	27.3	16.72	33.6	143	291	P	V
	*	2462	95.09	-	-	84.67	27.3	16.72	33.6	143	291	A	V
		2484.4	53.65	-20.35	74	43.21	27.3	16.74	33.6	143	291	P	V
		2483.52	44.16	-9.84	54	33.72	27.3	16.74	33.6	143	291	A	V
													V
													V
Remark	1. No other spurious found. 2. All results are PASS against Peak and Average limit line.												



**2.4GHz 2400~2483.5MHz
WIFI 802.11n HT20 (Harmonic @ 3m)**

WIFI Ant. 1	Note	Frequency (MHz)	Level (dBμV/m)	Over Limit (dB)	Limit Line (dBμV/m)	Read Level (dBμV)	Antenna Factor (dB/m)	Path Loss (dB)	Preamp Factor (dB)	Ant Pos (cm)	Table Pos (deg)	Peak Avg. (P/A)	Pol. (H/V)	
802.11n HT20 CH 01 2412MHz		4824	36.35	-37.65	74	53.39	31.1	11.02	59.16	100	0	P	H	
													H	
													H	
													H	
			4824	37.93	-36.07	74	54.97	31.1	11.02	59.16	100	0	P	V
														V
														V
802.11n HT20 CH 06 2437MHz		4874	37.03	-36.97	74	54.09	31.05	11.06	59.17	100	0	P	H	
													H	
			7311	40.75	-33.25	74	49.75	36.52	13.66	59.18	100	0	P	H
														H
			4874	37.68	-36.32	74	54.74	31.05	11.06	59.17	100	0	P	V
			7311	40.93	-33.07	74	49.93	36.52	13.66	59.18	100	0	P	V
														V
802.11n HT20 CH 11 2462MHz		4924	38.29	-35.71	74	55.24	31.14	11.09	59.18	100	0	P	H	
													H	
			7386	40.39	-33.61	74	49.5	36.46	13.58	59.15	100	0	P	H
														H
			4924	37.63	-36.37	74	54.58	31.14	11.09	59.18	100	0	P	V
			7386	40.85	-33.15	74	49.96	36.46	13.58	59.15	100	0	P	V
														V
Remark	1. No other spurious found.													
	2. All results are PASS against Peak and Average limit line.													



Note symbol

*	Fundamental Frequency which can be ignored. However, the level of any unwanted emissions shall not exceed the level of the fundamental frequency.
!	Test result is over limit line.
P/A	Peak or Average
H/V	Horizontal or Vertical



A calculation example for radiated spurious emission is shown as below:

WIFI	Note	Frequency	Level	Over	Limit	Read	Antenna	Path	Preamp	Ant	Table	Peak	Pol.
Ant.				Limit	Line	Level	Factor	Loss	Factor	Pos	Pos	Avg.	
1		(MHz)	(dBμV/m)	(dB)	(dBμV/m)	(dBμV)	(dB/m)	(dB)	(dB)	(cm)	(deg)	(P/A)	(H/V)
802.11b		2390	55.45	-18.55	74	54.51	32.22	4.58	35.86	103	308	P	H
CH 01													
2412MHz		2390	43.54	-10.46	54	42.6	32.22	4.58	35.86	103	308	A	H

1. Path Loss(dB) = Cable loss(dB) + Filter loss(dB) + Attenuator loss(dB)
2. Level(dBμV/m) =
Antenna Factor(dB/m) + Path Loss(dB) + Read Level(dBμV) - Preamp Factor(dB)
3. Over Limit(dB) = Level(dBμV/m) – Limit Line(dBμV/m)

For Peak Limit @ 2390MHz:

1. Level(dBμV/m)
= Antenna Factor(dB/m) + Path Loss(dB) + Read Level(dBμV) - Preamp Factor(dB)
= 32.22(dB/m) + 4.58(dB) + 54.51(dBμV) – 35.86 (dB)
= 55.45 (dBμV/m)
2. Over Limit(dB)
= Level(dBμV/m) – Limit Line(dBμV/m)
= 55.45(dBμV/m) – 74(dBμV/m)
= -18.55(dB)

For Average Limit @ 2390MHz:

1. Level(dBμV/m)
= Antenna Factor(dB/m) + Path Loss(dB) + Read Level(dBμV) - Preamp Factor(dB)
= 32.22(dB/m) + 4.58(dB) + 42.6(dBμV) – 35.86 (dB)
= 43.54 (dBμV/m)
2. Over Limit(dB)
= Level(dBμV/m) – Limit Line(dBμV/m)
= 43.54(dBμV/m) – 54(dBμV/m)
= -10.46(dB)

Both peak and average measured complies with the limit line, so test result is “PASS”.



Appendix D. Radiated Spurious Emission Plots

Test Engineer :	Hao Shu, Ken Wu, and Fu Chen	Temperature :	20~24°C
		Relative Humidity :	51~56%

Note symbol

-L	Low channel location
-R	High channel location

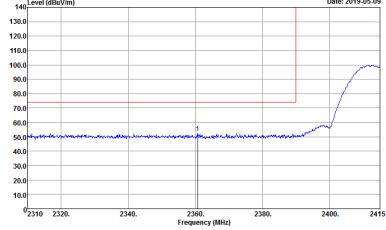
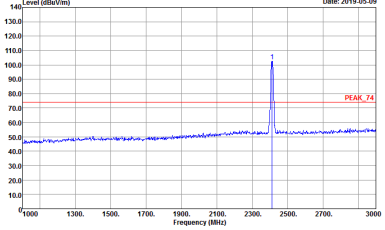
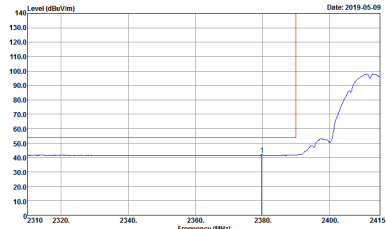
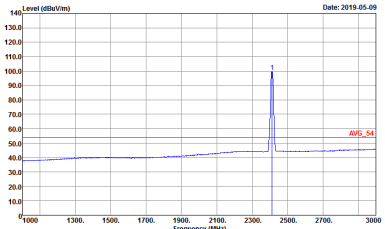

2.4GHz 2400~2483.5MHz
WIFI 802.11b (Band Edge @ 3m)

WIFI	2.4GHz 2400~2483.5MHz Band Edge @ 3m	
ANT	802.11b CH01 2412MHz	
1	Horizontal	Fundamental
Peak	 <p>Site : 03CH11-HY Condition : PEAK_BE_74 3m HORN 9120D-HF HORIZONTAL Detector : Peak Project : 942629</p>	 <p>Site : 03CH11-HY Condition : PEAK_74 3m HORN 9120D-HF HORIZONTAL Detector : Peak Project : 942629</p>
Avg.	 <p>Site : 03CH11-HY Condition : AV6_BE_54 3m HORN 9120D-HF HORIZONTAL Detector : Peak Project : 942629</p>	 <p>Site : 03CH11-HY Condition : AV6_54 3m HORN 9120D-HF HORIZONTAL Detector : Peak Project : 942629</p>

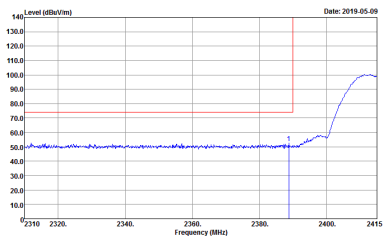
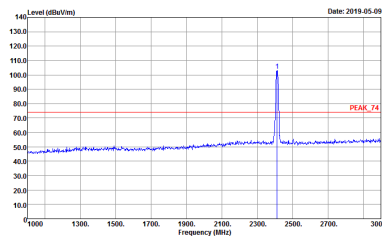
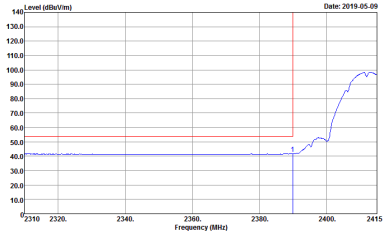
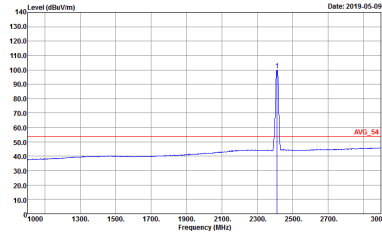

WIFI	2.4GHz 2400~2483.5MHz Band Edge @ 3m	
ANT	802.11b CH01 2412MHz	
1	Vertical	Fundamental
Peak	 <p>Site : 03CH11-HY Condition : PEAK_BE_74 3m HORN 91200-HF VERTICAL Detector : Peak Project : 942629</p>	 <p>Site : 03CH11-HY Condition : PEAK_74 3m HORN 91200-HF VERTICAL Detector : Peak Project : 942629</p>
Avg.	 <p>Site : 03CH11-HY Condition : AVG_BE_54 3m HORN 91200-HF VERTICAL Detector : Peak Project : 942629</p>	 <p>Site : 03CH11-HY Condition : AVG_54 3m HORN 91200-HF VERTICAL Detector : Peak Project : 942629</p>

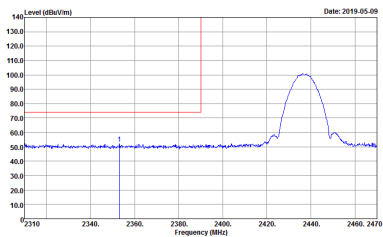
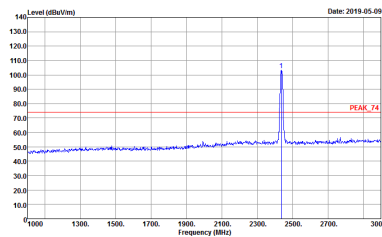
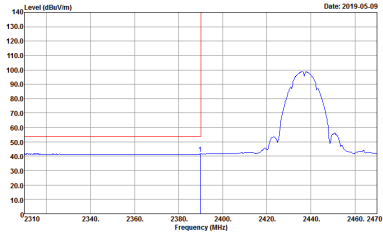
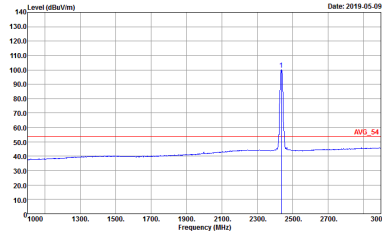

WIFI	2.4GHz 2400~2483.5MHz Band Edge @ 3m	
ANT	802.11b CH06 2437MHz - L	
1	Horizontal	Fundamental
Peak	 <p>Site : 03CH11-HY Condition : PEAK_BE_74 3m HORN 9120D-HF HORIZONTAL Detector : Peak Project : 942629</p>	 <p>Site : 03CH11-HY Condition : PEAK_74 3m HORN 9120D-HF HORIZONTAL Detector : Peak Project : 942629</p>
Avg.	 <p>Site : 03CH11-HY Condition : AVG_BE_54 3m HORN 9120D-HF HORIZONTAL Detector : Peak Project : 942629</p>	 <p>Site : 03CH11-HY Condition : AVG_54 3m HORN 9120D-HF HORIZONTAL Detector : Peak Project : 942629</p>

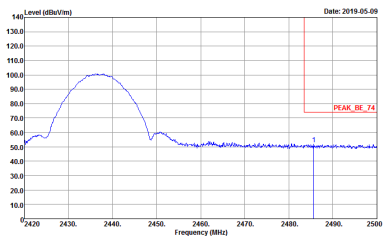
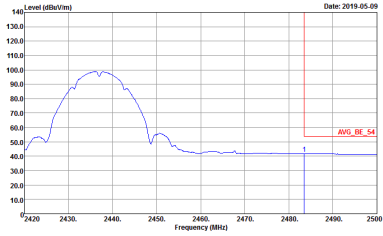

WIFI	2.4GHz 2400~2483.5MHz Band Edge @ 3m	
ANT	802.11b CH06 2437MHz - R	
1	Horizontal	Fundamental
Peak	 <p>Site : 03CH11-HY Condition : PEAK_BE_74 3m HORN 91200-HF HORIZONTAL Detector : Peak Project : 942629</p>	Left blank
Avg.	 <p>Site : 03CH11-HY Condition : AVG_BE_54 3m HORN 91200-HF HORIZONTAL Detector : Peak Project : 942629</p>	Left blank

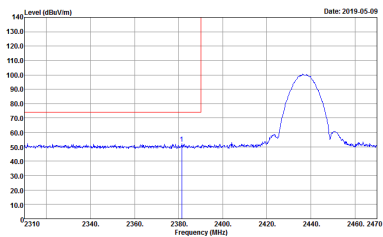
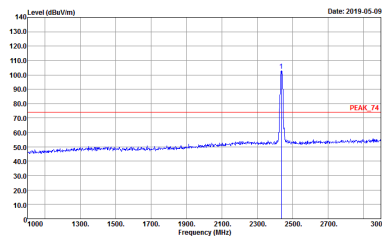
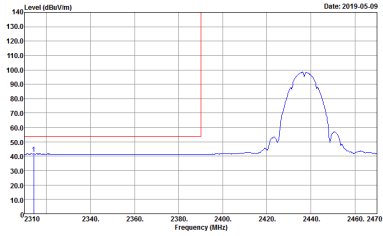
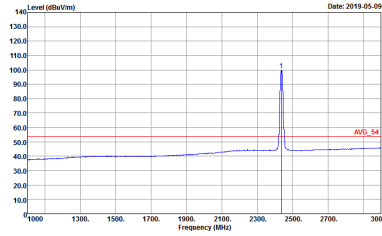

WIFI	2.4GHz 2400~2483.5MHz Band Edge @ 3m	
ANT	802.11b CH06 2437MHz - L	
1	Vertical	Fundamental
Peak	 <p>Date: 2019-05-09</p> <p>Site : 03CH11-HY Condition : PEAK_BE_74 3m HORN 9120D-HF VERTICAL : RBW:1000.000KHz VBW:3000.000KHz SWT:Auto Detector : Peak Project : 942629</p>	 <p>Date: 2019-05-09</p> <p>Site : 03CH11-HY Condition : PEAK_74 3m HORN 9120D-HF VERTICAL : RBW:1000.000KHz VBW:3000.000KHz SWT:Auto Detector : Peak Project : 942629</p>
Avg.	 <p>Date: 2019-05-09</p> <p>Site : 03CH11-HY Condition : AVG_BE_54 3m HORN 9120D-HF VERTICAL : RBW:1000.000KHz VBW:0.010KHz SWT:Auto Detector : Peak Project : 942629</p>	 <p>Date: 2019-05-09</p> <p>Site : 03CH11-HY Condition : AVG_54 3m HORN 9120D-HF VERTICAL : RBW:1000.000KHz VBW:0.010KHz SWT:Auto Detector : Peak Project : 942629</p>



WIFI	2.4GHz 2400~2483.5MHz Band Edge @ 3m	
ANT	802.11b CH06 2437MHz - R	
1	Vertical	Fundamental
Peak	<p>Site : 03CH11-HY Condition : PEAK_BE_74 3m HORN 91200-HF VERTICAL Detector : Peak Project : 942629</p>	Left blank
Avg.	<p>Site : 03CH11-HY Condition : AVG_BE_54 3m HORN 91200-HF VERTICAL Detector : Peak Project : 942629</p>	Left blank

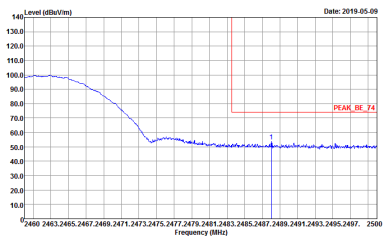
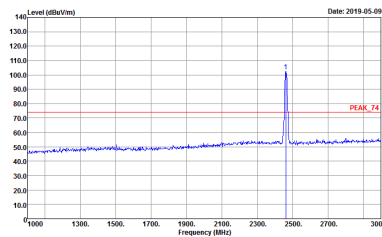
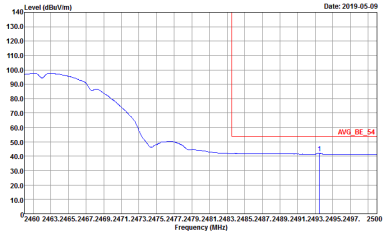
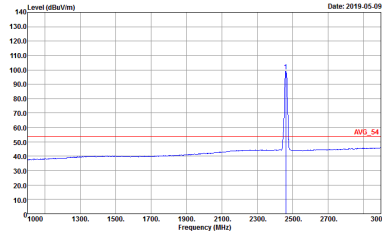

WIFI	2.4GHz 2400~2483.5MHz Band Edge @ 3m	
ANT	802.11b CH11 2462MHz	
1	Horizontal	Fundamental
Peak	 <p>Level (dBm/100MHz) vs Frequency (MHz) plot showing a peak at 2462 MHz. The y-axis ranges from 10.0 to 140.0 dBm/100MHz, and the x-axis ranges from 2460 to 2500 MHz. A red line indicates the peak level at approximately 100 dBm/100MHz.</p> <p>Site : 03CH11-HY Condition : PEAK_BE_74 3m HORN 9120D-HF HORIZONTAL RBW:1000.000KHz VBW:3000.000KHz SWT:Auto Detector : Peak Project : 942629</p>	 <p>Level (dBm/100MHz) vs Frequency (MHz) plot showing a sharp peak at 2462 MHz. The y-axis ranges from 10.0 to 140.0 dBm/100MHz, and the x-axis ranges from 1000 to 3000 MHz. A red line indicates the peak level at approximately 100 dBm/100MHz.</p> <p>Site : 03CH11-HY Condition : PEAK_74 3m HORN 9120D-HF HORIZONTAL RBW:1000.000KHz VBW:3000.000KHz SWT:Auto Detector : Peak Project : 942629</p>
Avg.	 <p>Level (dBm/100MHz) vs Frequency (MHz) plot showing the average level across the band. The y-axis ranges from 10.0 to 140.0 dBm/100MHz, and the x-axis ranges from 2460 to 2500 MHz. A red line indicates the average level at approximately 50 dBm/100MHz.</p> <p>Site : 03CH11-HY Condition : AVG_BE_54 3m HORN 9120D-HF HORIZONTAL RBW:1000.000KHz VBW:0.010KHz SWT:Auto Detector : Peak Project : 942629</p>	 <p>Level (dBm/100MHz) vs Frequency (MHz) plot showing the average level across the band. The y-axis ranges from 10.0 to 140.0 dBm/100MHz, and the x-axis ranges from 1000 to 3000 MHz. A red line indicates the average level at approximately 50 dBm/100MHz.</p> <p>Site : 03CH11-HY Condition : AVG_54 3m HORN 9120D-HF HORIZONTAL RBW:1000.000KHz VBW:0.010KHz SWT:Auto Detector : Peak Project : 942629</p>

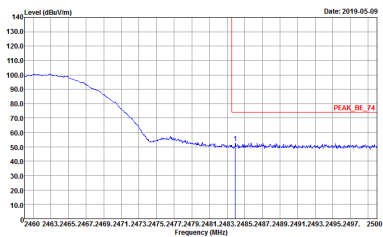
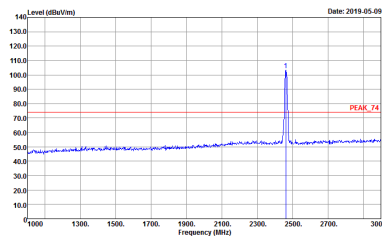
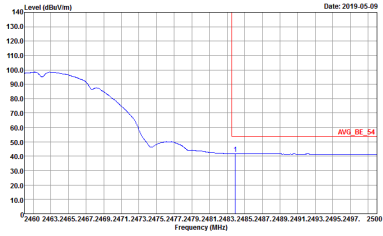
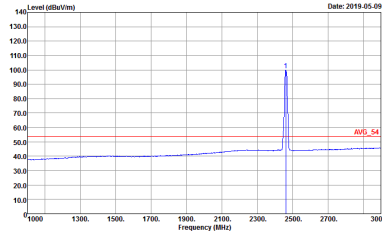

WIFI	2.4GHz 2400~2483.5MHz Band Edge @ 3m	
ANT	802.11b CH11 2462MHz	
1	Vertical	Fundamental
Peak	 <p>Date: 2019-05-09</p> <p>Site : 03CH11-HY Condition : PEAK_BE_74 3m HORN 9120D-HF VERTICAL : RBW:1000.000KHz VBW:3000.000KHz SWT:Auto Detector : Peak Project : 942629</p>	 <p>Date: 2019-05-09</p> <p>Site : 03CH11-HY Condition : PEAK_74 3m HORN 9120D-HF VERTICAL : RBW:1000.000KHz VBW:3000.000KHz SWT:Auto Detector : Peak Project : 942629</p>
Avg.	 <p>Date: 2019-05-09</p> <p>Site : 03CH11-HY Condition : AVG_BE_54 3m HORN 9120D-HF VERTICAL : RBW:1000.000KHz VBW:0.010KHz SWT:Auto Detector : Peak Project : 942629</p>	 <p>Date: 2019-05-09</p> <p>Site : 03CH11-HY Condition : AVG_54 3m HORN 9120D-HF VERTICAL : RBW:1000.000KHz VBW:0.010KHz SWT:Auto Detector : Peak Project : 942629</p>

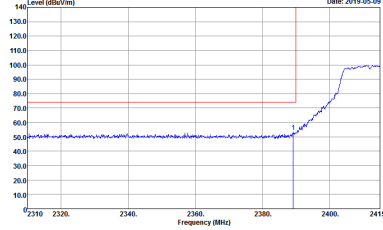
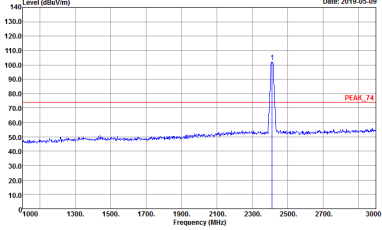
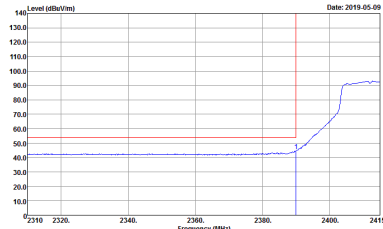
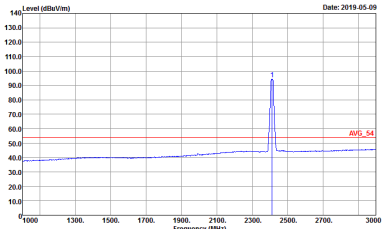

2.4GHz 2400~2483.5MHz
WIFI 802.11g (Band Edge @ 3m)

WIFI	2.4GHz 2400~2483.5MHz Band Edge @ 3m	
ANT	802.11g CH01 2412MHz	
1	Horizontal	Fundamental
Peak	 <p>Site : 03CH11-HY Condition : PEAK_BE_74 3m HORN 9120D-HF HORIZONTAL RBW:1000.000KHz VBW:3000.000KHz SWT:Auto Detector : Peak Project : 942629</p>	 <p>Site : 03CH11-HY Condition : PEAK_74 3m HORN 9120D-HF HORIZONTAL RBW:1000.000KHz VBW:3000.000KHz SWT:Auto Detector : Peak Project : 942629</p>
Avg.	 <p>Site : 03CH11-HY Condition : AV6_BE_54 3m HORN 9120D-HF HORIZONTAL RBW:1000.000KHz VBW:1.000KHz SWT:Auto Detector : Peak Project : 942629</p>	 <p>Site : 03CH11-HY Condition : AV6_54 3m HORN 9120D-HF HORIZONTAL RBW:1000.000KHz VBW:1.000KHz SWT:Auto Detector : Peak Project : 942629</p>

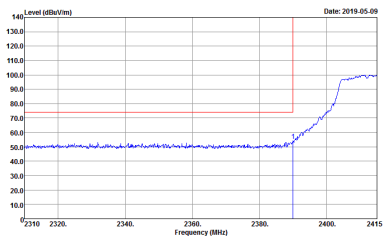
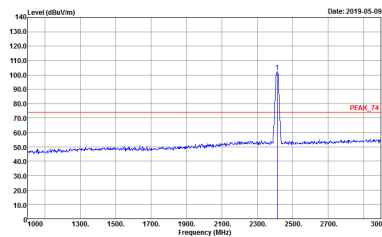
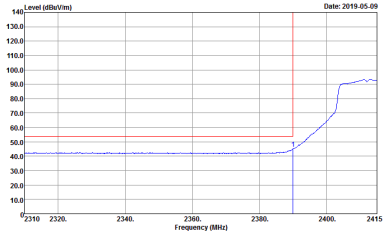
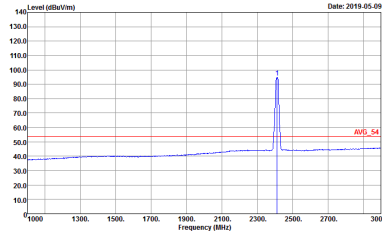

WIFI	2.4GHz 2400~2483.5MHz Band Edge @ 3m	
ANT	802.11g CH01 2412MHz	
1	Vertical	Fundamental
Peak	 <p>Date: 2019-05-09</p> <p>Site : 03CH11-HY Condition : PEAK_BE_74 3m HORN 91200-HF VERTICAL : RBW:1000.000KHz VBW:3000.000KHz SWT:Auto Detector : Peak Project : 942629</p>	 <p>Date: 2019-05-09</p> <p>Site : 03CH11-HY Condition : PEAK_74 3m HORN 91200-HF VERTICAL : RBW:1000.000KHz VBW:3000.000KHz SWT:Auto Detector : Peak Project : 942629</p>
Avg.	 <p>Date: 2019-05-09</p> <p>Site : 03CH11-HY Condition : AVG_BE_54 3m HORN 91200-HF VERTICAL : RBW:1000.000KHz VBW:1000KHz SWT:Auto Detector : Peak Project : 942629</p>	 <p>Date: 2019-05-09</p> <p>Site : 03CH11-HY Condition : AVG_54 3m HORN 91200-HF VERTICAL : RBW:1000.000KHz VBW:1000KHz SWT:Auto Detector : Peak Project : 942629</p>

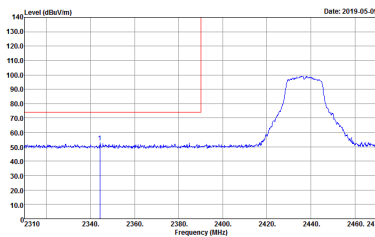
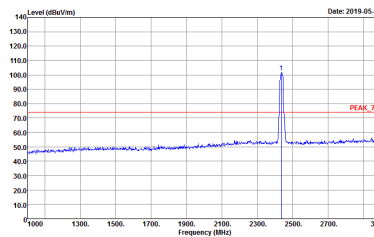
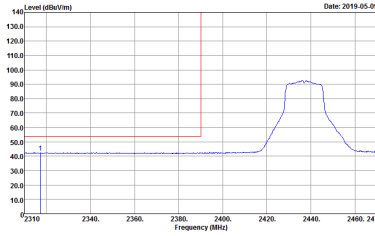
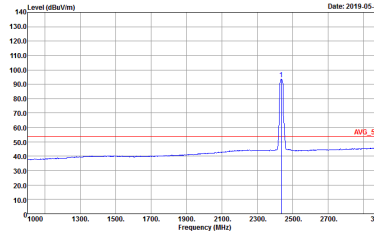

WIFI	2.4GHz 2400~2483.5MHz Band Edge @ 3m	
ANT	802.11g CH06 2437MHz - L	
1	Horizontal	Fundamental
Peak	 <p>Site : 03CH11-HY Condition : PEAK_BE_74 3m HORN 9120D-HF HORIZONTAL Detector : Peak Project : 942629</p>	 <p>Site : 03CH11-HY Condition : PEAK_74 3m HORN 9120D-HF HORIZONTAL Detector : Peak Project : 942629</p>
Avg.	 <p>Site : 03CH11-HY Condition : AVG_BE_54 3m HORN 9120D-HF HORIZONTAL Detector : Peak Project : 942629</p>	 <p>Site : 03CH11-HY Condition : AVG_54 3m HORN 9120D-HF HORIZONTAL Detector : Peak Project : 942629</p>

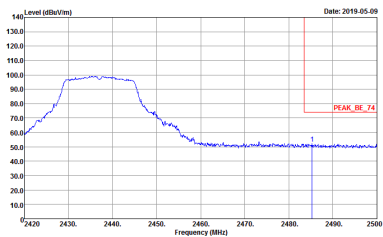
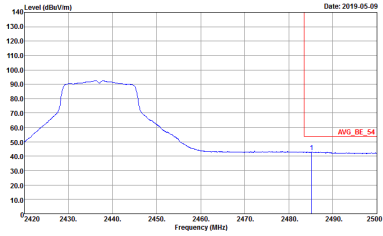

WIFI	2.4GHz 2400~2483.5MHz Band Edge @ 3m	
ANT	802.11g CH06 2437MHz - R	
1	Horizontal	Fundamental
Peak	 <p>Site : 03CH11-HY Condition : PEAK_BE_74 3m HORN 91200-HF HORIZONTAL Detector : Peak Project : 942629</p>	Left blank
Avg.	 <p>Site : 03CH11-HY Condition : AVG_BE_54 3m HORN 91200-HF HORIZONTAL Detector : Peak Project : 942629</p>	Left blank

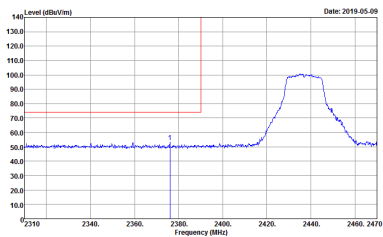
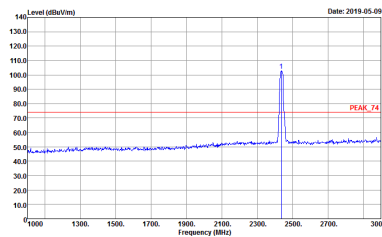
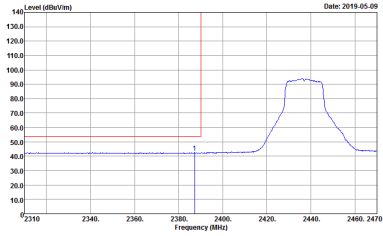
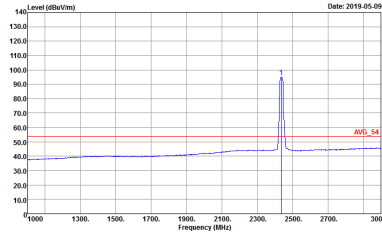

WIFI	2.4GHz 2400~2483.5MHz Band Edge @ 3m	
ANT	802.11g CH06 2437MHz - L	
1	Vertical	Fundamental
Peak	 <p>Date: 2019-05-09</p> <p>Site : 03CH11-HY Condition : PEAK_BE_74 3m HORN 9120D-HF VERTICAL : RBW:1000.000KHz VBW:3000.000KHz SWT:Auto Detector : Peak Project : 942629</p>	 <p>Date: 2019-05-09</p> <p>Site : 03CH11-HY Condition : PEAK_74 3m HORN 9120D-HF VERTICAL : RBW:1000.000KHz VBW:3000.000KHz SWT:Auto Detector : Peak Project : 942629</p>
Avg.	 <p>Date: 2019-05-09</p> <p>Site : 03CH11-HY Condition : AVG_BE_54 3m HORN 9120D-HF VERTICAL : RBW:1000.000KHz VBW:1000KHz SWT:Auto Detector : Peak Project : 942629</p>	 <p>Date: 2019-05-09</p> <p>Site : 03CH11-HY Condition : AVG_54 3m HORN 9120D-HF VERTICAL : RBW:1000.000KHz VBW:1000KHz SWT:Auto Detector : Peak Project : 942629</p>

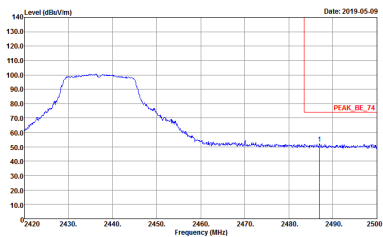
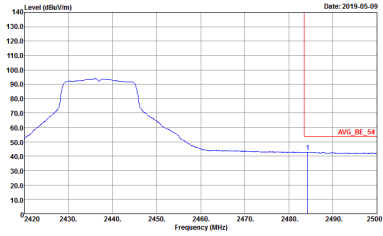

WIFI	2.4GHz 2400~2483.5MHz Band Edge @ 3m	
ANT	802.11g CH06 2437MHz - R	
1	Vertical	Fundamental
<p>Peak</p>	 <p>Site : 03CH11-HY Condition : PEAK_BE_74 3m HORN 91200-HF VERTICAL Detector : Peak Project : 942629</p>	<p>Left Blank</p>
<p>Avg.</p>	 <p>Site : 03CH11-HY Condition : AVG_BE_54 3m HORN 91200-HF VERTICAL Detector : Peak Project : 942629</p>	<p>Left Blank</p>

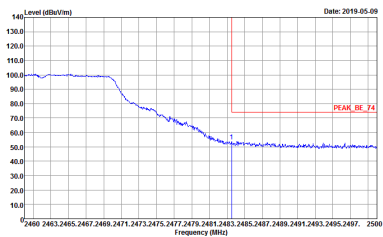
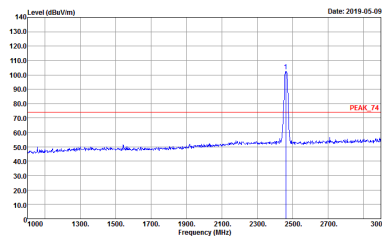
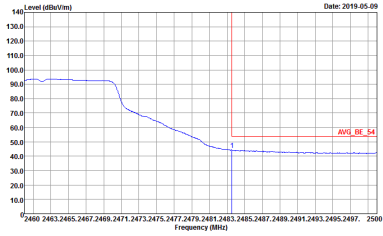
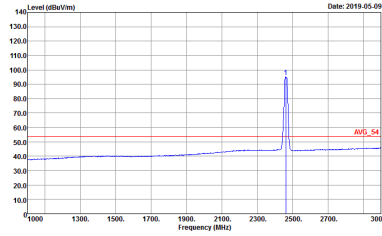

WIFI	2.4GHz 2400~2483.5MHz Band Edge @ 3m	
ANT	802.11g CH11 2462MHz	
1	Horizontal	Fundamental
Peak	 <p>Date: 2019-05-09</p> <p>Site : 03CH11-HY Condition : PEAK_BE_74 3m HORN 9120D-HF HORIZONTAL RBW:1000.000KHz VBW:3000.000KHz SWT:Auto Detector : Peak Project : 942629</p>	 <p>Date: 2019-05-09</p> <p>Site : 03CH11-HY Condition : PEAK_74 3m HORN 9120D-HF HORIZONTAL RBW:1000.000KHz VBW:3000.000KHz SWT:Auto Detector : Peak Project : 942629</p>
Avg.	 <p>Date: 2019-05-09</p> <p>Site : 03CH11-HY Condition : AVG_BE_54 3m HORN 9120D-HF HORIZONTAL RBW:1000.000KHz VBW:1000KHz SWT:Auto Detector : Peak Project : 942629</p>	 <p>Date: 2019-05-09</p> <p>Site : 03CH11-HY Condition : AVG_54 3m HORN 9120D-HF HORIZONTAL RBW:1000.000KHz VBW:1000KHz SWT:Auto Detector : Peak Project : 942629</p>

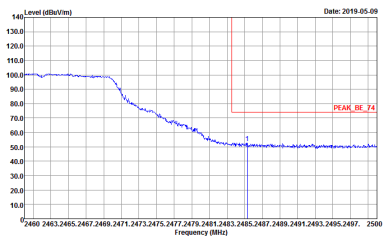
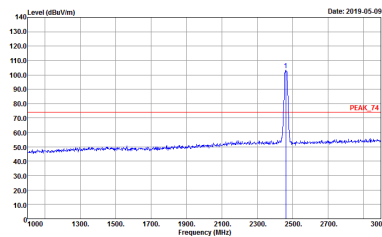
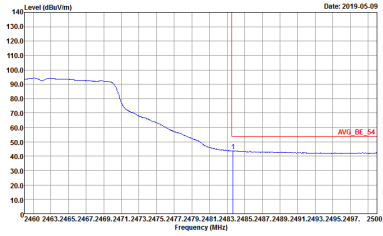
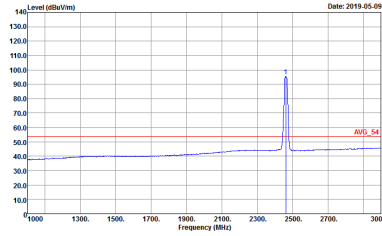

WIFI	2.4GHz 2400~2483.5MHz Band Edge @ 3m	
ANT	802.11g CH11 2462MHz	
1	Vertical	Fundamental
Peak	 <p>Site : 03CH11-HY Condition : PEAK_BE_74 3m HORN 91200-HF VERTICAL : RBW:1000.000KHz VBW:3000.000KHz SWT:Auto Detector : Peak Project : 942629</p>	 <p>Site : 03CH11-HY Condition : PEAK_74 3m HORN 91200-HF VERTICAL : RBW:1000.000KHz VBW:3000.000KHz SWT:Auto Detector : Peak Project : 942629</p>
Avg.	 <p>Site : 03CH11-HY Condition : AVG_BE_54 3m HORN 91200-HF VERTICAL : RBW:1000.000KHz VBW:1000KHz SWT:Auto Detector : Peak Project : 942629</p>	 <p>Site : 03CH11-HY Condition : AVG_54 3m HORN 91200-HF VERTICAL : RBW:1000.000KHz VBW:1000KHz SWT:Auto Detector : Peak Project : 942629</p>



2.4GHz 2400~2483.5MHz

WIFI 802.11n HT20 (Band Edge @ 3m)

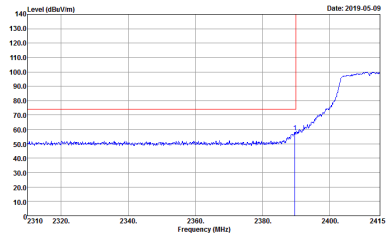
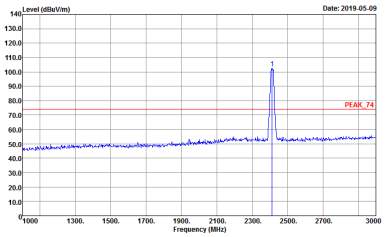
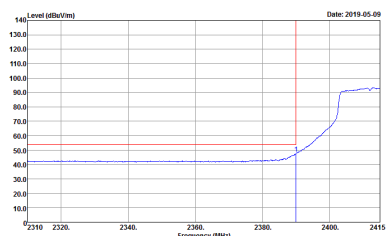
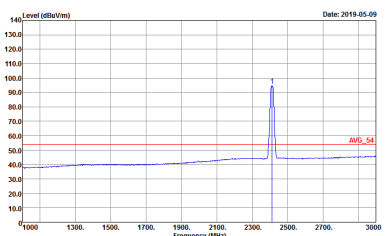
WIFI	2.4GHz 2400~2483.5MHz Band Edge @ 3m	
ANT	802.11n HT20 CH01 2412MHz	
1	Horizontal	Fundamental
Peak	 <p>Site : 03CH11-HY Condition : PEAK_BE_74 3m HORN 9120D-HF HORIZONTAL Detector : Peak Project : 942629</p>	 <p>Site : 03CH11-HY Condition : PEAK_74 3m HORN 9120D-HF HORIZONTAL Detector : Peak Project : 942629</p>
Avg.	 <p>Site : 03CH11-HY Condition : AV6_BE_54 3m HORN 9120D-HF HORIZONTAL Detector : Peak Project : 942629</p>	 <p>Site : 03CH11-HY Condition : AV6_54 3m HORN 9120D-HF HORIZONTAL Detector : Peak Project : 942629</p>

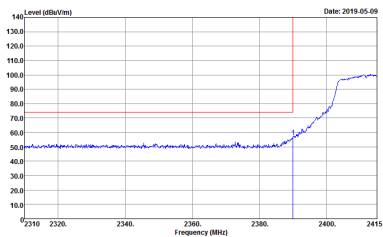
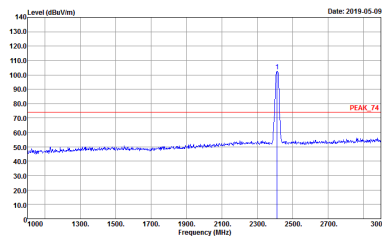
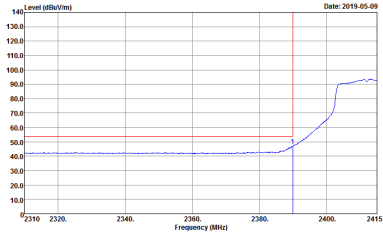
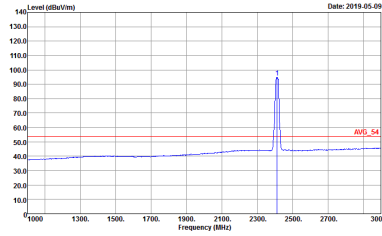

WIFI	2.4GHz 2400~2483.5MHz Band Edge @ 3m	
ANT	802.11n HT20 CH01 2412MHz	
1	Vertical	Fundamental
Peak	 <p>Site : 03CH11-HY Condition : PEAK_BE_74 3m HORN 91200-HF VERTICAL Detector : Peak Project : 942629</p>	 <p>Site : 03CH11-HY Condition : PEAK_74 3m HORN 91200-HF VERTICAL Detector : Peak Project : 942629</p>
Avg.	 <p>Site : 03CH11-HY Condition : AVG_BE_54 3m HORN 91200-HF VERTICAL Detector : Peak Project : 942629</p>	 <p>Site : 03CH11-HY Condition : AVG_54 3m HORN 91200-HF VERTICAL Detector : Peak Project : 942629</p>

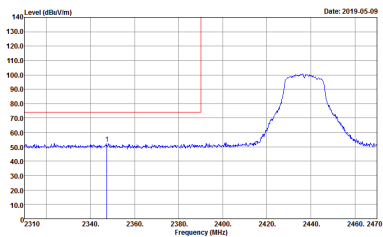
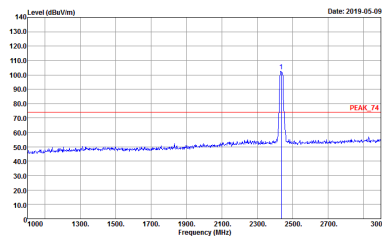
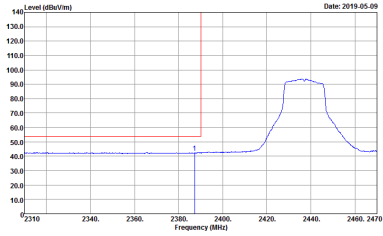
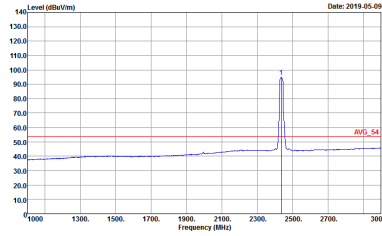

WIFI	2.4GHz 2400~2483.5MHz Band Edge @ 3m	
ANT	802.11n HT20 CH06 2437MHz - L	
1	Horizontal	Fundamental
Peak	 <p>Site : 03CH11-HY Condition : PEAK_BE_74 3m HORN 9120D-HF HORIZONTAL Detector : Peak Project : 942629</p>	 <p>Site : 03CH11-HY Condition : PEAK_74 3m HORN 9120D-HF HORIZONTAL Detector : Peak Project : 942629</p>
Avg.	 <p>Site : 03CH11-HY Condition : AVG_BE_54 3m HORN 9120D-HF HORIZONTAL Detector : Peak Project : 942629</p>	 <p>Site : 03CH11-HY Condition : AVG_54 3m HORN 9120D-HF HORIZONTAL Detector : Peak Project : 942629</p>

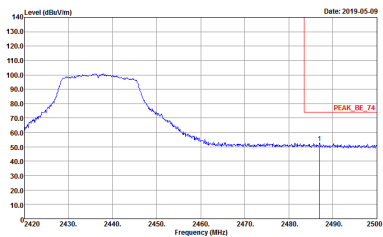
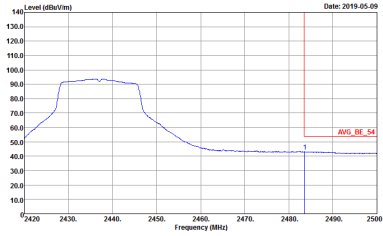

WIFI	2.4GHz 2400~2483.5MHz Band Edge @ 3m	
ANT	802.11n HT20 CH06 2437MHz - R	
1	Horizontal	Fundamental
<p>Peak</p>	 <p>Site : 03CH11-HY Condition : PEAK_BE_74 3m HORN 91200-HF HORIZONTAL Detector : Peak Project : 942629</p>	<p>Left blank</p>
<p>Avg.</p>	 <p>Site : 03CH11-HY Condition : AVG_BE_54 3m HORN 91200-HF HORIZONTAL Detector : Peak Project : 942629</p>	<p>Left blank</p>

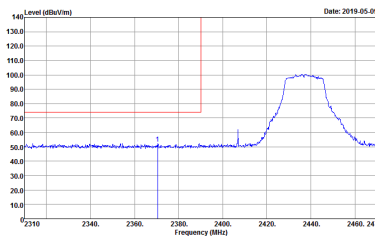
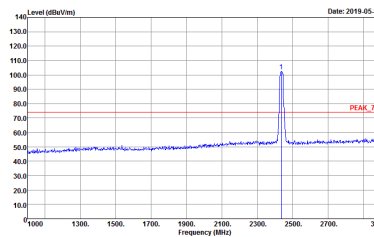
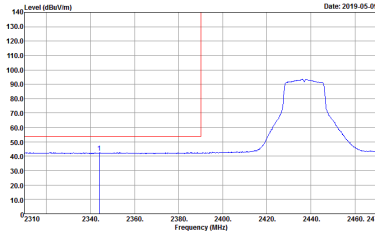
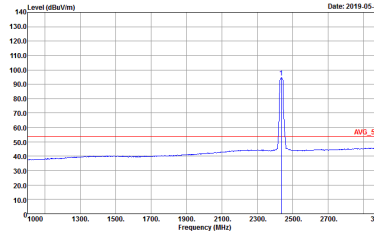

WIFI	2.4GHz 2400~2483.5MHz Band Edge @ 3m	
ANT	802.11n HT20 CH06 2437MHz - L	
1	Vertical	Fundamental
Peak	 <p>Date: 2019-05-09</p> <p>Site : 03CH11-HY Condition : PEAK_BE_74 3m HORN 9120D-HF VERTICAL : RBW:1000.000KHz VBW:3000.000KHz SWT:Auto Detector : Peak Project : 942629</p>	 <p>Date: 2019-05-09</p> <p>Site : 03CH11-HY Condition : PEAK_74 3m HORN 9120D-HF VERTICAL : RBW:1000.000KHz VBW:3000.000KHz SWT:Auto Detector : Peak Project : 942629</p>
Avg.	 <p>Date: 2019-05-09</p> <p>Site : 03CH11-HY Condition : AVG_BE_54 3m HORN 9120D-HF VERTICAL : RBW:1000.000KHz VBW:1000KHz SWT:Auto Detector : Peak Project : 942629</p>	 <p>Date: 2019-05-09</p> <p>Site : 03CH11-HY Condition : AVG_54 3m HORN 9120D-HF VERTICAL : RBW:1000.000KHz VBW:1000KHz SWT:Auto Detector : Peak Project : 942629</p>

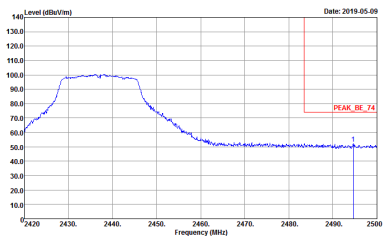
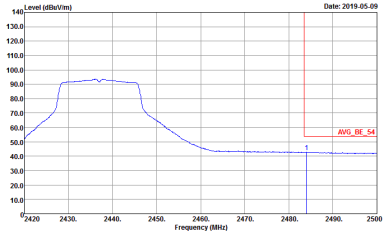

WIFI	2.4GHz 2400~2483.5MHz Band Edge @ 3m	
ANT	802.11n HT20 CH06 2437MHz - R	
1	Vertical	Fundamental
Peak	 <p>Site : 03CH11-HY Condition : PEAK_BE_74 3m HORN 91200-HF VERTICAL Detector : Peak Project : 942629</p>	Left Blank
Avg.	 <p>Site : 03CH11-HY Condition : AVG_BE_54 3m HORN 91200-HF VERTICAL Detector : Peak Project : 942629</p>	Left Blank

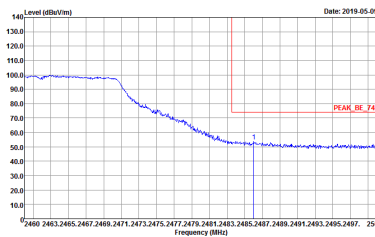
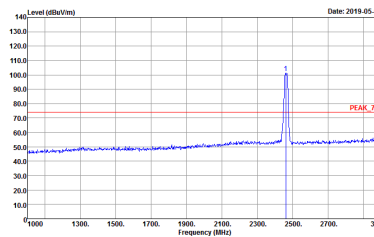
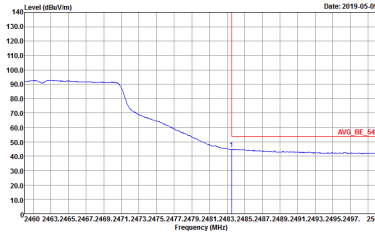
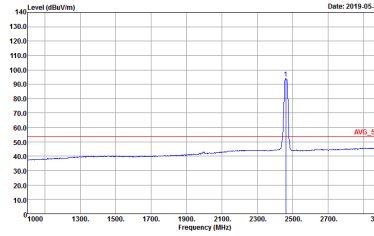

WIFI	2.4GHz 2400~2483.5MHz Band Edge @ 3m	
ANT	802.11n HT20 CH11 2462MHz	
1	Horizontal	Fundamental
Peak	 <p>Site : 03CH11-HY Condition : PEAK_BE_74 3m HORN 9120D-HF HORIZONTAL Detector : Peak Project : 942629</p>	 <p>Site : 03CH11-HY Condition : PEAK_74 3m HORN 9120D-HF HORIZONTAL Detector : Peak Project : 942629</p>
Avg.	 <p>Site : 03CH11-HY Condition : AVG_BE_54 3m HORN 9120D-HF HORIZONTAL Detector : Peak Project : 942629</p>	 <p>Site : 03CH11-HY Condition : AVG_54 3m HORN 9120D-HF HORIZONTAL Detector : Peak Project : 942629</p>

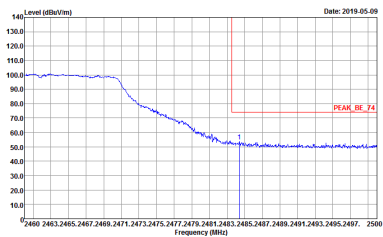
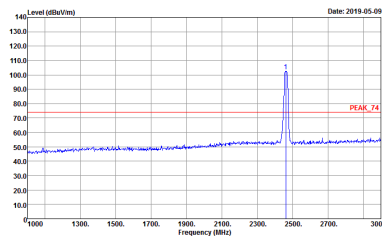
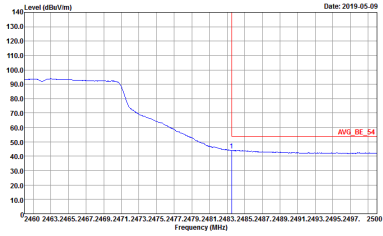
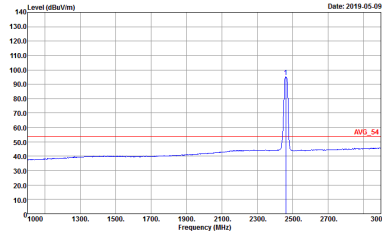

WIFI	2.4GHz 2400~2483.5MHz Fundamental @ 3m	
ANT	802.11n HT20 CH11 2462MHz	
1	Vertical	Fundamental
Peak	 <p>Site : 03CH11-HY Condition : PEAK_BE_74 3m HORN 91200-HF VERTICAL RBW:1000.000KHz VBW:3000.000KHz SWT:Auto Detector : Peak Project : 942629</p>	 <p>Site : 03CH11-HY Condition : PEAK_74 3m HORN 91200-HF VERTICAL RBW:1000.000KHz VBW:3000.000KHz SWT:Auto Detector : Peak Project : 942629</p>
Avg.	 <p>Site : 03CH11-HY Condition : AVG_BE_54 3m HORN 91200-HF VERTICAL RBW:1000.000KHz VBW:1000KHz SWT:Auto Detector : Peak Project : 942629</p>	 <p>Site : 03CH11-HY Condition : AVG_54 3m HORN 91200-HF VERTICAL RBW:1000.000KHz VBW:1000KHz SWT:Auto Detector : Peak Project : 942629</p>



2.4GHz 2400~2483.5MHz

WIFI 802.11b (Harmonic @ 3m)

WIFI	2.4GHz 2400~2483.5MHz Harmonic @ 3m	
ANT	802.11b CH01 2412MHz	
1	Horizontal	Vertical
<p>Peak</p> <p>Avg.</p>	<p>Site : 03CH11-HY Condition : PEAK_74 3m HORN 91200-HF HORIZONTAL Detector : Peak Project : 942629</p>	<p>Site : 03CH11-HY Condition : PEAK_74 3m HORN 91200-HF VERTICAL Detector : Peak Project : 942629</p>



WIFI	2.4GHz 2400~2483.5MHz Harmonic @ 3m	
ANT	802.11b CH06 2437MHz	
1	Horizontal	Vertical
Peak Avg.	<p>Site : 03CH11-11Y Condition : PEAK_74 3m HORN 91200-HF HORIZONTAL Detector : Peak Project : 942629</p>	<p>Site : 03CH11-11Y Condition : PEAK_74 3m HORN 91200-HF VERTICAL Detector : Peak Project : 942629</p>



WIFI	2.4GHz 2400~2483.5MHz Harmonic @ 3m	
ANT	802.11b CH11 2462MHz	
1	Horizontal	Vertical
Peak Avg.	<p>Site : 03CH11-11Y Condition : PEAK_74 3m HORN 91200-HF HORIZONTAL Detector : Peak Project : 942629</p>	<p>Site : 03CH11-11Y Condition : PEAK_74 3m HORN 91200-HF VERTICAL Detector : Peak Project : 942629</p>



2.4GHz 2400~2483.5MHz

WIFI 802.11g (Harmonic @ 3m)

WIFI	2.4GHz 2400~2483.5MHz Harmonic @ 3m	
ANT	802.11g CH01 2412MHz	
1	Horizontal	Vertical
<p>Peak</p> <p>Avg.</p>	<p>Site : 03CH11-HY Condition : PEAK_74 3m HORN 91200-HF HORIZONTAL Detector : Peak Project : 942629</p>	<p>Site : 03CH11-HY Condition : PEAK_74 3m HORN 91200-HF VERTICAL Detector : Peak Project : 942629</p>



WIFI	2.4GHz 2400~2483.5MHz Harmonic @ 3m	
ANT	802.11g CH06 2437MHz	
1	Horizontal	Vertical
Peak Avg.	<p>Site : 03CH11-11Y Condition : PEAK_74 3m HORN 91200-HF HORIZONTAL Detector : Peak Project : 942629</p>	<p>Site : 03CH11-11Y Condition : PEAK_74 3m HORN 91200-HF VERTICAL Detector : Peak Project : 942629</p>

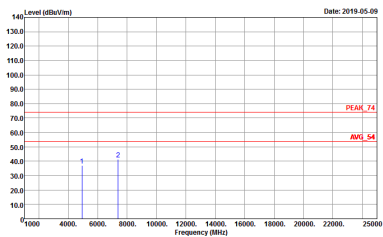
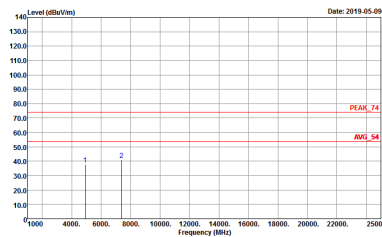

WIFI	2.4GHz 2400~2483.5MHz Harmonic @ 3m	
ANT	802.11g CH11 2462MHz	
1	Horizontal	Vertical
<p>Peak</p> <p>Avg.</p>	 <p>Site : 03CH11-11Y Condition : PEAK_74 3m HORN 91200-HF HORIZONTAL Detector : Peak Project : 942629</p>	 <p>Site : 03CH11-11Y Condition : PEAK_74 3m HORN 91200-HF VERTICAL Detector : Peak Project : 942629</p>



2.4GHz 2400~2483.5MHz

WIFI 802.11n HT20 (Harmonic @ 3m)

WIFI	2.4GHz 2400~2483.5MHz Harmonic @ 3m	
ANT	802.11n HT20 CH01 2412MHz	
1	Horizontal	Vertical
<p>Peak</p> <p>Avg.</p>	<p>Site : 03CH11-HY Condition : PEAK_74 3m HORN 91200-HF HORIZONTAL Detector : Peak Project : 942629</p>	<p>Site : 03CH11-HY Condition : PEAK_74 3m HORN 91200-HF VERTICAL Detector : Peak Project : 942629</p>



WIFI	2.4GHz 2400~2483.5MHz Harmonic @ 3m	
ANT	802.11n HT20 CH06 2437MHz	
1	Horizontal	Vertical
Peak Avg.	<p>Site : 03CH11-11Y Condition : PEAK_74 3m HORN 91200-HF HORIZONTAL Detector : Peak Project : 942629</p>	<p>Site : 03CH11-11Y Condition : PEAK_74 3m HORN 91200-HF VERTICAL Detector : Peak Project : 942629</p>



WIFI	2.4GHz 2400~2483.5MHz Harmonic @ 3m	
ANT	802.11n HT20 CH11 2462MHz	
1	Horizontal	Vertical
<p>Peak</p> <p>Avg.</p>	<p>Site : 03CH11-11Y Condition : PEAK_74 3m HORN 91200-HF HORIZONTAL Detector : Peak Project : 942629</p>	<p>Site : 03CH11-11Y Condition : PEAK_74 3m HORN 91200-HF VERTICAL Detector : Peak Project : 942629</p>



Emission below 1GHz
2.4GHz WIFI 802.11n HT20 (LF)

WIFI	2.4GHz 2400~2483.5MHz	
ANT	802.11n HT20 LF	
1	Horizontal	Vertical
QP / Peak	<p>Site : 03CH11-11Y Condition : QP 3m BE-LOG 6111D-LF_ETC HORIZONTAL Detector : Peak Project : 942629</p>	<p>Site : 03CH11-11Y Condition : QP 3m BE-LOG 6111D-LF_ETC VERTICAL Detector : Peak Project : 942629</p>



Appendix E. Duty Cycle Plots

Band	Duty Cycle (%)	T(us)	1/T(kHz)	VBW Setting	Duty Factor (dB)
802.11b	98.77	-	-	10Hz	0.05
802.11g	97.87	2070.00	0.48	1kHz	0.09
2.4GHz 802.11n HT20	97.97	1935.00	0.52	1kHz	0.09

802.11b

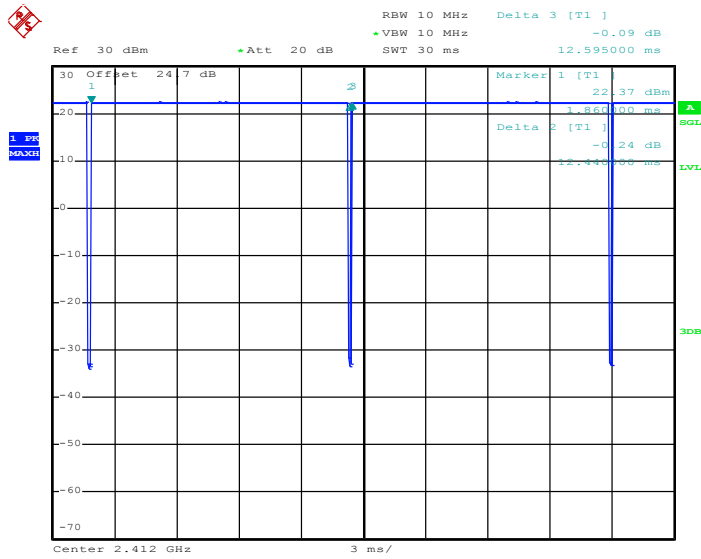

Date: 7.MAY.2019 14:40:47



802.11g

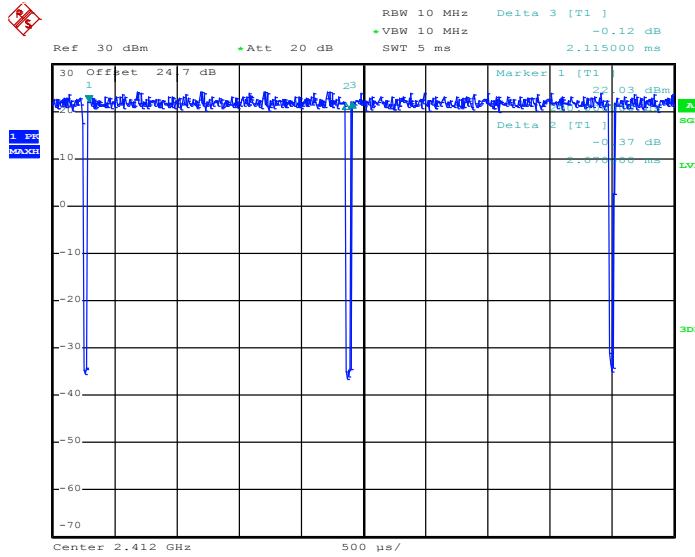

Date: 7.MAY.2019 14:42:58

802.11n HT20

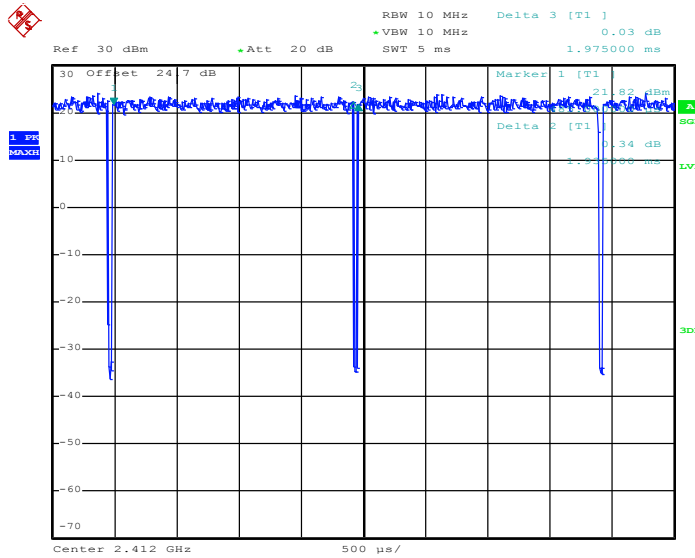

Date: 7.MAY.2019 14:44:50

————THE END————