



FCC RADIO TEST REPORT

FCC ID : IHDT56YC1
Equipment : Mobile Cellular Phone
Brand Name : Motorola
Model name : XT2010-1
Applicant : Motorola Mobility LLC
222 W,Merchandise Mart Plaza, Chicago IL
60654 USA
Manufacturer : Motorola Mobility LLC
222 W,Merchandise Mart Plaza, Chicago IL
60654 USA
Standard : FCC Part 15 Subpart E §15.407

The product was received on Apr. 26, 2019 and testing was started from May 07, 2019 and completed on May 27, 2019. We, SPORTON INTERNATIONAL INC., EMC & Wireless Communications Laboratory, would like to declare that the tested sample has been evaluated in accordance with the test procedures and has been in compliance with the applicable technical standards.

The report must not be used by the client to claim product certification, approval, or endorsement by TAF or any agency of government.

The test results in this report apply exclusively to the tested model / sample. Without written approval of SPORTON INTERNATIONAL INC. EMC & Wireless Communications Laboratory, the test report shall not be reproduced except in full.

Approved by: Jones Tsai

SPORTON INTERNATIONAL INC. EMC & Wireless Communications Laboratory

No. 52, Huaya 1st Rd., Guishan Dist., Taoyuan City, Taiwan (R.O.C.)



Table of Contents

History of this test report	3
Summary of Test Result	4
1 General Description	5
1.1 Product Feature of Equipment Under Test.....	5
1.2 Product Specification of Equipment Under Test.....	7
1.3 Modification of EUT.....	7
1.4 Testing Location.....	8
1.5 Applicable Standards	8
2 Test Configuration of Equipment Under Test	9
2.1 Carrier Frequency and Channel	9
2.2 Test Mode	10
2.3 Connection Diagram of Test System.....	11
2.4 Support Unit used in test configuration and system	12
2.5 EUT Operation Test Setup	12
2.6 Measurement Results Explanation Example.....	12
3 Test Result.....	13
3.1 6dB and 26dB and 99% Occupied Bandwidth Measurement	13
3.2 Maximum Conducted Output Power Measurement	16
3.3 Power Spectral Density Measurement	17
3.4 Unwanted Emissions Measurement	19
3.5 AC Conducted Emission Measurement.....	24
3.6 Automatically Discontinue Transmission	26
3.7 Antenna Requirements	27
4 List of Measuring Equipment	28
5 Uncertainty of Evaluation	30
Appendix A. Conducted Test Results	
Appendix B. AC Conducted Emission Test Result	
Appendix C. Radiated Spurious Emission	
Appendix D. Radiated Spurious Emission Plots	
Appendix E. Duty Cycle Plots	



History of this test report

Report No.	Version	Description	Issued Date
FR942629F	01	Initial issue of report	Jun. 06, 2019



Summary of Test Result

Report Clause	Ref Std. Clause	Test Items	Result (PASS/FAIL)	Remark
3.1	15.403 (i)	6dB & 26dB Bandwidth	Pass	-
3.1	2.1049	99% Occupied Bandwidth	Reporting only	-
3.2	15.407 (a)	Maximum Conducted Output Power	Pass	-
3.3	15.407 (a)	Power Spectral Density	Pass	-
3.4	15.407(b)	Unwanted Emissions	Pass	Under limit 6.78 dB at 30.000 MHz
3.5	15.207	AC Conducted Emission	Pass	Under limit 18.20 dB at 0.575 MHz
3.6	15.407 (c)	Automatically Discontinue Transmission	Pass	-
3.7	15.203 & 15.407 (a)	Antenna Requirement	Pass	-

Declaration of Conformity:

The test results with all measurement uncertainty excluded are presented in accordance with the regulation limits or requirements declared by manufacturers.

Comments and Explanations:

The declared of product specification for EUT presented in the report are provided by the manufacturer, and the manufacturer takes all the responsibilities for the accuracy of product specification.

Reviewed by: Wii Chang

Report Producer: Dara Chiu



1 General Description

1.1 Product Feature of Equipment Under Test

Product Feature	
Equipment	Mobile Cellular Phone
Brand Name	Motorola
Model Name	XT2010-1
FCC ID	IHDT56YC1
Sample 1	Single SIM
Sample 2	Dual SIM
IMEI Code	Conducted : IMEI: 354156100004763 Conduction : IMEI: 354156100005315 Radiation : IMEI: 354156100005430
EUT supports Radios application	GSM/EGPRS/WCDMA/HSPA/LTE/GNSS/NFC/FM WLAN 11b/g/n HT20 WLAN 11a/n HT20/HT40 WLAN 11ac VHT20/VHT40/VHT80 Bluetooth BR/EDR/LE
HW Version	DVT2A
EUT Stage	Identical Prototype

Remark: The above EUT's information was declared by manufacturer.



Accessory List	
AC Adapter 1 (US)	Brand Name : Motorola
	Model Name : SC-51
	Manufacturer : Salom
AC Adapter 1 (EU)	Brand Name : Motorola
	Model Name : SC-52
	Manufacturer : Salom
AC Adapter 1 (UK)	Brand Name : Motorola
	Model Name : SC-53
	Manufacturer : Salom
AC Adapter 1 (AR)	Brand Name : Motorola
	Model Name : SC-56
	Manufacturer : Salom
AC Adapter 1 (BR)	Brand Name : Motorola
	Model Name : SC-57
	Manufacturer : Salom
AC Adapter 2 (US)	Brand Name : Motorola
	Model Name : SC-51
	Manufacturer : Chenyang
AC Adapter 2 (EU)	Brand Name : Motorola
	Model Name : SC-52
	Manufacturer : Chenyang
AC Adapter 2 (UK)	Brand Name : Motorola
	Model Name : SC-53
	Manufacturer : Chenyang
AC Adapter 2 (AR)	Brand Name : Motorola
	Model Name : SC-56
	Manufacturer : Chenyang
AC Adapter 3 (BR)	Brand Name : Motorola
	Model Name : SC-57
	Manufacturer : Flex
AC Adapter 4 (BR)	Brand Name : Motorola
	Model Name : SC-57
	Manufacturer : Cliptech
Battery 1	Brand Name : Motorola
	Model Name : KP50
	Manufacturer : SCUD
Earphone 1	Brand Name : Motorola
	Model Name : SH38C37773
	Manufacturer : Lianyun
Earphone 2	Brand Name : Motorola
	Model Name : SH38C44959
	Manufacturer : Cosonic
USB Cable 1	Brand Name : Luxshare
	Model Name : SC18C24368
USB Cable 2	Brand Name : Saibao
	Model Name : SC18C24367



1.2 Product Specification of Equipment Under Test

Standards-related Product Specification	
Tx/Rx Channel Frequency Range	5745 MHz ~ 5825 MHz
Maximum Output Power	802.11a : 16.90 dBm / 0.0490 W 802.11n HT20 : 15.80 dBm / 0.0380 W 802.11n HT40 : 15.70 dBm / 0.0372 W 802.11ac VHT20 : 14.70 dBm / 0.0295 W 802.11ac VHT40 : 14.60 dBm / 0.0288 W 802.11ac VHT80 : 14.90 dBm / 0.0309 W
99% Occupied Bandwidth	802.11a : 16.75 MHz 802.11n HT20 : 17.95 MHz 802.11n HT40 : 36.60 MHz 802.11 ac VHT80 : 76.92 MHz
Antenna Type / Gain	Loop Antenna type with gain -8.00 dBi
Type of Modulation	802.11a/n : OFDM (BPSK / QPSK / 16QAM / 64QAM) 802.11ac: OFDM (BPSK / QPSK / 16QAM / 64QAM / 256QAM)

1.3 Modification of EUT

No modifications are made to the EUT during all test items.



1.4 Testing Location

Test Site	SPORTON INTERNATIONAL INC.	
Test Site Location	No.52, Huaya 1st Rd., Guishan Dist., Taoyuan City, Taiwan (R.O.C.) TEL: +886-3-327-3456 FAX: +886-3-328-4978	
Test Site No.	Sporton Site No.	
	TH05-HY	CO05-HY

Note: The test site complies with ANSI C63.4 2014 requirement.

Test Site	SPORTON INTERNATIONAL INC.	
Test Site Location	No.58, Aly. 75, Ln. 564, Wenhua 3rd, Rd., Guishan Dist., Taoyuan City, Taiwan (R.O.C.) TEL: +886-3-327-0868 FAX: +886-3-327-0855	
Test Site No.	Sporton Site No.	
	03CH15-HY	

Note: The test site complies with ANSI C63.4 2014 requirement.

FCC designation No.: TW1190 and TW0007

1.5 Applicable Standards

According to the specifications of the manufacturer, the EUT must comply with the requirements of the following standards:

- ♦ FCC Part 15 Subpart E
- ♦ FCC KDB 789033 D02 General UNII Test Procedures New Rules v02r01.
- ♦ FCC KDB 414788 D01 Radiated Test Site v01r01.
- ♦ ANSI C63.10-2013

Remark:

1. All test items were verified and recorded according to the standards and without any deviation during the test.
2. This EUT has also been tested and complied with the requirements of FCC Part 15, Subpart B, recorded in a separate test report.



2 Test Configuration of Equipment Under Test

- a. The EUT has been associated with peripherals and configuration operated in a manner tended to maximize its emission characteristics in a typical application. Frequency range investigated: conduction emission (150 kHz to 30 MHz), radiation emission (9 kHz to the 10th harmonic of the highest fundamental frequency or to 40 GHz, whichever is lower). For radiated measurement, pre-scanned in three orthogonal panels, X, Y, Z. The worst cases (X plane) were recorded in this report.

- b. AC power line Conducted Emission was tested under maximum output power.

2.1 Carrier Frequency and Channel

Frequency Band	Channel	Freq. (MHz)	Channel	Freq. (MHz)
5725-5850 MHz Band 4 (U-NII-3)	149	5745	157	5785
	151*	5755	159*	5795
	153	5765	161	5805
	155#	5775	165	5825

Note:

- 1. The above Frequency and Channel in "*" were 802.11n HT40 and 802.11ac VHT40.
- 2. The above Frequency and Channel in "#n" were 802.11ac VHT80.



2.2 Test Mode

Final test modes are considering the modulation and worse data rates as below table.

Modulation	Data Rate
802.11a	6 Mbps
802.11n HT20	MCS0
802.11n HT40	MCS0
802.11ac VHT20 (Covered by HT20)	MCS0
802.11ac VHT40 (Covered by HT40)	MCS0
802.11ac VHT80	MCS0

Test Cases	
AC Conducted Emission	Mode 1: LTE Band 12 Low Channel Idle + Bluetooth Link + WLAN (5GHz) Link + Camera (Back) + Battery + Earphone 2 + USB Cable 2 (Charging from AC Adapter 4 (Cliptech_BR)) for Sample 1
Remark: For Radiated Test Cases, the tests were performed with AC Adapter 1 (Salom_US), Earphone 1, USB Cable 1, and Sample 1	

Ch. #	Band IV : 5725-5850 MHz			
	802.11a	802.11n HT20	802.11n HT40	802.11ac VHT80
L Low	149	149	151	-
M Middle	157	157	-	155
H High	165	165	159	-

2.3 Connection Diagram of Test System

<WLAN Tx Mode>

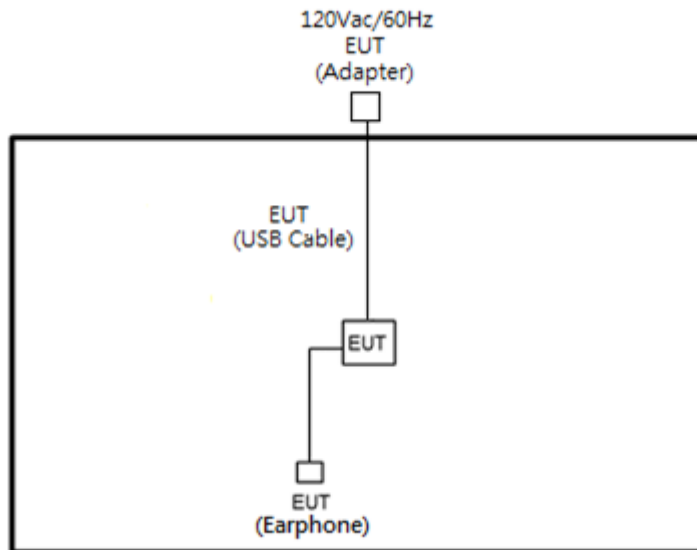

<AC Conducted Emission Mode>

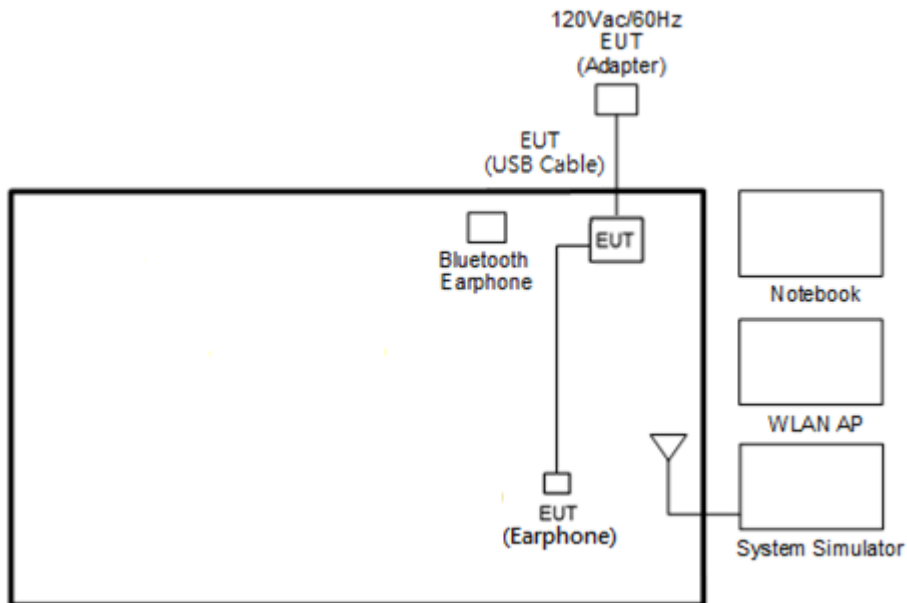



2.4 Support Unit used in test configuration and system

Item	Equipment	Trade Name	Model Name	FCC ID	Data Cable	Power Cord
1.	System Simulator	Anritsu	MT8820C	N/A	N/A	Unshielded, 1.8 m
2.	Bluetooth Earphone	Sony Ericsson	MW600	PY7DDA-2029	N/A	N/A
3.	WLAN AP	ASUS	RT-AC66U	MSQ-RTAC66U	N/A	Unshielded, 1.8 m
4.	Notebook	DELL	Latitude E6320	FCC DoC/ Contains FCC ID: QDS-BRCM1054	N/A	AC I/P: Unshielded, 1.2 m DC O/P: Shielded, 1.8 m
5.	SD Card	SanDisk	MicroSD HC	FCC DoC	N/A	N/A

2.5 EUT Operation Test Setup

The RF test items, utility "QDART_WIN_4_8_Installer_00064_1 qpst.win.2.7_installer_00471.4" was installed in Notebook which was programmed in order to make the EUT get into the engineering modes to provide channel selection, power level, data rate and the application type and for continuous transmitting signals.

2.6 Measurement Results Explanation Example

For all conducted test items:

The offset level is set in the spectrum analyzer to compensate the RF cable loss and attenuator factor between EUT conducted output port and spectrum analyzer. With the offset compensation, the spectrum analyzer reading level is exactly the EUT RF output level.

Example :

The spectrum analyzer offset is derived from RF cable loss and attenuator factor.

Offset = RF cable loss + attenuator factor.

Following shows an offset computation example with cable loss 4.2 dB and 10dB attenuator.

$$\begin{aligned} \text{Offset(dB)} &= \text{RF cable loss(dB)} + \text{attenuator factor(dB)}. \\ &= 4.2 + 10 = 14.2 \text{ (dB)} \end{aligned}$$

3 Test Result

3.1 6dB and 26dB and 99% Occupied Bandwidth Measurement

3.1.1 Description of 6dB and 26dB and 99% Occupied Bandwidth

The minimum 6 dB bandwidth shall be at least 500 kHz.

26dB and 99% Occupied bandwidth are reporting only.

3.1.2 Measuring Instruments

See list of measuring equipment of this test report.

3.1.3 Test Procedures

1. The testing follows FCC KDB 789033 D02 General UNII Test Procedures New Rules v02r01. Section C) Emission bandwidth for the band 5.725-5.85GHz
2. Set RBW = 100kHz.
3. Set the VBW $\geq 3 \times$ RBW.
4. Detector = Peak.
5. Trace mode = max hold
6. Measure the maximum width of the emission that is 6 dB down from the peak of the emission.
7. Measure and record the results in the test report.

3.1.4 Test Setup

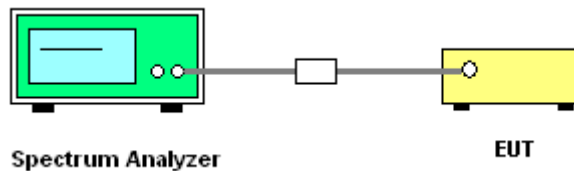

3.1.5 Test Result of 6dB and 26dB and 99% Occupied Bandwidth

Please refer to Appendix A.

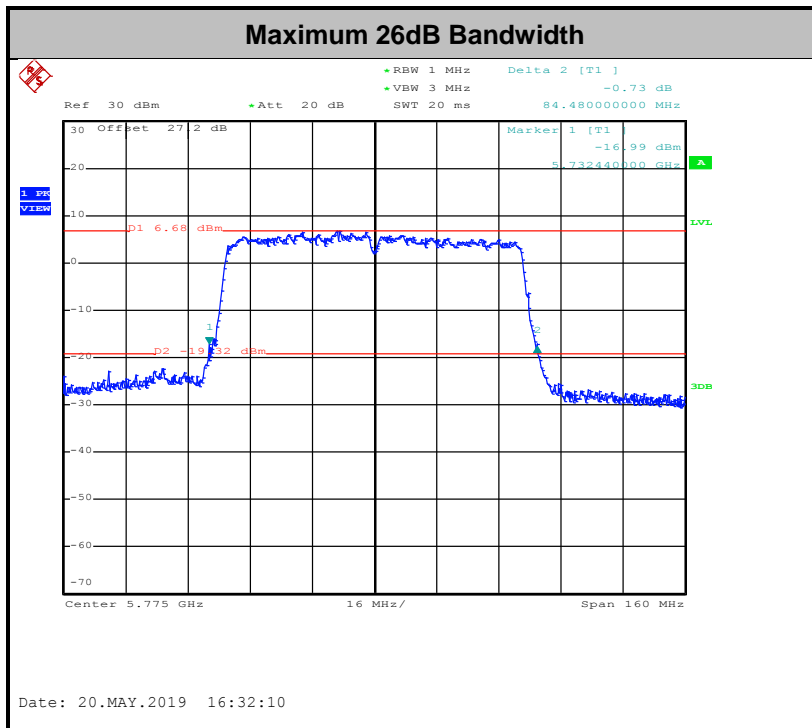
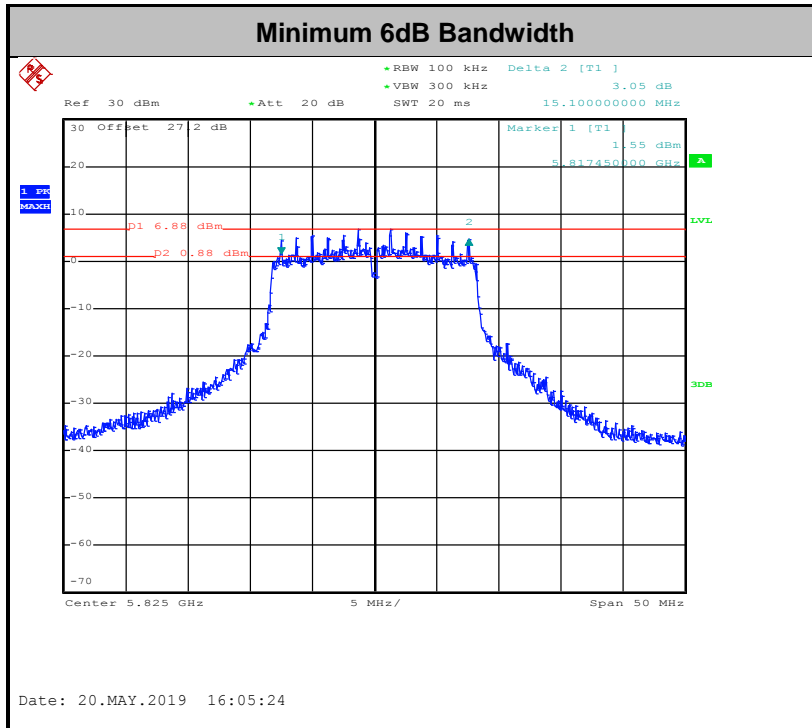

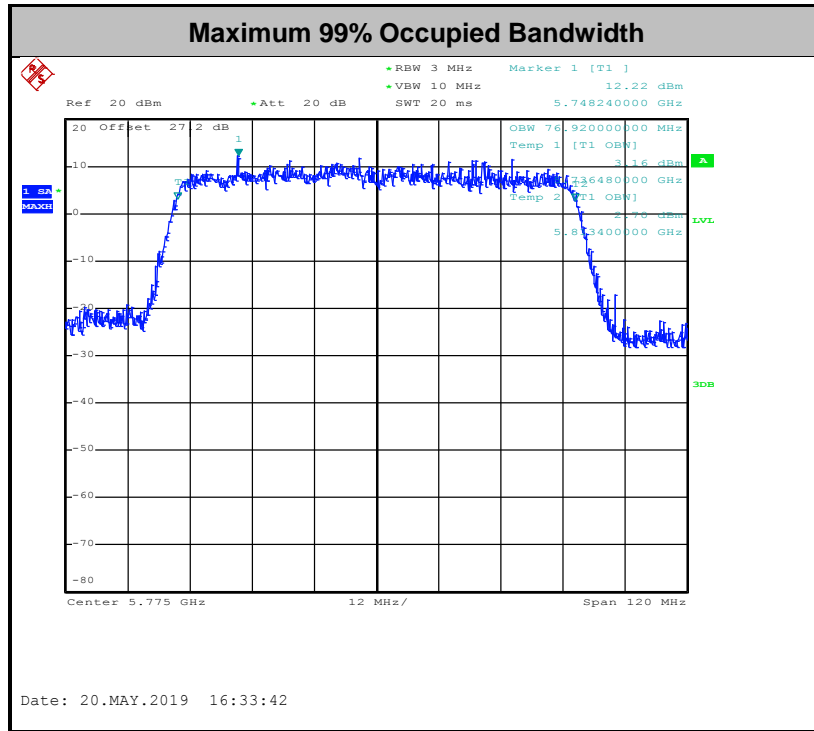

Note: The occupied channel bandwidth is maintained within the band of operation for all of the modulations.

3.2 Maximum Conducted Output Power Measurement

3.2.1 Limit of Maximum Conducted Output Power

For the band 5.725–5.85 GHz, the maximum conducted output power over the frequency band of operation shall not exceed 1 W.

If transmitting antennas of directional gain greater than 6 dBi are used, the peak output power shall be reduced by the amount in dB that the directional gain of the antenna exceeds 6 dBi.

3.2.2 Measuring Instruments

See list of measuring equipment of this test report.

3.2.3 Test Procedures

The testing follows Method PM-G of FCC KDB 789033 D02 General UNII Test Procedures New Rules v02r01.

Method PM-G (Measurement using a gated RF average power meter):

1. Measurement is performed using a wideband RF power meter.
2. The EUT is configured to transmit at its maximum power control level.
3. Measure the average power of the transmitter
4. Since the measurement is made only during the ON time of the transmitter, no duty cycle correction factor is required.

3.2.4 Test Setup

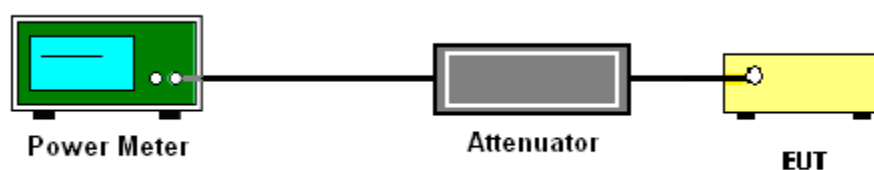

3.2.5 Test Result of Maximum Conducted Output Power

Please refer to Appendix A.



3.3 Power Spectral Density Measurement

3.3.1 Limit of Power Spectral Density

For the band 5.725–5.85 GHz, the maximum power spectral density shall not exceed 30 dBm in any 500-kHz band.

If transmitting antennas of directional gain greater than 6 dBi are used, the peak output power shall be reduced by the amount in dB that the directional gain of the antenna exceeds 6 dBi.

3.3.2 Measuring Instruments

See list of measuring equipment of this test report.

3.3.3 Test Procedures

The testing follows FCC KDB 789033 D02 General UNII Test Procedures New Rules v02r01. Section F) Maximum power spectral density.

Method SA-2

(trace averaging across on and off times of the EUT transmissions, followed by duty cycle correction).

- Measure the duty cycle.
 - Set span to encompass the entire emission bandwidth (EBW) of the signal.
 - Set RBW = 300 kHz.
 - Set VBW \geq 1 MHz.
 - Number of points in sweep \geq 2 Span / RBW.
 - Sweep time = auto.
 - Detector = RMS
 - Trace average at least 100 traces in power averaging mode.
 - Add $10 \log(500\text{kHz}/\text{RBW})$ to the test result.
 - Add $10 \log(1/x)$, where x is the duty cycle, to the measured power in order to compute the average power during the actual transmission times. For example, add $10 \log(1/0.25) = 6$ dB if the duty cycle is 25 percent.
1. The RF output of EUT was connected to the spectrum analyzer by a low loss cable.
 2. Each plot has already offset with cable loss, and attenuator loss. Measure the PPSD and record it.



3.4 Unwanted Emissions Measurement

This section is to measure unwanted emissions through radiated measurement for band edge spurious emissions and out of band emissions measurement.

3.4.1 Limit of Unwanted Emissions

(1) For transmitters operating in the 5.725-5.85 GHz band:

15.407(b)(4)(i) All emissions shall be limited to a level of -27 dBm/MHz at 75 MHz or more above or below the band edge increasing linearly to 10 dBm/MHz at 25 MHz above or below the band edge, and from 25 MHz above or below the band edge increasing linearly to a level of 15.6 dBm/MHz at 5 MHz above or below the band edge, and from 5 MHz above or below the band edge increasing linearly to a level of 27 dBm/MHz at the band edge.

(2) Unwanted spurious emissions fallen in restricted bands shall comply with the general field strength limits as below table,

Frequency (MHz)	Field Strength (microvolts/meter)	Measurement Distance (meters)
0.009 – 0.490	2400/F(kHz)	300
0.490 – 1.705	24000/F(kHz)	30
1.705 – 30.0	30	30
30 – 88	100	3
88 – 216	150	3
216 - 960	200	3
Above 960	500	3

Note: The following formula is used to convert the EIRP to field strength.

$$E = \frac{1000000\sqrt{30P}}{3} \text{ } \mu\text{V/m, where P is the eirp (Watts)}$$

EIRP (dBm)	Field Strength at 3m (dBμV/m)
- 27	68.3



- (3) KDB789033 D02 v02r01 G)2)c)
 - (i) Section 15.407(b)(1) to (b)(3) specify the unwanted emission limits for the U-NII-1 and U-NII-2 bands. As specified, emissions above 1000 MHz that are outside of the restricted bands are subject to a peak emission limit of -27 dBm/MHz.³
 - (ii) Section 15.407(b)(4) specifies the unwanted emission limit for the U-NII-3 band. A band emissions mask is specified in Section 15.407(b)(4)(i). The emission limits are in terms of a Peak detector. An alternative to the band emissions mask is specified in Section 15.407(b)(4)(ii). The alternative limits are based on the highest antenna gain specified in the filing. There are also marketing and importation restrictions for the devices using the alternative limit.⁴

Note 3: An out-of-band emission that complies with both the average and peak limits of Section 15.209 is not required to satisfy the -27 dBm/MHz peak emission limit.

Note 4: Only devices with antenna gains of 10 dBi or less may be approved using the emission limits specified in Section 15.247(d) till March 2, 2018; all other devices operating in this band must use the mask specified in Section 15.407(b)(4)(i).

3.4.2 Measuring Instruments

See list of measuring equipment of this test report.

3.4.3 Test Procedures

1. The testing follows FCC KDB 789033 D02 General UNII Test Procedures New Rules v02r01. Section G) Unwanted emissions measurement.
 - (1) Procedure for Unwanted Emissions Measurements Below 1000MHz
 - RBW = 120 kHz
 - VBW = 300 kHz
 - Detector = Peak
 - Trace mode = max hold
 - (2) Procedure for Peak Unwanted Emissions Measurements Above 1000 MHz
 - RBW = 1 MHz
 - VBW ≥ 3 MHz
 - Detector = Peak
 - Sweep time = auto
 - Trace mode = max hold
 - (3) Procedures for Average Unwanted Emissions Measurements Above 1000MHz
 - RBW = 1 MHz
 - VBW = 10 Hz, when duty cycle is no less than 98 percent.
 - VBW ≥ 1/T, when duty cycle is less than 98 percent where T is the minimum transmission duration over which the transmitter is on and is transmitting at its maximum power control level for the tested mode of operation.

2. The EUT was placed on a turntable with 0.8 meter for frequency below 1GHz and 1.5 meter for frequency above 1GHz respectively above ground.
3. The EUT was set 3 meters from the interference receiving antenna which was mounted on the top of a variable height antenna tower.
4. The antenna is a broadband antenna and its height is adjusted between one meter and four meters above ground to find the maximum value of the field strength for both horizontal polarization and vertical polarization of the antenna.
5. For each suspected emission, the EUT was arranged to its worst case and then adjust the antenna tower (from 1 m to 4 m) and turntable (from 0 degree to 360 degrees) to find the maximum reading.
6. For testing below 1GHz, if the emission level of the EUT in peak mode was 3 dB lower than the limit specified, then peak values of EUT will be reported, otherwise, the emissions will be repeated one by one using the CISPR quasi-peak method and reported.
7. For testing above 1GHz, the emission level of the EUT in peak mode was 20dB lower than average limit (that means the emission level in average mode also complies with the limit in average mode), then peak values of EUT will be reported, otherwise, the emissions will be measured in average mode again and reported.

3.4.4 Test Setup

For radiated emissions below 30MHz

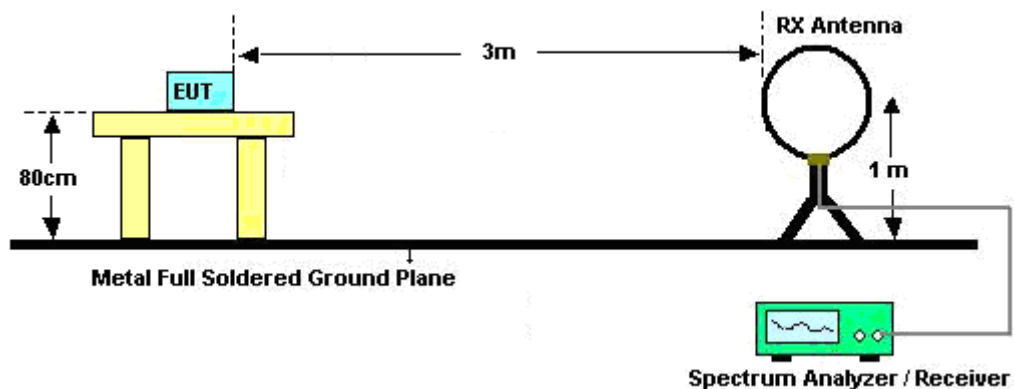

For radiated emissions from 30MHz to 1GHz

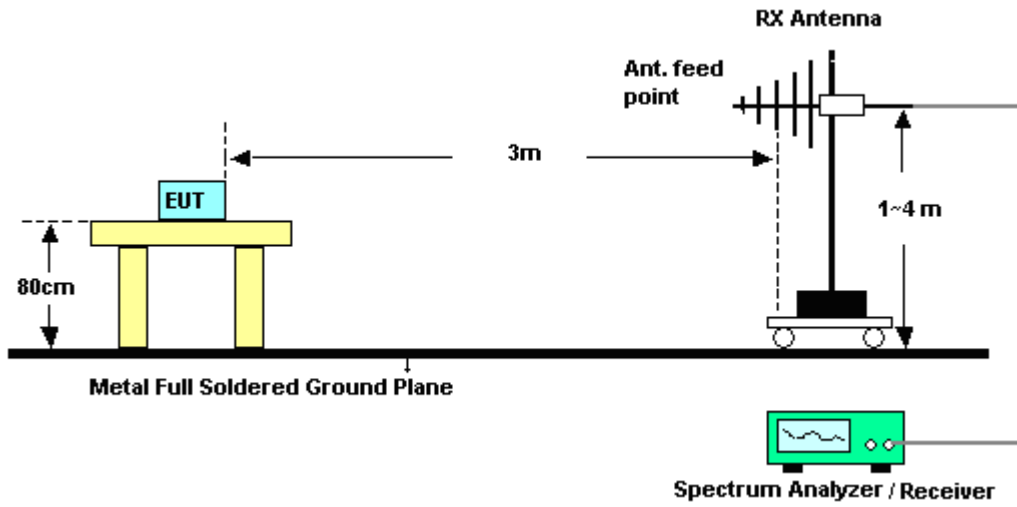

For radiated emissions above 1GHz

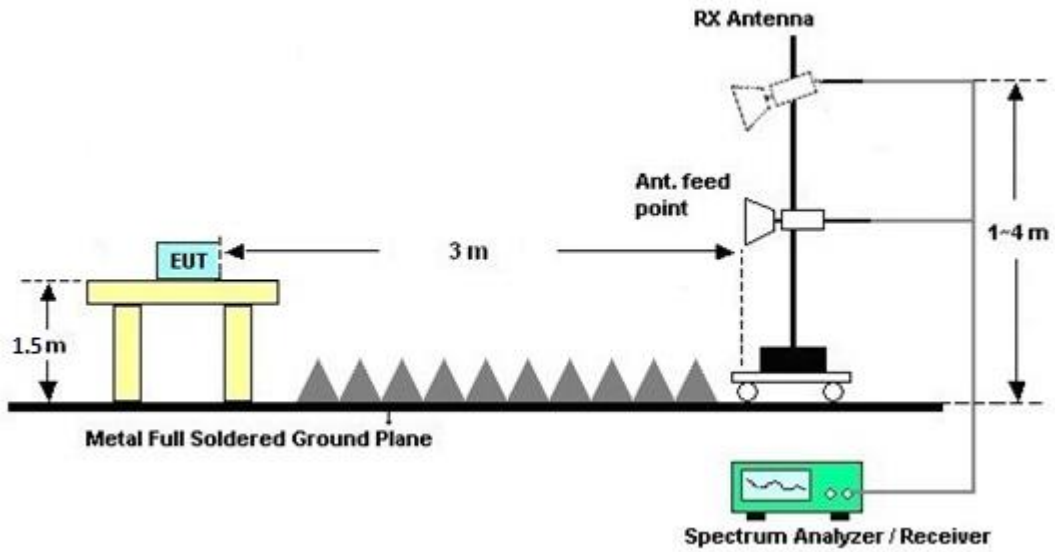

3.4.5 Test Results of Radiated Emissions (9 kHz ~ 30 MHz)

The low frequency, which started from 9 kHz to 30MHz, was pre-scanned and the result which was 20dB lower than the limit line was not reported.

There is a comparison data of both open-field test site and alternative test site - semi-Anechoic chamber according to 414788 D01 Radiated Test Site v01r01, and the result came out very similar.



3.4.6 Test Result of Radiated Band Edges

Please refer to Appendix C and D.

3.4.7 Duty Cycle

Please refer to Appendix E.

3.4.8 Test Result of Unwanted Radiated Emission (30MHz ~ 10th Harmonic)

Please refer to Appendix C and D.



3.5 AC Conducted Emission Measurement

3.5.1 Limit of AC Conducted Emission

For equipment that is designed to be connected to the public utility (AC) power line, the radio frequency voltage that is conducted back onto the AC power line on any frequency or frequencies within the band 150 kHz to 30 MHz shall not exceed the limits in the following table.

Frequency of emission (MHz)	Conducted limit (dBµV)	
	Quasi-peak	Average
0.15-0.5	66 to 56*	56 to 46*
0.5-5	56	46
5-30	60	50

*Decreases with the logarithm of the frequency.

3.5.2 Measuring Instruments

See list of measuring equipment of this test report.

3.5.3 Test Procedures

1. The EUT was placed 0.4 meter from the conducting wall of the shielding room was kept at least 80 centimeters from any other grounded conducting surface.
2. Connect EUT to the power mains through a line impedance stabilization network (LISN).
3. All the support units are connecting to the other LISN.
4. The LISN provides 50 ohm coupling impedance for the measuring instrument.
5. The FCC states that a 50 ohm, 50 microhenry LISN should be used.
6. Both sides of AC line were checked for maximum conducted interference.
7. The frequency range from 150 kHz to 30 MHz was searched.
8. Set the test-receiver system to Peak Detect Function and specified bandwidth with Maximum Hold Mode.

3.5.4 Test Setup

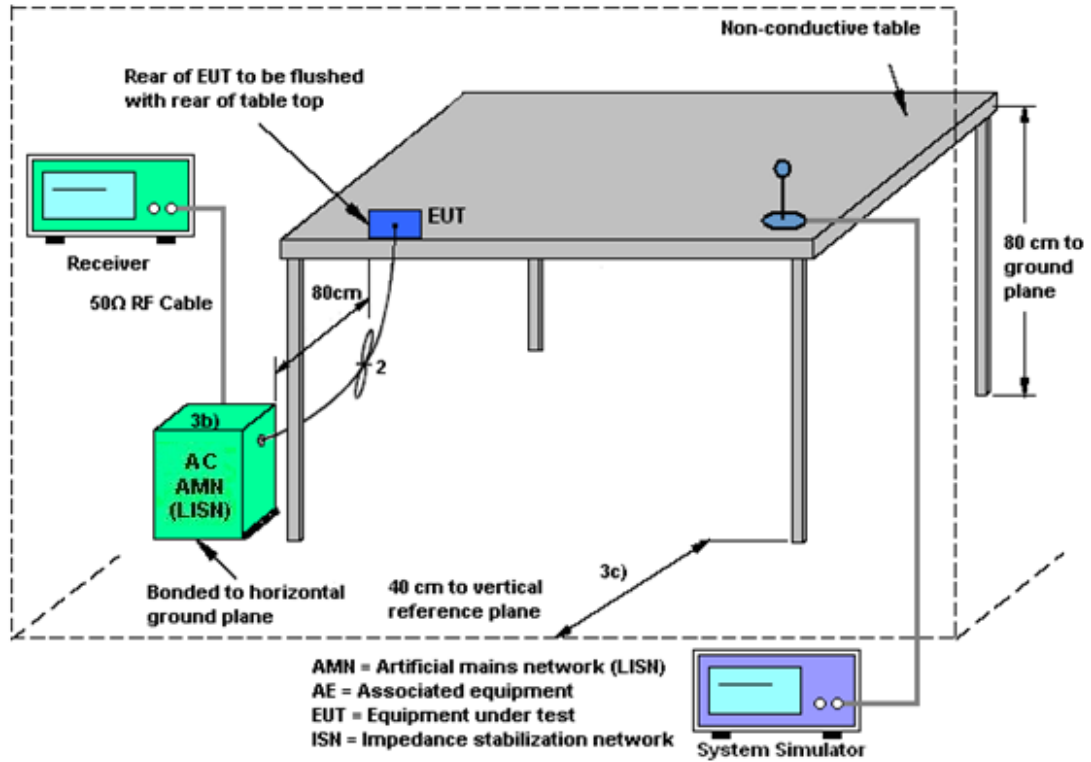

3.5.5 Test Result of AC Conducted Emission

Please refer to Appendix B.



3.6 Automatically Discontinue Transmission

3.6.1 Limit of Automatically Discontinue Transmission

The device shall automatically discontinue transmission in case of either absence of information to transmit or operational failure. These provisions are not intended to preclude the transmission of control or signaling information or the use of repetitive codes used by certain digital technologies to complete frame or burst intervals. Applicants shall include in their application for equipment authorization to describe how this requirement is met.

3.6.2 Measuring Instruments

See list of measuring equipment of this test report.

3.6.3 Test Result of Automatically Discontinue Transmission

While the EUT is not transmitting any information, the EUT can automatically discontinue transmission and become standby mode for power saving. The EUT can detect the controlling signal of ACK message transmitting from remote device and verify whether it shall resend or discontinue transmission.



3.7 Antenna Requirements

3.7.1 Standard Applicable

If transmitting antenna directional gain is greater than 6 dBi, both the peak transmit power and the peak power spectral density shall be reduced by the amount in dB that the directional gain of the antenna exceeds 6 dBi.

3.7.2 Antenna Anti-Replacement Construction

An embedded-in antenna design is used.

3.7.3 Antenna Gain

The antenna peak gain of EUT is less than 6 dBi. Therefore, it is not necessary to reduce maximum peak output power limit.



4 List of Measuring Equipment

Instrument	Manufacturer	Model No.	Serial No.	Characteristics	Calibration Date	Test Date	Due Date	Remark
Hygrometer	Testo	DTM-303A	TP157075	N/A	Nov. 05, 2018	May 07, 2019~ May 20, 2019	Nov. 04, 2019	Conducted (TH05-HY)
Power Sensor	DARE	RPR3006W	13I00030S NO32	9kHz~6GHz	Dec. 03, 2018	May 07,2019~ May 20,2019	Dec. 02, 2019	Conducted (TH05-HY)
Spectrum Analyzer	Rohde & Schwarz	FSP40	100057	9kHz-40GHz	Nov. 21, 2018	May 07,2019~ May 20,2019	Nov. 20, 2019	Conducted (TH05-HY)
Switch Box & RF Cable	Burgeon	ETF-058	EC120838 2	N/A	Mar. 27, 2019	May 07,2019~ May 20,2019	Mar. 26, 2020	Conducted (TH05-HY)
AC Power Source	ChainTek	APC-1000W	N/A	N/A	N/A	May. 27, 2019	N/A	Conduction (CO05-HY)
EMI Test Receiver	Rohde & Schwarz	ESR3	102388	9KHZ~3.6GHz	Nov. 12, 2018	May. 27, 2019	Nov. 11, 2019	Conduction (CO05-HY)
Hygrometer	Testo	608-H1	34913912	N/A	Mar. 19, 2019	May 27, 2019	Mar. 18, 2020	Conduction (CO05-HY)
LISN	Rohde & Schwarz	ENV216	100080	9kHz~30MHz	Nov. 14, 2018	May. 27, 2019	Nov. 13, 2019	Conduction (CO05-HY)
LISN	Rohde & Schwarz	ENV216	100081	9kHz~30MHz	Nov. 09, 2018	May. 27, 2019	Nov. 08, 2019	Conduction (CO05-HY)
Software	Rohde & Schwarz	EMC32 V10.30	N/A	N/A	N/A	May. 27, 2019	N/A	Conduction (CO05-HY)
LF Cable	HUBER + SUHNER	RG-214/U	LF01	N/A	Dec. 31, 2018	May. 27, 2019	Dec. 30, 2019	Conduction (CO05-HY)
Pulse Limiter	Rohde & Schwarz	ESH3-Z2	100851	N/A	Dec. 31, 2018	May. 27, 2019	Dec. 30, 2019	Conduction (CO05-HY)
Loop Antenna	Rohde & Schwarz	HFH2-Z2	100488	9 kHz~30 MHz	Jan. 07, 2019	May 09, 2019~ May 12, 2019	Jan. 06, 2020	Radiation (03CH15-HY)
Preamplifier	EMEC	EM18G40G	060715	18GHz~ 40GHz	Dec. 06, 2018	May 09, 2019~ May 12, 2019	Dec. 05, 2019	Radiation (03CH15-HY)
Bilog Antenna	TESEQ	CBL6111D&0 0800N1D01N- 06	41912&05	30MHz to 1GHz	Feb. 12, 2019	May 09, 2019~ May 12, 2019	Feb. 11, 2020	Radiation (03CH15-HY)
Horn Antenna	SCHWARZBE CK	BBHA 9120D	9120D-162 0	1G~18GHz	Oct. 17, 2018	May 09, 2019~ May 12, 2019	Oct. 16, 2019	Radiation (03CH15-HY)
SHF-EHF Horn Antenna	SCHWARZBE CK	BBHA 9170	BBHA9170 584	18GHz- 40GHz	Dec. 05, 2018	May 09, 2019~ May 12, 2019	Dec. 04, 2019	Radiation (03CH15-HY)
Amplifier	SONOMA	310N	363440	9kHz~1GHz	Dec. 28, 2018	May 09, 2019~ May 12, 2019	Dec. 27, 2019	Radiation (03CH15-HY)
Preamplifier	Jet-Power	JAP00101800 -30-10P	160118550 004	1GHz~18GHz	Apr. 16, 2019	May 09, 2019~ May 12, 2019	Apr. 15, 2020	Radiation (03CH15-HY)
Preamplifier	Keysight	83017A	MY532700 78	1GHz~26.5GHz	Oct. 28, 2018	May 09, 2019~ May 12, 2019	Oct. 27, 2019	Radiation (03CH15-HY)
EMI Test Receiver	Keysight	N9038A (MXE)	MY541300 85	20Hz ~ 8.4GHz	Nov. 01, 2018	May 09, 2019~ May 12, 2019	Oct. 31, 2019	Radiation (03CH15-HY)
Spectrum Analyzer	Agilent	E4446A	MY501801 36	3Hz~44GHz	Apr. 30, 2019	May 09, 2019~ May 12, 2019	Apr. 29, 2020	Radiation (03CH15-HY)



Instrument	Manufacturer	Model No.	Serial No.	Characteristics	Calibration Date	Test Date	Due Date	Remark
Controller	ChainTek	3000-1	N/A	Control Turn table & Ant Mast	N/A	May 09, 2019~ May 12, 2019	N/A	Radiation (03CH15-HY)
Antenna Mast	ChainTek	MBS-520-1	N/A	1m~4m	N/A	May 09, 2019~ May 12, 2019	N/A	Radiation (03CH15-HY)
Turn Table	ChainTek	T-200-S-1	N/A	0~360 Degree	N/A	May 09, 2019~ May 12, 2019	N/A	Radiation (03CH15-HY)
Software	Audix	E3 6.2009-8-24	RK-00045 1	N/A	N/A	May 09, 2019~ May 12, 2019	N/A	Radiation (03CH15-HY)
RF Cable	HUBER + SUHNER	SUCOFLEX 104	MY36980/ 4	30M-18G	Apr. 15, 2019	May 09, 2019~ May 12, 2019	Apr. 14, 2020	Radiation (03CH15-HY)
RF Cable	HUBER + SUHNER	SUCOFLEX 104	MY9838/4	30M-18G	Apr. 15, 2019	May 09, 2019~ May 12, 2019	Apr. 14, 2020	Radiation (03CH15-HY)
RF Cable	HUBER + SUHNER	MTJ	000000-M T18A-100 D3210	30M-18G	Apr. 15, 2019	May 09, 2019~ May 12, 2019	Apr. 14, 2020	Radiation (03CH15-HY)
RF Cable	HUBER + SUHNER	SUCOFLEX 102	MY2859/2	30MHz-40GHz	Mar. 13, 2019	May 09, 2019~ May 12, 2019	Mar. 12, 2020	Radiation (03CH15-HY)
RF Cable	HUBER + SUHNER	SUCOFLEX 102	MY4274/2	30MHz-40GHz	Mar. 13, 2019	May 09, 2019~ May 12, 2019	Mar. 12, 2020	Radiation (03CH15-HY)
Filter	Wainwright	WHKX8-5872. 5-6750-18000 -40ST	SN3	6.75 GHz Highpass	Sep. 16, 2018	May 09, 2019~ May 12, 2019	Sep. 15, 2019	Radiation (03CH15-HY)
Filter	Wainwright	WLK4-1000-1 530-8000-40S S	SN11	1G Low Pass	Sep. 16, 2018	May 09, 2019~ May 12, 2019	Sep. 15, 2019	Radiation (03CH15-HY)
Hygrometer	TECPEL	DTM-303B	TP140320	N/A	Nov. 05, 2018	May 09, 2019~ May 12, 2019	Nov. 04, 2019	Radiation (03CH15-HY)



5 Uncertainty of Evaluation

Uncertainty of Conducted Emission Measurement (150kHz ~ 30MHz)

Measuring Uncertainty for a Level of Confidence of 95% ($U = 2Uc(y)$)	2.20
---	------

Uncertainty of Radiated Emission Measurement (30 MHz ~ 1000 MHz)

Measuring Uncertainty for a Level of Confidence of 95% ($U = 2Uc(y)$)	5.20
---	------

Uncertainty of Radiated Emission Measurement (1000 MHz ~ 18000 MHz)

Measuring Uncertainty for a Level of Confidence of 95% ($U = 2Uc(y)$)	5.50
---	------

Uncertainty of Radiated Emission Measurement (18000 MHz ~ 40000 MHz)

Measuring Uncertainty for a Level of Confidence of 95% ($U = 2Uc(y)$)	5.20
---	------

Appendix A. Test Result of Conducted Test Items

Test Engineer:	Rebecca Li	Temperature:	21~25	°C
Test Date:	2019/05/07 ~ 2019/05/20	Relative Humidity:	51~54	%

TEST RESULTS DATA
6dB and 26dB EBW and 99% OBW

Band IV												
Mod.	Data Rate	NTX	CH.	Freq. (MHz)	99% Bandwidth (MHz)		26dB Bandwidth (MHz)		6 dB Bandwidth (MHz)		6 dB Bandwidth Min. Limit (MHz)	Pass/Fail
					Ant 1	Ant 2	Ant 1	Ant 2	Ant 1	Ant 2		
11a	6Mbps	1	149	5745	16.70	-	24.60	-	15.15	-	0.5	Pass
11a	6Mbps	1	157	5785	16.75	-	24.90	-	15.30	-	0.5	Pass
11a	6Mbps	1	165	5825	16.75	-	24.90	-	15.10	-	0.5	Pass
HT20	MCS0	1	149	5745	17.85	-	25.60	-	15.10	-	0.5	Pass
HT20	MCS0	1	157	5785	17.95	-	25.60	-	15.10	-	0.5	Pass
HT20	MCS0	1	165	5825	17.90	-	25.80	-	15.90	-	0.5	Pass
HT40	MCS0	1	151	5755	36.60	-	41.76	-	34.92	-	0.5	Pass
HT40	MCS0	1	159	5795	36.60	-	41.94	-	35.20	-	0.5	Pass
VHT80	MCS0	1	155	5775	76.92	-	84.48	-	75.20	-	0.5	Pass

TEST RESULTS DATA
Average Power Table

Band IV												
Mod.	Data Rate	NTX	CH.	Freq. (MHz)	Average Conducted Power (dBm)			FCC Conducted Power Limit (dBm)		DG (dBi)		Pass/Fail
					Ant 1	Ant 2	SUM	Ant 1	Ant 2	Ant 1	Ant 2	
11a	6Mbps	1	149	5745	16.90	-		30.00	-	-8.00	-	Pass
11a	6Mbps	1	157	5785	16.80	-		30.00	-	-8.00	-	Pass
11a	6Mbps	1	165	5825	16.90	-		30.00	-	-8.00	-	Pass
HT20	MCS0	1	149	5745	15.70	-		30.00	-	-8.00	-	Pass
HT20	MCS0	1	157	5785	15.80	-		30.00	-	-8.00	-	Pass
HT20	MCS0	1	165	5825	15.70	-		30.00	-	-8.00	-	Pass
HT40	MCS0	1	151	5755	15.60	-		30.00	-	-8.00	-	Pass
HT40	MCS0	1	159	5795	15.70	-		30.00	-	-8.00	-	Pass
VHT20	MCS0	1	149	5745	14.70	-		30.00	-	-8.00	-	Pass
VHT20	MCS0	1	157	5785	14.50	-		30.00	-	-8.00	-	Pass
VHT20	MCS0	1	165	5825	14.70	-		30.00	-	-8.00	-	Pass
VHT40	MCS0	1	151	5755	14.60	-		30.00	-	-8.00	-	Pass
VHT40	MCS0	1	159	5795	14.60	-		30.00	-	-8.00	-	Pass
VHT80	MCS0	1	155	5775	14.90	-		30.00	-	-8.00	-	Pass

TEST RESULTS DATA
Power Spectral Density

Band IV																
Mod.	Data Rate	NTX	CH.	Freq. (MHz)	Duty Factor (dB)		10log (500kHz /RBW) Factor (dB)		Average Power Density (dBm/500kHz)			Average PSD Limit (dBm/500kHz)		DG (dBi)		Pass /Fail
					Ant 1	Ant 2	Ant 1	Ant 2	Ant 1	Ant 2	SUM	Ant 1	Ant 2	Ant 1	Ant 2	
11a	6Mbps	1	149	5745	0.08	-	2.22	-	3.64	-		30.00	-	-8.00	-	Pass
11a	6Mbps	1	157	5785	0.08	-	2.22	-	3.16	-		30.00	-	-8.00	-	Pass
11a	6Mbps	1	165	5825	0.08	-	2.22	-	3.15	-		30.00	-	-8.00	-	Pass
HT20	MCS0	1	149	5745	0.11	-	2.22	-	1.97	-		30.00	-	-8.00	-	Pass
HT20	MCS0	1	157	5785	0.11	-	2.22	-	1.49	-		30.00	-	-8.00	-	Pass
HT20	MCS0	1	165	5825	0.11	-	2.22	-	1.65	-		30.00	-	-8.00	-	Pass
HT40	MCS0	1	151	5755	0.17	-	2.22	-	-1.20	-		30.00	-	-8.00	-	Pass
HT40	MCS0	1	159	5795	0.17	-	2.22	-	-1.63	-		30.00	-	-8.00	-	Pass
VHT80	MCS0	1	155	5775	0.36	-	2.22	-	-5.00	-		30.00	-	-8.00	-	Pass



Appendix B. AC Conducted Emission Test Results

Test Engineer :	Eric Jeng and Jimmy Chang	Temperature :	22~25°C
		Relative Humidity :	52~55%

EUT Information

Report NO : 942629
 Test Mode : Mode 1
 Test Voltage : 120Vac/60Hz
 Phase : Line

Full Spectrum

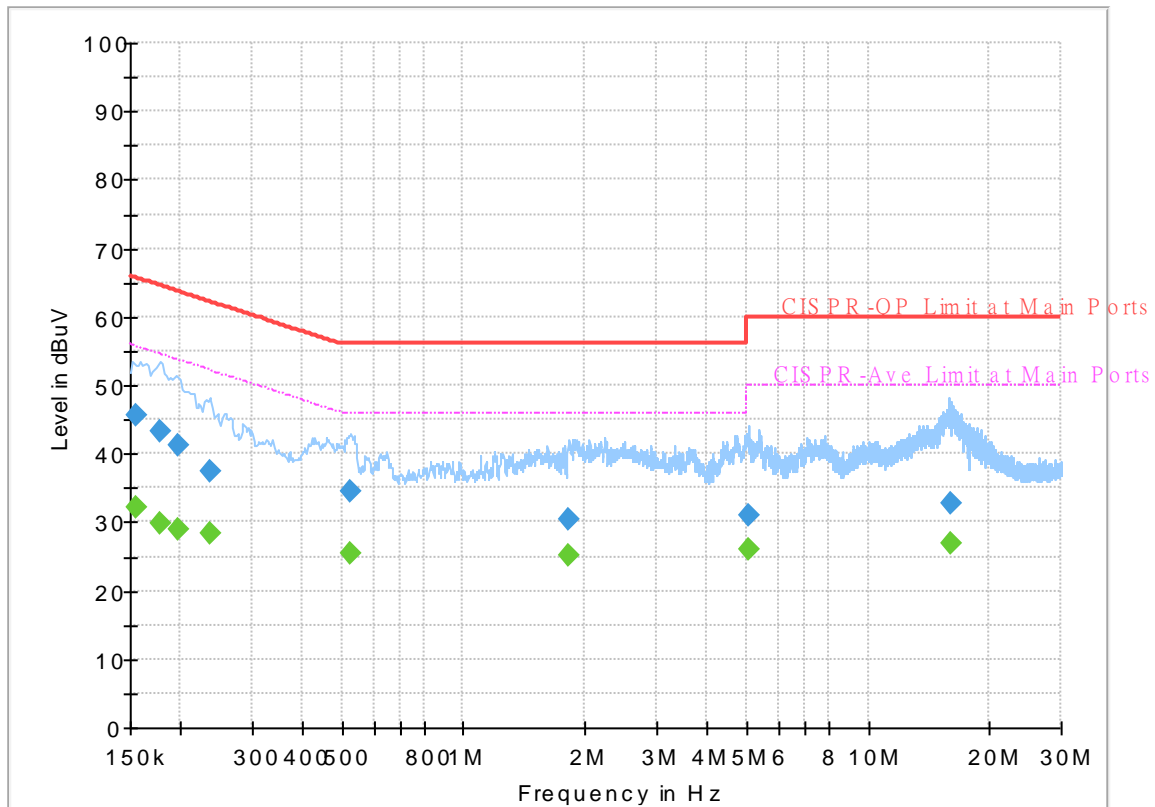

Final_Result

Frequency (MHz)	QuasiPeak (dBuV)	CAverage (dBuV)	Limit (dBuV)	Margin (dB)	Line	Filter	Corr. (dB)
0.154500	---	32.11	55.75	23.64	L1	OFF	19.5
0.154500	45.61	---	65.75	20.14	L1	OFF	19.5
0.177000	---	29.96	54.63	24.67	L1	OFF	19.5
0.177000	43.30	---	64.63	21.33	L1	OFF	19.5
0.197250	---	28.91	53.73	24.82	L1	OFF	19.5
0.197250	41.27	---	63.73	22.46	L1	OFF	19.5
0.235500	---	28.37	52.25	23.88	L1	OFF	19.5
0.235500	37.49	---	62.25	24.76	L1	OFF	19.5
0.528000	---	25.54	46.00	20.46	L1	OFF	19.5
0.528000	34.57	---	56.00	21.43	L1	OFF	19.5
1.828500	---	25.09	46.00	20.91	L1	OFF	19.6
1.828500	30.54	---	56.00	25.46	L1	OFF	19.6
5.061750	---	26.03	50.00	23.97	L1	OFF	19.7
5.061750	30.96	---	60.00	29.04	L1	OFF	19.7
15.972000	---	27.04	50.00	22.96	L1	OFF	20.1
15.972000	32.74	---	60.00	27.26	L1	OFF	20.1

EUT Information

Report NO : 942629
 Test Mode : Mode 1
 Test Voltage : 120Vac/60Hz
 Phase : Neutral

Full Spectrum

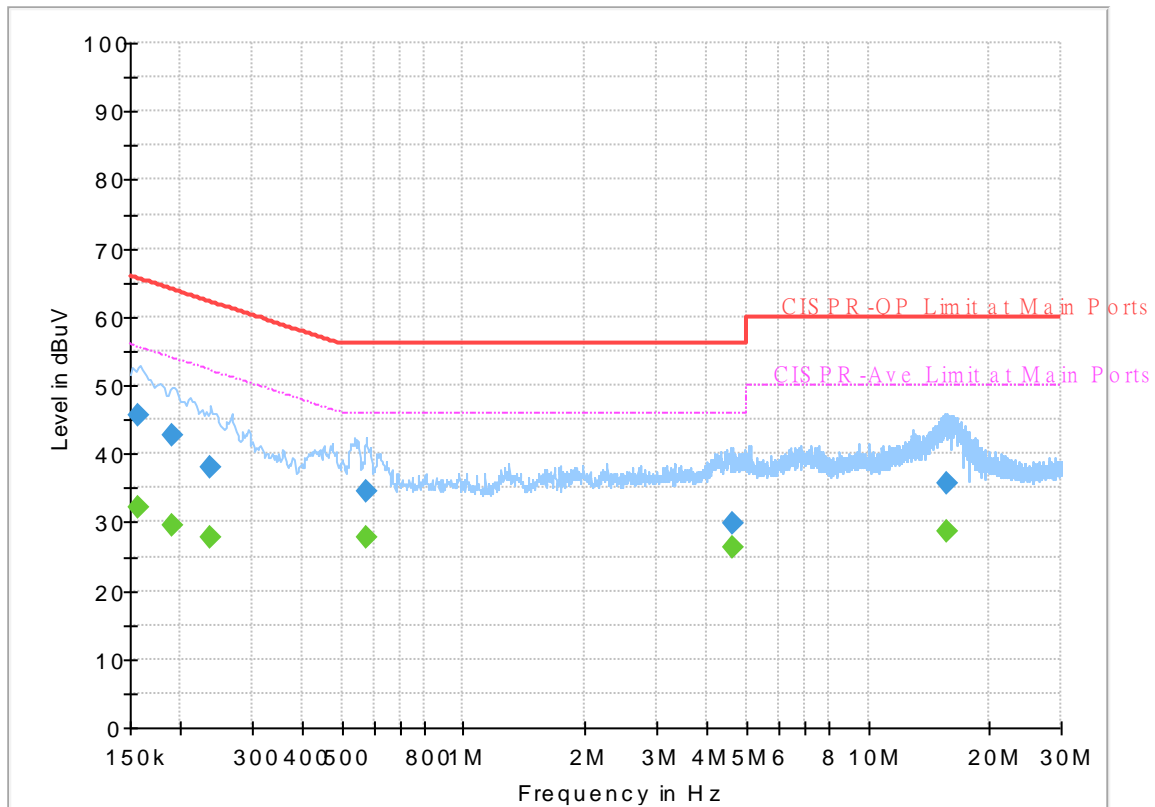

Final_Result

Frequency (MHz)	QuasiPeak (dBuV)	CAverage (dBuV)	Limit (dBuV)	Margin (dB)	Line	Filter	Corr. (dB)
0.156750	---	32.08	55.63	23.55	N	OFF	19.5
0.156750	45.49	---	65.63	20.14	N	OFF	19.5
0.190500	---	29.59	54.02	24.43	N	OFF	19.5
0.190500	42.82	---	64.02	21.20	N	OFF	19.5
0.237750	---	27.90	52.17	24.27	N	OFF	19.5
0.237750	37.99	---	62.17	24.18	N	OFF	19.5
0.575250	---	27.80	46.00	18.20	N	OFF	19.5
0.575250	34.62	---	56.00	21.38	N	OFF	19.5
4.641000	---	26.21	46.00	19.79	N	OFF	19.7
4.641000	29.82	---	56.00	26.18	N	OFF	19.7
15.618750	---	28.73	50.00	21.27	N	OFF	20.1
15.618750	35.80	---	60.00	24.20	N	OFF	20.1



Appendix B. Radiated Spurious Emission

Test Engineer :	Watt Tseng, Karl Hou, and BigShow Wang	Temperature :	23~26°C
		Relative Humidity :	50~57%

Band 4 - 5725~5850MHz

WIFI 802.11a (Band Edge @ 3m)

WIFI Ant.	Note	Frequency (MHz)	Level (dBμV/m)	Over Limit (dB)	Limit Line (dBμV/m)	Read Level (dBμV)	Antenna Factor (dB/m)	Path Loss (dB)	Preamp Factor (dB)	Ant Pos (cm)	Table Pos (deg)	Peak Avg. (P/A)	Pol. (H/V)	
802.11a CH 149 5745MHz		5640.4	50.37	-17.83	68.2	38.86	31.73	10	30.22	100	147	P	H	
		5694.6	52.57	-48.65	101.22	41.01	31.8	10.01	30.25	100	147	P	H	
		5714.8	57.45	-51.9	109.35	45.83	31.87	10.01	30.26	100	147	P	H	
		5725	60.04	-62.16	122.2	48.36	31.93	10.01	30.26	100	147	P	H	
	*	5745	105.28	-	-	93.53	32	10.02	30.27	100	147	P	H	
	*	5745	97.59	-	-	85.84	32	10.02	30.27	100	147	A	H	
														H
														H
			5647.8	50.16	-18.04	68.2	38.65	31.73	10	30.22	306	211	P	V
			5700	52.87	-52.33	105.2	41.31	31.8	10.01	30.25	306	211	P	V
			5718	53.16	-57.08	110.24	41.48	31.93	10.01	30.26	306	211	P	V
			5724.6	59.66	-61.63	121.29	47.98	31.93	10.01	30.26	306	211	P	V
	*		5745	105.67	-	-	93.92	32	10.02	30.27	306	211	P	V
	*		5745	97.78	-	-	86.03	32	10.02	30.27	306	211	A	V
														V
														V



WIFI Ant. 1	Note	Frequency (MHz)	Level (dBμV/m)	Over Limit (dB)	Limit Line (dBμV/m)	Read Level (dBμV)	Antenna Factor (dB/m)	Path Loss (dB)	Preamp Factor (dB)	Ant Pos (cm)	Table Pos (deg)	Peak Avg. (P/A)	Pol. (H/V)
		5611.6	50.73	-17.47	68.2	39.15	31.8	9.99	30.21	100	150	P	H
		5694.8	51.08	-50.29	101.37	39.52	31.8	10.01	30.25	100	150	P	H
		5719.8	50.95	-59.79	110.74	39.27	31.93	10.01	30.26	100	150	P	H
		5720	50.69	-60.11	110.8	39.01	31.93	10.01	30.26	100	150	P	H
	*	5785	106.25	-	-	94.39	32.13	10.03	30.3	100	150	P	H
	*	5785	98.38	-	-	86.52	32.13	10.03	30.3	100	150	A	H
		5851.2	52.14	-67.32	119.46	40.17	32.2	10.1	30.33	100	150	P	H
		5870	52.26	-54.34	106.6	40.24	32.23	10.13	30.34	100	150	P	H
		5888	51.15	-44.4	95.55	39.05	32.3	10.16	30.36	100	150	P	H
		5949.6	51.57	-16.63	68.2	39.3	32.4	10.25	30.38	100	150	P	H
													H
													H
802.11a													
CH 157													
5785MHz		5629.8	51.29	-16.91	68.2	39.74	31.77	10	30.22	334	210	P	V
		5694	50.95	-49.83	100.78	39.39	31.8	10.01	30.25	334	210	P	V
		5711	51.46	-56.82	108.28	39.84	31.87	10.01	30.26	334	210	P	V
		5724.6	51.76	-69.53	121.29	40.08	31.93	10.01	30.26	334	210	P	V
	*	5785	106.52	-	-	94.66	32.13	10.03	30.3	334	210	P	V
	*	5785	98.72	-	-	86.86	32.13	10.03	30.3	334	210	A	V
		5850	53.1	-69.1	122.2	41.13	32.2	10.1	30.33	334	210	P	V
		5860	52.15	-57.25	109.4	40.14	32.23	10.12	30.34	334	210	P	V
		5907.4	51.44	-29.75	81.19	39.28	32.33	10.19	30.36	334	210	P	V
		5939.4	51.44	-16.76	68.2	39.19	32.4	10.23	30.38	334	210	P	V
													V
													V



WIFI Ant. 1	Note	Frequency (MHz)	Level (dBµV/m)	Over Limit (dB)	Limit Line (dBµV/m)	Read Level (dBµV)	Antenna Factor (dB/m)	Path Loss (dB)	Preamp Factor (dB)	Ant Pos (cm)	Table Pos (deg)	Peak Avg. (P/A)	Pol. (H/V)	
802.11a CH 165 5825MHz	*	5825	105.58	-	-	93.63	32.2	10.07	30.32	100	151	P	H	
	*	5825	97.69	-	-	85.74	32.2	10.07	30.32	100	151	A	H	
		5853.4	56.07	-58.38	114.45	44.09	32.2	10.11	30.33	100	151	P	H	
		5855	53.16	-57.64	110.8	41.15	32.23	10.11	30.33	100	151	P	H	
		5883.6	53.53	-45.28	98.81	41.47	32.27	10.15	30.36	100	151	P	H	
		5948	52.46	-15.74	68.2	40.2	32.4	10.24	30.38	100	151	P	H	
														H
														H
	*	5825	106.7	-	-	94.75	32.2	10.07	30.32	299	207	P	V	
	*	5825	98.9	-	-	86.95	32.2	10.07	30.32	299	207	A	V	
		5853.8	57.28	-56.26	113.54	45.27	32.23	10.11	30.33	299	207	P	V	
		5855	55.91	-54.89	110.8	43.9	32.23	10.11	30.33	299	207	P	V	
		5877.6	54.3	-48.97	103.27	42.23	32.27	10.14	30.34	299	207	P	V	
		5927.8	52.25	-15.95	68.2	40.03	32.37	10.22	30.37	299	207	P	V	
														V
														V
													V	
Remark	1. No other spurious found. 2. All results are PASS against Peak and Average limit line.													



Band 4 5725~5850MHz
WIFI 802.11a (Harmonic @ 3m)

WIFI Ant. 1	Note	Frequency (MHz)	Level (dBμV/m)	Over Limit (dB)	Limit Line (dBμV/m)	Read Level (dBμV)	Antenna Factor (dB/m)	Path Loss (dB)	Preamp Factor (dB)	Ant Pos (cm)	Table Pos (deg)	Peak Avg. (P/A)	Pol. (H/V)
802.11a CH 149 5745MHz		11490	48.13	-25.87	74	56.32	40.17	14.63	62.99	100	0	P	H
		17235	48.75	-19.45	68.2	51.6	40.7	18.66	62.21	100	0	P	H
													H
													H
		11490	48.81	-25.19	74	57	40.17	14.63	62.99	100	0	P	V
		17235	48.69	-19.51	68.2	51.54	40.7	18.66	62.21	100	0	P	V
													V
													V
802.11a CH 157 5785MHz		11570	48.35	-25.65	74	56.76	40	14.67	63.08	100	0	P	H
		17355	50.42	-17.78	68.2	52.33	41.4	18.86	62.17	100	0	P	H
													H
													H
		11570	49.39	-24.61	74	57.8	40	14.67	63.08	100	0	P	V
		17355	50.8	-17.4	68.2	52.71	41.4	18.86	62.17	100	0	P	V
													V
													V
802.11a CH 165 5825MHz		11650	47.36	-26.64	74	56.2	39.66	14.71	63.21	100	0	P	H
		17475	49.38	-18.82	68.2	50.06	42.43	19.03	62.14	100	0	P	H
													H
													H
		11650	47.62	-26.38	74	56.46	39.66	14.71	63.21	100	0	P	V
		17475	51.46	-16.74	68.2	52.14	42.43	19.03	62.14	100	0	P	V
													V
													V
Remark	1. No other spurious found. 2. All results are PASS against Peak and Average limit line.												



Band 4 5725~5850MHz
WIFI 802.11n HT20 (Band Edge @ 3m)

WIFI Ant. 1	Note	Frequency (MHz)	Level (dBμV/m)	Over Limit (dB)	Limit Line (dBμV/m)	Read Level (dBμV)	Antenna Factor (dB/m)	Path Loss (dB)	Preamp Factor (dB)	Ant Pos (cm)	Table Pos (deg)	Peak Avg. (P/A)	Pol. (H/V)	
802.11n HT20 CH 149 5745MHz		5648	51.8	-16.4	68.2	40.29	31.73	10	30.22	100	135	P	H	
		5660.6	51.12	-24.95	76.07	39.65	31.7	10	30.23	100	135	P	H	
		5718.4	54.81	-55.54	110.35	43.13	31.93	10.01	30.26	100	135	P	H	
		5724.8	58.1	-63.64	121.74	46.42	31.93	10.01	30.26	100	135	P	H	
	*	5745	104.43	-	-	92.68	32	10.02	30.27	100	135	P	H	
	*	5745	96.89	-	-	85.14	32	10.02	30.27	100	135	A	H	
														H
														H
			5618.2	51.27	-16.93	68.2	39.72	31.77	9.99	30.21	311	199	P	V
			5685	51.22	-42.91	94.13	39.66	31.8	10.01	30.25	311	199	P	V
			5708.2	52.54	-54.96	107.5	40.92	31.87	10.01	30.26	311	199	P	V
			5724.6	59.44	-61.85	121.29	47.76	31.93	10.01	30.26	311	199	P	V
	*		5745	104.37	-	-	92.62	32	10.02	30.27	311	199	P	V
	*		5745	96.84	-	-	85.09	32	10.02	30.27	311	199	A	V
														V
														V



WIFI Ant. 1	Note	Frequency (MHz)	Level (dBμV/m)	Over Limit (dB)	Limit Line (dBμV/m)	Read Level (dBμV)	Antenna Factor (dB/m)	Path Loss (dB)	Preamp Factor (dB)	Ant Pos (cm)	Table Pos (deg)	Peak Avg. (P/A)	Pol. (H/V)
		5608.8	50.76	-17.44	68.2	39.18	31.8	9.99	30.21	100	136	P	H
		5666.8	51.39	-29.28	80.67	39.87	31.75	10	30.23	100	136	P	H
		5716.8	50.71	-59.2	109.91	39.09	31.87	10.01	30.26	100	136	P	H
		5723	50.7	-66.94	117.64	39.02	31.93	10.01	30.26	100	136	P	H
	*	5785	104.7	-	-	92.84	32.13	10.03	30.3	100	136	P	H
	*	5785	97.06	-	-	85.2	32.13	10.03	30.3	100	136	A	H
		5851.8	50.51	-67.59	118.1	38.53	32.2	10.11	30.33	100	136	P	H
		5867.2	50.56	-56.82	107.38	38.54	32.23	10.13	30.34	100	136	P	H
		5903.4	51.99	-32.16	84.15	39.87	32.3	10.18	30.36	100	136	P	H
		5943.8	51.19	-17.01	68.2	38.93	32.4	10.24	30.38	100	136	P	H
													H
													H
802.11n													
HT20													
CH 157		5634.8	51	-17.2	68.2	39.49	31.73	10	30.22	321	198	P	V
5785MHz		5669.2	51.25	-31.2	82.45	39.73	31.75	10	30.23	321	198	P	V
		5707.6	50.73	-56.6	107.33	39.11	31.87	10.01	30.26	321	198	P	V
		5721.8	49.81	-65.09	114.9	38.13	31.93	10.01	30.26	321	198	P	V
	*	5785	106	-	-	94.14	32.13	10.03	30.3	321	198	P	V
	*	5785	98.13	-	-	86.27	32.13	10.03	30.3	321	198	A	V
		5854.8	51.43	-59.83	111.26	39.42	32.23	10.11	30.33	321	198	P	V
		5872.8	51.89	-53.93	105.82	39.82	32.27	10.14	30.34	321	198	P	V
		5922.2	51.85	-18.41	70.26	39.64	32.37	10.21	30.37	321	198	P	V
		5939	51.13	-17.07	68.2	38.88	32.4	10.23	30.38	321	198	P	V
													V
													V



WIFI Ant. 1	Note	Frequency (MHz)	Level (dBμV/m)	Over Limit (dB)	Limit Line (dBμV/m)	Read Level (dBμV)	Antenna Factor (dB/m)	Path Loss (dB)	Preamp Factor (dB)	Ant Pos (cm)	Table Pos (deg)	Peak Avg. (P/A)	Pol. (H/V)	
802.11n HT20 CH 165 5825MHz	*	5825	104.12	-	-	92.17	32.2	10.07	30.32	100	139	P	H	
	*	5825	96.37	-	-	84.42	32.2	10.07	30.32	100	139	A	H	
		5850.2	54.47	-67.27	121.74	42.5	32.2	10.1	30.33	100	139	P	H	
		5860	53.36	-56.04	109.4	41.35	32.23	10.12	30.34	100	139	P	H	
		5895.8	52.78	-36.99	89.77	40.67	32.3	10.17	30.36	100	139	P	H	
		5937	51.16	-17.04	68.2	38.94	32.37	10.23	30.38	100	139	P	H	
														H
														H
	*	5825	105.59	-	-	93.64	32.2	10.07	30.32	335	199	P	V	
	*	5825	97.79	-	-	85.84	32.2	10.07	30.32	335	199	A	V	
		5850.6	52.47	-68.36	120.83	40.5	32.2	10.1	30.33	335	199	P	V	
		5865.8	53.18	-54.59	107.77	41.16	32.23	10.13	30.34	335	199	P	V	
		5875.4	51.31	-53.59	104.9	39.24	32.27	10.14	30.34	335	199	P	V	
		5933.4	51.69	-16.51	68.2	39.47	32.37	10.22	30.37	335	199	P	V	
														V
														V
Remark	1. No other spurious found. 2. All results are PASS against Peak and Average limit line.													



Band 4 5725~5850MHz
WIFI 802.11n HT20 (Harmonic @ 3m)

WIFI Ant. 1	Note	Frequency (MHz)	Level (dBμV/m)	Over Limit (dB)	Limit Line (dBμV/m)	Read Level (dBμV)	Antenna Factor (dB/m)	Path Loss (dB)	Preamp Factor (dB)	Ant Pos (cm)	Table Pos (deg)	Peak Avg. (P/A)	Pol. (H/V)	
802.11n HT20 CH 149 5745MHz		11490	49.13	-24.87	74	57.32	40.17	14.63	62.99	100	0	P	H	
		17235	48.27	-19.93	68.2	51.12	40.7	18.66	62.21	100	0	P	H	
													H	
													H	
			11490	48.54	-25.46	74	56.73	40.17	14.63	62.99	100	0	P	V
			17235	48.16	-20.04	68.2	51.01	40.7	18.66	62.21	100	0	P	V
														V
802.11n HT20 CH 157 5785MHz		11570	48.03	-25.97	74	56.44	40	14.67	63.08	100	0	P	H	
		17355	49.89	-18.31	68.2	51.8	41.4	18.86	62.17	100	0	P	H	
													H	
													H	
			11570	47.92	-26.08	74	56.33	40	14.67	63.08	100	0	P	V
			17355	51.6	-16.6	68.2	53.51	41.4	18.86	62.17	100	0	P	V
														V
802.11n HT20 CH 165 5825MHz		11650	47.6	-26.4	74	56.44	39.66	14.71	63.21	100	0	P	H	
		17475	49.57	-18.63	68.2	50.25	42.43	19.03	62.14	100	0	P	H	
													H	
													H	
			11650	47.31	-26.69	74	56.15	39.66	14.71	63.21	100	0	P	V
			17475	50.8	-17.4	68.2	51.48	42.43	19.03	62.14	100	0	P	V
														V
Remark	1. No other spurious found.													
	2. All results are PASS against Peak and Average limit line.													



Band 4 5725~5850MHz
WIFI 802.11n HT40 (Band Edge @ 3m)

WIFI Ant. 1	Note	Frequency (MHz)	Level (dBμV/m)	Over Limit (dB)	Limit Line (dBμV/m)	Read Level (dBμV)	Antenna Factor (dB/m)	Path Loss (dB)	Preamp Factor (dB)	Ant Pos (cm)	Table Pos (deg)	Peak Avg. (P/A)	Pol. (H/V)
		5607.6	51.23	-16.97	68.2	39.65	31.8	9.99	30.21	100	136	P	H
		5695.8	52.07	-50.03	102.1	40.51	31.8	10.01	30.25	100	136	P	H
		5719	61.3	-49.22	110.52	49.62	31.93	10.01	30.26	100	136	P	H
		5723.8	61.4	-58.06	119.46	49.72	31.93	10.01	30.26	100	136	P	H
	*	5755	101.95	-	-	90.13	32.07	10.02	30.27	100	136	P	H
	*	5755	94.08	-	-	82.26	32.07	10.02	30.27	100	136	A	H
		5850.4	50.85	-70.44	121.29	38.88	32.2	10.1	30.33	100	136	P	H
		5859.2	51.04	-58.58	109.62	39.03	32.23	10.12	30.34	100	136	P	H
		5894.2	51.79	-39.16	90.95	39.68	32.3	10.17	30.36	100	136	P	H
		5942.2	51.27	-16.93	68.2	39.01	32.4	10.24	30.38	100	136	P	H
802.11n													H
HT40													H
CH 151		5604.6	52.51	-15.69	68.2	40.93	31.8	9.99	30.21	324	198	P	V
5755MHz		5696	52.71	-49.54	102.25	41.15	31.8	10.01	30.25	324	198	P	V
		5719.2	60.63	-49.95	110.58	48.95	31.93	10.01	30.26	324	198	P	V
		5725	60.95	-61.25	122.2	49.27	31.93	10.01	30.26	324	198	P	V
	*	5755	102.28	-	-	90.46	32.07	10.02	30.27	324	198	P	V
	*	5755	94.48	-	-	82.66	32.07	10.02	30.27	324	198	A	V
		5855	50.63	-60.17	110.8	38.62	32.23	10.11	30.33	324	198	P	V
		5860.2	51.14	-58.2	109.34	39.13	32.23	10.12	30.34	324	198	P	V
		5903	52.33	-32.11	84.44	40.21	32.3	10.18	30.36	324	198	P	V
		5940.6	52.73	-15.47	68.2	40.48	32.4	10.23	30.38	324	198	P	V
													V
													V



WIFI Ant. 1	Note	Frequency (MHz)	Level (dBμV/m)	Over Limit (dB)	Limit Line (dBμV/m)	Read Level (dBμV)	Antenna Factor (dB/m)	Path Loss (dB)	Preamp Factor (dB)	Ant Pos (cm)	Table Pos (deg)	Peak Avg. (P/A)	Pol. (H/V)
		5603.6	50.82	-17.38	68.2	39.24	31.8	9.99	30.21	100	137	P	H
		5663.2	50.23	-27.77	78	38.76	31.7	10	30.23	100	137	P	H
		5709.6	51.51	-56.38	107.89	39.89	31.87	10.01	30.26	100	137	P	H
		5722.2	51.87	-63.95	115.82	40.19	31.93	10.01	30.26	100	137	P	H
	*	5795	102.41	-	-	90.48	32.2	10.03	30.3	100	137	P	H
	*	5795	94.43	-	-	82.5	32.2	10.03	30.3	100	137	A	H
		5851	57.5	-62.42	119.92	45.53	32.2	10.1	30.33	100	137	P	H
		5867.2	55	-52.38	107.38	42.98	32.23	10.13	30.34	100	137	P	H
		5878	52.57	-50.4	102.97	40.5	32.27	10.14	30.34	100	137	P	H
		5939.6	53.64	-14.56	68.2	41.39	32.4	10.23	30.38	100	137	P	H
802.11n													H
HT40													H
CH 159		5632.2	51.21	-16.99	68.2	39.66	31.77	10	30.22	306	198	P	V
5795MHz		5666	50.83	-29.25	80.08	39.36	31.7	10	30.23	306	198	P	V
		5704.4	50.79	-55.64	106.43	39.16	31.87	10.01	30.25	306	198	P	V
		5725	51.04	-71.16	122.2	39.36	31.93	10.01	30.26	306	198	P	V
	*	5795	103.01	-	-	91.08	32.2	10.03	30.3	306	198	P	V
	*	5795	95.11	-	-	83.18	32.2	10.03	30.3	306	198	A	V
		5851.6	54.46	-64.09	118.55	42.49	32.2	10.1	30.33	306	198	P	V
		5860.4	57.09	-52.2	109.29	45.08	32.23	10.12	30.34	306	198	P	V
		5875.2	54.12	-50.93	105.05	42.05	32.27	10.14	30.34	306	198	P	V
		5929.6	51.48	-16.72	68.2	39.26	32.37	10.22	30.37	306	198	P	V
													V
													V
Remark	1. No other spurious found. 2. All results are PASS against Peak and Average limit line.												



**Band 4 5725~5850MHz
WIFI 802.11n HT40 (Harmonic @ 3m)**

WIFI Ant. 1	Note	Frequency (MHz)	Level (dBμV/m)	Over Limit (dB)	Limit Line (dBμV/m)	Read Level (dBμV)	Antenna Factor (dB/m)	Path Loss (dB)	Preamp Factor (dB)	Ant Pos (cm)	Table Pos (deg)	Peak Avg. (P/A)	Pol. (H/V)
802.11n HT40 CH 151 5755MHz		11510	49.41	-24.59	74	57.56	40.2	14.64	62.99	100	0	P	H
		17265	49.53	-18.67	68.2	52.22	40.8	18.71	62.2	100	0	P	H
													H
													H
		11510	49.45	-24.55	74	57.6	40.2	14.64	62.99	100	0	P	V
		17265	48.98	-19.22	68.2	51.67	40.8	18.71	62.2	100	0	P	V
													V
													V
802.11n HT40 CH 159 5795MHz		11590	48.45	-25.55	74	56.94	39.95	14.68	63.12	100	0	P	H
		17385	49.74	-18.46	68.2	51.27	41.73	18.9	62.16	100	0	P	H
													H
													H
		11590	47.96	-26.04	74	56.45	39.95	14.68	63.12	100	0	P	V
		17385	49.65	-18.55	68.2	51.18	41.73	18.9	62.16	100	0	P	V
													V
													V
Remark	1. No other spurious found. 2. All results are PASS against Peak and Average limit line.												



Band 4 5725~5850MHz
WIFI 802.11ac VHT80 (Band Edge @ 3m)

WIFI Ant. 1	Note	Frequency (MHz)	Level (dBμV/m)	Over Limit (dB)	Limit Line (dBμV/m)	Read Level (dBμV)	Antenna Factor (dB/m)	Path Loss (dB)	Preamp Factor (dB)	Ant Pos (cm)	Table Pos (deg)	Peak Avg. (P/A)	Pol. (H/V)	
		5622.4	50.97	-17.23	68.2	39.42	31.77	9.99	30.21	100	136	P	H	
		5688.6	57.92	-38.87	96.79	46.36	31.8	10.01	30.25	100	136	P	H	
		5718.6	61.64	-48.77	110.41	49.96	31.93	10.01	30.26	100	136	P	H	
		5720.2	62.63	-48.63	111.26	50.95	31.93	10.01	30.26	100	136	P	H	
	*	5775	98.62	-	-	86.76	32.13	10.02	30.29	100	136	P	H	
	*	5775	90.32	-	-	78.46	32.13	10.02	30.29	100	136	A	H	
		5853.8	61.1	-52.44	113.54	49.09	32.23	10.11	30.33	100	136	P	H	
		5858.6	59.89	-49.9	109.79	47.89	32.23	10.11	30.34	100	136	P	H	
		5875.4	54.52	-50.38	104.9	42.45	32.27	10.14	30.34	100	136	P	H	
		5950	52.18	-16.02	68.2	39.91	32.4	10.25	30.38	100	136	P	H	
802.11ac VHT80 CH 155 5775MHz													H	
													H	
			5602.6	52.68	-15.52	68.2	41.08	31.8	9.99	30.19	319	199	P	V
			5699.2	58.08	-46.53	104.61	46.52	31.8	10.01	30.25	319	199	P	V
			5718.4	61.56	-48.79	110.35	49.88	31.93	10.01	30.26	319	199	P	V
			5721	60.97	-52.11	113.08	49.29	31.93	10.01	30.26	319	199	P	V
		*	5775	99.13	-	-	87.27	32.13	10.02	30.29	319	199	P	V
		*	5775	91.58	-	-	79.72	32.13	10.02	30.29	319	199	A	V
			5853.8	60.42	-53.12	113.54	48.41	32.23	10.11	30.33	319	199	P	V
			5858.6	60.49	-49.3	109.79	48.49	32.23	10.11	30.34	319	199	P	V
			5876	54.22	-50.24	104.46	42.15	32.27	10.14	30.34	319	199	P	V
			5929.8	51.42	-16.78	68.2	39.2	32.37	10.22	30.37	319	199	P	V
														V
														V
	Remark	1. No other spurious found. 2. All results are PASS against Peak and Average limit line.												



**Band 4 5725~5850MHz
WIFI 802.11ac VHT80 (Harmonic @ 3m)**

WIFI Ant. 1	Note	Frequency (MHz)	Level (dBμV/m)	Over Limit (dB)	Limit Line (dBμV/m)	Read Level (dBμV)	Antenna Factor (dB/m)	Path Loss (dB)	Preamp Factor (dB)	Ant Pos (cm)	Table Pos (deg)	Peak Avg. (P/A)	Pol. (H/V)	
802.11ac VHT80 CH 155 5775MHz		11550	47.95	-26.05	74	56.29	40.05	14.66	63.05	100	0	P	H	
		17325	50.67	-17.53	68.2	52.96	41.07	18.82	62.18	100	0	P	H	
													H	
													H	
			11550	49.06	-24.94	74	57.4	40.05	14.66	63.05	100	0	P	V
			17325	50.03	-18.17	68.2	52.32	41.07	18.82	62.18	100	0	P	V
														V
														V
Remark	1. No other spurious found. 2. All results are PASS against Peak and Average limit line.													



Emission below 1GHz
5GHz WIFI 802.11n HT40 (LF @ 3m)

WIFI Ant. 1	Note	Frequency (MHz)	Level (dBμV/m)	Over Limit (dB)	Limit Line (dBμV/m)	Read Level (dBμV)	Antenna Factor (dB/m)	Path Loss (dB)	Preamp Factor (dB)	Ant Pos (cm)	Table Pos (deg)	Peak Avg. (P/A)	Pol. (H/V)	
5GHz 802.11n HT40 LF		30	24.64	-15.36	40	31.31	25.2	0.75	32.62	-	-	P	H	
		162.89	21.96	-21.54	43.5	36.4	16.21	1.85	32.5	-	-	P	H	
		205.57	21.25	-22.25	43.5	36.51	15.2	2.03	32.49	-	-	P	H	
		264.74	21.53	-24.47	46	31.75	20	2.3	32.52	-	-	P	H	
		554.77	26.62	-19.38	46	30.09	25.86	3.26	32.59	-	-	P	H	
		751.68	30.67	-15.33	46	30.92	28.4	3.65	32.3	100	0	P	H	
														H
														H
														H
														H
														H
														H
			30	33.22	-6.78	40	39.89	25.2	0.75	32.62	100	0	P	V
			82.38	20.47	-19.53	40	37.94	13.78	1.29	32.54	-	-	P	V
			146.4	19.72	-23.78	43.5	33.16	17.34	1.72	32.5	-	-	P	V
			259.89	20.28	-25.72	46	30.54	19.98	2.28	32.52	-	-	P	V
			586.78	27.85	-18.15	46	31.17	25.96	3.32	32.6	-	-	P	V
			794.36	30.68	-15.32	46	30.8	28.3	3.79	32.21	-	-	P	V
													V	
													V	
													V	
													V	
													V	
													V	
Remark	1. No other spurious found. 2. All results are PASS against limit line.													



Note symbol

*	Fundamental Frequency which can be ignored. However, the level of any unwanted emissions shall not exceed the level of the fundamental frequency.
!	Test result is over limit line.
P/A	Peak or Average
H/V	Horizontal or Vertical



A calculation example for radiated spurious emission is shown as below:

WIFI	Note	Frequency	Level	Over	Limit	Read	Antenna	Path	Preamp	Ant	Table	Peak	Pol.
Ant.				Limit	Line	Level	Factor	Loss	Factor	Pos	Pos	Avg.	
1		(MHz)	(dBμV/m)	(dB)	(dBμV/m)	(dBμV)	(dB/m)	(dB)	(dB)	(cm)	(deg)	(P/A)	(H/V)
802.11b		2390	55.45	-18.55	74	54.51	32.22	4.58	35.86	103	308	P	H
CH 01													
2412MHz		2390	43.54	-10.46	54	42.6	32.22	4.58	35.86	103	308	A	H

1. Path Loss(dB) = Cable loss(dB) + Filter loss(dB) + Attenuator loss(dB)
2. Level(dBμV/m) = Antenna Factor(dB/m) + Path Loss(dB) + Read Level(dBμV) - Preamp Factor(dB)
3. Over Limit(dB) = Level(dBμV/m) – Limit Line(dBμV/m)

For Peak Limit @ 2390MHz:

1. Level(dBμV/m)
= Antenna Factor(dB/m) + Path Loss(dB) + Read Level(dBμV) - Preamp Factor(dB)
= 32.22(dB/m) + 4.58(dB) + 54.51(dBμV) – 35.86 (dB)
= 55.45 (dBμV/m)
2. Over Limit(dB)
= Level(dBμV/m) – Limit Line(dBμV/m)
= 55.45(dBμV/m) – 74(dBμV/m)
= -18.55(dB)

For Average Limit @ 2390MHz:

1. Level(dBμV/m)
= Antenna Factor(dB/m) + Path Loss(dB) + Read Level(dBμV) - Preamp Factor(dB)
= 32.22(dB/m) + 4.58(dB) + 42.6(dBμV) – 35.86 (dB)
= 43.54 (dBμV/m)
2. Over Limit(dB) = Level(dBμV/m) – Limit Line(dBμV/m)
= 43.54(dBμV/m) – 54(dBμV/m)
= -10.46(dB)

Both peak and average measured complies with the limit line, so test result is “PASS”.



Appendix D. Radiated Spurious Emission Plots

Test Engineer :	Watt Tseng, Karl Hou, and BigShow Wang	Temperature :	23~26°C
		Relative Humidity :	50~57%

Band 4 - 5725~5850MHz
WIFI 802.11a (Band Edge @ 3m)

WIFI	Band 4 5725~5850MHz Band Edge @ 3m	
ANT	802.11a CH149 5745MHz	
1	Horizontal	Fundamental
Peak	<p>Site : 03CH15-HY Condition : PEAK_BE(B4)_16-24 3m 91200_15_1620 HORIZONTAL Detector : Peak Project : 942629 Mode : 30</p>	<p>Site : 03CH15-HY Condition : PEAK(UNIT) 3m 91200_15_1620 HORIZONTAL Detector : Peak Project : 942629 Mode : 30</p>



WIFI	Band 4 5725~5850MHz Band Edge @ 3m	
ANT	802.11a CH149 5745MHz	
1	Vertical	Fundamental
Peak	<p>Site : 03CH15-HY Condition : PEAK_BE(84)_16-24 3m 91200_15_1620 VERTICAL RBW:1000.000KHz VBW:3000.000KHz SWT:Auto Detector : Peak Project : 942629 Mode : 30</p>	<p>Site : 03CH15-HY Condition : PEAK(UNII) 3m 91200_15_1620 VERTICAL RBW:1000.000KHz VBW:3000.000KHz SWT:Auto Detector : Peak Project : 942629 Mode : 30</p>



WIFI	Band 4 5725~5850MHz Band Edge @ 3m	
ANT	802.11a CH157 5785MHz	
1	Horizontal	Fundamental
<p>Peak</p>	<p>Site : 03CH15-HY Condition : PEAK_BE(B4)_16-24 3m 91200_15_1620 HORIZONTAL Detector : Peak Project : 942629 Mode : 31</p>	<p>Site : 03CH15-HY Condition : PEAK(UNII) 3m 91200_15_1620 HORIZONTAL Detector : Peak Project : 942629 Mode : 31</p>
<p>Peak</p>	<p>Site : 03CH15-HY Condition : PEAK_BE(B4)_16-24 3m 91200_15_1620 HORIZONTAL Detector : Peak Project : 942629 Mode : 31</p>	<p>Left blank</p>



WIFI	Band 4 5725~5850MHz Band Edge @ 3m	
ANT	802.11a CH157 5785MHz	
1	Vertical	Fundamental
Peak	<p>Site : 03CH15-HY Condition : PEAK_BE(B4)_16-24 3m 91200_15_1620 VERTICAL RBW:1000.000KHz VBW:3000.000KHz SWT:Auto Detector : Peak Project : 942629 Mode : 31</p>	<p>Site : 03CH15-HY Condition : PEAK(UNII) 3m 91200_15_1620 VERTICAL RBW:1000.000KHz VBW:3000.000KHz SWT:Auto Detector : Peak Project : 942629 Mode : 31</p>
Peak	<p>Site : 03CH15-HY Condition : PEAK_BE(B4)_16-24 3m 91200_15_1620 VERTICAL RBW:1000.000KHz VBW:3000.000KHz SWT:Auto Detector : Peak Project : 942629 Mode : 31</p>	Left blank

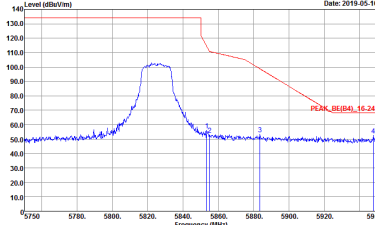
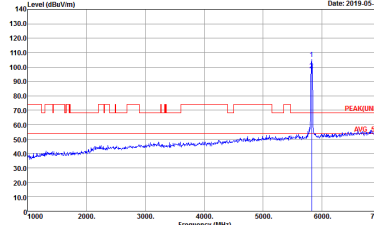

WIFI	Band 4 5725~5850MHz Band Edge @ 3m	
ANT	802.11a CH165 5825MHz	
1	Horizontal	Fundamental
Peak	 <p>Site : 03CH15-HY Condition : PEAK_BE(B4)_16-24 3m 91200_15_1620 HORIZONTAL Detector : Peak Project : 942629 Mode : 32</p>	 <p>Site : 03CH15-HY Condition : PEAK(UNII) 3m 91200_15_1620 HORIZONTAL Detector : Peak Project : 942629 Mode : 32</p>

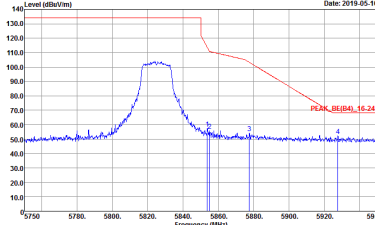
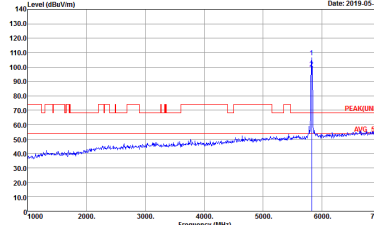

WIFI	Band 4 5725~5850MHz Band Edge @ 3m	
ANT	802.11a CH165 5825MHz	
1	Vertical	Fundamental
<p>Peak</p>	 <p>Date: 2019-05-10</p> <p>Site : 03CH15-HY Condition : PEAK_BE(B4)_16-24 3m 91200_15_1620 VERTICAL RBW:1000.000KHz VBW:3000.000KHz SWT:Auto Detector : Peak Project : 942629 Mode : 32</p>	 <p>Date: 2019-05-10</p> <p>Site : 03CH15-HY Condition : PEAK(U)B 3m 91200_15_1620 VERTICAL RBW:1000.000KHz VBW:3000.000KHz SWT:Auto Detector : Peak Project : 942629 Mode : 32</p>

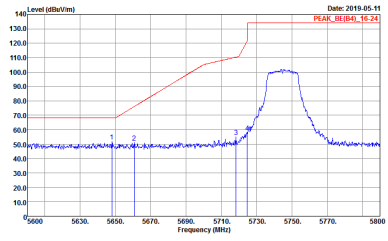
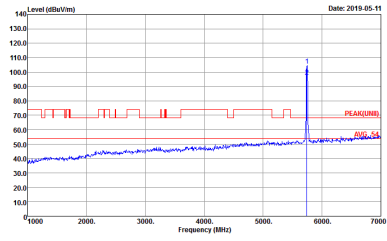

Band 4 5725~5850MHz
WIFI 802.11n HT20 (Band Edge @ 3m)

WIFI	Band 4 5725~5850MHz Band Edge @ 3m	
ANT	802.11n HT20 CH149 5745MHz	
1	Horizontal	Fundamental
Peak	 <p>Site : 03CH15-HY Condition : PEAK_8E(B4)_16-24 3m 91200_15_1620 HORIZONTAL Detector : Peak Project : 942629 Mode : 33</p>	 <p>Site : 03CH15-HY Condition : PEAK(UNIT) 3m 91200_15_1620 HORIZONTAL Detector : Peak Project : 942629 Mode : 33</p>



WIFI	Band 4 5725~5850MHz Band Edge @ 3m	
ANT	802.11n HT20 CH149 5745MHz	
1	Vertical	Fundamental
<p>Peak</p>	<p>Date: 2019-05-11 PEAK: 115.20</p> <p>Site : 03CH15-HY Condition : PEAK_8E(84)_16-24 3m 91200_15_1620 VERTICAL RBW:1000.000KHz VBW:3000.000KHz SWT:Auto Detector : Peak Project : 942629 Mode : 33</p>	<p>Date: 2019-05-11 PEAK: 115.20</p> <p>Site : 03CH15-HY Condition : PEAK(UNII) 3m 91200_15_1620 VERTICAL RBW:1000.000KHz VBW:3000.000KHz SWT:Auto Detector : Peak Project : 942629 Mode : 33</p>



WIFI	Band 4 5725~5850MHz Band Edge @ 3m	
ANT	802.11n HT20 CH157 5785MHz	
1	Horizontal	Fundamental
Peak	<p>Date: 2019-05-11 PEAK_BE(84)_15-20</p> <p>Site : 03CH15-HY Condition : PEAK_BE(84)_16-24 3m 91200_15_1620 HORIZONTAL RBW:1000.000KHz VBW:3000.000KHz SWT:Auto Detector : Peak Project : 942629 Mode : 34</p>	<p>Date: 2019-05-11 PEAK(84)_15-20</p> <p>Site : 03CH15-HY Condition : PEAK(UNII) 3m 91200_15_1620 HORIZONTAL RBW:1000.000KHz VBW:3000.000KHz SWT:Auto Detector : Peak Project : 942629 Mode : 34</p>
Peak	<p>Date: 2019-05-11 PEAK_BE(84)_16-24</p> <p>Site : 03CH15-HY Condition : PEAK_BE(84)_16-24 3m 91200_15_1620 HORIZONTAL RBW:1000.000KHz VBW:3000.000KHz SWT:Auto Detector : Peak Project : 942629 Mode : 34</p>	Left blank



WIFI	Band 4 5725~5850MHz Band Edge @ 3m	
ANT	802.11n HT20 CH157 5785MHz	
1	Vertical	Fundamental
Peak	<p>Site : 03CH15-HY Condition : PEAK_BE(B4)_16-24 3m 91200_15_1620 VERTICAL RBW:1000.000KHz VBW:3000.000KHz SWT:Auto Detector : Peak Project : 942629 Mode : 34</p>	<p>Site : 03CH15-HY Condition : PEAK(UNII) 3m 91200_15_1620 VERTICAL RBW:1000.000KHz VBW:3000.000KHz SWT:Auto Detector : Peak Project : 942629 Mode : 34</p>
Peak	<p>Site : 03CH15-HY Condition : PEAK_BE(B4)_16-24 3m 91200_15_1620 VERTICAL RBW:1000.000KHz VBW:3000.000KHz SWT:Auto Detector : Peak Project : 942629 Mode : 34</p>	Left blank

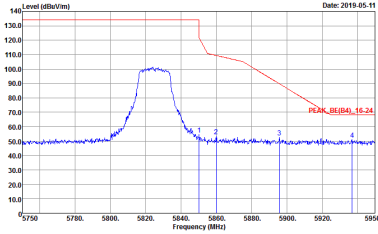
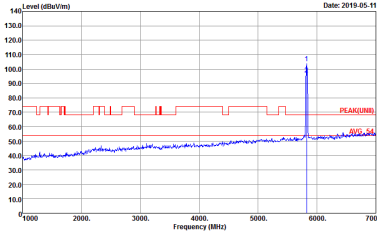

WIFI	Band 4 5725~5850MHz Band Edge @ 3m	
ANT	802.11n HT20 CH165 5825MHz	
1	Horizontal	Fundamental
Peak	 <p>Site : 03CH15-HY Condition : PEAK_BE(B4)_16-24 3m 91200_15_1620 HORIZONTAL Detector : Peak Project : 942629 Mode : 35</p>	 <p>Site : 03CH15-HY Condition : PEAK(UNII) 3m 91200_15_1620 HORIZONTAL Detector : Peak Project : 942629 Mode : 35</p>



WIFI	Band 4 5725~5850MHz Band Edge @ 3m	
ANT	802.11n HT20 CH165 5825MHz	
1	Vertical	Fundamental
Peak	<p>Site : 03CH15-HY Condition : PEAK_BE(B4)_16-24 3m 91200_15_1620 VERTICAL RBW:1000.000KHz VBW:3000.000KHz SWT:Auto Detector : Peak Project : 942629 Mode : 35</p>	<p>Site : 03CH15-HY Condition : PEAK(U)B 3m 91200_15_1620 VERTICAL RBW:1000.000KHz VBW:3000.000KHz SWT:Auto Detector : Peak Project : 942629 Mode : 35</p>



Band 4 5725~5850MHz
WIFI 802.11n HT40 (Band Edge @ 3m)

WIFI	Band 4 5725~5850MHz Band Edge @ 3m	
ANT	802.11n HT40 CH151 5755MHz	
1	Horizontal	Fundamental
Peak	<p>Site : 03CH15-HY Condition : PEAK_BE(84)_16-24 3m 91200_15_1620 HORIZONTAL Detector : Peak Project : 942629 Mode : 36</p>	<p>Site : 03CH15-HY Condition : PEAK(UNIT) 3m 91200_15_1620 HORIZONTAL Detector : Peak Project : 942629 Mode : 36</p>
Peak	<p>Site : 03CH15-HY Condition : PEAK_BE(84)_16-24 3m 91200_15_1620 HORIZONTAL Detector : Peak Project : 942629 Mode : 36</p>	Left blank

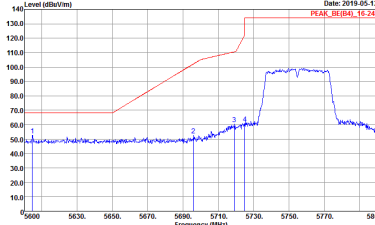
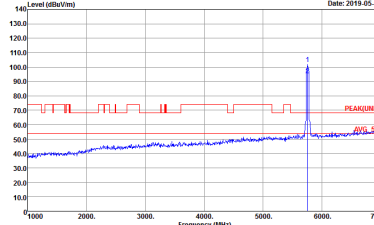
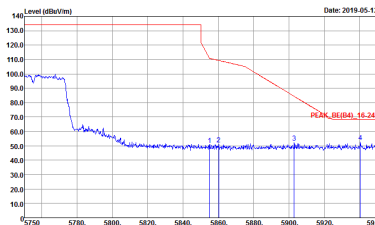

WIFI	Band 4 5725~5850MHz Band Edge @ 3m	
ANT	802.11n HT40 CH151 5755MHz	
1	Vertical	Fundamental
Peak	 <p>Site : 03CH15-HY Condition : PEAK_BE(84)_16-24 3m 91200_15_1620 VERTICAL RBW:1000.000KHz VBW:3000.000KHz SWT:Auto Detector : Peak Project : 942629 Mode : 36</p>	 <p>Site : 03CH15-HY Condition : PEAK(UNII) 3m 91200_15_1620 VERTICAL RBW:1000.000KHz VBW:3000.000KHz SWT:Auto Detector : Peak Project : 942629 Mode : 36</p>
Peak	 <p>Site : 03CH15-HY Condition : PEAK_BE(84)_16-24 3m 91200_15_1620 VERTICAL RBW:1000.000KHz VBW:3000.000KHz SWT:Auto Detector : Peak Project : 942629 Mode : 36</p>	Left blank



WIFI	Band 4 5725~5850MHz Band Edge @ 3m	
ANT	802.11n HT40 CH159 5795MHz	
1	Horizontal	Fundamental
Peak	<p> Date: 2019-05-12 PEAK_BE(84)_15-20 </p> <p> Site : 03CH15-HY Condition : PEAK_BE(84)_16-24 3m 91200_15_1620 HORIZONTAL RBW:1000.000KHz VBW:3000.000KHz SWT:Auto Detector : Peak Project : 942629 Mode : 37 </p>	<p> Date: 2019-05-12 PEAK(84)_15-20 </p> <p> Site : 03CH15-HY Condition : PEAK(UNII) 3m 91200_15_1620 HORIZONTAL RBW:1000.000KHz VBW:3000.000KHz SWT:Auto Detector : Peak Project : 942629 Mode : 37 </p>
Peak	<p> Date: 2019-05-12 PEAK_BE(84)_16-24 </p> <p> Site : 03CH15-HY Condition : PEAK_BE(84)_16-24 3m 91200_15_1620 HORIZONTAL RBW:1000.000KHz VBW:3000.000KHz SWT:Auto Detector : Peak Project : 942629 Mode : 37 </p>	Left blank



WIFI	Band 4 5725~5850MHz Band Edge @ 3m	
ANT	802.11n HT40 CH159 5795MHz	
1	Vertical	Fundamental
Peak	<p>Site : 03CH15-HY Condition : PEAK_BE(84)_16-24 3m 91200_15_1620 VERTICAL RBW:1000.000KHz VBW:3000.000KHz SWT:Auto Detector : Peak Project : 942629 Mode : 37</p>	<p>Site : 03CH15-HY Condition : PEAK(UNII) 3m 91200_15_1620 VERTICAL RBW:1000.000KHz VBW:3000.000KHz SWT:Auto Detector : Peak Project : 942629 Mode : 37</p>
Peak	<p>Site : 03CH15-HY Condition : PEAK_BE(84)_16-24 3m 91200_15_1620 VERTICAL RBW:1000.000KHz VBW:3000.000KHz SWT:Auto Detector : Peak Project : 942629 Mode : 37</p>	Left blank



Band 4 5725~5850MHz
WIFI 802.11ac VHT80 (Band Edge @ 3m)

WIFI	Band 4 5725~5850MHz Band Edge @ 3m	
ANT	802.11ac VHT80 CH155 5775MHz	
1	Horizontal	Fundamental
Peak	<p>Site : 03CH15-HY Condition : PEAK_BE(84)_16-24 3m 91200_15_1620 HORIZONTAL RBW:1000.000kHz VBW:3000.000kHz SWT:Auto Detector : Peak Project : 942629 Mode : 38</p>	<p>Site : 03CH15-HY Condition : PEAK(UNIT) 3m 91200_15_1620 HORIZONTAL RBW:1000.000kHz VBW:3000.000kHz SWT:Auto Detector : Peak Project : 942629 Mode : 38</p>
Peak	<p>Site : 03CH15-HY Condition : PEAK_BE(84)_16-24 3m 91200_15_1620 HORIZONTAL RBW:1000.000kHz VBW:3000.000kHz SWT:Auto Detector : Peak Project : 942629 Mode : 38</p>	Left blank



WIFI	Band 4 5725~5850MHz Band Edge @ 3m	
ANT	802.11ac VHT80 CH155 5775MHz	
1	Vertical	Fundamental
Peak	<p>Site : 03CH15-HY Condition : PEAK_BE(84)_16-24 3m 91200_15_1620 VERTICAL RBW:1000.000KHz VBW:3000.000KHz SWT:Auto Detector : Peak Project : 942629 Mode : 38</p>	<p>Site : 03CH15-HY Condition : PEAK(UNII) 3m 91200_15_1620 VERTICAL RBW:1000.000KHz VBW:3000.000KHz SWT:Auto Detector : Peak Project : 942629 Mode : 38</p>
Peak	<p>Site : 03CH15-HY Condition : PEAK_BE(84)_16-24 3m 91200_15_1620 VERTICAL RBW:1000.000KHz VBW:3000.000KHz SWT:Auto Detector : Peak Project : 942629 Mode : 38</p>	Left blank



Band 4 - 5725~5850MHz
WIFI 802.11a (Harmonic @ 3m)

WIFI	Band 4 5725~5850MHz Harmonic @ 3m	
ANT	802.11a CH149 5745MHz	
1	Horizontal	Vertical
Peak Avg.		



WIFI	Band 4 5725~5850MHz Harmonic @ 3m	
ANT	802.11a CH157 5785MHz	
1	Horizontal	Vertical
<p>Peak Avg.</p>	<p>Site : 03CH15-HY Condition : PEAK(UNII) 3m 91200_15_1620 HORIZONTAL Detector : Peak Project : 942629 Mode : 31</p>	<p>Site : 03CH15-HY Condition : PEAK(UNII) 3m 91200_15_1620 VERTICAL Detector : Peak Project : 942629 Mode : 31</p>

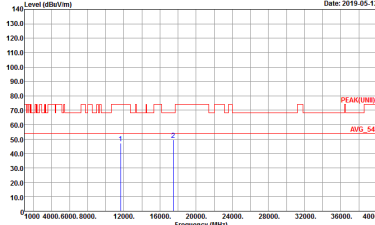
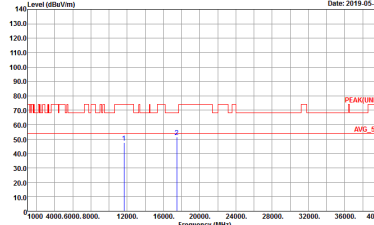

WIFI	Band 4 5725~5850MHz Harmonic @ 3m	
ANT	802.11a CH165 5825MHz	
1	Horizontal	Vertical
<p>Peak Avg.</p>	 <p>Site : 03CH15-HY Condition : PEAK(UNII) 3m 91200_15_1620 HORIZONTAL Detector : Peak Project : 942629 Mode : 32</p>	 <p>Site : 03CH15-HY Condition : PEAK(UNII) 3m 91200_15_1620 VERTICAL Detector : Peak Project : 942629 Mode : 32</p>



Band 4 5725~5850MHz
WIFI 802.11n HT20 (Harmonic @ 3m)

Table with 2 columns: WIFI (Band 4 5725~5850MHz Harmonic @ 3m), ANT (802.11n HT20 CH149 5745MHz). Row 1: 1, Horizontal, Vertical. Each plot shows Level (dBu/m) vs Frequency (MHz) with Peak and Avg markers.



WIFI	Band 4 5725~5850MHz Harmonic @ 3m	
ANT	802.11n HT20 CH157 5785MHz	
1	Horizontal	Vertical
<p>Peak Avg.</p>	<p>Site : 03CH15-HY Condition : PEAK(UNII) 3m 91200_15_1620 HORIZONTAL Detector : Peak Project : 942629 Mode : 34</p>	<p>Site : 03CH15-HY Condition : PEAK(UNII) 3m 91200_15_1620 VERTICAL Detector : Peak Project : 942629 Mode : 34</p>



WIFI	Band 4 5725~5850MHz Harmonic @ 3m	
ANT	802.11n HT20 CH165 5825MHz	
1	Horizontal	Vertical
Peak Avg.	<p>Site : 03CH15-HY Condition : PEAK(UNII) 3m 91200_15_1620 HORIZONTAL Detector : Peak Project : 942629 Mode : 35</p>	<p>Site : 03CH15-HY Condition : PEAK(UNII) 3m 91200_15_1620 VERTICAL Detector : Peak Project : 942629 Mode : 35</p>



Band 4 5725~5850MHz
WIFI 802.11n HT40 (Harmonic @ 3m)

Table with 2 columns: WIFI (Band 4 5725~5850MHz Harmonic @ 3m), ANT (802.11n HT40 CH151 5755MHz). Row 1: 1, Horizontal, Vertical. Each plot shows Level (dBu/m) vs Frequency (MHz) with Peak and Avg markers.



WIFI	Band 4 5725~5850MHz Harmonic @ 3m	
ANT	802.11n HT40 CH159 5795MHz	
1	Horizontal	Vertical
Peak Avg.	<p>Site : 03CH15-HY Condition : PEAK(UNII) 3m 91200_15_1620 HORIZONTAL Detector : Peak Project : 942629 Mode : 37</p>	<p>Site : 03CH15-HY Condition : PEAK(UNII) 3m 91200_15_1620 VERTICAL Detector : Peak Project : 942629 Mode : 37</p>



**Band 4 5725~5850MHz
WIFI 802.11ac VHT80 (Harmonic @ 3m)**

WIFI	Band 4 5725~5850MHz Harmonic @ 3m	
ANT	802.11ac VHT80 CH155 5775MHz	
1	Horizontal	Vertical
Peak Avg.	<p>Site : 03CH15-HY Condition : PEAK(UNII) 3m 91200_15_1620 HORIZONTAL Detector : Peak Project : 942629 Mode : 38</p>	<p>Site : 03CH15-HY Condition : PEAK(UNII) 3m 91200_15_1620 VERTICAL Detector : Peak Project : 942629 Mode : 38</p>



Emission below 1GHz
5GHz WIFI 802.11n HT40 (LF)

WIFI	5GHz 5725~5850MHz	
ANT	802.11n HT40 LF	
1	Horizontal	Vertical
QP / Peak	<p>Site : 03CH15-FY Condition : QP 3m BTL0G_15_41912 HORIZONTAL Detector : Peak Project : 942629 Mode : 39</p>	<p>Site : 03CH15-FY Condition : QP 3m BTL0G_15_41912 VERTICAL Detector : Peak Project : 942629 Mode : 39</p>



Appendix E. Duty Cycle Plots

Band	Duty Cycle (%)	T(us)	1/T(kHz)	VBW Setting	Duty Factor (dB)
802.11a	98.11	-	-	10Hz	0.08
5GHz 802.11n HT20	97.47	1925.00	0.52	1kHz	0.11
5GHz 802.11n HT40	96.06	952.00	1.05	3kHz	0.17
5GHz 802.11ac VHT20	97.98	1945.00	0.51	1kHz	0.09
5GHz 802.11ac VHT40	96.56	954.00	1.05	3kHz	0.15
5GHz 802.11ac VHT80	92.02	461.00	2.17	3kHz	0.36

802.11a

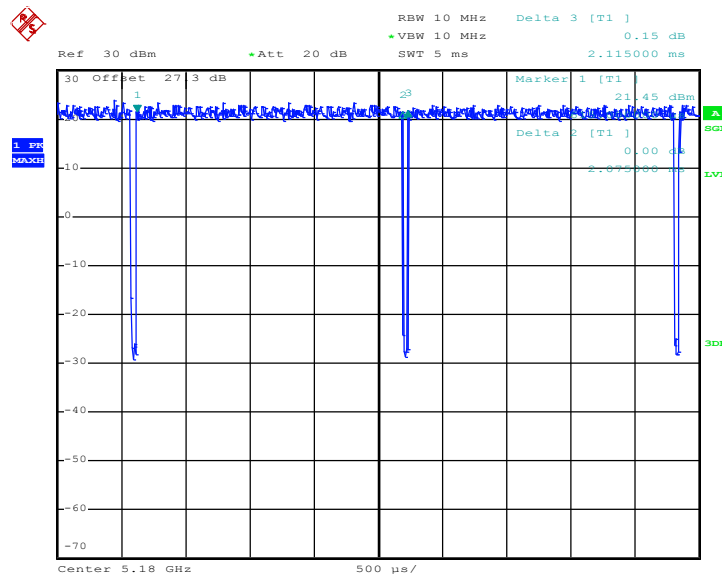

Date: 7.MAY.2019 15:24:07



802.11n HT20

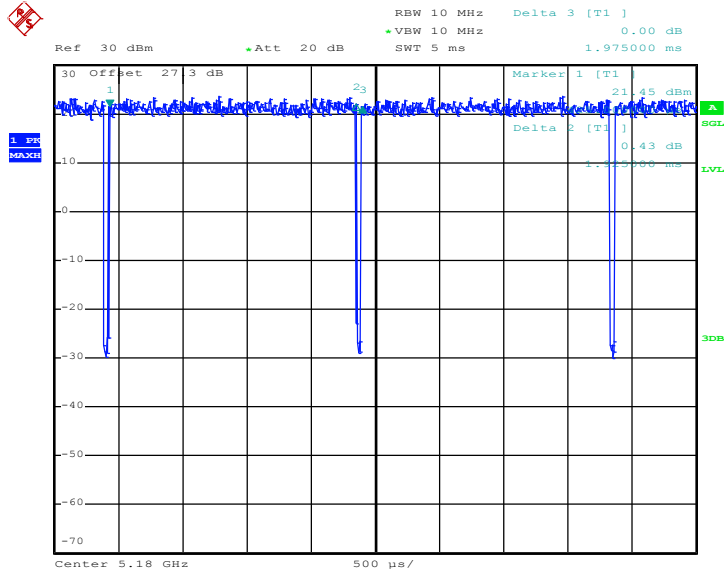

Date: 7.MAY.2019 15:25:54

802.11n HT40

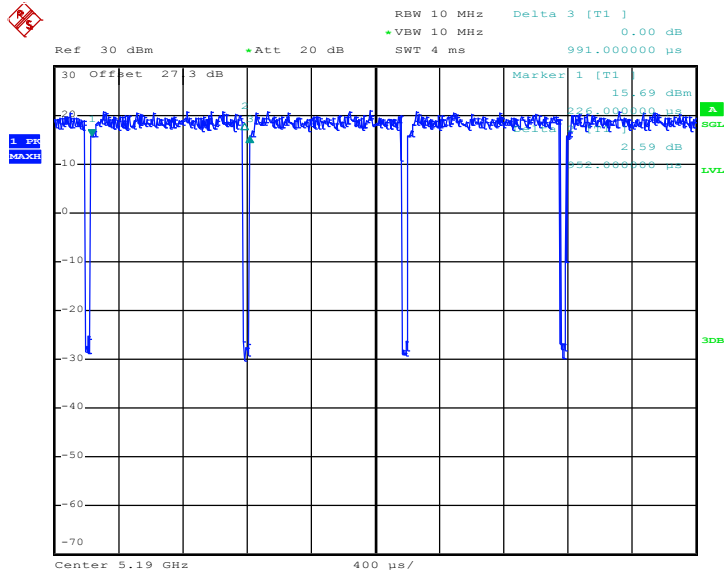

Date: 7.MAY.2019 15:26:57



802.11ac VHT20

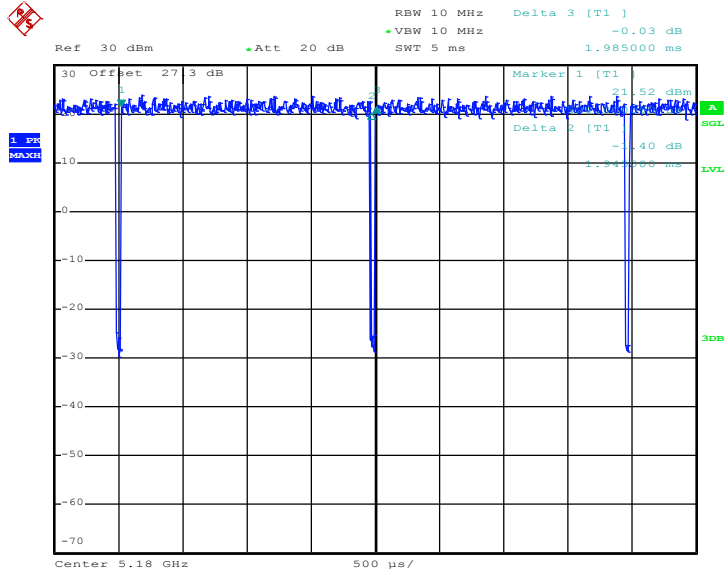

Date: 7.MAY.2019 15:28:28

802.11ac VHT40

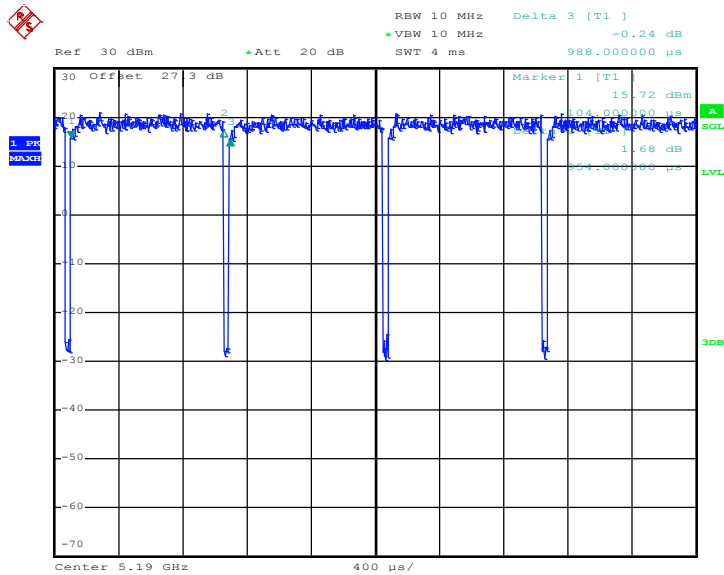

Date: 7.MAY.2019 15:29:40



802.11ac VHT80

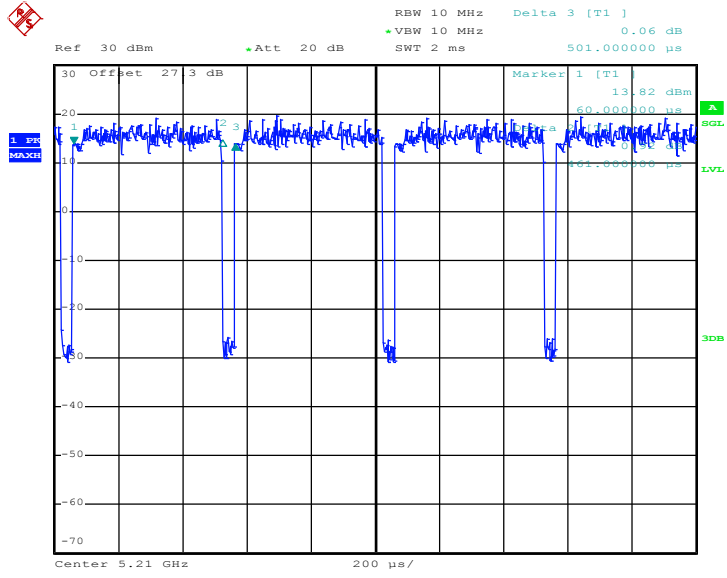

Date: 7.MAY.2019 15:31:11

————THE END————