



FCC RADIO TEST REPORT

FCC ID : IHDT56YC1
Equipment : Mobile Cellular Phone
Brand Name : Motorola
Model Name : XT2010-1
Applicant : Motorola Mobility LLC
222 W,Merchandise Mart Plaza, Chicago IL 60654 USA
Manufacturer : Motorola Mobility LLC
222 W,Merchandise Mart Plaza, Chicago IL 60654 USA
Standard : 47 CFR Part 2, 22(H), 24(E), 27

The product was received on Apr. 26, 2019 and testing was started from May 07, 2019 and completed on May 16, 2019. We, SPORTON INTERNATIONAL INC. EMC & Wireless Communications Laboratory, would like to declare that the tested sample has been evaluated in accordance with the test procedures given in ANSI / TIA-603-E and has been in compliance with the applicable technical standards.

The report must not be used by the client to claim product certification, approval, or endorsement by TAF or any agency of government.

The test results in this report apply exclusively to the tested model / sample. Without written approval of SPORTON INTERNATIONAL INC. EMC & Wireless Communications Laboratory, the test report shall not be reproduced except in full.

Approved by: Jones Tsai

SPORTON INTERNATIONAL INC. EMC & Wireless Communications Laboratory

No. 52, Huaya 1st Rd., Guishan Dist., Taoyuan City, Taiwan (R.O.C.)



Table of Contents

History of this test report.....	3
Summary of Test Result.....	4
1 General Description	6
1.1 Product Feature of Equipment Under Test.....	6
1.2 Product Specification of Equipment Under Test.....	8
1.3 Modification of EUT	9
1.4 Emission Designator.....	9
1.5 Testing Location	11
1.6 Applicable Standards.....	12
2 Test Configuration of Equipment Under Test	13
2.1 Test Mode.....	13
2.2 Connection Diagram of Test System.....	16
2.3 Support Unit used in test configuration and system	16
2.4 Measurement Results Explanation Example.....	17
2.5 Frequency List of Low/Middle/High Channels	18
3 Conducted Test Items.....	22
3.1 Measuring Instruments	22
3.2 Conducted Output Power and ERP/EIRP	23
3.3 Peak-to-Average Ratio	24
3.4 Occupied Bandwidth.....	25
3.5 Conducted Band Edge	26
3.6 Conducted Spurious Emission	28
3.7 Frequency Stability	29
4 Radiated Test Items	30
4.1 Measuring Instruments	30
4.2 Radiated Spurious Emission Measurement	31
5 List of Measuring Equipment.....	32
6 Uncertainty of Evaluation.....	34
Appendix A. Test Results of Conducted Test	
Appendix B. Test Results of ERP/EIRP and Radiated Test	
Appendix C. Test Setup Photographs	



History of this test report

Report No.	Version	Description	Issued Date
FG942629B	01	Initial issue of report	Jun. 06, 2019



Summary of Test Result

Report Clause	Ref Std. Clause	Test Items	Result (PASS/FAIL)	Remark
3.2	§2.1046	Conducted Output Power	Reporting only	-
	§22.913 (a)(2)	Effective Radiated Power (Band 5)	Pass	
	§27.50 (c)(10)	Effective Radiated Power (Band 12) (Band 17))		
	§24.232 (c) §27.50 (h)(2)	Equivalent Isotropic Radiated Power (Band 2) (Band 7) (Band 38) (Band 41)		
	§27.50 (d)(4)	Equivalent Isotropic Radiated Power (Band 4) (Band 66)		
3.3	§24.232 (d) §27.50 (d)(5)	Peak-to-Average Ratio	Pass	-
3.4	§2.1049	Occupied Bandwidth	Reporting only	-
3.5	§2.1051 §22.917 (a) §24.238 (a) §27.53 (g) §27.53 (h)	Conducted Band Edge Measurement (Band 2) (Band 4) (Band 5) (Band 12) (Band 17) (Band 66)	Pass	-
	§2.1051 §27.53 (m)(4)	Conducted Band Edge Measurement (Band 7) (Band 38) (Band 41)		
3.6	§2.1051 §22.917 (a) §24.238 (a) §27.53 (g) §27.53 (h)	Conducted Spurious Emission (Band 2) (Band 4) (Band 5) (Band 12) (Band 17) (Band 66)	Pass	-
	§2.1051 §27.53 (m)(4)	Conducted Spurious Emission (Band 7) (Band 38) (Band 41)		



Report Clause	Ref Std. Clause	Test Items	Result (PASS/FAIL)	Remark
3.7	§2.1055 §22.355 §24.235 §27.54	Frequency Stability Temperature & Voltage	Pass	-
4.2	§2.1053 §22.917 (a) §24.238 (a) §27.53 (g) §27.53 (h)	Radiated Spurious Emission (Band 2) (Band 4) (Band 5) (Band 12) (Band 17) (Band 66)	Pass	Under limit 10.65 dB at 7806.000 MHz
	§2.1053 §27.53 (m)(4)	Radiated Spurious Emission (Band 7) (Band 38) (Band 41)		

Declaration of Conformity:
The test results with all measurement uncertainty excluded are presented in accordance with the regulation limits or requirements declared by manufacturers.
Comments and Explanations:
The declared of product specification for EUT presented in the report are provided by the manufacturer, and the manufacturer takes all the responsibilities for the accuracy of product specification.

Reviewed by: Wii Chang

Report Producer: Yimin Ho



1 General Description

1.1 Product Feature of Equipment Under Test

Product Feature	
Equipment	Mobile Cellular Phone
Brand Name	Motorola
Model Name	XT2010-1
FCC ID	IHDT56YC1
Sample 1	EUT with Single SIM
Sample 2	EUT with Dual SIM
IMEI Code	Conducted : IMEI: 354156100004854 Radiation : IMEI: 354156100005851
EUT supports Radios application	GSM/EGPRS/WCDMA/HSPA/LTE/GNSS/NFC/FM WLAN 11b/g/n HT20 WLAN 11a/n HT20/HT40 WLAN 11ac VHT20/VHT40/VHT80 Bluetooth BR/EDR/LE
HW Version	DVT2A
EUT Stage	Identical Prototype

Remark:

1. The above EUT's information was declared by manufacturer.
2. All test items were performed with Sample 1.



Accessory List	
AC Adapter 1 (US)	Brand Name : Motorola
	Model Name : SC-51
	Manufacturer : Salom
AC Adapter 1 (EU)	Brand Name : Motorola
	Model Name : SC-52
	Manufacturer : Salom
AC Adapter 1 (UK)	Brand Name : Motorola
	Model Name : SC-53
	Manufacturer : Salom
AC Adapter 1 (AR)	Brand Name : Motorola
	Model Name : SC-56
	Manufacturer : Salom
AC Adapter 1 (BR)	Brand Name : Motorola
	Model Name : SC-57
	Manufacturer : Salom
AC Adapter 2 (US)	Brand Name : Motorola
	Model Name : SC-51
	Manufacturer : Chenyang
AC Adapter 2 (EU)	Brand Name : Motorola
	Model Name : SC-52
	Manufacturer : Chenyang
AC Adapter 2 (UK)	Brand Name : Motorola
	Model Name : SC-53
	Manufacturer : Chenyang
AC Adapter 2 (AR)	Brand Name : Motorola
	Model Name : SC-56
	Manufacturer : Chenyang
AC Adapter 3 (BR)	Brand Name : Motorola
	Model Name : SC-57
	Manufacturer : Flex
AC Adapter 4 (BR)	Brand Name : Motorola
	Model Name : SC-57
	Manufacturer : Cliptech
Battery	Brand Name : Motorola
	Model Name : KP50
	Manufacturer : SCUD
Earphone 1	Brand Name : Motorola
	Model Name : SH38C37773
	Manufacturer : Lianyun
Earphone 2	Brand Name : Motorola
	Model Name : SH38C44959
	Manufacturer : Cosonic
USB Cable 1	Brand Name : Luxshare
	Model Name : SC18C24368
USB Cable 2	Brand Name : Saibao
	Model Name : SC18C24367



1.2 Product Specification of Equipment Under Test

Standards-related Product Specification	
Tx Frequency	LTE Band 2: 1850.7 MHz ~ 1909.3 MHz LTE Band 4: 1710.7 MHz ~ 1754.3 MHz LTE Band 5: 824.7 MHz ~ 848.3 MHz LTE Band 7: 2502.5 MHz ~ 2567.5 MHz LTE Band 12: 699.7 MHz ~ 715.3 MHz LTE Band 17: 706.5 MHz ~ 713.5 MHz LTE Band 38: 2572.5 MHz ~ 2617.5 MHz LTE Band 41: 2498.5 MHz ~ 2687.5 MHz LTE Band 66: 1710.7 MHz ~ 1779.3 MHz
Rx Frequency	LTE Band 2: 1930.7 MHz ~ 1989.3 MHz LTE Band 4: 2110.7 MHz ~ 2154.3 MHz LTE Band 5: 869.7 MHz ~ 893.3 MHz LTE Band 7: 2622.5 MHz ~ 2687.5 MHz LTE Band 12: 729.7 MHz ~ 745.3 MHz LTE Band 17: 736.5 MHz ~ 743.5 MHz LTE Band 38: 2572.5 MHz ~ 2617.5 MHz LTE Band 41: 2498.5 MHz ~ 2687.5 MHz LTE Band 66: 2110.7 MHz ~ 2199.3 MHz
Bandwidth	LTE Band 2: 1.4MHz / 3MHz / 5MHz / 10MHz / 15MHz / 20MHz LTE Band 4: 1.4MHz / 3MHz / 5MHz / 10MHz / 15MHz / 20MHz LTE Band 5: 1.4MHz / 3MHz / 5MHz / 10MHz LTE Band 7: 5MHz / 10MHz / 15MHz / 20MHz LTE Band 12: 1.4MHz / 3MHz / 5MHz / 10MHz LTE Band 17: 5MHz / 10MHz LTE Band 38: 5MHz / 10MHz / 15MHz / 20MHz LTE Band 41: 5MHz / 10MHz / 15MHz / 20MHz LTE Band 66: 1.4MHz / 3MHz / 5MHz / 10MHz / 15MHz / 20MHz
Maximum Output Power to Antenna	LTE Band 2: 22.95 dBm LTE Band 4: 22.94 dBm LTE Band 5: 22.79 dBm LTE Band 7: 23.28 dBm LTE Band 12: 22.94 dBm LTE Band 17: 22.86 dBm LTE Band 38: 23.12 dBm LTE Band 41: 22.88 dBm LTE Band 66: 22.80 dBm
Antenna Type	Dipole Antenna
Antenna Gain	LTE Band 2: -1.0 dBi LTE Band 4: 1.0 dBi LTE Band 5: -3.0 dBi LTE Band 7: 1.0 dBi LTE Band 12: -3.0 dBi LTE Band 17: -3.0 dBi LTE Band 38: 1.0 dBi LTE Band 41: 1.0 dBi LTE Band 66: 1.0 dBi
Type of Modulation	QPSK / 16QAM / 64QAM



1.3 Modification of EUT

No modifications are made to the EUT during all test items.

1.4 Emission Designator

LTE Band 2		QPSK			16QAM			64QAM		
BW (MHz)	Frequency Range (MHz)	Emission Designator (99%OBW)	Frequency Tolerance (ppm)	Maximum EIRP(W)	Emission Designator (99%OBW)	Frequency Tolerance (ppm)	Maximum EIRP(W)	Emission Designator (99%OBW)	Frequency Tolerance (ppm)	Maximum EIRP(W)
1.4	1850.7 ~ 1909.3	1M09G7D	-	0.1507	1M10W7D	-	0.1276	1M09W7D	-	0.1005
3	1851.5 ~ 1908.5	2M72G7D	-	0.1517	2M73W7D	-	0.1291	2M73W7D	-	0.1012
5	1852.5 ~ 1907.5	4M51G7D	-	0.1560	4M50W7D	-	0.1309	4M50W7D	-	0.1033
10	1855.0 ~ 1905.0	9M05G7D	0.0071	0.1552	9M03W7D	-	0.1355	9M03W7D	-	0.1074
15	1857.5 ~ 1902.5	13M5G7D	-	0.1549	13M5W7D	-	0.1346	13M5W7D	-	0.1062
20	1860.0 ~ 1900.0	17M9G7D	-	0.1567	17M9W7D	-	0.1330	17M9W7D	-	0.1045
LTE Band 4		QPSK			16QAM			64QAM		
BW (MHz)	Frequency Range (MHz)	Emission Designator (99%OBW)	Frequency Tolerance (ppm)	Maximum EIRP(W)	Emission Designator (99%OBW)	Frequency Tolerance (ppm)	Maximum EIRP(W)	Emission Designator (99%OBW)	Frequency Tolerance (ppm)	Maximum EIRP(W)
1.4	1710.7 ~ 1754.3	1M10G7D	-	0.2443	1M10W7D	-	0.2037	1M09W7D	-	0.1614
3	1711.5 ~ 1753.5	2M73G7D	-	0.2460	2M72W7D	-	0.2051	2M72W7D	-	0.1626
5	1712.5 ~ 1752.5	4M51G7D	-	0.2460	4M50W7D	-	0.2084	4M50W7D	-	0.1648
10	1715.0 ~ 1750.0	9M07G7D	0.0063	0.2466	9M01W7D	-	0.2089	9M01W7D	-	0.1656
15	1717.5 ~ 1747.5	13M5G7D	-	0.2472	13M5W7D	-	0.2123	13M5W7D	-	0.1679
20	1720.0 ~ 1745.0	17M9G7D	-	0.2477	17M9W7D	-	0.2084	18M0W7D	-	0.1637
LTE Band 5		QPSK			16QAM			64QAM		
BW (MHz)	Frequency Range (MHz)	Emission Designator (99%OBW)	Frequency Tolerance (ppm)	Maximum ERP(W)	Emission Designator (99%OBW)	Frequency Tolerance (ppm)	Maximum ERP(W)	Emission Designator (99%OBW)	Frequency Tolerance (ppm)	Maximum EIRP(W)
1.4	824.7 ~ 848.3	1M09G7D	-	0.0566	1M09W7D	-	0.0509	1M09W7D	-	0.0401
3	825.5 ~ 847.5	2M72G7D	-	0.0570	2M75W7D	-	0.0509	2M73W7D	-	0.0408
5	826.5 ~ 846.5	4M50G7D	-	0.0574	4M50W7D	-	0.0521	4M50W7D	-	0.0406
10	829.0 ~ 844.0	9M03G7D	0.0148	0.0581	9M03W7D	-	0.0521	9M03W7D	-	0.0406
LTE Band 7		QPSK			16QAM			64QAM		
BW (MHz)	Frequency Range (MHz)	Emission Designator (99%OBW)	Frequency Tolerance (ppm)	Maximum EIRP(W)	Emission Designator (99%OBW)	Frequency Tolerance (ppm)	Maximum EIRP(W)	Emission Designator (99%OBW)	Frequency Tolerance (ppm)	Maximum EIRP(W)
5	2502.5 ~ 2567.5	4M52G7D	-	0.2541	4M49W7D	-	0.2143	4M53W7D	-	0.1675
10	2505.0 ~ 2565.0	9M15G7D	0.0047	0.2535	9M05W7D	-	0.2128	9M05W7D	-	0.1706
15	2507.5 ~ 2562.5	13M5G7D	-	0.2649	13M5W7D	-	0.2286	13M5W7D	-	0.1758
20	2510.0 ~ 2560.0	17M9G7D	-	0.2679	17M9W7D	-	0.2307	17M9W7D	-	0.1774



LTE Band 12		QPSK			16QAM			64QAM		
BW (MHz)	Frequency Range (MHz)	Emission Designator (99%OBW)	Frequency Tolerance (ppm)	Maximum ERP(W)	Emission Designator (99%OBW)	Frequency Tolerance (ppm)	Maximum ERP(W)	Emission Designator (99%OBW)	Frequency Tolerance (ppm)	Maximum EIRP(W)
1.4	699.7 ~ 715.3	1M09G7D	-	0.0600	1M09W7D	-	0.0508	1M09W7D	-	0.0402
3	700.5 ~ 714.5	2M72G7D	-	0.0585	2M74W7D	-	0.0506	2M73W7D	-	0.0395
5	701.5 ~ 713.5	4M50G7D	-	0.0586	4M50W7D	-	0.0506	4M51W7D	-	0.0395
10	704.0 ~ 711.0	9M07G7D	0.0204	0.0601	9M01W7D	-	0.0497	9M05W7D	-	0.0388
LTE Band 17		QPSK			16QAM			64QAM		
BW (MHz)	Frequency Range (MHz)	Emission Designator (99%OBW)	Frequency Tolerance (ppm)	Maximum ERP(W)	Emission Designator (99%OBW)	Frequency Tolerance (ppm)	Maximum ERP(W)	Emission Designator (99%OBW)	Frequency Tolerance (ppm)	Maximum EIRP(W)
5	706.5 ~ 713.5	4M49G7D	-	0.0589	4M51W7D	-	0.0505	4M49W7D	-	0.0397
10	709.0 ~ 711.0	9M03G7D	0.0187	0.0590	9M03W7D	-	0.0500	9M01W7D	-	0.0391
LTE Band 38		QPSK			16QAM			64QAM		
BW (MHz)	Frequency Range (MHz)	Emission Designator (99%OBW)	Frequency Tolerance (ppm)	Maximum EIRP(W)	Emission Designator (99%OBW)	Frequency Tolerance (ppm)	Maximum EIRP(W)	Emission Designator (99%OBW)	Frequency Tolerance (ppm)	Maximum EIRP(W)
5	2572.5 ~ 2617.5	4M53G7D	-	0.2523	4M51W7D	-	0.2065	4M51W7D	-	0.1556
10	2575.0 ~ 2615.0	9M01G7D	0.0076	0.2541	9M07W7D	-	0.2094	9M13W7D	-	0.1563
15	2577.5 ~ 2612.5	13M4G7D	-	0.2564	13M4W7D	-	0.2128	13M4W7D	-	0.1596
20	2580.0 ~ 2610.0	17M9G7D	-	0.2582	17M8W7D	-	0.2099	17M9W7D	-	0.1592
LTE Band 41		QPSK			16QAM			64QAM		
BW (MHz)	Frequency Range (MHz)	Emission Designator (99%OBW)	Frequency Tolerance (ppm)	Maximum EIRP(W)	Emission Designator (99%OBW)	Frequency Tolerance (ppm)	Maximum EIRP(W)	Emission Designator (99%OBW)	Frequency Tolerance (ppm)	Maximum EIRP(W)
5	2537.5~2652.5	4M54G7D	-	0.2438	4M50W7D	-	0.2018	4M51W7D	-	0.1493
10	2540.0~2650.0	9M03G7D	0.0070	0.2443	9M05W7D	-	0.2023	9M03W7D	-	0.1503
15	2542.5~2647.5	13M5G7D	-	0.2399	13M5W7D	-	0.2009	13M5W7D	-	0.1524
20	2545.0~2645.0	17M9G7D	-	0.2432	17M9W7D	-	0.1977	17M9W7D	-	0.1493



LTE Band 66		QPSK			16QAM			64QAM		
BW (MHz)	Frequency Range (MHz)	Emission Designator (99%OBW)	Frequency Tolerance (ppm)	Maximum EIRP(W)	Emission Designator (99%OBW)	Frequency Tolerance (ppm)	Maximum EIRP(W)	Emission Designator (99%OBW)	Frequency Tolerance (ppm)	Maximum EIRP(W)
1.4	1710.7 ~ 1779.3	1M09G7D	-	0.2312	1M09W7D	-	0.1950	1M09W7D	-	0.1552
3	1711.5 ~ 1778.5	2M73G7D	-	0.2307	2M72W7D	-	0.1945	2M73W7D	-	0.1542
5	1712.5 ~ 1777.5	4M49G7D	-	0.2312	4M51W7D	-	0.1991	4M50W7D	-	0.1563
10	1715.0 ~ 1775.0	9M05G7D	0.0066	0.2355	9M05W7D	-	0.1991	9M01W7D	-	0.1578
15	1717.5 ~ 1772.5	13M5G7D	-	0.2388	13M5W7D	-	0.1991	13M5W7D	-	0.1567
20	1720.0 ~ 1770.0	17M9G7D	-	0.2399	18M0W7D	-	0.2037	17M9W7D	-	0.1585

1.5 Testing Location

Test Site	SPORTON INTERNATIONAL INC.
Test Site Location	No.52, Huaya 1st Rd., Guishan Dist., Taoyuan City, Taiwan (R.O.C.) TEL: +886-3-327-3456 FAX: +886-3-328-4978
Test Site No.	Sporton Site No. TH05-HY
Test Engineer	Chester Chen
Temperature	23~25°C
Relative Humidity	51~56%

Note: The test site complies with ANSI C63.4 2014 requirement.

Test Site	SPORTON INTERNATIONAL INC.
Test Site Location	No.58, Aly. 75, Ln. 564, Wenhua 3rd, Rd., Guishan Dist., Taoyuan City, Taiwan (R.O.C.) TEL: +886-3-327-0868 FAX: +886-3-327-0855
Test Site No.	Sporton Site No. 03CH11-HY
Test Engineer	Hao Hsu, Fu Chen and Ken Wu
Temperature	24~25°C
Relative Humidity	53~57%

Note: The test site complies with ANSI C63.4 2014 requirement.

FCC Designation No.: TW1190 and TW0007



1.6 Applicable Standards

According to the specifications of the manufacturer, the EUT must comply with the requirements of the following standards:

- ♦ ANSI C63.26-2015
- ♦ ANSI / TIA-603-E
- ♦ 47 CFR Part 2, 22(H), 24(E), 27
- ♦ FCC KDB 971168 D01 Power Meas. License Digital Systems v03r01
- ♦ FCC KDB 412172 D01 Determining ERP and EIRP v01r01

Remark:

1. All test items were verified and recorded according to the standards and without any deviation during the test.
2. This EUT has also been tested and complied with the requirements of FCC Part 15, Subpart B, recorded in a separate test report.



2 Test Configuration of Equipment Under Test

2.1 Test Mode

Antenna port conducted and radiated test items listed below are performed according to KDB 971168 D01 Power Meas. License Digital Systems v03r01 with maximum output power.

For radiated measurement, pre-scanned in three orthogonal panels, X, Y, Z. The worst cases (X Plane without Accessory for LTE Band 66, Y Plane with Accessory for LTE Band 12, Z Plane without Accessory for LTE Band 2 and Z Plane with Accessory for LTE Band 4 / 5 / 7 / 17 / 38 / 41) were recorded in this report.

Test Items	Band	Bandwidth (MHz)						Modulation			RB #			Test Channel		
		1.4	3	5	10	15	20	QPSK	16QAM	64QAM	1	Half	Full	L	M	H
Max. Output Power	2	v	v	v	v	v	v	v	v	v	v	v	v	v	v	v
	4	v	v	v	v	v	v	v	v	v	v	v	v	v	v	v
	5	v	v	v	v	-	-	v	v	v	v	v	v	v	v	v
	7	-	-	v	v	v	v	v	v	v	v	v	v	v	v	v
	12	v	v	v	v	-	-	v	v	v	v	v	v	v	v	v
	17	-	-	v	v	-	-	v	v	v	v	v	v	v	v	v
	38	-	-	v	v	v	v	v	v	v	v	v	v	v	v	v
	41	-	-	v	v	v	v	v	v	v	v	v	v	v	v	v
	66	v	v	v	v	v	v	v	v	v	v	v	v	v	v	v
Peak-to-Average Ratio	2						v	v	v	v	v		v	v	v	v
	4						v	v	v	v	v		v	v	v	v
	5				v	-	-	v	v	v	v		v	v	v	v
	7	-	-				v	v	v	v	v		v	v	v	v
	12				v	-	-	v	v	v	v		v	v	v	v
	17	-	-		v	-	-	v	v	v	v		v	v	v	v
	38	-	-				v	v	v	v	v		v	v	v	v
	41	-	-				v	v	v	v	v		v	v	v	v
	66						v	v	v	v	v		v	v	v	v



Test Items	Band	Bandwidth (MHz)						Modulation			RB #			Test Channel		
		1.4	3	5	10	15	20	QPSK	16QAM	64QAM	1	Half	Full	L	M	H
26dB and 99% Bandwidth	2	v	v	v	v	v	v	v	v	v			v	v	v	v
	4	v	v	v	v	v	v	v	v	v			v	v	v	v
	5	v	v	v	v	-	-	v	v	v			v	v	v	v
	7	-	-	v	v	v	v	v	v	v			v	v	v	v
	12	v	v	v	v	-	-	v	v	v			v	v	v	v
	17	-	-	v	v	-	-	v	v	v			v	v	v	v
	38	-	-	v	v	v	v	v	v	v			v	v	v	v
	41	-	-	v	v	v	v	v	v	v			v	v	v	v
66	v	v	v	v	v	v	v	v	v			v	v	v	v	
Conducted Band Edge	2	v	v	v	v	v	v	v	v	v	v		v	v		v
	4	v	v	v	v	v	v	v	v	v	v		v	v		v
	5	v	v	v	v	-	-	v	v	v	v		v	v		v
	7	-	-	v	v	v	v	v	v	v	v		v	v		v
	12	v	v	v	v	-	-	v	v	v	v		v	v		v
	17	-	-	v	v	-	-	v	v	v	v		v	v		v
	38	-	-	v	v	v	v	v	v	v	v		v	v		v
	41	-	-	v	v	v	v	v	v	v	v		v	v		v
66	v	v	v	v	v	v	v	v	v	v		v	v		v	
Conducted Spurious Emission	2	v	v	v	v	v	v	v	v	v	v			v	v	v
	4	v	v	v	v	v	v	v	v	v	v			v	v	v
	5	v	v	v	v	-	-	v	v	v	v			v	v	v
	7	-	-	v	v	v	v	v	v	v	v			v	v	v
	12	v	v	v	v	-	-	v	v	v	v			v	v	v
	17	-	-	v	v	-	-	v	v	v	v			v	v	v
	38	-	-	v	v	v	v	v	v	v	v			v	v	v
	41	-	-	v	v	v	v	v	v	v	v			v	v	v
66	v	v	v	v	v	v	v	v	v	v			v	v	v	



Test Items	Band	Bandwidth (MHz)						Modulation			RB #			Test Channel			
		1.4	3	5	10	15	20	QPSK	16QAM	64QAM	1	Half	Full	L	M	H	
Frequency Stability	2				v			v						v		v	
	4				v			v						v		v	
	5				v	-	-	v						v		v	
	7	-	-		v			v						v		v	
	12				v	-	-	v						v		v	
	17	-	-		v	-	-	v						v		v	
	38	-	-		v			v						v		v	
	41	-	-		v			v						v		v	
	66				v			v						v		v	
E.R.P / E.I.R.P	2	v	v	v	v	v	v	v	v	v	v	v			v	v	v
	4	v	v	v	v	v	v	v	v	v	v	v			v	v	v
	5	v	v	v	v	-	-	v	v	v	v	v			v	v	v
	7	-	-	v	v	v	v	v	v	v	v	v			v	v	v
	12	v	v	v	v	-	-	v	v	v	v	v			v	v	v
	17	-	-	v	v	-	-	v	v	v	v	v			v	v	v
	38	-	-	v	v	v	v	v	v	v	v	v			v	v	v
	41	-	-	v	v	v	v	v	v	v	v	v			v	v	v
	66	v	v	v	v	v	v	v	v	v	v	v			v	v	v
Radiated Spurious Emission	2	Worst Case												v	v	v	
	4	Worst Case												v	v	v	
	5	Worst Case												v	v	v	
	7	Worst Case												v	v	v	
	12	Worst Case												v	v	v	
	17	Worst Case												v	v	v	
	38	Worst Case												v	v	v	
	41	Worst Case												v	v	v	
	66	Worst Case												v	v	v	
Remark	<ol style="list-style-type: none"> The mark "v" means that this configuration is chosen for testing The mark "-" means that this bandwidth is not supported. The device is investigated from 30MHz to 10 times of fundamental signal for radiated spurious emission test under different RB size/offset and modulations in exploratory test. Subsequently, only the worst case emissions are reported. All the radiated test cases were performed with Adapter 1 (Salom US), Earphone 1 and USB Cable 1. 																

2.2 Connection Diagram of Test System

<EUT with Accesory>

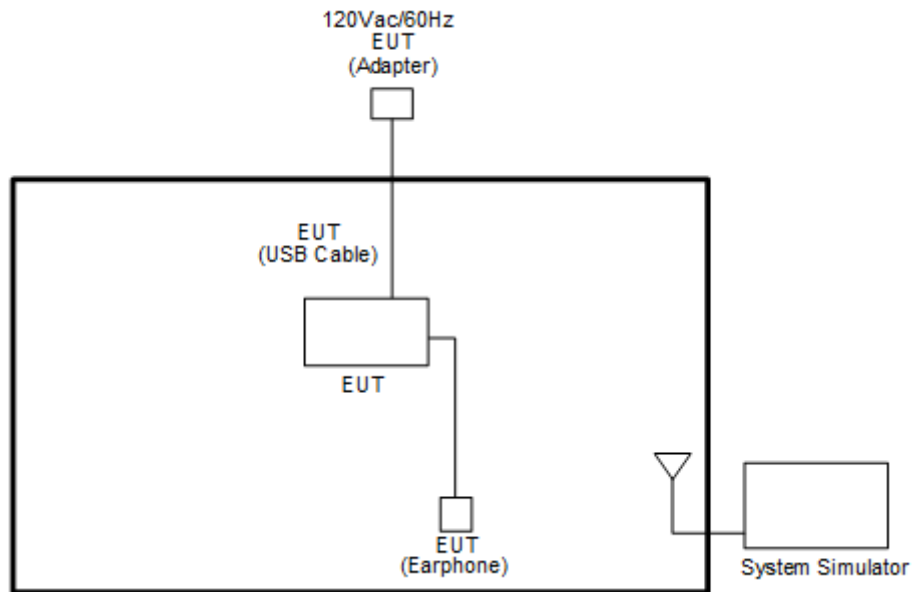

<EUT without Accesory>

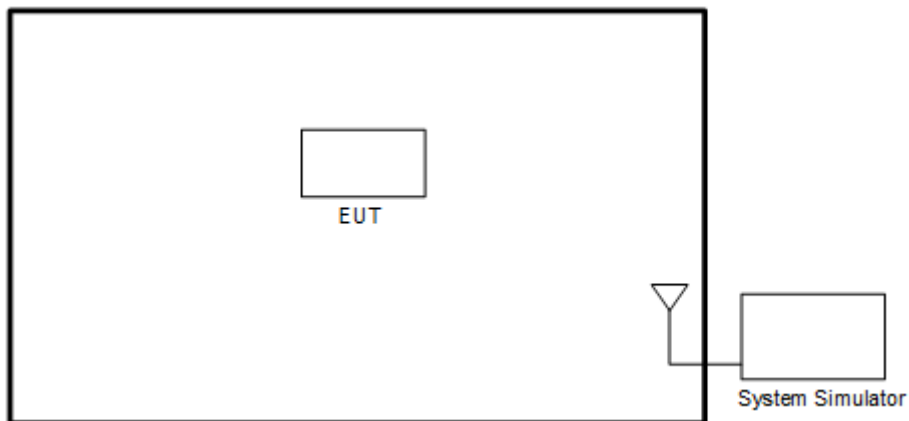

2.3 Support Unit used in test configuration and system

Item	Equipment	Trade Name	Model No.	FCC ID	Data Cable	Power Cord
1.	System Simulator	Anritsu	MT8821C	N/A	N/A	Unshielded, 1.8 m



2.4 Measurement Results Explanation Example

For all conducted test items:

The offset level is set in the spectrum analyzer to compensate the RF cable loss and attenuator factor between EUT conducted output port and spectrum analyzer. With the offset compensation, the spectrum analyzer reading level is exactly the EUT RF output level.

The spectrum analyzer offset is derived from RF cable loss and attenuator factor.

Offset = RF cable loss + attenuator factor.

Following shows an offset computation example with cable loss 4.2 dB and 10dB attenuator.

Example :

$$\begin{aligned} \text{Offset(dB)} &= \text{RF cable loss(dB)} + \text{attenuator factor(dB)}. \\ &= 4.2 + 10 = 14.2 \text{ (dB)} \end{aligned}$$



2.5 Frequency List of Low/Middle/High Channels

LTE Band 2 Channel and Frequency List				
BW [MHz]	Channel/Frequency(MHz)	Lowest	Middle	Highest
20	Channel	18700	18900	19100
	Frequency	1860	1880	1900
15	Channel	18675	18900	19125
	Frequency	1857.5	1880	1902.5
10	Channel	18650	18900	19150
	Frequency	1855	1880	1905
5	Channel	18625	18900	19175
	Frequency	1852.5	1880	1907.5
3	Channel	18615	18900	19185
	Frequency	1851.5	1880	1908.5
1.4	Channel	18607	18900	19193
	Frequency	1850.7	1880	1909.3

LTE Band 4 Channel and Frequency List				
BW [MHz]	Channel/Frequency(MHz)	Lowest	Middle	Highest
20	Channel	20050	20175	20300
	Frequency	1720	1732.5	1745
15	Channel	20025	20175	20325
	Frequency	1717.5	1732.5	1747.5
10	Channel	20000	20175	20350
	Frequency	1715	1732.5	1750
5	Channel	19975	20175	20375
	Frequency	1712.5	1732.5	1752.5
3	Channel	19965	20175	20385
	Frequency	1711.5	1732.5	1753.5
1.4	Channel	19957	20175	20393
	Frequency	1710.7	1732.5	1754.3



LTE Band 5 Channel and Frequency List				
BW [MHz]	Channel/Frequency(MHz)	Lowest	Middle	Highest
10	Channel	20450	20525	20600
	Frequency	829	836.5	844
5	Channel	20425	20525	20625
	Frequency	826.5	836.5	846.5
3	Channel	20415	20525	20635
	Frequency	825.5	836.5	847.5
1.4	Channel	20407	20525	20643
	Frequency	824.7	836.5	848.3

LTE Band 7 Channel and Frequency List				
BW [MHz]	Channel/Frequency(MHz)	Lowest	Middle	Highest
20	Channel	20850	21100	21350
	Frequency	2510	2535	2560
15	Channel	20825	21100	21375
	Frequency	2507.5	2535	2562.5
10	Channel	20800	21100	21400
	Frequency	2505	2535	2565
5	Channel	20775	21100	21425
	Frequency	2502.5	2535	2567.5

LTE Band 12 Channel and Frequency List				
BW [MHz]	Channel/Frequency(MHz)	Lowest	Middle	Highest
10	Channel	23060	23095	23130
	Frequency	704	707.5	711
5	Channel	23035	23095	23155
	Frequency	701.5	707.5	713.5
3	Channel	23025	23095	23165
	Frequency	700.5	707.5	714.5
1.4	Channel	23017	23095	23173
	Frequency	699.7	707.5	715.3



LTE Band 17 Channel and Frequency List				
BW [MHz]	Channel/Frequency(MHz)	Lowest	Middle	Highest
10	Channel	23780	23790	23800
	Frequency	709	710	711
5	Channel	23755	23790	23825
	Frequency	706.5	710	713.5

LTE Band 38 Channel and Frequency List				
BW [MHz]	Channel/Frequency(MHz)	Lowest	Middle	Highest
20	Channel	37850	38000	38150
	Frequency	2580.0	2595.0	2610.0
15	Channel	37825	38000	38175
	Frequency	2577.5	2595.0	2612.5
10	Channel	37800	38000	38200
	Frequency	2575.0	2595.0	2615.0
5	Channel	37775	38000	38225
	Frequency	2572.5	2595.0	2617.5

LTE Band 41 2535MHz ~ 2655MHz Channel and Frequency List				
BW [MHz]	Channel/Frequency(MHz)	Lowest	Middle	Highest
20	Channel	40140	40640	41140
	Frequency	2545.0	2595.0	2645.0
15	Channel	40115	40640	41165
	Frequency	2542.5	2595.0	2647.5
10	Channel	40090	40640	41190
	Frequency	2540.0	2595.0	2650.0
5	Channel	40065	40640	41215
	Frequency	2537.5	2595.0	2652.5



LTE Band 66 Channel and Frequency List				
BW [MHz]	Channel/Frequency(MHz)	Lowest	Middle	Highest
20	Channel	132072	132322	132572
	Frequency	1720	1745	1770
15	Channel	132047	132322	132597
	Frequency	1717.5	1745	1772.5
10	Channel	132022	132322	132622
	Frequency	1715	1745	1775
5	Channel	131997	132322	132647
	Frequency	1712.5	1745	1777.5
3	Channel	131987	132322	132657
	Frequency	1711.5	1745	1778.5
1.4	Channel	131979	132322	132665
	Frequency	1710.7	1745	1779.3

3 Conducted Test Items

3.1 Measuring Instruments

See list of measuring instruments of this test report.

3.1.1 Test Setup

3.1.2 Conducted Output Power

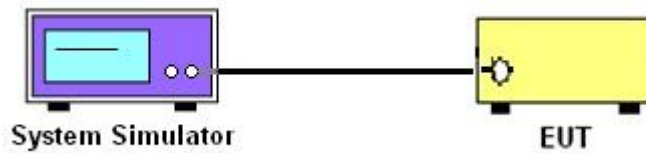

3.1.3 Peak-to-Average Ratio, Occupied Bandwidth ,Conducted Band-Edge and Conducted Spurious Emission

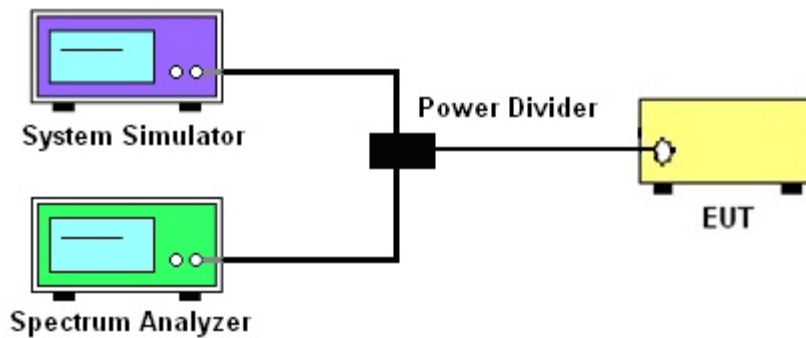

3.1.4 Frequency Stability

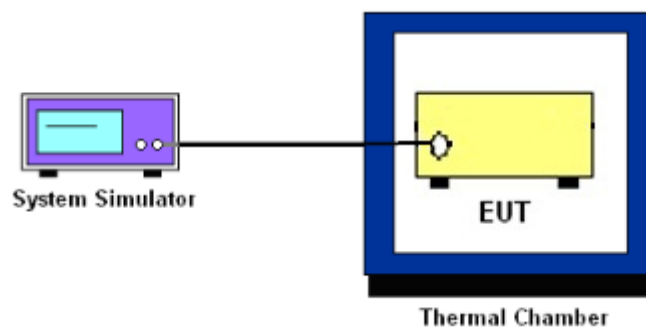

3.1.5 Test Result of Conducted Test

Please refer to Appendix A.



3.2 Conducted Output Power and ERP/EIRP

3.2.1 Description of the Conducted Output Power Measurement and ERP/EIRP Measurement

A system simulator was used to establish communication with the EUT. Its parameters were set to force the EUT transmitting at maximum output power. The measured power in the radio frequency on the transmitter output terminals shall be reported.

The ERP of mobile transmitters must not exceed 7 Watts for LTE Band 5.

The ERP of mobile transmitters must not exceed 3 Watts for LTE Band 12 and Band 17.

The EIRP of mobile transmitters must not exceed 2 Watts for LTE Band 2, Band 7, Band 38 and Band 41.

The EIRP of mobile transmitters must not exceed 1 Watts for LTE Band 4 and Band 66.

According to KDB 412172 D01 Power Approach,

$EIRP = P_T + G_T - L_C$, $ERP = EIRP - 2.15$, where

P_T = transmitter output power in dBm

G_T = gain of the transmitting antenna in dBi

L_C = signal attenuation in the connecting cable between the transmitter and antenna in dB

3.2.2 Test Procedures

1. The transmitter output port was connected to the system simulator.
2. Set EUT at maximum power through the system simulator.
3. Select lowest, middle, and highest channels for each band and different modulation.
4. Measure and record the power level from the system simulator.



3.3 Peak-to-Average Ratio

3.3.1 Description of the PAR Measurement

Power Complementary Cumulative Distribution Function (CCDF) curves provide a means for characterizing the power peaks of a digitally modulated signal on a statistical basis. A CCDF curve depicts the probability of the peak signal amplitude exceeding the average power level. Most contemporary measurement instrumentation include the capability to produce CCDF curves for an input signal provided that the instrument's resolution bandwidth can be set wide enough to accommodate the entire input signal bandwidth. In measuring transmissions in this band using an average power technique, the peak-to-average ratio (PAR) of the transmission may not exceed 13 dB.

3.3.2 Test Procedures

The testing follows ANSI C63.26-2015 Section 5.2.6

1. The EUT was connected to spectrum and system simulator via a power divider.
2. Set the CCDF (Complementary Cumulative Distribution Function) option in spectrum analyzer.
3. The highest RF powers were measured and recorded the maximum PAPR level associated with a probability of 0.1 %.
4. Record the deviation as Peak to Average Ratio.



3.4 Occupied Bandwidth

3.4.1 Description of Occupied Bandwidth Measurement

The occupied bandwidth is the width of a frequency band such that, below the lower and above the upper frequency limits, the mean powers emitted are each equal to a specified percentage 0.5% of the total mean transmitted power.

The 26 dB emission bandwidth is defined as the frequency range between two points, one above and one below the carrier frequency, at which the spectral density of the emission is attenuated 26 dB below the maximum in-band spectral density of the modulated signal. Spectral density (power per unit bandwidth) is to be measured with a detector of resolution bandwidth equal to approximately 1.0% of the emission bandwidth.

3.4.2 Test Procedures

The testing follows ANSI C63.26-2015 Section 5.4.3 (26dB) and Section 5.4.4 (99OB)

1. The EUT was connected to spectrum analyzer and system simulator via a power divider.
2. The spectrum analyzer center frequency is set to the nominal EUT channel center frequency. The span range for the spectrum analyzer shall be between two and five times the anticipated OBW.
3. The nominal resolution bandwidth (RBW) shall be in the range of 1 to 5 % of the anticipated OBW, and the VBW shall be at least 3 times the RBW.
4. Set the detection mode to peak, and the trace mode to max hold.
5. Determine the reference value: Set the EUT to transmit a modulated signal. Allow the trace to stabilize. Set the spectrum analyzer marker to the highest level of the displayed trace.
(this is the reference value)
6. Determine the “-26 dB down amplitude” as equal to (Reference Value – X).
7. Place two markers, one at the lowest and the other at the highest frequency of the envelope of the spectral display such that each marker is at or slightly below the “-X dB down amplitude” determined in step 6. If a marker is below this “-X dB down amplitude” value it shall be placed as close as possible to this value. The OBW is the positive frequency difference between the two markers.
8. Use the 99 % power bandwidth function of the spectrum analyzer and report the measured bandwidth.



3.5 Conducted Band Edge

3.5.1 Description of Conducted Band Edge Measurement

22.917(a)

For operations in the 824 – 849 MHz band, the FCC limit is $43 + 10\log_{10}(P[\text{Watts}])$ dB below the transmitter power $P(\text{Watts})$ in a 100kHz bandwidth. However, in the 1MHz bands immediately outside and adjacent to the licensee's frequency block, a resolution bandwidth of at least one percent of the emission bandwidth of the fundamental emission of the transmitter may be employed.

24.238 (a)

For operations in the 1850-1910 and 1930-1990 MHz band, the FCC limit is $43 + 10\log_{10}(P[\text{Watts}])$ dB below the transmitter power $P(\text{Watts})$ in a 1MHz bandwidth. However, in the 1 MHz bands immediately outside and adjacent to the frequency block a resolution bandwidth of at least one percent of the emission bandwidth of the fundamental emission of the transmitter may be employed.

27.53 (g)

For operations in the 600MHz band and 698 -746 MHz band, the FCC limit is $43 + 10\log_{10}(P[\text{Watts}])$ dB below the transmitter power $P(\text{Watts})$ in a 100 kHz bandwidth. However, in the 100 kilohertz bands immediately outside and adjacent to a licensee's frequency block, a resolution bandwidth of at least 30 kHz may be employed.

27.53 (h)

For operations in the 1710 – 1755 MHz band, the FCC limit is $43 + 10\log_{10}(P[\text{Watts}])$ dB below the transmitter power $P(\text{Watts})$ in a 1 MHz bandwidth. However, in the 1MHz bands immediately outside and adjacent to the licensee's frequency block, a resolution bandwidth of at least one percent of the emission bandwidth of the fundamental emission of the transmitter may be employed.

**27.53(m)(4)**

For mobile digital stations, the attenuation factor shall be not less than $40 + 10 \log (P)$ dB on all frequencies between the channel edge and 5 megahertz from the channel edge, $43 + 10 \log (P)$ dB on all frequencies between 5 megahertz and X megahertz from the channel edge, and $55 + 10 \log (P)$ dB on all frequencies more than X megahertz from the channel edge, where X is the greater of 6 megahertz or the actual emission bandwidth as defined in paragraph (m)(6) of this section. In addition, the attenuation factor shall not be less that $43 + 10 \log (P)$ dB on all frequencies between 2490.5 MHz and 2496 MHz and $55 + 10 \log (P)$ dB at or below 2490.5 MHz. Mobile Satellite Service licensees operating on frequencies below 2495 MHz may also submit a documented interference complaint against BRS licensees operating on channel BRS Channel 1 on the same terms and conditions as adjacent channel BRS or EBS licensees.

3.5.2 Test Procedures

The testing follows FCC KDB 971168 D01 v03r01 Section 6.1.

1. The EUT was connected to spectrum analyzer and system simulator via a power divider.
2. The band edges of low and high channels for the highest RF powers were measured.
3. Set RBW \geq 1% EBW in the 1MHz band immediately outside and adjacent to the band edge.
4. Beyond the 1 MHz band from the band edge, RBW=1MHz was used.
5. Set spectrum analyzer with RMS detector.
6. The RF fundamental frequency should be excluded against the limit line in the operating frequency band.
7. Checked that all the results comply with the emission limit line.
The limit line is derived from $43 + 10\log(P)$ dB below the transmitter power P(Watts)
8. For LTE Band 7, 38, 41, the other 40 dB, and 55 dB have additionally applied same calculation above.



3.6 Conducted Spurious Emission

3.6.1 Description of Conducted Spurious Emission Measurement

The power of any emission outside of the authorized operating frequency ranges must be lower than the transmitter power (P) by a factor of at least $43 + 10 \log (P)$ dB.

For Band 7,38,41:

The power of any emission outside of the authorized operating frequency ranges must be lower than the transmitter power (P) by a factor of at least $55 + 10 \log (P)$ dB.

It is measured by means of a calibrated spectrum analyzer and scanned from 30 MHz up to a frequency including its 10th harmonic.

3.6.2 Test Procedures

FCC KDB 971168 D01 v03r01 Section 6.1.

1. The EUT was connected to spectrum analyzer and system simulator via a power divider.
2. The RF output of EUT was connected to the spectrum analyzer by RF cable and attenuator.
The path loss was compensated to the results for each measurement.
3. The middle channel for the highest RF power within the transmitting frequency was measured.
4. The conducted spurious emission for the whole frequency range was taken.
5. Make the measurement with the spectrum analyzer's RBW = 1MHz, VBW = 3MHz.
6. Set spectrum analyzer with RMS detector.
7. Taking the record of maximum spurious emission.
8. The RF fundamental frequency should be excluded against the limit line in the operating frequency band.
9. The limit line is derived from $43 + 10\log(P)$ dB below the transmitter power P(Watts)
10. For Band 7, 38, 41
The limit line is derived from $55 + 10\log(P)$ dB below the transmitter power P(Watts)



3.7 Frequency Stability

3.7.1 Description of Frequency Stability Measurement

22.355

The frequency stability shall be measured by variation of ambient temperature and variation of primary supply voltage to ensure that the fundamental emission stays within the authorized frequency block. The frequency stability of the transmitter shall be maintained within $\pm 0.00025\%$ ($\pm 2.5\text{ppm}$) of the center frequency.

24.235 & 27.54

The frequency stability shall be sufficient to ensure that the fundamental emission stays within the authorized frequency block.

3.7.2 Test Procedures for Temperature Variation

The testing follows FCC KDB 971168 D01 v03r01 Section 9.0.

1. The EUT was set up in the thermal chamber and connected with the system simulator.
2. With power OFF, the temperature was decreased to -30°C and the EUT was stabilized before testing. Power was applied and the maximum change in frequency was recorded within one minute.
3. With power OFF, the temperature was raised in 10°C step up to 50°C . The EUT was stabilized at each step for at least half an hour. Power was applied and the maximum frequency change was recorded within one minute.

3.7.3 Test Procedures for Voltage Variation

The testing follows FCC KDB 971168 D01 v03r01 Section 9.0.

1. The EUT was placed in a temperature chamber at $20\pm 5^{\circ}\text{C}$ and connected with the system simulator.
2. The power supply voltage to the EUT was varied from 85% to 115% of the nominal value measured at the input to the EUT.
3. The variation in frequency was measured for the worst case.

4 Radiated Test Items

4.1 Measuring Instruments

See list of measuring instruments of this test report.

4.1.1 Test Setup

For radiated test from 30MHz to 1GHz

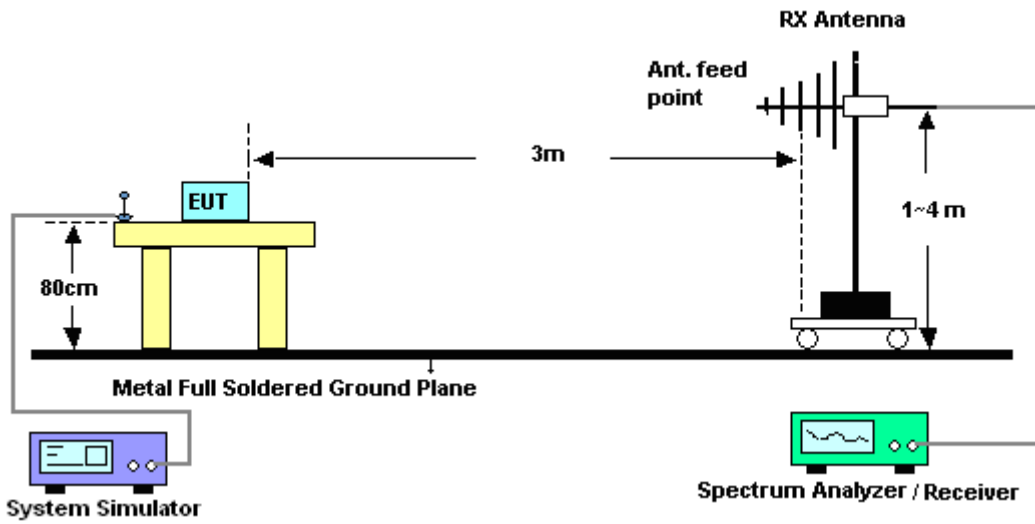

For radiated test above 1GHz

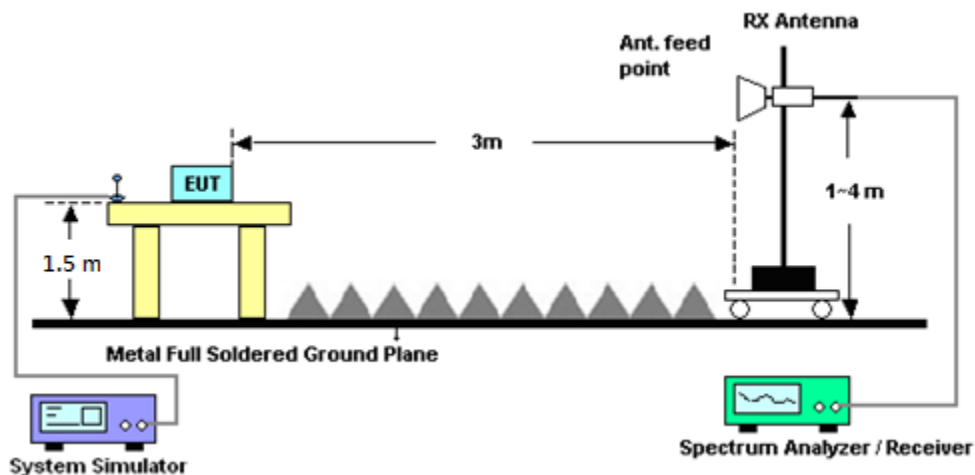

4.1.2 Test Result of Radiated Test

Please refer to Appendix B.



4.2 Radiated Spurious Emission Measurement

4.2.1 Description of Radiated Spurious Emission Measurement

The radiated spurious emission was measured by substitution method according to ANSI / TIA-603-E. The power of any emission outside of the authorized operating frequency ranges must be attenuated below the transmitter power (P) by a factor of at least $43 + 10 \log (P)$ dB.

For Band 7, 38, 41

The power of any emission outside of the authorized operating frequency ranges must be attenuated below the transmitter power (P) by a factor of at least $55 + 10 \log (P)$ dB.

The spectrum is scanned from 30 MHz up to a frequency including its 10th harmonic.

4.2.2 Test Procedures

The testing follows FCC KDB 971168 D01 v03r01 Section 7 and ANSI / TIA-603-E Section 2.2.12.

1. The EUT was placed on a turntable with 0.8 meter for frequency below 1GHz and 1.5 meter for frequency above 1GHz respectively above ground.
2. The EUT was set 3 meters from the receiving antenna, which was mounted on the antenna tower.
3. The table was rotated 360 degrees to determine the position of the highest spurious emission.
4. The height of the receiving antenna is varied between one meter and four meters to search the maximum spurious emission for both horizontal and vertical polarizations.
5. Make the measurement with the spectrum analyzer's RBW = 1MHz, VBW = 3MHz, taking the record of maximum spurious emission.
6. A horn antenna was substituted in place of the EUT and was driven by a signal generator.
7. Tune the output power of signal generator to the same emission level with EUT maximum spurious emission.
8. Taking the record of output power at antenna port.
9. Repeat step 7 to step 8 for another polarization.
10. The RF fundamental frequency should be excluded against the limit line in the operating frequency band.

The limit line is derived from $43 + 10\log(P)$ dB below the transmitter power P(Watts)

11. For Band 7, 38, 41:

The limit line is derived from $55 + 10\log(P)$ dB below the transmitter power P(Watts)

$EIRP \text{ (dBm)} = S.G. \text{ Power} - Tx \text{ Cable Loss} + Tx \text{ Antenna Gain}$

$ERP \text{ (dBm)} = EIRP - 2.15$



5 List of Measuring Equipment

Instrument	Manufacturer	Model No.	Serial No.	Characteristics	Calibration Date	Test Date	Due Date	Remark
Amplifier	MITEQ	TTA1840-35-HG	1871923	18GHz~40GHz, VSWR : 2.5:1 max	Jul. 16, 2018	May 07, 2019 ~ May 09, 2019	Jul. 15, 2019	Radiation (03CH11-HY)
Amplifier	SONOMA	310N	187312	9kHz~1GHz	Dec. 04, 2018	May 07, 2019 ~ May 09, 2019	Dec. 03, 2019	Radiation (03CH11-HY)
Bilog Antenna	TESEQ	CBL 6111D&N-6-06	35414&AT-N0602	30MHz~1GHz	Oct. 13, 2018	May 07, 2019 ~ May 09, 2019	Oct. 12, 2019	Radiation (03CH11-HY)
Horn Antenna	SCHWARZBECK	BBHA 9120 D	9120D-1326	1GHz ~ 18GHz	Oct. 15, 2018	May 07, 2019 ~ May 09, 2019	Oct. 14, 2019	Radiation (03CH11-HY)
Horn Antenna	SCHWARZBECK	BBHA 9120D	9120D-1328	1GHz ~ 18GHz	Nov. 09, 2018	May 07, 2019 ~ May 09, 2019	Nov. 08, 2019	Radiation (03CH11-HY)
Loop Antenna	Rohde & Schwarz	HFH2-Z2	100488	9 kHz~30 MHz	Nov. 23, 2017	May 07, 2019 ~ May 09, 2019	Nov. 22, 2019	Radiation (03CH11-HY)
Preamplifier	Keysight	83017A	MY53270148	1GHz~26.5GHz	Nov. 14, 2018	May 07, 2019 ~ May 09, 2019	Nov. 13, 2019	Radiation (03CH11-HY)
Spectrum Analyzer	Keysight	N9010A	MY54200486	10Hz ~ 44GHz	Oct. 18, 2018	May 07, 2019 ~ May 09, 2019	Oct. 17, 2019	Radiation (03CH11-HY)
Filter	Wainwright	WHKX12-1080-1200-1500-60SS	SN2	1.2G High Pass	Sep. 17, 2018	May 07, 2019 ~ May 09, 2019	Sep. 16, 2019	Radiation (03CH11-HY)
Filter	Wainwright	WHKX12-2700-3000-18000-60SS	SN3	2.7G High Pass	Sep. 17, 2018	May 07, 2019 ~ May 09, 2019	Sep. 16, 2019	Radiation (03CH11-HY)
Controller	EMEC	EM 1000	N/A	Control Turn table & Ant Mast	N/A	May 07, 2019 ~ May 09, 2019	N/A	Radiation (03CH11-HY)
Antenna Mast	EMEC	AM-BS-4500-B	N/A	1~4m	N/A	May 07, 2019 ~ May 09, 2019	N/A	Radiation (03CH11-HY)
Turn Table	EMEC	TT 2000	N/A	0~360 Degree	N/A	May 07, 2019 ~ May 09, 2019	N/A	Radiation (03CH11-HY)
EMI Test Receiver	Keysight	N9038A (MXE)	MY53290045	20MHz~8.4GHz	Jan. 19, 2019	May 07, 2019 ~ May 09, 2019	Jan. 18, 2020	Radiation (03CH11-HY)
Signal Generator	Rohde & Schwarz	SMF100A	101107	100kHz~40GHz	May 22, 2018	May 07, 2019 ~ May 09, 2019	May 21, 2019	Radiation (03CH11-HY)
SHF-EHF Horn Antenna	SCHWARZBECK	BBHA 9170	BBHA9170584	18GHz- 40GHz	Dec. 05, 2018	May 07, 2019 ~ May 09, 2019	Dec. 04, 2019	Radiation (03CH11-HY)
Software	Audix	E3 6.2009-8-24	RK-001042	N/A	N/A	May 07, 2019 ~ May 09, 2019	N/A	Radiation (03CH11-HY)
Hygrometer	TECPEL	DTN-303B	TP140325	N/A	Nov. 05, 2018	May 07, 2019 ~ May 09, 2019	Nov. 04, 2019	Radiation (03CH11-HY)
RF Cable	HUBER + SUHNER	SUCOFLEX 104	MY9837/4PE	9kHz-30MHz	Mar. 13, 2019	May 07, 2019 ~ May 09, 2019	Mar. 12, 2020	Radiation (03CH11-HY)
RF Cable	HUBER + SUHNER	SUCOFLEX 102	MY2859/2	30MHz-40GHz	Mar. 13, 2019	May 07, 2019 ~ May 09, 2019	Mar. 12, 2020	Radiation (03CH11-HY)
RF Cable	HUBER + SUHNER	SUCOFLEX 104	MY9837/4PE	30M-18G	Mar. 13, 2019	May 07, 2019 ~ May 09, 2019	Mar. 12, 2020	Radiation (03CH11-HY)
RF Cable	HUBER + SUHNER	SUCOFLEX 102	MY4274/2	30MHz-40GHz	Mar. 13, 2019	May 07, 2019 ~ May 09, 2019	Mar. 12, 2020	Radiation (03CH11-HY)
Hygrometer	TECPEL	DTM-303B	TP161237	N/A	Oct. 22, 2018	May 07, 2019 ~ May 09, 2019	Oct. 21, 2019	Radiation (03CH11-HY)



Instrument	Manufacturer	Model No.	Serial No.	Characteristics	Calibration Date	Test Date	Due Date	Remark
Base Station(Measure)	Anritsu	MT8821C	620166475 5	GSM / GPRS /WCDMA / LTE FDD/TDD with 44) /LTE-3CC DLCA,2CC ULCA	Mar. 03, 2019	May 11, 2019 ~ May 16, 2019	Mar. 02, 2020	Conducted (TH05-HY)
Spectrum Analyzer	Rohde & Schwarz	FSV40	101397	10Hz~40GHz	Nov. 13, 2018	May 11, 2019 ~ May 16, 2019	Nov. 12, 2019	Conducted (TH05-HY)
Temperature Chamber	ESPEC	SH-641	92013720	-40℃~90℃	Aug. 29, 2018	May 11, 2019 ~ May 16, 2019	Aug. 28, 2019	Conducted (TH05-HY)
Programmable Power Supply	GW Instek	PSS-2005	EL890094	1V~20V 0.5A~5A	Oct. 02, 2018	May 11, 2019 ~ May 16, 2019	Oct. 01, 2019	Conducted (TH05-HY)
Coupler	Warison	20dB 25W SMA Directional Coupler	#A	1-18GHz	Jan. 14, 2019	May 11, 2019 ~ May 16, 2019	Jan. 13, 2020	Conducted (TH05-HY)



6 Uncertainty of Evaluation

Uncertainty of Radiated Emission Measurement (30 MHz ~ 1000 MHz)

Measuring Uncertainty for a Level of Confidence of 95% ($U = 2Uc(y)$)	3.37
---	------

Uncertainty of Radiated Emission Measurement (1 GHz ~ 18 GHz)

Measuring Uncertainty for a Level of Confidence of 95% ($U = 2Uc(y)$)	3.67
---	------

Uncertainty of Radiated Emission Measurement (18 GHz ~ 40 GHz)

Measuring Uncertainty for a Level of Confidence of 95% ($U = 2Uc(y)$)	4.03
---	------



Appendix A. Test Results of Conducted Test

Conducted Output Power(Average power)

LTE Band 2 Maximum Average Power [dBm]						
BW [MHz]	RB Size	RB Offset	Mod	Lowest	Middle	Highest
20	1	0	QPSK	22.94	22.95	22.73
20	1	49		22.60	22.62	22.62
20	1	99		22.67	22.61	22.58
20	50	0		21.71	21.75	21.73
20	50	24		21.64	21.71	21.71
20	50	50		21.65	21.56	21.71
20	100	0		21.68	21.72	21.66
20	1	0	16-QAM	22.13	22.24	22.06
20	1	49		21.82	21.81	21.96
20	1	99		21.93	21.97	21.86
20	50	0		20.82	20.88	20.85
20	50	24		20.64	20.76	20.81
20	50	50		20.71	20.73	20.80
20	100	0		20.79	20.79	20.80
20	1	0	64-QAM	21.19	21.16	20.95
20	1	49		20.83	20.87	20.96
20	1	99		21.03	20.90	20.81
20	50	0		19.85	19.84	19.86
20	50	24		19.73	19.78	19.94
20	50	50		19.73	19.78	19.86
20	100	0		19.78	19.76	19.74
15	1	0	QPSK	22.85	22.84	22.90
15	1	37		22.66	22.67	22.80
15	1	74		22.60	22.67	22.79
15	36	0		21.84	21.83	21.96
15	36	20		21.76	21.78	21.89
15	36	39		21.76	21.73	21.83
15	75	0		21.76	21.78	21.90
15	1	0	16-QAM	22.19	22.19	22.29
15	1	37		21.98	22.01	22.13
15	1	74		21.98	21.99	22.11
15	36	0		20.92	20.98	21.03
15	36	20		20.88	20.92	21.02
15	36	39		20.85	20.89	20.91
15	75	0		20.93	20.92	20.98
15	1	0	64-QAM	21.14	21.13	21.26
15	1	37		20.94	20.95	21.09
15	1	74		20.89	20.93	21.03
15	36	0		19.98	19.98	20.06
15	36	20		19.93	19.94	20.03
15	36	39		19.85	19.89	19.95
15	75	0		19.86	19.90	19.98



LTE Band 2 Maximum Average Power [dBm]						
BW [MHz]	RB Size	RB Offset	Mod	Lowest	Middle	Highest
10	1	0	QPSK	22.89	22.91	22.88
10	1	25		22.67	22.66	22.80
10	1	49		22.84	22.85	22.75
10	25	0		21.82	21.81	21.90
10	25	12		21.79	21.79	21.89
10	25	25		21.74	21.77	21.83
10	50	0		21.79	21.80	21.85
10	1	0	16-QAM	22.32	22.32	22.22
10	1	25		22.03	22.04	22.15
10	1	49		22.16	22.20	22.08
10	25	0		20.94	20.93	20.97
10	25	12		20.89	20.91	20.98
10	25	25		20.83	20.85	20.93
10	50	0		20.90	20.88	20.95
10	1	0	64-QAM	21.31	21.22	21.11
10	1	25		21.01	21.00	21.04
10	1	49		21.09	21.15	21.05
10	25	0		19.93	19.93	20.02
10	25	12		19.90	19.90	19.99
10	25	25		19.86	19.89	19.94
10	50	0		19.90	19.91	19.97
5	1	0	QPSK	22.77	22.74	22.93
5	1	12		22.72	22.72	22.87
5	1	24		22.69	22.71	22.77
5	12	0		21.83	21.76	21.84
5	12	7		21.79	21.78	21.88
5	12	13		21.73	21.76	21.79
5	25	0		21.76	21.75	21.84
5	1	0	16-QAM	22.13	22.11	22.17
5	1	12		22.08	22.06	22.13
5	1	24		22.07	22.06	22.05
5	12	0		20.90	20.91	20.94
5	12	7		20.87	20.87	20.97
5	12	13		20.89	20.88	20.90
5	25	0		20.87	20.86	20.93
5	1	0	64-QAM	21.09	21.05	21.14
5	1	12		21.01	21.02	21.05
5	1	24		21.01	20.96	21.02
5	12	0		19.97	19.93	20.01
5	12	7		19.96	19.96	20.00
5	12	13		19.95	19.94	19.98
5	25	0		19.87	19.88	19.93



LTE Band 2 Maximum Average Power [dBm]						
BW [MHz]	RB Size	RB Offset	Mod	Lowest	Middle	Highest
3	1	0	QPSK	22.75	22.70	22.81
3	1	8		22.71	22.69	22.77
3	1	14		22.69	22.67	22.74
3	8	0		21.77	21.75	21.78
3	8	4		21.76	21.76	21.82
3	8	7		21.76	21.76	21.82
3	15	0		21.74	21.75	21.79
3	1	0	16-QAM	22.07	22.01	22.11
3	1	8		22.06	21.97	22.09
3	1	14		22.03	21.97	22.03
3	8	0		20.91	20.91	20.94
3	8	4		20.96	20.94	20.99
3	8	7		20.91	20.88	20.94
3	15	0		20.86	20.84	20.90
3	1	0	64-QAM	21.04	21.00	21.03
3	1	8		21.01	20.96	21.05
3	1	14		20.99	20.95	21.00
3	8	0		19.95	19.92	19.94
3	8	4		19.98	19.94	19.98
3	8	7		19.91	19.92	19.92
3	15	0		19.86	19.89	19.92
1.4	1	0	QPSK	22.63	22.62	22.70
1.4	1	3		22.67	22.71	22.77
1.4	1	5		22.65	22.60	22.68
1.4	3	0		22.71	22.66	22.72
1.4	3	1		22.73	22.70	22.78
1.4	3	3		22.71	22.66	22.74
1.4	6	0		21.68	21.67	21.75
1.4	1	0	16-QAM	21.99	21.96	21.99
1.4	1	3		22.06	22.01	22.03
1.4	1	5		21.97	21.94	21.96
1.4	3	0		21.80	21.74	21.79
1.4	3	1		21.82	21.80	21.81
1.4	3	3		21.76	21.74	21.80
1.4	6	0		20.83	20.82	20.89
1.4	1	0	64-QAM	20.93	20.91	20.98
1.4	1	3		20.98	20.95	21.02
1.4	1	5		20.94	20.91	20.93
1.4	3	0		20.95	20.91	20.93
1.4	3	1		21.01	20.94	20.96
1.4	3	3		20.92	20.89	20.95
1.4	6	0		19.77	19.78	19.84



LTE Band 4 Maximum Average Power [dBm]						
BW [MHz]	RB Size	RB Offset	Mod	Lowest	Middle	Highest
20	1	0	QPSK	22.79	22.94	22.62
20	1	49		22.62	22.42	22.53
20	1	99		22.47	22.32	22.33
20	50	0		21.56	21.75	21.55
20	50	24		21.65	21.57	21.43
20	50	50		21.56	21.50	21.51
20	100	0		21.51	21.72	21.47
20	1	0	16-QAM	22.15	22.19	22.05
20	1	49		21.99	21.88	21.87
20	1	99		21.88	21.77	21.69
20	50	0		20.84	20.74	20.64
20	50	24		20.83	20.61	20.55
20	50	50		20.68	20.56	20.63
20	100	0		20.76	20.70	20.56
20	1	0	64-QAM	21.14	21.11	20.90
20	1	49		20.90	20.74	20.81
20	1	99		20.82	20.64	20.61
20	50	0		19.93	19.69	19.72
20	50	24		19.79	19.70	19.63
20	50	50		19.62	19.58	19.65
20	100	0		19.80	19.65	19.54
15	1	0	QPSK	22.76	22.93	22.68
15	1	37		22.71	22.54	22.57
15	1	74		22.71	22.54	22.57
15	36	0		21.71	21.82	21.65
15	36	20		21.76	21.64	21.67
15	36	39		21.76	21.61	21.62
15	75	0		21.64	21.81	21.54
15	1	0	16-QAM	22.27	22.10	22.01
15	1	37		22.02	21.94	21.89
15	1	74		22.08	21.85	21.82
15	36	0		20.98	20.79	20.72
15	36	20		20.93	20.74	20.73
15	36	39		20.85	20.67	20.68
15	75	0		20.89	20.75	20.66
15	1	0	64-QAM	21.25	21.05	20.97
15	1	37		21.00	20.86	20.88
15	1	74		21.03	20.85	20.83
15	36	0		19.99	19.83	19.80
15	36	20		19.96	19.80	19.82
15	36	39		19.92	19.75	19.77
15	75	0		19.93	19.78	19.69



LTE Band 4 Maximum Average Power [dBm]						
BW [MHz]	RB Size	RB Offset	Mod	Lowest	Middle	Highest
10	1	0	QPSK	22.92	22.66	22.69
10	1	25		22.83	22.56	22.60
10	1	49		22.71	22.52	22.54
10	25	0		21.94	21.65	21.66
10	25	12		21.82	21.65	21.66
10	25	25		21.76	21.62	21.63
10	50	0		21.82	21.64	21.66
10	1	0	16-QAM	22.20	22.06	22.07
10	1	25		22.16	21.96	21.94
10	1	49		22.08	21.90	21.86
10	25	0		21.06	20.80	20.82
10	25	12		20.91	20.73	20.78
10	25	25		20.86	20.70	20.74
10	50	0		20.93	20.74	20.74
10	1	0	64-QAM	21.19	20.94	20.94
10	1	25		21.15	20.84	20.84
10	1	49		21.02	20.77	20.76
10	25	0		20.08	19.80	19.81
10	25	12		19.92	19.78	19.78
10	25	25		19.89	19.71	19.73
10	50	0		19.94	19.79	19.81
5	1	0	QPSK	22.91	22.64	22.64
5	1	12		22.85	22.58	22.58
5	1	24		22.86	22.54	22.56
5	12	0		21.90	21.65	21.60
5	12	7		21.92	21.64	21.63
5	12	13		21.88	21.59	21.60
5	25	0		21.92	21.60	21.62
5	1	0	16-QAM	22.17	22.00	21.98
5	1	12		22.18	21.95	21.91
5	1	24		22.19	21.95	21.85
5	12	0		21.01	20.74	20.75
5	12	7		21.03	20.76	20.74
5	12	13		21.01	20.73	20.67
5	25	0		21.00	20.73	20.70
5	1	0	64-QAM	21.17	20.93	20.91
5	1	12		21.10	20.86	20.82
5	1	24		21.13	20.86	20.80
5	12	0		20.10	19.83	19.79
5	12	7		20.08	19.82	19.77
5	12	13		20.05	19.80	19.79
5	25	0		20.03	19.74	19.71



LTE Band 4 Maximum Average Power [dBm]						
BW [MHz]	RB Size	RB Offset	Mod	Lowest	Middle	Highest
3	1	0	QPSK	22.91	22.59	22.59
3	1	8		22.84	22.57	22.57
3	1	14		22.81	22.53	22.53
3	8	0		21.86	21.59	21.60
3	8	4		21.91	21.62	21.63
3	8	7		21.86	21.59	21.58
3	15	0		21.90	21.60	21.60
3	1	0	16-QAM	22.12	21.93	21.85
3	1	8		22.11	21.93	21.82
3	1	14		22.12	21.88	21.79
3	8	0		21.01	20.77	20.73
3	8	4		21.07	20.81	20.76
3	8	7		21.01	20.78	20.71
3	15	0		21.02	20.70	20.72
3	1	0	64-QAM	21.09	20.90	20.84
3	1	8		21.10	20.86	20.82
3	1	14		21.11	20.84	20.81
3	8	0		20.10	19.80	19.76
3	8	4		20.08	19.80	19.76
3	8	7		20.05	19.77	19.75
3	15	0		20.02	19.73	19.71
1.4	1	0	QPSK	22.78	22.49	22.48
1.4	1	3		22.86	22.58	22.55
1.4	1	5		22.75	22.51	22.49
1.4	3	0		22.81	22.55	22.55
1.4	3	1		22.88	22.57	22.58
1.4	3	3		22.82	22.53	22.56
1.4	6	0		21.84	21.54	21.53
1.4	1	0	16-QAM	22.04	21.85	21.74
1.4	1	3		22.09	21.90	21.80
1.4	1	5		22.02	21.78	21.77
1.4	3	0		21.86	21.64	21.59
1.4	3	1		21.91	21.69	21.64
1.4	3	3		21.88	21.61	21.57
1.4	6	0		21.00	20.71	20.67
1.4	1	0	64-QAM	21.04	20.81	20.78
1.4	1	3		21.08	20.89	20.79
1.4	1	5		21.01	20.80	20.72
1.4	3	0		21.02	20.80	20.78
1.4	3	1		21.07	20.84	20.81
1.4	3	3		21.03	20.83	20.74
1.4	6	0		19.95	19.66	19.65



LTE Band 5 Maximum Average Power [dBm]						
BW [MHz]	RB Size	RB Offset	Mod	Lowest	Middle	Highest
10	1	0	QPSK	22.78	22.79	22.39
10	1	25		22.74	22.76	22.34
10	1	49		22.62	22.61	22.27
10	25	0		21.94	21.95	21.61
10	25	12		21.94	21.89	21.56
10	25	25		21.91	21.88	21.54
10	50	0		21.92	21.93	21.54
10	1	0	16-QAM	22.28	22.32	21.92
10	1	25		22.27	22.25	21.86
10	1	49		22.24	22.22	21.86
10	25	0		21.02	21.06	20.70
10	25	12		21.06	21.05	20.69
10	25	25		21.01	21.00	20.65
10	50	0		21.00	21.03	20.64
10	1	0	64-QAM	21.17	21.23	20.85
10	1	25		21.16	21.18	20.82
10	1	49		21.14	21.10	20.77
10	25	0		20.10	20.11	19.76
10	25	12		20.10	20.12	19.79
10	25	25		20.15	20.07	19.80
10	50	0		20.15	20.01	19.72
5	1	0	QPSK	22.70	22.74	22.51
5	1	12		22.61	22.66	22.44
5	1	24		22.67	22.67	22.38
5	12	0		21.90	21.96	21.72
5	12	7		22.00	21.92	21.73
5	12	13		21.92	21.84	21.68
5	25	0		21.99	21.89	21.69
5	1	0	16-QAM	22.30	22.32	22.10
5	1	12		22.24	22.25	22.05
5	1	24		22.28	22.19	21.94
5	12	0		21.03	21.03	20.86
5	12	7		21.15	21.01	20.82
5	12	13		21.09	20.96	20.78
5	25	0		21.13	20.99	20.84
5	1	0	64-QAM	21.14	21.24	21.05
5	1	12		21.10	21.11	20.97
5	1	24		21.16	21.09	20.90
5	12	0		20.05	20.04	19.87
5	12	7		20.15	20.06	19.84
5	12	13		20.22	20.13	19.77
5	25	0		20.23	20.11	19.92



LTE Band 5 Maximum Average Power [dBm]						
BW [MHz]	RB Size	RB Offset	Mod	Lowest	Middle	Highest
3	1	0	QPSK	22.71	22.68	22.33
3	1	8		22.66	22.62	22.30
3	1	14		22.65	22.62	22.30
3	8	0		21.91	21.88	21.56
3	8	4		21.94	21.93	21.56
3	8	7		21.92	21.86	21.52
3	15	0		21.91	21.86	21.54
3	1	0	16-QAM	22.22	22.16	21.89
3	1	8		22.21	22.21	21.85
3	1	14		22.18	22.16	21.81
3	8	0		21.06	21.08	20.70
3	8	4		21.07	21.07	20.74
3	8	7		21.07	21.06	20.73
3	15	0		21.03	21.03	20.64
3	1	0	64-QAM	21.24	21.19	20.81
3	1	8		21.26	21.11	20.82
3	1	14		21.15	21.14	20.81
3	8	0		20.11	20.05	19.73
3	8	4		20.09	20.07	19.74
3	8	7		20.06	20.03	19.71
3	15	0		20.10	20.02	19.67
1.4	1	0	QPSK	22.62	22.58	22.25
1.4	1	3		22.68	22.62	22.29
1.4	1	5		22.60	22.55	22.22
1.4	3	0		22.63	22.63	22.26
1.4	3	1		22.68	22.64	22.33
1.4	3	3		22.67	22.60	22.30
1.4	6	0		21.85	21.83	21.48
1.4	1	0	16-QAM	22.15	22.12	21.81
1.4	1	3		22.21	22.22	21.85
1.4	1	5		22.16	22.10	21.77
1.4	3	0		21.98	21.95	21.57
1.4	3	1		21.97	21.97	21.63
1.4	3	3		21.93	21.93	21.59
1.4	6	0		21.03	21.00	20.67
1.4	1	0	64-QAM	21.13	21.10	20.74
1.4	1	3		21.18	21.17	20.81
1.4	1	5		21.06	21.11	20.72
1.4	3	0		21.11	21.06	20.68
1.4	3	1		21.11	21.14	20.73
1.4	3	3		21.07	21.05	20.68
1.4	6	0		19.97	19.93	19.60



LTE Band 7 Maximum Average Power [dBm]						
BW [MHz]	RB Size	RB Offset	Mod	Lowest	Middle	Highest
20	1	0	QPSK	23.20	23.28	22.98
20	1	49		23.08	22.99	22.81
20	1	99		23.20	23.03	22.84
20	50	0		22.19	22.25	21.85
20	50	24		22.05	22.06	21.93
20	50	50		22.15	21.98	21.84
20	100	0		22.03	22.21	21.86
20	1	0	16-QAM	22.55	22.41	22.38
20	1	49		22.63	22.41	22.18
20	1	99		22.52	22.32	22.14
20	50	0		21.40	21.16	21.07
20	50	24		21.37	21.21	20.98
20	50	50		21.28	21.15	20.95
20	100	0		21.25	21.15	21.00
20	1	0	64-QAM	21.49	21.41	21.26
20	1	49		21.48	21.28	21.21
20	1	99		21.49	21.33	21.20
20	50	0		20.44	20.23	20.00
20	50	24		20.43	20.22	20.00
20	50	50		20.32	20.11	20.07
20	100	0		20.34	20.21	19.98
15	1	0	QPSK	23.12	23.00	22.83
15	1	37		23.11	22.90	22.79
15	1	74		23.23	22.99	22.78
15	36	0		22.15	21.99	21.85
15	36	20		22.18	22.04	21.83
15	36	39		22.12	21.91	21.72
15	75	0		22.16	22.03	21.79
15	1	0	16-QAM	22.47	22.43	22.21
15	1	37		22.52	22.29	22.18
15	1	74		22.59	22.35	22.14
15	36	0		21.36	21.11	20.94
15	36	20		21.32	21.08	20.98
15	36	39		21.28	21.11	20.88
15	75	0		21.26	21.09	20.91
15	1	0	64-QAM	21.45	21.36	21.27
15	1	37		21.44	21.23	21.10
15	1	74		21.41	21.27	21.13
15	36	0		20.30	20.17	19.96
15	36	20		20.29	20.09	19.96
15	36	39		20.27	20.05	19.92
15	75	0		20.17	20.18	20.01



LTE Band 7 Maximum Average Power [dBm]						
BW [MHz]	RB Size	RB Offset	Mod	Lowest	Middle	Highest
10	1	0	QPSK	22.99	22.92	22.63
10	1	25		23.03	22.84	22.59
10	1	49		23.04	22.84	22.66
10	25	0		21.97	21.94	21.64
10	25	12		22.00	21.96	21.63
10	25	25		21.95	21.87	21.62
10	50	0		22.00	21.85	21.63
10	1	0	16-QAM	22.28	22.16	22.06
10	1	25		22.25	22.25	21.99
10	1	49		22.25	22.19	21.93
10	25	0		21.08	21.05	20.74
10	25	12		21.09	21.05	20.76
10	25	25		21.11	21.01	20.75
10	50	0		21.07	20.98	20.74
10	1	0	64-QAM	21.28	21.20	21.07
10	1	25		21.32	21.19	21.03
10	1	49		21.32	21.21	20.93
10	25	0		20.08	19.97	19.74
10	25	12		20.17	20.03	19.87
10	25	25		20.13	20.04	19.77
10	50	0		20.04	19.96	19.76
5	1	0	QPSK	23.05	22.86	22.54
5	1	12		23.01	22.79	22.58
5	1	24		22.95	22.84	22.58
5	12	0		21.97	21.90	21.69
5	12	7		22.00	21.93	21.70
5	12	13		21.93	21.84	21.64
5	25	0		21.91	21.80	21.56
5	1	0	16-QAM	22.28	22.17	21.96
5	1	12		22.31	22.17	22.04
5	1	24		22.27	22.13	22.02
5	12	0		21.04	21.01	20.73
5	12	7		21.06	21.10	20.81
5	12	13		21.10	21.02	20.75
5	25	0		21.07	20.98	20.66
5	1	0	64-QAM	21.21	21.13	20.98
5	1	12		21.19	21.09	20.92
5	1	24		21.24	21.05	20.86
5	12	0		20.11	20.00	19.76
5	12	7		20.11	20.05	19.86
5	12	13		20.15	20.06	19.90
5	25	0		20.05	19.99	19.81



LTE Band 12 Maximum Average Power [dBm]						
BW [MHz]	RB Size	RB Offset	Mod	Lowest	Middle	Highest
10	1	0	QPSK	22.50	22.94	22.69
10	1	25		22.59	22.73	22.68
10	1	49		22.68	22.73	22.74
10	25	0		21.65	21.83	21.76
10	25	12		21.73	21.82	21.76
10	25	25		21.72	21.78	21.70
10	50	0		21.71	21.80	21.72
10	1	0	16-QAM	21.87	22.04	22.05
10	1	25		21.95	22.09	22.03
10	1	49		22.00	22.06	22.11
10	25	0		20.72	20.89	20.83
10	25	12		20.87	20.90	20.84
10	25	25		20.80	20.87	20.84
10	50	0		20.85	20.86	20.80
10	1	0	64-QAM	20.84	20.98	21.01
10	1	25		20.94	21.04	21.00
10	1	49		20.96	21.00	21.03
10	25	0		19.76	19.93	19.85
10	25	12		19.88	19.94	19.88
10	25	25		19.86	19.89	19.84
10	50	0		19.87	19.91	19.85
5	1	0	QPSK	22.55	22.67	22.76
5	1	12		22.63	22.74	22.83
5	1	24		22.64	22.71	22.82
5	12	0		21.69	21.76	21.79
5	12	7		21.69	21.84	21.92
5	12	13		21.67	21.76	21.90
5	25	0		21.63	21.78	21.80
5	1	0	16-QAM	21.92	22.04	22.10
5	1	12		22.03	22.08	22.19
5	1	24		22.01	22.08	22.16
5	12	0		20.79	20.92	20.93
5	12	7		20.79	20.92	21.04
5	12	13		20.78	20.91	21.02
5	25	0		20.82	20.87	20.92
5	1	0	64-QAM	20.85	20.97	21.05
5	1	12		20.97	21.02	21.12
5	1	24		20.93	21.02	21.11
5	12	0		19.86	19.96	19.97
5	12	7		19.90	20.00	20.09
5	12	13		19.87	19.95	20.09
5	25	0		19.80	19.89	19.92



LTE Band 12 Maximum Average Power [dBm]						
BW [MHz]	RB Size	RB Offset	Mod	Lowest	Middle	Highest
3	1	0	QPSK	22.52	22.75	22.82
3	1	8		22.51	22.73	22.80
3	1	14		22.63	22.73	22.81
3	8	0		21.54	21.78	21.86
3	8	4		21.60	21.79	21.89
3	8	7		21.67	21.76	21.87
3	15	0		21.65	21.76	21.88
3	1	0	16-QAM	21.87	22.10	22.14
3	1	8		21.88	22.08	22.19
3	1	14		22.00	22.02	22.12
3	8	0		20.73	20.91	21.05
3	8	4		20.79	20.95	21.08
3	8	7		20.84	20.91	21.02
3	15	0		20.82	20.88	21.00
3	1	0	64-QAM	20.85	21.06	21.12
3	1	8		20.87	21.03	21.11
3	1	14		20.98	21.00	21.09
3	8	0		19.75	19.96	20.02
3	8	4		19.77	19.95	20.08
3	8	7		19.82	19.95	20.08
3	15	0		19.80	19.90	19.98
1.4	1	0	QPSK	22.47	22.64	22.84
1.4	1	3		22.52	22.72	22.93
1.4	1	5		22.46	22.64	22.83
1.4	3	0		22.52	22.72	22.87
1.4	3	1		22.55	22.73	22.90
1.4	3	3		22.51	22.69	22.89
1.4	6	0		21.52	21.70	21.90
1.4	1	0	16-QAM	21.81	22.01	22.20
1.4	1	3		21.92	22.06	22.21
1.4	1	5		21.79	21.97	22.12
1.4	3	0		21.64	21.81	21.96
1.4	3	1		21.68	21.83	22.01
1.4	3	3		21.61	21.80	21.95
1.4	6	0		20.69	20.87	21.05
1.4	1	0	64-QAM	20.79	20.99	21.11
1.4	1	3		20.86	21.04	21.19
1.4	1	5		20.80	20.95	21.10
1.4	3	0		20.75	20.92	21.15
1.4	3	1		20.80	20.98	21.14
1.4	3	3		20.76	20.93	21.10
1.4	6	0		19.63	19.83	20.03



LTE Band 17 Maximum Average Power [dBm]						
BW [MHz]	RB Size	RB Offset	Mod	Lowest	Middle	Highest
10	1	0	QPSK	22.55	22.86	22.62
10	1	25		22.71	22.69	22.67
10	1	49		22.78	22.74	22.73
10	25	0		21.77	21.82	21.77
10	25	12		21.81	21.74	21.76
10	25	25		21.74	21.72	21.75
10	50	0		21.77	21.78	21.71
10	1	0	16-QAM	21.91	22.01	21.95
10	1	25		22.04	22.05	22.01
10	1	49		22.13	22.14	22.10
10	25	0		20.89	20.87	20.85
10	25	12		20.89	20.90	20.85
10	25	25		20.86	20.87	20.84
10	50	0		20.88	20.85	20.86
10	1	0	64-QAM	20.86	20.91	20.89
10	1	25		20.99	20.98	20.97
10	1	49		21.07	21.04	21.05
10	25	0		19.90	19.90	19.86
10	25	12		19.92	19.89	19.89
10	25	25		19.88	19.86	19.85
10	50	0		19.87	19.90	19.88
5	1	0	QPSK	22.48	22.70	22.77
5	1	12		22.55	22.68	22.85
5	1	24		22.64	22.78	22.83
5	12	0		21.58	21.73	21.78
5	12	7		21.62	21.75	21.93
5	12	13		21.67	21.71	21.86
5	25	0		21.70	21.71	21.79
5	1	0	16-QAM	21.83	21.98	22.08
5	1	12		21.89	22.00	22.17
5	1	24		21.98	22.13	22.18
5	12	0		20.73	20.88	20.93
5	12	7		20.76	20.90	21.05
5	12	13		20.82	20.88	21.03
5	25	0		20.79	20.86	20.92
5	1	0	64-QAM	20.79	21.00	21.07
5	1	12		20.87	20.98	21.14
5	1	24		20.93	21.07	21.11
5	12	0		19.83	19.94	19.98
5	12	7		19.83	19.95	20.09
5	12	13		19.89	19.92	20.09
5	25	0		19.84	19.86	19.89



LTE Band 38 Maximum Average Power [dBm]						
BW [MHz]	RB Size	RB Offset	Mod	Lowest	Middle	Highest
20	1	0	QPSK	23.08	23.12	22.89
20	1	49		22.95	23.00	22.92
20	1	99		22.99	23.05	22.98
20	50	0		22.00	22.03	21.87
20	50	24		22.03	22.00	21.90
20	50	50		22.06	21.95	21.93
20	100	0		22.01	22.03	21.83
20	1	0	16-QAM	22.22	22.20	22.10
20	1	49		22.16	22.18	22.09
20	1	99		22.22	22.20	22.06
20	50	0		21.10	21.10	20.97
20	50	24		21.15	21.15	21.12
20	50	50		21.16	21.13	21.08
20	100	0		21.11	21.10	20.94
20	1	0	64-QAM	21.00	21.02	20.84
20	1	49		20.87	20.87	20.81
20	1	99		20.89	20.92	20.81
20	50	0		20.12	20.21	20.00
20	50	24		20.09	20.10	20.10
20	50	50		20.22	20.07	20.05
20	100	0		20.21	20.15	20.05
15	1	0	QPSK	23.05	23.05	23.01
15	1	37		23.01	23.09	22.85
15	1	74		23.01	22.95	22.97
15	36	0		21.98	21.98	21.98
15	36	20		22.08	22.06	21.91
15	36	39		21.96	22.00	21.94
15	75	0		22.01	22.01	21.89
15	1	0	16-QAM	22.14	22.28	22.17
15	1	37		22.20	22.14	22.07
15	1	74		22.19	22.16	22.16
15	36	0		21.12	21.13	21.10
15	36	20		21.12	21.12	21.03
15	36	39		21.09	21.08	21.02
15	75	0		21.15	21.16	21.05
15	1	0	64-QAM	21.03	21.03	20.93
15	1	37		20.97	20.96	20.85
15	1	74		20.90	20.95	20.82
15	36	0		20.17	20.08	20.12
15	36	20		20.12	20.13	20.19
15	36	39		20.18	20.17	20.04
15	75	0		20.11	20.15	20.13



LTE Band 38 Maximum Average Power [dBm]						
BW [MHz]	RB Size	RB Offset	Mod	Lowest	Middle	Highest
10	1	0	QPSK	23.00	23.05	22.81
10	1	25		22.98	22.98	22.85
10	1	49		23.03	23.00	22.73
10	25	0		22.05	22.05	21.80
10	25	12		22.01	22.08	21.82
10	25	25		22.04	22.02	21.78
10	50	0		22.07	21.97	21.84
10	1	0	16-QAM	22.19	22.12	22.02
10	1	25		22.21	22.15	21.94
10	1	49		22.14	22.12	21.97
10	25	0		21.11	21.13	20.99
10	25	12		21.16	21.10	20.96
10	25	25		21.18	21.15	20.97
10	50	0		21.09	21.14	21.04
10	1	0	64-QAM	20.92	20.94	20.76
10	1	25		20.94	20.90	20.82
10	1	49		20.90	20.88	20.79
10	25	0		20.18	20.19	20.03
10	25	12		20.23	20.18	20.06
10	25	25		20.22	20.16	19.98
10	50	0		20.08	20.12	19.92
5	1	0	QPSK	22.97	22.93	22.82
5	1	12		23.01	23.02	22.86
5	1	24		22.85	22.85	22.80
5	12	0		22.01	21.99	21.82
5	12	7		22.02	22.04	21.90
5	12	13		21.94	21.93	21.84
5	25	0		21.96	21.98	21.80
5	1	0	16-QAM	22.06	22.09	21.97
5	1	12		22.14	22.05	22.01
5	1	24		22.07	22.15	22.02
5	12	0		21.02	21.05	20.96
5	12	7		21.05	21.10	21.00
5	12	13		21.06	21.03	20.94
5	25	0		21.15	21.07	20.93
5	1	0	64-QAM	20.87	20.92	20.74
5	1	12		20.89	20.92	20.75
5	1	24		20.87	20.87	20.78
5	12	0		20.09	20.11	19.98
5	12	7		20.20	20.15	19.98
5	12	13		20.06	20.06	19.98
5	25	0		20.09	20.13	20.05



LTE Band 41 Maximum Average Power [dBm]						
BW [MHz]	RB Size	RB Offset	Mod	Lowest	Middle	Highest
20	1	0	QPSK	22.49	22.86	22.46
20	1	49		22.45	22.63	22.82
20	1	99		22.46	22.63	22.53
20	50	0		21.52	21.77	21.76
20	50	24		21.54	21.65	21.78
20	50	50		21.46	21.75	21.86
20	100	0		21.53	21.71	21.78
20	1	0	16-QAM	21.76	21.91	21.44
20	1	49		21.69	21.87	21.96
20	1	99		21.64	21.95	21.65
20	50	0		20.65	20.74	20.90
20	50	24		20.60	20.65	20.95
20	50	50		20.57	20.81	21.04
20	100	0		20.68	20.78	20.88
20	1	0	64-QAM	20.49	20.64	20.43
20	1	49		20.46	20.58	20.74
20	1	99		20.40	20.60	20.42
20	50	0		19.63	19.69	19.95
20	50	24		19.68	19.82	19.86
20	50	50		19.68	19.81	19.99
20	100	0		19.64	19.67	19.89
15	1	0	QPSK	22.57	22.68	22.46
15	1	37		22.52	22.71	22.80
15	1	74		22.50	22.65	22.65
15	36	0		21.53	21.66	21.82
15	36	20		21.49	21.74	21.87
15	36	39		21.50	21.63	21.82
15	75	0		21.56	21.55	21.69
15	1	0	16-QAM	21.80	21.78	21.51
15	1	37		21.63	21.84	22.03
15	1	74		21.66	21.83	21.83
15	36	0		20.55	20.80	20.90
15	36	20		20.60	20.84	21.06
15	36	39		20.56	20.78	20.99
15	75	0		20.73	20.75	20.87
15	1	0	64-QAM	20.44	20.55	20.50
15	1	37		20.49	20.67	20.83
15	1	74		20.51	20.46	20.49
15	36	0		19.73	19.80	19.89
15	36	20		19.61	19.82	20.09
15	36	39		19.59	19.82	19.97
15	75	0		19.63	19.72	19.89



LTE Band 41 Maximum Average Power [dBm]						
BW [MHz]	RB Size	RB Offset	Mod	Lowest	Middle	Highest
10	1	0	QPSK	22.51	22.68	22.88
10	1	25		22.50	22.60	22.84
10	1	49		22.50	22.61	22.77
10	25	0		21.52	21.69	21.87
10	25	12		21.58	21.62	21.94
10	25	25		21.55	21.60	21.89
10	50	0		21.56	21.65	21.84
10	1	0	16-QAM	21.74	21.89	21.94
10	1	25		21.67	21.80	22.06
10	1	49		21.59	21.89	22.01
10	25	0		20.64	20.89	20.98
10	25	12		20.71	20.86	21.04
10	25	25		20.66	20.88	20.95
10	50	0		20.63	20.92	20.99
10	1	0	64-QAM	20.51	20.63	20.58
10	1	25		20.48	20.61	20.77
10	1	49		20.43	20.57	20.70
10	25	0		19.68	19.88	20.06
10	25	12		19.68	19.86	20.10
10	25	25		19.65	19.93	20.11
10	50	0		19.70	19.78	19.97
5	1	0	QPSK	22.46	22.67	22.79
5	1	12		22.59	22.58	22.87
5	1	24		22.51	22.62	22.82
5	12	0		21.50	21.74	21.81
5	12	7		21.51	21.67	21.90
5	12	13		21.50	21.62	21.89
5	25	0		21.55	21.63	21.80
5	1	0	16-QAM	21.67	21.79	22.04
5	1	12		21.72	21.86	22.05
5	1	24		21.69	21.78	21.98
5	12	0		20.63	20.79	20.98
5	12	7		20.69	20.72	20.95
5	12	13		20.59	20.75	20.93
5	25	0		20.69	20.73	21.06
5	1	0	64-QAM	20.56	20.61	20.71
5	1	12		20.51	20.52	20.74
5	1	24		20.55	20.55	20.73
5	12	0		19.62	19.83	20.03
5	12	7		19.70	19.89	20.04
5	12	13		19.69	19.78	20.05
5	25	0		19.71	19.77	20.09



LTE Band 66 Maximum Average Power [dBm]						
BW [MHz]	RB Size	RB Offset	Mod	Lowest	Middle	Highest
20	1	0	QPSK	22.73	22.80	22.65
20	1	49		22.57	22.43	22.49
20	1	99		22.46	22.33	22.39
20	50	0		21.55	21.74	21.73
20	50	24		21.61	21.49	21.56
20	50	50		21.57	21.52	21.52
20	100	0		21.47	21.69	21.68
20	1	0	16-QAM	22.09	21.99	22.00
20	1	49		22.01	21.78	21.80
20	1	99		21.89	21.62	21.78
20	50	0		20.82	20.73	20.80
20	50	24		20.80	20.68	20.66
20	50	50		20.70	20.55	20.64
20	100	0		20.75	20.64	20.69
20	1	0	64-QAM	21.00	20.94	20.94
20	1	49		20.91	20.70	20.79
20	1	99		20.79	20.58	20.70
20	50	0		19.87	19.73	19.88
20	50	24		19.84	19.67	19.72
20	50	50		19.66	19.54	19.67
20	100	0		19.78	19.69	19.76
15	1	0	QPSK	22.76	22.78	22.65
15	1	37		22.53	22.48	22.61
15	1	74		22.56	22.43	22.60
15	36	0		21.67	21.75	21.74
15	36	20		21.63	21.52	21.71
15	36	39		21.57	21.44	21.61
15	75	0		21.65	21.68	21.67
15	1	0	16-QAM	21.94	21.99	21.97
15	1	37		21.90	21.77	21.90
15	1	74		21.91	21.72	21.93
15	36	0		20.82	20.66	20.82
15	36	20		20.76	20.65	20.80
15	36	39		20.73	20.54	20.71
15	75	0		20.76	20.62	20.80
15	1	0	64-QAM	20.91	20.95	20.94
15	1	37		20.87	20.74	20.86
15	1	74		20.87	20.69	20.84
15	36	0		19.86	19.76	19.87
15	36	20		19.82	19.66	19.84
15	36	39		19.73	19.61	19.78
15	75	0		19.80	19.63	19.83



LTE Band 66 Maximum Average Power [dBm]						
BW [MHz]	RB Size	RB Offset	Mod	Lowest	Middle	Highest
10	1	0	QPSK	22.66	22.57	22.72
10	1	25		22.62	22.47	22.63
10	1	49		22.56	22.40	22.59
10	25	0		21.67	21.57	21.73
10	25	12		21.64	21.52	21.66
10	25	25		21.58	21.50	21.62
10	50	0		21.65	21.49	21.68
10	1	0	16-QAM	21.95	21.92	21.99
10	1	25		21.91	21.78	21.93
10	1	49		21.89	21.73	21.85
10	25	0		20.75	20.62	20.82
10	25	12		20.73	20.60	20.76
10	25	25		20.70	20.57	20.72
10	50	0		20.74	20.63	20.78
10	1	0	64-QAM	20.91	20.84	20.98
10	1	25		20.84	20.74	20.90
10	1	49		20.85	20.69	20.82
10	25	0		19.78	19.68	19.82
10	25	12		19.76	19.64	19.80
10	25	25		19.72	19.59	19.75
10	50	0		19.75	19.62	19.79
5	1	0	QPSK	22.64	22.49	22.64
5	1	12		22.58	22.42	22.59
5	1	24		22.55	22.43	22.59
5	12	0		21.61	21.49	21.67
5	12	7		21.63	21.51	21.65
5	12	13		21.62	21.45	21.64
5	25	0		21.63	21.45	21.64
5	1	0	16-QAM	21.90	21.84	21.99
5	1	12		21.84	21.79	21.92
5	1	24		21.90	21.77	21.91
5	12	0		20.76	20.64	20.74
5	12	7		20.79	20.62	20.75
5	12	13		20.72	20.59	20.74
5	25	0		20.75	20.60	20.73
5	1	0	64-QAM	20.89	20.82	20.94
5	1	12		20.83	20.70	20.90
5	1	24		20.86	20.70	20.88
5	12	0		19.80	19.68	19.81
5	12	7		19.83	19.69	19.85
5	12	13		19.78	19.64	19.78
5	25	0		19.73	19.58	19.76



LTE Band 66 Maximum Average Power [dBm]						
BW [MHz]	RB Size	RB Offset	Mod	Lowest	Middle	Highest
3	1	0	QPSK	22.62	22.47	22.63
3	1	8		22.60	22.43	22.57
3	1	14		22.60	22.41	22.59
3	8	0		21.60	21.49	21.61
3	8	4		21.66	21.50	21.65
3	8	7		21.59	21.45	21.61
3	15	0		21.63	21.47	21.64
3	1	0	16-QAM	21.87	21.79	21.88
3	1	8		21.89	21.77	21.89
3	1	14		21.87	21.72	21.86
3	8	0		20.74	20.63	20.81
3	8	4		20.81	20.68	20.82
3	8	7		20.76	20.65	20.75
3	15	0		20.75	20.61	20.75
3	1	0	64-QAM	20.88	20.76	20.87
3	1	8		20.87	20.75	20.87
3	1	14		20.83	20.73	20.87
3	8	0		19.80	19.65	19.81
3	8	4		19.81	19.65	19.80
3	8	7		19.78	19.62	19.80
3	15	0		19.75	19.61	19.75
1.4	1	0	QPSK	22.50	22.37	22.52
1.4	1	3		22.56	22.45	22.61
1.4	1	5		22.50	22.37	22.53
1.4	3	0		22.53	22.43	22.59
1.4	3	1		22.61	22.47	22.64
1.4	3	3		22.56	22.45	22.57
1.4	6	0		21.56	21.43	21.57
1.4	1	0	16-QAM	21.82	21.72	21.88
1.4	1	3		21.87	21.80	21.90
1.4	1	5		21.78	21.71	21.80
1.4	3	0		21.59	21.49	21.65
1.4	3	1		21.66	21.54	21.67
1.4	3	3		21.60	21.52	21.64
1.4	6	0		20.72	20.58	20.73
1.4	1	0	64-QAM	20.80	20.66	20.87
1.4	1	3		20.86	20.73	20.91
1.4	1	5		20.75	20.63	20.78
1.4	3	0		20.75	20.68	20.82
1.4	3	1		20.82	20.66	20.86
1.4	3	3		20.77	20.62	20.82
1.4	6	0		19.64	19.50	19.66



LTE Band 2

Peak-to-Average Ratio

Mode	LTE Band 2 / 20MHz				
Mod.	QPSK		16QAM		Limit: 13dB
RB Size	1RB	Full RB	1RB	Full RB	Result
Lowest CH	3.54	4.49	5.3	5.88	PASS
Middle CH	3.59	4.67	5.36	6	
Highest CH	3.48	4.55	4.81	6	
Mode	LTE Band 2 / 20MHz				
Mod.	64QAM				Limit: 13dB
RB Size	1RB	Full RB			Result
Lowest CH	6.67	6.41	-	-	PASS
Middle CH	6.58	6.67	-	-	
Highest CH	6.46	6.52	-	-	



LTE Band 2 / 20MHz / QPSK

Lowest Channel / 1RB

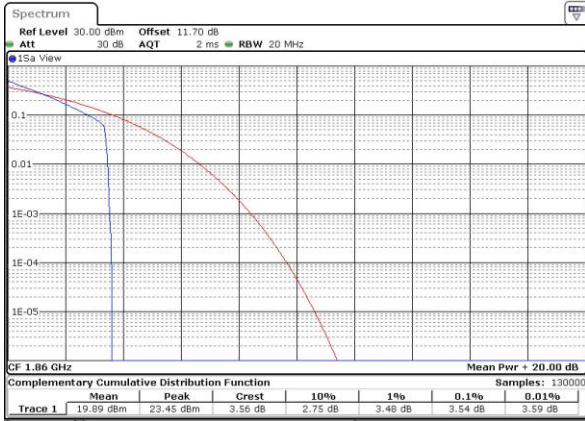

Date: 11 MAY 2019 00:59:10

Lowest Channel / Full RB

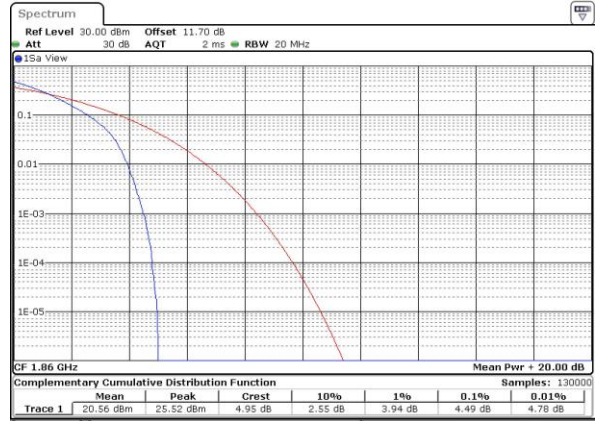

Date: 11 MAY 2019 00:59:23

Middle Channel / 1RB

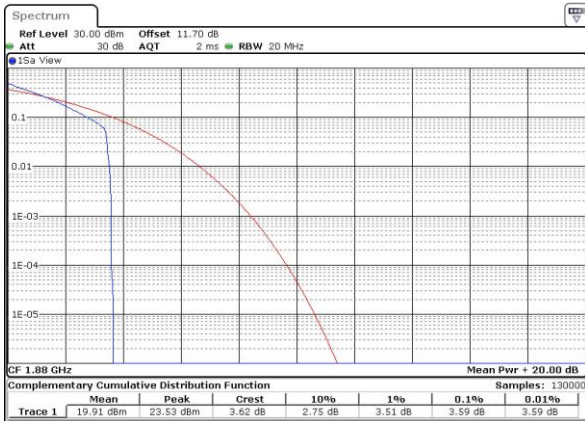

Date: 11 MAY 2019 00:59:34

Middle Channel / Full RB

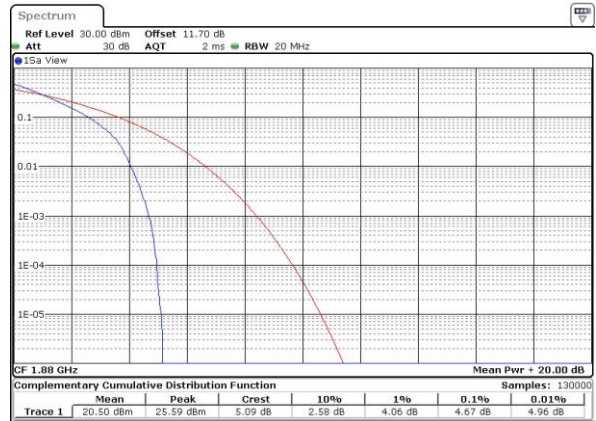

Date: 11 MAY 2019 00:59:45

Highest Channel / 1RB

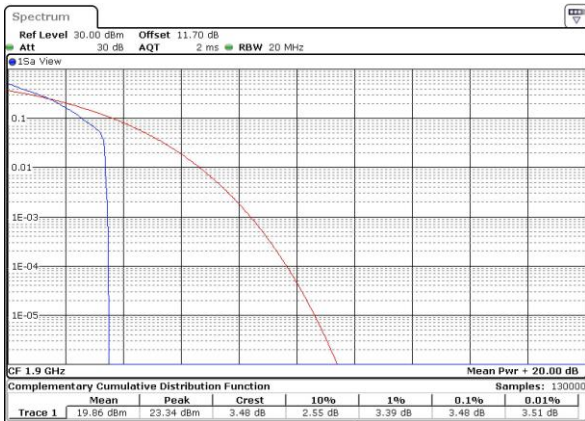

Date: 11 MAY 2019 00:59:56

Highest Channel / Full RB

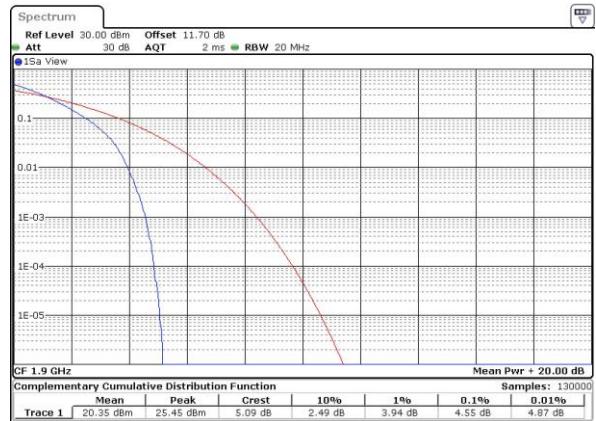

Date: 11 MAY 2019 01:00:07



LTE Band 2 / 20MHz / 16QAM

Lowest Channel / 1RB



Date: 11 MAY 2019 00:57:57

Lowest Channel / Full RB

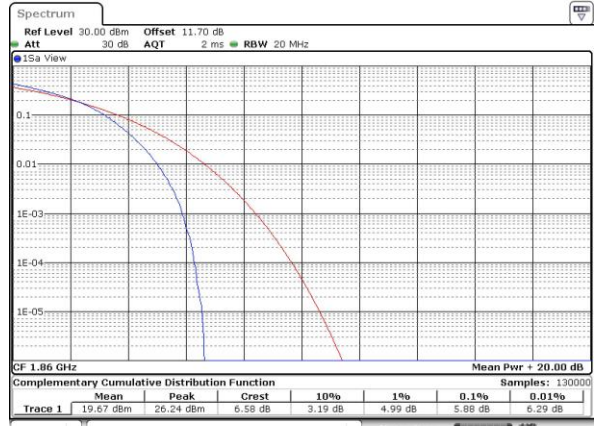

Date: 11 MAY 2019 00:58:09

Middle Channel / 1RB

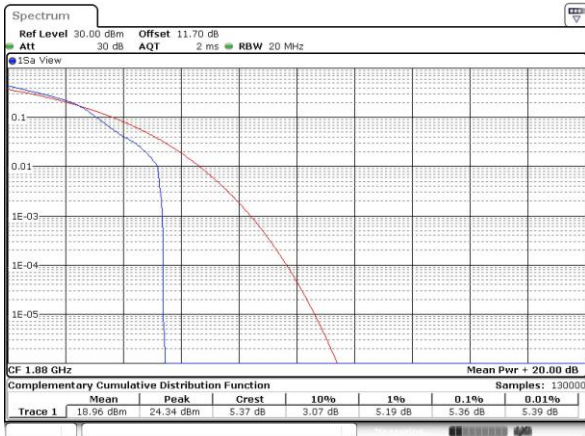

Date: 11 MAY 2019 00:58:20

Middle Channel / Full RB

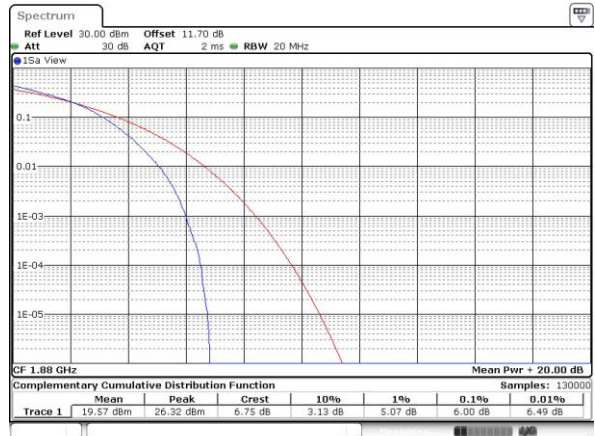

Date: 11 MAY 2019 00:58:31

Highest Channel / 1RB



Date: 11 MAY 2019 00:58:42

Highest Channel / Full RB

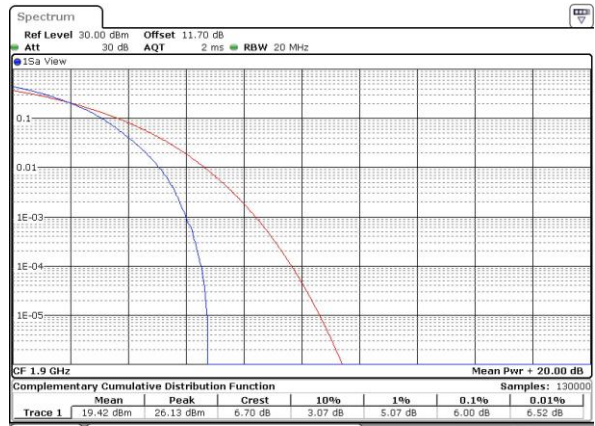

Date: 11 MAY 2019 00:58:57



LTE Band 2 / 20MHz / 64QAM

Lowest Channel / 1RB



Date: 11 MAY 2019 01:00:19

Lowest Channel / Full RB

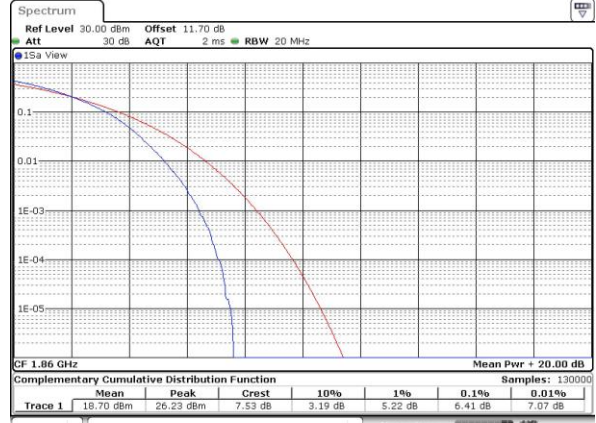

Date: 11 MAY 2019 01:00:31

Middle Channel / 1RB

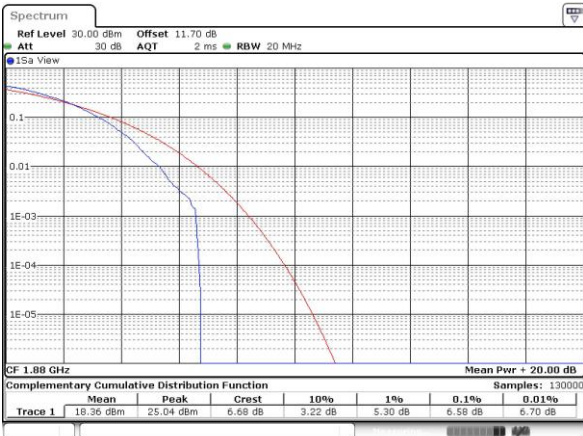

Date: 11 MAY 2019 01:00:42

Middle Channel / Full RB

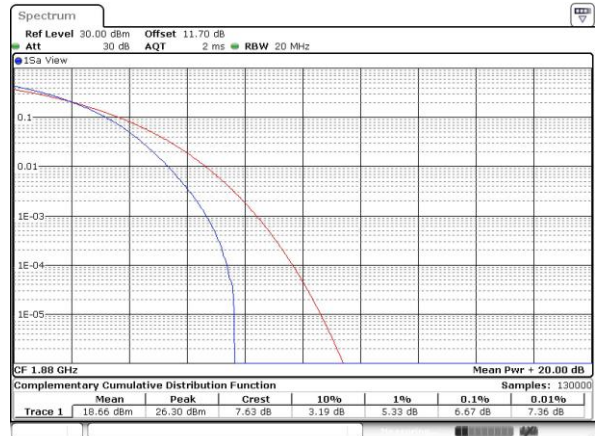

Date: 11 MAY 2019 01:01:02

Highest Channel / 1RB

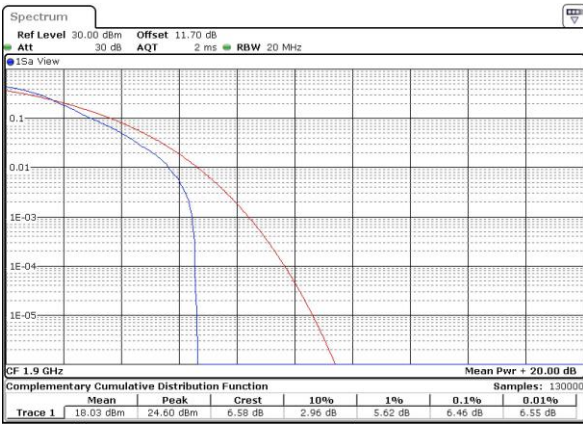

Date: 11 MAY 2019 01:01:13

Highest Channel / Full RB

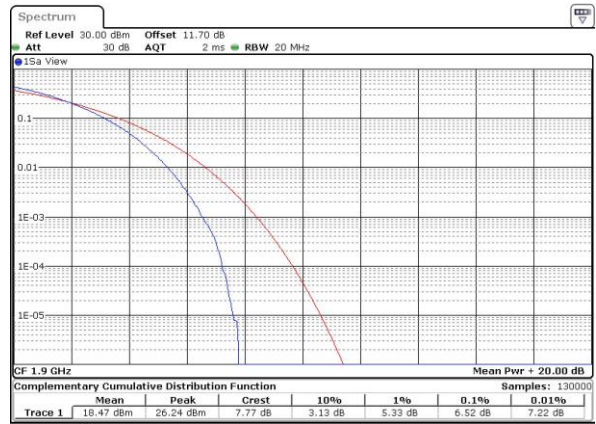

Date: 11 MAY 2019 01:02:03



26dB Bandwidth

Mode	LTE Band 2 : 26dB BW(MHz)											
BW	1.4MHz		3MHz		5MHz		10MHz		15MHz		20MHz	
Mod.	QPSK	16QAM	QPSK	16QAM	QPSK	16QAM	QPSK	16QAM	QPSK	16QAM	QPSK	16QAM
Lowest CH	1.23	1.22	3.00	3.00	4.92	4.96	9.81	9.77	14.24	14.30	18.82	18.66
Middle CH	1.23	1.21	3.06	3.02	4.92	4.92	9.69	9.83	14.57	14.54	19.02	19.22
Highest CH	1.24	1.20	2.99	3.07	4.93	4.82	9.73	9.75	14.54	14.15	19.10	19.06
Mode	LTE Band 2 : 26dB BW(MHz)											
BW	1.4MHz		3MHz		5MHz		10MHz		15MHz		20MHz	
Mod.	64QAM		64QAM		64QAM		64QAM		64QAM		64QAM	
Lowest CH	1.24	-	3.03	-	4.84	-	9.79	-	14.42	-	18.74	-
Middle CH	1.22	-	3.02	-	4.86	-	9.73	-	14.54	-	19.02	-
Highest CH	1.22	-	3.02	-	4.89	-	9.75	-	14.21	-	19.10	-



LTE Band 2

Lowest Channel / 1.4MHz / QPSK

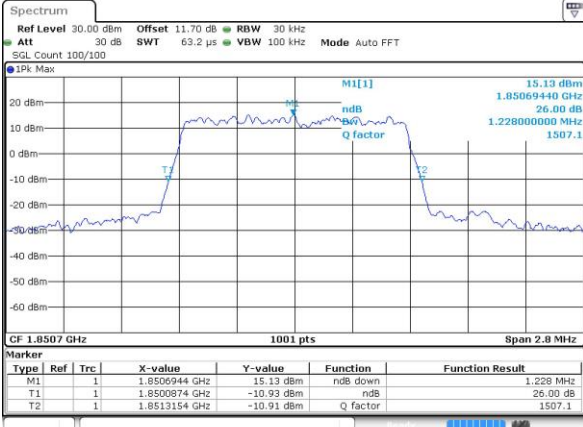

Date: 11 MAY 2019 00:40:42

Lowest Channel / 1.4MHz / 16QAM

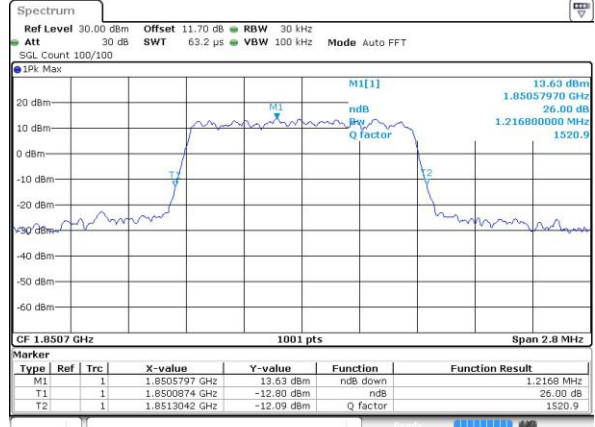

Date: 11 MAY 2019 00:40:54

Middle Channel / 1.4MHz / QPSK

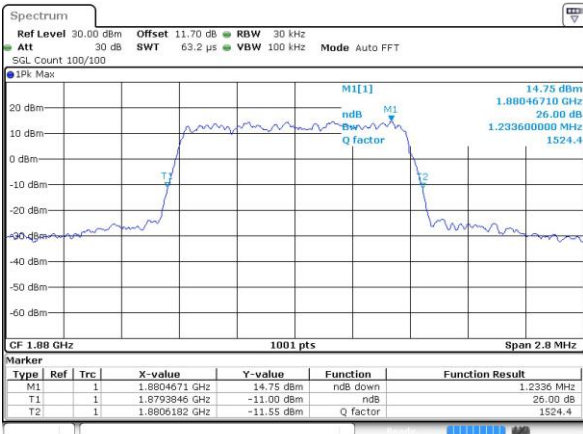

Date: 11 MAY 2019 00:47:11

Middle Channel / 1.4MHz / 16QAM

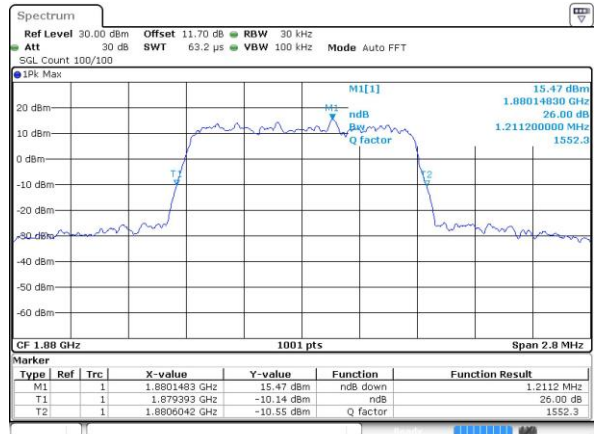

Date: 11 MAY 2019 00:47:23

Highest Channel / 1.4MHz / QPSK

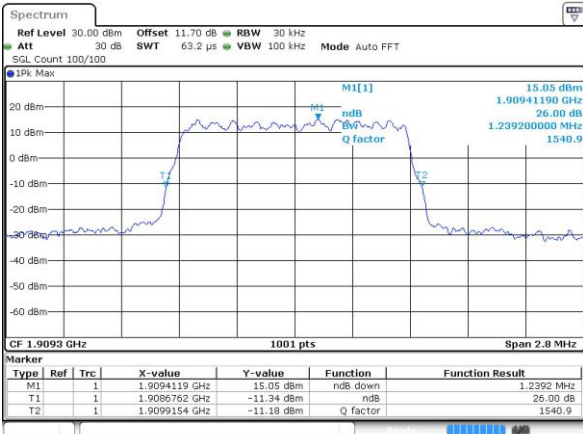

Date: 11 MAY 2019 00:49:21

Highest Channel / 1.4MHz / 16QAM

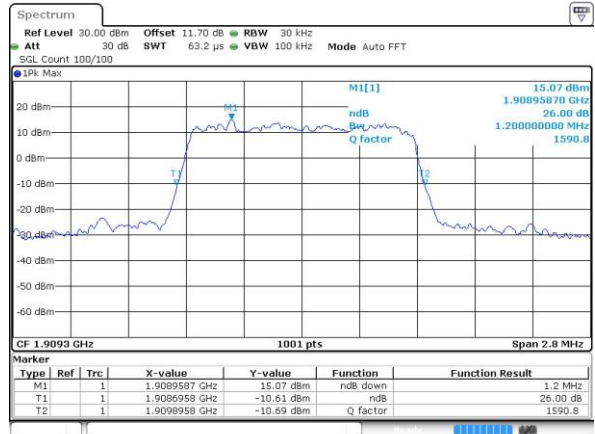

Date: 11 MAY 2019 00:49:34



LTE Band 2

Lowest Channel / 3MHz / QPSK

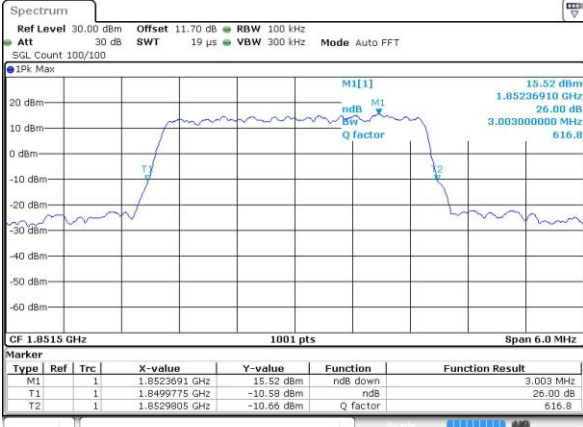

Date: 10 MAY 2019 22:56:05

Lowest Channel / 3MHz / 16QAM

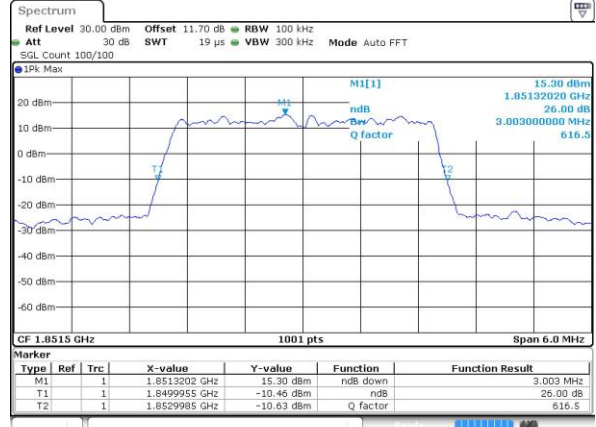

Date: 10 MAY 2019 22:56:18

Middle Channel / 3MHz / QPSK

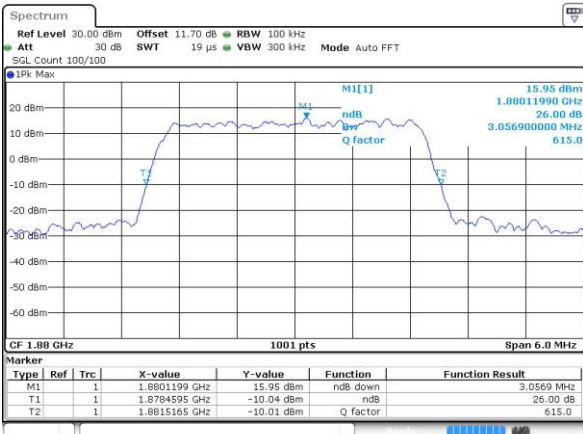

Date: 10 MAY 2019 23:00:43

Middle Channel / 3MHz / 16QAM

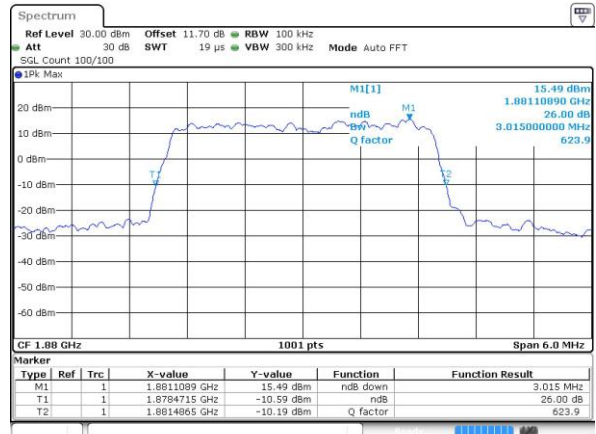

Date: 10 MAY 2019 23:00:54

Highest Channel / 3MHz / QPSK

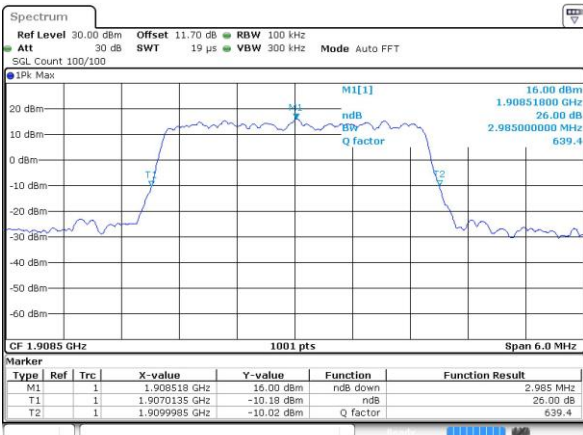

Date: 10 MAY 2019 23:02:53

Highest Channel / 3MHz / 16QAM

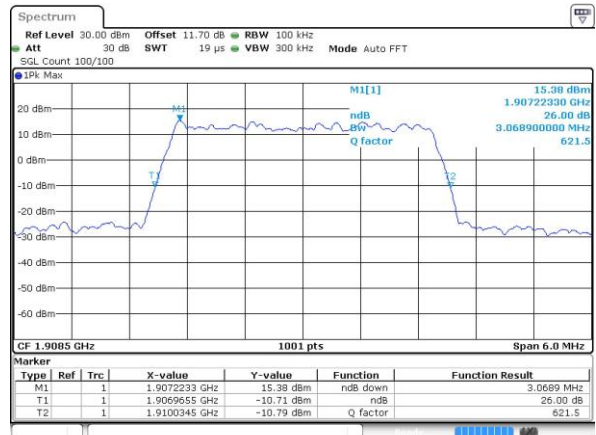

Date: 10 MAY 2019 23:03:05



LTE Band 2

Lowest Channel / 5MHz / QPSK

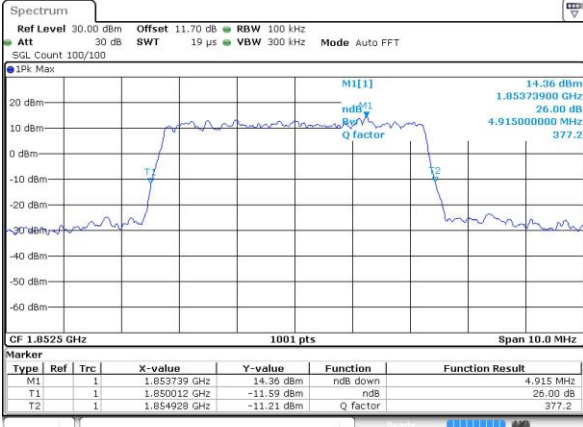

Date: 10 MAY 2019 23:07:31

Lowest Channel / 5MHz / 16QAM

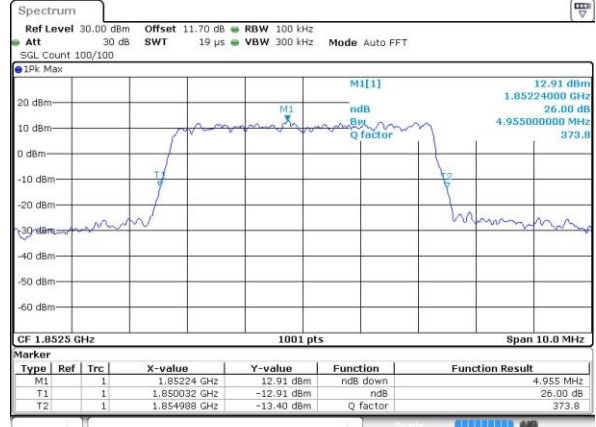

Date: 10 MAY 2019 23:07:43

Middle Channel / 5MHz / QPSK

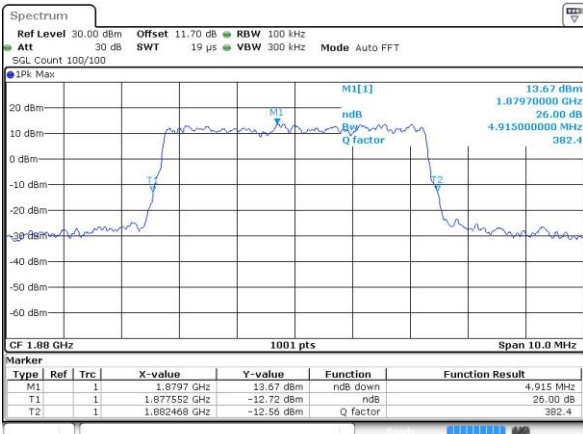

Date: 10 MAY 2019 23:12:07

Middle Channel / 5MHz / 16QAM

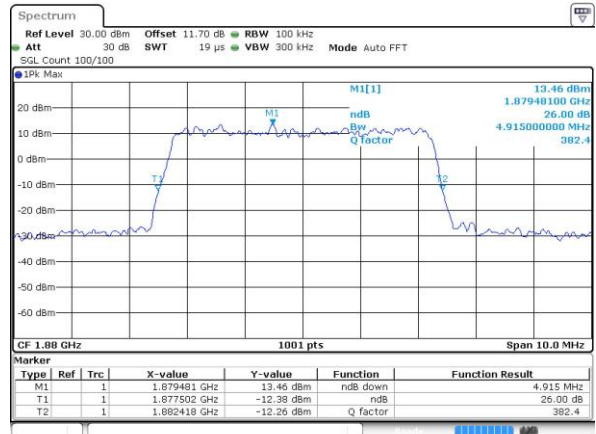

Date: 10 MAY 2019 23:12:19

Highest Channel / 5MHz / QPSK

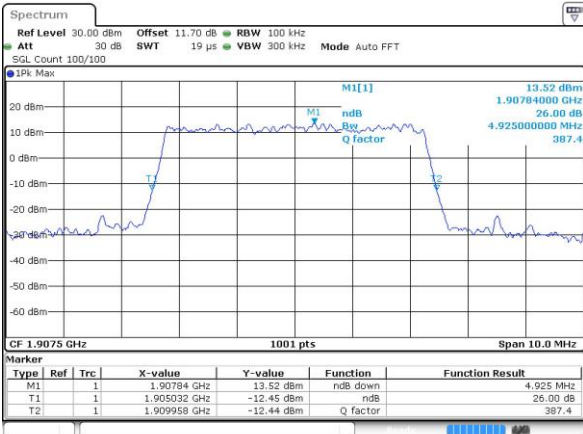

Date: 10 MAY 2019 23:14:17

Highest Channel / 5MHz / 16QAM

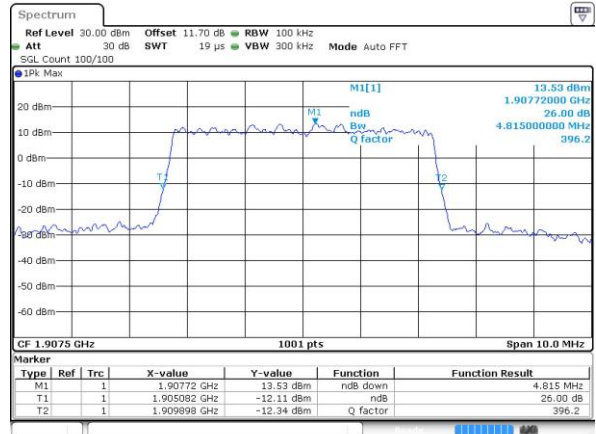

Date: 10 MAY 2019 23:14:30



LTE Band 2

Lowest Channel / 10MHz / QPSK

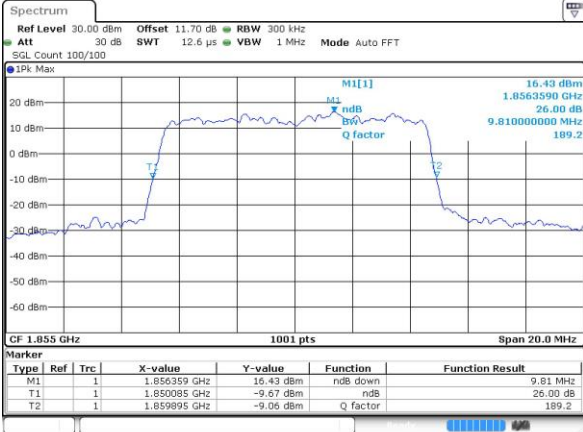

Date: 10 MAY 2019 23:18:55

Lowest Channel / 10MHz / 16QAM

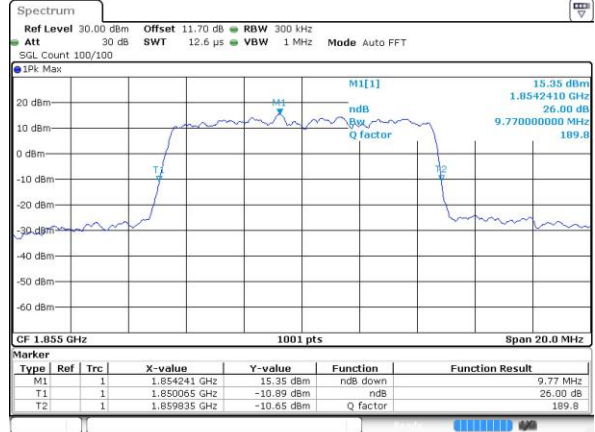

Date: 10 MAY 2019 23:19:07

Middle Channel / 10MHz / QPSK



Date: 10 MAY 2019 23:23:30

Middle Channel / 10MHz / 16QAM

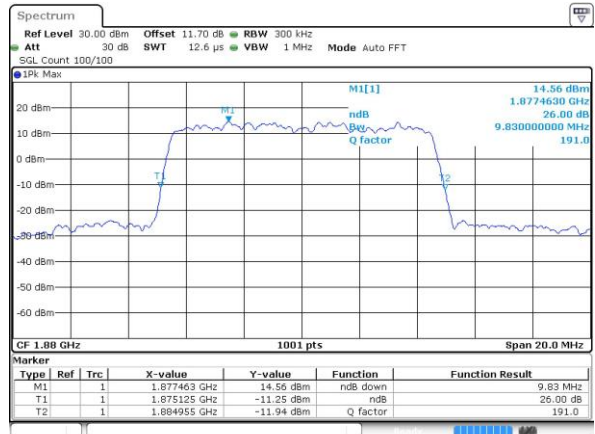

Date: 10 MAY 2019 23:24:42

Highest Channel / 10MHz / QPSK

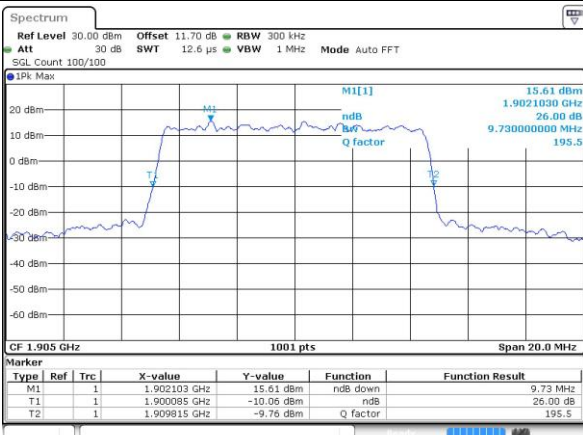

Date: 10 MAY 2019 23:25:41

Highest Channel / 10MHz / 16QAM

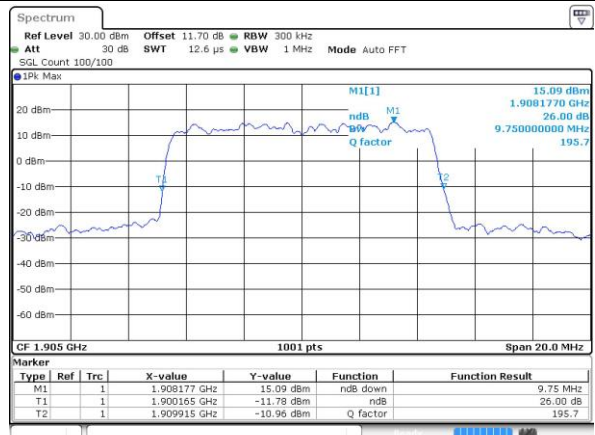

Date: 10 MAY 2019 23:25:53



LTE Band 2

Lowest Channel / 15MHz / QPSK

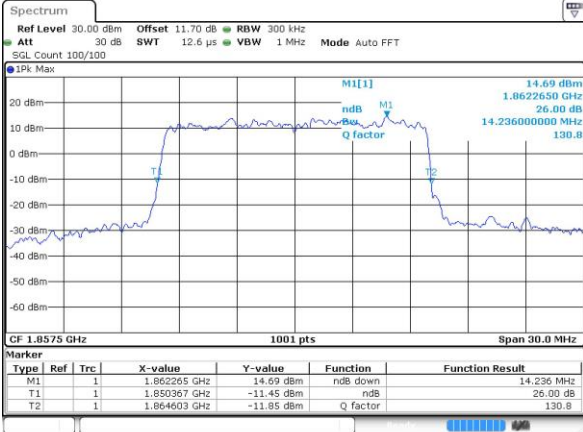

Date: 10 MAY 2019 23:30:20

Lowest Channel / 15MHz / 16QAM

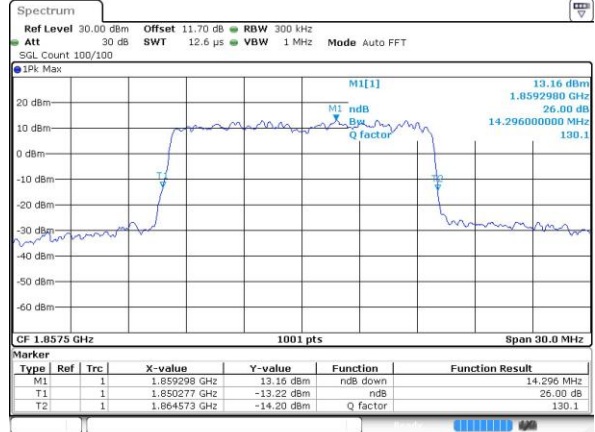

Date: 10 MAY 2019 23:30:32

Middle Channel / 15MHz / QPSK



Date: 10 MAY 2019 23:34:56

Middle Channel / 15MHz / 16QAM

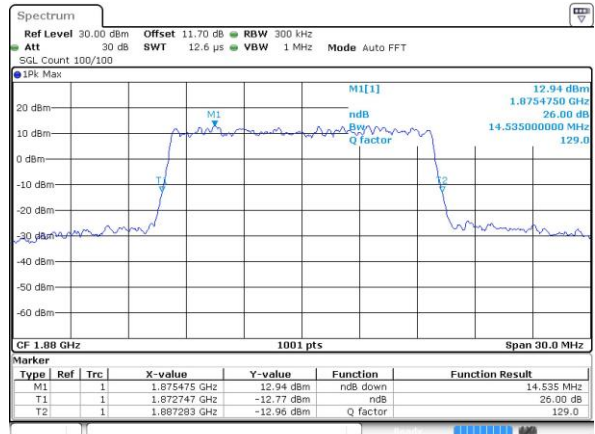

Date: 10 MAY 2019 23:35:08

Highest Channel / 15MHz / QPSK



Date: 10 MAY 2019 23:37:06

Highest Channel / 15MHz / 16QAM

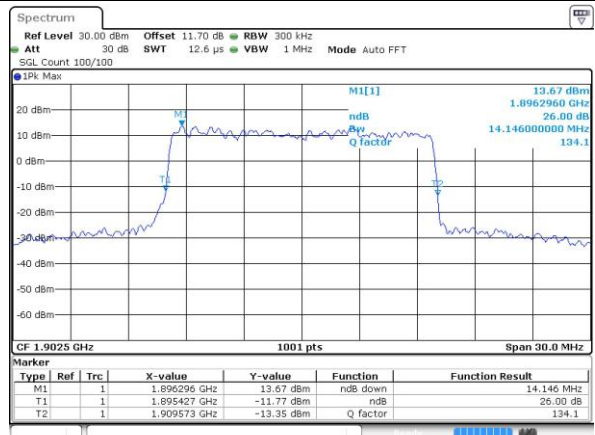

Date: 10 MAY 2019 23:37:19



LTE Band 2

Lowest Channel / 20MHz / QPSK

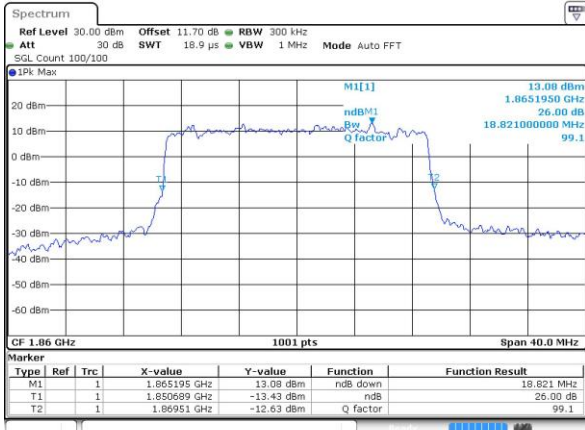

Date: 10 MAY 2019 23:41:44

Lowest Channel / 20MHz / 16QAM

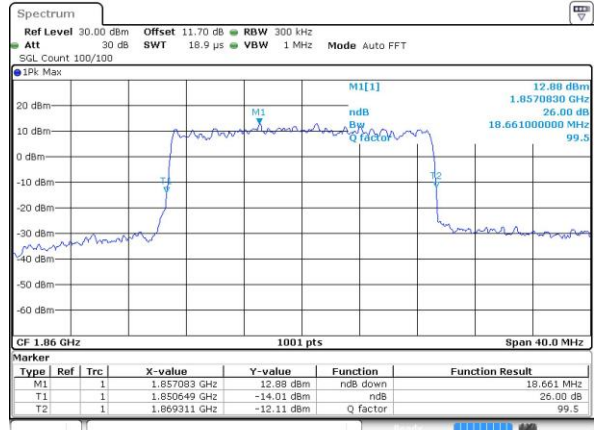

Date: 10 MAY 2019 23:41:57

Middle Channel / 20MHz / QPSK

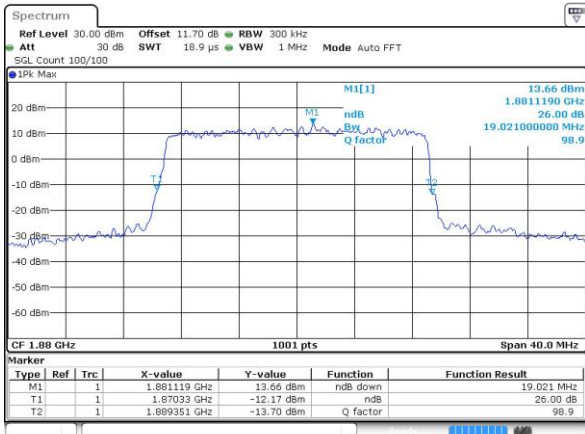

Date: 10 MAY 2019 23:46:21

Middle Channel / 20MHz / 16QAM

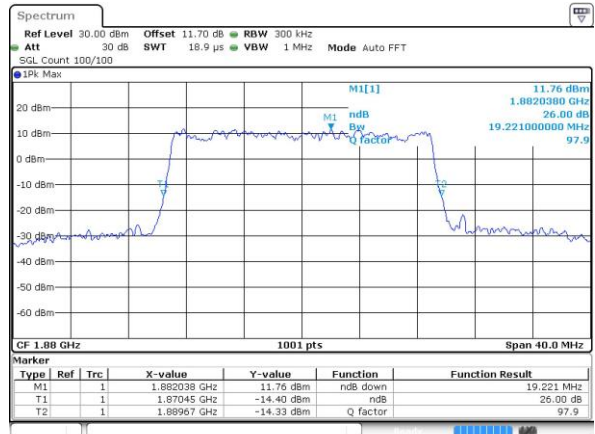

Date: 10 MAY 2019 23:46:33

Highest Channel / 20MHz / QPSK

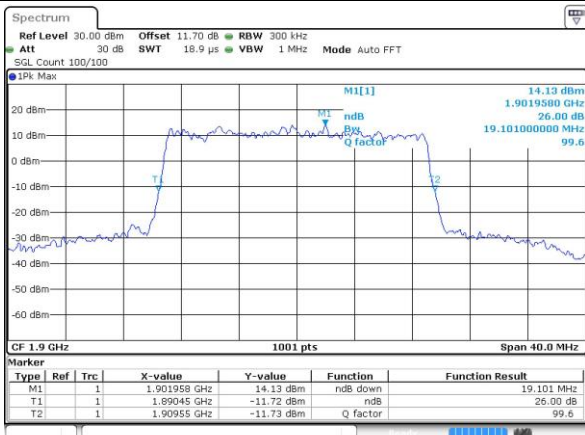

Date: 10 MAY 2019 23:48:32

Highest Channel / 20MHz / 16QAM

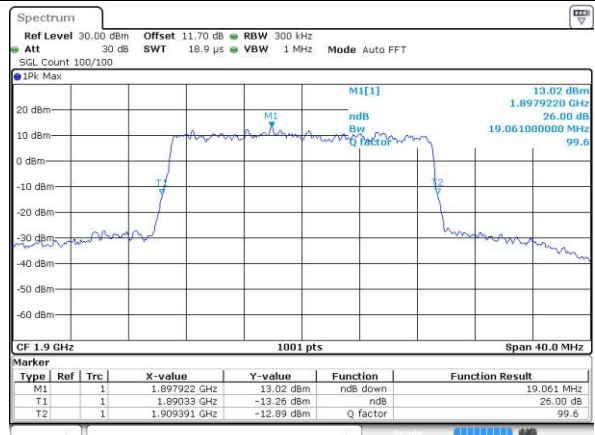

Date: 10 MAY 2019 23:48:44



LTE Band 2

Lowest Channel / 1.4MHz / 64QAM

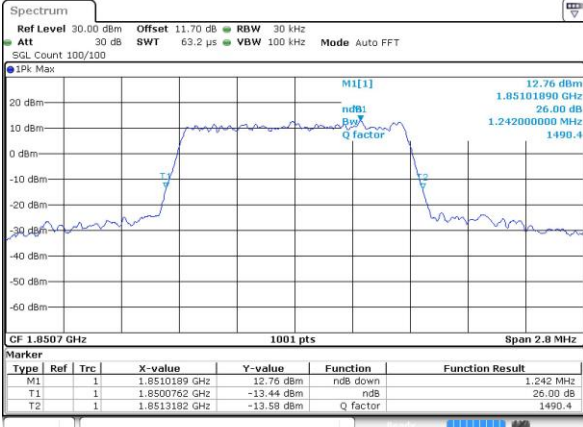

Date: 11 MAY 2019 00:32:55

Lowest Channel / 3MHz / 64QAM

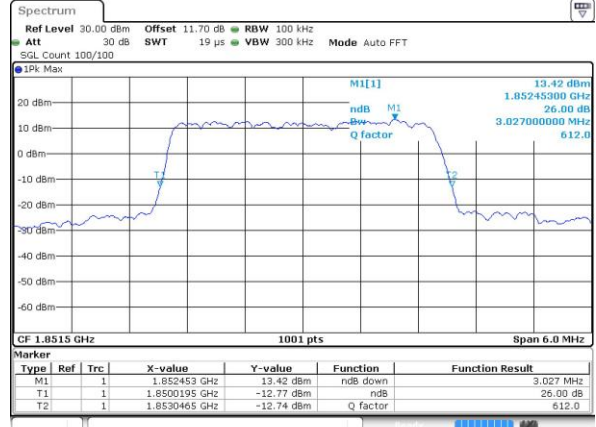

Date: 10 MAY 2019 23:52:57

Middle Channel / 1.4MHz / 64QAM

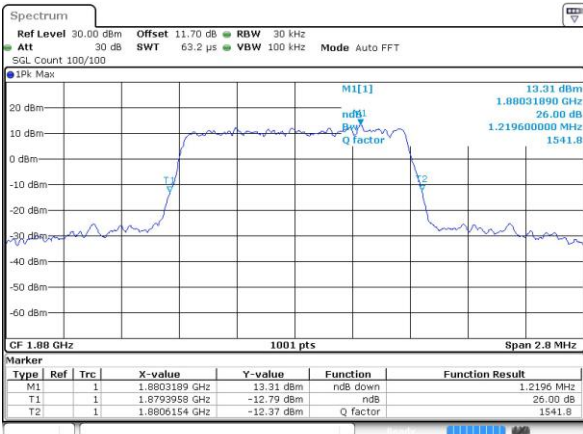

Date: 11 MAY 2019 00:36:09

Middle Channel / 3MHz / 64QAM

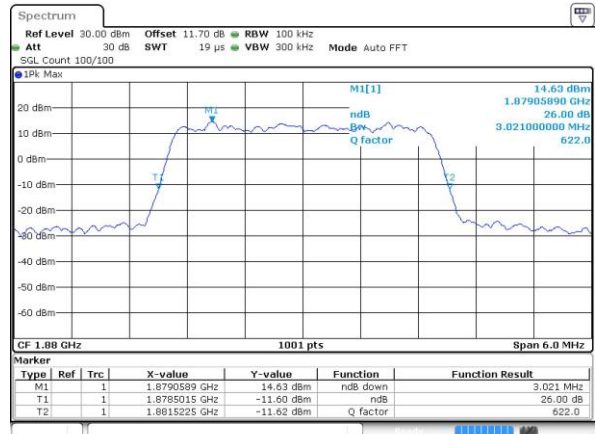

Date: 10 MAY 2019 23:55:15

Highest Channel / 1.4MHz / 64QAM

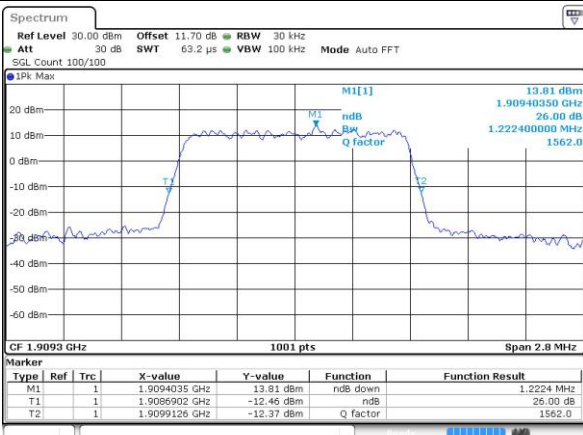

Date: 11 MAY 2019 00:37:15

Highest Channel / 3MHz / 64QAM

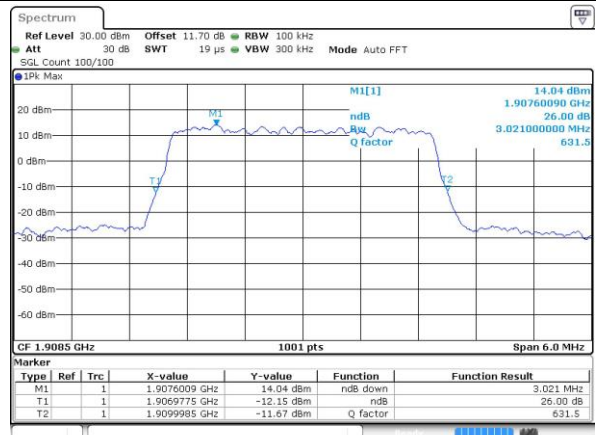

Date: 10 MAY 2019 23:56:20



LTE Band 2

Lowest Channel / 5MHz / 64QAM

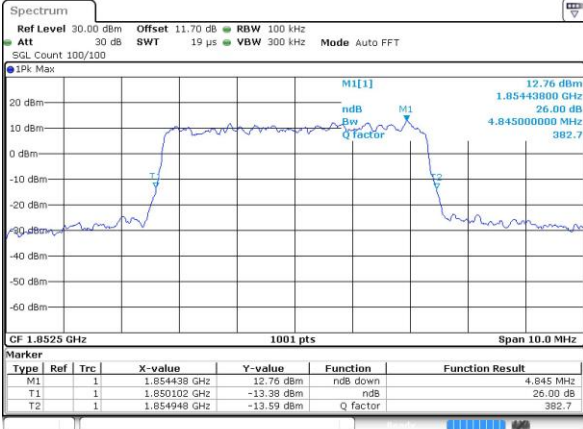

Date: 10 MAY 2019 23:58:39

Lowest Channel / 10MHz / 64QAM

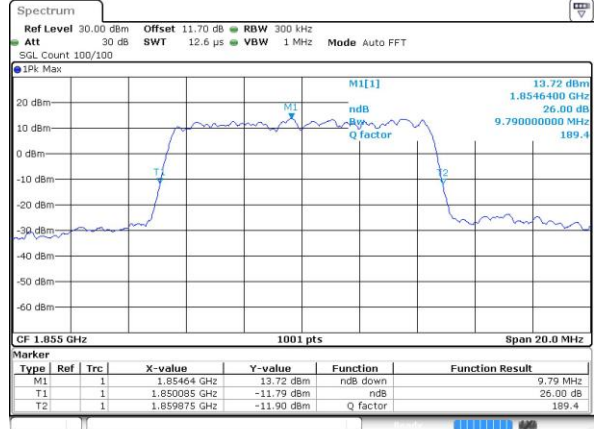

Date: 11 MAY 2019 00:04:22

Middle Channel / 5MHz / 64QAM

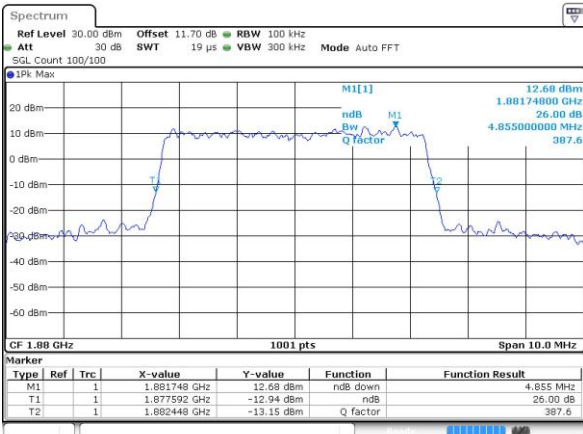

Date: 11 MAY 2019 00:00:57

Middle Channel / 10MHz / 64QAM

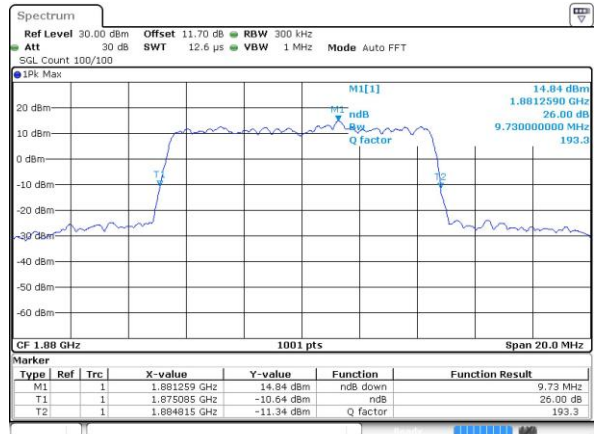

Date: 11 MAY 2019 00:06:40

Highest Channel / 5MHz / 64QAM

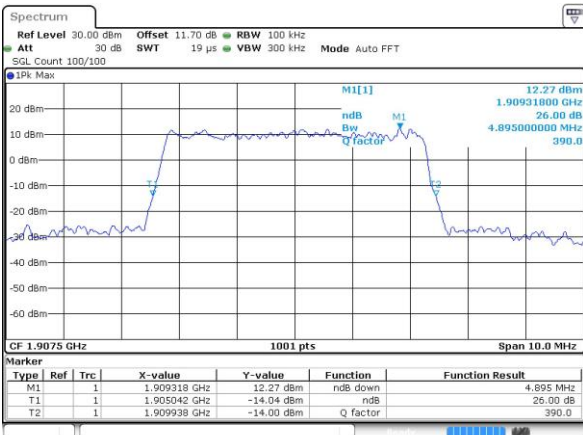

Date: 11 MAY 2019 00:02:02

Highest Channel / 10MHz / 64QAM

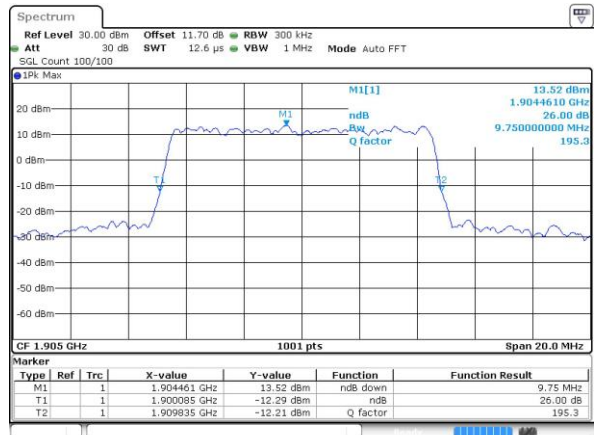

Date: 11 MAY 2019 00:07:45



LTE Band 2

Lowest Channel / 15MHz / 64QAM

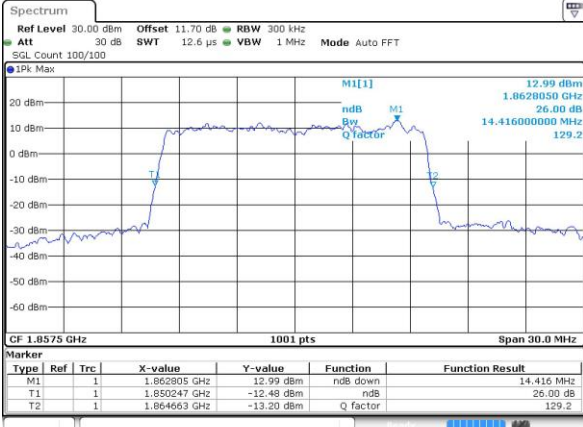

Date: 11 MAY 2019 00:10:04

Lowest Channel / 20MHz / 64QAM

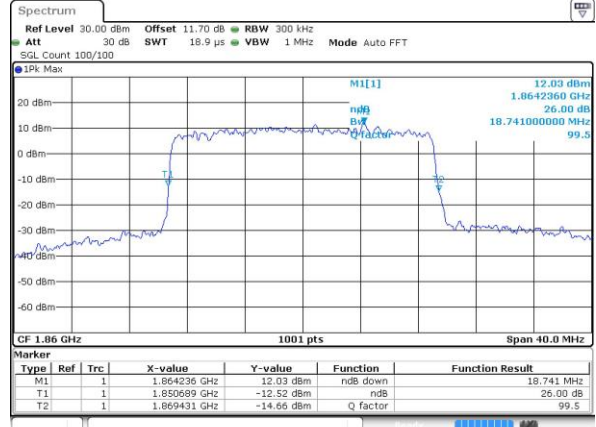

Date: 11 MAY 2019 00:15:46

Middle Channel / 15MHz / 64QAM

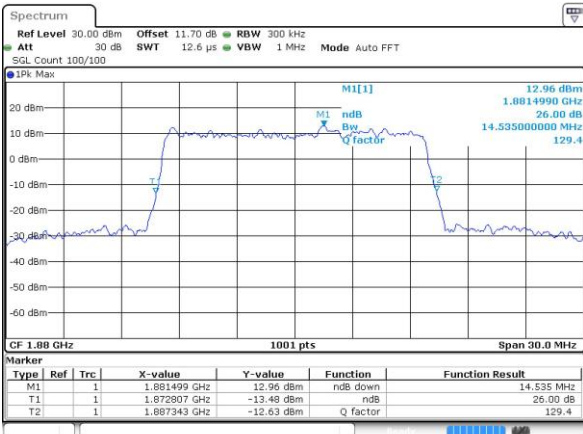

Date: 11 MAY 2019 00:12:22

Middle Channel / 20MHz / 64QAM

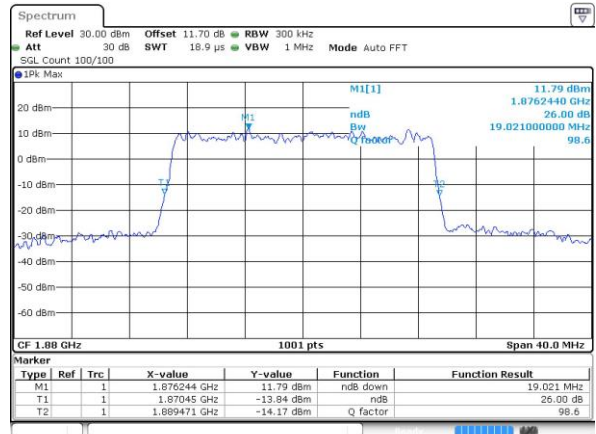

Date: 11 MAY 2019 00:18:04

Highest Channel / 15MHz / 64QAM

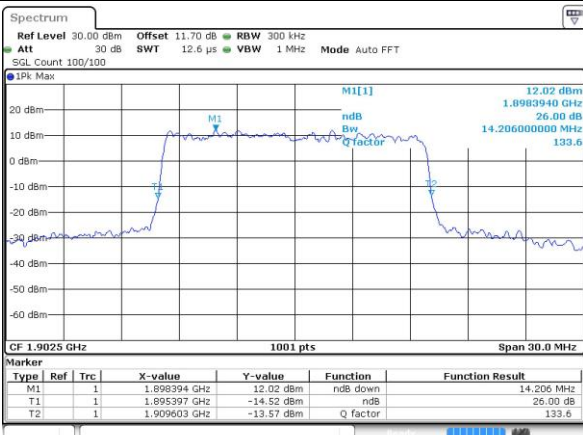

Date: 11 MAY 2019 00:13:27

Highest Channel / 20MHz / 64QAM

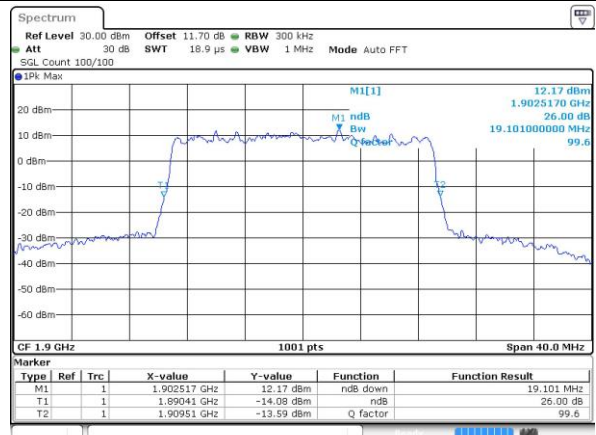

Date: 11 MAY 2019 00:19:09



Occupied Bandwidth

Mode	LTE Band 2 : 99%OBW(MHz)											
BW	1.4MHz		3MHz		5MHz		10MHz		15MHz		20MHz	
Mod.	QPSK	16QAM	QPSK	16QAM	QPSK	16QAM	QPSK	16QAM	QPSK	16QAM	QPSK	16QAM
Lowest CH	1.09	1.1	2.72	2.71	4.47	4.5	9.03	9.01	13.46	13.37	17.86	17.78
Middle CH	1.08	1.09	2.72	2.73	4.51	4.5	9.05	9.03	13.43	13.46	17.94	17.86
Highest CH	1.08	1.09	2.71	2.73	4.49	4.48	9.03	9.01	13.4	13.49	17.74	17.82
Mode	LTE Band 2 : 99%OBW(MHz)											
BW	1.4MHz		3MHz		5MHz		10MHz		15MHz		20MHz	
Mod.	64QAM		64QAM		64QAM		64QAM		64QAM		64QAM	
Lowest CH	1.09	-	2.73	-	4.49	-	9.03	-	13.49	-	17.82	-
Middle CH	1.09	-	2.72	-	4.50	-	9.03	-	13.40	-	17.90	-
Highest CH	1.09	-	2.73	-	4.49	-	9.03	-	13.43	-	17.86	-



LTE Band 2

Lowest Channel / 1.4MHz / QPSK

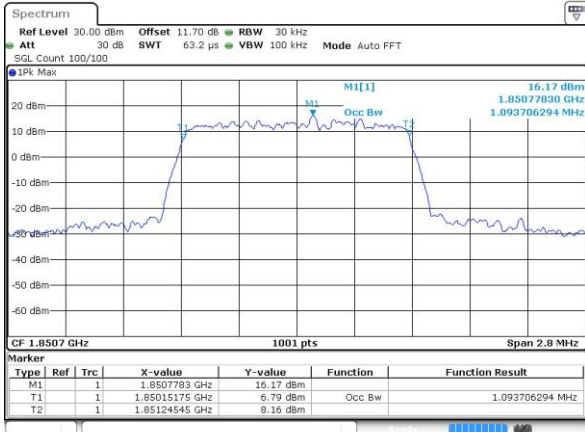

Lowest Channel / 1.4MHz / 16QAM

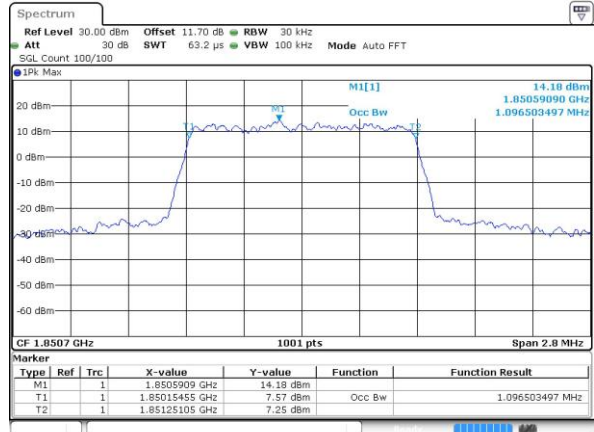

Middle Channel / 1.4MHz / QPSK

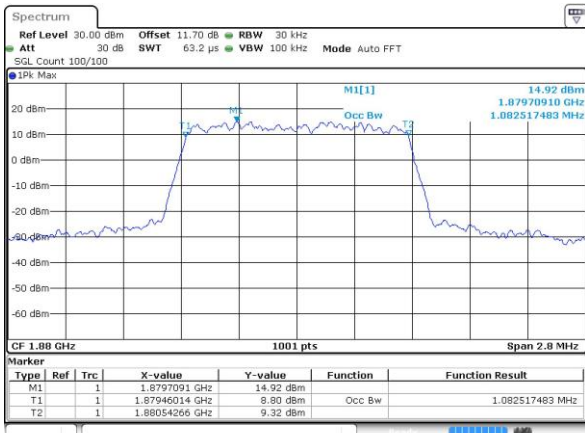

Middle Channel / 1.4MHz / 16QAM

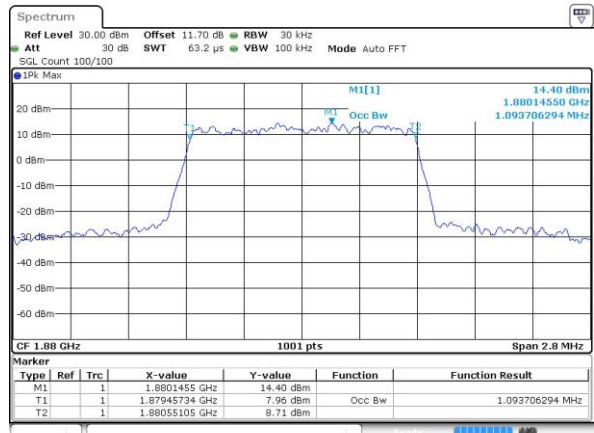

Highest Channel / 1.4MHz / QPSK

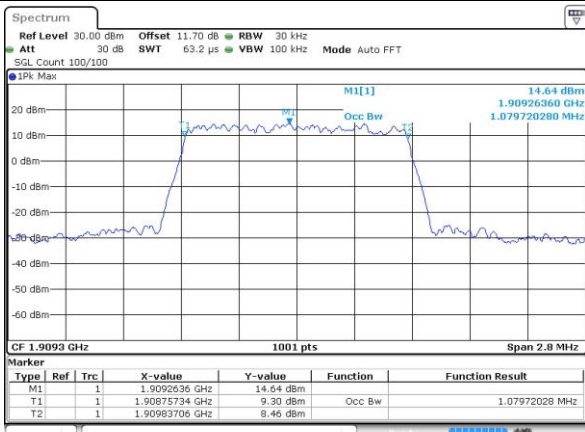

Highest Channel / 1.4MHz / 16QAM

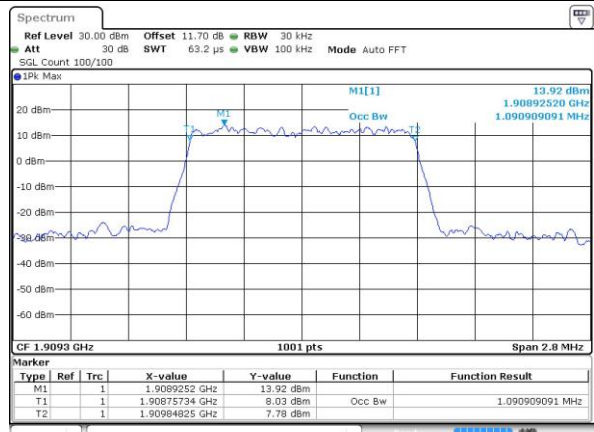



LTE Band 2

Lowest Channel / 3MHz / QPSK

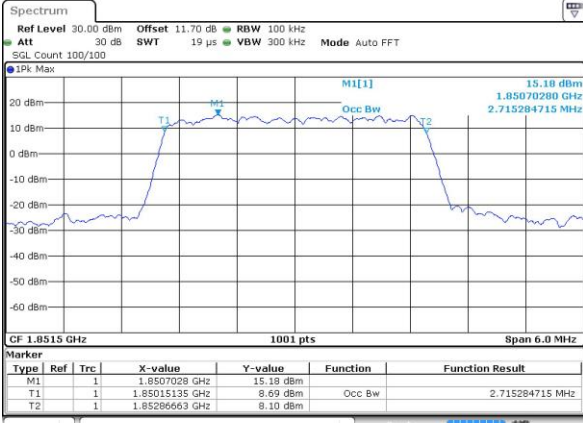

Date: 10 MAY 2019 22:55:40

Lowest Channel / 3MHz / 16QAM

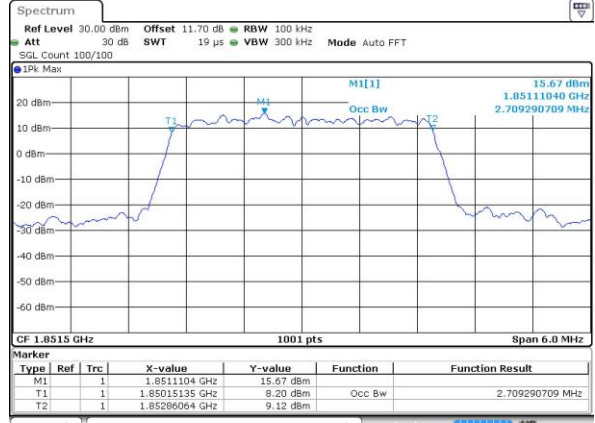

Date: 10 MAY 2019 22:55:53

Middle Channel / 3MHz / QPSK

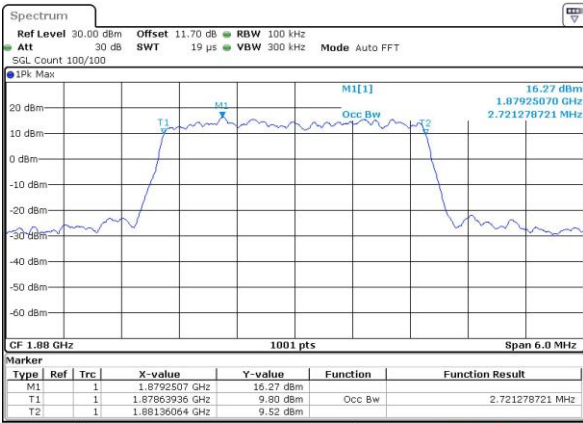

Date: 10 MAY 2019 23:00:19

Middle Channel / 3MHz / 16QAM

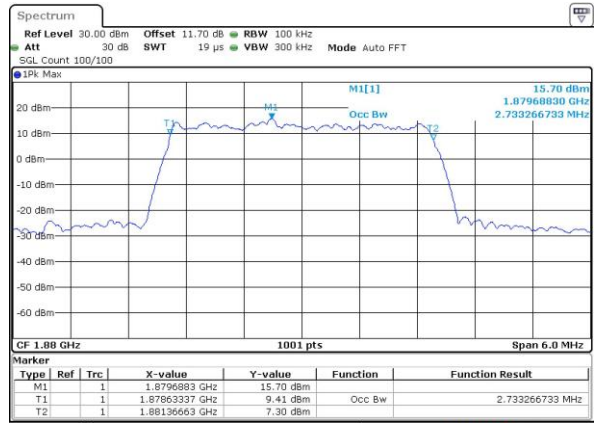

Date: 10 MAY 2019 23:00:31

Highest Channel / 3MHz / QPSK

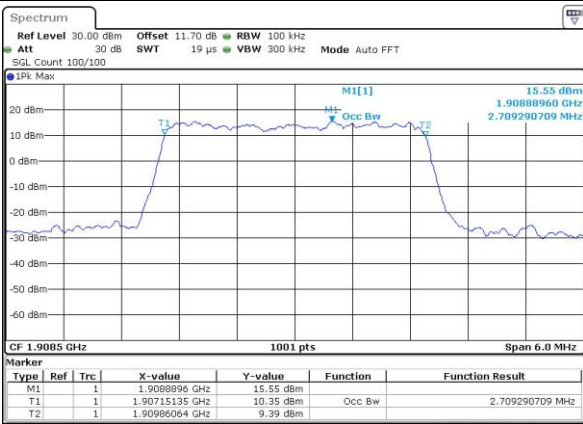

Date: 10 MAY 2019 23:02:28

Highest Channel / 3MHz / 16QAM

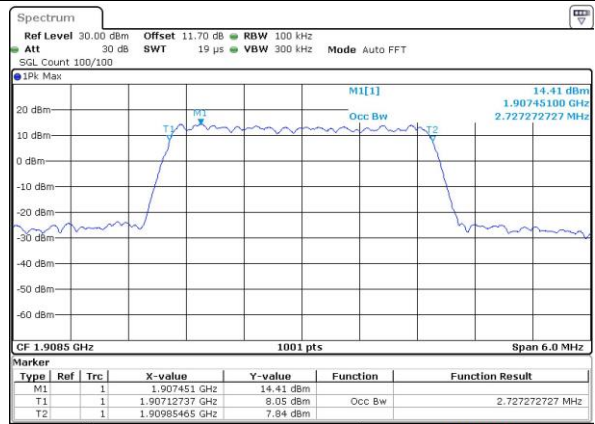

Date: 10 MAY 2019 23:02:41