

Case #24	Band	Position	SAR (W/kg)	Gap (mm)	SAR peak location (mm)			3D distance (mm)	Summed SAR (W/kg)	SPLSR Results	Simultaneous SAR
					X	Y	Z				
	CDMA2000 BC10	Back	0.901	5	-2.7	-63.6	-2.56	132.5	1.99	0.02	Not required
	WLAN2.4GHz		1.086	5	-28.2	66.4	-2.19				

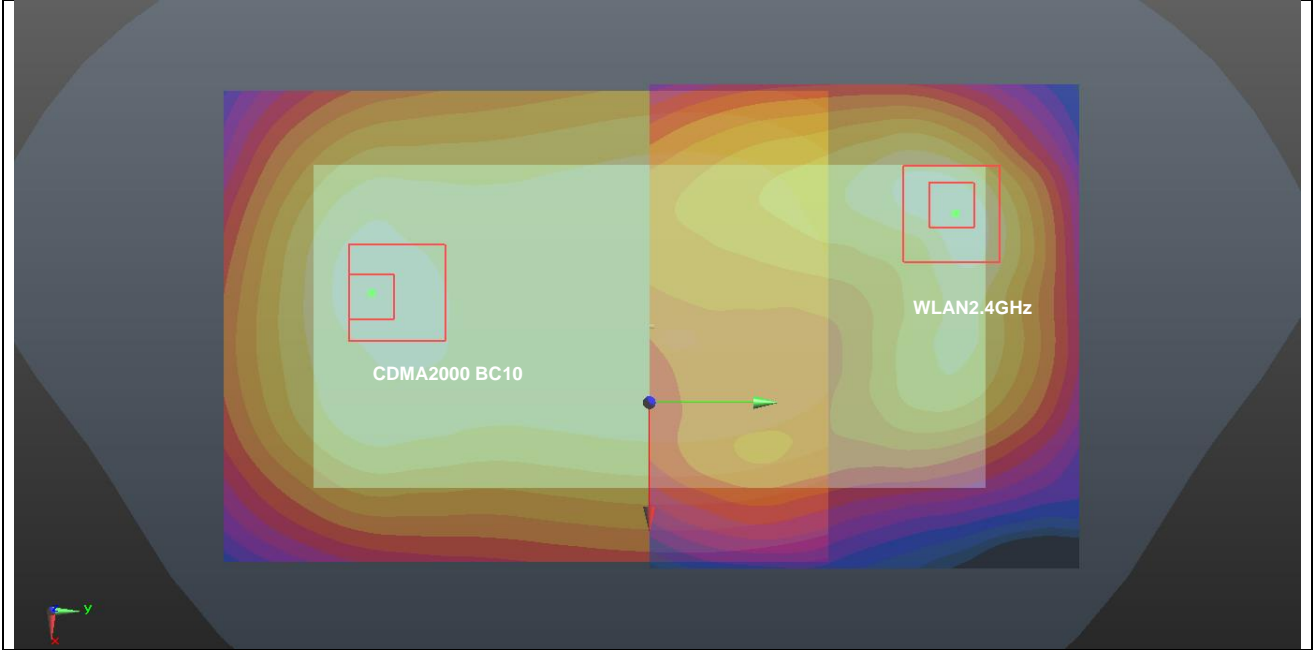

Case #25	Band	Position	SAR (W/kg)	Gap (mm)	SAR peak location (mm)			3D distance (mm)	Summed SAR (W/kg)	SPLSR Results	Simultaneous SAR
					X	Y	Z				
	CDMA2000 BC10	Back	0.901	5	-2.7	-63.6	-2.56	116.8	2.10	0.03	Not required
	WLAN5GHz		1.195	5	-25.2	51	-2.33				



Case #26	Band	Position	SAR (W/kg)	Gap (mm)	SAR peak location (mm)			3D distance (mm)	Summed SAR (W/kg)	SPLSR Results	Simultaneous SAR
					X	Y	Z				
	CDMA2000 BC1	Front	1.139	5	-22.5	-72	-0.73	150.8	1.71	0.01	Not required
	WLAN2.4GHz		0.572	5	16.7	73.6	-1.7				

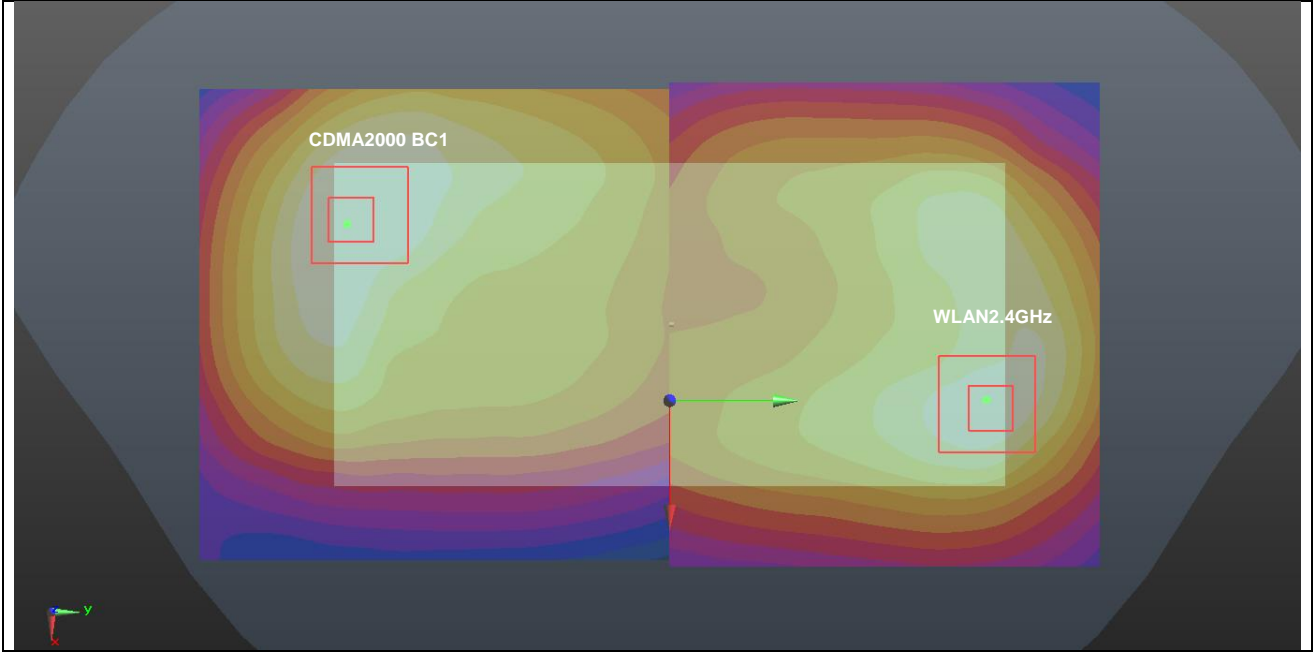

Case #27	Band	Position	SAR (W/kg)	Gap (mm)	SAR peak location (mm)			3D distance (mm)	Summed SAR (W/kg)	SPLSR Results	Simultaneous SAR
					X	Y	Z				
	CDMA2000 BC1	Back	1.374	5	3	-70.5	-0.59	140.4	2.46	0.03	Not required
	WLAN2.4GHz		1.086	5	-28.2	66.4	-2.19				

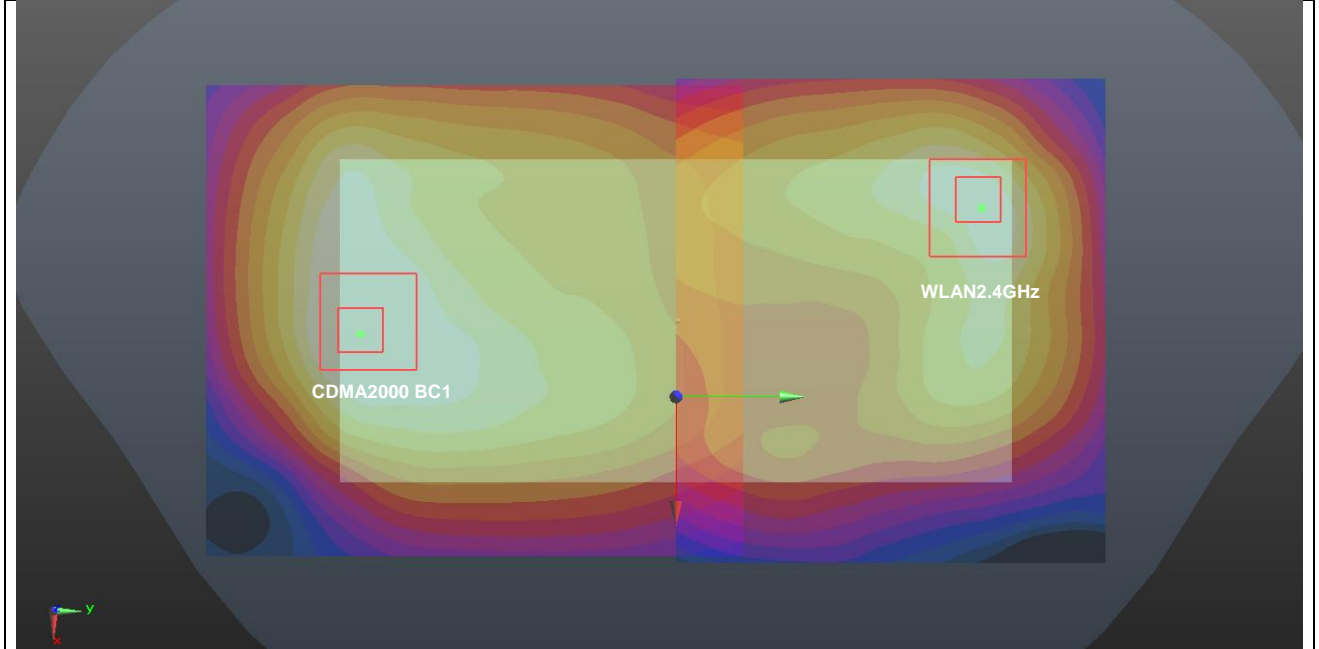

Case #28	Band	Position	SAR (W/kg)	Gap (mm)	SAR peak location (mm)			3D distance (mm)	Summed SAR (W/kg)	SPLSR Results	Simultaneous SAR
					X	Y	Z				
	CDMA2000 BC1	Back	1.374	5	3	-70.5	-0.59	124.7	2.57	0.03	Not required
	WLAN5GHz		1.195	5	-25.2	51	-2.33				

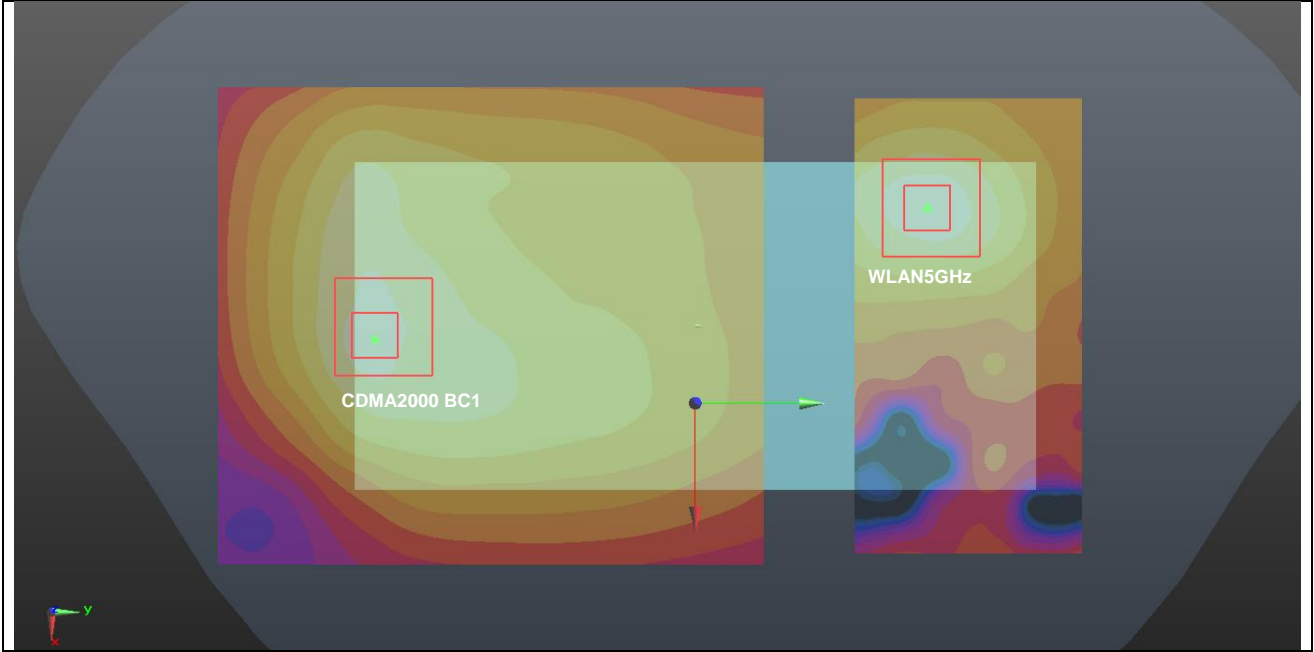

Case #29	Band	Position	SAR (W/kg)	Gap (mm)	SAR peak location (mm)			3D distance (mm)	Summed SAR (W/kg)	SPLSR Results	Simultaneous SAR
					X	Y	Z				
	LTE Band 71	Back	0.699	5	-4.2	-70.3	-2.33	138.8	1.79	0.02	Not required
	WLAN2.4GHz		1.086	5	-28.2	66.4	-2.19				

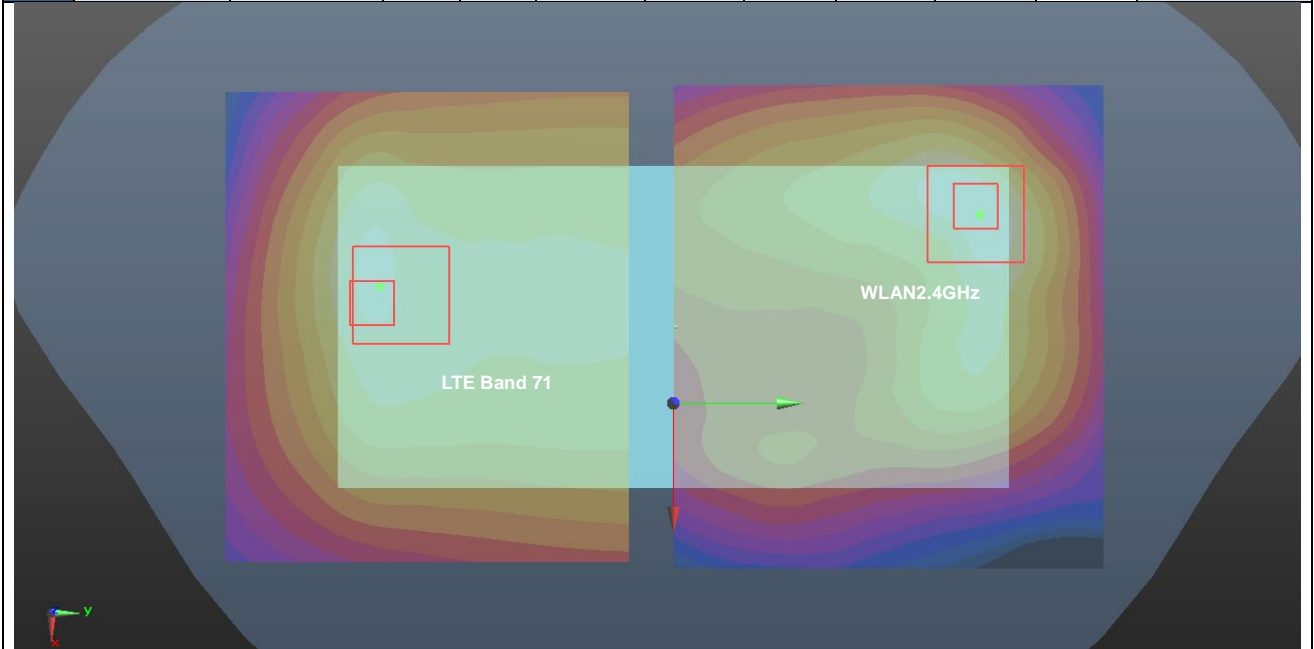

Case #30	Band	Position	SAR (W/kg)	Gap (mm)	SAR peak location (mm)			3D distance (mm)	Summed SAR (W/kg)	SPLSR Results	Simultaneous SAR
					X	Y	Z				
	LTE Band 71	Back	0.699	5	-4.2	-70.3	-2.33	123.1	1.89	0.02	Not required
	WLAN5GHz		1.195	5	-25.2	51	-2.33				

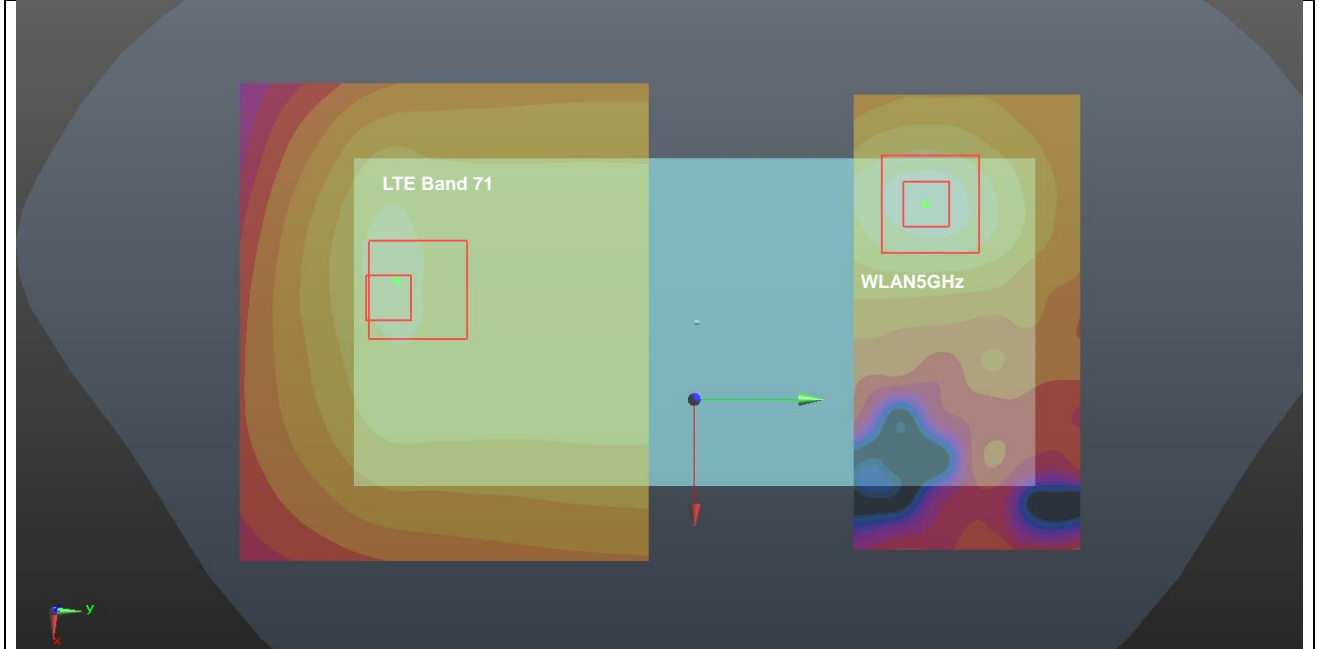

Case #31	Band	Position	SAR (W/kg)	Gap (mm)	SAR peak location (mm)			3D distance (mm)	Summed SAR (W/kg)	SPLSR Results	Simultaneous SAR
					X	Y	Z				
	LTE Band 12	Back	0.924	5	-2.7	-65	-2.71	133.9	2.01	0.02	Not required
	WLAN2.4GHz		1.086	5	-28.2	66.4	-2.19				

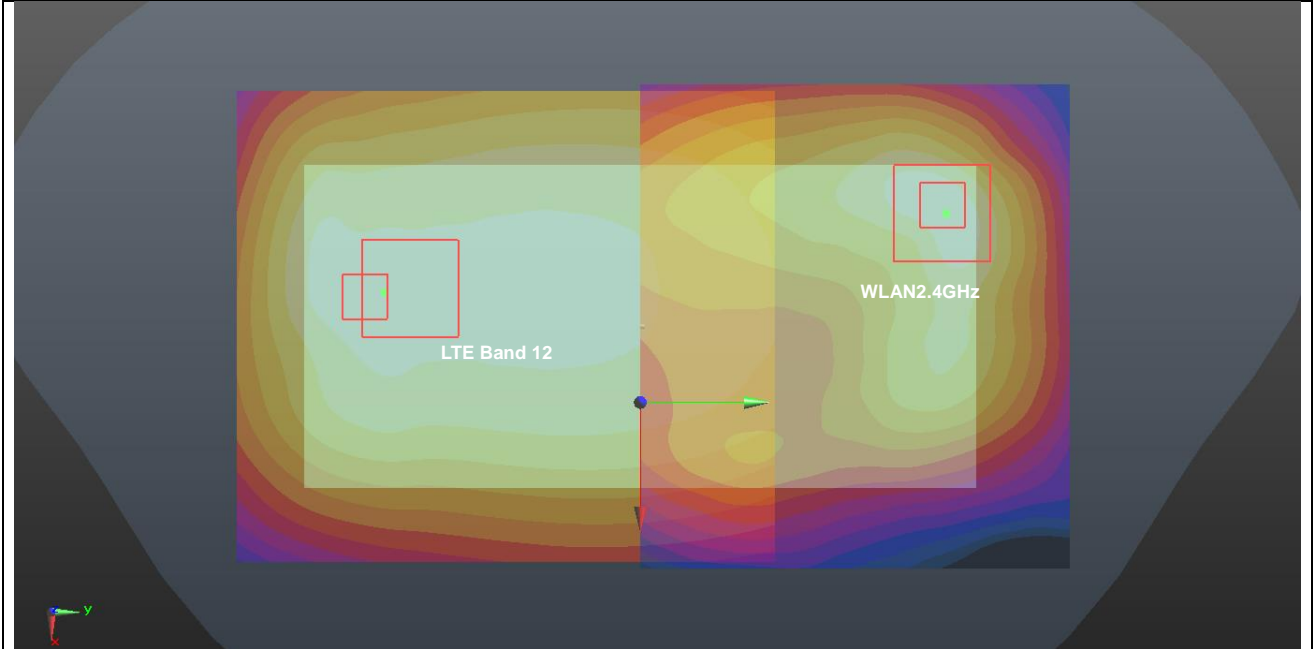

Case #32	Band	Position	SAR (W/kg)	Gap (mm)	SAR peak location (mm)			3D distance (mm)	Summed SAR (W/kg)	SPLSR Results	Simultaneous SAR
					X	Y	Z				
	LTE Band 12	Back	0.924	5	-2.7	-65	-2.71	118.2	2.12	0.03	Not required
	WLAN5GHz		1.195	5	-25.2	51	-2.33				

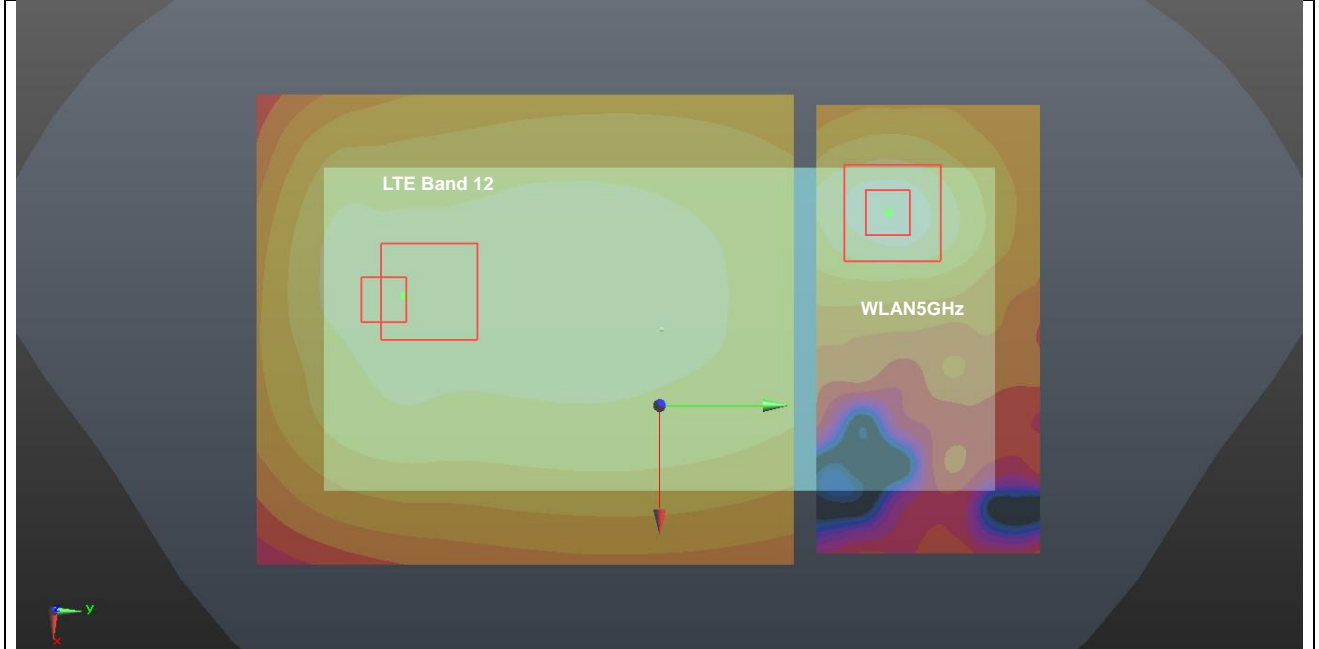

Case #33	Band	Position	SAR (W/kg)	Gap (mm)	SAR peak location (mm)			3D distance (mm)	Summed SAR (W/kg)	SPLSR Results	Simultaneous SAR
					X	Y	Z				
	LTE Band 13	Back	0.951	5	-4.1	-64.3	-2.74	132.9	2.04	0.02	Not required
	WLAN2.4GHz		1.086	5	-28.2	66.4	-2.19				

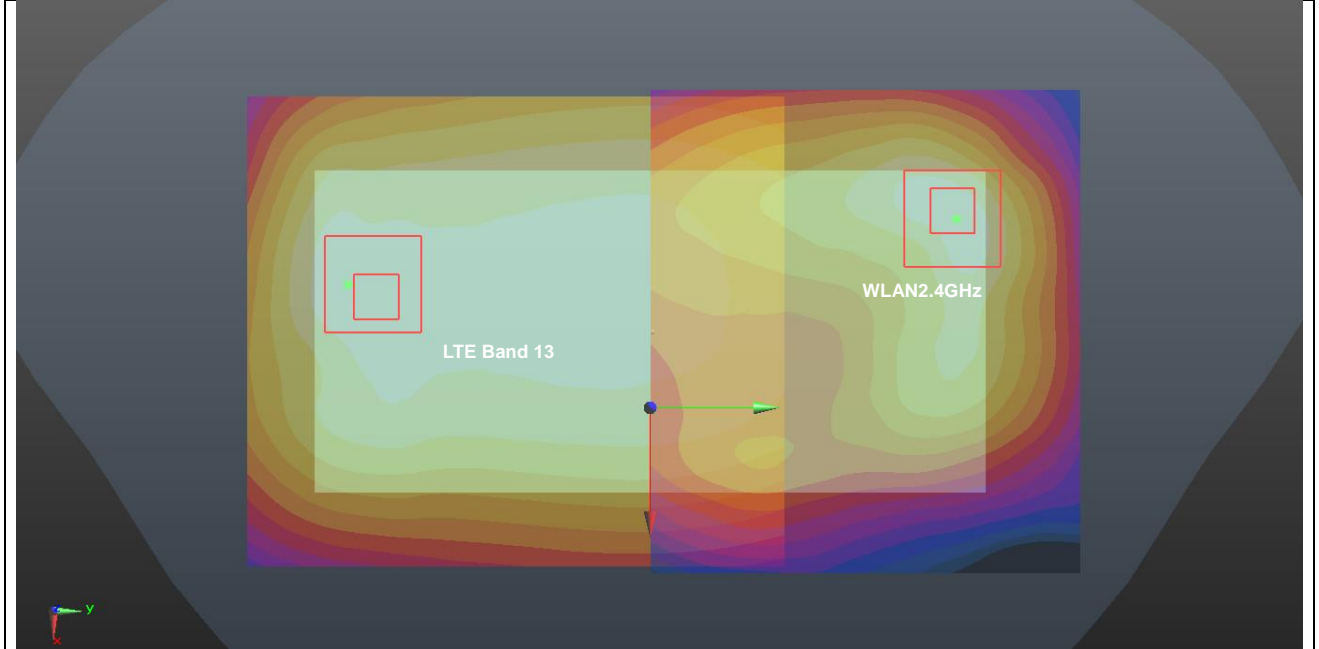

Case #34	Band	Position	SAR (W/kg)	Gap (mm)	SAR peak location (mm)			3D distance (mm)	Summed SAR (W/kg)	SPLSR Results	Simultaneous SAR
					X	Y	Z				
	LTE Band 13	Back	0.951	5	-4.1	-64.3	-2.74	117.2	2.15	0.03	Not required
	WLAN5GHz		1.195	5	-25.2	51	-2.33				

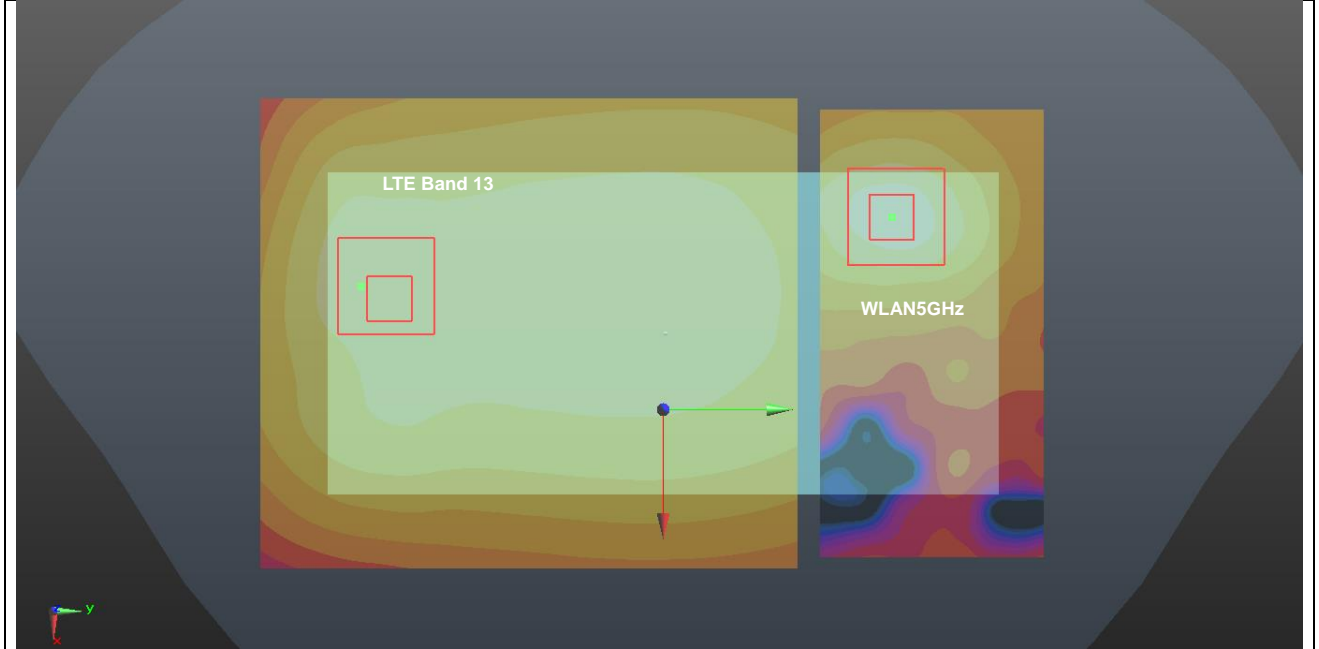

Case #36	Band	Position	SAR (W/kg)	Gap (mm)	SAR peak location (mm)			3D distance (mm)	Summed SAR (W/kg)	SPLSR Results	Simultaneous SAR
					X	Y	Z				
	LTE Band 26	Back	0.967	5	-2.7	-64.8	-2.71	133.7	2.05	0.02	Not required
	WLAN2.4GHz		1.086	5	-28.2	66.4	-2.19				

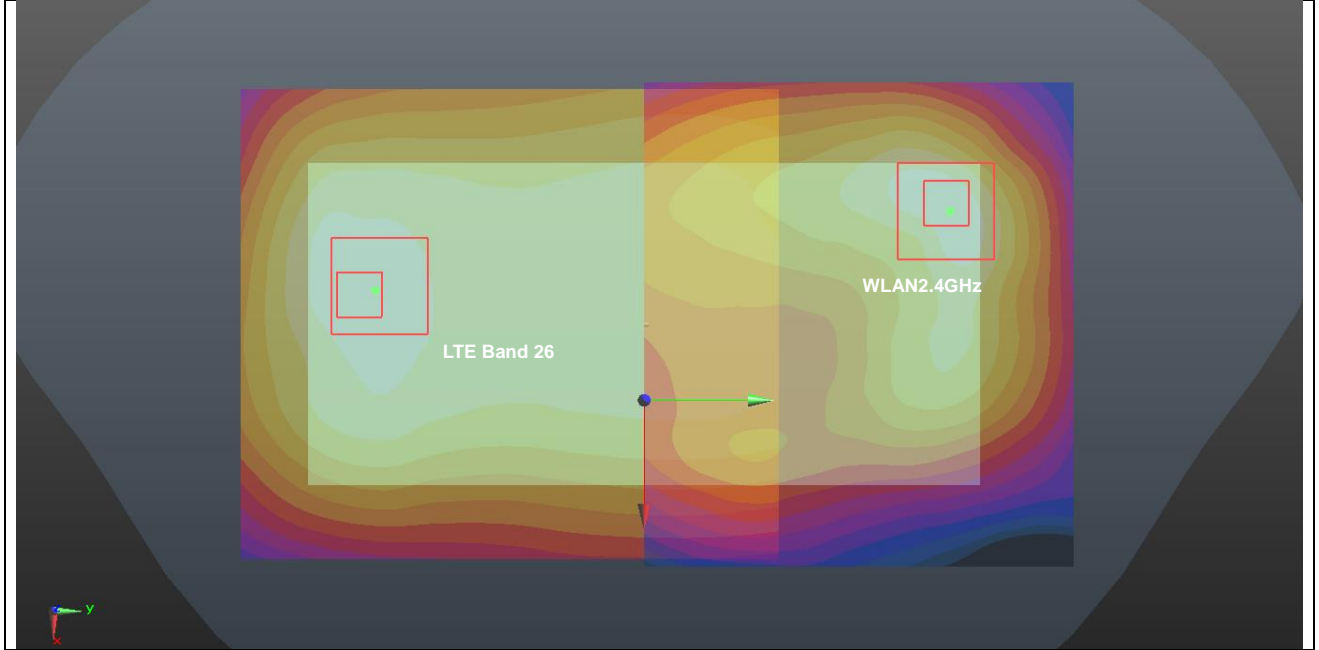

Case #37	Band	Position	SAR (W/kg)	Gap (mm)	SAR peak location (mm)			3D distance (mm)	Summed SAR (W/kg)	SPLSR Results	Simultaneous SAR
					X	Y	Z				
	LTE Band 26	Back	0.967	5	-2.7	-64.8	-2.71	118.0	2.16	0.03	Not required
	WLAN5GHz		1.195	5	-25.2	51	-2.33				

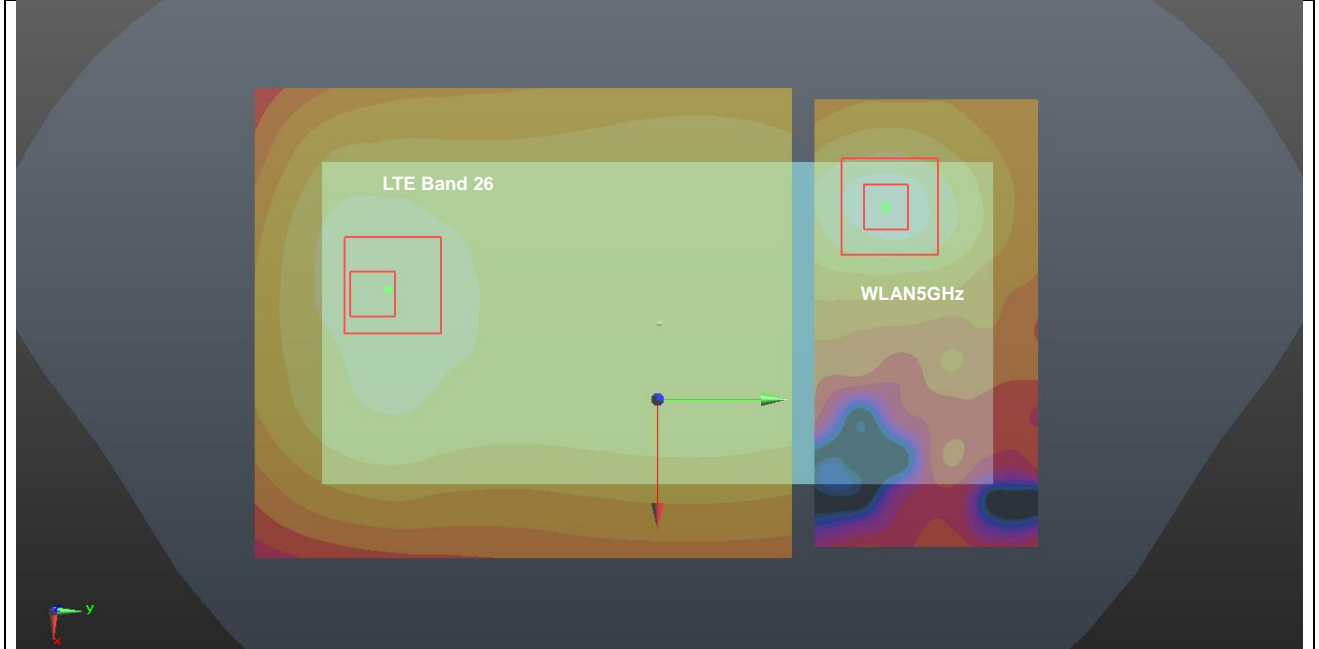

Case #38	Band	Position	SAR (W/kg)	Gap (mm)	SAR peak location (mm)			3D distance (mm)	Summed SAR (W/kg)	SPLSR Results	Simultaneous SAR
					X	Y	Z				
	LTE Band 66	Back	1.35	5	-12.7	-77.4	-3.29	144.6	2.44	0.03	Not required
	WLAN2.4GHz		1.086	5	-28.2	66.4	-2.19				

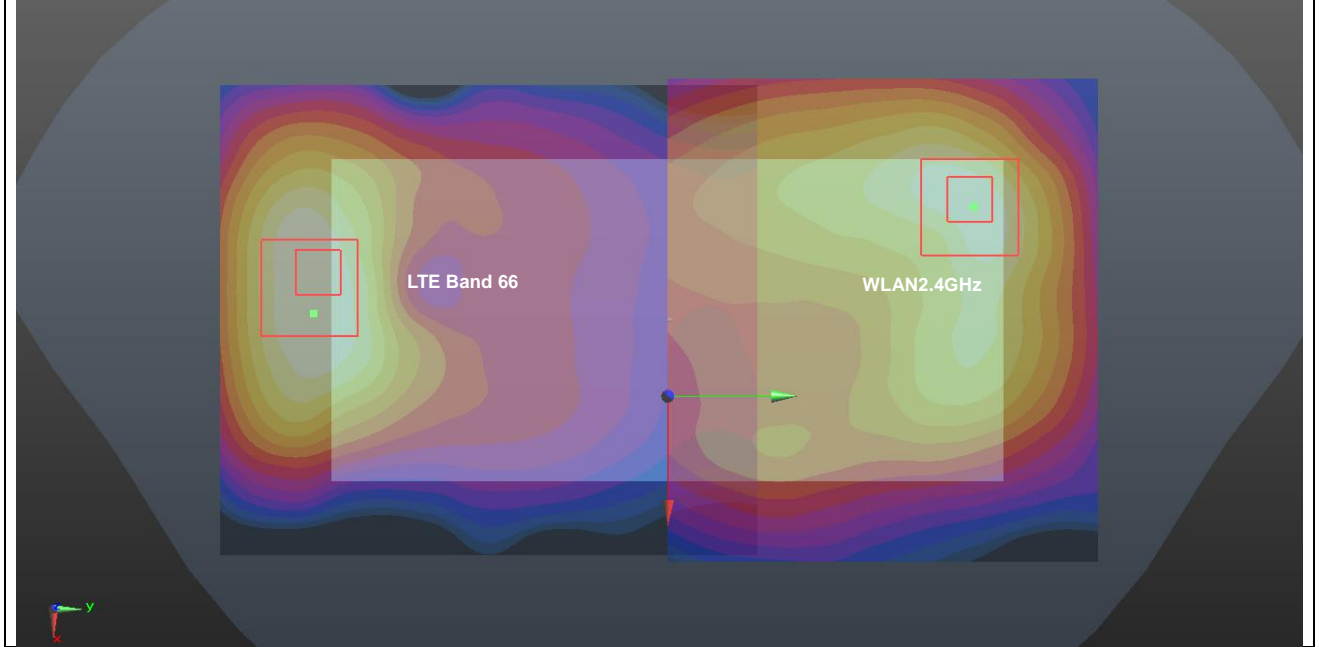

Case #39	Band	Position	SAR (W/kg)	Gap (mm)	SAR peak location (mm)			3D distance (mm)	Summed SAR (W/kg)	SPLSR Results	Simultaneous SAR
					X	Y	Z				
	LTE Band 66	Back	1.35	5	-12.7	-77.4	-3.29	129.0	2.55	0.03	Not required
	WLAN5GHz		1.195	5	-25.2	51	-2.33				

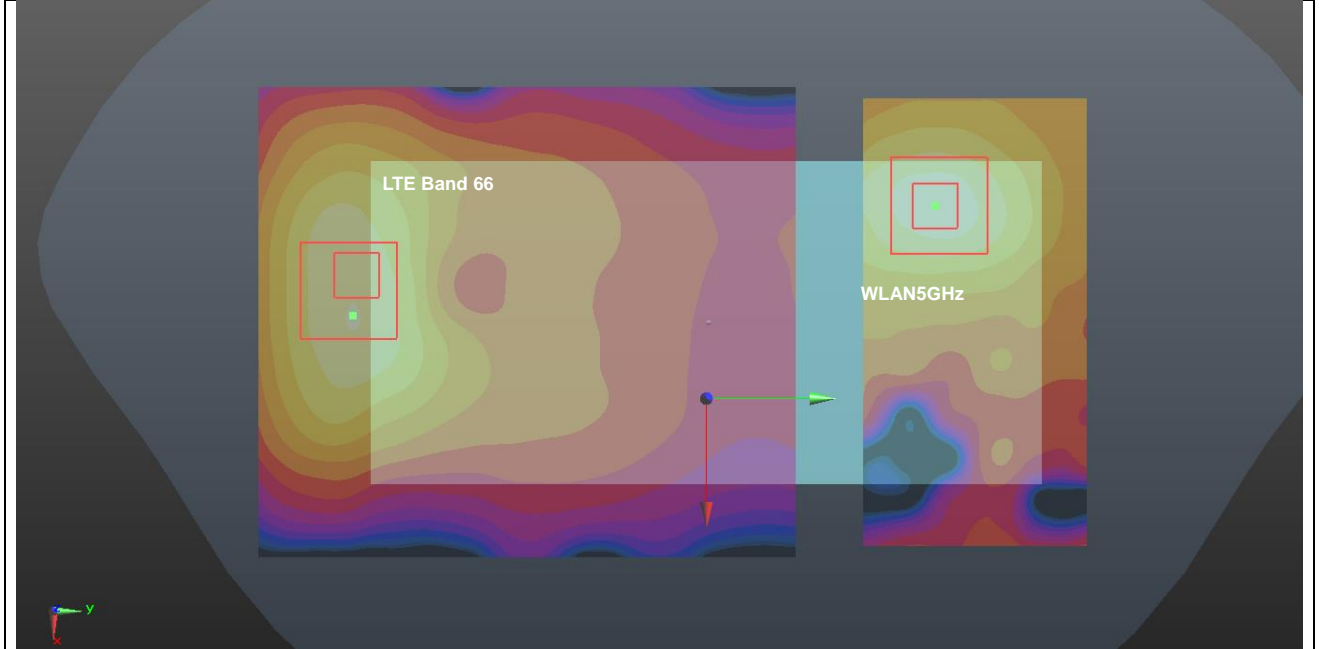

Case #40	Band	Position	SAR (W/kg)	Gap (mm)	SAR peak location (mm)			3D distance (mm)	Summed SAR (W/kg)	SPLSR Results	Simultaneous SAR
					X	Y	Z				
	LTE Band 25	Back	1.256	5	-22.6	-73.5	-2.45	140.0	2.34	0.03	Not required
	WLAN2.4GHz		1.086	5	-28.2	66.4	-2.19				

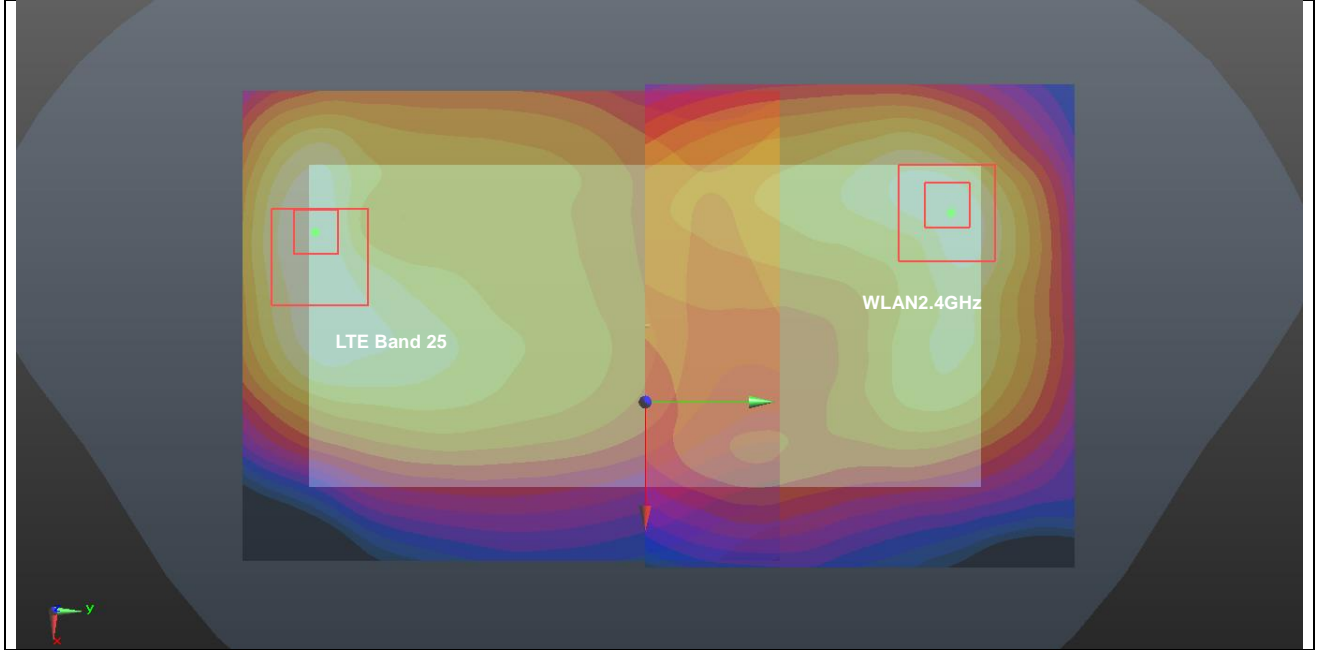

Case #41	Band	Position	SAR (W/kg)	Gap (mm)	SAR peak location (mm)			3D distance (mm)	Summed SAR (W/kg)	SPLSR Results	Simultaneous SAR
					X	Y	Z				
	LTE Band 25	Back	1.256	5	-22.6	-73.5	-2.45	124.5	2.45	0.03	Not required
	WLAN5GHz		1.195	5	-25.2	51	-2.33				

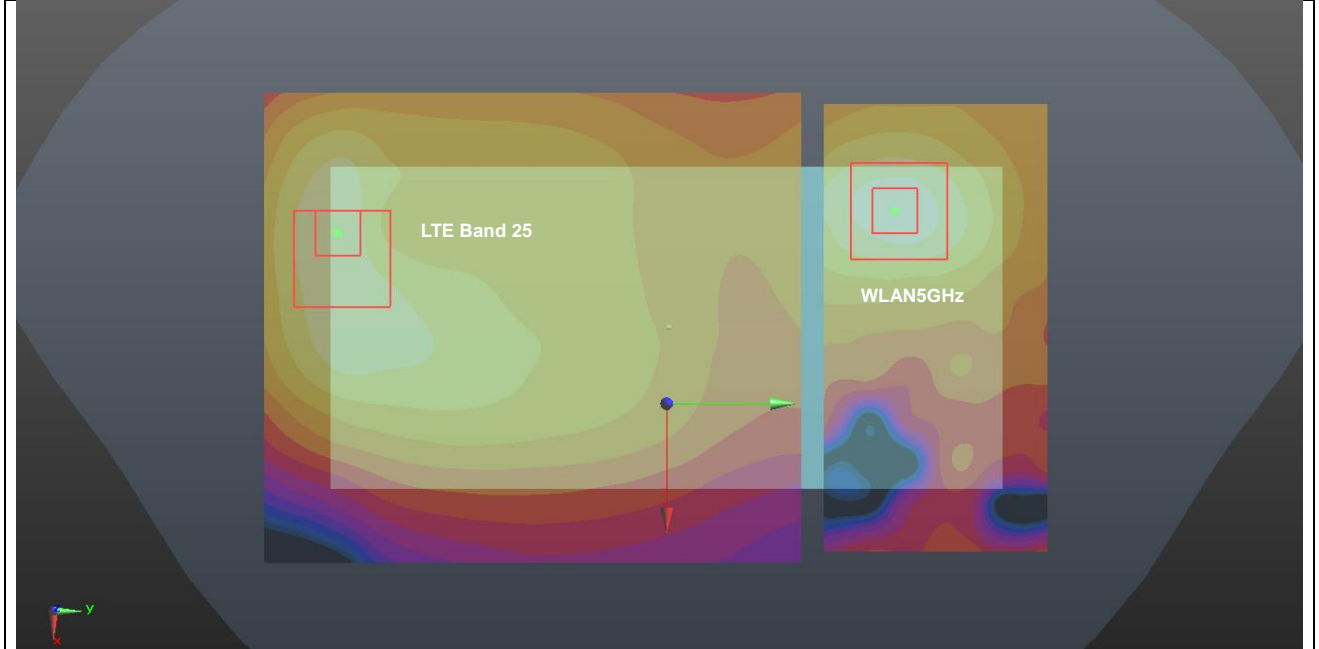

Case #42	Band	Position	SAR (W/kg)	Gap (mm)	SAR peak location (mm)			3D distance (mm)	Summed SAR (W/kg)	SPLSR Results	Simultaneous SAR
					X	Y	Z				
	LTE Band 41	Back	1.403	5	19.8	-69	-2.29	143.7	2.49	0.03	Not required
	WLAN2.4GHz		1.086	5	-28.2	66.4	-2.19				

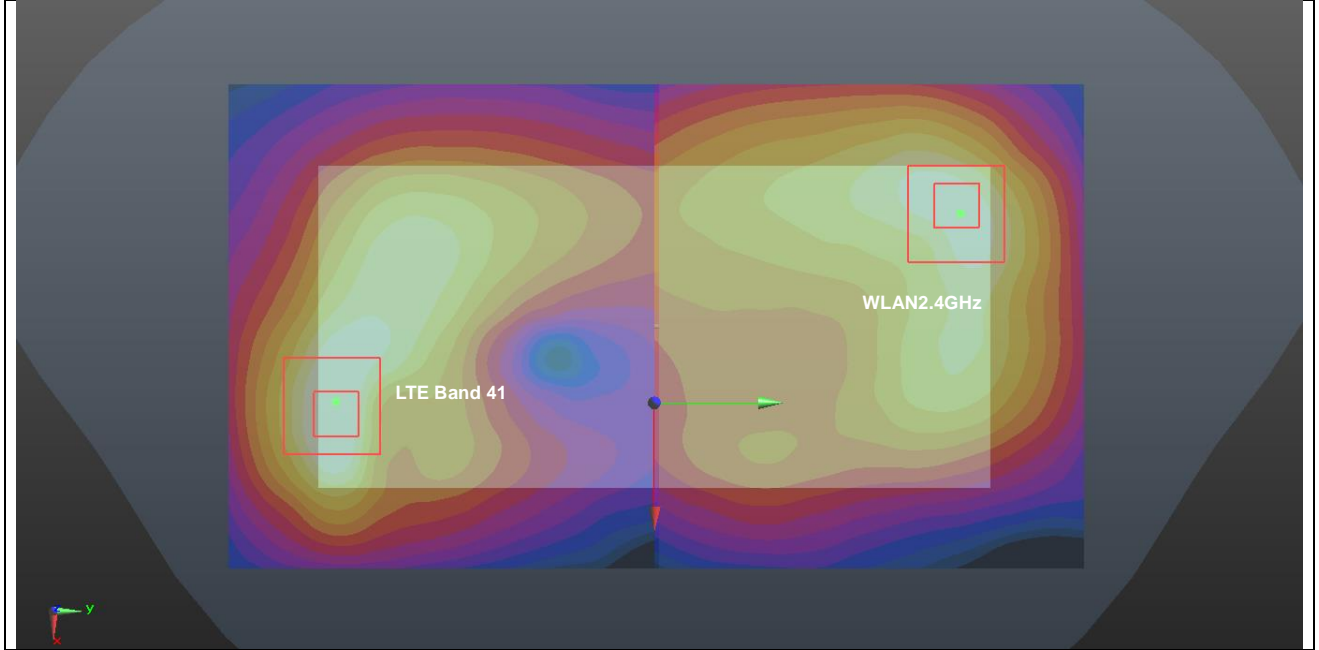

Case #43	Band	Position	SAR (W/kg)	Gap (mm)	SAR peak location (mm)			3D distance (mm)	Summed SAR (W/kg)	SPLSR Results	Simultaneous SAR
					X	Y	Z				
	LTE Band 41	Back	1.403	5	19.8	-69	-2.29	128.2	2.60	0.03	Not required
	WLAN5GHz		1.195	5	-25.2	51	-2.33				

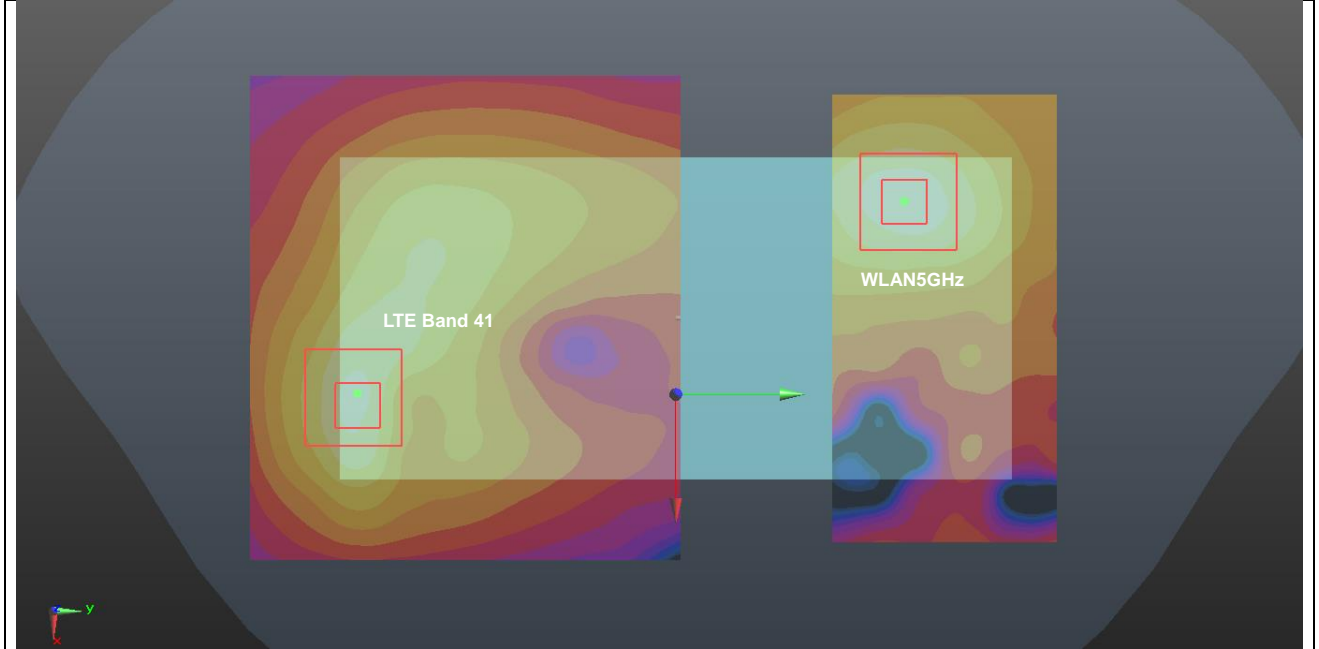

Case #44	Band	Position	SAR (W/kg)	Gap (mm)	SAR peak location (mm)			3D distance (mm)	Summed SAR (W/kg)	SPLSR Results	Simultaneous SAR
					X	Y	Z				
	LTE Band 41	Back	1.403	5	19.8	-69	-2.29	141.3	1.62	0.01	Not required
	Bluetooth		0.214	5	-26.8	64.4	-2.13				

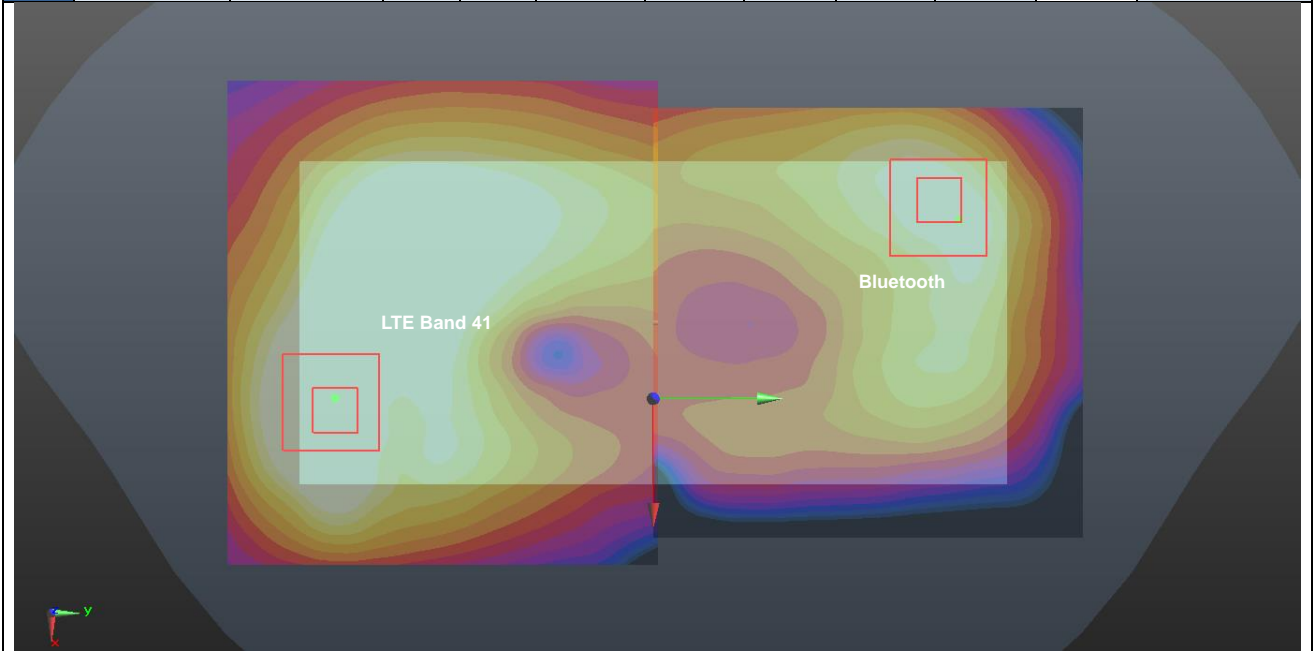

Case #45	Band	Position	SAR (W/kg)	Gap (mm)	SAR peak location (mm)			3D distance (mm)	Summed SAR (W/kg)	SPLSR Results	Simultaneous SAR
					X	Y	Z				
	CDMA2000 BC0	Back	1.26	5	-5.5	-67.5	-2.39	135.8	2.35	0.03	Not required
	WLAN2.4GHz		1.086	5	-28.2	66.4	-2.19				

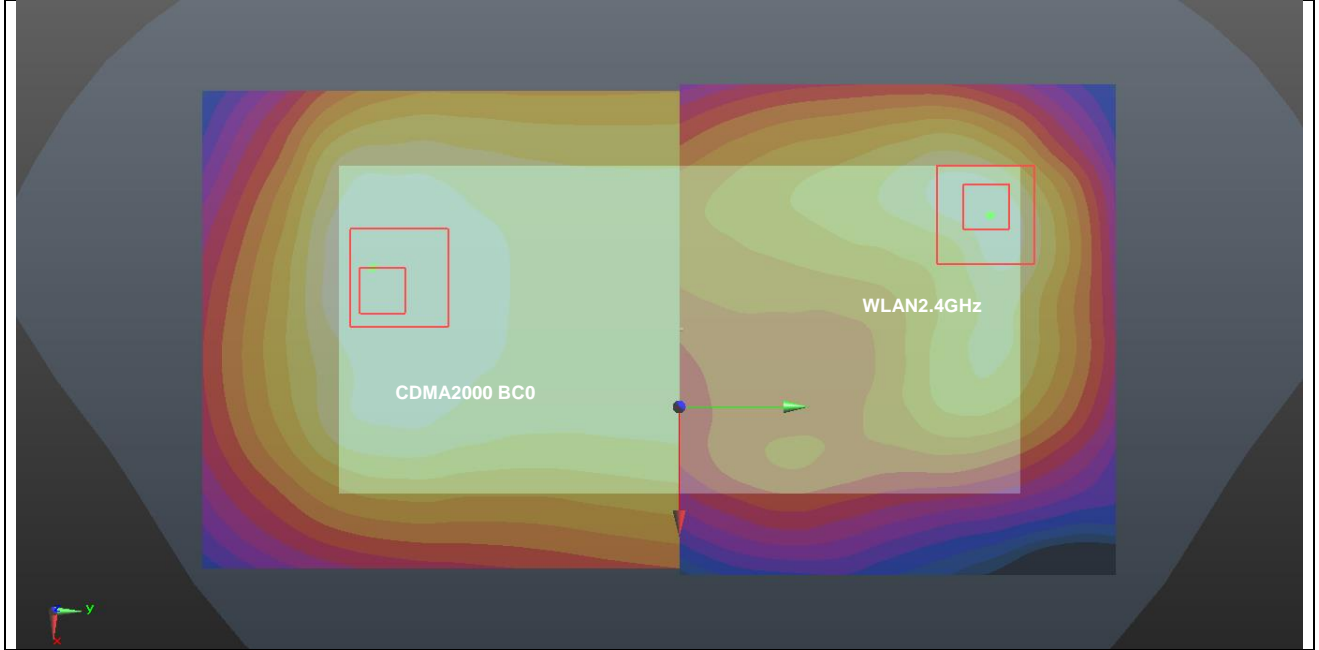

Case #46	Band	Position	SAR (W/kg)	Gap (mm)	SAR peak location (mm)			3D distance (mm)	Summed SAR (W/kg)	SPLSR Results	Simultaneous SAR
					X	Y	Z				
	CDMA2000 BC0	Back	1.26	5	-5.5	-67.5	-2.39	120.1	2.46	0.03	Not required
	WLAN5GHz		1.195	5	-25.2	51	-2.33				

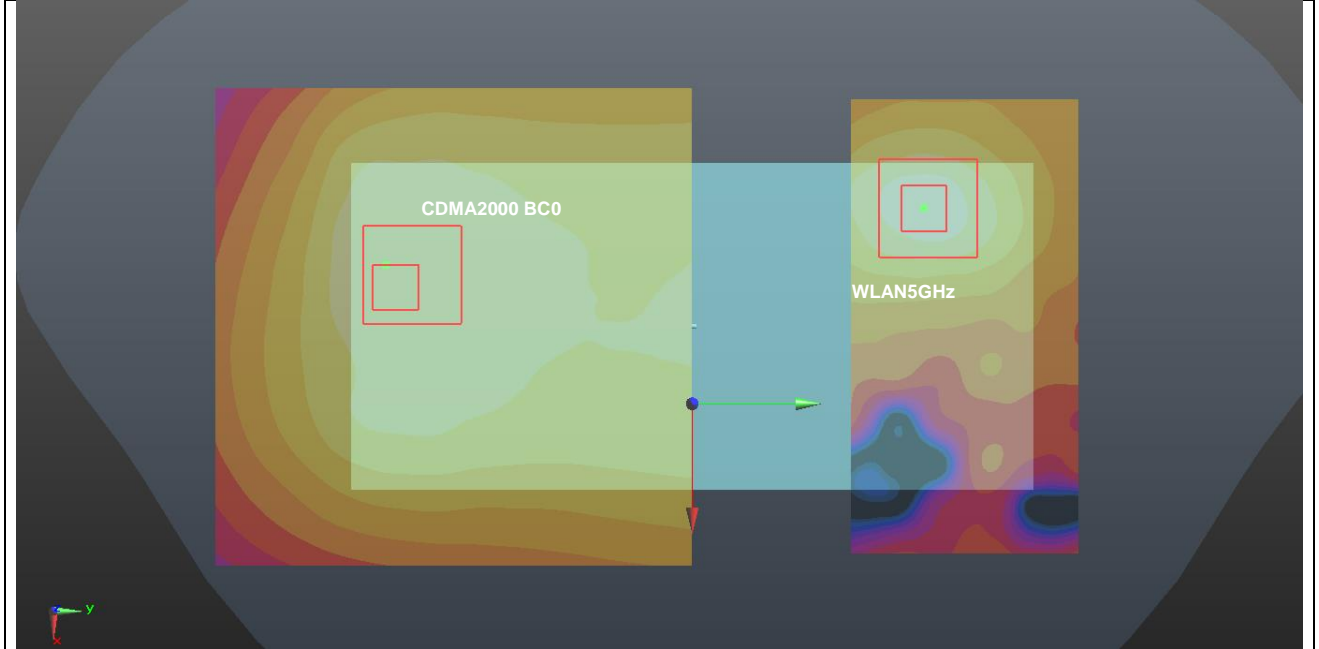

Case #47	Band	Position	SAR (W/kg)	Gap (mm)	SAR peak location (mm)			3D distance (mm)	Summed SAR (W/kg)	SPLSR Results	Simultaneous SAR
					X	Y	Z				
	CDMA2000 BC10	Back	1.217	5	-4.1	-67.5	-2.43	136.1	2.30	0.03	Not required
	WLAN2.4GHz		1.086	5	-28.2	66.4	-2.19				

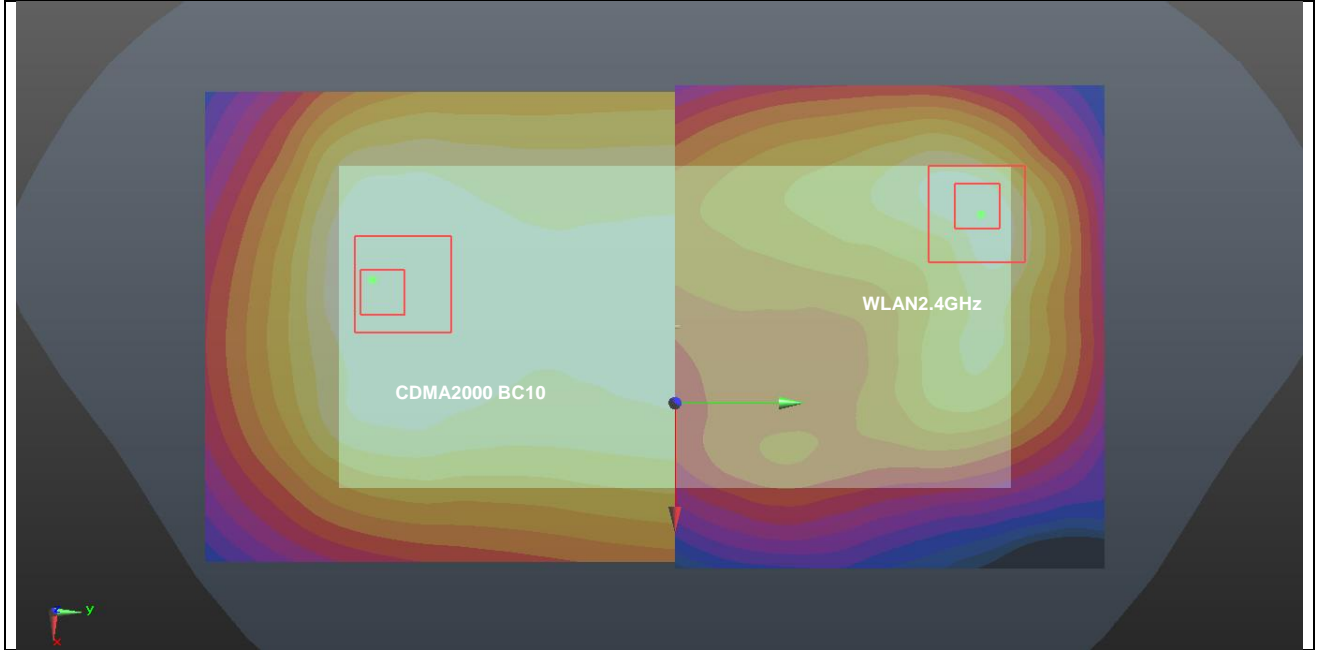

Case #48	Band	Position	SAR (W/kg)	Gap (mm)	SAR peak location (mm)			3D distance (mm)	Summed SAR (W/kg)	SPLSR Results	Simultaneous SAR
					X	Y	Z				
	CDMA2000 BC10	Back	1.217	5	-4.1	-67.5	-2.43	120.4	2.41	0.03	Not required
	WLAN5GHz		1.195	5	-25.2	51	-2.33				

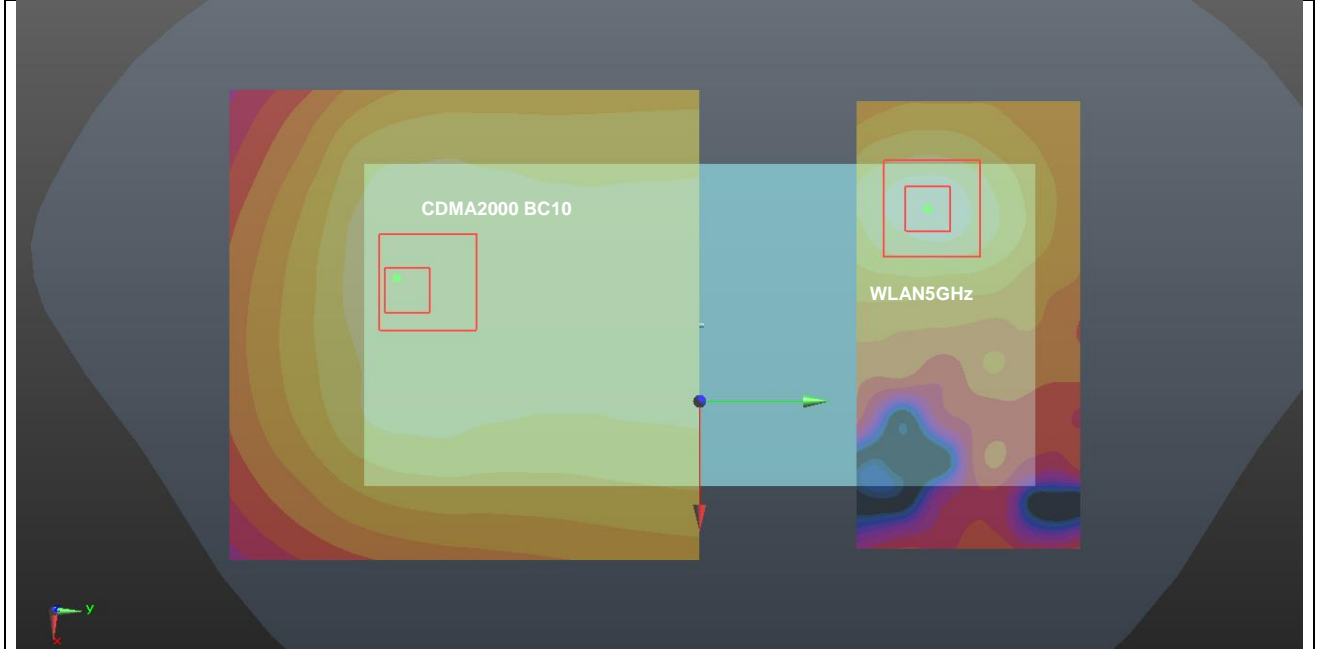

Case #49	Band	Position	SAR (W/kg)	Gap (mm)	SAR peak location (mm)			3D distance (mm)	Summed SAR (W/kg)	SPLSR Results	Simultaneous SAR
					X	Y	Z				
	CDMA2000 BC1	Front	1.231	5	-22.5	-72	-0.72	123.0	1.80	0.02	Not required
	WLAN2.4GHz		0.572	5	-25.2	51	-2.33				

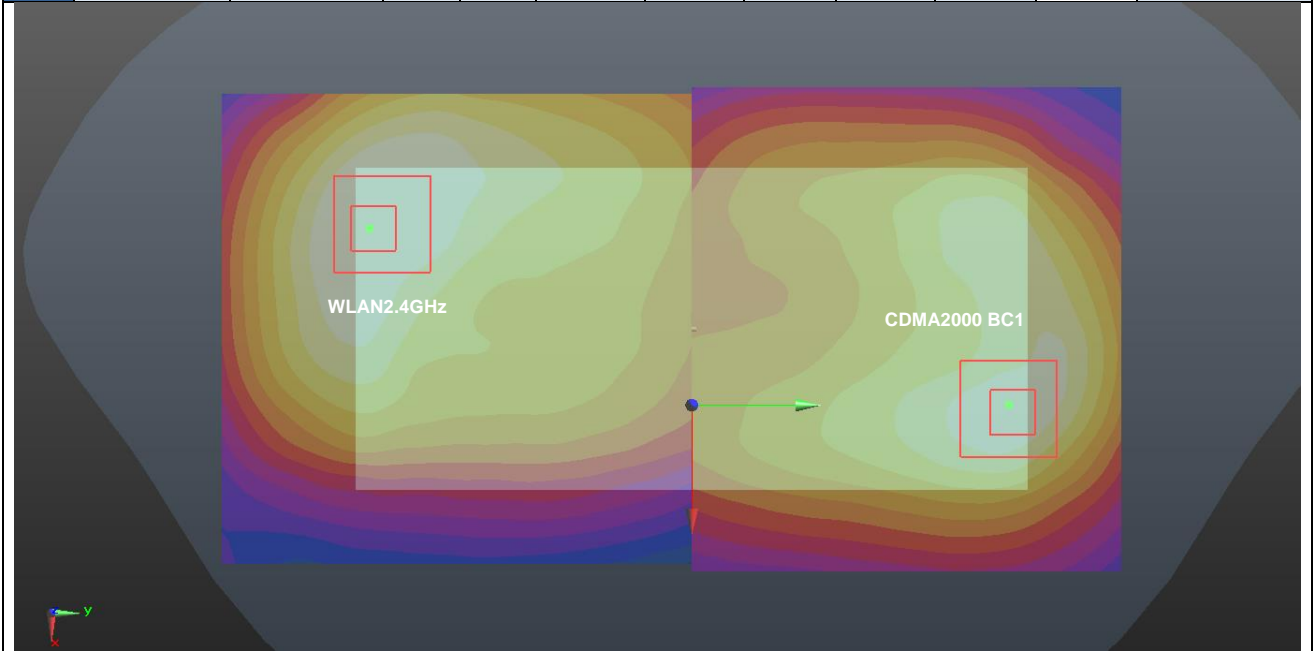

Case #50	Band	Position	SAR (W/kg)	Gap (mm)	SAR peak location (mm)			3D distance (mm)	Summed SAR (W/kg)	SPLSR Results	Simultaneous SAR
					X	Y	Z				
	CDMA2000 BC1	Back	1.287	5	-2.7	-73.6	-0.65	142.3	2.37	0.03	Not required
	WLAN2.4GHz		1.086	5	-28.2	66.4	-2.19				

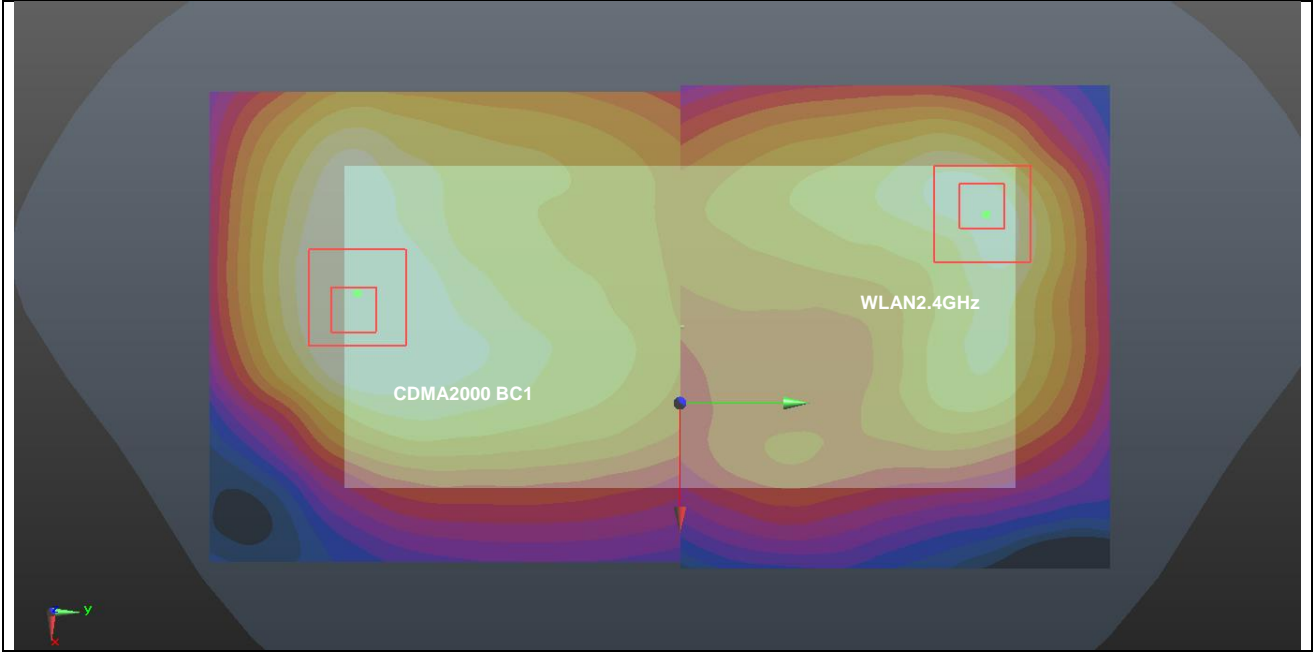

Case #51	Band	Position	SAR (W/kg)	Gap (mm)	SAR peak location (mm)			3D distance (mm)	Summed SAR (W/kg)	SPLSR Results	Simultaneous SAR
					X	Y	Z				
	CDMA2000 BC1	Back	1.287	5	-2.7	-73.6	-0.65	126.6	2.48	0.03	Not required
	WLAN5GHz		1.195	5	-25.2	51	-2.33				

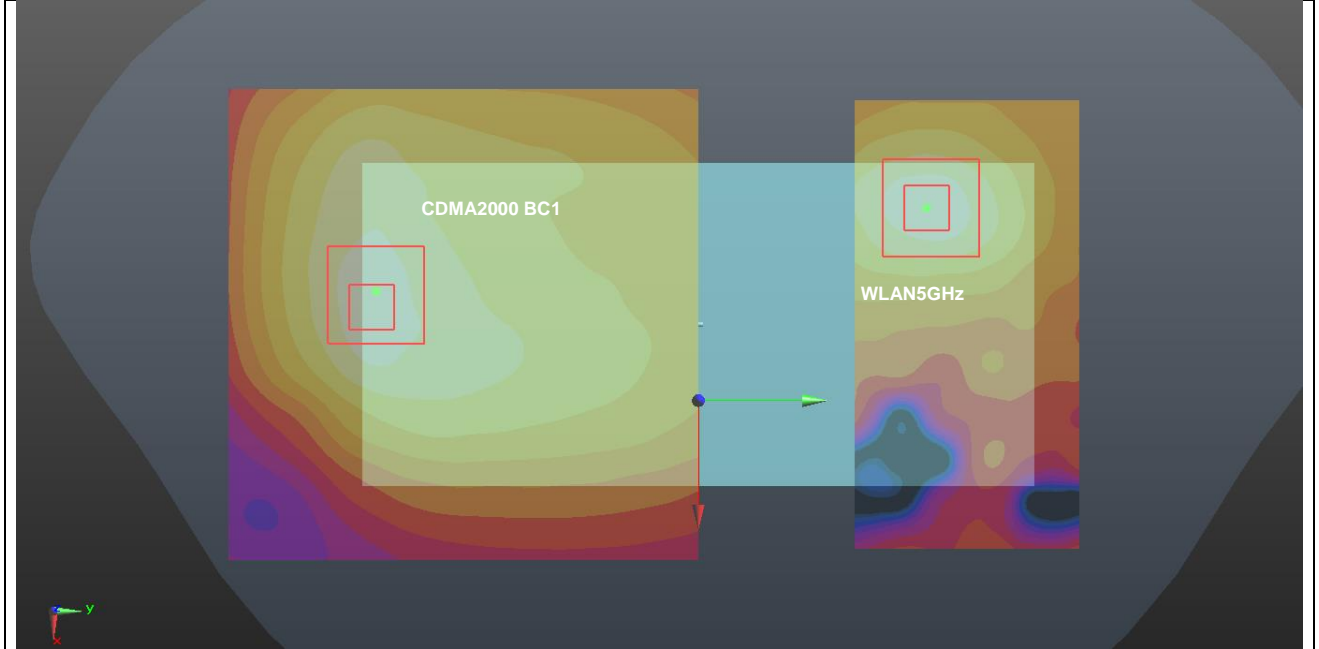

Test Engineer: Nick Hu



17. Uncertainty Assessment

Per KDB 865664 D01 SAR measurement 100MHz to 6GHz, when the highest measured 1-g SAR within a frequency band is < 1.5 W/kg and the measured 10-g SAR within a frequency band is < 3.75 W/kg. The expanded SAR measurement uncertainty must be $\leq 30\%$, for a confidence interval of $k = 2$. If these conditions are met, extensive SAR measurement uncertainty analysis described in IEEE Std 1528-2013 is not required in SAR reports submitted for equipment approval. For this device, the highest measured 1-g SAR is less 1.5W/kg and highest measured 10-g SAR is less 3.75W/kg. Therefore, the measurement uncertainty table is not required in this report.



18. References

- [1] FCC 47 CFR Part 2 “Frequency Allocations and Radio Treaty Matters; General Rules and Regulations”
- [2] ANSI/IEEE Std. C95.1-1992, “IEEE Standard for Safety Levels with Respect to Human Exposure to Radio Frequency Electromagnetic Fields, 3 kHz to 300 GHz”, September 1992
- [3] IEEE Std. 1528-2013, “IEEE Recommended Practice for Determining the Peak Spatial-Average Specific Absorption Rate (SAR) in the Human Head from Wireless Communications Devices: Measurement Techniques”, Sep 2013
- [4] SPEAG DASYS System Handbook
- [5] FCC KDB 865664 D01 v01r04, "SAR Measurement Requirements for 100 MHz to 6 GHz", Aug 2015.
- [6] FCC KDB 865664 D02 v01r02, “RF Exposure Compliance Reporting and Documentation Considerations” Oct 2015.
- [7] FCC KDB 447498 D01 v06, “Mobile and Portable Device RF Exposure Procedures and Equipment Authorization Policies”, Oct 2015
- [8] FCC KDB 648474 D04 v01r03, “SAR Evaluation Considerations for Wireless Handsets”, Oct 2015.
- [9] FCC KDB 248227 D01 v02r02, “SAR Guidance for IEEE 802.11 (WiFi) Transmitters”, Oct 2015.
- [10] FCC KDB 616217 D04 v01r02, “SAR Evaluation Considerations for Laptop, Notebook, Netbook and Tablet Computers”, Oct 2015
- [11] FCC KDB 941225 D01 v03r01, “3G SAR MEASUREMENT PROCEDURES”, Oct 2015
- [12] FCC KDB 941225 D05 v02r05, “SAR Evaluation Considerations for LTE Devices”, Dec 2015
- [13] FCC KDB 941225 D05A v01r02, “Rel. 10 LTE SAR Test Guidance and KDB Inquiries”, Oct 2015
- [14] FCC KDB 941225 D06 v02r01, "SAR Evaluation Procedures for Portable Devices with Wireless Router Capabilities", Oct 2015.



Appendix A. Plots of System Performance Check

The plots are shown as follows.

System Check_Head_750MHz

DUT: D750V3 - SN:1087

Communication System: UID 0, CW (0); Frequency: 750 MHz; Duty Cycle: 1:1
Medium: HSL_750 Medium parameters used: $f = 750 \text{ MHz}$; $\sigma = 0.9 \text{ S/m}$; $\epsilon_r = 41.707$; $\rho = 1000 \text{ kg/m}^3$
Ambient Temperature : $23.1 \text{ }^\circ\text{C}$; Liquid Temperature : $22.8 \text{ }^\circ\text{C}$

DASY5 Configuration:

- Probe: ES3DV3 - SN3279; ConvF(6.58, 6.58, 6.58); Calibrated: 2019.3.4
- Sensor-Surface: 3mm (Mechanical Surface Detection)
- Electronics: DAE4 Sn1279; Calibrated: 2018.10.22
- Phantom: SAM2; Type: SAM; Serial: TP-1542
- Measurement SW: DASY52, Version 52.10 (1); SEMCAD X Version 14.6.11 (7439)

Pin=250mW/Area Scan (61x61x1): Interpolated grid: $dx=1.500 \text{ mm}$, $dy=1.500 \text{ mm}$
Maximum value of SAR (interpolated) = 2.44 W/kg

Pin=250mW/Zoom Scan (5x5x7)/Cube 0: Measurement grid: $dx=8\text{mm}$, $dy=8\text{mm}$, $dz=5\text{mm}$
Reference Value = 46.25 V/m ; Power Drift = 0.04 dB
Peak SAR (extrapolated) = 2.94 W/kg
SAR(1 g) = 2.01 W/kg ; SAR(10 g) = 1.35 W/kg
Maximum value of SAR (measured) = 2.45 W/kg

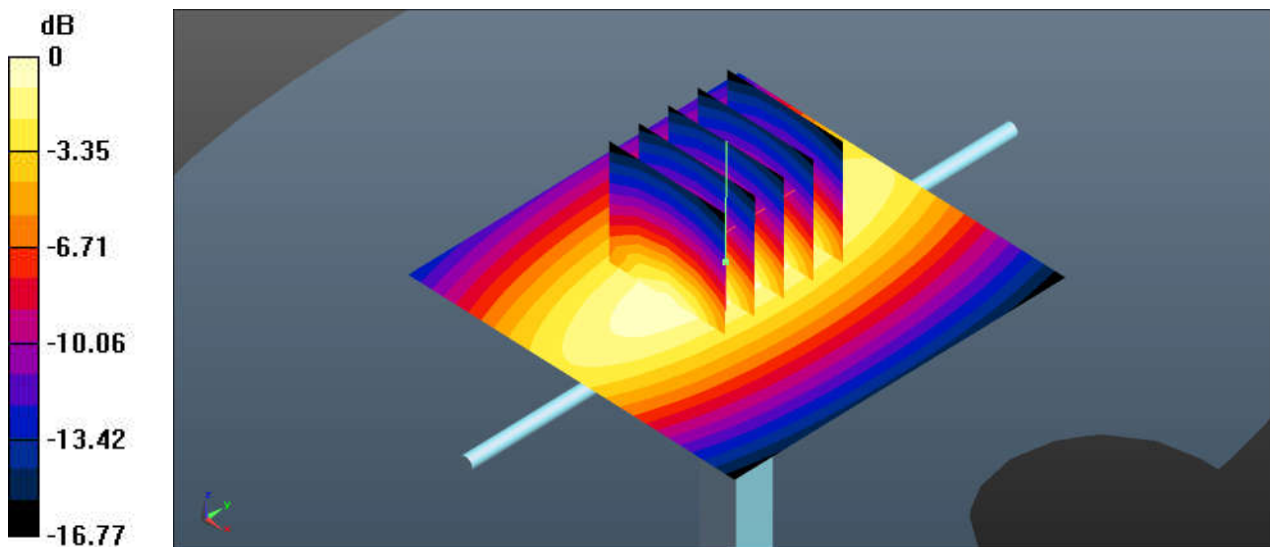

0 dB = $2.44 \text{ W/kg} = 3.87 \text{ dBW/kg}$

System Check_Head_835MHz

DUT: D835V2 - SN:4d151

Communication System: UID 0, CW (0); Frequency: 835 MHz; Duty Cycle: 1:1
Medium: HSL_850 Medium parameters used: $f = 835 \text{ MHz}$; $\sigma = 0.902 \text{ S/m}$; $\epsilon_r = 41.778$; $\rho = 1000 \text{ kg/m}^3$
Ambient Temperature : $23.2 \text{ }^\circ\text{C}$; Liquid Temperature : $22.7 \text{ }^\circ\text{C}$

DASY5 Configuration:

- Probe: ES3DV3 - SN3279; ConvF(6.38, 6.38, 6.38); Calibrated: 2019.3.4
- Sensor-Surface: 3mm (Mechanical Surface Detection)
- Electronics: DAE4 Sn1279; Calibrated: 2018.10.22
- Phantom: SAM2; Type: SAM; Serial: TP-1542
- Measurement SW: DASY52, Version 52.10 (1); SEMCAD X Version 14.6.11 (7439)

Pin=250mW/Area Scan (61x61x1): Interpolated grid: $dx=1.500 \text{ mm}$, $dy=1.500 \text{ mm}$
Maximum value of SAR (interpolated) = 4.72 W/kg

Pin=250mW/Zoom Scan (5x5x7)/Cube 0: Measurement grid: $dx=8\text{mm}$, $dy=8\text{mm}$, $dz=5\text{mm}$
Reference Value = 66.70 V/m ; Power Drift = -0.05 dB
Peak SAR (extrapolated) = 5.92 W/kg
SAR(1 g) = 2.43 W/kg ; SAR(10 g) = 1.44 W/kg
Maximum value of SAR (measured) = 4.74 W/kg

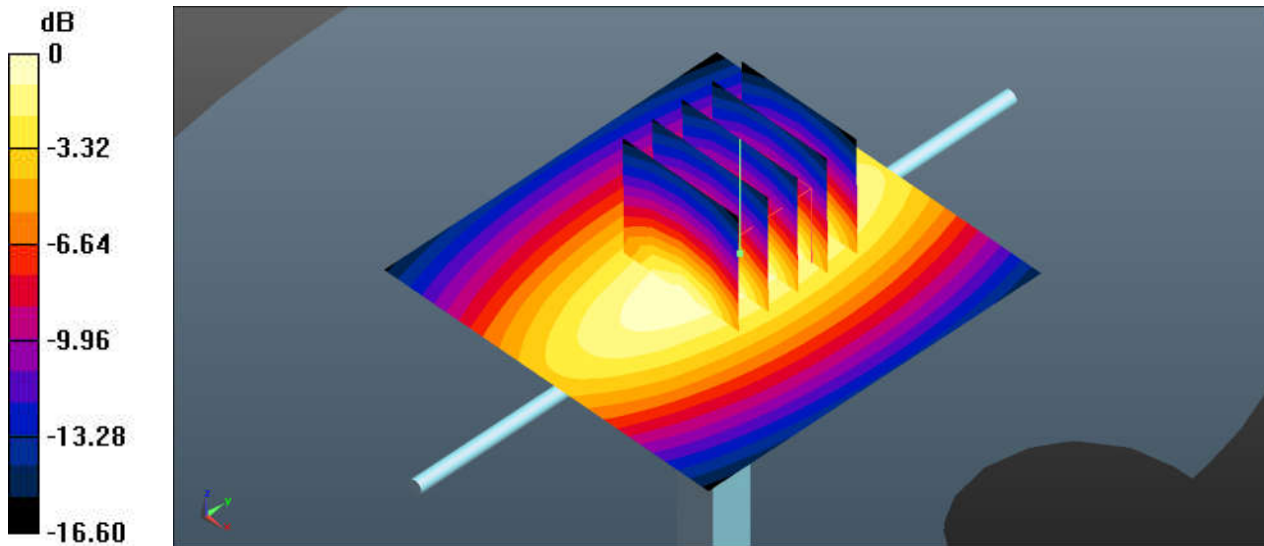

0 dB = $4.72 \text{ W/kg} = 6.74 \text{ dBW/kg}$

System Check_Head_1750MHz

DUT: D1750V2 - SN:1090

Communication System: UID 0, CW; Frequency: 1750 MHz; Duty Cycle: 1:1
Medium: HSL_1750 Medium parameters used: $f = 1750$ MHz; $\sigma = 1.351$ S/m; $\epsilon_r = 40.495$; $\rho = 1000$ kg/m³
Ambient Temperature : 23.3 °C; Liquid Temperature : 22.8 °C

DASY5 Configuration:

- Probe: ES3DV3 - SN3279; ConvF(5.59, 5.59, 5.59); Calibrated: 2019.3.4
- Sensor-Surface: 3mm (Mechanical Surface Detection)
- Electronics: DAE4 Sn1279; Calibrated: 2018.10.22
- Phantom: SAM2; Type: SAM; Serial: TP-1542
- Measurement SW: DASY52, Version 52.10 (1); SEMCAD X Version 14.6.11 (7439)

Pin=250mW/Area Scan (61x61x1): Interpolated grid: dx=1.500 mm, dy=1.500 mm

Maximum value of SAR (interpolated) = 25.8 W/kg

Pin=250mW/Zoom Scan (5x5x7)/Cube 0: Measurement grid: dx=8mm, dy=8mm, dz=5mm

Reference Value = 129.7 V/m; Power Drift = -0.06 dB

Peak SAR (extrapolated) = 30.9 W/kg

SAR(1 g) = 9.32 W/kg; SAR(10 g) = 4.62 W/kg

Maximum value of SAR (measured) = 26.0 W/kg

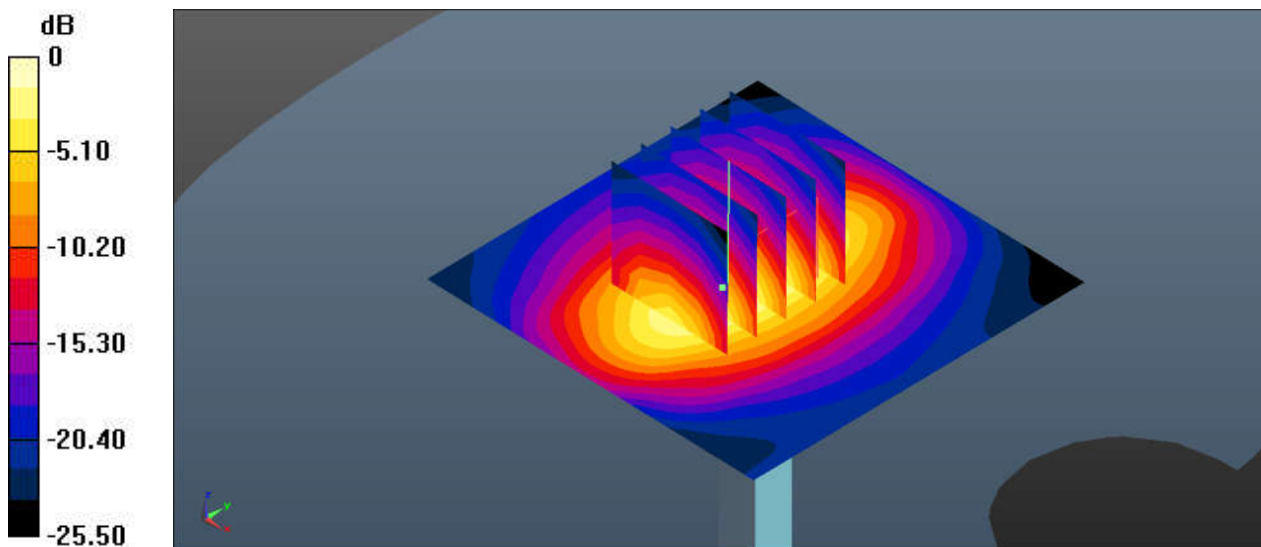

0 dB = 25.8 W/kg = 14.12 dBW/kg

System Check_Head_1900MHz

DUT: D1900V2 - SN:5d170

Communication System: UID 0, CW (0); Frequency: 1900 MHz; Duty Cycle: 1:1
Medium: HSL_1900 Medium parameters used: $f = 1900$ MHz; $\sigma = 1.427$ S/m; $\epsilon_r = 38.73$; $\rho = 1000$ kg/m³
Ambient Temperature : 23.2 °C ; Liquid Temperature : 22.9 °C

DASY5 Configuration:

- Probe: ES3DV3 - SN3279; ConvF(5.35, 5.35, 5.35); Calibrated: 2019.3.4
- Sensor-Surface: 3mm (Mechanical Surface Detection)
- Electronics: DAE4 Sn1279; Calibrated: 2018.10.22
- Phantom: SAM2; Type: SAM; Serial: TP-1542
- Measurement SW: DASY52, Version 52.10 (1); SEMCAD X Version 14.6.11 (7439)

Pin=250mW/Area Scan (61x61x1): Interpolated grid: dx=1.500 mm, dy=1.500 mm
Maximum value of SAR (interpolated) = 31.0 W/kg

Pin=250mW/Zoom Scan (5x5x7)/Cube 0: Measurement grid: dx=8mm, dy=8mm, dz=5mm
Reference Value = 140.4 V/m; Power Drift = -0.05 dB
Peak SAR (extrapolated) = 37.4 W/kg
SAR(1 g) = 9.9 W/kg; SAR(10 g) = 5.22 W/kg
Maximum value of SAR (measured) = 31.3 W/kg

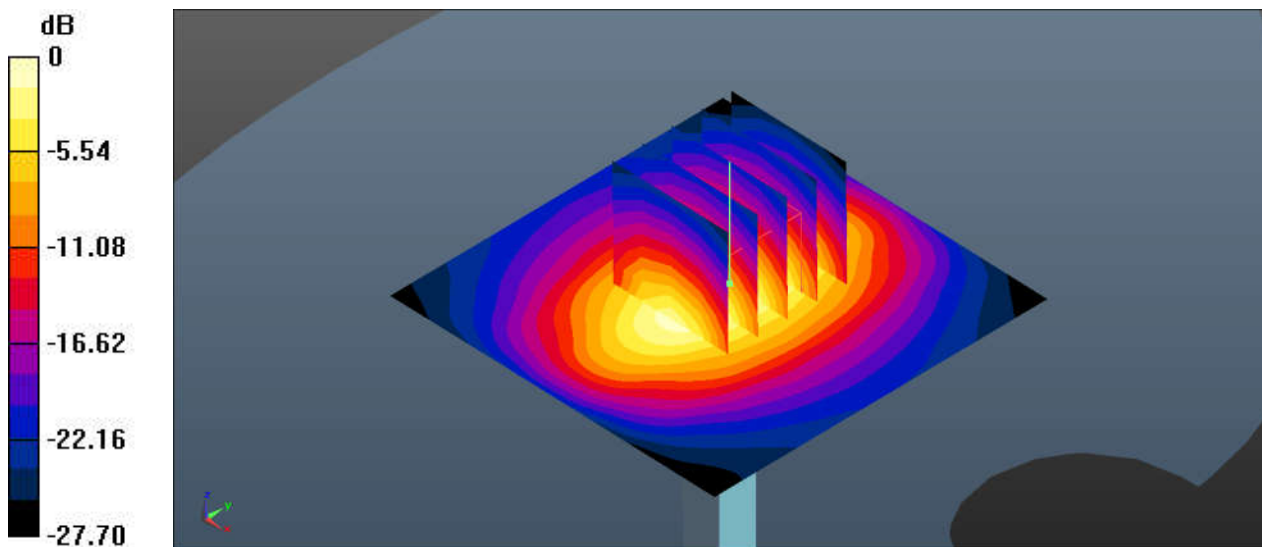

0 dB = 31.0 W/kg = 14.91 dBW/kg

System Check_Head_2450Hz

DUT: D2450V2 - SN:908

Communication System: UID 0, CW (0); Frequency: 2450 MHz; Duty Cycle: 1:1

Medium: HSL_2450 Medium parameters used: $f = 2450$ MHz; $\sigma = 1.845$ S/m; $\epsilon_r = 38.195$; $\rho = 1000$ kg/m³

Ambient Temperature : 23.5 °C ; Liquid Temperature : 22.8 °C

DASY5 Configuration:

- Probe: ES3DV3 - SN3293; ConvF(4.53, 4.53, 4.53); Calibrated: 2018.10.25
- Sensor-Surface: 3mm (Mechanical Surface Detection)
- Electronics: DAE4 Sn1210; Calibrated: 2019.1.25
- Phantom: SAM2; Type: SAM; Serial: TP-1542
- Measurement SW: DASY52, Version 52.10 (1); SEMCAD X Version 14.6.11 (7439)

Pin=250mW/Area Scan (71x71x1): Interpolated grid: dx=1.200 mm, dy=1.200 mm

Maximum value of SAR (interpolated) = 16.1 W/kg

Pin=250mW/Zoom Scan (7x7x7)/Cube 0: Measurement grid: dx=5mm, dy=5mm, dz=5mm

Reference Value = 79.23 V/m; Power Drift = 0.14 dB

Peak SAR (extrapolated) = 20.4 W/kg

SAR(1 g) = 12.5 W/kg; SAR(10 g) = 5.61 W/kg

Maximum value of SAR (measured) = 16.1 W/kg

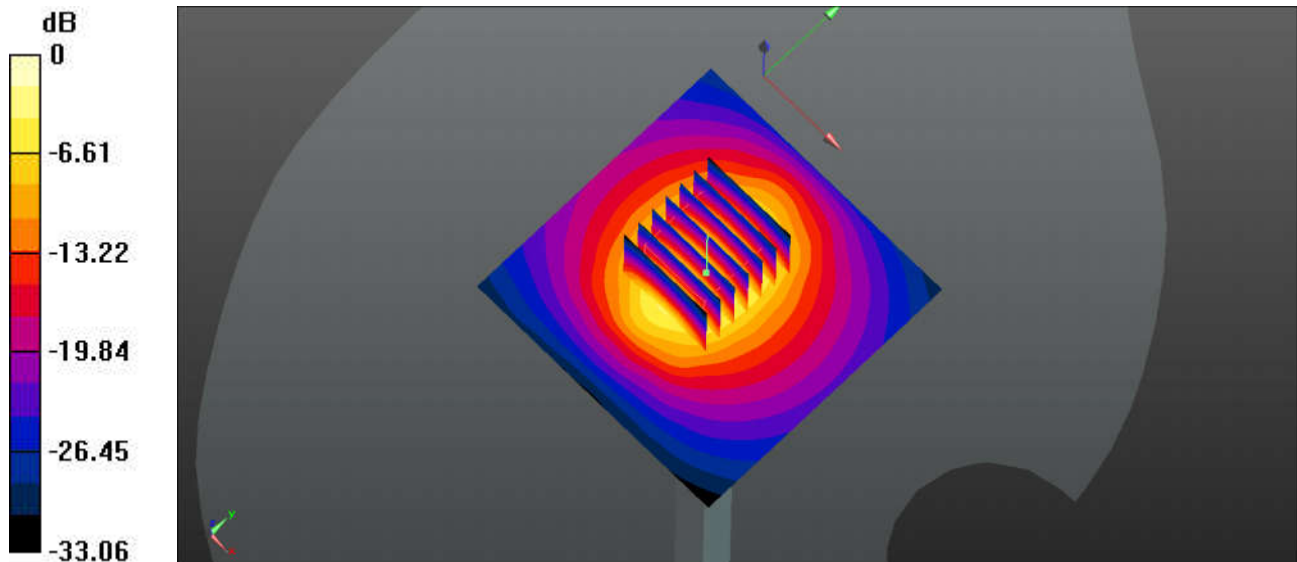

0 dB = 16.1 W/kg = 12.07 dBW/kg

System Check_Head_2600MHz

DUT: D2600V2 - SN:1061

Communication System: UID 0, CW (0); Frequency: 2600 MHz; Duty Cycle: 1:1

Medium: HSL_2600 Medium parameters used: $f = 2600 \text{ MHz}$; $\sigma = 2.037 \text{ S/m}$; $\epsilon_r = 38.9$; $\rho = 1000 \text{ kg/m}^3$
 Ambient Temperature : $23.2 \text{ }^\circ\text{C}$; Liquid Temperature : $22.6 \text{ }^\circ\text{C}$

DASY5 Configuration:

- Probe: ES3DV3 - SN3293; ConvF(4.44, 4.44, 4.44); Calibrated: 2018.10.25
- Sensor-Surface: 3mm (Mechanical Surface Detection)
- Electronics: DAE4 Sn1210; Calibrated: 2019.1.25
- Phantom: SAM2; Type: SAM; Serial: TP-1542
- Measurement SW: DASY52, Version 52.10 (1); SEMCAD X Version 14.6.11 (7439)

Pin=250mW/Area Scan (71x71x1): Interpolated grid: $dx=1.200 \text{ mm}$, $dy=1.200 \text{ mm}$
 Maximum value of SAR (interpolated) = 20.2 W/kg

Pin=250mW/Zoom Scan (7x7x7)/Cube 0: Measurement grid: $dx=5\text{mm}$, $dy=5\text{mm}$, $dz=5\text{mm}$
 Reference Value = 81.33 V/m ; Power Drift = 0.14 dB
 Peak SAR (extrapolated) = 27.4 W/kg
SAR(1 g) = 14.1 W/kg ; SAR(10 g) = 6.51 W/kg
 Maximum value of SAR (measured) = 19.7 W/kg

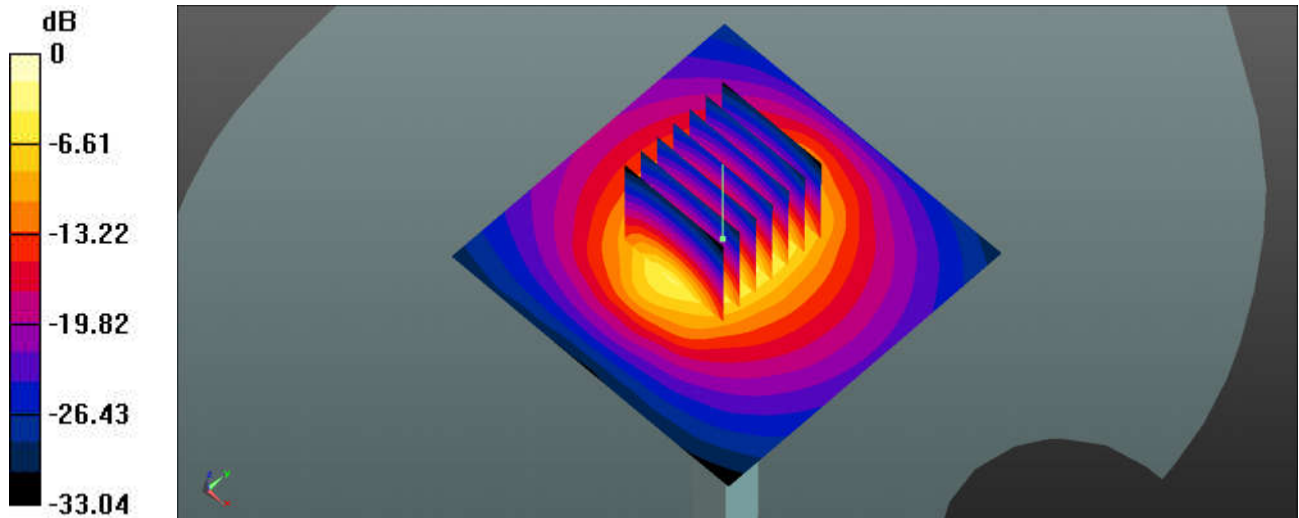

0 dB = $20.2 \text{ W/kg} = 13.05 \text{ dBW/kg}$

System Check_Head_5250MHz

DUT: D5GHzV2-SN:1006

Communication System: UID 0, CW (0); Frequency: 5250 MHz; Duty Cycle: 1:1
Medium: HSL_5000 Medium parameters used: $f = 5250$ MHz; $\sigma = 4.844$ S/m; $\epsilon_r = 36.985$; $\rho = 1000$ kg/m³
Ambient Temperature : 23.3 °C ; Liquid Temperature : 22.6 °C

DASY5 Configuration:

- Probe: EX3DV4 - SN3857; ConvF(5.2, 5.2, 5.2); Calibrated: 2018.5.31;
- Sensor-Surface: 1.4mm (Mechanical Surface Detection)
- Electronics: DAE4 Sn1279; Calibrated: 2018.10.22
- Phantom: SAM1; Type: SAM; Serial: TP-1697
- Measurement SW: DASY52, Version 52.8 (8); SEMCAD X Version 14.6.10 (7372)

Pin=100mW/Area Scan (71x71x1): Interpolated grid: dx=1.000 mm, dy=1.000 mm
Maximum value of SAR (interpolated) = 15.4 W/kg

Pin=100mW/Zoom Scan (8x8x7)/Cube 0: Measurement grid: dx=4mm, dy=4mm, dz=1.4mm
Reference Value = 30.77 V/m; Power Drift = -0.04 dB
Peak SAR (extrapolated) = 21.3 W/kg
SAR(1 g) = 7.89 W/kg; SAR(10 g) = 2.3 W/kg
Maximum value of SAR (measured) = 14.9 W/kg

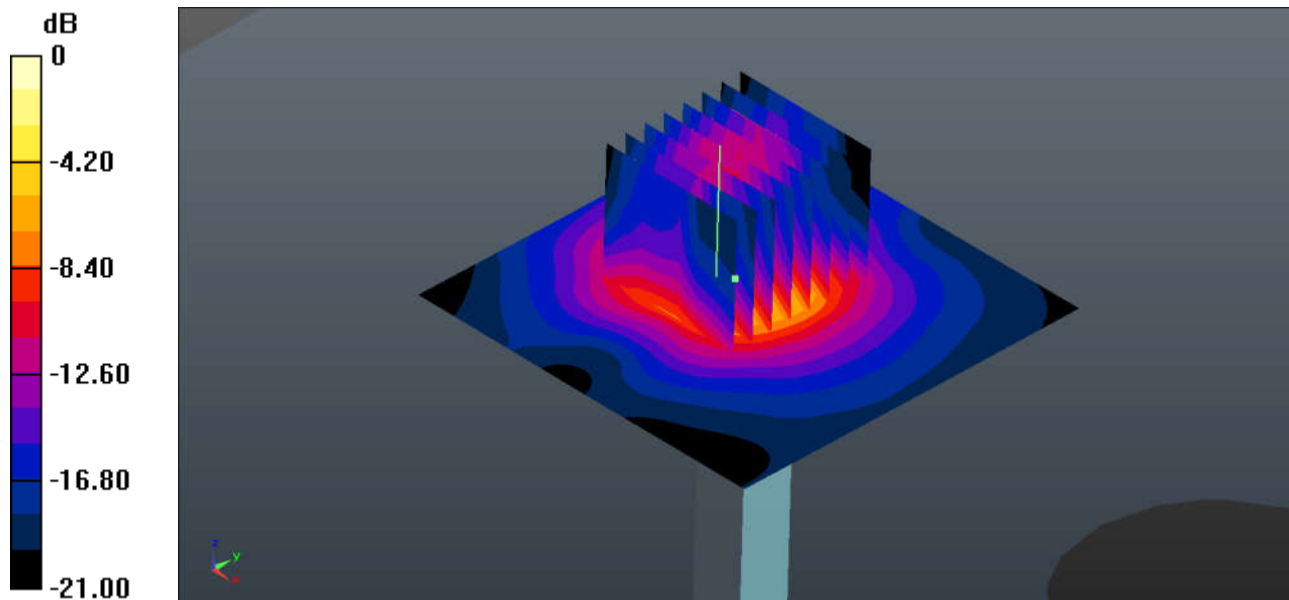

0 dB = 14.9 W/kg = 11.73 dBW/kg

System Check_Head_5600MHz

DUT: D5GHzV2-SN:1006

Communication System: UID 0, CW (0); Frequency: 5600 MHz; Duty Cycle: 1:1
Medium: HSL_5000 Medium parameters used: $f = 5600$ MHz; $\sigma = 5.212$ S/m; $\epsilon_r = 36.458$; $\rho = 1000$ kg/m³
Ambient Temperature : 23.3 °C ; Liquid Temperature : 22.8 °C

DASY5 Configuration:

- Probe: EX3DV4 - SN3857; ConvF(4.94, 4.94, 4.94); Calibrated: 2018.5.31;
- Sensor-Surface: 1.4mm (Mechanical Surface Detection)
- Electronics: DAE4 Sn1279; Calibrated: 2018.10.22
- Phantom: SAM1; Type: SAM; Serial: TP-1697
- Measurement SW: DASY52, Version 52.8 (8); SEMCAD X Version 14.6.10 (7372)

Pin=100mW/Area Scan (71x71x1): Interpolated grid: dx=1.000 mm, dy=1.000 mm
Maximum value of SAR (interpolated) = 19.2 W/kg

Pin=100mW/Zoom Scan (8x8x7)/Cube 0: Measurement grid: dx=4mm, dy=4mm, dz=1.4mm
Reference Value = 39.08 V/m; Power Drift = 0.02 dB
Peak SAR (extrapolated) = 33.9 W/kg
SAR(1 g) = 7.81 W/kg; SAR(10 g) = 2.24 W/kg
Maximum value of SAR (measured) = 18.4 W/kg

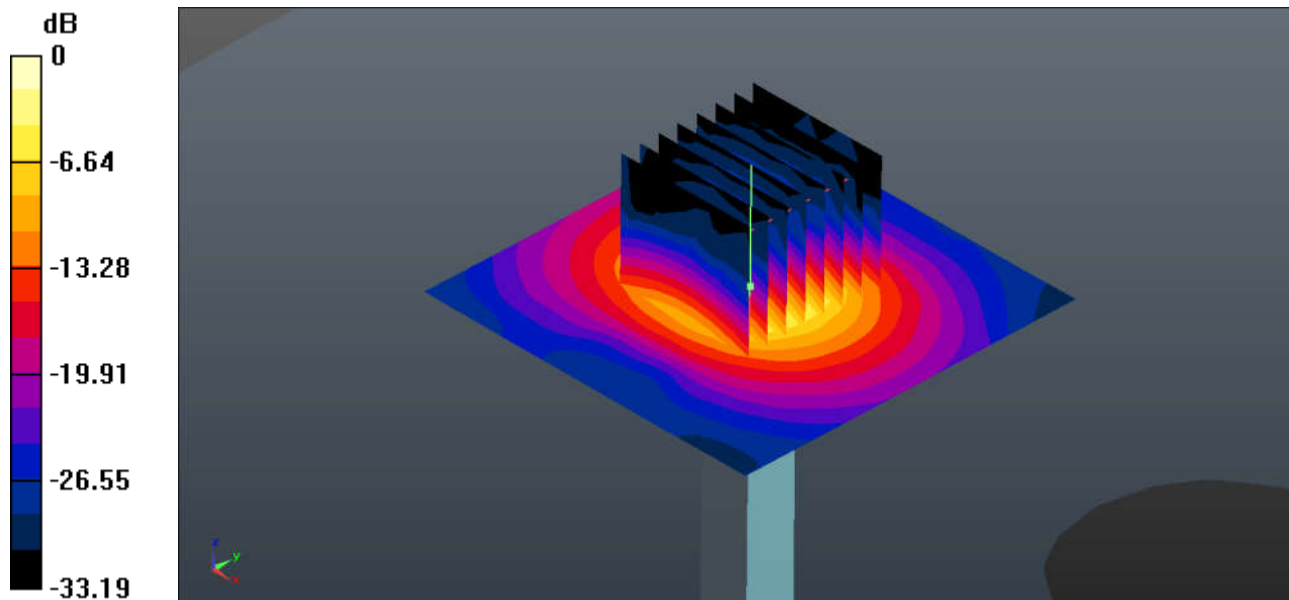

0 dB = 18.4 W/kg = 12.65 dBW/kg

System Check_Head_5750MHz

DUT: D5GHzV2-SN:1006

Communication System: UID 0, CW (0); Frequency: 5750 MHz; Duty Cycle: 1:1
Medium: HSL_5000 Medium parameters used: $f = 5750$ MHz; $\sigma = 5.377$ S/m; $\epsilon_r = 36.232$; $\rho = 1000$ kg/m³
Ambient Temperature : 23.4 °C ; Liquid Temperature : 22.7 °C

DASY5 Configuration:

- Probe: EX3DV4 - SN3857; ConvF(5.23, 5.23, 5.23); Calibrated: 2018.5.31;
- Sensor-Surface: 1.4mm (Mechanical Surface Detection)
- Electronics: DAE4 Sn1279; Calibrated: 2018.10.22
- Phantom: SAM1; Type: SAM; Serial: TP-1697
- Measurement SW: DASY52, Version 52.8 (8); SEMCAD X Version 14.6.10 (7372)

Pin=100mW/Area Scan (71x71x1): Interpolated grid: dx=1.000 mm, dy=1.000 mm
Maximum value of SAR (interpolated) = 17.3 W/kg

Pin=100mW/Zoom Scan (8x8x7)/Cube 0: Measurement grid: dx=4mm, dy=4mm, dz=1.4mm
Reference Value = 37.16 V/m; Power Drift = 0.06 dB
Peak SAR (extrapolated) = 33.3 W/kg
SAR(1 g) = 7.65 W/kg; SAR(10 g) = 2.25 W/kg
Maximum value of SAR (measured) = 17.6 W/kg

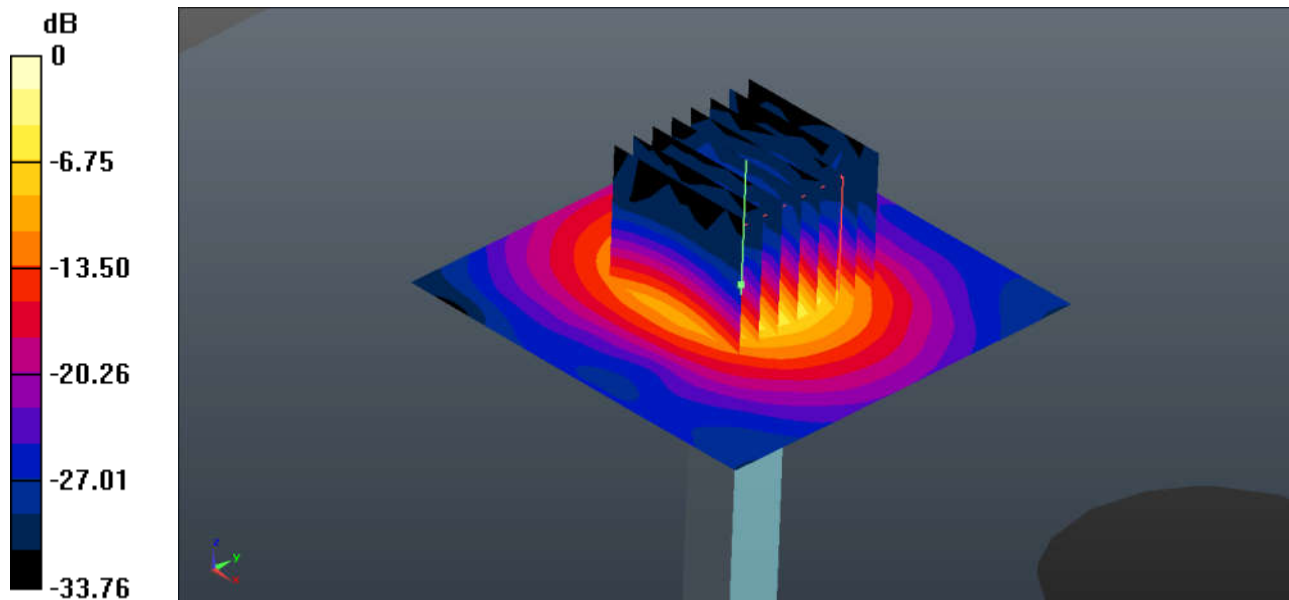

0 dB = 17.6 W/kg = 12.46 dBW/kg



Appendix B. Plots of High SAR Measurement

The plots are shown as follows.

01_GSM850_GPRS (4 Tx slots)_Left Cheek_0mm_OFF_Ch251

Communication System: UID 0, GSM850 (0); Frequency: 848.8 MHz; Duty Cycle: 1:8.30
Medium: HSL_850 Medium parameters used: $f = 848.8$ MHz; $\sigma = 0.915$ S/m; $\epsilon_r = 41.594$; $\rho = 1000$ kg/m³
Ambient Temperature : 23.2 °C ; Liquid Temperature : 22.7 °C

DASY5 Configuration:

- Probe: ES3DV3 - SN3279; ConvF(6.38, 6.38, 6.38); Calibrated: 2019.3.4
- Sensor-Surface: 3mm (Mechanical Surface Detection)
- Electronics: DAE4 Sn1279; Calibrated: 2018.10.22
- Phantom: SAM2; Type: SAM; Serial: TP-1542
- Measurement SW: DASY52, Version 52.10 (1); SEMCAD X Version 14.6.11 (7439)

Ch251/Area Scan (71x81x1): Interpolated grid: dx=1.500 mm, dy=1.500 mm
Maximum value of SAR (interpolated) = 0.569 W/kg

Ch251/Zoom Scan (6x6x7)/Cube 0: Measurement grid: dx=8mm, dy=8mm, dz=5mm
Reference Value = 8.223 V/m; Power Drift = 0.02 dB
Peak SAR (extrapolated) = 0.673 W/kg
SAR(1 g) = 0.506 W/kg; SAR(10 g) = 0.372 W/kg
Maximum value of SAR (measured) = 0.553 W/kg

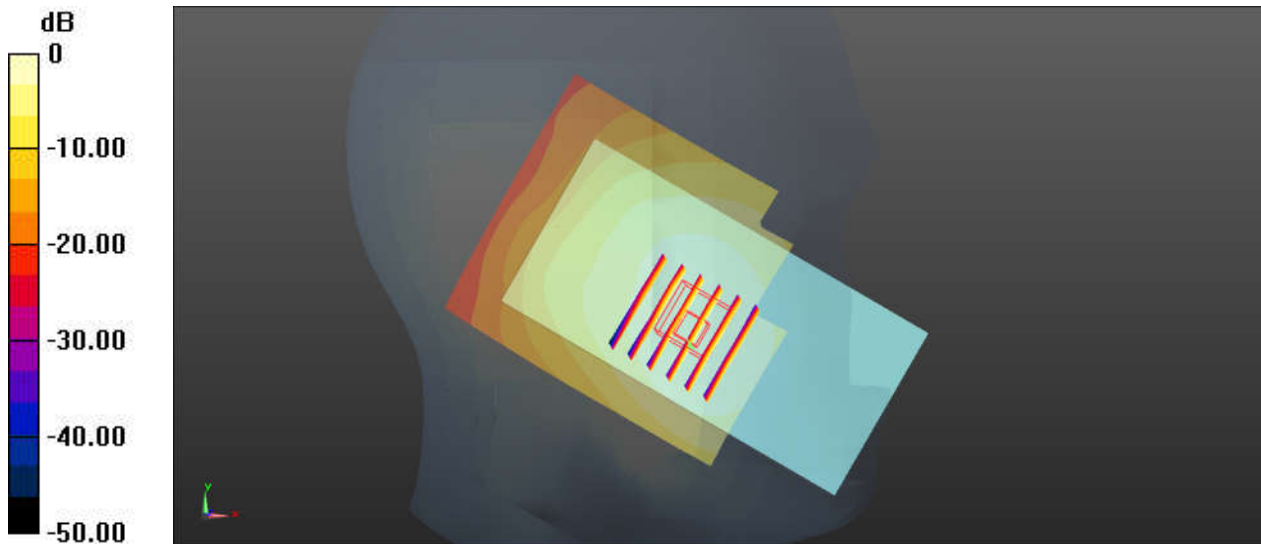

0 dB = 0.569 W/kg = -2.45 dBW/kg

02_GSM 1900_GPRS (4 Tx slot)_Left Cheek_0mm_Ch810

Communication System: UID 0, PCS-4UP (0); Frequency: 1909.8 MHz; Duty Cycle: 1:2.08
Medium: HSL_1900 Medium parameters used: $f = 1909.8$ MHz; $\sigma = 1.383$ S/m; $\epsilon_r = 39.69$; $\rho = 1000$ kg/m³
Ambient Temperature : 23.2 °C ; Liquid Temperature : 22.9 °C

DASY5 Configuration:

- Probe: ES3DV3 - SN3279; ConvF(5.35, 5.35, 5.35); Calibrated: 2019.3.4
- Sensor-Surface: 3mm (Mechanical Surface Detection)
- Electronics: DAE4 Sn1279; Calibrated: 2018.10.22
- Phantom: SAM2; Type: SAM; Serial: TP-1542
- Measurement SW: DASY52, Version 52.10 (1); SEMCAD X Version 14.6.11 (7439)

Ch810/Area Scan (71x81x1): Interpolated grid: dx=1.500 mm, dy=1.500 mm
Maximum value of SAR (interpolated) = 0.364 W/kg

Ch810/Zoom Scan (5x5x7)/Cube 0: Measurement grid: dx=8mm, dy=8mm, dz=5mm
Reference Value = 4.829 V/m; Power Drift = 0.14 dB
Peak SAR (extrapolated) = 0.453 W/kg
SAR(1 g) = 0.291 W/kg; SAR(10 g) = 0.183 W/kg
Maximum value of SAR (measured) = 0.343 W/kg

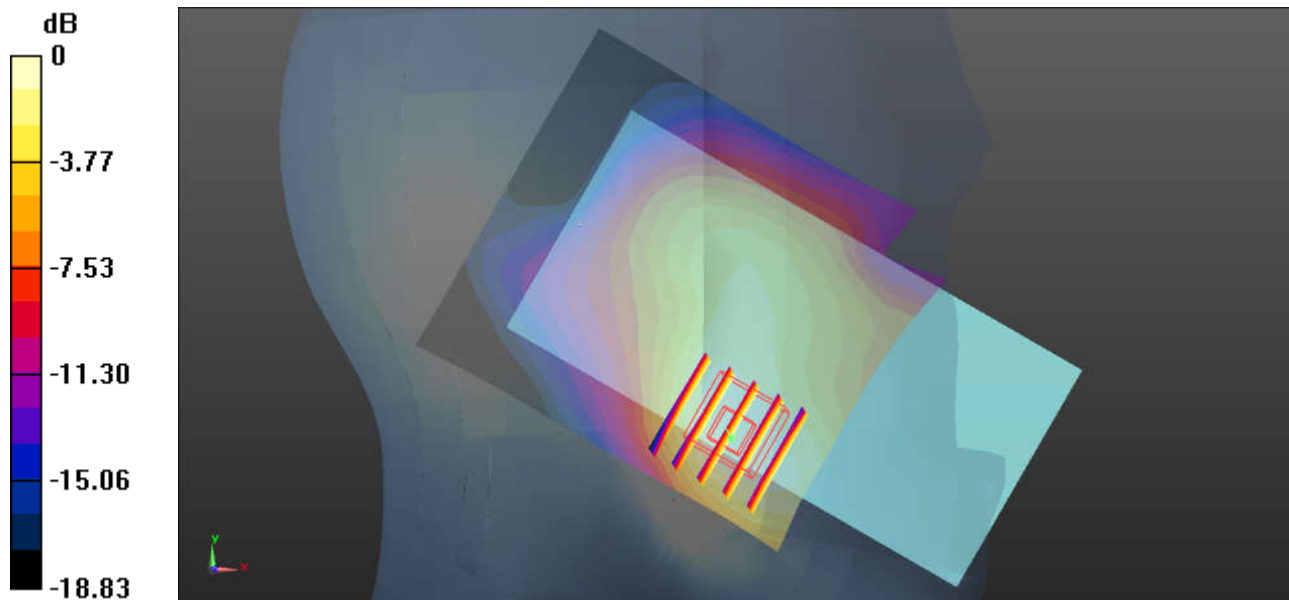

0 dB = 0.343 W/kg = -4.65 dBW/kg

03_WCDMA V_RMC 12.2Kbps_Left Cheek_0mm_OFF_Ch4132

Communication System: UID 0, WCDMA (0); Frequency: 826.4 MHz; Duty Cycle: 1:1
Medium: HSL_850 Medium parameters used: $f = 826.4$ MHz; $\sigma = 0.895$ S/m; $\epsilon_r = 41.891$; $\rho = 1000$ kg/m³
Ambient Temperature : 23.2 °C ; Liquid Temperature : 22.7 °C

DASY5 Configuration:

- Probe: ES3DV3 - SN3279; ConvF(6.38, 6.38, 6.38); Calibrated: 2019.3.4
- Sensor-Surface: 3mm (Mechanical Surface Detection)
- Electronics: DAE4 Sn1279; Calibrated: 2018.10.22
- Phantom: SAM2; Type: SAM; Serial: TP-1542
- Measurement SW: DASY52, Version 52.10 (1); SEMCAD X Version 14.6.11 (7439)

Ch4132/Area Scan (71x81x1): Interpolated grid: dx=1.500 mm, dy=1.500 mm
Maximum value of SAR (interpolated) = 0.562 W/kg

Ch4132/Zoom Scan (6x6x7)/Cube 0: Measurement grid: dx=8mm, dy=8mm, dz=5mm
Reference Value = 9.376 V/m; Power Drift = 0.14 dB
Peak SAR (extrapolated) = 0.650 W/kg
SAR(1 g) = 0.505 W/kg; SAR(10 g) = 0.382 W/kg
Maximum value of SAR (measured) = 0.547 W/kg

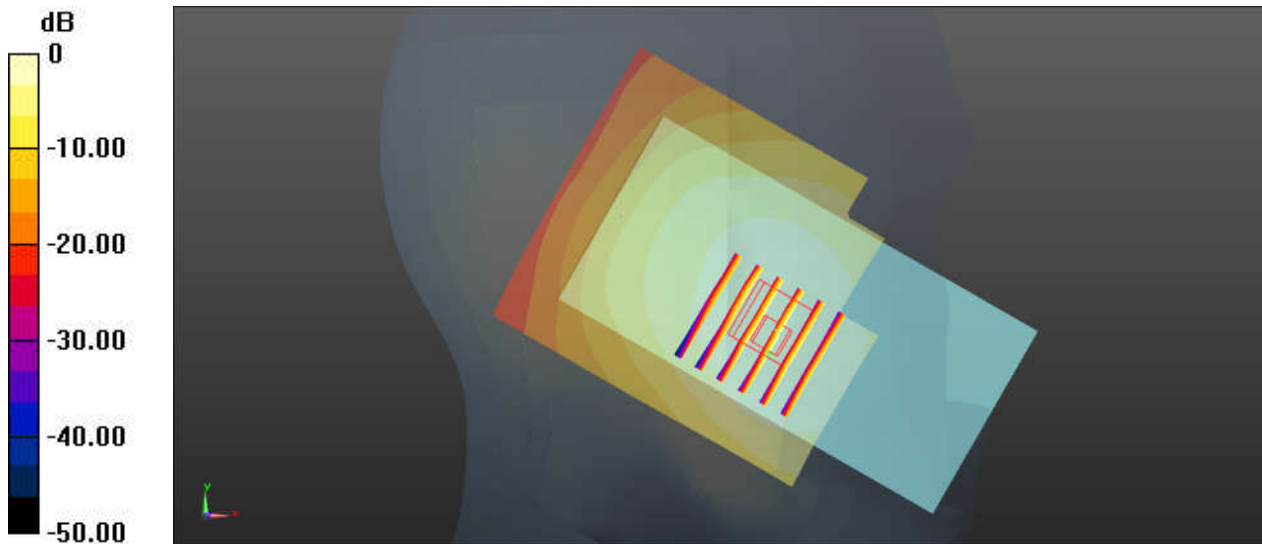

0 dB = 0.562 W/kg = -2.50 dBW/kg

04_WCDMA IV_RMC 12.2Kbps_Right Cheek_0mm_OFF_Ch1413

Communication System: UID 0, WCDMA (0); Frequency: 1732.6 MHz; Duty Cycle: 1:1
Medium: HSL_1750 Medium parameters used: $f = 1732.6$ MHz; $\sigma = 1.363$ S/m; $\epsilon_r = 41.153$; $\rho = 1000$ kg/m³
Ambient Temperature : 23.3 °C ; Liquid Temperature : 22.8 °C

DASY5 Configuration:

- Probe: ES3DV3 - SN3279; ConvF(5.59, 5.59, 5.59); Calibrated: 2019.3.4
- Sensor-Surface: 3mm (Mechanical Surface Detection)
- Electronics: DAE4 Sn1279; Calibrated: 2018.10.22
- Phantom: SAM2; Type: SAM; Serial: TP-1542
- Measurement SW: DASY52, Version 52.10 (1); SEMCAD X Version 14.6.11 (7439)

Ch1413/Area Scan (71x81x1): Interpolated grid: dx=1.500 mm, dy=1.500 mm
Maximum value of SAR (interpolated) = 0.375 W/kg

Ch1413/Zoom Scan (5x5x7)/Cube 0: Measurement grid: dx=8mm, dy=8mm, dz=5mm
Reference Value = 4.519 V/m; Power Drift = -0.03 dB
Peak SAR (extrapolated) = 0.440 W/kg
SAR(1 g) = 0.290 W/kg; SAR(10 g) = 0.188 W/kg
Maximum value of SAR (measured) = 0.327 W/kg

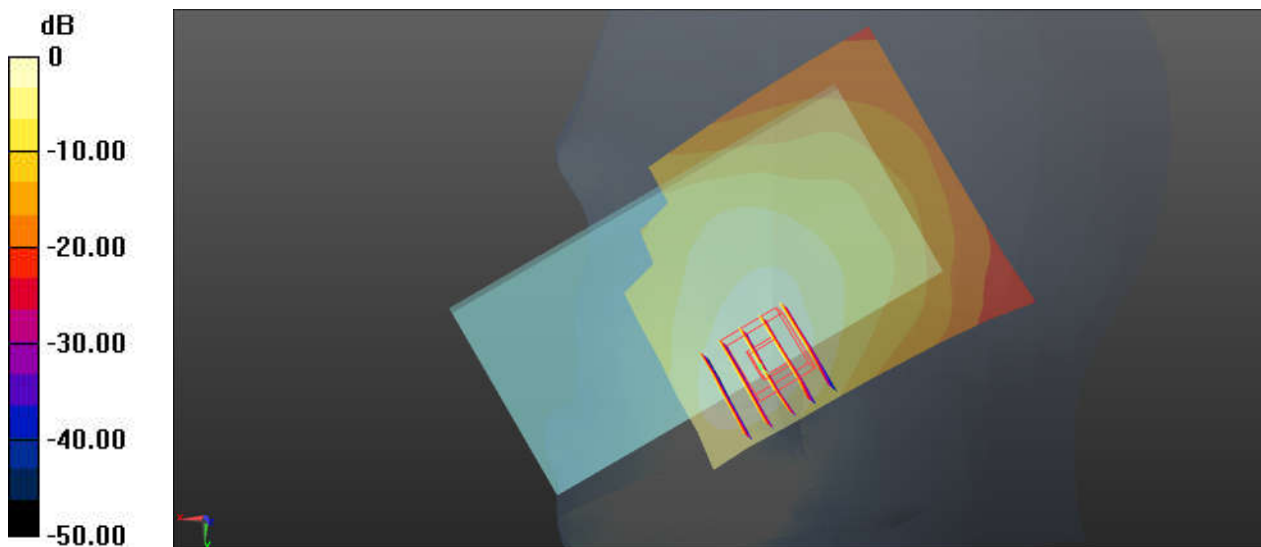

0 dB = 0.375 W/kg = -4.26 dBW/kg

05_WCDMA II_RMC12.2Kbps_Left Cheek_0mm_Ch9400

Communication System: UID 0, WCDMA (0); Frequency: 1880 MHz; Duty Cycle: 1:1
 Medium: HSL_1900 Medium parameters used: $f = 1880 \text{ MHz}$; $\sigma = 1.352 \text{ S/m}$; $\epsilon_r = 39.804$; $\rho = 1000 \text{ kg/m}^3$
 Ambient Temperature : $23.2 \text{ }^\circ\text{C}$; Liquid Temperature : $22.9 \text{ }^\circ\text{C}$

DASY5 Configuration:

- Probe: ES3DV3 - SN3279; ConvF(5.35, 5.35, 5.35); Calibrated: 2019.3.4
- Sensor-Surface: 3mm (Mechanical Surface Detection)
- Electronics: DAE4 Sn1279; Calibrated: 2018.10.22
- Phantom: SAM2; Type: SAM; Serial: TP-1542
- Measurement SW: DASY52, Version 52.10 (1); SEMCAD X Version 14.6.11 (7439)

Ch9400/Area Scan (71x81x1): Interpolated grid: $dx=1.500 \text{ mm}$, $dy=1.500 \text{ mm}$
 Maximum value of SAR (interpolated) = 0.785 W/kg

Ch9400/Zoom Scan (5x5x7)/Cube 0: Measurement grid: $dx=8\text{mm}$, $dy=8\text{mm}$, $dz=5\text{mm}$
 Reference Value = 7.639 V/m ; Power Drift = 0.06 dB
 Peak SAR (extrapolated) = 0.945 W/kg
SAR(1 g) = 0.617 W/kg ; SAR(10 g) = 0.395 W/kg
 Maximum value of SAR (measured) = 0.718 W/kg

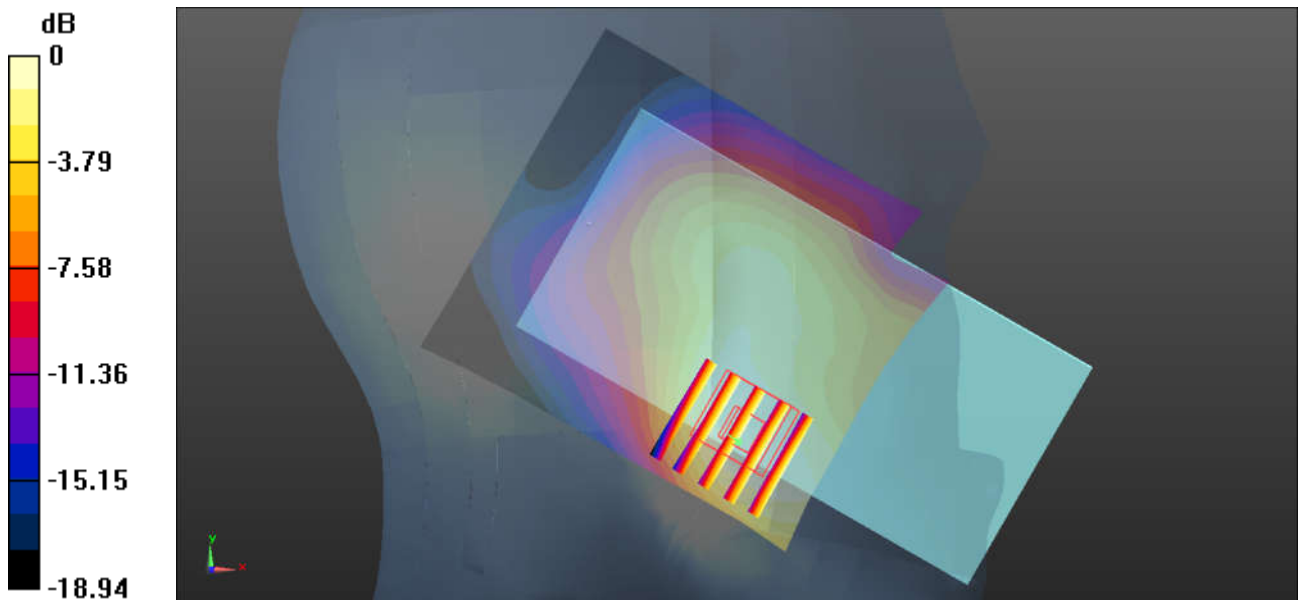

0 dB = 0.718 W/kg = -1.44 dBW/kg

06_CDMA2000 BC0_RC3 SO55_Left Cheek_0mm_OFF_Ch1013

Communication System: UID 0, CDMA (0); Frequency: 824.7 MHz; Duty Cycle: 1:1
Medium: HSL_850 Medium parameters used: $f = 824.7$ MHz; $\sigma = 0.893$ S/m; $\epsilon_r = 41.912$; $\rho = 1000$ kg/m³
Ambient Temperature : 23.2 °C ; Liquid Temperature : 22.7 °C

DASY5 Configuration:

- Probe: ES3DV3 - SN3279; ConvF(6.38, 6.38, 6.38); Calibrated: 2019.3.4
- Sensor-Surface: 3mm (Mechanical Surface Detection)
- Electronics: DAE4 Sn1279; Calibrated: 2018.10.22
- Phantom: SAM2; Type: SAM; Serial: TP-1542
- Measurement SW: DASY52, Version 52.10 (1); SEMCAD X Version 14.6.11 (7439)

Ch1013/Area Scan (71x81x1): Interpolated grid: dx=1.500 mm, dy=1.500 mm
Maximum value of SAR (interpolated) = 0.577 W/kg

Ch1013/Zoom Scan (6x6x7)/Cube 0: Measurement grid: dx=8mm, dy=8mm, dz=5mm
Reference Value = 10.38 V/m; Power Drift = 0.06 dB
Peak SAR (extrapolated) = 0.673 W/kg
SAR(1 g) = 0.520 W/kg; SAR(10 g) = 0.392 W/kg
Maximum value of SAR (measured) = 0.562 W/kg

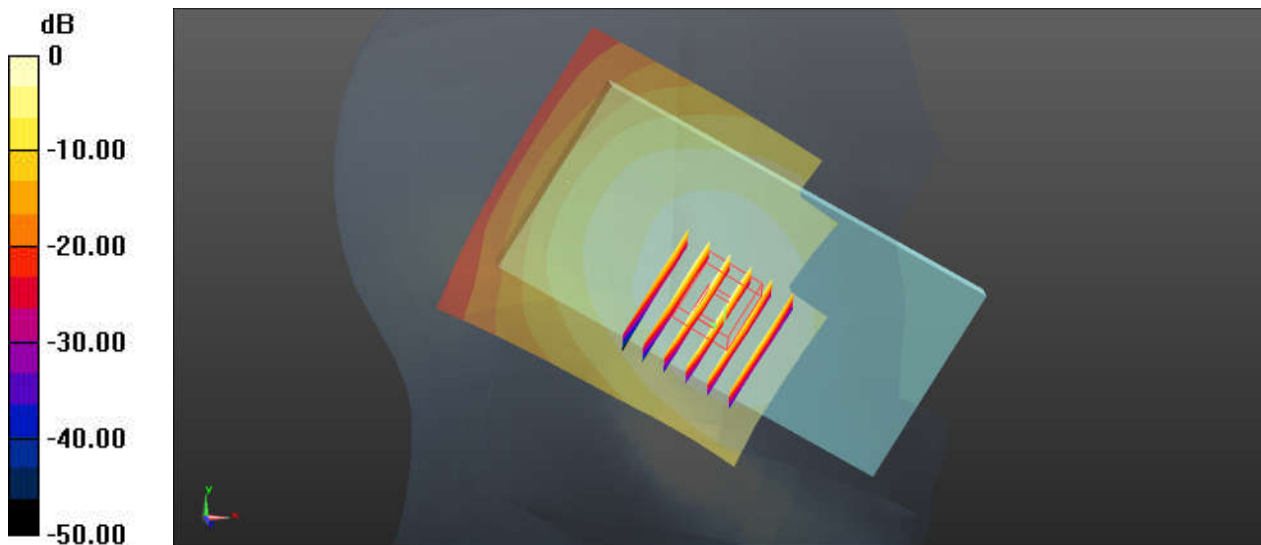

0 dB = 0.577 W/kg = -2.39 dBW/kg

07_CDMA2000 BC10_RC3 SO55_Left Cheek_0mm_OFF_Ch580

Communication System: UID 0, CDMA (0); Frequency: 820.5 MHz; Duty Cycle: 1:1
Medium: HSL_850 Medium parameters used: $f = 820.5$ MHz; $\sigma = 0.889$ S/m; $\epsilon_r = 41.969$; $\rho = 1000$ kg/m³
Ambient Temperature : 23.2 °C ; Liquid Temperature : 22.7 °C

DASY5 Configuration:

- Probe: ES3DV3 - SN3279; ConvF(6.38, 6.38, 6.38); Calibrated: 2019.3.4
- Sensor-Surface: 3mm (Mechanical Surface Detection)
- Electronics: DAE4 Sn1279; Calibrated: 2018.10.22
- Phantom: SAM2; Type: SAM; Serial: TP-1542
- Measurement SW: DASY52, Version 52.10 (1); SEMCAD X Version 14.6.11 (7439)

Ch580/Area Scan (71x81x1): Interpolated grid: $dx=1.500$ mm, $dy=1.500$ mm
Maximum value of SAR (interpolated) = 0.600 W/kg

Ch580/Zoom Scan (6x6x7)/Cube 0: Measurement grid: $dx=8$ mm, $dy=8$ mm, $dz=5$ mm
Reference Value = 10.56 V/m; Power Drift = 0.05 dB
Peak SAR (extrapolated) = 0.699 W/kg
SAR(1 g) = 0.551 W/kg; SAR(10 g) = 0.414 W/kg
Maximum value of SAR (measured) = 0.604 W/kg

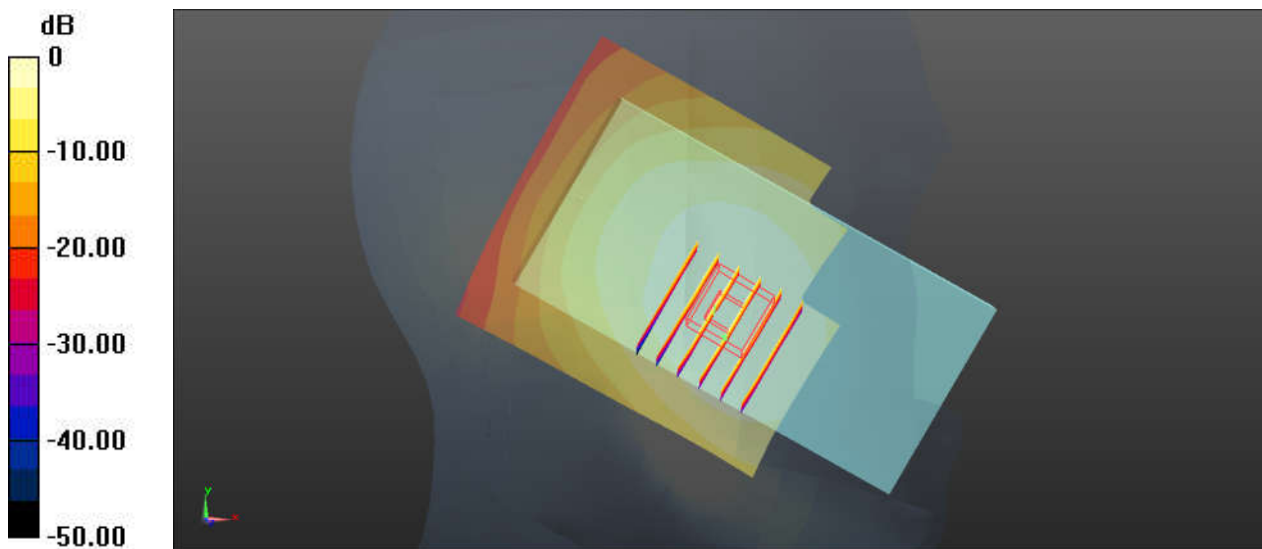

0 dB = 0.600 W/kg = -2.22 dBW/kg

08_CDMA2000 BC1_RC3 SO55_Left Cheek_0mm_OFF_Ch25

Communication System: UID 0, CDMA (0); Frequency: 1851.25 MHz; Duty Cycle: 1:1
Medium: HSL_1900 Medium parameters used: $f = 1851.25$ MHz; $\sigma = 1.379$ S/m; $\epsilon_r = 38.952$; $\rho = 1000$ kg/m³
Ambient Temperature : 23.2 °C ; Liquid Temperature : 22.9 °C

DASY5 Configuration:

- Probe: ES3DV3 - SN3279; ConvF(5.35, 5.35, 5.35); Calibrated: 2019.3.4
- Sensor-Surface: 3mm (Mechanical Surface Detection)
- Electronics: DAE4 Sn1279; Calibrated: 2018.10.22
- Phantom: SAM2; Type: SAM; Serial: TP-1542
- Measurement SW: DASY52, Version 52.10 (1); SEMCAD X Version 14.6.11 (7439)

Ch25/Area Scan (71x81x1): Interpolated grid: dx=1.500 mm, dy=1.500 mm.
Maximum value of SAR (interpolated) = 0.796 W/kg

Ch25/Zoom Scan (6x6x7)/Cube 0: Measurement grid: dx=8mm, dy=8mm, dz=5mm
Reference Value = 8.352 V/m; Power Drift = 0.13 dB
Peak SAR (extrapolated) = 1.01 W/kg
SAR(1 g) = 0.677 W/kg; SAR(10 g) = 0.441 W/kg
Maximum value of SAR (measured) = 0.776 W/kg

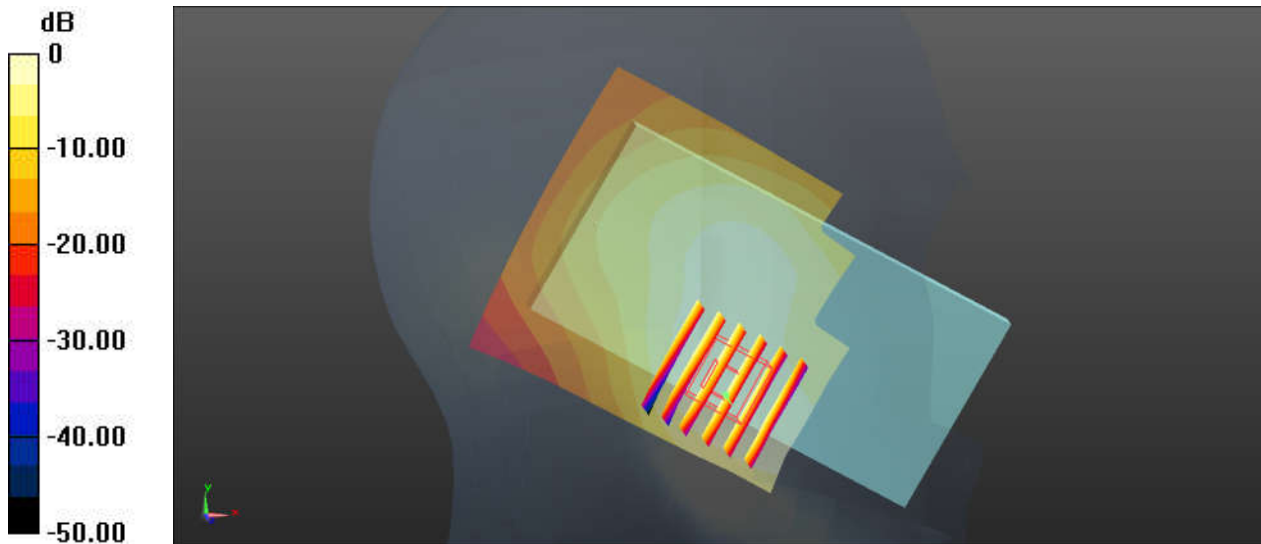

0 dB = 0.796 W/kg = -0.99 dBW/kg

09_LTE B71_20M_QPSK_1RB_0offset_Right Cheek_0mm_OFF_Ch133322

Communication System: UID 0, LTE-FDD (0); Frequency: 683 MHz;Duty Cycle: 1:1
Medium: HSL_750 Medium parameters used: $f = 683 \text{ MHz}$; $\sigma = 0.835 \text{ S/m}$; $\epsilon_r = 42.538$; $\rho = 1000 \text{ kg/m}^3$
Ambient Temperature : $23.1 \text{ }^\circ\text{C}$; Liquid Temperature : $22.8 \text{ }^\circ\text{C}$

DASY5 Configuration:

- Probe: ES3DV3 - SN3279; ConvF(6.58, 6.58, 6.58); Calibrated: 2019.3.4
- Sensor-Surface: 3mm (Mechanical Surface Detection)
- Electronics: DAE4 Sn1279; Calibrated: 2018.10.22
- Phantom: SAM2; Type: SAM; Serial: TP-1542
- Measurement SW: DASY52, Version 52.10 (1); SEMCAD X Version 14.6.11 (7439)

Ch133322/Area Scan (71x61x1): Interpolated grid: $dx=1.500 \text{ mm}$, $dy=1.500 \text{ mm}$
Maximum value of SAR (interpolated) = 0.289 W/kg

Ch133322/Zoom Scan (6x6x7)/Cube 0: Measurement grid: $dx=8\text{mm}$, $dy=8\text{mm}$, $dz=5\text{mm}$
Reference Value = 7.597 V/m ; Power Drift = 0.05 dB
Peak SAR (extrapolated) = 0.333 W/kg
SAR(1 g) = 0.269 W/kg ; SAR(10 g) = 0.213 W/kg
Maximum value of SAR (measured) = 0.286 W/kg

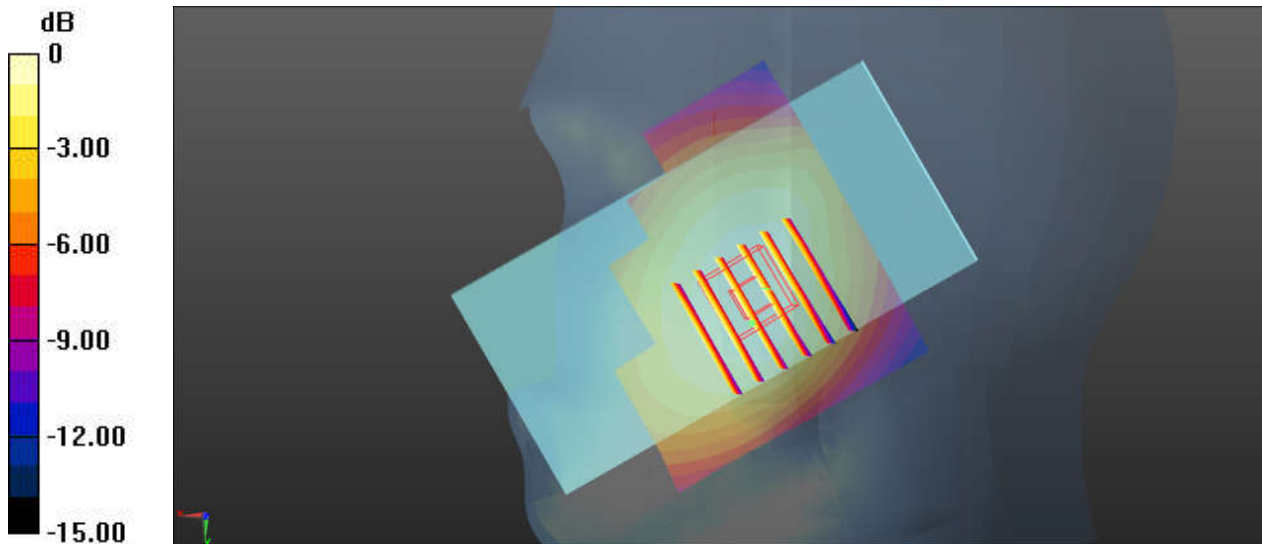

$0 \text{ dB} = 0.289 \text{ W/kg} = -5.39 \text{ dBW/kg}$

10_LTE B12_10M_QPSK_1RB_0offset_Left Cheek_0mm_OFF_Ch23095

Communication System: UID 0, LTE-FDD (0); Frequency: 707.5 MHz; Duty Cycle: 1:1
Medium: HSL_750 Medium parameters used: $f = 707.5$ MHz; $\sigma = 0.858$ S/m; $\epsilon_r = 42.2$; $\rho = 1000$ kg/m³
Ambient Temperature : 23.1 °C ; Liquid Temperature : 22.8 °C

DASY5 Configuration:

- Probe: ES3DV3 - SN3279; ConvF(6.58, 6.58, 6.58); Calibrated: 2019.3.4
- Sensor-Surface: 3mm (Mechanical Surface Detection)
- Electronics: DAE4 Sn1279; Calibrated: 2018.10.22
- Phantom: SAM2; Type: SAM; Serial: TP-1542
- Measurement SW: DASY52, Version 52.10 (1); SEMCAD X Version 14.6.11 (7439)

Ch23095/Area Scan (71x71x1): Interpolated grid: dx=1.500 mm, dy=1.500 mm
Maximum value of SAR (interpolated) = 0.566 W/kg

Ch23095/Zoom Scan (5x5x7)/Cube 0: Measurement grid: dx=8mm, dy=8mm, dz=5mm
Reference Value = 11.29 V/m; Power Drift = -0.03 dB
Peak SAR (extrapolated) = 0.551 W/kg
SAR(1 g) = 0.447 W/kg; SAR(10 g) = 0.352 W/kg
Maximum value of SAR (measured) = 0.483 W/kg

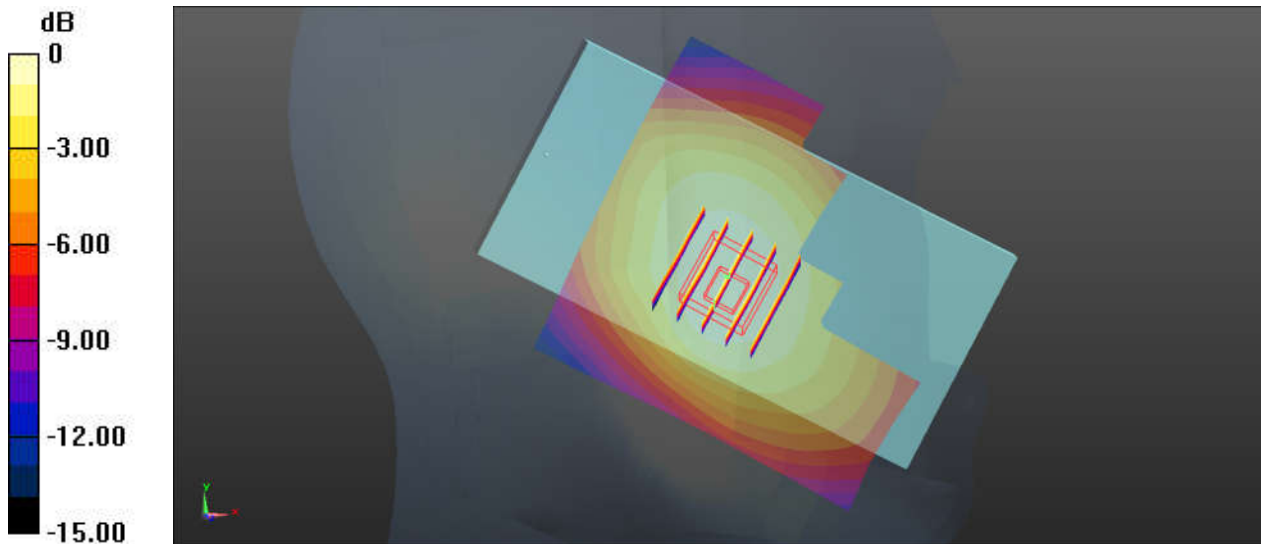

0 dB = 0.566 W/kg = -2.47 dBW/kg

11_LTE B13_10M_QPSK_1RB_0offset_Left Cheek_0mm_OFF_Ch23230

Communication System: UID 0, LTE-FDD (0); Frequency: 782 MHz; Duty Cycle: 1:1
Medium: HSL_750 Medium parameters used: $f = 782 \text{ MHz}$; $\sigma = 0.926 \text{ S/m}$; $\epsilon_r = 41.246$; $\rho = 1000 \text{ kg/m}^3$
Ambient Temperature : $23.1 \text{ }^\circ\text{C}$; Liquid Temperature : $22.8 \text{ }^\circ\text{C}$

DASY5 Configuration:

- Probe: ES3DV3 - SN3279; ConvF(6.58, 6.58, 6.58); Calibrated: 2019.3.4
- Sensor-Surface: 3mm (Mechanical Surface Detection)
- Electronics: DAE4 Sn1279; Calibrated: 2018.10.22
- Phantom: SAM2; Type: SAM; Serial: TP-1542
- Measurement SW: DASY52, Version 52.10 (1); SEMCAD X Version 14.6.11 (7439)

Ch23230/Area Scan (71x91x1): Interpolated grid: $dx=1.500 \text{ mm}$, $dy=1.500 \text{ mm}$

Maximum value of SAR (interpolated) = 0.715 W/kg

Ch23230/Zoom Scan (5x5x7)/Cube 0: Measurement grid: $dx=8\text{mm}$, $dy=8\text{mm}$, $dz=5\text{mm}$

Reference Value = 10.27 V/m ; Power Drift = -0.01 dB

Peak SAR (extrapolated) = 0.721 W/kg

SAR(1 g) = 0.571 W/kg ; SAR(10 g) = 0.437 W/kg

Maximum value of SAR (measured) = 0.622 W/kg

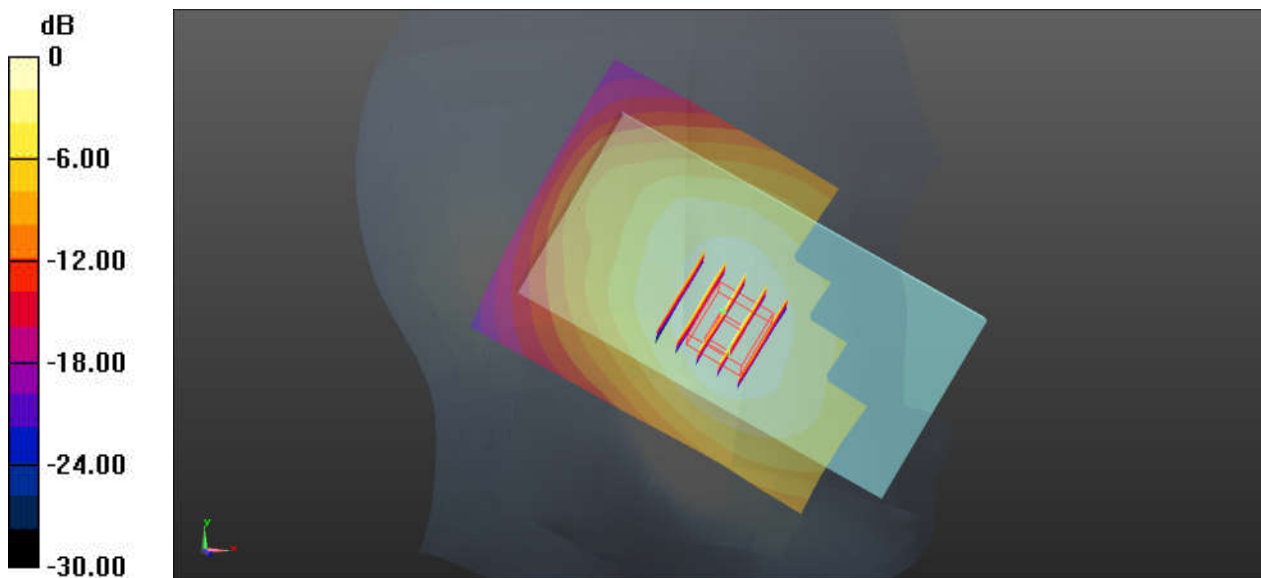

0 dB = 0.715 W/kg = -1.46 dBW/kg

12_LTE B26_15M_QPSK_1RB_74offset_Left Cheek_0mm_OFF_Ch26865

Communication System: UID 0, LTE-FDD (0); Frequency: 831.5 MHz; Duty Cycle: 1:1
Medium: HSL_850 Medium parameters used: $f = 831.5$ MHz; $\sigma = 0.899$ S/m; $\epsilon_r = 41.825$; $\rho = 1000$ kg/m³
Ambient Temperature : 23.2 °C ; Liquid Temperature : 22.7 °C

DASY5 Configuration:

- Probe: ES3DV3 - SN3279; ConvF(6.38, 6.38, 6.38); Calibrated: 2019.3.4
- Sensor-Surface: 3mm (Mechanical Surface Detection)
- Electronics: DAE4 Sn1279; Calibrated: 2018.10.22
- Phantom: SAM2; Type: SAM; Serial: TP-1542
- Measurement SW: DASY52, Version 52.10 (1); SEMCAD X Version 14.6.11 (7439)

Ch26865/Area Scan (71x81x1): Interpolated grid: dx=1.500 mm, dy=1.500 mm
Maximum value of SAR (interpolated) = 0.575 W/kg

Ch26865/Zoom Scan (6x6x7)/Cube 0: Measurement grid: dx=8mm, dy=8mm, dz=5mm
Reference Value = 9.920 V/m; Power Drift = -0.06 dB
Peak SAR (extrapolated) = 0.669 W/kg
SAR(1 g) = 0.521 W/kg; SAR(10 g) = 0.392 W/kg
Maximum value of SAR (measured) = 0.564 W/kg

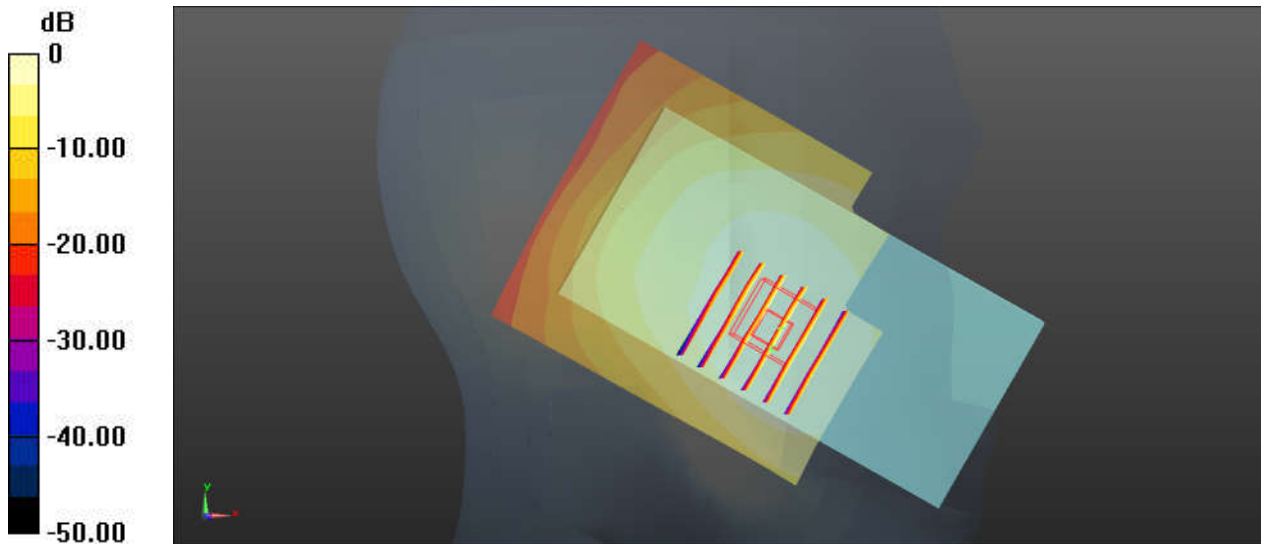

0 dB = 0.575 W/kg = -2.40 dBW/kg

13_LTE B66_20M_QPSK_1RB_0offset_Right Cheek_0mm_OFF_Ch132322

Communication System: UID 0, LTE-FDD (0); Frequency: 1745 MHz; Duty Cycle: 1:1
Medium: HSL_1750 Medium parameters used: $f = 1745$ MHz; $\sigma = 1.346$ S/m; $\epsilon_r = 40.515$; $\rho = 1000$ kg/m³
Ambient Temperature : 23.3 °C ; Liquid Temperature : 22.8 °C

DASY5 Configuration:

- Probe: ES3DV3 - SN3279; ConvF(5.59, 5.59, 5.59); Calibrated: 2019.3.4
- Sensor-Surface: 3mm (Mechanical Surface Detection)
- Electronics: DAE4 Sn1279; Calibrated: 2018.10.22
- Phantom: SAM2; Type: SAM; Serial: TP-1542
- Measurement SW: DASY52, Version 52.10 (1); SEMCAD X Version 14.6.11 (7439)

Ch132322/Area Scan (71x81x1): Interpolated grid: dx=1.500 mm, dy=1.500 mm
Maximum value of SAR (interpolated) = 0.444 W/kg

Ch132322/Zoom Scan (5x5x7)/Cube 0: Measurement grid: dx=8mm, dy=8mm, dz=5mm
Reference Value = 4.791 V/m; Power Drift = -0.07 dB
Peak SAR (extrapolated) = 0.556 W/kg
SAR(1 g) = 0.355 W/kg; SAR(10 g) = 0.225 W/kg
Maximum value of SAR (measured) = 0.404 W/kg

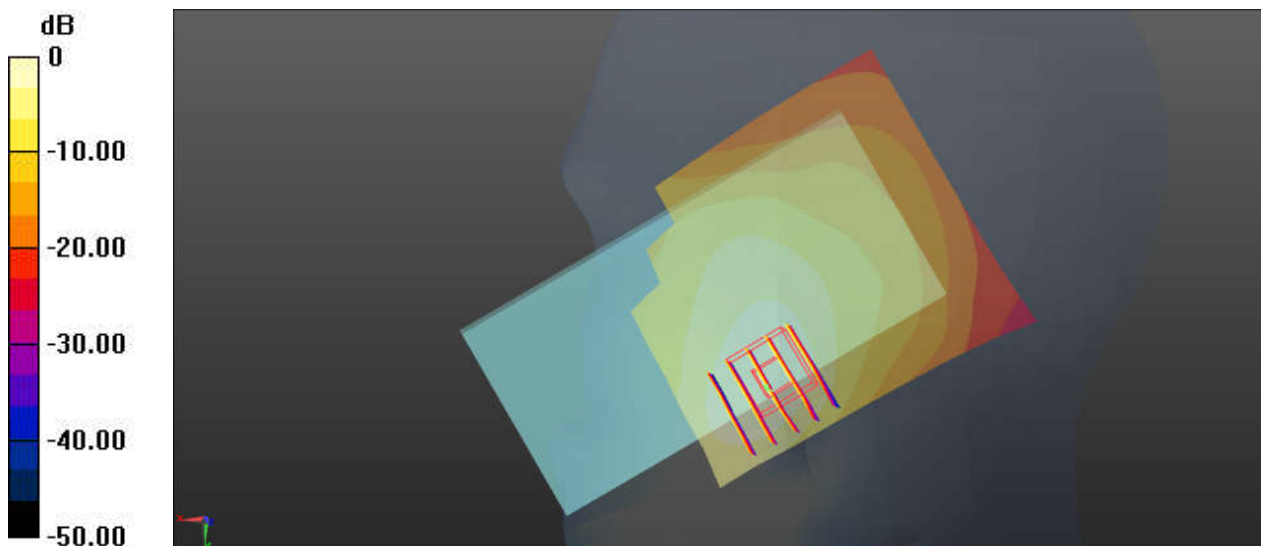

0 dB = 0.444 W/kg = -3.53 dBW/kg

14_LTE B25_20M_QPSK_1RB_0offset_Left Cheek_0mm_OFF_Ch26590

Communication System: UID 0, LTE-FDD (0); Frequency: 1905 MHz; Duty Cycle: 1:1
Medium: HSL_1900 Medium parameters used: $f = 1905$ MHz; $\sigma = 1.432$ S/m; $\epsilon_r = 38.709$; $\rho = 1000$ kg/m³
Ambient Temperature : 23.2 °C ; Liquid Temperature : 22.9 °C

DASY5 Configuration:

- Probe: ES3DV3 - SN3279; ConvF(5.35, 5.35, 5.35); Calibrated: 2019.3.4
- Sensor-Surface: 3mm (Mechanical Surface Detection)
- Electronics: DAE4 Sn1279; Calibrated: 2018.10.22
- Phantom: SAM2; Type: SAM; Serial: TP-1542
- Measurement SW: DASY52, Version 52.10 (1); SEMCAD X Version 14.6.11 (7439)

Ch26590/Area Scan (71x71x1): Interpolated grid: dx=1.500 mm, dy=1.500 mm

Maximum value of SAR (interpolated) = 0.736 W/kg

Ch26590/Zoom Scan (5x5x7)/Cube 0: Measurement grid: dx=8mm, dy=8mm, dz=5mm

Reference Value = 7.518 V/m; Power Drift = 0.10 dB

Peak SAR (extrapolated) = 0.857 W/kg

SAR(1 g) = 0.578 W/kg; SAR(10 g) = 0.369 W/kg

Maximum value of SAR (measured) = 0.672 W/kg

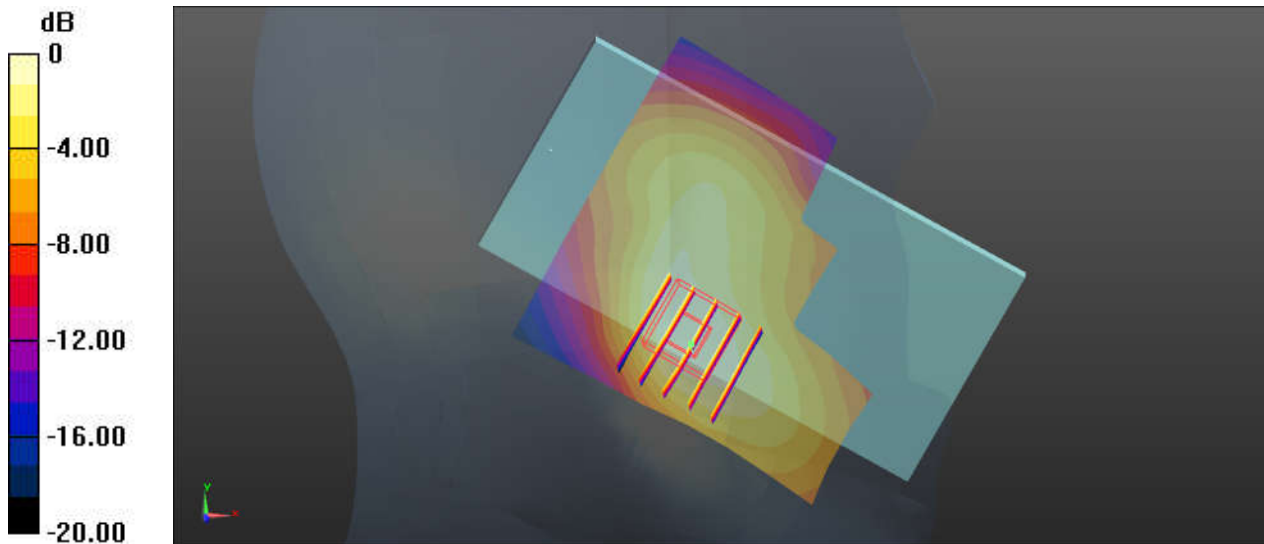

0 dB = 0.736 W/kg = -1.33 dBW/kg

15_LTE Band 41_20M_QPSK_1RB_49offset_Right Cheek_0mm_Ch41055_Power Class 2

Communication System: UID 0, LTE-TDD (0); Frequency: 2636.5 MHz; Duty Cycle: 1:2.33
 Medium: HSL_2600 Medium parameters used: $f = 2636.5$ MHz; $\sigma = 2.082$ S/m; $\epsilon_r = 38.743$; $\rho = 1000$ kg/m³

Ambient Temperature : 23.2 °C ; Liquid Temperature : 22.6 °C

DASY5 Configuration:

- Probe: ES3DV3 - SN3293; ConvF(4.44, 4.44, 4.44); Calibrated: 2018.10.25
- Sensor-Surface: 3mm (Mechanical Surface Detection)
- Electronics: DAE4 Sn1210; Calibrated: 2019.1.25
- Phantom: SAM2; Type: SAM; Serial: TP-1542
- Measurement SW: DASY52, Version 52.10 (1); SEMCAD X Version 14.6.11 (7439)

Ch41055/Area Scan (81x101x1): Interpolated grid: dx=1.200 mm, dy=1.200 mm
 Maximum value of SAR (interpolated) = 0.287 W/kg

Ch41055/Zoom Scan (7x7x7)/Cube 0: Measurement grid: dx=5mm, dy=5mm, dz=5mm

Reference Value = 2.078 V/m; Power Drift = 0.06 dB

Peak SAR (extrapolated) = 0.529 W/kg

SAR(1 g) = 0.246 W/kg; SAR(10 g) = 0.138 W/kg

Maximum value of SAR (measured) = 0.347 W/kg

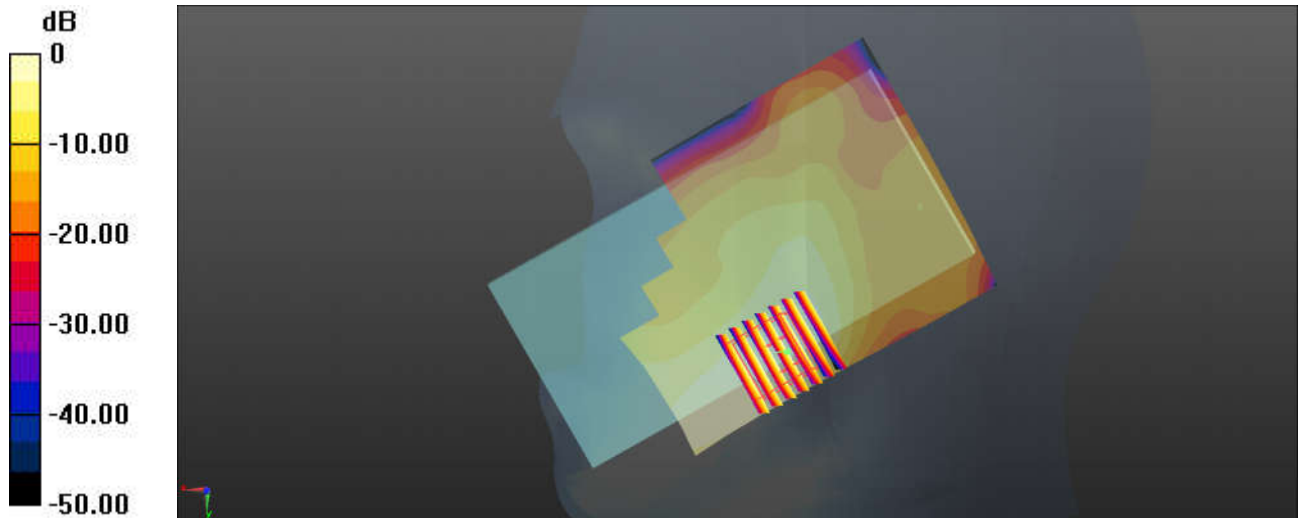

0 dB = 0.287 W/kg = -5.42 dBW/kg

16_WLAN2.4GHz_802.11b 1Mbps_Left Cheek_0mm_Ch11

Communication System: UID 0, 802.11b (0); Frequency: 2462 MHz; Duty Cycle: 1:1.025
Medium: HSL_2450 Medium parameters used: $f = 2462$ MHz; $\sigma = 1.86$ S/m; $\epsilon_r = 38.157$; $\rho = 1000$ kg/m³
Ambient Temperature : 23.5 °C; Liquid Temperature : 22.8 °C

DASY5 Configuration:

- Probe: ES3DV3 - SN3293; ConvF(4.53, 4.53, 4.53); Calibrated: 2018.10.25
- Sensor-Surface: 3mm (Mechanical Surface Detection)
- Electronics: DAE4 Sn1210; Calibrated: 2019.1.25
- Phantom: SAM2; Type: SAM; Serial: TP-1542
- Measurement SW: DASY52, Version 52.10 (1); SEMCAD X Version 14.6.11 (7439)

Ch11/Area Scan (91x101x1): Interpolated grid: dx=1.200 mm, dy=1.200 mm
Maximum value of SAR (interpolated) = 1.55 W/kg

Ch11/Zoom Scan (7x7x7)/Cube 0: Measurement grid: dx=5mm, dy=5mm, dz=5mm
Reference Value = 17.34 V/m; Power Drift = 0.07 dB
Peak SAR (extrapolated) = 2.83 W/kg
SAR(1 g) = 1.09 W/kg; SAR(10 g) = 0.466 W/kg
Maximum value of SAR (measured) = 1.47 W/kg

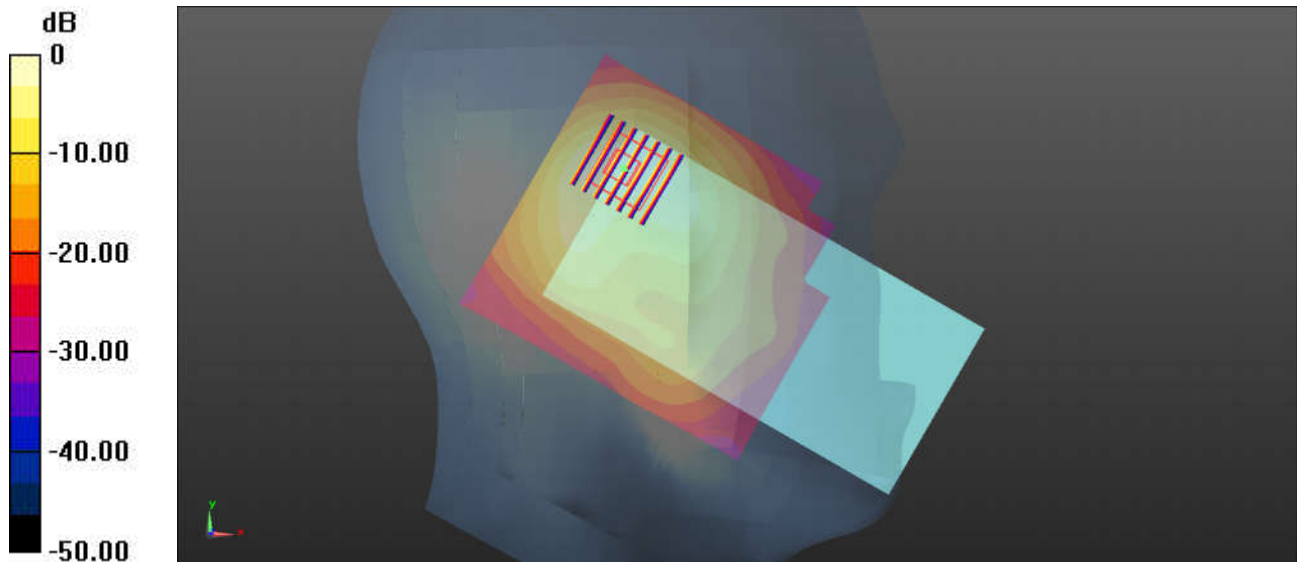

0 dB = 1.55 W/kg = 1.90 dBW/kg

17_WLAN5GHz_802.11a 6Mbps_Left Cheek_0mm_Ch64

Communication System: UID 0, WIFI (0); Frequency: 5320 MHz; Duty Cycle: 1:1.147
Medium: HSL_5000 Medium parameters used: $f = 5320$ MHz; $\sigma = 4.917$ S/m; $\epsilon_r = 36.871$; $\rho = 1000$ kg/m³
Ambient Temperature : 23.3 °C; Liquid Temperature : 22.6 °C

DASY5 Configuration:

- Probe: EX3DV4 - SN3857; ConvF(5.2, 5.2, 5.2); Calibrated: 2018.5.31;
- Sensor-Surface: 1.4mm (Mechanical Surface Detection)
- Electronics: DAE4 Sn1279; Calibrated: 2018.10.22
- Phantom: SAM1; Type: SAM; Serial: TP-1697
- Measurement SW: DASY52, Version 52.8 (8); SEMCAD X Version 14.6.10 (7372)

Ch64/Area Scan (111x81x1): Interpolated grid: dx=1.000 mm, dy=1.000 mm
Maximum value of SAR (interpolated) = 0.367 W/kg

Ch64/Zoom Scan (8x8x7)/Cube 0: Measurement grid: dx=4mm, dy=4mm, dz=1.4mm
Reference Value = 1.404 V/m; Power Drift = 0.09 dB
Peak SAR (extrapolated) = 0.250 W/kg
SAR(1 g) = 0.059 W/kg; SAR(10 g) = 0.017 W/kg
Maximum value of SAR (measured) = 0.162 W/kg

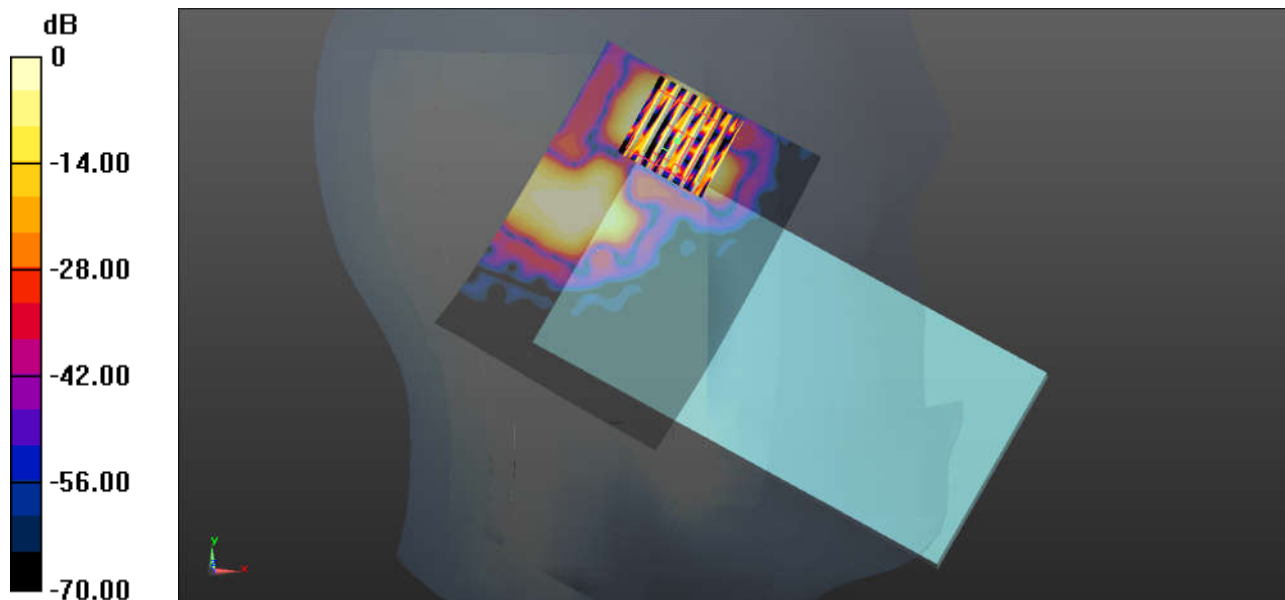

0 dB = 0.162 W/kg = -7.90 dBW/kg

18_WLAN5GHz_802.11a 6Mbps_Left Cheek_0mm_Ch116

Communication System: UID 0, WIFI (0); Frequency: 5580 MHz;Duty Cycle: 1:1.147
Medium: HSL_5000 Medium parameters used: $f = 5580$ MHz; $\sigma = 5.19$ S/m; $\epsilon_r = 36.492$; $\rho = 1000$ kg/m³
Ambient Temperature : 23.3 °C; Liquid Temperature : 22.8 °C

DASY5 Configuration:

- Probe: EX3DV4 - SN3857; ConvF(4.94, 4.94, 4.94); Calibrated: 2018.5.31;
- Sensor-Surface: 1.4mm (Mechanical Surface Detection)
- Electronics: DAE4 Sn1279; Calibrated: 2018.10.22
- Phantom: SAM1; Type: SAM; Serial: TP-1697
- Measurement SW: DASY52, Version 52.8 (8); SEMCAD X Version 14.6.10 (7372)

Ch116/Area Scan (111x81x1): Interpolated grid: dx=1.000 mm, dy=1.000 mm
Maximum value of SAR (interpolated) = 0.616 W/kg

Ch116/Zoom Scan (9x9x7)/Cube 0: Measurement grid: dx=4mm, dy=4mm, dz=1.4mm
Reference Value = 0 V/m; Power Drift = 0.01 dB
Peak SAR (extrapolated) = 0.597 W/kg
SAR(1 g) = 0.140 W/kg; SAR(10 g) = 0.037 W/kg
Maximum value of SAR (measured) = 0.369 W/kg

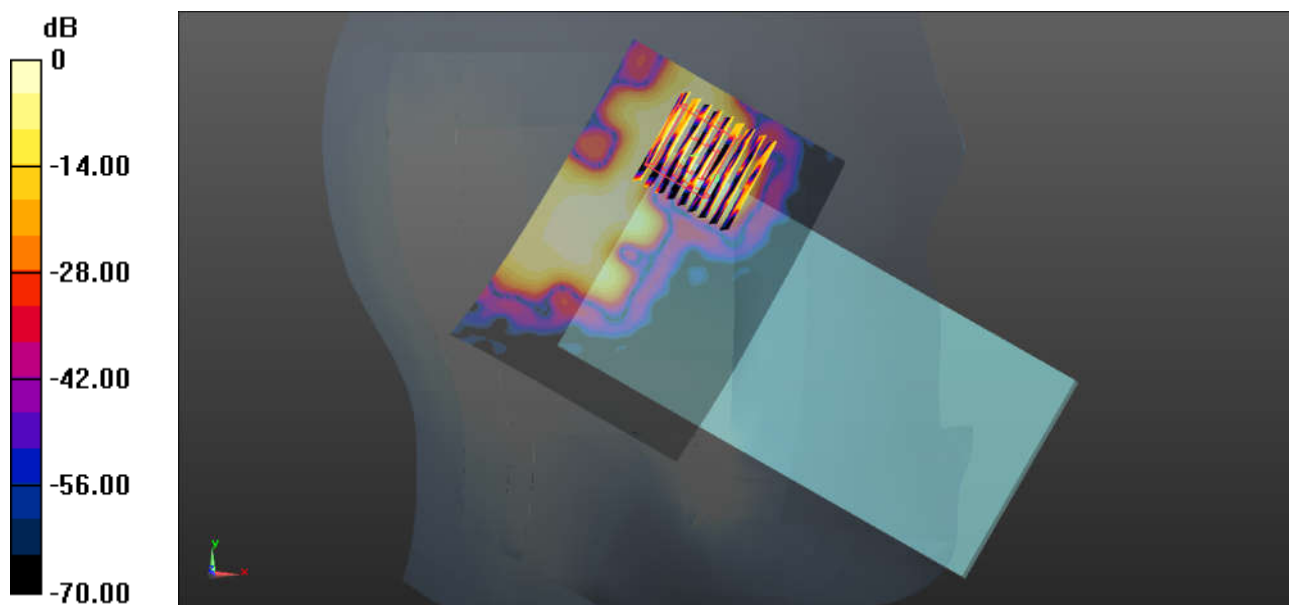

0 dB = 0.369 W/kg = -4.33 dBW/kg

19_WLAN5GHz_802.11a MCS0_Left Cheek_0mm_Ch165

Communication System: UID 0, WIFI (0); Frequency: 5825 MHz; Duty Cycle: 1:1.147
Medium: HSL_5000 Medium parameters used: $f = 5825$ MHz; $\sigma = 5.457$ S/m; $\epsilon_r = 36.13$; $\rho = 1000$ kg/m³
Ambient Temperature : 23.4 °C; Liquid Temperature : 22.7 °C

DASY5 Configuration:

- Probe: EX3DV4 - SN3857; ConvF(5.23, 5.23, 5.23); Calibrated: 2018.5.31;
- Sensor-Surface: 1.4mm (Mechanical Surface Detection)
- Electronics: DAE4 Sn1279; Calibrated: 2018.10.22
- Phantom: SAM1; Type: SAM; Serial: TP-1697
- Measurement SW: DASY52, Version 52.8 (8); SEMCAD X Version 14.6.10 (7372)

Ch165/Area Scan (111x81x1): Interpolated grid: dx=1.000 mm, dy=1.000 mm
Maximum value of SAR (interpolated) = 0.505 W/kg

Ch165/Zoom Scan (8x8x7)/Cube 0: Measurement grid: dx=4mm, dy=4mm, dz=1.4mm
Reference Value = 1.922 V/m; Power Drift = 0.05 dB
Peak SAR (extrapolated) = 0.705 W/kg
SAR(1 g) = 0.158 W/kg; SAR(10 g) = 0.043 W/kg
Maximum value of SAR (measured) = 0.431 W/kg

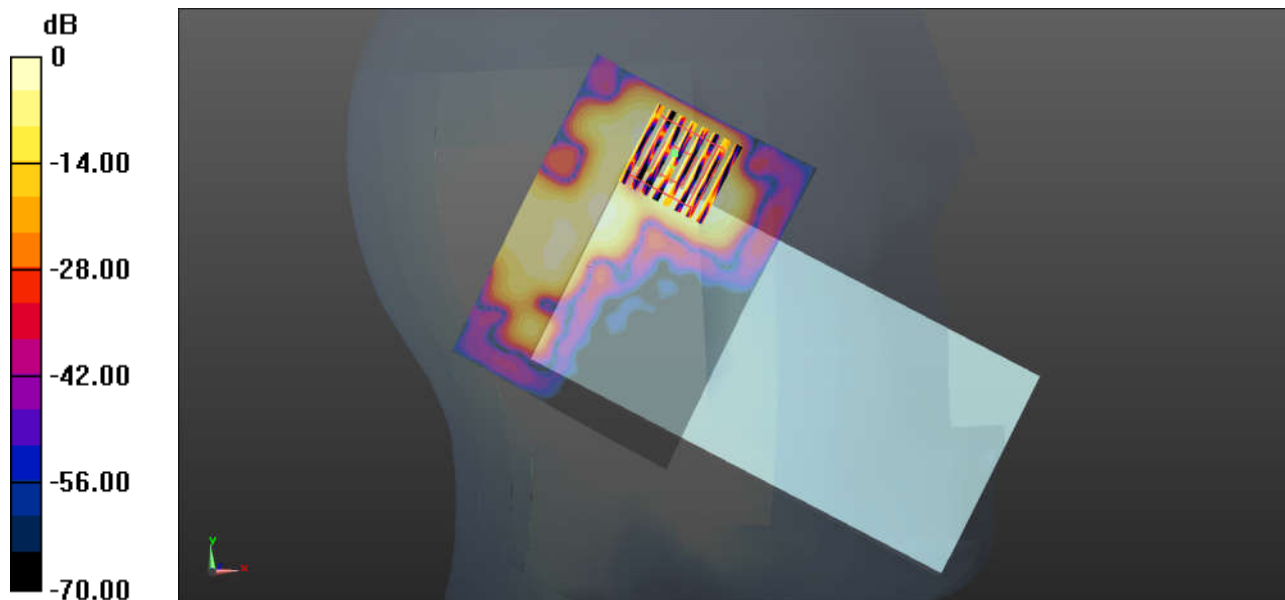

0 dB = 0.431 W/kg = -3.66 dBW/kg

20_Bluetooth_1Mbps_Left Cheek_0mm_Ant1_Ch78

Communication System: UID 0, Bluetooth (0); Frequency: 2480 MHz; Duty Cycle: 1:1.303
Medium: HSL_2450 Medium parameters used: $f = 2480$ MHz; $\sigma = 1.879$ S/m; $\epsilon_r = 38.087$; $\rho = 1000$ kg/m³
Ambient Temperature : 23.5 °C; Liquid Temperature : 22.8 °C

DASY5 Configuration:

- Probe: ES3DV3 - SN3293; ConvF(4.53, 4.53, 4.53); Calibrated: 2018.10.25
- Sensor-Surface: 3mm (Mechanical Surface Detection)
- Electronics: DAE4 Sn1210; Calibrated: 2019.1.25
- Phantom: SAM2; Type: SAM; Serial: TP-1542
- Measurement SW: DASY52, Version 52.10 (1); SEMCAD X Version 14.6.11 (7439)

Ch78/Area Scan (91x91x1): Interpolated grid: dx=1.200 mm, dy=1.200 mm

Maximum value of SAR (interpolated) = 0.227 W/kg

Ch78/Zoom Scan (7x7x7)/Cube 0: Measurement grid: dx=5mm, dy=5mm, dz=5mm

Reference Value = 6.604 V/m; Power Drift = 0.08 dB

Peak SAR (extrapolated) = 0.447 W/kg

SAR(1 g) = 0.174 W/kg; SAR(10 g) = 0.075 W/kg

Maximum value of SAR (measured) = 0.227 W/kg

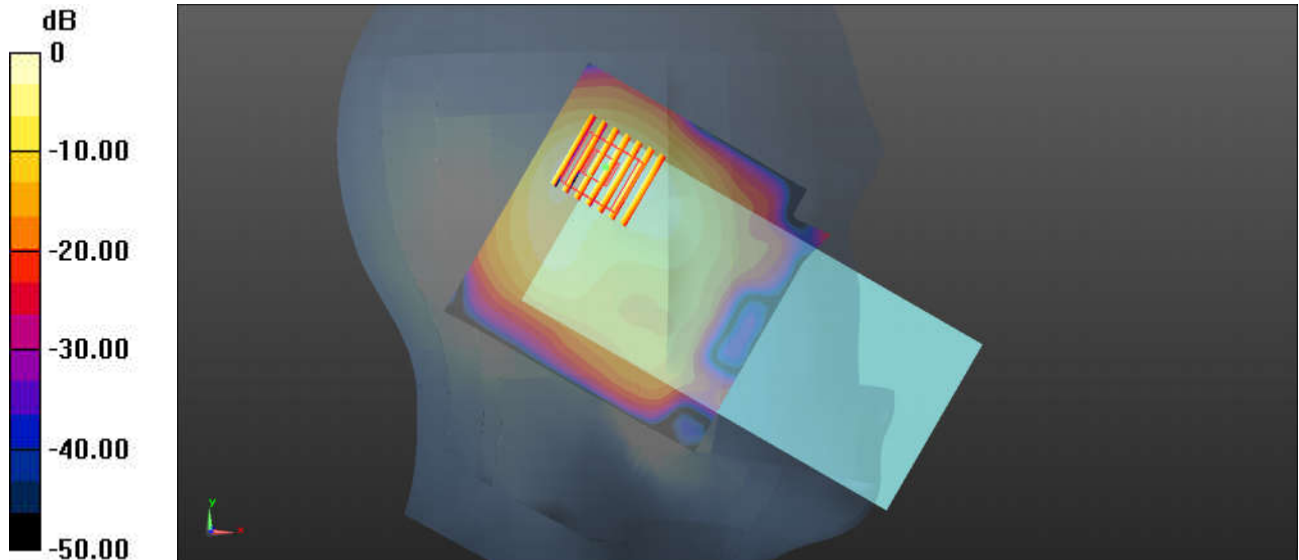

0 dB = 0.227 W/kg = -6.44 dBW/kg

21_GSM850_GPRS (4 Tx slots)_Back_5mm_OFF_Ch251

Communication System: UID 0, GSM850 (0); Frequency: 848.8 MHz; Duty Cycle: 1:2.08
Medium: HSL_850 Medium parameters used: $f = 848.8$ MHz; $\sigma = 0.915$ S/m; $\epsilon_r = 41.594$; $\rho = 1000$ kg/m³
Ambient Temperature : 23.2 °C; Liquid Temperature : 22.7 °C

DASY5 Configuration:

- Probe: ES3DV3 - SN3279; ConvF(6.38, 6.38, 6.38); Calibrated: 2019.3.4
- Sensor-Surface: 3mm (Mechanical Surface Detection)
- Electronics: DAE4 Sn1279; Calibrated: 2018.10.22
- Phantom: SAM2; Type: SAM; Serial: TP-1542
- Measurement SW: DASY52, Version 52.10 (1); SEMCAD X Version 14.6.11 (7439)

Ch251/Area Scan (71x91x1): Interpolated grid: dx=1.500 mm, dy=1.500 mm

Maximum value of SAR (interpolated) = 1.13 W/kg

Ch251/Zoom Scan (6x6x7)/Cube 0: Measurement grid: dx=8mm, dy=8mm, dz=5mm

Reference Value = 23.08 V/m; Power Drift = 0.04 dB

Peak SAR (extrapolated) = 1.67 W/kg

SAR(1 g) = 0.862 W/kg; SAR(10 g) = 0.512 W/kg

Maximum value of SAR (measured) = 1.06 W/kg

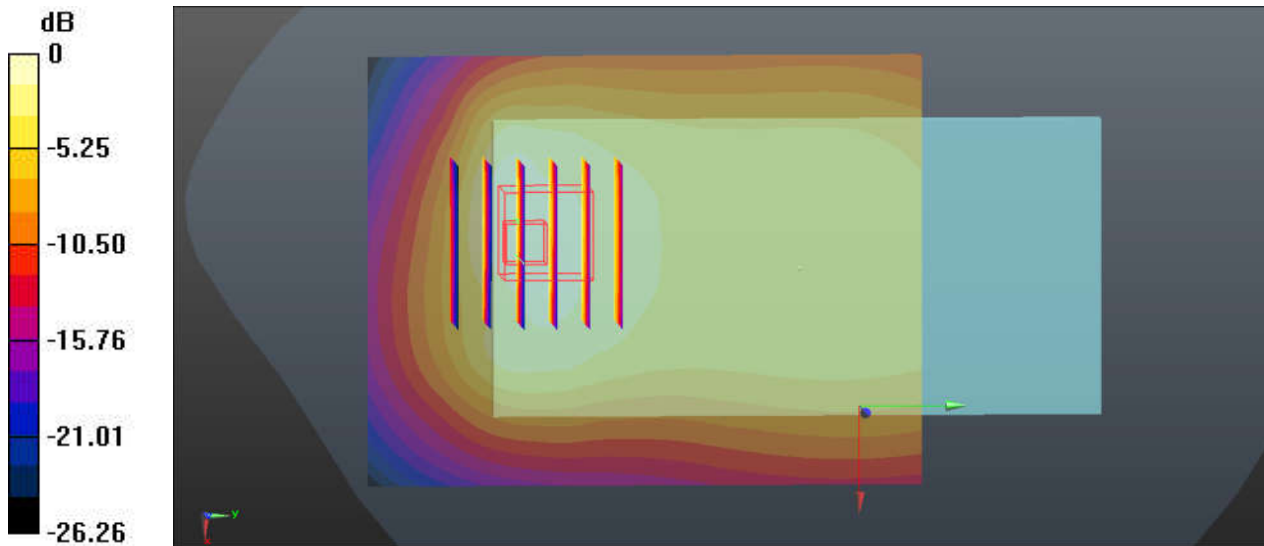

0 dB = 1.13 W/kg = 0.53 dBW/kg

22_GSM1900_GPRS (4 Tx slot)_Bottom side_5mm_Ch512

Communication System: UID 0, GPRS/EDGE (4 Tx slots) (0); Frequency: 1850.2 MHz; Duty Cycle: 1:2.08

Medium: HSL_1900 Medium parameters used: $f = 1850.2$ MHz; $\sigma = 1.378$ S/m; $\epsilon_r = 38.957$; $\rho = 1000$ kg/m³

Ambient Temperature : 23.2 °C ; Liquid Temperature : 22.9 °C

DASY5 Configuration:

- Probe: ES3DV3 - SN3279; ConvF(5.35, 5.35, 5.35); Calibrated: 2019.3.4
- Sensor-Surface: 3mm (Mechanical Surface Detection)
- Electronics: DAE4 Sn1279; Calibrated: 2018.10.22
- Phantom: SAM2; Type: SAM; Serial: TP-1542
- Measurement SW: DASY52, Version 52.10 (1); SEMCAD X Version 14.6.11 (7439)

Ch512/Area Scan (41x71x1): Interpolated grid: dx=1.500 mm, dy=1.500 mm

Maximum value of SAR (interpolated) = 1.54 W/kg

Ch512/Zoom Scan (5x5x7)/Cube 0: Measurement grid: dx=8mm, dy=8mm, dz=5mm

Reference Value = 17.49 V/m; Power Drift = 0.02 dB

Peak SAR (extrapolated) = 2.11 W/kg

SAR(1 g) = 1.17 W/kg; SAR(10 g) = 0.600 W/kg

Maximum value of SAR (measured) = 1.43 W/kg

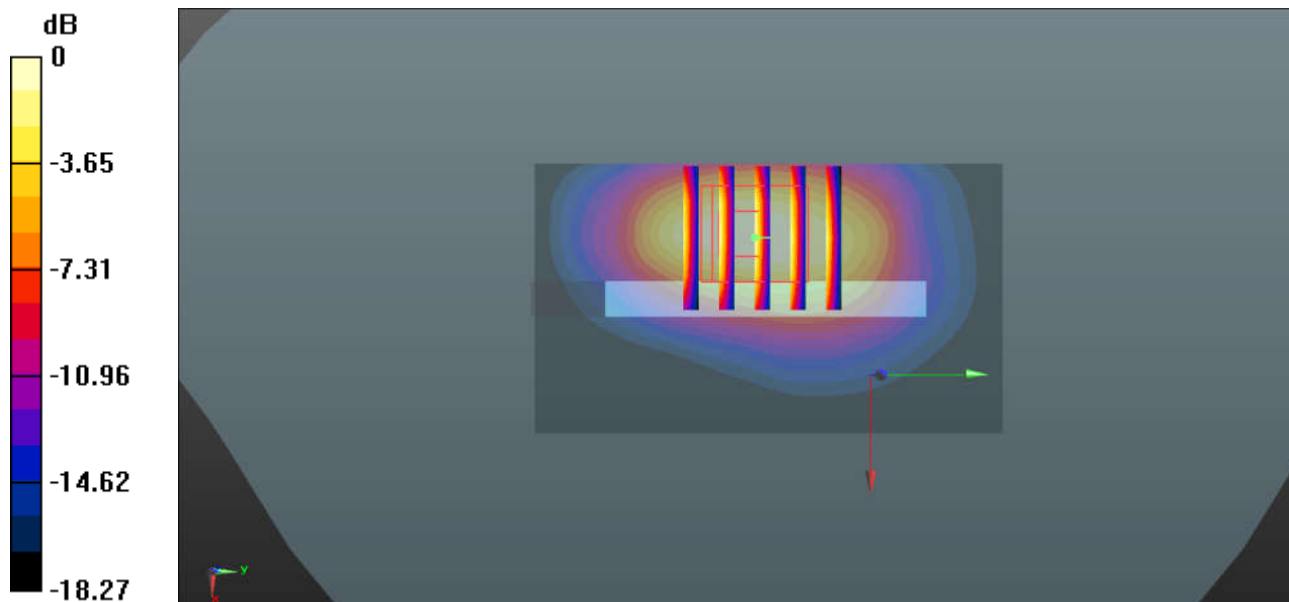

0 dB = 1.43 W/kg = 1.55 dBW/kg

23_WCDMA V_RMC 12.2Kbps_Left Side_5mm_OFF_Ch4233

Communication System: UID 0, WCDMA (0); Frequency: 846.6 MHz; Duty Cycle: 1:1
Medium: HSL_850 Medium parameters used: $f = 846.6 \text{ MHz}$; $\sigma = 0.913 \text{ S/m}$; $\epsilon_r = 41.611$; $\rho = 1000 \text{ kg/m}^3$
Ambient Temperature : $23.2 \text{ }^\circ\text{C}$; Liquid Temperature : $22.7 \text{ }^\circ\text{C}$

DASY5 Configuration:

- Probe: ES3DV3 - SN3279; ConvF(6.38, 6.38, 6.38); Calibrated: 2019.3.4
- Sensor-Surface: 3mm (Mechanical Surface Detection)
- Electronics: DAE4 Sn1279; Calibrated: 2018.10.22
- Phantom: SAM2; Type: SAM; Serial: TP-1542
- Measurement SW: DASY52, Version 52.10 (1); SEMCAD X Version 14.6.11 (7439)

Ch4233/Area Scan (41x111x1): Interpolated grid: $dx=1.500 \text{ mm}$, $dy=1.500 \text{ mm}$

Maximum value of SAR (interpolated) = 1.01 W/kg

Ch4233/Zoom Scan (5x5x7)/Cube 0: Measurement grid: $dx=8\text{mm}$, $dy=8\text{mm}$, $dz=5\text{mm}$

Reference Value = 33.08 V/m ; Power Drift = 0.10 dB

Peak SAR (extrapolated) = 1.32 W/kg

SAR(1 g) = 0.878 W/kg ; SAR(10 g) = 0.580 W/kg

Maximum value of SAR (measured) = 1.03 W/kg

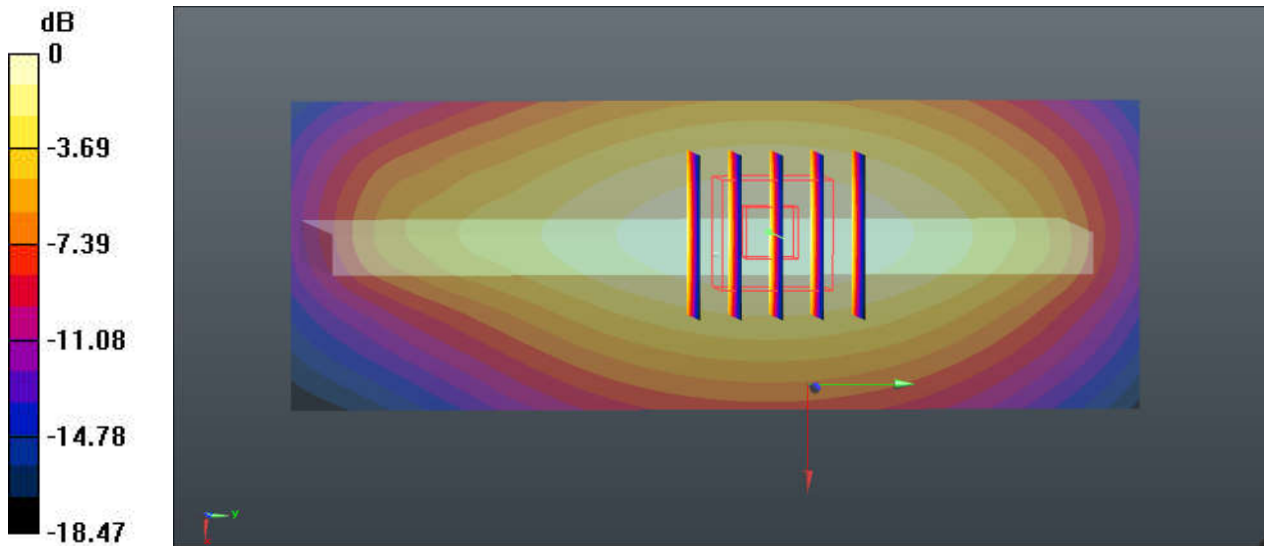

0 dB = 1.01 W/kg = 0.04 dBW/kg

24_WCDMA IV_RMC12.2Kbps_Back_5mm_Ch1312

Communication System: UID 0, WCDMA (0); Frequency: 1712.4 MHz; Duty Cycle: 1:1
Medium: HSL_1750 Medium parameters used: $f = 1712.4$ MHz; $\sigma = 1.311$ S/m; $\epsilon_r = 40.397$; $\rho = 1000$ kg/m³
Ambient Temperature : 23.3 °C ; Liquid Temperature : 22.8 °C

DASY5 Configuration:

- Probe: ES3DV3 - SN3279; ConvF(5.59, 5.59, 5.594); Calibrated: 2019.3.4
- Sensor-Surface: 3mm (Mechanical Surface Detection)
- Electronics: DAE4 Sn1279; Calibrated: 2018.10.22
- Phantom: SAM2; Type: SAM; Serial: TP-1542
- Measurement SW: DASY52, Version 52.10 (1); SEMCAD X Version 14.6.11 (7439)

Ch1312/Area Scan (71x81x1): Interpolated grid: dx=1.500 mm, dy=1.500 mm
Maximum value of SAR (interpolated) = 1.28 W/kg

Ch1312/Zoom Scan (5x5x7)/Cube 0: Measurement grid: dx=8mm, dy=8mm, dz=5mm
Reference Value = 0 V/m; Power Drift = 0.03 dB
Peak SAR (extrapolated) = 2.37 W/kg
SAR(1 g) = 1.1 W/kg; SAR(10 g) = 0.505 W/kg
Maximum value of SAR (measured) = 1.35 W/kg

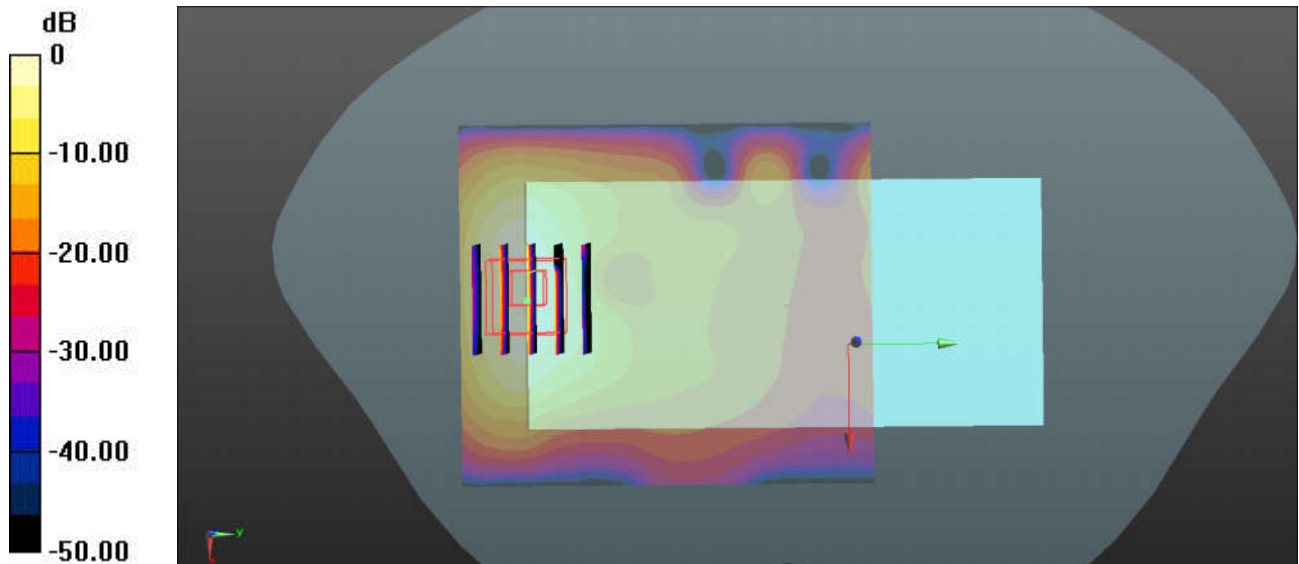

0 dB = 1.28 W/kg = 1.07 dBW/kg

25_WCDMA II_RMC 12.2Kbps_Back_5mm_Ch9538

Communication System: UID 0, UMTS (0); Frequency: 1907.6 MHz; Duty Cycle: 1:1
 Medium: HSL_1900 Medium parameters used: $f = 1907.6$ MHz; $\sigma = 1.436$ S/m; $\epsilon_r = 38.693$; $\rho = 1000$ kg/m³
 Ambient Temperature : 23.2 °C ; Liquid Temperature : 22.9 °C

DASY5 Configuration:

- Probe: ES3DV3 - SN3279; ConvF(5.35, 5.35, 5.35); Calibrated: 2019.3.4
- Sensor-Surface: 3mm (Mechanical Surface Detection)
- Electronics: DAE4 Sn1279; Calibrated: 2018.10.22
- Phantom: SAM2; Type: SAM; Serial: TP-1542
- Measurement SW: DASY52, Version 52.10 (1); SEMCAD X Version 14.6.11 (7439)

Ch9538/Area Scan (71x71x1): Interpolated grid: dx=1.500 mm, dy=1.500 mm
 Maximum value of SAR (interpolated) = 1.35 W/kg

Ch9538/Zoom Scan (5x5x7)/Cube 0: Measurement grid: dx=8mm, dy=8mm, dz=5mm
 Reference Value = 11.69 V/m; Power Drift = 0.08 dB
 Peak SAR (extrapolated) = 2.27 W/kg
SAR(1 g) = 1.07 W/kg; SAR(10 g) = 0.540 W/kg
 Maximum value of SAR (measured) = 1.44 W/kg

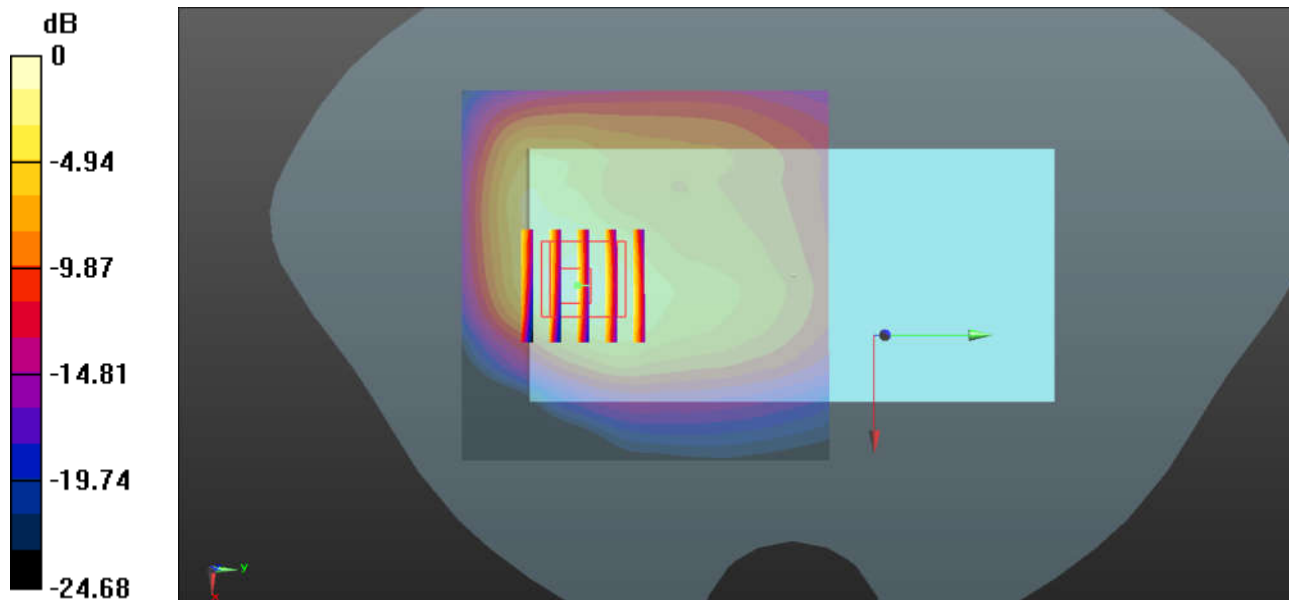

0 dB = 1.44 W/kg = 1.58 dBW/kg

26_CDMA2000 BC0_RTAP 153.6Kbps_Left side_5mm_OFF_Ch384

Communication System: UID 0, CDMA (0); Frequency: 836.52 MHz; Duty Cycle: 1:1
Medium: HSL_850 Medium parameters used: $f = 836.52$ MHz; $\sigma = 0.904$ S/m; $\epsilon_r = 41.753$; $\rho = 1000$ kg/m³
Ambient Temperature : 23.2 °C; Liquid Temperature : 22.7 °C

DASY5 Configuration:

- Probe: ES3DV3 - SN3279; ConvF(6.38, 6.38, 6.38); Calibrated: 2019.3.4
- Sensor-Surface: 3mm (Mechanical Surface Detection)
- Electronics: DAE4 Sn1279; Calibrated: 2018.10.22
- Phantom: SAM2; Type: SAM; Serial: TP-1542
- Measurement SW: DASY52, Version 52.10 (1); SEMCAD X Version 14.6.11 (7439)

Ch384/Area Scan (41x81x1): Interpolated grid: dx=1.500 mm, dy=1.500 mm

Maximum value of SAR (interpolated) = 1.02 W/kg

Ch384/Zoom Scan (5x5x7)/Cube 0: Measurement grid: dx=8mm, dy=8mm, dz=5mm

Reference Value = 33.80 V/m; Power Drift = 0.06 dB

Peak SAR (extrapolated) = 1.31 W/kg

SAR(1 g) = 0.871 W/kg; SAR(10 g) = 0.575 W/kg

Maximum value of SAR (measured) = 1.02 W/kg

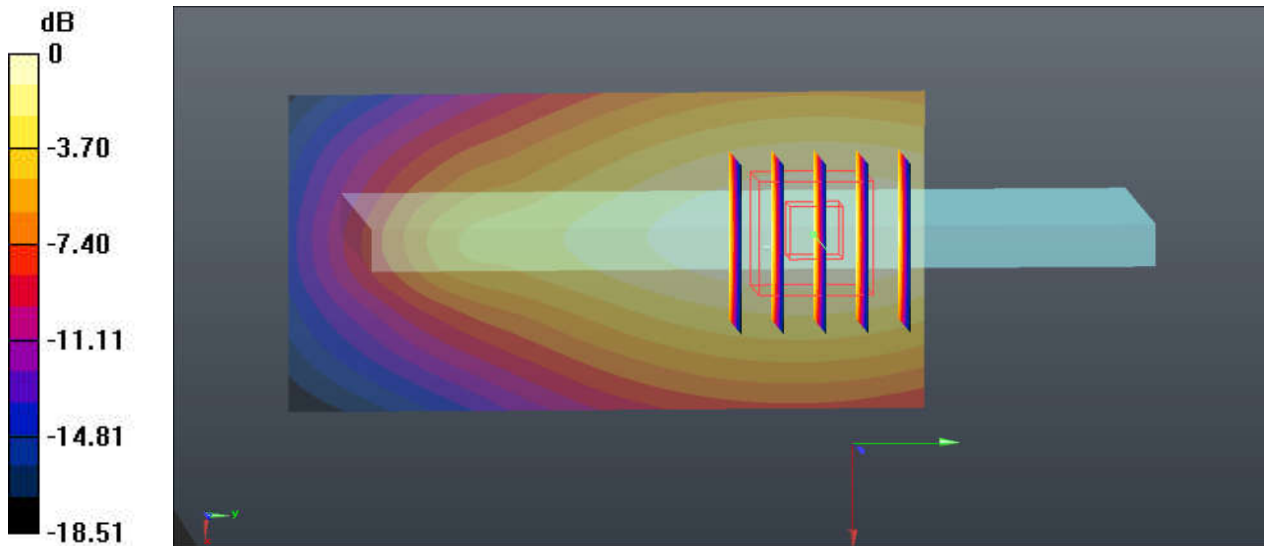

0 dB = 1.02 W/kg = 0.09 dBW/kg

27_CDMA2000 BC10_RTAP 153.6Kbps_Left side_5mm_OFF_Ch684

Communication System: UID 0, CDMA (0); Frequency: 823.1 MHz; Duty Cycle: 1:1
Medium: HSL_850 Medium parameters used: $f = 823.1$ MHz; $\sigma = 0.892$ S/m; $\epsilon_r = 41.936$; $\rho = 1000$ kg/m³
Ambient Temperature : 23.2 °C ; Liquid Temperature : 22.7 °C

DASY5 Configuration:

- Probe: ES3DV3 - SN3279; ConvF(6.38, 6.38, 6.38); Calibrated: 2019.3.4
- Sensor-Surface: 3mm (Mechanical Surface Detection)
- Electronics: DAE4 Sn1279; Calibrated: 2018.10.22
- Phantom: SAM2; Type: SAM; Serial: TP-1542
- Measurement SW: DASY52, Version 52.10 (1); SEMCAD X Version 14.6.11 (7439)

Ch684/Area Scan (41x81x1): Interpolated grid: dx=1.500 mm, dy=1.500 mm
Maximum value of SAR (interpolated) = 1.07 W/kg

Ch684/Zoom Scan (5x5x7)/Cube 0: Measurement grid: dx=8mm, dy=8mm, dz=5mm
Reference Value = 35.20 V/m; Power Drift = 0.10 dB
Peak SAR (extrapolated) = 1.40 W/kg
SAR(1 g) = 0.935 W/kg; SAR(10 g) = 0.620 W/kg
Maximum value of SAR (measured) = 1.09 W/kg

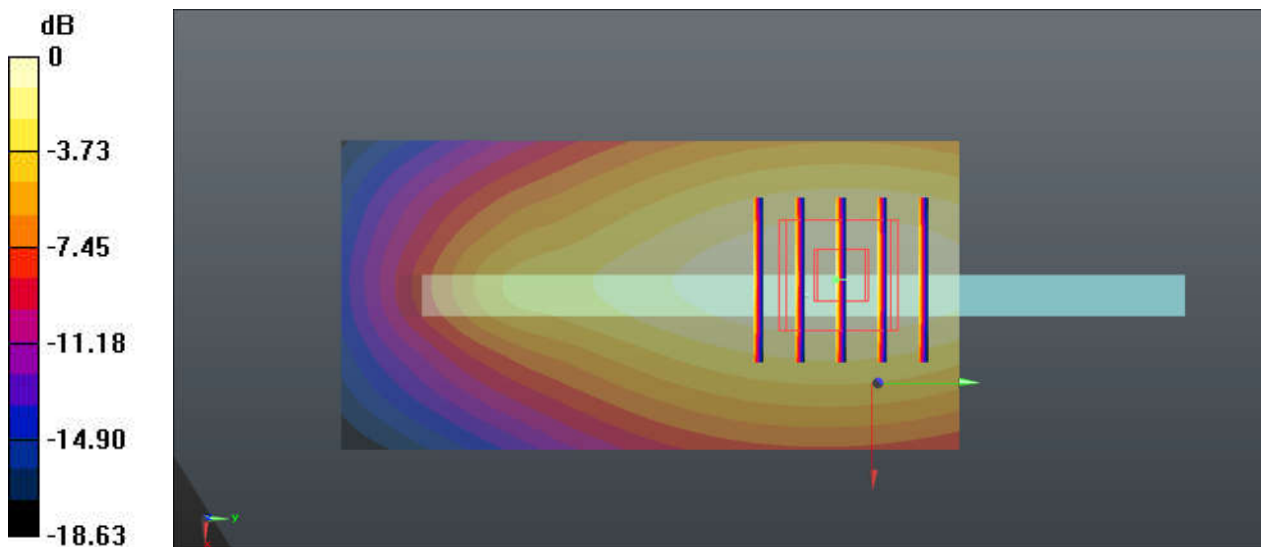

0 dB = 1.07 W/kg = 0.29 dBW/kg

28_CDMA2000 BC1_RTAP 153.6Kbps_Back_5mm_Sensor On_Ch1175

Communication System: UID 0, CDMA (0); Frequency: 1908.75 MHz; Duty Cycle: 1:1
Medium: HSL_1900 Medium parameters used: $f = 1908.75$ MHz; $\sigma = 1.437$ S/m; $\epsilon_r = 38.688$; $\rho = 1000$ kg/m³
Ambient Temperature : 23.2 °C ; Liquid Temperature : 22.9 °C

DASY5 Configuration:

- Probe: ES3DV3 - SN3279; ConvF(5.35, 5.35, 5.35); Calibrated: 2019.3.4
- Sensor-Surface: 3mm (Mechanical Surface Detection)
- Electronics: DAE4 Sn1279; Calibrated: 2018.10.22
- Phantom: SAM2; Type: SAM; Serial: TP-1542
- Measurement SW: DASY52, Version 52.10 (1); SEMCAD X Version 14.6.11 (7439)

Ch1175/Area Scan (71x81x1): Interpolated grid: dx=1.500 mm, dy=1.500 mm

Maximum value of SAR (interpolated) = 1.71 W/kg

Ch1175/Zoom Scan (5x5x7)/Cube 0: Measurement grid: dx=8mm, dy=8mm, dz=5mm

Reference Value = 10.74 V/m; Power Drift = -0.08 dB

Peak SAR (extrapolated) = 2.66 W/kg

SAR(1 g) = 1.23 W/kg; SAR(10 g) = 0.596 W/kg

Maximum value of SAR (measured) = 1.67 W/kg

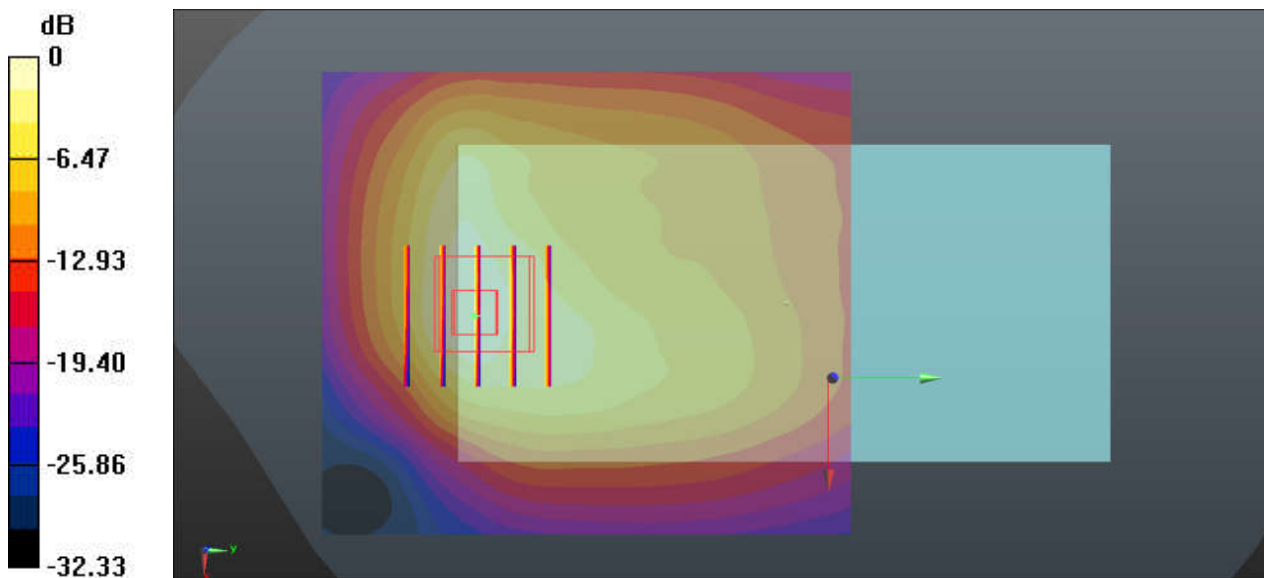

0 dB = 1.71 W/kg = 2.33 dBW/kg

29_LTE B71_20M_QPSK_1RB_0offset_Back_5mm_OFF_Ch133322

Communication System: UID 0, LTE-FDD (0); Frequency: 683 MHz;Duty Cycle: 1:1
Medium: HSL_750 Medium parameters used: f = 683 MHz; $\sigma = 0.835$ S/m; $\epsilon_r = 42.538$; $\rho = 1000$ kg/m³
Ambient Temperature : 23.1 °C; Liquid Temperature : 22.8 °C

DASY5 Configuration:

- Probe: ES3DV3 - SN3279; ConvF(6.58, 6.58, 6.58); Calibrated: 2019.3.4
- Sensor-Surface: 3mm (Mechanical Surface Detection)
- Electronics: DAE4 Sn1279; Calibrated: 2018.10.22
- Phantom: SAM2; Type: SAM; Serial: TP-1542
- Measurement SW: DASY52, Version 52.10 (1); SEMCAD X Version 14.6.11 (7439)

Ch133322/Area Scan (71x61x1): Interpolated grid: dx=1.500 mm, dy=1.500 mm
Maximum value of SAR (interpolated) = 0.739 W/kg

Ch133322/Zoom Scan (5x5x7)/Cube 0: Measurement grid: dx=8mm, dy=8mm, dz=5mm
Reference Value = 22.34 V/m; Power Drift = -0.04 dB
Peak SAR (extrapolated) = 1.08 W/kg
SAR(1 g) = 0.529 W/kg; SAR(10 g) = 0.322 W/kg
Maximum value of SAR (measured) = 0.631 W/kg

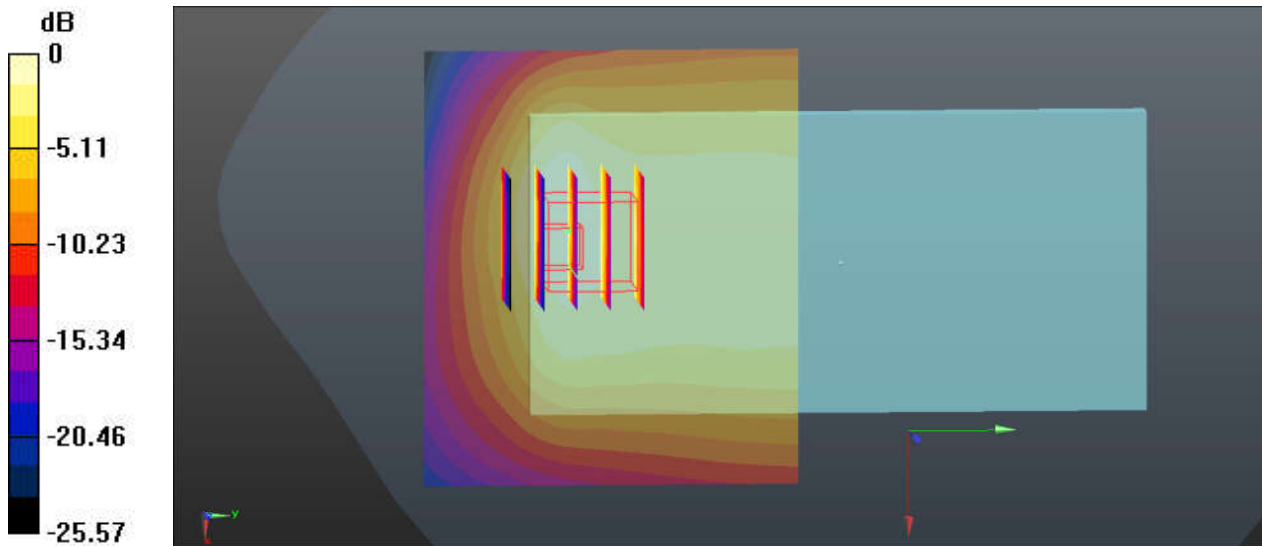

0 dB = 0.739 W/kg = -1.31 dBW/kg

30_LTE B12_10M_QPSK_1RB_0offset_Left Side_5mm_OFF_Ch23095

Communication System: UID 0, LTE-FDD (0); Frequency: 707.5 MHz; Duty Cycle: 1:1
Medium: HSL_750 Medium parameters used: $f = 707.5$ MHz; $\sigma = 0.858$ S/m; $\epsilon_r = 42.2$; $\rho = 1000$ kg/m³
Ambient Temperature : 23.1 °C ; Liquid Temperature : 22.8 °C

DASY5 Configuration:

- Probe: ES3DV3 - SN3279; ConvF(6.58, 6.58, 6.58); Calibrated: 2019.3.4
- Sensor-Surface: 3mm (Mechanical Surface Detection)
- Electronics: DAE4 Sn1279; Calibrated: 2018.10.22
- Phantom: SAM2; Type: SAM; Serial: TP-1542
- Measurement SW: DASY52, Version 52.10 (1); SEMCAD X Version 14.6.11 (7439)

Ch23095/Area Scan (41x91x1): Interpolated grid: dx=1.500 mm, dy=1.500 mm

Maximum value of SAR (interpolated) = 0.867 W/kg

Ch23095/Zoom Scan (5x5x7)/Cube 0: Measurement grid: dx=8mm, dy=8mm, dz=5mm

Reference Value = 32.45 V/m; Power Drift = 0.01 dB

Peak SAR (extrapolated) = 1.07 W/kg

SAR(1 g) = 0.739 W/kg; SAR(10 g) = 0.510 W/kg

Maximum value of SAR (measured) = 0.852 W/kg

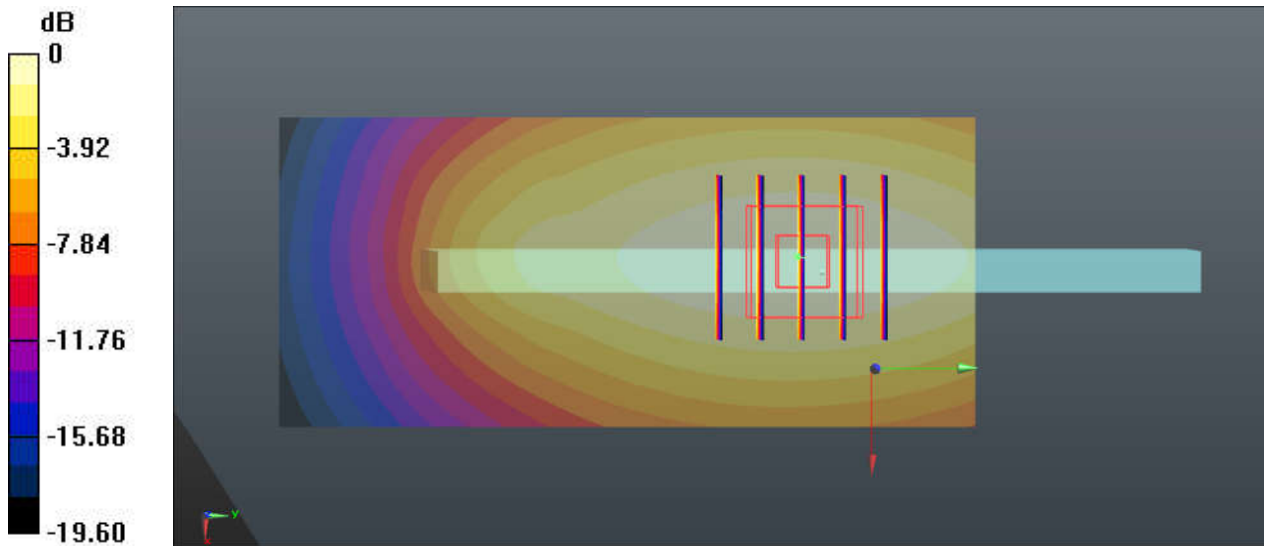

0 dB = 0.867 W/kg = -0.62 dBW/kg

31_LTE B13_10M_QPSK_1RB_0offset_Right Side_5mm_OFF_Ch23230

Communication System: UID 0, LTE-FDD (0); Frequency: 782 MHz; Duty Cycle: 1:1
Medium: HSL_750 Medium parameters used: $f = 782 \text{ MHz}$; $\sigma = 0.926 \text{ S/m}$; $\epsilon_r = 41.246$; $\rho = 1000 \text{ kg/m}^3$
Ambient Temperature : $23.1 \text{ }^\circ\text{C}$; Liquid Temperature : $22.8 \text{ }^\circ\text{C}$

DASY5 Configuration:

- Probe: ES3DV3 - SN3279; ConvF(6.58, 6.58, 6.58); Calibrated: 2019.3.4
- Sensor-Surface: 3mm (Mechanical Surface Detection)
- Electronics: DAE4 Sn1279; Calibrated: 2018.10.22
- Phantom: SAM2; Type: SAM; Serial: TP-1542
- Measurement SW: DASY52, Version 52.10 (1); SEMCAD X Version 14.6.11 (7439)

Ch23230/Area Scan (41x101x1): Interpolated grid: $dx=1.500 \text{ mm}$, $dy=1.500 \text{ mm}$

Maximum value of SAR (interpolated) = 1.22 W/kg

Ch23230/Zoom Scan (5x5x7)/Cube 0: Measurement grid: $dx=8\text{mm}$, $dy=8\text{mm}$, $dz=5\text{mm}$

Reference Value = 37.10 V/m ; Power Drift = 0.01 dB

Peak SAR (extrapolated) = 1.55 W/kg

SAR(1 g) = 1.05 W/kg ; SAR(10 g) = 0.712 W/kg

Maximum value of SAR (measured) = 1.22 W/kg

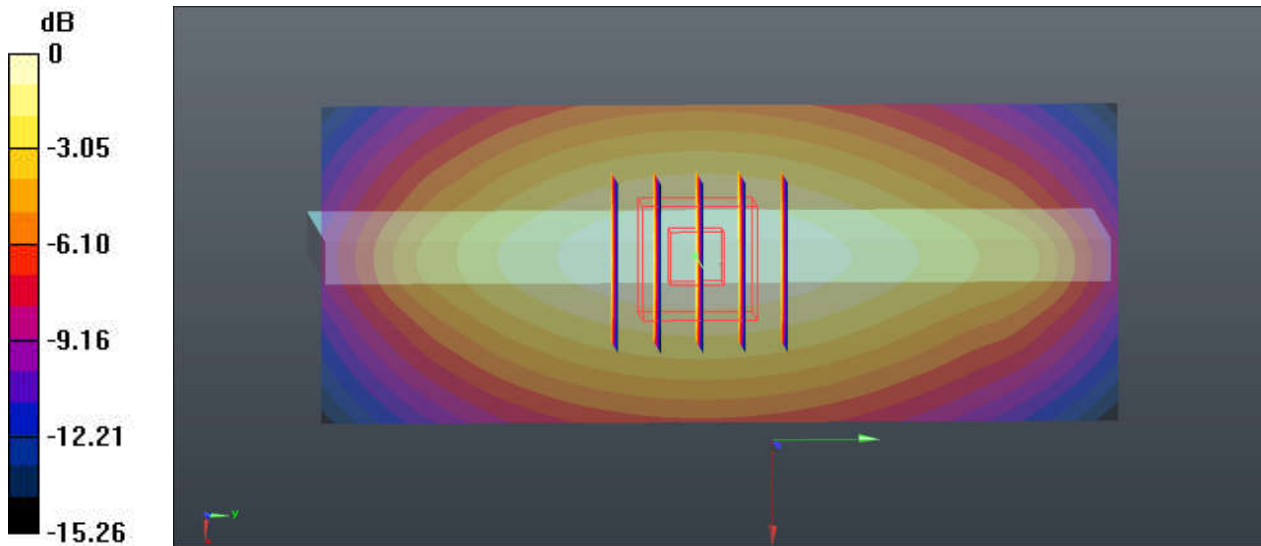

0 dB = $1.22 \text{ W/kg} = 0.86 \text{ dBW/kg}$

32_LTE B26_15M_QPSK_1RB_74offset_Left Side_5mm_OFF_Ch26865

Communication System: UID 0, LTE-FDD (0); Frequency: 831.5 MHz; Duty Cycle: 1:1
Medium: HSL_850 Medium parameters used: $f = 831.5 \text{ MHz}$; $\sigma = 0.899 \text{ S/m}$; $\epsilon_r = 41.825$; $\rho = 1000 \text{ kg/m}^3$
Ambient Temperature : $23.2 \text{ }^\circ\text{C}$; Liquid Temperature : $22.7 \text{ }^\circ\text{C}$

DASY5 Configuration:

- Probe: ES3DV3 - SN3279; ConvF(6.38, 6.38, 6.38); Calibrated: 2019.3.4
- Sensor-Surface: 3mm (Mechanical Surface Detection)
- Electronics: DAE4 Sn1279; Calibrated: 2018.10.22
- Phantom: SAM2; Type: SAM; Serial: TP-1542
- Measurement SW: DASY52, Version 52.10 (1); SEMCAD X Version 14.6.11 (7439)

Ch26865/Area Scan (41x101x1): Interpolated grid: $dx=1.500 \text{ mm}$, $dy=1.500 \text{ mm}$
Maximum value of SAR (interpolated) = 0.997 W/kg

Ch26865/Zoom Scan (5x5x7)/Cube 0: Measurement grid: $dx=8\text{mm}$, $dy=8\text{mm}$, $dz=5\text{mm}$
Reference Value = 33.69 V/m ; Power Drift = 0.01 dB
Peak SAR (extrapolated) = 1.25 W/kg
SAR(1 g) = 0.841 W/kg ; SAR(10 g) = 0.557 W/kg
Maximum value of SAR (measured) = 0.988 W/kg

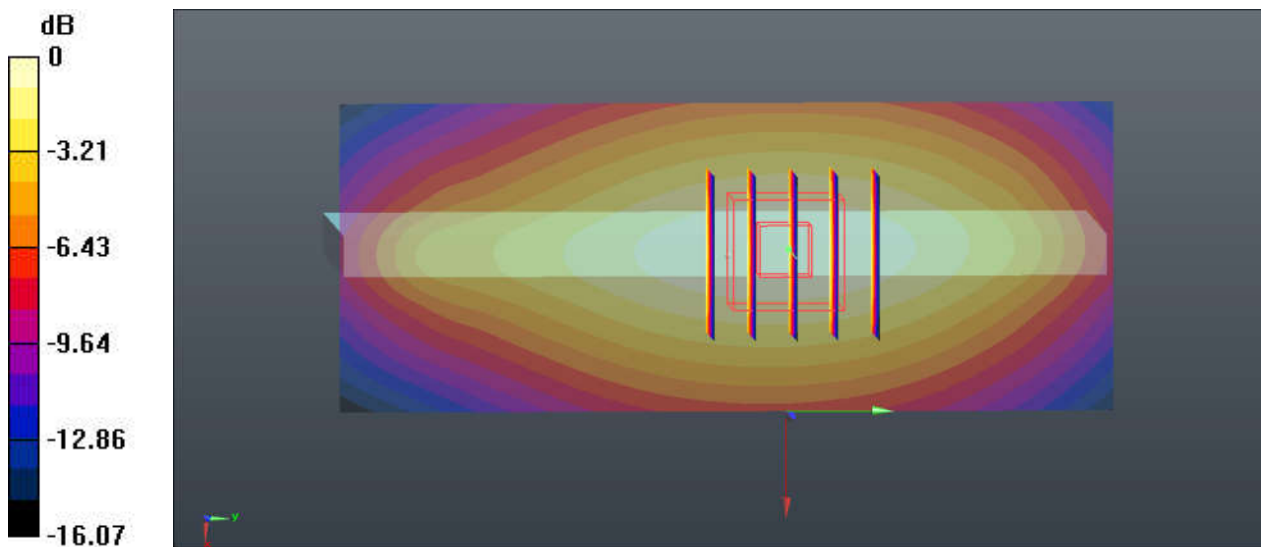

0 dB = $0.997 \text{ W/kg} = -0.01 \text{ dBW/kg}$

33_LTE Band 66_20M_QPSK_50RB_24offset_Back_5mm_Ch132072

Communication System: UID 0, LTE-FDD (0); Frequency: 1720 MHz; Duty Cycle: 1:1

Medium: HSL_1750 Medium parameters used: $f = 1720$ MHz; $\sigma = 1.32$ S/m; $\epsilon_r = 40.628$; $\rho = 1000$ kg/m³

Ambient Temperature : 23.3 °C; Liquid Temperature : 22.8 °C

DASY5 Configuration:

- Probe: ES3DV3 - SN3279; ConvF(5.59, 5.59, 5.59); Calibrated: 2019.3.4
- Sensor-Surface: 3mm (Mechanical Surface Detection)
- Electronics: DAE4 Sn1279; Calibrated: 2018.10.22
- Phantom: SAM2; Type: SAM; Serial: TP-1542
- Measurement SW: DASY52, Version 52.10 (1); SEMCAD X Version 14.6.11 (7439)

Ch132072/Area Scan (71x81x1): Interpolated grid: dx=1.500 mm, dy=1.500 mm

Maximum value of SAR (interpolated) = 1.23 W/kg

Ch132072/Zoom Scan (5x5x7)/Cube 0: Measurement grid: dx=8mm, dy=8mm, dz=5mm

Reference Value = 2.894 V/m; Power Drift = 0.01 dB

Peak SAR (extrapolated) = 1.97 W/kg

SAR(1 g) = 1.01 W/kg; SAR(10 g) = 0.496 W/kg

Maximum value of SAR (measured) = 1.30 W/kg

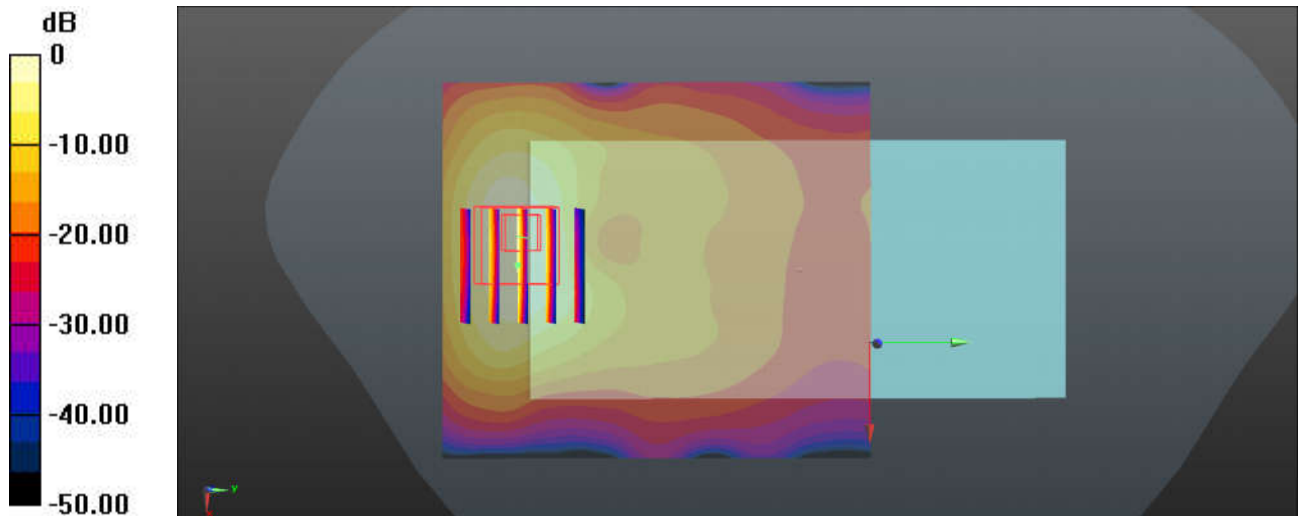

0 dB = 1.23 W/kg = 0.90 dBW/kg

34_LTE Band 25_20M_QPSK_1RB_0offset_Back_5mm_Ch26140

Communication System: UID 0, FDD_LTE (0); Frequency: 1860 MHz; Duty Cycle: 1:1
Medium: HSL_1900 Medium parameters used: $f = 1860$ MHz; $\sigma = 1.388$ S/m; $\epsilon_r = 38.923$; $\rho = 1000$ kg/m³
Ambient Temperature : 23.2 °C; Liquid Temperature : 22.9 °C

DASY5 Configuration:

- Probe: ES3DV3 - SN3279; ConvF(5.35, 5.35, 5.35); Calibrated: 2019.3.4
- Sensor-Surface: 3mm (Mechanical Surface Detection)
- Electronics: DAE4 Sn1279; Calibrated: 2018.10.22
- Phantom: SAM2; Type: SAM; Serial: TP-1542
- Measurement SW: DASY52, Version 52.10 (1); SEMCAD X Version 14.6.11 (7439)

Ch26140/Area Scan (71x81x1): Interpolated grid: dx=1.500 mm, dy=1.500 mm
Maximum value of SAR (interpolated) = 1.15 W/kg

Ch26140/Zoom Scan (5x5x7)/Cube 0: Measurement grid: dx=8mm, dy=8mm, dz=5mm
Reference Value = 9.187 V/m; Power Drift = 0.03 dB
Peak SAR (extrapolated) = 1.65 W/kg
SAR(1 g) = 0.889 W/kg; SAR(10 g) = 0.452 W/kg
Maximum value of SAR (measured) = 1.19 W/kg

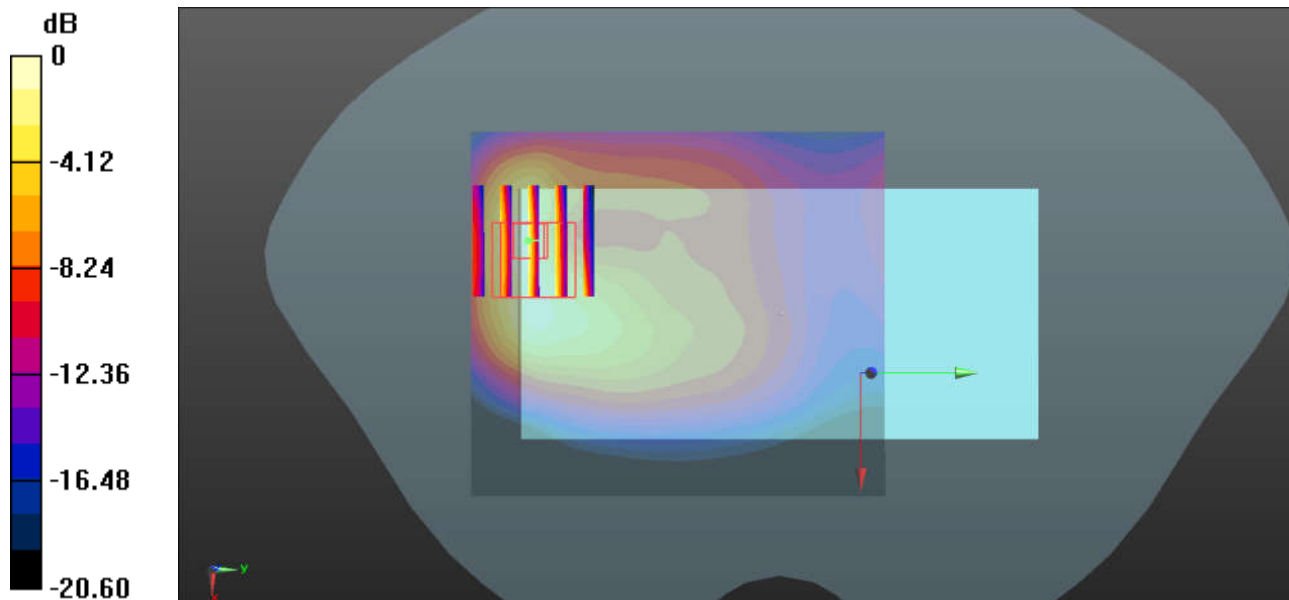

0 dB = 1.19 W/kg = 0.76 dBW/kg