



FCC RF Test Report

APPLICANT : Motorola Mobility LLC
EQUIPMENT : Mobile Cellular Phone
BRAND NAME : Motorola
MODEL NAME : XT2005-5, XT2005-1PP, XT2005-1
FCC ID : IHDT56YA1
STANDARD : 47 CFR Part 2, 22(H), 24(E), 27(L)
CLASSIFICATION : PCS Licensed Transmitter Held to Ear (PCE)

This is a data re-used report which is only valid together with the original test report. The product was received on Feb. 21, 2019 and completely tested on Apr. 07, 2019. We, Sporton International (Kunshan) Inc., would like to declare that the tested sample has been evaluated in accordance with the procedures given in ANSI C63.26-2015 and shown compliance with the applicable technical standards.

The test results in this report apply exclusively to the tested model / sample. Without written approval of Sporton International (Kunshan) Inc., the test report shall not be reproduced except in full.



Approved by: James Huang / Manager

Sporton International (Kunshan) Inc.
No. 1098, Pengxi North Road, Kunshan Economic Development Zone,
Jiangsu Province 215335, China



TABLE OF CONTENTS

REVISION HISTORY.....3

SUMMARY OF TEST RESULT4

1 GENERAL DESCRIPTION5

 1.1 Applicant.....5

 1.2 Manufacturer5

 1.3 Product Feature of Equipment Under Test5

 1.4 Product Specification of Equipment Under Test6

 1.5 Modification of EUT6

 1.6 Re-use of Measured Data7

 1.7 Specification of Accessory8

 1.8 Maximum EIRP Power, Frequency Tolerance, and Emission Designator.....8

 1.9 Testing Location9

 1.10 Applicable Standards9

2 TEST CONFIGURATION OF EQUIPMENT UNDER TEST10

 2.1 Test Mode.....10

 2.2 Connection Diagram of Test System11

 2.3 Support Unit used in test configuration11

 2.4 Measurement Results Explanation Example11

 2.5 Frequency List of Low/Middle/High Channels.....12

3 CONDUCTED TEST RESULT.....13

 3.1 Measuring Instruments.....13

 3.2 Test Setup13

 3.3 Test Result of Conducted Test.....13

 3.4 Conducted Output Power and EIRP14

 3.5 Peak-to-Average Ratio15

 3.6 99% Occupied Bandwidth and 26dB Bandwidth Measurement.....16

 3.7 Conducted Band Edge17

 3.8 Conducted Spurious Emission18

 3.9 Frequency Stability.....19

4 RADIATED TEST ITEMS20

 4.1 Measuring Instruments.....20

 4.2 Test Setup20

 4.3 Test Result of Radiated Test.....20

 4.4 Field Strength of Spurious Radiation Measurement21

5 LIST OF MEASURING EQUIPMENT22

6 UNCERTAINTY OF EVALUATION23

APPENDIX A. TEST RESULTS OF CONDUCTED TEST

APPENDIX B. TEST RESULTS OF RADIATED TEST

APPENDIX C. TEST SETUP PHOTOGRAPHS

APPENDIX D. REFERENCE REPORT



REVISION HISTORY

REPORT NO.	VERSION	DESCRIPTION	ISSUED DATE
FG922110-02A	Rev. 01	Initial issue of report	May 09, 2019



SUMMARY OF TEST RESULT

Report Section	FCC Rule	Description	Limit	Result	Remark
3.4	§2.1046	Conducted Output Power	Reporting Only	PASS	-
	§22.913(a)(5)	Effective Radiated Power	< 7 Watts	PASS	-
	§24.232(c)	Equivalent Isotropic Radiated Power	< 2 Watts	PASS	-
	§27.50(d)(4)	Equivalent Isotropic Radiated Power	< 1 Watts	PASS	-
3.5	§24.232(d)	Peak-to-Average Ratio	< 13 dB	PASS	-
3.6	§2.1049	Occupied Bandwidth	Reporting Only	PASS	-
3.7	§2.1051 §22.917(a) §24.238(a) §27.53(h)	Band Edge Measurement	< 43+10log10(P[Watts])	PASS	-
3.8	§2.1051 §22.917(a) §24.238(a) §27.53(h)	Conducted Emission	< 43+10log10(P[Watts])	PASS	-
3.9	§2.1055 §22.355	Frequency Stability for Temperature & Voltage	< 2.5 ppm for Part 22H	PASS	-
	§2.1055 §24.235 §27.54		Within Authorized Band		
4.4	§2.1053 §22.917(a) §24.238(a) §27.53(h)	Field Strength of Spurious Radiation	< 43+10log10(P[Watts])	PASS	Under limit 35.57 dB at 5640.000 MHz



1 General Description

1.1 Applicant

Motorola Mobility LLC
222 W,Merchandise Mart Plaza, Chicago IL 60654 USA

1.2 Manufacturer

Motorola Mobility LLC
222 W,Merchandise Mart Plaza, Chicago IL 60654 USA

1.3 Product Feature of Equipment Under Test

Product Feature	
Equipment	Mobile Cellular Phone
Brand Name	Motorola
Model Name	XT2005-5, XT2005-1PP, XT2005-1
FCC ID	IHDT56YA1
EUT supports Radios application	CDMA/EV-DO/GSM/GPRS/EGPRS/WCDMA/HSPA/DC-HSDPA/HSPA+(16QAM uplink is not supported)/LTE WLAN 2.4GHz 802.11b/g/n HT20/HT40 WLAN 5GHz 802.11a/n HT20/HT40 Bluetooth BR / EDR / LE FM Receiver/GNSS
IMEI Code	Conducted: N/A Radiation: 352178100007283 for 24E/27L 352178100007267 for 22H/CDMA
HW Version	88941-1-12
SW Version	fastboot_surfna_oem_userdebug_9_PP29.12_2fc78_intcfg-test-keys_oem
EUT Stage	Identical Prototype

Remark: The above EUT's information was declared by manufacturer. Please refer to the specifications or user's manual for more detailed description.



1.4 Product Specification of Equipment Under Test

Standards-related Product Specification	
Tx Frequency	GSM/GPRS/EDGE: 850: 824.2 MHz ~ 848.8 MHz 1900: 1850.2 MHz ~ 1909.8MHz WCDMA: Band V: 826.4 MHz ~ 846.6 MHz Band II: 1852.4 MHz ~ 1907.6 MHz Band IV: 1712.4 MHz ~ 1752.6 MHz CDMA2000: BC0: 824.70 MHz ~ 848.31 MHz BC1: 1851.25 MHz ~ 1908.75 MHz
Rx Frequency	GSM/GPRS/EDGE: 850: 869.2 MHz ~ 893.8 MHz 1900: 1930.2 MHz ~ 1989.8 MHz WCDMA: Band V: 871.4 MHz ~ 891.6 MHz Band II: 1932.4 MHz ~ 1987.6 MHz Band IV: 2112.4 MHz ~ 2152.6 MHz CDMA2000: BC0: 869.70 MHz ~ 893.31 MHz BC1: 1931.25 MHz ~ 1988.75 MHz
Maximum Output Power to Antenna	WCDMA: Band II: 23.13 dBm CDMA2000: BC1: 24.69 dBm
Antenna Type	Coupling type (LDS) Antenna
Antenna Gain	Cellular Band: 2.00 dBi PCS Band: 2.10 dBi
Type of Modulation	GSM: GMSK GPRS: GMSK EDGE: GMSK / 8PSK WCDMA : BPSK HSDPA/DC-HSDPA : QPSK HSUPA : QPSK HSPA+ : 16QAM (uplink is not supported) DC-HSDPA : 64QAM CDMA2000 1xRTT: QPSK CDMA2000 1xEV-DO: QPSK/8PSK

1.5 Modification of EUT

No modifications are made to the EUT during all test items.



1.6 Re-use of Measured Data

1.6.1 Introduction Section

This application re-uses data collected on a similar device. The subject device of this application (Model: XT2005-5, XT2005-1PP, XT2005-1, FCC ID: IHDT56YA1) is electrically identical to the reference device (Model: XT2005-3, FCC ID: IHDT56YA3) for the portions of the circuitry corresponding to the data being re-used, as treated by KDB Publication 484596 D01.

1.6.2 Difference Section

For details concerning the similarity with respect to component placement, mechanical/electrical design etc., please refer to the Product Equality Declaration.

The re-used RF data includes the following bands provided in Appendix D (Sporton RF Report No. FG922110A for the reference device Model: XT2005-3, FCC ID: IHDT56YA3).

1.6.3 Reference detail Section:

Equipment Class	Reference FCC ID	Folder Test	Report Title/Section
PCE (2G/3G)	IHDT56YA3	Part22H.24E.27L(FG922110A)	All Conducted sections and ERP/EIRP applicable for GSM850/1900, WCDMA Band V/IV and CDMA BC0

1.6.4 Spot Check Verification Data Section

In order to confirm hardware similarity of the subject device with the reference device, spot check measurements were performed on the subject device for the for Conducted Power, the test result were consistent with FCC ID: IHDT56YA3.

Assertions concerning the similarity of these devices are based on representations by the applicant. The applicant accepts full responsibility for the validity of the similarity claim, and for the determination that verification test data are sufficient to support it.

Test Item	Mode	IHDT56YA3 Worst Result	IHDT56YA1 Worst Result	Difference (dB)
Average Conducted Power (dBm)	GSM 850	32.19	32.68	-0.49
	PCS 1900	29.45	29.29	0.16
	WCDMA Band V	22.80	23.04	-0.24
	WCDMA Band IV	22.42	23.09	-0.67
	CDMA BC0	24.57	24.23	0.34

1.7 Specification of Accessory

Specification of Accessory				
AC Adapter 1	Brand Name	Motorola(Acbel)	Model Name	SC-61
	Power Rating	I/P: 100-240 Vac, 130mA ; O/P: 5Vdc,1000mA		
AC Adapter 2	Brand Name	Motorola (Chenyang)	Model Name	SC-61
	Power Rating	I/P: 100-240 Vac, 130mA ; O/P: 5Vdc,1000mA		
Battery 1	Brand Name	Motorola(ATL)	Model Name	KE40
	Power Rating	3.8Vdc, 2820/3000mAh (Rated/typ)	Type	Li-ion
Battery 2	Brand Name	Motorola(Sunwoda)	Model Name	KE40
	Power Rating	3.8Vdc, 2820/3000mAh (Rated/typ)	Type	Li-ion
USB Cable	Brand Name	Motorola (SaiBao)	Model Name	711310002241
	Signal Line Type	1.0 meter, shielded cable, without ferrite core		

1.8 Maximum EIRP Power, Frequency Tolerance, and Emission Designator

FCC Rule	System	Type of Modulation	Maximum EIRP (W)	Frequency Tolerance (ppm)	Emission Designator
Part 24E	WCDMA Band II RMC 12.2Kbps	BPSK	0.3334	0.0167 ppm	4M16F9W
Part 24E	CDMA2000 BC1 1xRTT	QPSK	0.4775	0.0133 ppm	1M27F9W



1.9 Testing Location

Sporton International (Kunshan) Inc. is accredited to ISO 17025 by National Voluntary Laboratory Accreditation Program (NVLAP code: 600155-0).

Test Site	Sporton International (Kunshan) Inc.		
Test Site Location	No. 1098, Pengxi North Road, Kunshan Economic Development Zone, Jiangsu Province 215335, China TEL : 86-512-57900158 FAX : 86-512-57900958		
Test Site No.	Sporton Site No.	FCC designation No.	FCC Test Firm Registration No.
	TH01-KS 03CH06-KS	CN5013	630927

1.10 Applicable Standards

According to the specifications of the manufacturer, the EUT must comply with the requirements of the following standards:

- ♦ 47 CFR Part 2, 22(H), 24(E), 27(L)
- ♦ ANSI C63.26-2015
- ♦ FCC KDB 971168 D01 Power Meas. License Digital Systems v03r01
- ♦ FCC KDB 412172 D01 Determining ERP and EIRP v01r01

Remark:

1. All test items were verified and recorded according to the standards and without any deviation during the test.
2. This EUT has also been tested and complied with the requirements of FCC Part 15, Subpart B, recorded in a separate test report.



2 Test Configuration of Equipment Under Test

2.1 Test Mode

Antenna port conducted and radiated test items were performed according to KDB 971168 D01 Power Meas. License Digital Systems v03r01 with maximum output power.

Radiated measurements were performed with rotating EUT in different three orthogonal test planes to find the maximum emission.

Radiated emissions were investigated as following frequency range:

1. 30 MHz to 10th harmonic for GSM/WCDMA/CDMA

All modes and data rates and positions were investigated.

Test modes are chosen to be reported as the worst case configuration below:

Test Modes		
Band	Radiated TCs	Conducted TCs
GSM 850	<ul style="list-style-type: none"> ■ GSM Link ■ EDGE class 8 Link 	
GSM 1900	<ul style="list-style-type: none"> ■ GSM Link ■ EDGE class 8 Link 	
WCDMA Band V	<ul style="list-style-type: none"> ■ RMC 12.2Kbps Link 	
WCDMA Band II	<ul style="list-style-type: none"> ■ RMC 12.2Kbps Link 	<ul style="list-style-type: none"> ■ RMC 12.2Kbps Link
WCDMA Band IV	<ul style="list-style-type: none"> ■ RMC 12.2Kbps Link 	
CDMA BC0	<ul style="list-style-type: none"> ■ 1xRTT Link 	
CDMA BC1	<ul style="list-style-type: none"> ■ 1xRTTLink 	<ul style="list-style-type: none"> ■ 1xRTT Link

2.2 Connection Diagram of Test System

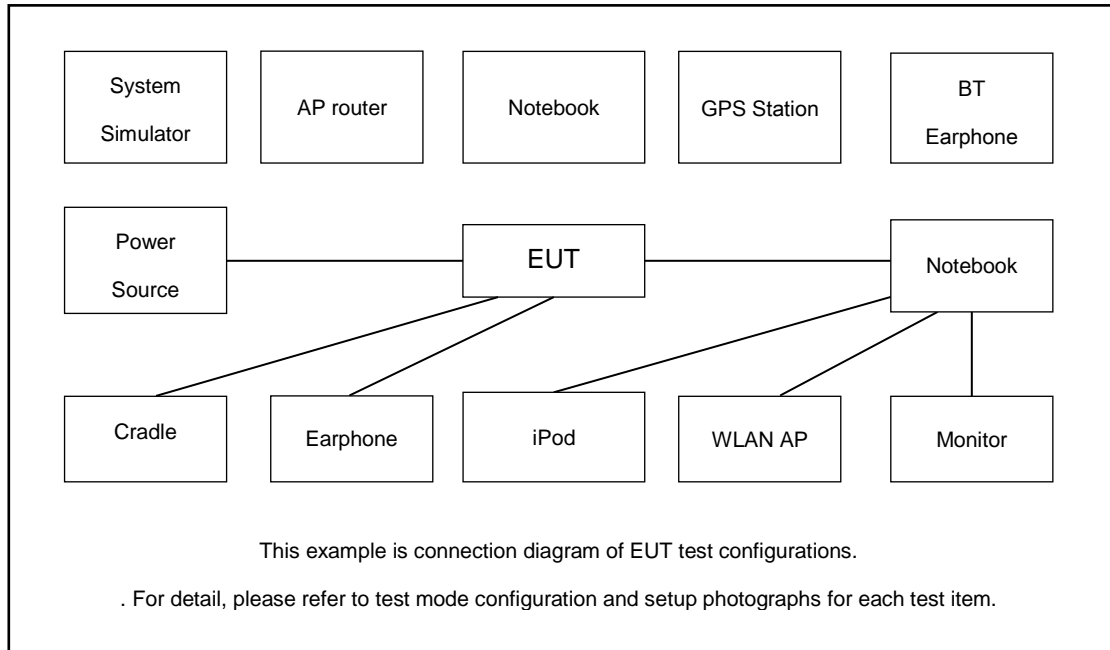

2.3 Support Unit used in test configuration

Item	Equipment	Trade Name	Model No.	FCC ID	Data Cable	Power Cord
1.	System Simulator	Anritsu	MT8820C	N/A	Unshielded,1.8m	Unshielded, 1.8 m
2.	DC Power Supply	GW INSTEK	GPS-3030D	N/A	N/A	Unshielded, 1.8 m
3.	Earphone	Lenovo	SH100	N/A	Unshielded,1.2m	N/A

2.4 Measurement Results Explanation Example

For all conducted test items:

The offset level is set in the spectrum analyzer to compensate the RF cable loss and attenuator factor between RF conducted output port and spectrum analyzer. With the offset compensation, the spectrum analyzer reading level will be exactly the RF output level.

The spectrum analyzer offset is derived from RF cable loss and attenuator factor.

$$\text{Offset} = \text{RF cable loss} + \text{attenuator factor}.$$

The following shows an offset computation example with RF cable loss 5.0 dB and a 10dB attenuator.

Example :

$$\begin{aligned} \text{Offset}(dB) &= \text{RF cable loss}(dB) + \text{attenuator factor}(dB). \\ &= 5.0 + 10 = 15.0 \text{ (dB)} \end{aligned}$$



2.5 Frequency List of Low/Middle/High Channels

Frequency List				
Band	Channel/Frequency(MHz)	Lowest	Middle	Highest
WCDMA Band II	Channel	9262	9400	9538
	Frequency	1852.4	1880.0	1907.6
CDMA200 BC1	Channel	25	600	1175
	Frequency	1851.25	1880.0	1908.75

3 Conducted Test Result

3.1 Measuring Instruments

See list of measuring instruments of this test report.

3.2 Test Setup

3.2.1 Conducted Output Power



3.2.2 Peak-to-Average Ratio, Occupied Bandwidth, Conducted Band-Edge and Conducted Spurious Emission

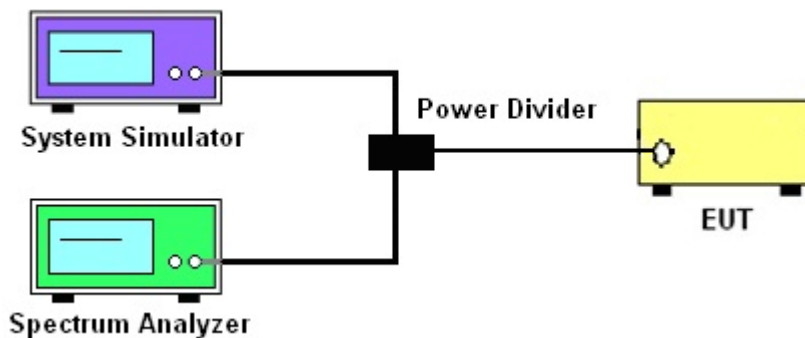

3.2.3 Frequency Stability

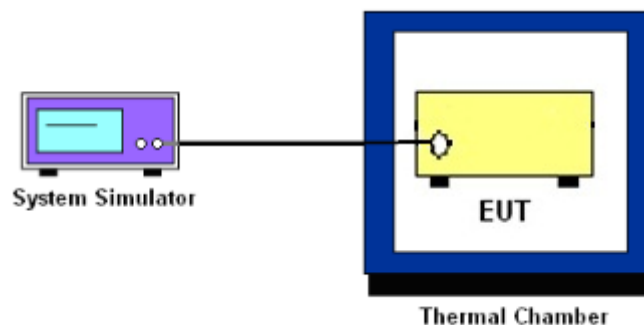

3.3 Test Result of Conducted Test

Please refer to Appendix A.



3.4 Conducted Output Power and EIRP

3.4.1 Description of the Conducted Output Power and EIRP

A system simulator was used to establish communication with the EUT. Its parameters were set to enforce EUT transmitting at the maximum power. The measured power in the radio frequency on the transmitter output terminals shall be reported.

The EIRP of mobile transmitters must not exceed 2 Watts for WCDMA Band II and CDMA BC1

According to KDB 412172 D01 Power Approach,

$EIRP = P_T + G_T - L_C$, $ERP = EIRP - 2.15$, where

P_T = transmitter output power in dBm

G_T = gain of the transmitting antenna in dBi

L_C = signal attenuation in the connecting cable between the transmitter and antenna in dB

3.4.2 Test Procedures

1. The testing follows ANSI C63.26 Section 5.2
2. The transmitter output port was connected to the system simulator.
3. Set EUT at maximum power through the system simulator.
4. Select lowest, middle, and highest channels for each band and different modulation.
5. Measure and record the power level from the system simulator.



3.5 Peak-to-Average Ratio

3.5.1 Description of the PAR Measurement

The peak-to-average ratio (PAR) of the transmission may not exceed 13 dB.

3.5.2 Test Procedures

1. The testing follows ANSI C63.26 Section 5.2.3.4 (CCDF).
2. The EUT was connected to spectrum and system simulator via a power divider.
3. Set the CCDF (Complementary Cumulative Distribution Function) option in spectrum analyzer.
4. The highest RF powers were measured and recorded the maximum PAPR level associated with a probability of 0.1 %.
5. Record the deviation as Peak to Average Ratio.



3.6 99% Occupied Bandwidth and 26dB Bandwidth Measurement

3.6.1 Description of 99% Occupied Bandwidth and 26dB Bandwidth Measurement

The occupied bandwidth is the width of a frequency band such that, below the lower and above the upper frequency limits, the mean powers emitted are each equal to a specified percentage 0.5% of the total mean transmitted power.

The 26 dB emission bandwidth is defined as the frequency range between two points, one above and one below the carrier frequency, at which the spectral density of the emission is attenuated 26 dB below the maximum in-band spectral density of the modulated signal. Spectral density (power per unit bandwidth) is to be measured with a detector of resolution bandwidth equal to approximately 1.0% of the emission bandwidth.

3.6.2 Test Procedures

1. The testing follows ANSI C63.26 Section 5.4
2. The EUT was connected to spectrum analyzer and system simulator via a power divider.
3. The spectrum analyzer center frequency is set to the nominal EUT channel center frequency. The span range for the spectrum analyzer shall be between two and five times the anticipated OBW.
4. The nominal resolution bandwidth (RBW) shall be in the range of 1 to 5 % of the anticipated OBW, and the VBW shall be at least 3 times the RBW.
5. Set the detection mode to peak, and the trace mode to max hold.
6. Determine the reference value: Set the EUT to transmit a modulated signal. Allow the trace to stabilize. Set the spectrum analyzer marker to the highest level of the displayed trace.
(this is the reference value)
7. Determine the “-26 dB down amplitude” as equal to (Reference Value – X).
8. Place two markers, one at the lowest and the other at the highest frequency of the envelope of the spectral display such that each marker is at or slightly below the “-X dB down amplitude” determined in step 6. If a marker is below this “-X dB down amplitude” value it shall be placed as close as possible to this value. The OBW is the positive frequency difference between the two markers.
9. Use the 99 % power bandwidth function of the spectrum analyzer and report the measured bandwidth.



3.7 Conducted Band Edge

3.7.1 Description of Conducted Band Edge Measurement

The power of any emission outside of the authorized operating frequency ranges must be lower than the transmitter power (P) by a factor of at least $43 + 10 \log (P)$ dB.

3.7.2 Test Procedures

1. The testing follows ANSI C63.26 section 5.7
2. The EUT was connected to the spectrum analyzer and system simulator via a power divider.
3. The RF output of EUT was connected to the spectrum analyzer by an RF cable and attenuator. The path loss was compensated to the results for each measurement.
4. The band edges of low and high channels for the highest RF powers were measured.
5. The RF fundamental frequency should be excluded against the limit line in the operating frequency band.
6. The limit line is derived from $43 + 10\log(P)$ dB below the transmitter power P(Watts)



3.8 Conducted Spurious Emission

3.8.1 Description of Conducted Spurious Emission Measurement

The power of any emission outside of the authorized operating frequency ranges must be lower than the transmitter power (P) by a factor of at least $43 + 10 \log (P)$ dB.

It is measured by means of a calibrated spectrum analyzer and scanned from 30 MHz up to a frequency including its 10th harmonic.

3.8.2 Test Procedures

1. The testing follows ANSI C63.26 section 5.7
2. The EUT was connected to the spectrum analyzer and system simulator via a power divider.
3. The RF output of EUT was connected to the spectrum analyzer by an RF cable and attenuator. The path loss was compensated to the results for each measurement.
4. The middle channel for the highest RF power within the transmitting frequency was measured.
5. The conducted spurious emission for the whole frequency range was taken.
6. The RF fundamental frequency should be excluded against the limit line in the operating frequency band.
7. The limit line is derived from $43 + 10\log(P)$ dB below the transmitter power P(Watts)



3.9 Frequency Stability

3.9.1 Description of Frequency Stability Measurement

The frequency stability shall be measured by variation of ambient temperature and variation of primary supply voltage to ensure that the fundamental emission stays within the authorized frequency block. The frequency stability of the transmitter shall be maintained within $\pm 0.00025\%$ ($\pm 2.5\text{ppm}$) of the center frequency.

3.9.2 Test Procedures for Temperature Variation

1. The testing follows ANSI C63.26 section 5.6.4
2. The EUT was set up in the thermal chamber and connected with the system simulator.
3. With power OFF, the temperature was decreased to -30°C and the EUT was stabilized before testing. Power was applied and the maximum change in frequency was recorded within one minute.
4. With power OFF, the temperature was raised in 10°C step up to 50°C . The EUT was stabilized at each step for at least half an hour. Power was applied and the maximum frequency change was recorded within one minute.

3.9.3 Test Procedures for Voltage Variation

1. The testing follows ANSI C63.26 section 5.6.5
2. The EUT was placed in a temperature chamber at $20\pm 5^{\circ}\text{C}$ and connected with the system simulator.
3. The power supply voltage to the EUT was varied from 85% to 115% of the nominal value for other than hand carried battery equipment.
4. For hand carried, battery powered equipment, reduce the primary ac or dc supply voltage to the battery operating end point, which shall be specified by the manufacturer.
5. The variation in frequency was measured for the worst case.

4 Radiated Test Items

4.1 Measuring Instruments

See list of measuring instruments of this test report.

4.2 Test Setup

4.2.1 For radiated test from 30MHz to 1GHz

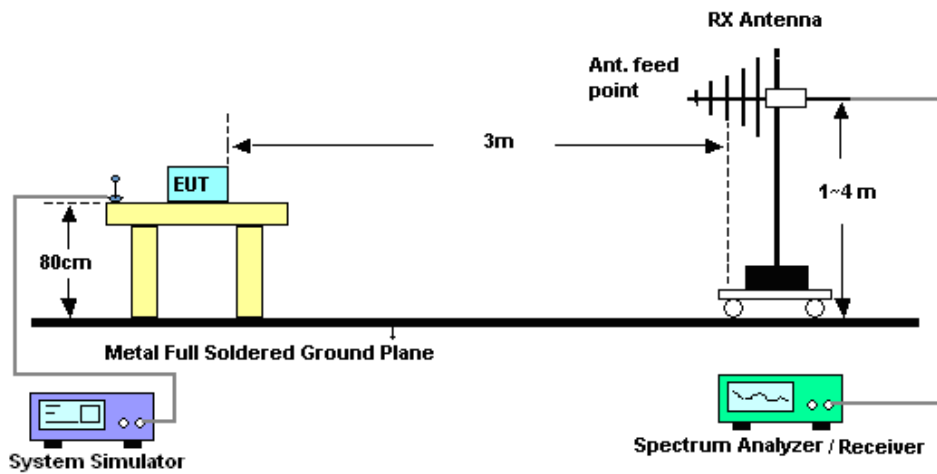

4.2.2 For radiated test above 1GHz

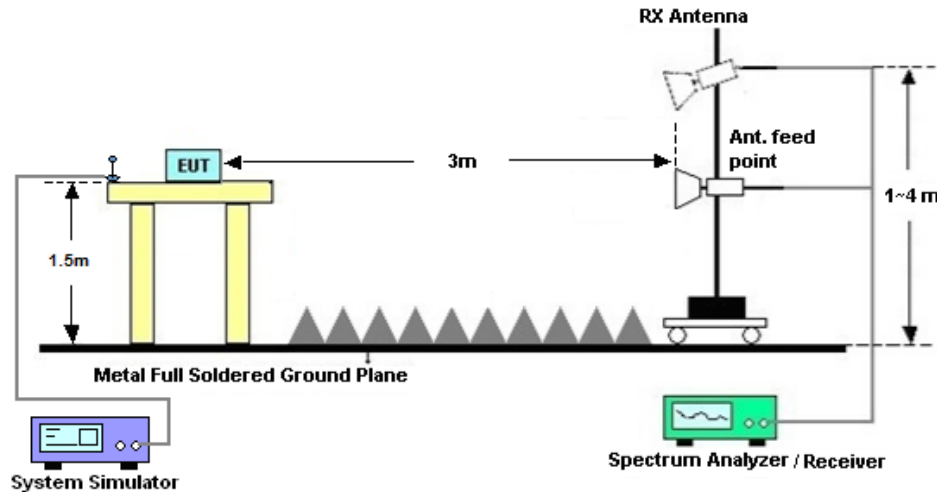

4.3 Test Result of Radiated Test

Please refer to Appendix B.



4.4 Field Strength of Spurious Radiation Measurement

4.4.1 Description of Field Strength of Spurious Radiated Measurement

The power of any emission outside of the authorized operating frequency ranges must be attenuated below the transmitter power (P) by a factor of at least $43 + 10 \log (P)$ dB. The spectrum is scanned from 30 MHz up to a frequency including its 10th harmonic.

4.4.2 Test Procedures

1. The testing follows ANSI C63.26 Section 5.5
2. The EUT was placed on a rotatable wooden table 0.8 meters for frequency below 1GHz and 1.5 meter for frequency above 1GHz above the ground.
3. The EUT was set 3 meters from the receiving antenna, which was mounted on the antenna tower.
4. The table was rotated 360 degrees to determine the position of the highest spurious emission.
5. The height of the receiving antenna is varied between one meter and four meters to search for the maximum spurious emission for both horizontal and vertical polarizations.
6. Make the measurement with the spectrum analyzer's RBW = 1MHz, VBW = 3MHz, taking record of maximum spurious emission.
7. A horn antenna was substituted in place of the EUT and was driven by a signal generator.
8. Tune the output power of signal generator to the same emission level with EUT maximum spurious emission.
9. Taking the record of output power at antenna port.
10. Repeat step 7 to step 8 for another polarization.
11. $EIRP \text{ (dBm)} = S.G. \text{ Power} - Tx \text{ Cable Loss} + Tx \text{ Antenna Gain}$
12. $ERP \text{ (dBm)} = EIRP - 2.15$
13. The RF fundamental frequency should be excluded against the limit line in the operating frequency band.
14. The limit line is derived from $43 + 10\log(P)$ dB below the transmitter power P(Watts)



5 List of Measuring Equipment

Instrument	Manufacturer	Model No.	Serial No.	Characteristics	Calibration Date	Test Date	Due Date	Remark
Spectrum Analyzer	R&S	FSV40	100319	10Hz~40GHz	Oct. 11, 2018	Mar. 16, 2019~ Apr. 07, 2019	Oct. 10, 2019	Conducted (TH01-KS)
Thermal Chamber	Hongzhan	LP-150U	H2014011440	-40~+150°C 20%~95%RH	Jun. 27, 2018	Mar. 16, 2019~ Apr. 07, 2019	Jun. 26, 2019	Conducted (TH01-KS)
EXA Spectrum Analyzer	Keysight	N9010B	MY57471084	10Hz-44GHz	Oct. 09, 2018	Mar. 06, 2019~ Mar. 27, 2019	Oct. 08, 2019	Radiation (03CH06-KS)
Bilog Antenna	TeseQ	CBL6111D	44483	30MHz-1GHz	Dec. 28, 2018	Mar. 06, 2019~ Mar. 27, 2019	Dec. 27, 2019	Radiation (03CH06-KS)
Double Ridge Horn Antenna	ETS-Lindgren	3117	75957	1GHz~18GHz	Oct. 20, 2018	Mar. 06, 2019~ Mar. 27, 2019	Oct. 19, 2019	Radiation (03CH06-KS)
SHF-EHF Horn	Com-power	AH-840	101070	18GHz~40GHz	Jan. 05, 2019	Mar. 06, 2019~ Mar. 27, 2019	Jan. 04, 2020	Radiation (03CH06-KS)
Amplifier	SONOMA	310N	187289	9KHz ~1GHZ	Aug. 06, 2018	Mar. 06, 2019~ Mar. 27, 2019	Aug. 05, 2019	Radiation (03CH06-KS)
high gain Amplifier	MITEQ	AMF-7D-00 101800-30-1 0P	2025788	1Ghz-18Ghz	Apr. 17, 2018	Mar. 06, 2019~ Mar. 27, 2019	Apr. 16, 2019	Radiation (03CH06-KS)
Amplifier	Keysight	83017A	MY53270203	500MHz~26.5GHz	Apr. 18, 2018	Mar. 06, 2019~ Mar. 27, 2019	Apr. 17, 2019	Radiation (03CH06-KS)
Amplifier	MITEQ	TTA1840-35 -HG	2014749	18~40GHz	Jan. 14, 2019	Mar. 06, 2019~ Mar. 27, 2019	Jan. 13, 2020	Radiation (03CH06-KS)
AC Power Source	Chroma	61601	F104090004	N/A	NCR	Mar. 06, 2019~ Mar. 27, 2019	NCR	Radiation (03CH06-KS)
Turn Table	ChamPro	EM 1000-T	060762-T	0~360 degree	NCR	Mar. 06, 2019~ Mar. 27, 2019	NCR	Radiation (03CH06-KS)
Antenna Mast	ChamPro	EM 1000-A	060762-A	1 m~4 m	NCR	Mar. 06, 2019~ Mar. 27, 2019	NCR	Radiation (03CH06-KS)

NCR: No Calibration Required



6 Uncertainty of Evaluation

The measurement uncertainties shown below were calculated in accordance with the requirements of ANSI 63.26-2015. All the measurement uncertainty value were shown with a coverage K=2 to indicate 95% level of confidence. The measurement data show herein meets or exceeds the CISPR measurement uncertainty values specified in CISPR 16-4-2 and can be compared directly to specified limit to determine compliance.

Uncertainty of Radiated Emission Measurement (30 MHz ~ 1000 MHz)

Measuring Uncertainty for a Level of Confidence of 95% (U = 2Uc(y))	2.5dB
---	-------

Uncertainty of Radiated Emission Measurement (1 GHz ~ 18 GHz)

Measuring Uncertainty for a Level of Confidence of 95% (U = 2Uc(y))	2.0dB
---	-------

Uncertainty of Radiated Emission Measurement (18 GHz ~ 40 GHz)

Measuring Uncertainty for a Level of Confidence of 95% (U = 2Uc(y))	2.0dB
---	-------



Appendix A. Test Results of Conducted Test

Conducted Output Power(Average power)

Conducted Power (*Unit: dBm)			
Band	WCDMA Band II		
Channel	9262	9400	9538
Frequency	1852.4	1880	1907.6
AMR 12.2K	22.87	23.12	22.75
RMC 12.2K	22.86	23.13	22.75
HSDPA Subtest-1	21.90	22.16	21.91
HSDPA Subtest-2	21.85	22.17	21.94
HSDPA Subtest-3	21.35	21.62	21.42
HSDPA Subtest-4	21.40	21.66	21.37
DC-HSDPA Subtest-1	21.88	22.13	21.92
DC-HSDPA Subtest-2	21.84	22.10	21.90
DC-HSDPA Subtest-3	21.38	21.59	21.43
DC-HSDPA Subtest-4	21.35	21.63	21.39
HSUPA Subtest-1	21.84	22.13	21.91
HSUPA Subtest-2	19.85	20.10	19.89
HSUPA Subtest-3	20.84	21.12	20.95
HSUPA Subtest-4	19.85	20.11	19.89
HSUPA Subtest-5	21.90	22.10	21.90



Conducted Power (*Unit: dBm)			
Band	CDMA 2000 BC1		
Channel	25	600	1175
Frequency	1851.25	1880	1908.75
1xRTT RC1 SO55	24.31	24.50	24.51
1xRTT RC3 SO55	24.35	24.57	24.69
1xRTT RC3 SO32 (+ F-SCH)	24.46	24.67	24.68
1xRTT RC3 SO32 (+SCH)	24.42	24.61	24.63
1xEVDO RTAP 153.6Kbps	24.34	24.56	24.60
1xEVDO RETAP 4096Bits	24.30	24.51	24.50



EIRP

WCDMA Band II (G _T - L _C = 2.10 dB)			
Channel	9262	9400	9538
	(Low)	(Mid)	(High)
Frequency	1852.4	1880	1907.6
(MHz)			
Conducted Power (dBm)	22.86	23.13	22.75
Conducted Power (Watts)	0.1932	0.2056	0.1884
EIRP(dBm)	24.96	25.23	24.85
EIRP(Watts)	0.3133	0.3334	0.3055

CDMA 2000 BC1 (G _T - L _C = 2.10 dB)			
Channel	25	600	1175
	(Low)	(Mid)	(High)
Frequency	1851.25	1880	1908.75
(MHz)			
Conducted Power (dBm)	24.35	24.57	24.69
Conducted Power (Watts)	0.2723	0.2864	0.2944
EIRP(dBm)	26.45	26.67	26.79
EIRP(Watts)	0.4416	0.4645	0.4775



Peak-to-Average Ratio

Mode	WCDMA Band II(dB)	Limit: 13dB
Mod.	RMC 12.2Kbps	Result
Lowest CH	2.78	PASS
Middle CH	2.67	
Highest CH	2.70	

Mode	CDMA BC1(dB)	Limit: 13dB
Mod.	1xRTT	Result
Lowest CH	3.01	PASS
Middle CH	3.07	
Highest CH	3.22	

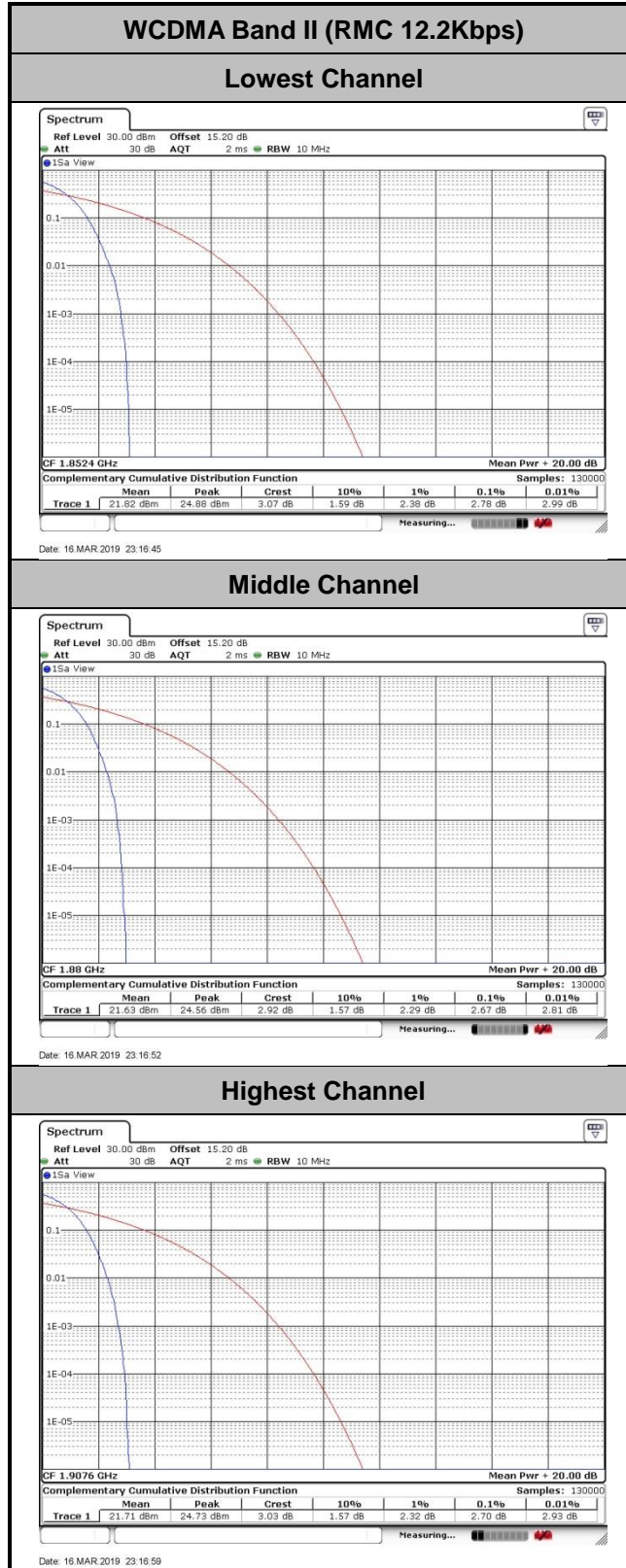

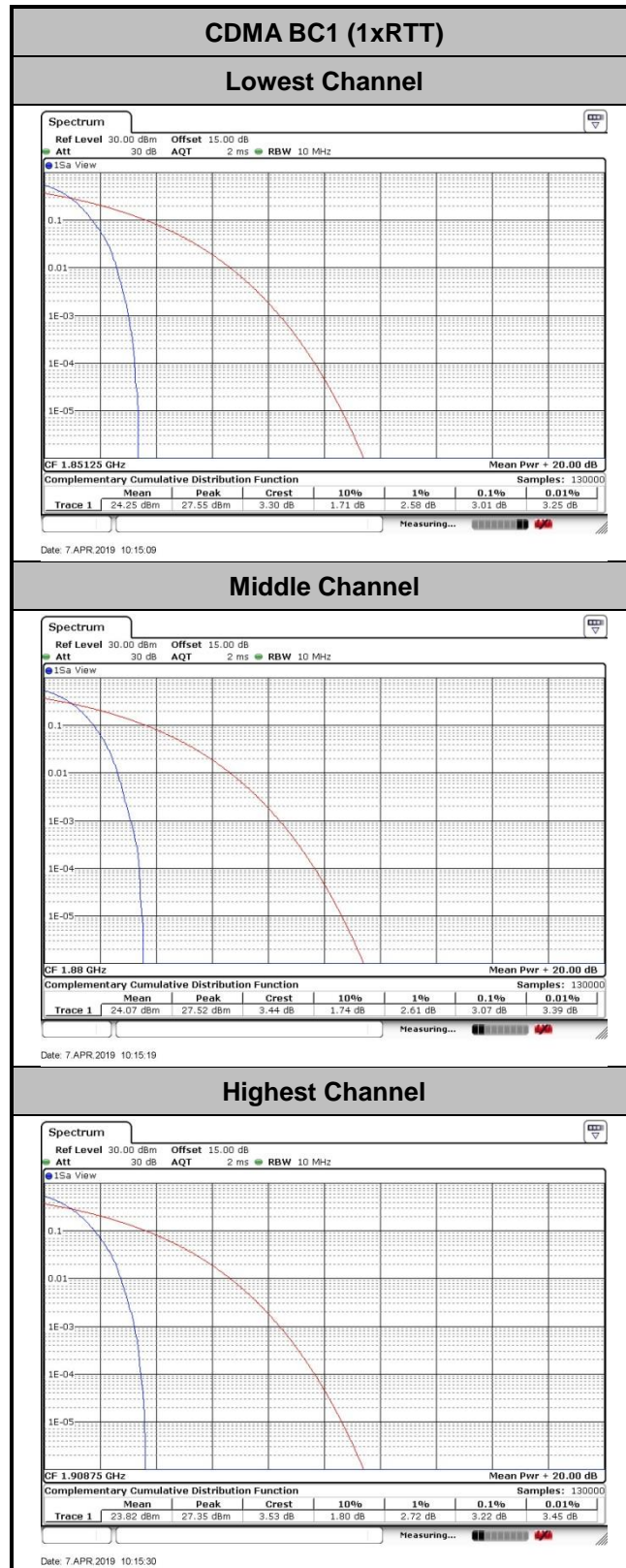



26dB Bandwidth

Mode	WCDMA Band II(MHz)
Mod.	RMC 12.2Kbps
Lowest CH	4.735
Middle CH	4.735
Highest CH	4.745

Mode	CDMA BC1(MHz)
Mod.	1xRTT
Lowest CH	1.439
Middle CH	1.431
Highest CH	1.429

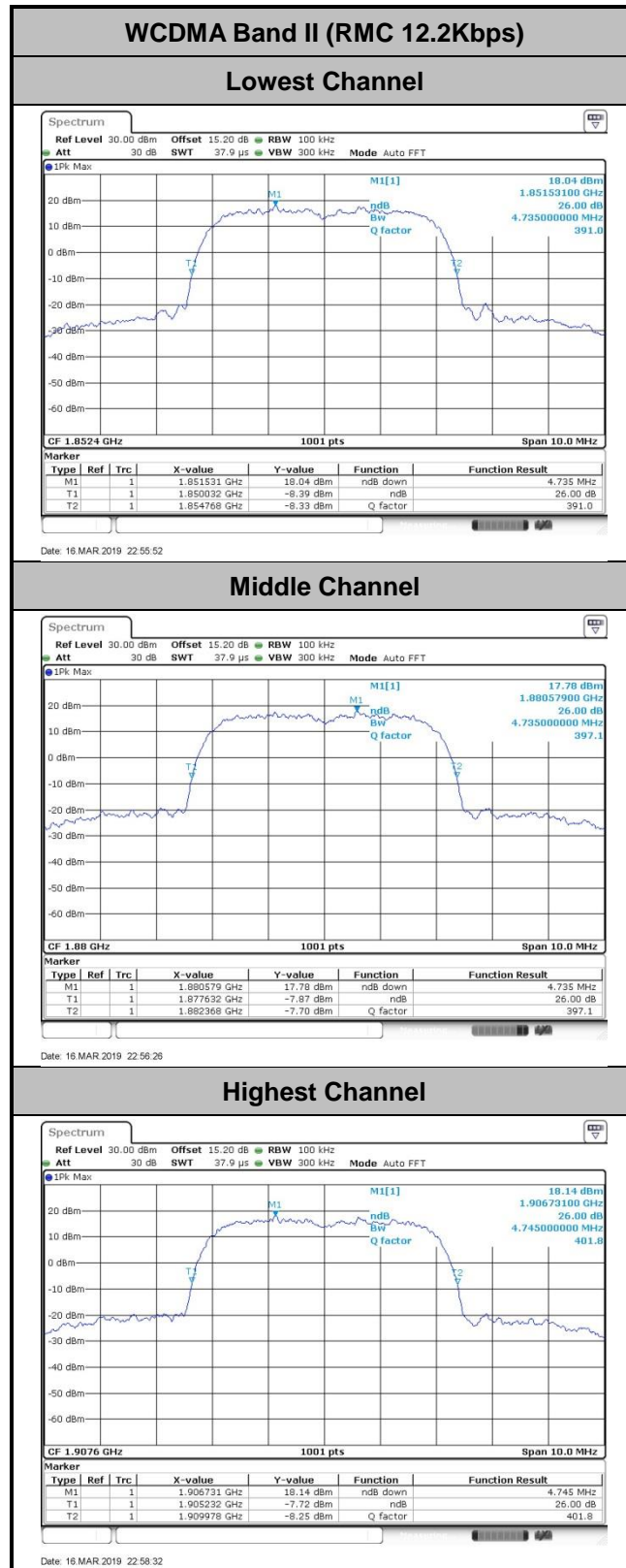

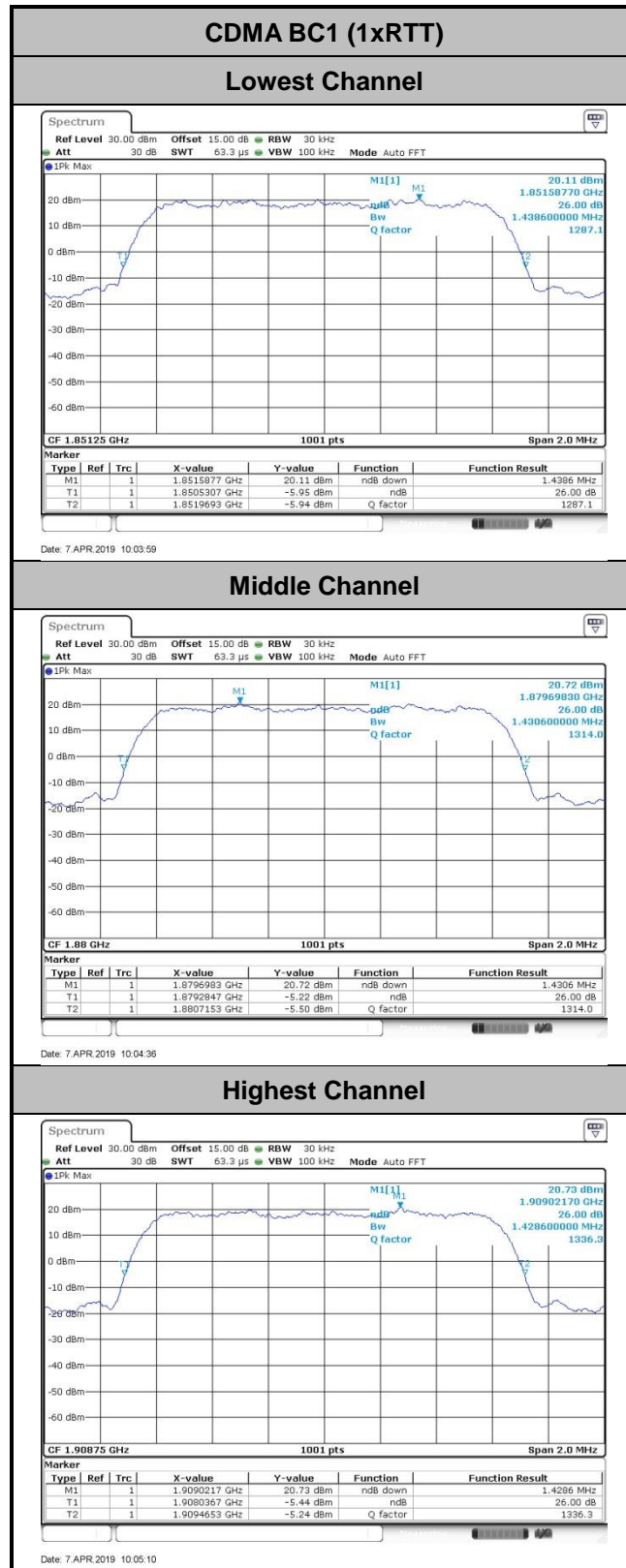



Occupied Bandwidth

Mode	WCDMA Band II(MHz)
Mod.	RMC 12.2Kbps
Lowest CH	4.136
Middle CH	4.156
Highest CH	4.146

Mode	CDMA BC1(MHz)
Mod.	1xRTT
Lowest CH	1.273
Middle CH	1.273
Highest CH	1.273

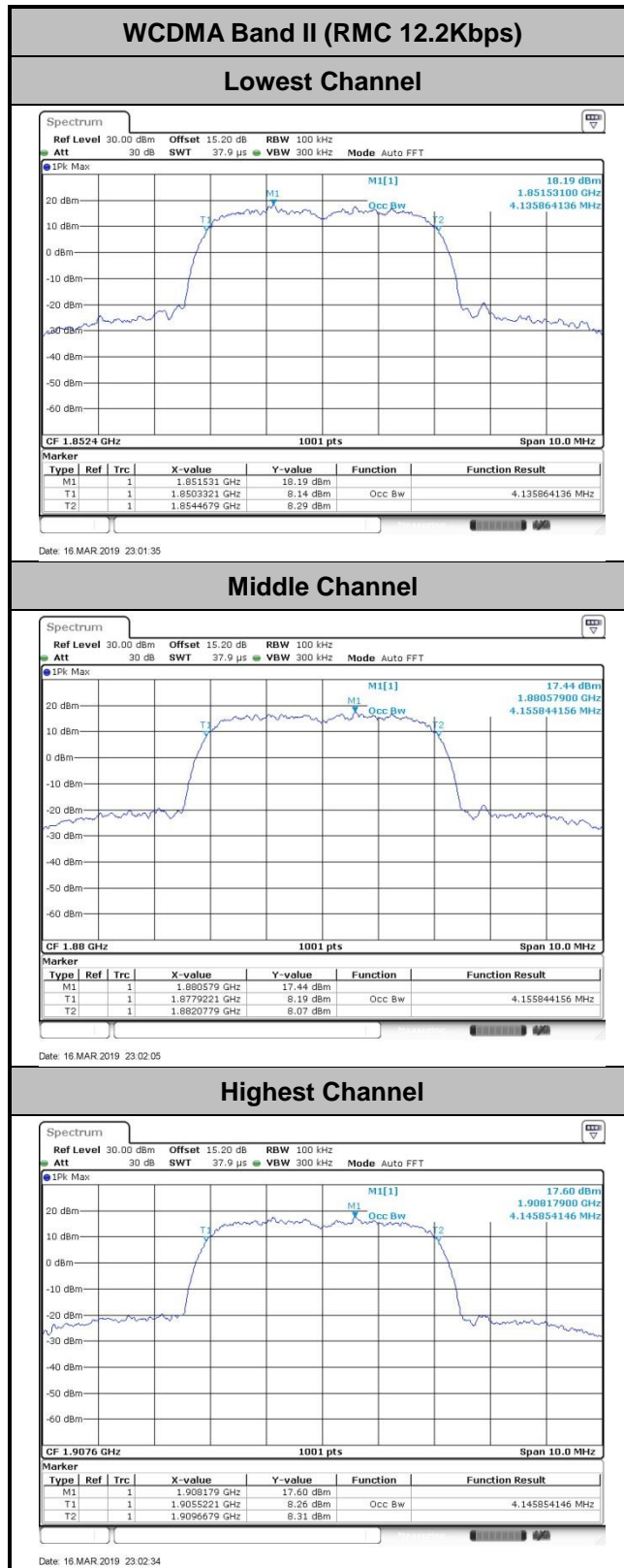

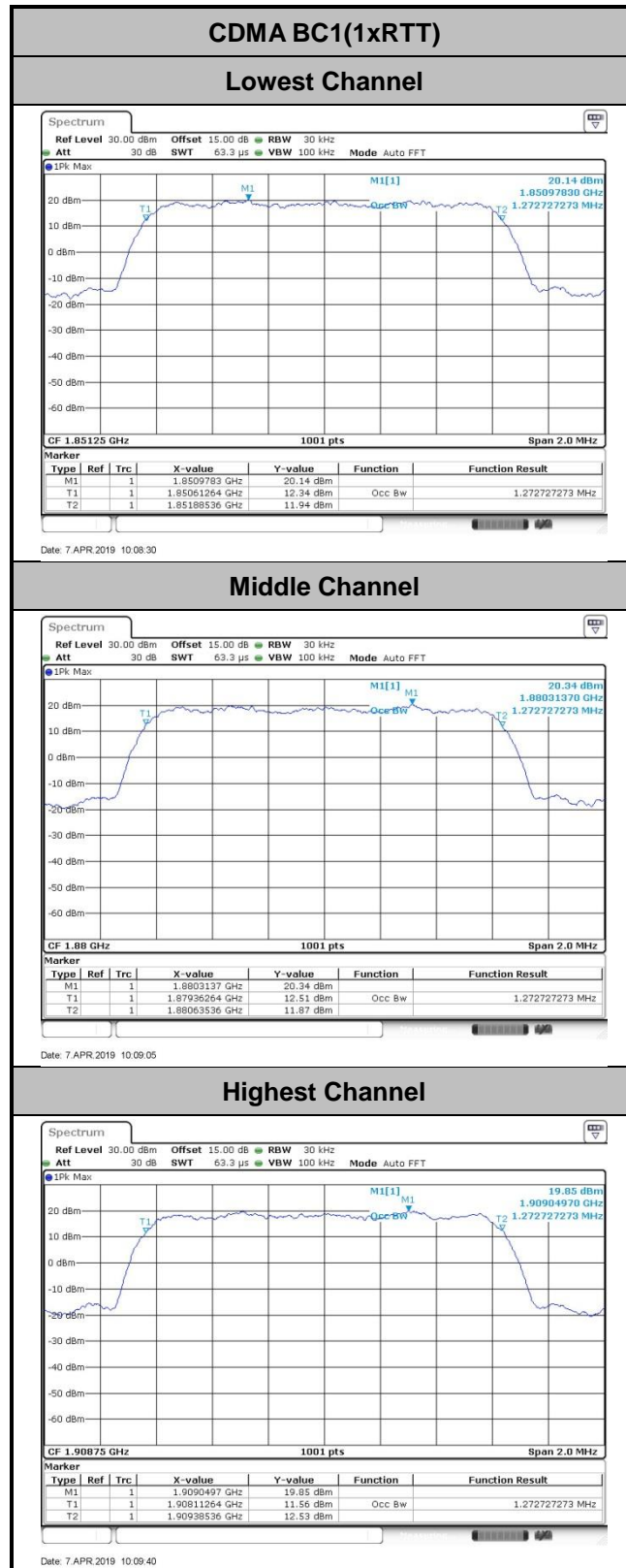



Conducted Band Edge

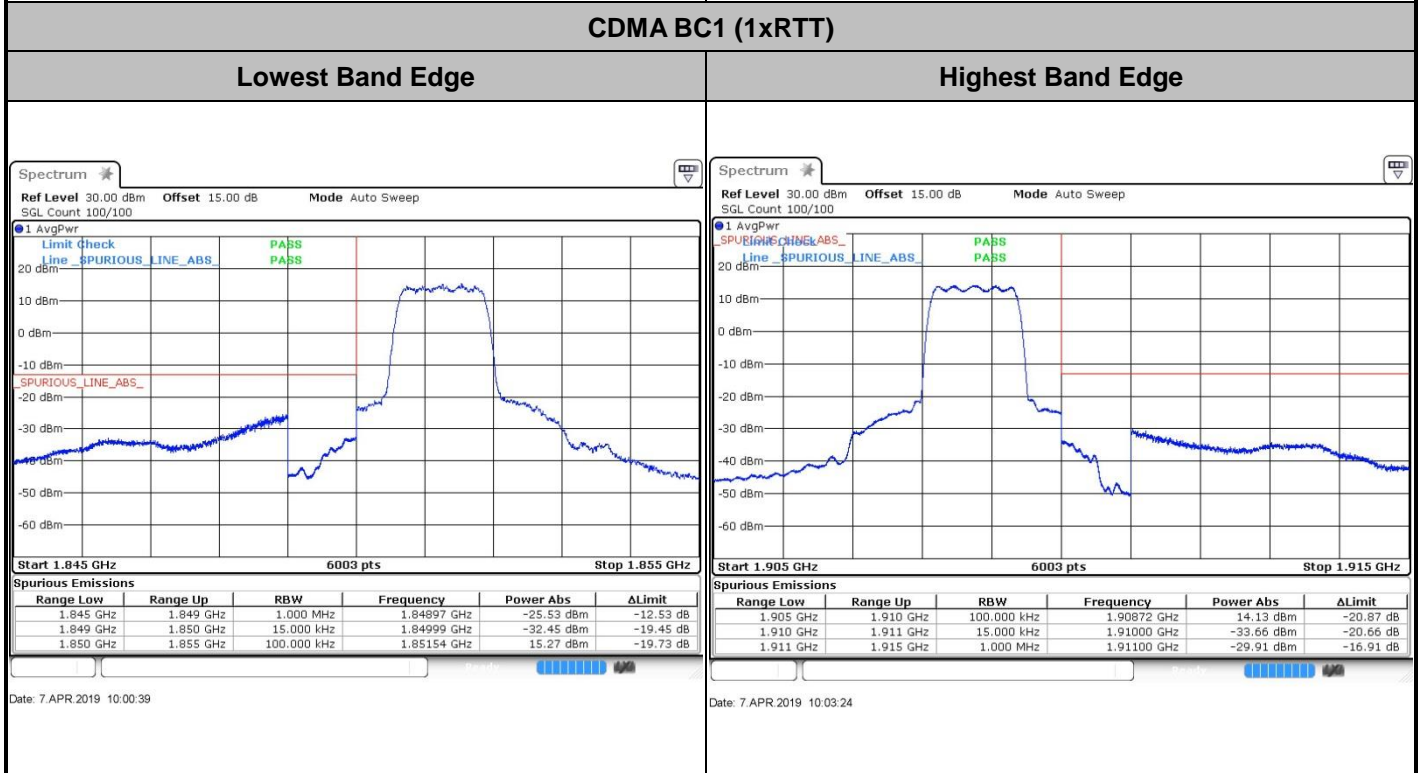
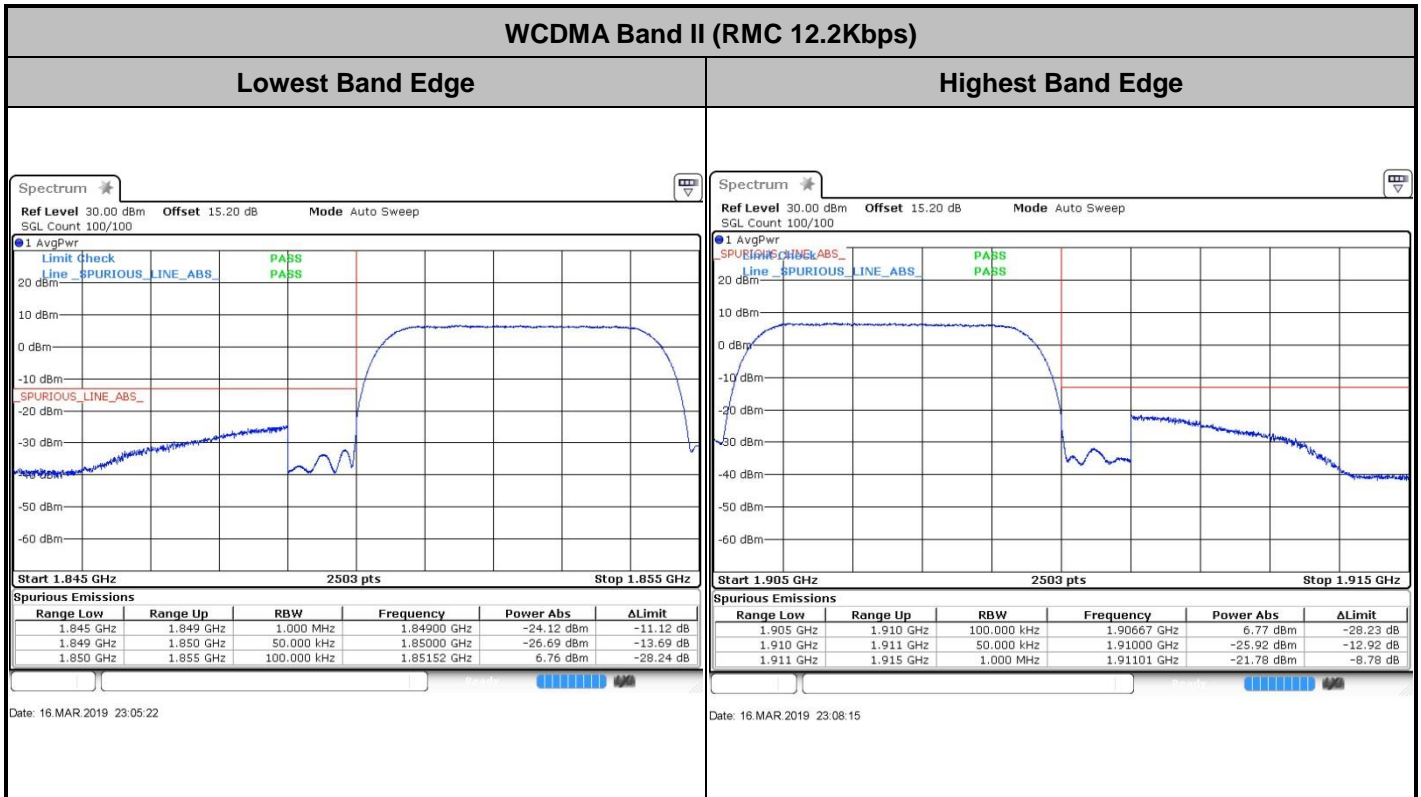



Conducted Spurious Emission

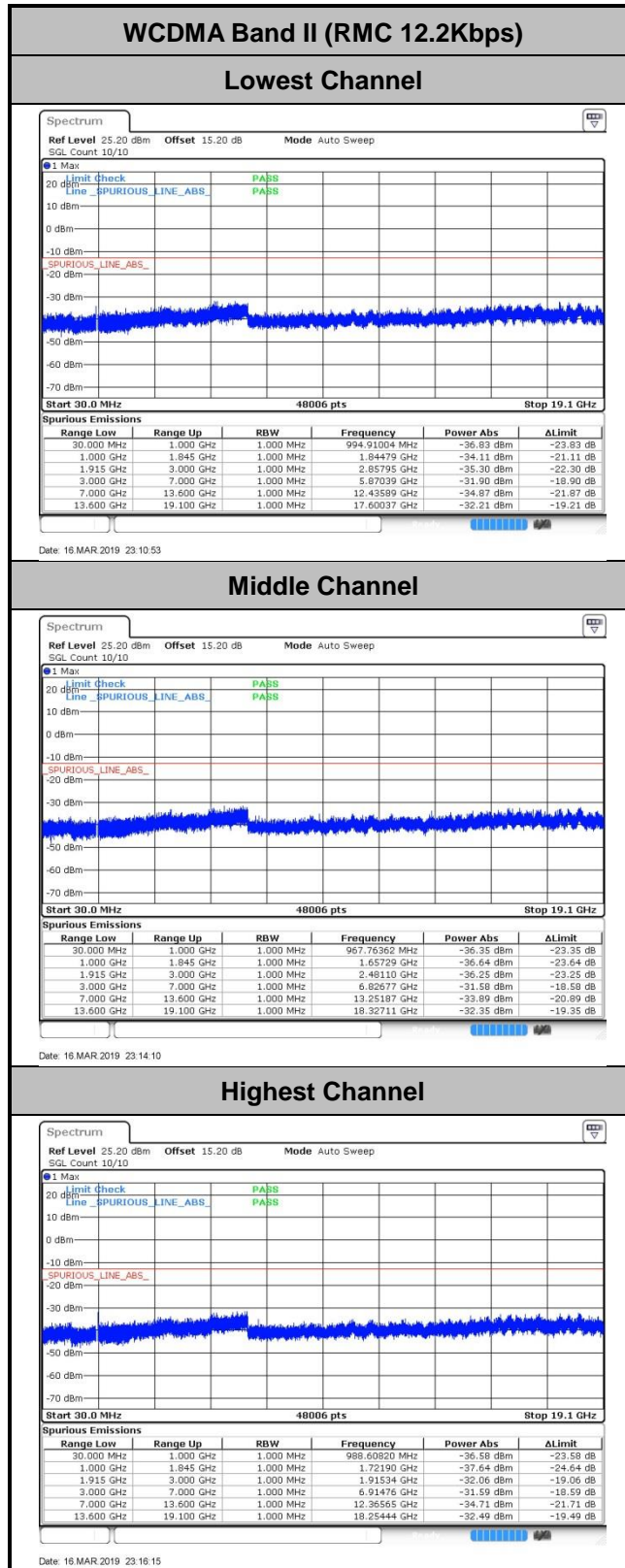

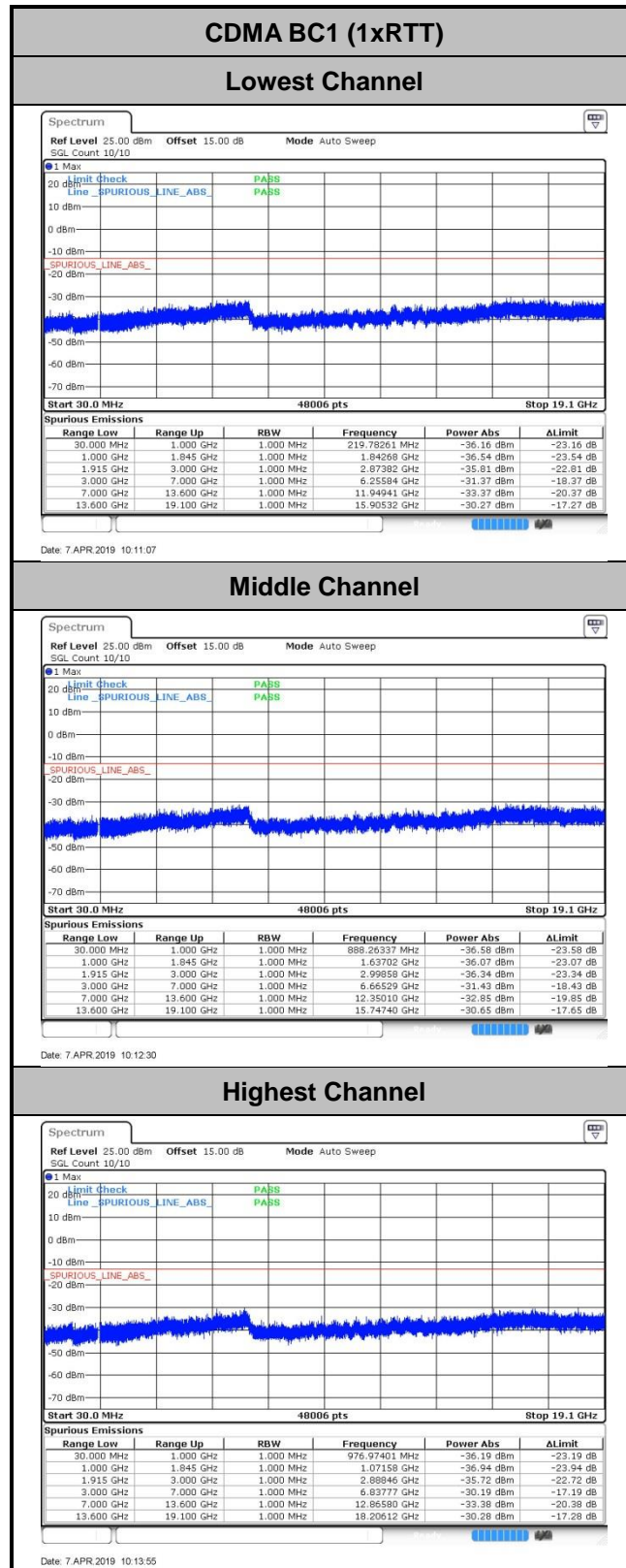



Frequency Stability

Test Conditions	Middle Channel	WCDMA Band II (RMC 12.2Kbps)	Limit Note 2.
Temperature (°C)	Voltage (Volt)	Deviation (ppm)	Result
50	Normal Voltage	0.0069	PASS
40	Normal Voltage	0.0156	
30	Normal Voltage	0.0017	
20(Ref.)	Normal Voltage	0.0000	
10	Normal Voltage	0.0012	
0	Normal Voltage	0.0058	
-10	Normal Voltage	0.0150	
-20	Normal Voltage	0.0167	
-30	Normal Voltage	0.0092	
20	Maximum Voltage	0.0092	
20	Normal Voltage	0.0000	
20	Battery End Point	0.0167	

Note:

1. Normal Voltage = 3.8V. ; Battery End Point (BEP) =3.6V. ; Maximum Voltage =4.1V
2. The frequency fundamental emissions stay within the authorized frequency block based on the frequency deviation measured is small.



Test Conditions	Middle Channel	CDMA BC1 (1xRTT)	Limit Note 2.
Temperature (°C)	Voltage (Volt)	Deviation (ppm)	Result
50	Normal Voltage	0.0037	PASS
40	Normal Voltage	0.0027	
30	Normal Voltage	0.0011	
20(Ref.)	Normal Voltage	0.0000	
10	Normal Voltage	0.0064	
0	Normal Voltage	0.0085	
-10	Normal Voltage	0.0005	
-20	Normal Voltage	0.0096	
-30	Normal Voltage	0.0128	
20	Maximum Voltage	0.0133	
20	Normal Voltage	0.0000	
20	Battery End Point	0.0011	

Note:

1. Normal Voltage = 3.8V ; Battery End Point (BEP) = 3.6V ; Maximum Voltage =4.1V
2. The frequency fundamental emissions stay within the authorized frequency block based on the frequency deviation measured is small.



Appendix B. Test Results of Radiated Test

Radiated Spurious Emission

GSM850 (GSM)								
Channel	Frequency (MHz)	ERP (dBm)	Limit (dBm)	Over Limit (dB)	S.G. Power (dBm)	TX Cable loss (dB)	TX Antenna Gain (dBi)	Polarization (H/V)
Lowest	1648	-49.88	-13	-36.88	-51.09	2.32	5.68	H
	2472	-55.38	-13	-42.38	-56.01	3.02	5.80	H
	3294	-65.30	-13	-52.30	-67.76	3.27	7.88	H
	1648	-63.34	-13	-50.34	-64.55	2.32	5.68	V
	2472	-54.96	-13	-41.96	-55.59	3.02	5.80	V
	3294	-65.77	-13	-52.77	-68.23	3.27	7.88	V
Middle	1672	-49.07	-13	-36.07	-50.28	2.32	5.68	H
	2508	-60.05	-13	-47.05	-60.68	3.02	5.80	H
	3345	-64.97	-13	-51.97	-67.43	3.27	7.88	H
	1672	-62.75	-13	-49.75	-63.96	2.32	5.68	V
	2508	-61.83	-13	-48.83	-62.46	3.02	5.80	V
	3345	-65.37	-13	-52.37	-67.83	3.27	7.88	V
Highest	1698	-53.05	-13	-40.05	-54.26	2.32	5.68	H
	2546	-64.73	-13	-51.73	-65.36	3.02	5.80	H
	3396	-63.80	-13	-50.80	-66.26	3.27	7.88	H
	1698	-64.79	-13	-51.79	-66.00	2.32	5.68	V
	2546	-61.85	-13	-48.85	-62.48	3.02	5.80	V
	3396	-64.45	-13	-51.45	-66.91	3.27	7.88	V

Remark: Spurious emissions within 30-1000MHz were found more than 20dB below limit line.



GSM850 (EDGE class 8)								
Channel	Frequency (MHz)	ERP (dBm)	Limit (dBm)	Over Limit (dB)	S.G. Power (dBm)	TX Cable loss (dB)	TX Antenna Gain (dBi)	Polarization (H/V)
Lowest	1648	-59.51	-13	-46.51	-60.72	2.32	5.68	H
	2472.6	-65.93	-13	-52.93	-66.56	3.02	5.80	H
	3294	-66.73	-13	-53.73	-69.19	3.27	7.88	H
	1648	-69.77	-13	-56.77	-70.98	2.32	5.68	V
	2472.6	-66.99	-13	-53.99	-67.62	3.02	5.80	V
	3294	-66.64	-13	-53.64	-69.10	3.27	7.88	V
Middle	1672	-65.22	-13	-52.22	-66.43	2.32	5.68	H
	2510	-66.56	-13	-53.56	-67.19	3.02	5.80	H
	3348	-64.93	-13	-51.93	-67.39	3.27	7.88	H
	1672.8	-68.94	-13	-55.94	-70.15	2.32	5.68	V
	2510	-66.94	-13	-53.94	-67.57	3.02	5.80	V
	3348	-65.55	-13	-52.55	-68.01	3.27	7.88	V
Highest	1698	-68.34	-13	-55.34	-69.55	2.32	5.68	H
	2546.4	-67.04	-13	-54.04	-67.67	3.02	5.80	H
	3396	-65.54	-13	-52.54	-68.00	3.27	7.88	H
	1697.6	-69.47	-13	-56.47	-70.68	2.32	5.68	V
	2546	-68.42	-13	-55.42	-69.05	3.02	5.80	V
	3396	-65.63	-13	-52.63	-68.09	3.27	7.88	V

Remark: Spurious emissions within 30-1000MHz were found more than 20dB below limit line.



GSM1900 (GSM)								
Channel	Frequency (MHz)	EIRP (dBm)	Limit (dBm)	Over Limit (dB)	S.G. Power (dBm)	TX Cable loss (dB)	TX Antenna Gain (dBi)	Polarization (H/V)
Lowest	3699	-56.96	-13	-43.96	-63.53	1.85	8.42	H
	5550	-53.15	-13	-40.15	-61.51	2.32	10.68	H
	7404	-52.68	-13	-39.68	-62.01	2.61	11.94	H
	3699	-55.94	-13	-42.94	-62.51	1.85	8.42	V
	5550	-52.62	-13	-39.62	-60.98	2.32	10.68	V
	7404	-53.01	-13	-40.01	-62.34	2.61	11.94	V
Middle	3759	-55.24	-13	-42.24	-61.81	1.85	8.42	H
	5640	-48.57	-13	-35.57	-56.93	2.32	10.68	H
	7524	-52.03	-13	-39.03	-61.36	2.61	11.94	H
	3760	-57.02	-13	-44.02	-63.59	1.85	8.42	V
	5640	-53.52	-13	-40.52	-61.88	2.32	10.68	V
	7524	-52.56	-13	-39.56	-61.89	2.61	11.94	V
Highest	3819	-57.03	-13	-44.03	-63.60	1.85	8.42	H
	5730	-51.62	-13	-38.62	-59.98	2.32	10.68	H
	7644	-52.16	-13	-39.16	-61.49	2.61	11.94	H
	3819	-57.32	-13	-44.32	-63.89	1.85	8.42	V
	5730	-50.35	-13	-37.35	-58.71	2.32	10.68	V
	7644	-52.03	-13	-39.03	-61.36	2.61	11.94	V

Remark: Spurious emissions within 30-1000MHz were found more than 20dB below limit line.



GSM1900 (EDGE class 8)								
Channel	Frequency (MHz)	EIRP (dBm)	Limit (dBm)	Over Limit (dB)	S.G. Power (dBm)	TX Cable loss (dB)	TX Antenna Gain (dBi)	Polarization (H/V)
Lowest	3699	-55.23	-13	-42.23	-61.80	1.85	8.42	H
	5550	-55.72	-13	-42.72	-64.08	2.32	10.68	H
	7404	-52.75	-13	-39.75	-62.08	2.61	11.94	H
	3700.4	-57.42	-13	-44.42	-63.99	1.85	8.42	V
	5550	-52.68	-13	-39.68	-61.04	2.32	10.68	V
	7404	-53.10	-13	-40.10	-62.43	2.61	11.94	V
Middle	3759	-57.52	-13	-44.52	-64.09	1.85	8.42	H
	5640	-50.16	-13	-37.16	-58.52	2.32	10.68	H
	7524	-52.23	-13	-39.23	-61.56	2.61	11.94	H
	3759	-56.38	-13	-43.38	-62.95	1.85	8.42	V
	5640	-51.77	-13	-38.77	-60.13	2.32	10.68	V
	7524	-52.97	-13	-39.97	-62.30	2.61	11.94	V
Highest	3819.6	-56.47	-13	-43.47	-63.04	1.848	8.42	H
	5730	-52.47	-13	-39.47	-60.83	2.32	10.68	H
	7644	-52.13	-13	-39.13	-61.46	2.61	11.94	H
	3819	-56.78	-13	-43.78	-63.35	1.85	8.42	V
	5730	-51.55	-13	-38.55	-59.91	2.32	10.68	V
	7644	-52.24	-13	-39.24	-61.57	2.61	11.94	V

Remark: Spurious emissions within 30-1000MHz were found more than 20dB below limit line.



WCDMA Band V(RMC 12.2Kbps)								
Channel	Frequency (MHz)	ERP (dBm)	Limit (dBm)	Over Limit (dB)	S.G. Power (dBm)	TX Cable loss (dB)	TX Antenna Gain (dBi)	Polarization (H/V)
Lowest	1652	-69.05	-13	-56.05	-70.26	2.32	5.68	H
	2479	-66.25	-13	-53.25	-66.88	3.02	5.80	H
	3305	-65.67	-13	-52.67	-68.13	3.27	7.88	H
	1652	-69.05	-13	-56.05	-70.26	2.32	5.68	V
	2479	-66.47	-13	-53.47	-67.10	3.02	5.80	V
	3305	-65.86	-13	-52.86	-68.32	3.27	7.88	V
Middle	1672	-69.27	-13	-56.27	-70.48	2.32	5.68	H
	2508	-66.67	-13	-53.67	-67.30	3.02	5.80	H
	3345	-65.76	-13	-52.76	-68.22	3.27	7.88	H
	1672.8	-69.26	-13	-56.26	-70.47	2.32	5.68	V
	2508	-67.03	-13	-54.03	-67.66	3.02	5.80	V
	3345	-65.63	-13	-52.63	-68.09	3.27	7.88	V
Highest	1693	-69.05	-13	-56.05	-70.26	2.32	5.68	H
	2539	-66.69	-13	-53.69	-67.32	3.02	5.80	H
	3386	-65.45	-13	-52.45	-67.91	3.27	7.88	H
	1693	-69.08	-13	-56.08	-70.29	2.32	5.68	V
	2539	-66.96	-13	-53.96	-67.59	3.02	5.80	V
	3386	-65.43	-13	-52.43	-67.89	3.27	7.88	V

Remark: Spurious emissions within 30-1000MHz were found more than 20dB below limit line.



WCDMA Band II(RMC 12.2Kbps)								
Channel	Frequency (MHz)	EIRP (dBm)	Limit (dBm)	Over Limit (dB)	S.G. Power (dBm)	TX Cable loss (dB)	TX Antenna Gain (dBi)	Polarization (H/V)
Lowest	3705	-58.19	-13	-45.19	-64.76	1.85	8.42	H
	5556	-57.21	-13	-44.21	-65.57	2.32	10.68	H
	7404	-52.72	-13	-39.72	-62.05	2.61	11.94	H
	3705	-57.86	-13	-44.86	-64.43	1.85	8.42	V
	5557.2	-57.35	-13	-44.35	-65.71	2.32	10.68	V
	7404	-53.09	-13	-40.09	-62.42	2.61	11.94	V
Middle	3759	-57.52	-13	-44.52	-64.09	1.85	8.42	H
	5640	-56.03	-13	-43.03	-64.39	2.32	10.68	H
	7520	-52.57	-13	-39.57	-61.90	2.61	11.94	H
	3760	-57.64	-13	-44.64	-64.21	1.85	8.42	V
	5640	-57.38	-13	-44.38	-65.74	2.32	10.68	V
	7520	-52.75	-13	-39.75	-62.08	2.61	11.94	V
Highest	3816	-57.77	-13	-44.77	-64.34	1.85	8.42	H
	5724	-57.12	-13	-44.12	-65.48	2.32	10.68	H
	7632	-52.66	-13	-39.66	-61.99	2.61	11.94	H
	3816	-57.43	-13	-44.43	-64.00	1.85	8.42	V
	5722.8	-57.78	-13	-44.78	-66.14	2.32	10.68	V
	7632	-52.83	-13	-39.83	-62.16	2.61	11.94	V

Remark: Spurious emissions within 30-1000MHz were found more than 20dB below limit line.



WCDMA Band IV(RMC 12.2Kbps)								
Channel	Frequency (MHz)	EIRP (dBm)	Limit (dBm)	Over Limit (dB)	S.G. Power (dBm)	TX Cable loss (dB)	TX Antenna Gain (dBi)	Polarization (H/V)
Lowest	3424.8	-58.52	-13	-45.52	-64.84	1.81	8.13	H
	5137.2	-57.51	-13	-44.51	-65.49	2.222	10.20	H
	6852	-53.00	-13	-40.00	-61.82	2.54	11.36	H
	3424.8	-57.98	-13	-44.98	-64.30	1.81	8.13	V
	5137.2	-58.12	-13	-45.12	-66.10	2.222	10.20	V
	6852	-54.34	-13	-41.34	-63.16	2.54	11.36	V
Middle	3465	-58.10	-13	-45.10	-64.42	1.81	8.13	H
	5199	-57.21	-13	-44.21	-65.19	2.222	10.20	H
	6930	-53.83	-13	-40.83	-62.65	2.54	11.36	H
	3465	-58.07	-13	-45.07	-64.39	1.81	8.13	V
	5199	-58.04	-13	-45.04	-66.02	2.222	10.20	V
	6930	-54.26	-13	-41.26	-63.08	2.54	11.36	V
Highest	3504	-58.17	-13	-45.17	-64.49	1.81	8.13	H
	5259	-57.54	-13	-44.54	-65.52	2.222	10.20	H
	7008	-52.81	-13	-39.81	-61.63	2.54	11.36	H
	3504	-58.19	-13	-45.19	-64.51	1.81	8.13	V
	5259	-58.28	-13	-45.28	-66.26	2.222	10.20	V
	7008	-53.55	-13	-40.55	-62.37	2.54	11.36	V

Remark: Spurious emissions within 30-1000MHz were found more than 20dB below limit line.



CDMA BC0(1xRTT)								
Channel	Frequency (MHz)	ERP (dBm)	Limit (dBm)	Over Limit (dB)	S.G. Power (dBm)	TX Cable loss (dB)	TX Antenna Gain (dBi)	Polarization (H/V)
Lowest	1648	-69.34	-13	-56.34	-70.55	2.32	5.68	H
	2474	-65.86	-13	-52.86	-66.49	3.02	5.80	H
	3300	-65.93	-13	-52.93	-68.39	3.27	7.88	H
	1648	-69.21	-13	-56.21	-70.42	2.32	5.68	V
	2474	-66.63	-13	-53.63	-67.26	3.02	5.80	V
	3300	-65.89	-13	-52.89	-68.35	3.27	7.88	V
Middle	1672	-69.20	-13	-56.20	-70.41	2.32	5.68	H
	2508	-65.66	-13	-52.66	-66.29	3.02	5.80	H
	3348	-64.75	-13	-51.75	-67.21	3.27	7.88	H
	1672	-69.32	-13	-56.32	-70.53	2.32	5.68	V
	2508	-66.94	-13	-53.94	-67.57	3.02	5.80	V
	3348	-65.30	-13	-52.30	-67.76	3.27	7.88	V
Highest	1696	-68.91	-13	-55.91	-70.12	2.32	5.68	H
	2544	-67.03	-13	-54.03	-67.66	3.02	5.80	H
	3393	-65.62	-13	-52.62	-68.08	3.27	7.88	H
	1696	-69.00	-13	-56.00	-70.21	2.32	5.68	V
	2544	-67.00	-13	-54.00	-67.63	3.02	5.80	V
	3393	-65.07	-13	-52.07	-67.53	3.27	7.88	V

Remark: Spurious emissions within 30-1000MHz were found more than 20dB below limit line.



CDMA BC1(1xRTT)								
Channel	Frequency (MHz)	EIRP (dBm)	Limit (dBm)	Over Limit (dB)	S.G. Power (dBm)	TX Cable loss (dB)	TX Antenna Gain (dBi)	Polarization (H/V)
Lowest	3702	-60.82	-13	-47.82	-65.69	3.55	8.42	H
	5553	-58.03	-13	-45.03	-64.37	4.34	10.68	H
	7404	-52.93	-13	-39.93	-59.73	5.14	11.94	H
	3702	-60.86	-13	-47.86	-65.73	3.55	8.42	V
	5553	-57.45	-13	-44.45	-63.79	4.34	10.68	V
	7404	-52.84	-13	-39.84	-59.64	5.14	11.94	V
Middle	3759	-60.45	-13	-47.45	-65.32	3.55	8.42	H
	5640	-57.44	-13	-44.44	-63.78	4.34	10.68	H
	7521	-52.45	-13	-39.45	-59.25	5.14	11.94	H
	3759	-60.26	-13	-47.26	-65.13	3.55	8.42	V
	5640	-57.04	-13	-44.04	-63.38	4.34	10.68	V
	7521	-52.16	-13	-39.16	-58.96	5.14	11.94	V
Highest	3816	-60.67	-13	-47.67	-65.54	3.55	8.42	H
	5727	-57.85	-13	-44.85	-64.19	4.34	10.68	H
	7635	-52.93	-13	-39.93	-59.73	5.14	11.94	H
	3816	-61.08	-13	-48.08	-65.95	3.55	8.42	V
	5727	-57.89	-13	-44.89	-64.23	4.34	10.68	V
	7635	-52.03	-13	-39.03	-58.83	5.14	11.94	V

Remark: Spurious emissions within 30-1000MHz were found more than 20dB below limit line.



Appendix D. Reference Report

Please refer to Sporton report number FG922110A which is issued separately.