

**30\_LTE Band 41\_20M\_QPSK\_1\_0\_Back\_5mm\_Ch41140**

Communication System: UID 0, LTE-TDD (0); Frequency: 2645 MHz; Duty Cycle: 1:1.59  
 Medium: MSL\_2600 Medium parameters used:  $f = 2645$  MHz;  $\sigma = 2.243$  S/m;  $\epsilon_r = 51.571$ ;  $\rho = 1000$  kg/m<sup>3</sup>  
 Ambient Temperature : 23.3 °C ; Liquid Temperature : 22.7 °C

**DASY5 Configuration:**

- Probe: EX3DV4 - SN3857; ConvF(7.38, 7.38, 7.38); Calibrated: 2018.5.31
- Sensor-Surface: 1.4mm (Mechanical Surface Detection)
- Electronics: DAE4 Sn1358; Calibrated: 2018.4.19
- Phantom: SAM2; Type: SAM; Serial: TP:1754
- Measurement SW: DASY52, Version 52.10 (1); SEMCAD X Version 14.6.11 (7439)

**Ch41140/Area Scan (91x91x1):** Interpolated grid: dx=1.200 mm, dy=1.200 mm  
 Maximum value of SAR (interpolated) = 2.14 W/kg

**Ch41140/Zoom Scan (7x7x7)/Cube 0:** Measurement grid: dx=5mm, dy=5mm, dz=5mm  
 Reference Value = 5.233 V/m; Power Drift = -0.05 dB  
 Peak SAR (extrapolated) = 2.99 W/kg  
**SAR(1 g) = 1.19 W/kg; SAR(10 g) = 0.470 W/kg**  
 Maximum value of SAR (measured) = 2.12 W/kg

**Ch41140/Zoom Scan (7x7x7)/Cube 1:** Measurement grid: dx=5mm, dy=5mm, dz=5mm  
 Reference Value = 5.233 V/m; Power Drift = -0.05 dB  
 Peak SAR (extrapolated) = 2.37 W/kg  
**SAR(1 g) = 0.990 W/kg; SAR(10 g) = 0.406 W/kg**  
 Maximum value of SAR (measured) = 1.78 W/kg

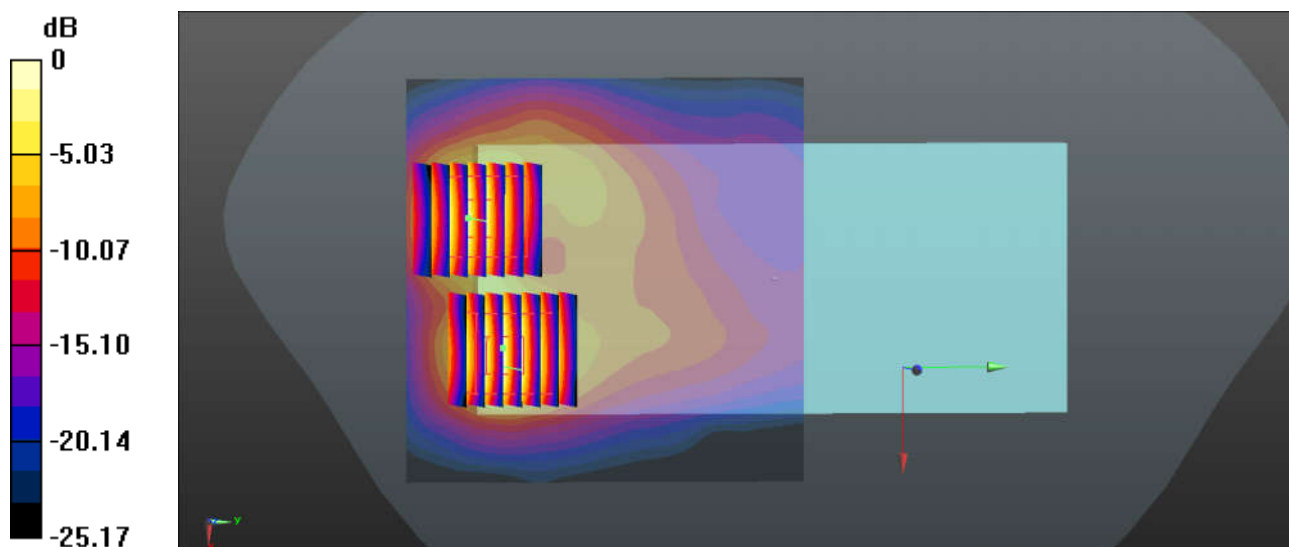

0 dB = 1.78 W/kg = 2.50 dBW/kg

**31\_WLAN2.4GHz\_802.11b 1Mbps\_Back\_5mm\_Ch1**

Communication System: UID 0, 802.11b (0); Frequency: 2412 MHz; Duty Cycle: 1:1  
 Medium: MSL\_2450 Medium parameters used:  $f = 2412$  MHz;  $\sigma = 1.954$  S/m;  $\epsilon_r = 53.33$ ;  $\rho = 1000$  kg/m<sup>3</sup>  
 Ambient Temperature : 23.2 °C ; Liquid Temperature : 22.6 °C

**DASY5 Configuration:**

- Probe: EX3DV4 - SN3843; ConvF(7.02, 7.02, 7.02); Calibrated: 2018.9.27
- Sensor-Surface: 1.4mm (Mechanical Surface Detection)
- Electronics: DAE4 Sn1338; Calibrated: 2018.12.3
- Phantom: SAM2; Type: SAM; Serial: TP-1754
- Measurement SW: DASY52, Version 52.10 (1); SEMCAD X Version 14.6.11 (7439)

**Ch1/Area Scan (91x91x1):** Interpolated grid: dx=1.200 mm, dy=1.200 mm  
 Maximum value of SAR (interpolated) = 0.771 W/kg

**Ch1/Zoom Scan (7x7x7)/Cube 0:** Measurement grid: dx=5mm, dy=5mm, dz=5mm  
 Reference Value = 2.370 V/m; Power Drift = 0.17 dB  
 Peak SAR (extrapolated) = 0.830 W/kg  
**SAR(1 g) = 0.444 W/kg; SAR(10 g) = 0.216 W/kg**  
 Maximum value of SAR (measured) = 0.697 W/kg

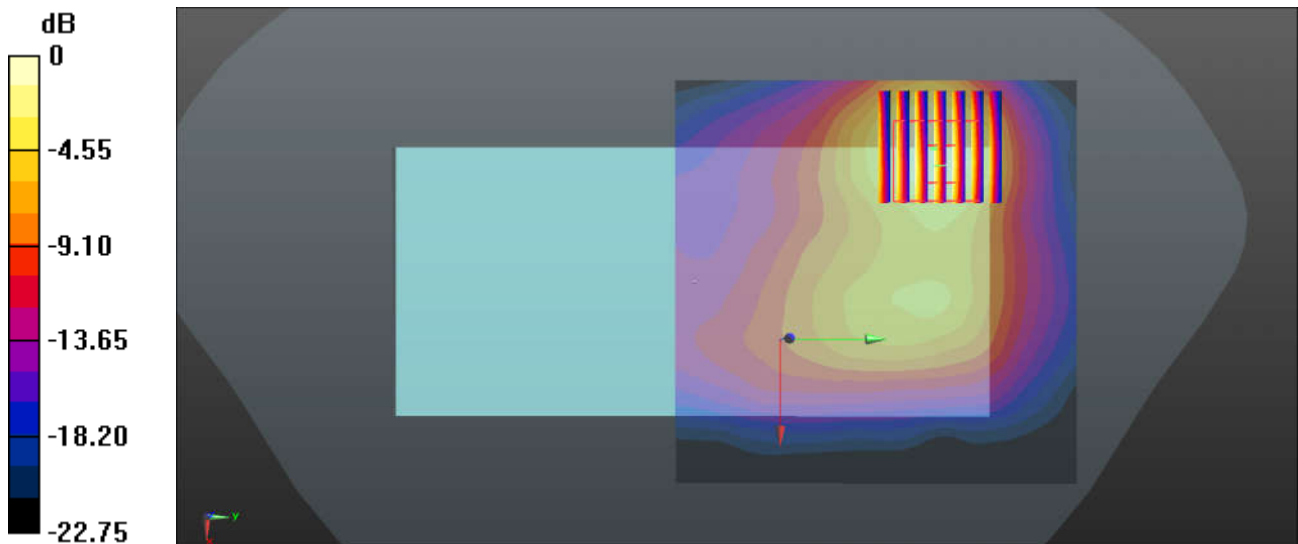

0 dB = 0.697 W/kg = -1.57 dBW/kg

### 32\_Bluetooth\_1Mbps\_Back\_5mm\_Ch39

Communication System: UID 0, Bluetooth (0); Frequency: 2441 MHz; Duty Cycle: 1:1.3  
 Medium: MSL\_2450 Medium parameters used:  $f = 2441$  MHz;  $\sigma = 1.994$  S/m;  $\epsilon_r = 53.217$ ;  $\rho = 1000$  kg/m<sup>3</sup>  
 Ambient Temperature : 23.2 °C ; Liquid Temperature : 22.6 °C

**DASY5 Configuration:**

- Probe: EX3DV4 - SN3843; ConvF(7.02, 7.02, 7.02); Calibrated: 2018.9.27
- Sensor-Surface: 1.4mm (Mechanical Surface Detection)
- Electronics: DAE4 Sn1338; Calibrated: 2018.12.3
- Phantom: SAM2; Type: SAM; Serial: TP-1754
- Measurement SW: DASY52, Version 52.10 (1); SEMCAD X Version 14.6.11 (7439)

**Ch39/Area Scan (91x91x1):** Interpolated grid: dx=1.200 mm, dy=1.200 mm  
 Maximum value of SAR (interpolated) = 0.0612 W/kg

**Ch39/Zoom Scan (7x7x7)/Cube 0:** Measurement grid: dx=5mm, dy=5mm, dz=5mm  
 Reference Value = 0.5770 V/m; Power Drift = 0.03 dB  
 Peak SAR (extrapolated) = 0.0680 W/kg  
**SAR(1 g) = 0.037 W/kg; SAR(10 g) = 0.019 W/kg**  
 Maximum value of SAR (measured) = 0.0562 W/kg

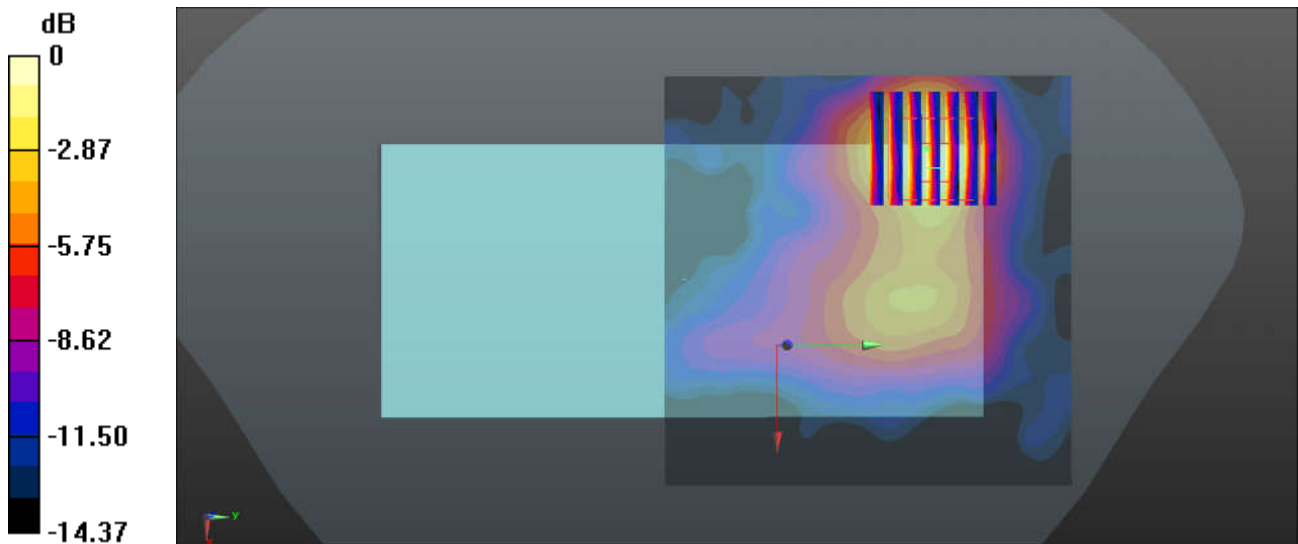

0 dB = 0.0562 W/kg = -12.50 dBW/kg

### 33\_WLAN5.3GHz\_802.11a 6Mbps\_Back\_5mm\_Ch64

Communication System: UID 0, WIFI (0); Frequency: 5320 MHz; Duty Cycle: 1:1.051

Medium: MSL\_5000 Medium parameters used:  $f = 5320$  MHz;  $\sigma = 5.554$  S/m;  $\epsilon_r = 47.55$ ;  $\rho = 1000$  kg/m<sup>3</sup>

Ambient Temperature : 23.4 °C ; Liquid Temperature : 22.9 °C

#### DASY5 Configuration:

- Probe: EX3DV4 - SN3857; ConvF(4.4, 4.4, 4.4); Calibrated: 2018.5.31
- Sensor-Surface: 1.4mm (Mechanical Surface Detection)
- Electronics: DAE4 Sn1279; Calibrated: 2018.10.22
- Phantom: SAM2; Type: SAM; Serial: TP-1754
- Measurement SW: DASY52, Version 52.10 (1); SEMCAD X Version 14.6.11 (7439)

**Ch64/Area Scan (101x81x1):** Interpolated grid: dx=1.000 mm, dy=1.000 mm

Maximum value of SAR (interpolated) = 0.607 W/kg

**Ch64/Zoom Scan (8x8x7)/Cube 0:** Measurement grid: dx=4mm, dy=4mm, dz=1.4mm

Reference Value = 6.965 V/m; Power Drift = -0.17 dB

Peak SAR (extrapolated) = 1.11 W/kg

**SAR(1 g) = 0.261 W/kg; SAR(10 g) = 0.087 W/kg**

Maximum value of SAR (measured) = 0.617 W/kg

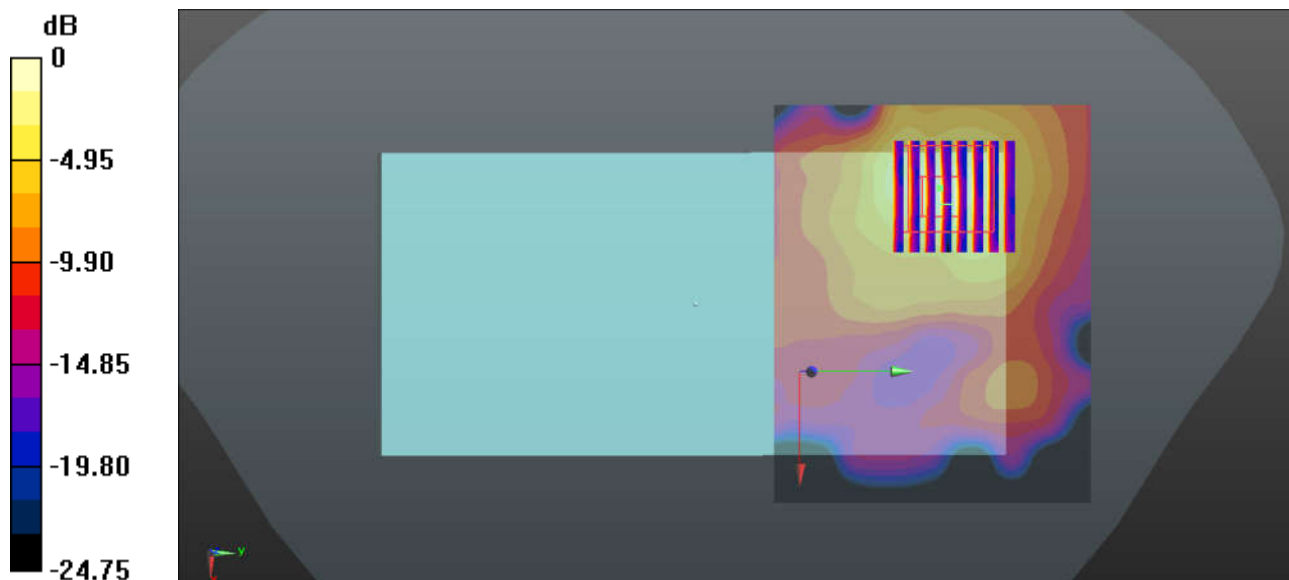

0 dB = 0.617 W/kg = -2.10 dBW/kg

### 34\_WLAN5.5GHz\_802.11a 6Mbps\_Back\_5mm\_Ch132

Communication System: UID 0, WIFI (0); Frequency: 5660 MHz; Duty Cycle: 1:1.051  
Medium: MSL\_5000 Medium parameters used:  $f = 5660$  MHz;  $\sigma = 6.004$  S/m;  $\epsilon_r = 46.992$ ;  $\rho = 1000$  kg/m<sup>3</sup>  
Ambient Temperature : 23.3 °C ; Liquid Temperature : 22. °C

#### DASY5 Configuration:

- Probe: EX3DV4 - SN3857; ConvF(3.98, 3.98, 3.98); Calibrated: 2018.5.31
- Sensor-Surface: 1.4mm (Mechanical Surface Detection)
- Electronics: DAE4 Sn1279; Calibrated: 2018.10.22
- Phantom: SAM2; Type: SAM; Serial: TP-1754
- Measurement SW: DASY52, Version 52.10 (1); SEMCAD X Version 14.6.11 (7439)

**Ch132/Area Scan (101x81x1):** Interpolated grid: dx=1.000 mm, dy=1.000 mm  
Maximum value of SAR (interpolated) = 1.41 W/kg

**Ch132/Zoom Scan (7x7x7)/Cube 0:** Measurement grid: dx=4mm, dy=4mm, dz=1.4mm  
Reference Value = 2.887 V/m; Power Drift = 0.04 dB  
Peak SAR (extrapolated) = 2.81 W/kg  
**SAR(1 g) = 0.584 W/kg; SAR(10 g) = 0.182 W/kg**  
Maximum value of SAR (measured) = 1.56 W/kg

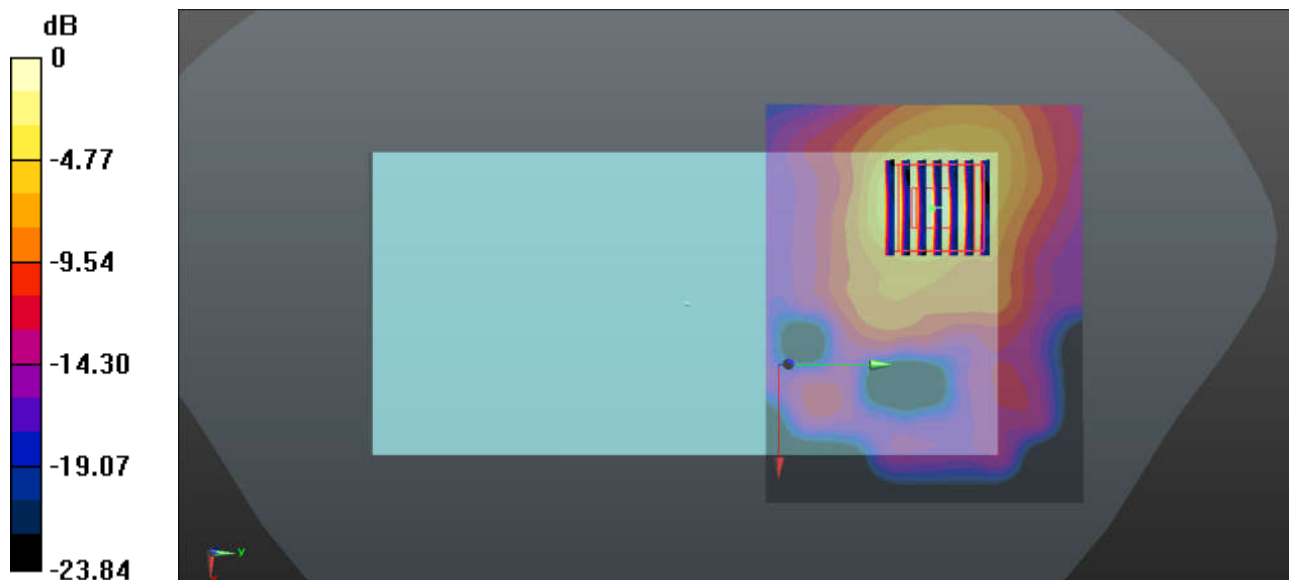

0 dB = 1.56 W/kg = 1.93 dBW/kg

### 35\_WLAN5.8GHz\_802.11a 6Mbps\_Back\_5mm\_Ch165

Communication System: UID 0, WIFI (0); Frequency: 5825 MHz; Duty Cycle: 1:1.051  
Medium: MSL\_5000 Medium parameters used:  $f = 5825$  MHz;  $\sigma = 6.228$  S/m;  $\epsilon_r = 46.741$ ;  $\rho = 1000$  kg/m<sup>3</sup>  
Ambient Temperature : 23.5 °C ; Liquid Temperature : 22.8 °C

#### DASY5 Configuration:

- Probe: EX3DV4 - SN3857; ConvF(4.31, 4.31, 4.31); Calibrated: 2018.5.31
- Sensor-Surface: 1.4mm (Mechanical Surface Detection)
- Electronics: DAE4 Sn1279; Calibrated: 2018.10.22
- Phantom: SAM2; Type: SAM; Serial: TP-1754
- Measurement SW: DASY52, Version 52.10 (1); SEMCAD X Version 14.6.11 (7439)

**Ch165/Area Scan (101x81x1):** Interpolated grid: dx=1.000 mm, dy=1.000 mm  
Maximum value of SAR (interpolated) = 0.959 W/kg

**Ch165/Zoom Scan (8x8x7)/Cube 0:** Measurement grid: dx=4mm, dy=4mm, dz=1.4mm  
Reference Value = 11.46 V/m; Power Drift = 0.01 dB  
Peak SAR (extrapolated) = 2.06 W/kg  
**SAR(1 g) = 0.408 W/kg; SAR(10 g) = 0.127 W/kg**  
Maximum value of SAR (measured) = 1.09 W/kg

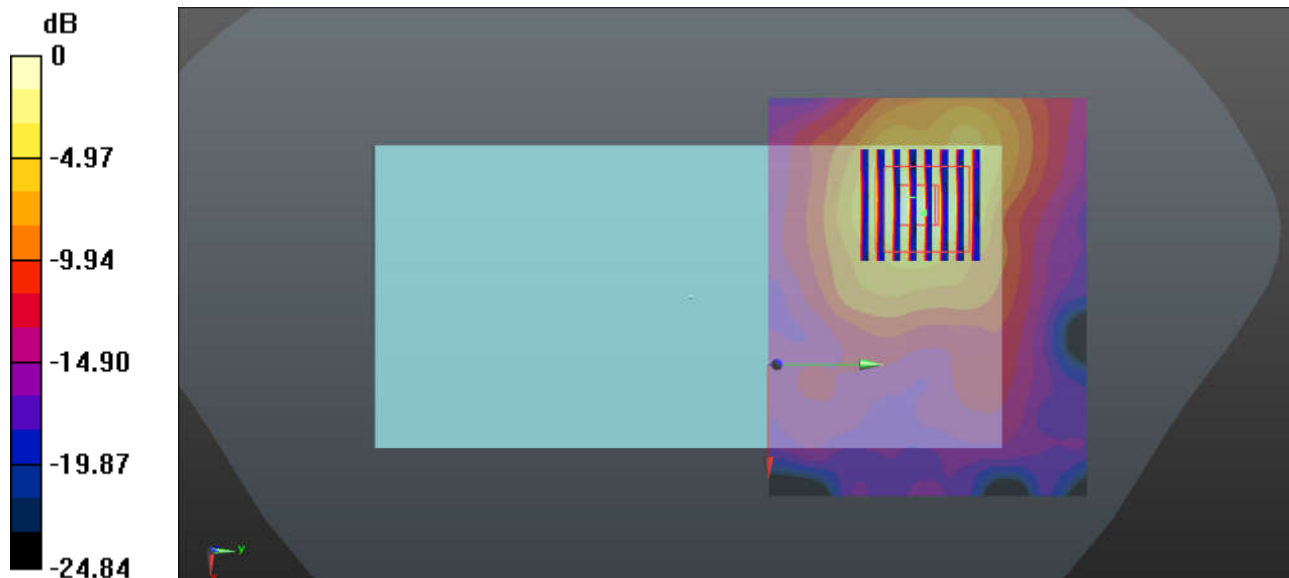

0 dB = 1.09 W/kg = 0.37 dBW/kg

### 36\_GSM850\_GPRS 3 Tx slots\_Front\_0mm\_Ch251

Communication System: UID 0, GSM850-3UP (0); Frequency: 848.8 MHz; Duty Cycle: 1:2.77  
 Medium: MSL\_835 Medium parameters used:  $f = 848.8 \text{ MHz}$ ;  $\sigma = 1.012 \text{ S/m}$ ;  $\epsilon_r = 54.518$ ;  $\rho = 1000 \text{ kg/m}^3$   
 Ambient Temperature :  $23.3 \text{ }^\circ\text{C}$  ; Liquid Temperature :  $22.6 \text{ }^\circ\text{C}$

#### DASY5 Configuration:

- Probe: EX3DV4 - SN3843; ConvF(9.03, 9.03, 9.03); Calibrated: 2018.9.27
- Sensor-Surface: 1.4mm (Mechanical Surface Detection)
- Electronics: DAE4 Sn1338; Calibrated: 2018.12.3
- Phantom: SAM2; Type: SAM; Serial: TP-1754
- Measurement SW: DASY52, Version 52.10 (1); SEMCAD X Version 14.6.11 (7439)

**Ch251/Area Scan (71x81x1):** Interpolated grid:  $dx=1.500 \text{ mm}$ ,  $dy=1.500 \text{ mm}$   
 Maximum value of SAR (interpolated) =  $3.93 \text{ W/kg}$

**Ch251/Zoom Scan (5x5x7)/Cube 0:** Measurement grid:  $dx=8\text{mm}$ ,  $dy=8\text{mm}$ ,  $dz=5\text{mm}$   
 Reference Value =  $8.451 \text{ V/m}$ ; Power Drift =  $-0.03 \text{ dB}$   
 Peak SAR (extrapolated) =  $8.05 \text{ W/kg}$   
**SAR(1 g) =  $3.12 \text{ W/kg}$ ; SAR(10 g) =  $1.53 \text{ W/kg}$**   
 Maximum value of SAR (measured) =  $6.05 \text{ W/kg}$

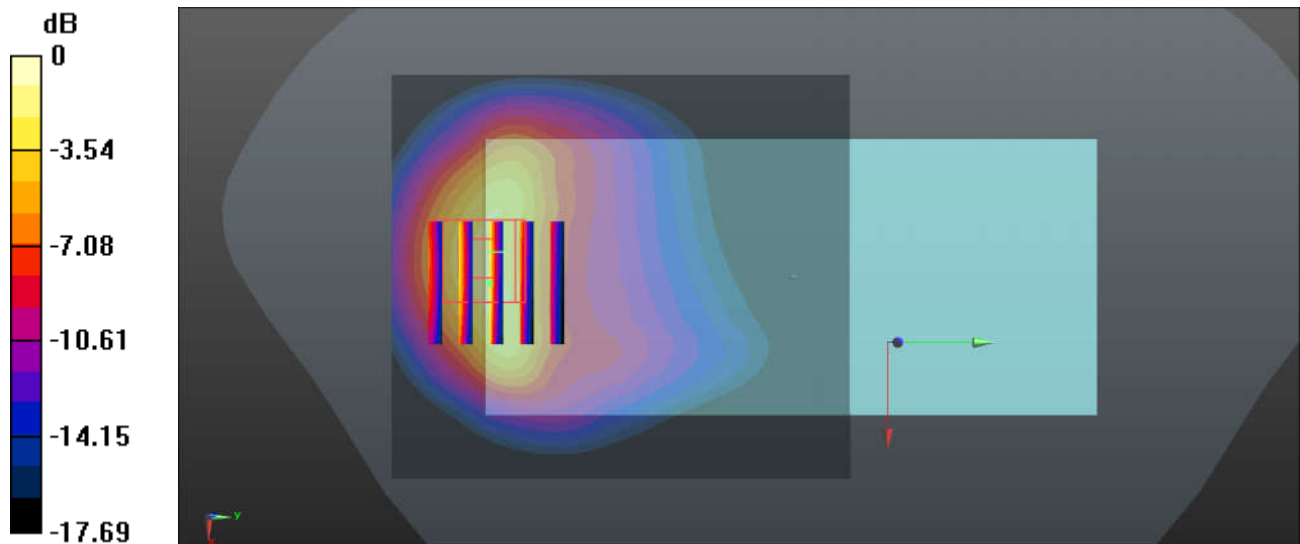

0 dB =  $6.05 \text{ W/kg} = 7.82 \text{ dBW/kg}$

**37\_GSM1900\_GPRS (3 Tx slots)\_Bottom Side\_0mm\_Ch810**

Communication System: UID 0, PCS-3UP (0); Frequency: 1909.8 MHz; Duty Cycle: 1:2.77  
 Medium: MSL\_1900 Medium parameters used:  $f = 1909.8$  MHz;  $\sigma = 1.564$  S/m;  $\epsilon_r = 52.638$ ;  $\rho = 1000$  kg/m<sup>3</sup>  
 Ambient Temperature : 23.4 °C ; Liquid Temperature : 22.8 °C

**DASY5 Configuration:**

- Probe: EX3DV4 - SN3843; ConvF(7.07, 7.07, 7.07); Calibrated: 2018.9.27
- Sensor-Surface: 1.4mm (Mechanical Surface Detection)
- Electronics: DAE4 Sn1338; Calibrated: 2018.12.3
- Phantom: SAM2; Type: SAM; Serial: TP-1754
- Measurement SW: DASY52, Version 52.10 (1); SEMCAD X Version 14.6.11 (7439)

**Ch810/Area Scan (41x61x1):** Interpolated grid: dx=1.500 mm, dy=1.500 mm  
 Maximum value of SAR (interpolated) = 6.77 W/kg

**Ch810/Zoom Scan (6x5x7)/Cube 0:** Measurement grid: dx=8mm, dy=8mm, dz=5mm  
 Reference Value = 28.45 V/m; Power Drift = 0.01 dB  
 Peak SAR (extrapolated) = 8.13 W/kg  
**SAR(1 g) = 3.59 W/kg; SAR(10 g) = 1.62 W/kg**  
 Maximum value of SAR (measured) = 6.31 W/kg

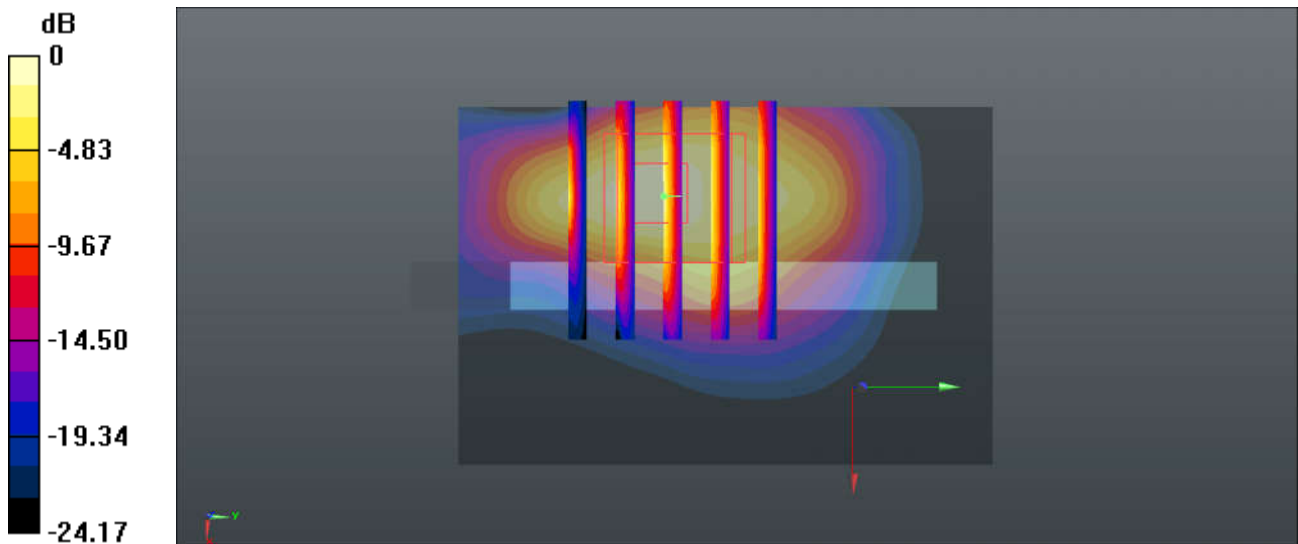

0 dB = 6.31 W/kg = 8.00 dBW/kg



### 38\_WCDMA Band V\_RMC 12.2Kbps\_Back\_0mm\_Ch4132

Communication System: UID 0, WCDMA (0); Frequency: 826.4 MHz; Duty Cycle: 1:1  
Medium: MSL\_835 Medium parameters used:  $f = 826.4$  MHz;  $\sigma = 0.99$  S/m;  $\epsilon_r = 54.727$ ;  $\rho = 1000$  kg/m<sup>3</sup>  
Ambient Temperature : 23.2 °C ; Liquid Temperature : 22.6 °C

#### DASY5 Configuration:

- Probe: EX3DV4 - SN3843; ConvF(9.03, 9.03, 9.03); Calibrated: 2018.9.27
- Sensor-Surface: 1.4mm (Mechanical Surface Detection)
- Electronics: DAE4 Sn1338; Calibrated: 2018.12.3
- Phantom: SAM2; Type: SAM; Serial: TP-1754
- Measurement SW: DASY52, Version 52.10 (1); SEMCAD X Version 14.6.11 (7439)

**Ch4132/Area Scan (71x81x1):** Interpolated grid: dx=1.500 mm, dy=1.500 mm  
Maximum value of SAR (interpolated) = 5.29 W/kg

**Ch4132/Zoom Scan (5x5x7)/Cube 0:** Measurement grid: dx=8mm, dy=8mm, dz=5mm  
Reference Value = 9.253 V/m; Power Drift = 0.09 dB  
Peak SAR (extrapolated) = 8.05 W/kg  
**SAR(1 g) = 2.68 W/kg; SAR(10 g) = 1.4 W/kg**  
Maximum value of SAR (measured) = 5.24 W/kg

**Ch4132/Zoom Scan (5x5x7)/Cube 1:** Measurement grid: dx=8mm, dy=8mm, dz=5mm  
Reference Value = 9.253 V/m; Power Drift = 0.09 dB  
Peak SAR (extrapolated) = 6.07 W/kg  
**SAR(1 g) = 2.67 W/kg; SAR(10 g) = 1.39 W/kg**  
Maximum value of SAR (measured) = 4.51 W/kg

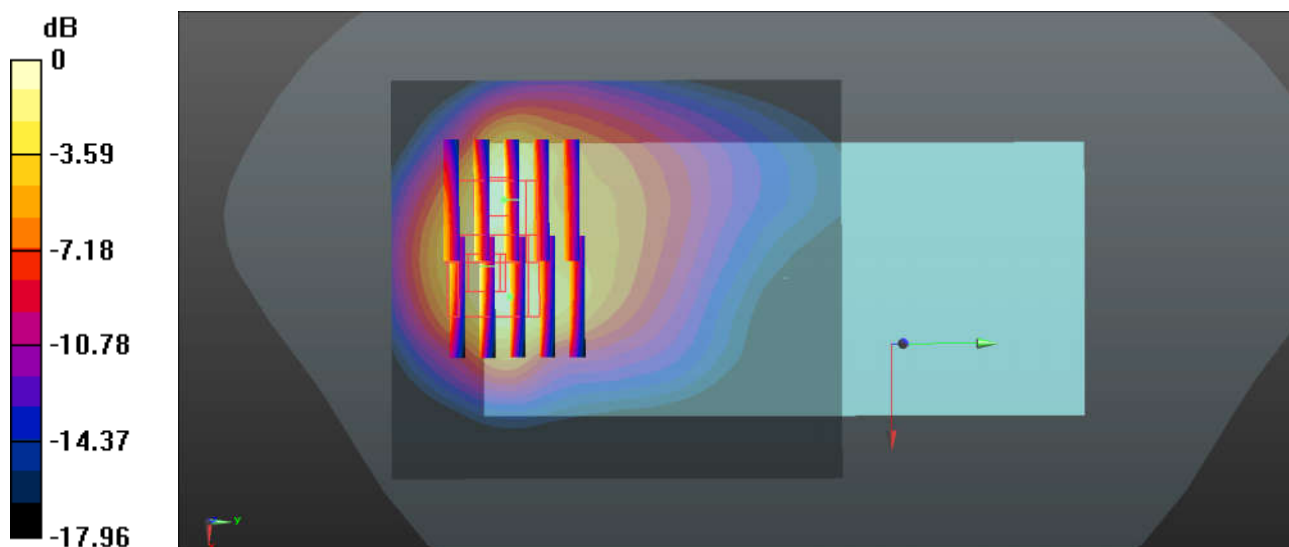

0 dB = 4.51 W/kg = 6.54 dBW/kg

### 39\_WCDMA Band II\_RMC 12.2Kbps\_Back\_0mm\_Ch9538

Communication System: UID 0, WCDMA (0); Frequency: 1907.6 MHz; Duty Cycle: 1:1  
 Medium: MSL\_1900 Medium parameters used:  $f = 1907.6$  MHz;  $\sigma = 1.562$  S/m;  $\epsilon_r = 52.642$ ;  $\rho = 1000$  kg/m<sup>3</sup>  
 Ambient Temperature : 23.0 °C ; Liquid Temperature : 22.0 °C

**DASY5 Configuration:**

- Probe: EX3DV4 - SN3843; ConvF(7.07, 7.07, 7.07); Calibrated: 2018.9.27
- Sensor-Surface: 1.4mm (Mechanical Surface Detection)
- Electronics: DAE4 Sn1338; Calibrated: 2018.12.3
- Phantom: SAM2; Type: SAM; Serial: TP-1754
- Measurement SW: DASY52, Version 52.10 (1); SEMCAD X Version 14.6.11 (7439)

**Ch9538/Area Scan (71x71x1):** Interpolated grid: dx=1.500 mm, dy=1.500 mm  
 Maximum value of SAR (interpolated) = 5.40 W/kg

**Ch9538/Zoom Scan (6x5x7)/Cube 0:** Measurement grid: dx=8mm, dy=8mm, dz=5mm  
 Reference Value = 3.239 V/m; Power Drift = 0.07 dB  
 Peak SAR (extrapolated) = 6.57 W/kg  
**SAR(1 g) = 3.16 W/kg; SAR(10 g) = 1.78 W/kg**  
 Maximum value of SAR (measured) = 4.99 W/kg

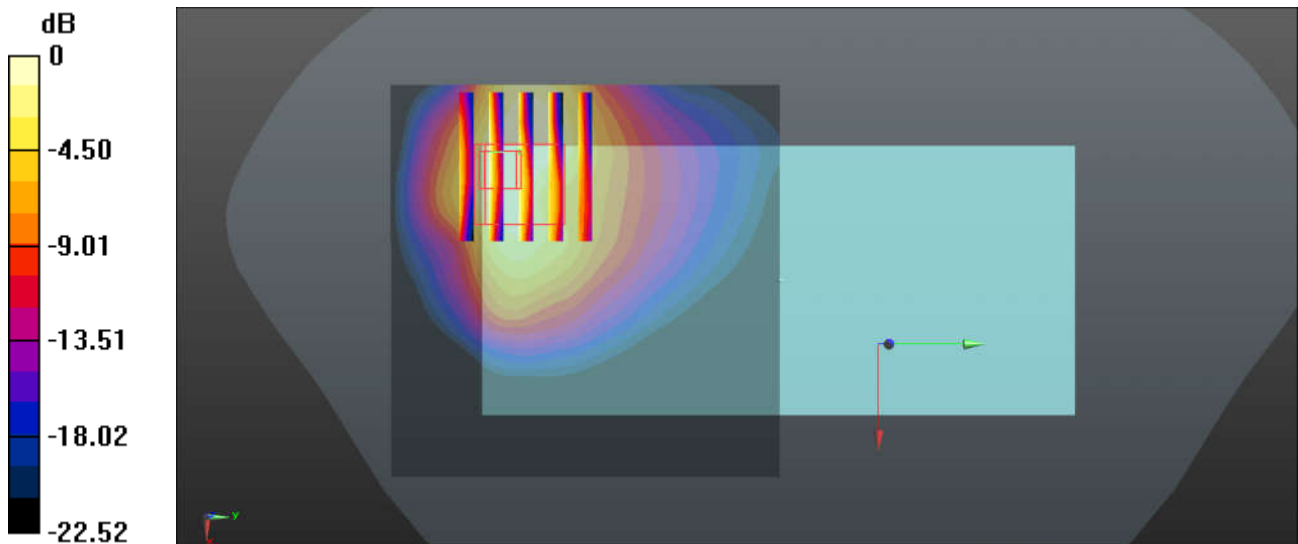

0 dB = 4.99 W/kg = 6.98 dBW/kg

**40\_LTE Band 5\_10M\_QPSK\_1RB\_0Offset\_Front\_0mm\_Ch20525**

Communication System: UID 0, LTE-FDD (0); Frequency: 836.5 MHz; Duty Cycle: 1:1  
 Medium: MSL\_835 Medium parameters used:  $f = 836.5$  MHz;  $\sigma = 0.999$  S/m;  $\epsilon_r = 54.633$ ;  $\rho = 1000$  kg/m<sup>3</sup>  
 Ambient Temperature : 23.3 °C ; Liquid Temperature : 22.6 °C

**DASY5 Configuration:**

- Probe: EX3DV4 - SN3843; ConvF(9.03, 9.03, 9.03); Calibrated: 2018.9.27
- Sensor-Surface: 1.4mm (Mechanical Surface Detection)
- Electronics: DAE4 Sn1338; Calibrated: 2018.12.3
- Phantom: SAM2; Type: SAM; Serial: TP-1754
- Measurement SW: DASY52, Version 52.10 (1); SEMCAD X Version 14.6.11 (7439)

**Ch20525/Area Scan (71x81x1):** Interpolated grid: dx=1.500 mm, dy=1.500 mm  
 Maximum value of SAR (interpolated) = 3.81 W/kg

**Ch20525/Zoom Scan (5x5x7)/Cube 0:** Measurement grid: dx=8mm, dy=8mm, dz=5mm  
 Reference Value = 8.809 V/m; Power Drift = -0.03 dB  
 Peak SAR (extrapolated) = 7.16 W/kg  
**SAR(1 g) = 3.22 W/kg; SAR(10 g) = 1.66 W/kg**  
 Maximum value of SAR (measured) = 5.48 W/kg

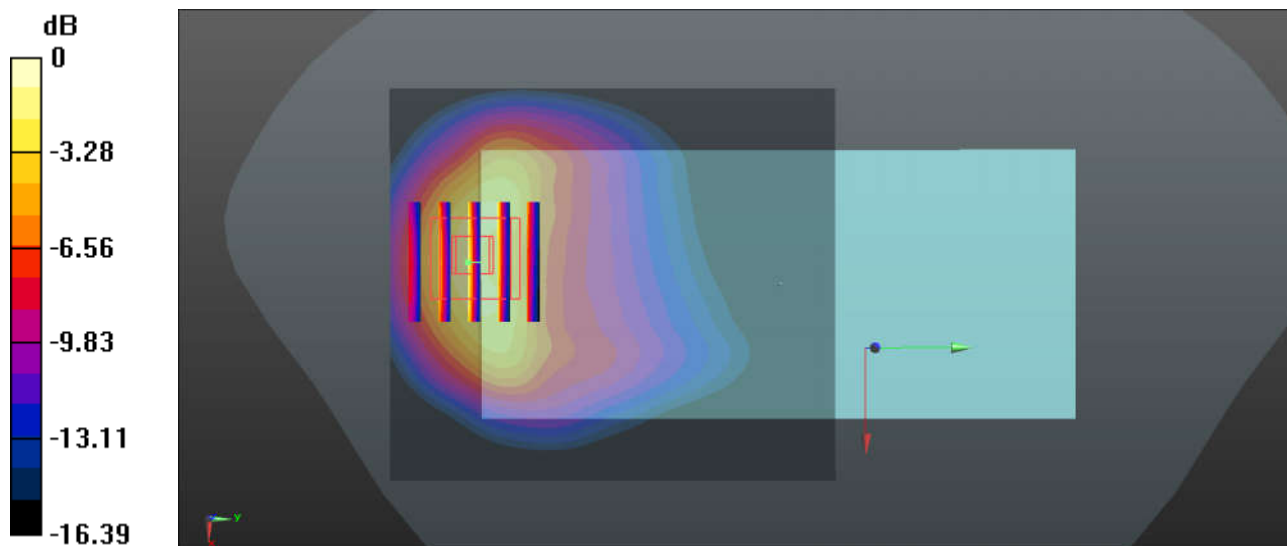

0 dB = 5.48 W/kg = 7.39 dBW/kg

**41\_LTE Band 7\_20M\_QPSK\_1RB\_0Offset\_Bottom Side\_0mm\_Ch21100**

Communication System: UID 0, LTE-FDD (0); Frequency: 2535 MHz; Duty Cycle: 1:1  
 Medium: MSL\_2600 Medium parameters used:  $f = 2535$  MHz;  $\sigma = 2.092$  S/m;  $\epsilon_r = 51.965$ ;  $\rho = 1000$  kg/m<sup>3</sup>  
 Ambient Temperature : 23.3 °C ; Liquid Temperature : 22.7 °C

**DASY5 Configuration:**

- Probe: EX3DV4 - SN3843; ConvF(7.02, 7.02, 7.02); Calibrated: 2018.9.27
- Sensor-Surface: 1.4mm (Mechanical Surface Detection)
- Electronics: DAE4 Sn1338; Calibrated: 2018.12.3
- Phantom: SAM2; Type: SAM; Serial: TP-1754
- Measurement SW: DASY52, Version 52.10 (1); SEMCAD X Version 14.6.11 (7439)

**Ch21100/Area Scan (51x81x1):** Interpolated grid: dx=1.200 mm, dy=1.200 mm  
 Maximum value of SAR (interpolated) = 16.1 W/kg

**Ch21100/Zoom Scan (7x7x7)/Cube 0:** Measurement grid: dx=5mm, dy=5mm, dz=5mm  
 Reference Value = 3.774 V/m; Power Drift = 0.04 dB  
 Peak SAR (extrapolated) = 19.8 W/kg  
**SAR(1 g) = 6.8 W/kg; SAR(10 g) = 2.23 W/kg**  
 Maximum value of SAR (measured) = 14.2 W/kg

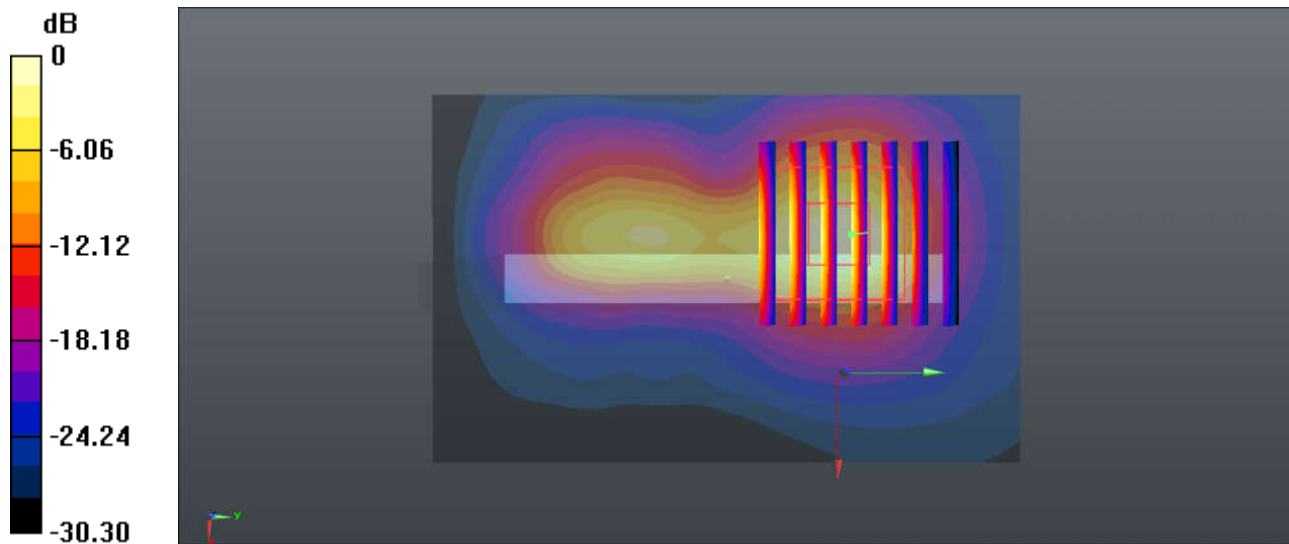

0 dB = 14.2 W/kg = 11.52 dBW/kg

**42\_LTE Band 41\_20M\_QPSK\_1\_0\_Back\_0mm\_Ch41140**

Communication System: UID 0, LTE-TDD (0); Frequency: 2645 MHz; Duty Cycle: 1:1.59  
 Medium: MSL\_2600 Medium parameters used:  $f = 2645$  MHz;  $\sigma = 2.243$  S/m;  $\epsilon_r = 51.571$ ;  $\rho = 1000$  kg/m<sup>3</sup>  
 Ambient Temperature : 23.3 °C ; Liquid Temperature : 22.7 °C

**DASY5 Configuration:**

- Probe: EX3DV4 - SN3843; ConvF(6.7, 6.7, 6.7); Calibrated: 2018.9.27
- Sensor-Surface: 1.4mm (Mechanical Surface Detection)
- Electronics: DAE4 Sn1338; Calibrated: 2018.12.3
- Phantom: SAM2; Type: SAM; Serial: TP-1754
- Measurement SW: DASY52, Version 52.10 (1); SEMCAD X Version 14.6.11 (7439)

**Ch41140/Area Scan (91x91x1):** Interpolated grid: dx=1.200 mm, dy=1.200 mm  
 Maximum value of SAR (interpolated) = 9.45 W/kg

**Ch41140/Zoom Scan (7x7x7)/Cube 0:** Measurement grid: dx=5mm, dy=5mm, dz=5mm  
 Reference Value = 1.820 V/m; Power Drift = 0.02 dB  
 Peak SAR (extrapolated) = 13.8 W/kg  
**SAR(1 g) = 4.53 W/kg; SAR(10 g) = 1.58 W/kg**  
 Maximum value of SAR (measured) = 8.97 W/kg

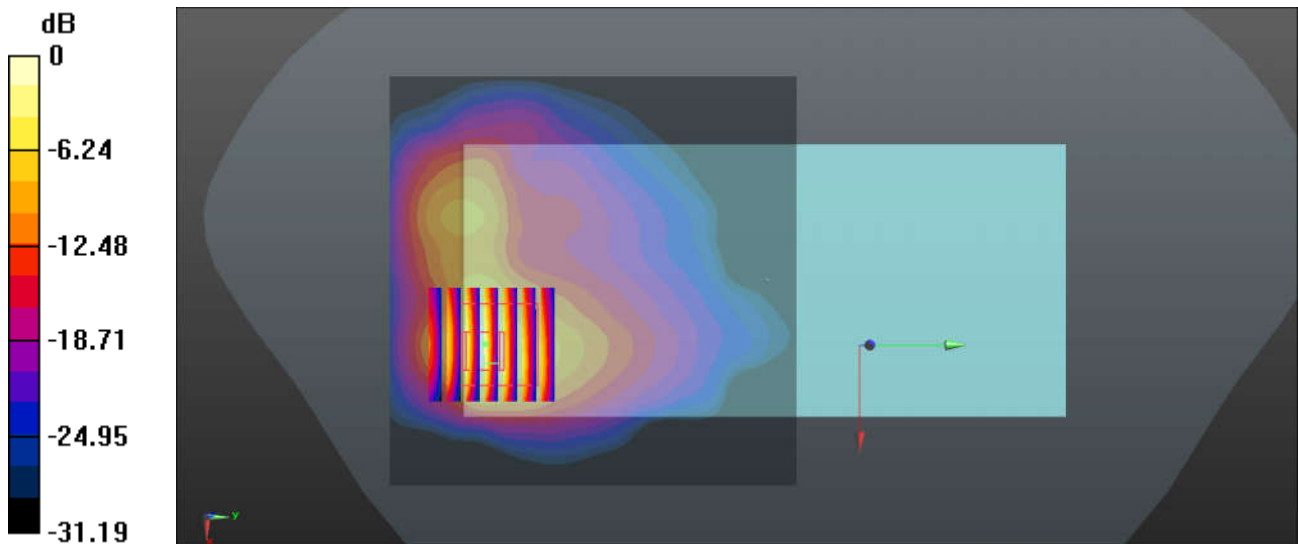

0 dB = 8.97 W/kg = 9.53 dBW/kg

### 43\_WLAN5.3GHz\_802.11a 6Mbps\_Back\_0mm\_Ch64

Communication System: UID 0, WIFI (0); Frequency: 5320 MHz; Duty Cycle: 1:1.051  
Medium: MSL\_5000 Medium parameters used:  $f = 5320$  MHz;  $\sigma = 5.554$  S/m;  $\epsilon_r = 47.55$ ;  $\rho = 1000$  kg/m<sup>3</sup>  
Ambient Temperature : 23.4 °C ; Liquid Temperature : 22.9 °C

#### DASY5 Configuration:

- Probe: EX3DV4 - SN3857; ConvF(4.4, 4.4, 4.4); Calibrated: 2018.5.31
- Sensor-Surface: 1.4mm (Mechanical Surface Detection)
- Electronics: DAE4 Sn1279; Calibrated: 2018.10.22
- Phantom: SAM2; Type: SAM; Serial: TP-1754
- Measurement SW: DASY52, Version 52.10 (1); SEMCAD X Version 14.6.11 (7439)

**Ch64/Area Scan (101x81x1):** Interpolated grid: dx=1.000 mm, dy=1.000 mm  
Maximum value of SAR (interpolated) = 3.22 W/kg

**Ch64/Zoom Scan (9x9x7)/Cube 0:** Measurement grid: dx=4mm, dy=4mm, dz=1.4mm  
Reference Value = 3.402 V/m; Power Drift = 0.04 dB  
Peak SAR (extrapolated) = 6.75 W/kg  
**SAR(1 g) = 1.56 W/kg; SAR(10 g) = 0.455 W/kg**  
Maximum value of SAR (measured) = 3.70 W/kg

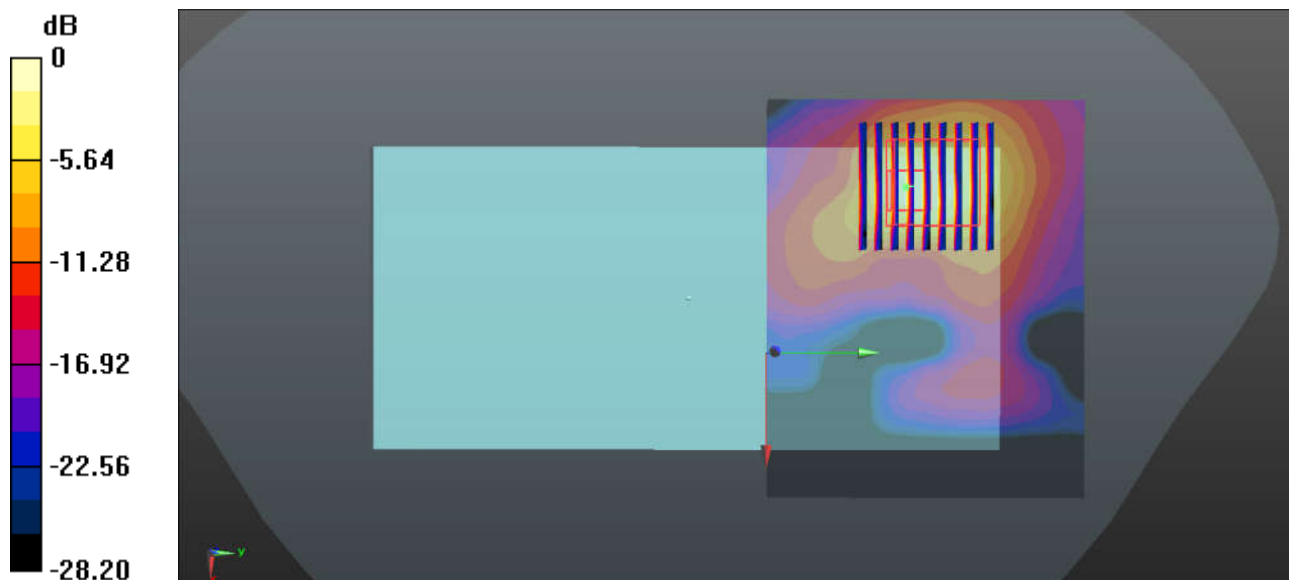

0 dB = 3.70 W/kg = 5.68 dBW/kg

### 44\_WLAN5.5GHz\_802.11a 6Mbps\_Back\_0mm\_Ch132

Communication System: UID 0, WIFI (0); Frequency: 5660 MHz; Duty Cycle: 1:1.051  
Medium: MSL\_5000 Medium parameters used:  $f = 5660$  MHz;  $\sigma = 6.004$  S/m;  $\epsilon_r = 46.992$ ;  $\rho = 1000$  kg/m<sup>3</sup>  
Ambient Temperature : 23.3 °C ; Liquid Temperature : 22.7 °C

#### DASY5 Configuration:

- Probe: EX3DV4 - SN3857; ConvF(3.98, 3.98, 3.98); Calibrated: 2018.5.31
- Sensor-Surface: 1.4mm (Mechanical Surface Detection)
- Electronics: DAE4 Sn1279; Calibrated: 2018.10.22
- Phantom: SAM2; Type: SAM; Serial: TP-1754
- Measurement SW: DASY52, Version 52.10 (1); SEMCAD X Version 14.6.11 (7439)

**Ch132/Area Scan (101x81x1):** Interpolated grid: dx=1.000 mm, dy=1.000 mm  
Maximum value of SAR (interpolated) = 4.52 W/kg

**Ch132/Zoom Scan (8x8x7)/Cube 0:** Measurement grid: dx=4mm, dy=4mm, dz=1.4mm  
Reference Value = 1.924 V/m; Power Drift = 0.02 dB  
Peak SAR (extrapolated) = 11.4 W/kg  
**SAR(1 g) = 2.29 W/kg; SAR(10 g) = 0.594 W/kg**  
Maximum value of SAR (measured) = 6.26 W/kg

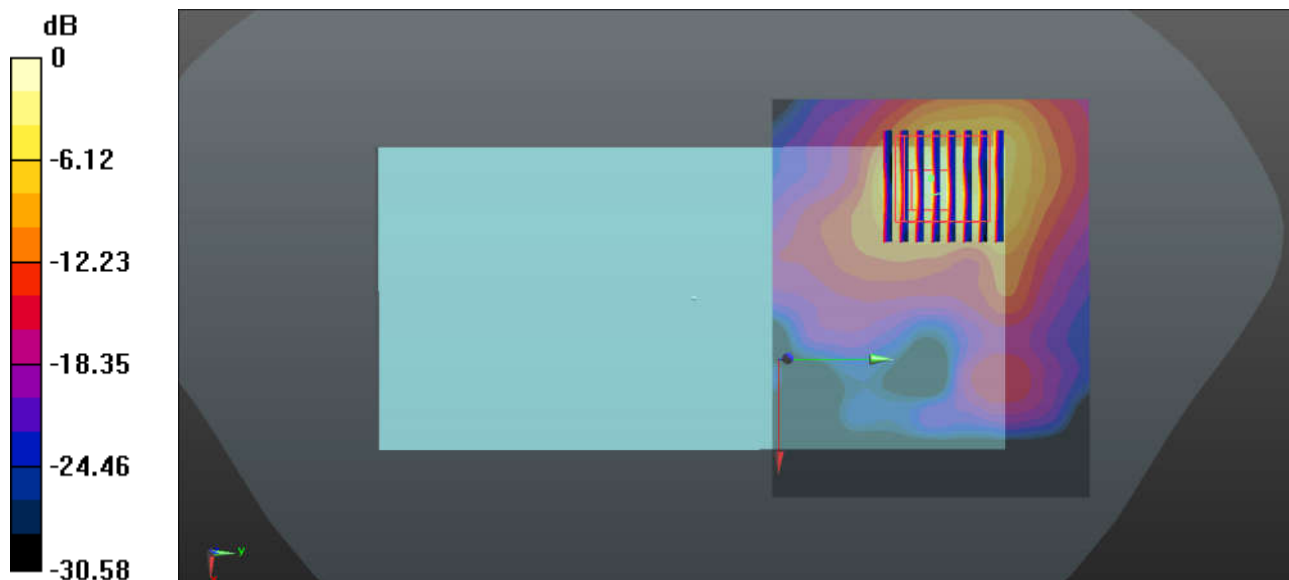

0 dB = 6.26 W/kg = 7.97 dBW/kg



## **Appendix C. DASYS Calibration Certificate**

The DASYS calibration certificates are shown as follows.





Accredited by the Swiss Accreditation Service (SAS)  
The Swiss Accreditation Service is one of the signatories to the EA  
Multilateral Agreement for the recognition of calibration certificates

Accreditation No.: **SCS 0108**

Client: **Sporton (Auden)**

Certificate No.: **D835V2-4d151\_Mar18**

**CALIBRATION CERTIFICATE**

Object: **D835V2 - SN:4d151**

Calibration procedure(s): **QA CAL-05.v10  
Calibration procedure for dipole validation kits above 700 MHz**

Calibration date: **March 26, 2018**

This calibration certificate documents the traceability to national standards, which realize the physical units of measurements (SI).  
The measurements and the uncertainties with confidence probability are given on the following pages and are part of the certificate.

All calibrations have been conducted in the closed laboratory facility: environment temperature (22 ± 3)°C and humidity < 70%.

Calibration Equipment used (M&TE critical for calibration)

Primary Standards	ID #	Cal Date (Certificate No.)	Scheduled Calibration
Power meter NRP	SN: 104778	04-Apr-17 (No. 217-02521/02522)	Apr-18
Power sensor NRP-Z91	SN: 103244	04-Apr-17 (No. 217-02521)	Apr-18
Power sensor NRP-Z91	SN: 103245	04-Apr-17 (No. 217-02522)	Apr-18
Reference 20 dB Attenuator	SN: 5058 (20k)	07-Apr-17 (No. 217-02528)	Apr-18
Type-N mismatch combination	SN: 5047.2 / 06327	07-Apr-17 (No. 217-02529)	Apr-18
Reference Probe EX3DV4	SN: 7349	30-Dec-17 (No. EX3-7349_Dec17)	Dec-18
DAE4	SN: 601	26-Oct-17 (No. DAE4-601_Oct17)	Oct-18
Secondary Standards	ID #	Check Date (in house)	Scheduled Check
Power meter EPM-442A	SN: GB37480704	07-Oct-15 (in house check Oct-16)	In house check: Oct-18
Power sensor HP 8481A	SN: US37292783	07-Oct-15 (in house check Oct-16)	In house check: Oct-18
Power sensor HP 8481A	SN: MY41092317	07-Oct-15 (in house check Oct-16)	In house check: Oct-18
RF generator R&S SMT-06	SN: 100972	15-Jun-15 (in house check Oct-16)	In house check: Oct-18
Network Analyzer HP 8753E	SN: US37390585	18-Oct-01 (in house check Oct-17)	In house check: Oct-18

Calibrated by: **Michael Weber** (Name), **Laboratory Technician** (Function), *[Signature]* (Signature)

Approved by: **Katja Pokovic** (Name), **Technical Manager** (Function), *[Signature]* (Signature)

Issued: March 26, 2018

This calibration certificate shall not be reproduced except in full without written approval of the laboratory.



Accredited by the Swiss Accreditation Service (SAS)

The Swiss Accreditation Service is one of the signatories to the EA  
Multilateral Agreement for the recognition of calibration certificates

Accreditation No.: **SCS 0108**

### Glossary:

TSL	tissue simulating liquid
ConvF	sensitivity in TSL / NORM x,y,z
N/A	not applicable or not measured

### Calibration is Performed According to the Following Standards:

- IEEE Std 1528-2013, "IEEE Recommended Practice for Determining the Peak Spatial-Averaged Specific Absorption Rate (SAR) in the Human Head from Wireless Communications Devices: Measurement Techniques", June 2013
- IEC 62209-1, "Measurement procedure for the assessment of Specific Absorption Rate (SAR) from hand-held and body-mounted devices used next to the ear (frequency range of 300 MHz to 6 GHz)", July 2016
- IEC 62209-2, "Procedure to determine the Specific Absorption Rate (SAR) for wireless communication devices used in close proximity to the human body (frequency range of 30 MHz to 6 GHz)", March 2010
- KDB 865664, "SAR Measurement Requirements for 100 MHz to 6 GHz"

### Additional Documentation:

- DASY4/5 System Handbook

### Methods Applied and Interpretation of Parameters:

- Measurement Conditions:** Further details are available from the Validation Report at the end of the certificate. All figures stated in the certificate are valid at the frequency indicated.
- Antenna Parameters with TSL:** The dipole is mounted with the spacer to position its feed point exactly below the center marking of the flat phantom section, with the arms oriented parallel to the body axis.
- Feed Point Impedance and Return Loss:** These parameters are measured with the dipole positioned under the liquid filled phantom. The impedance stated is transformed from the measurement at the SMA connector to the feed point. The Return Loss ensures low reflected power. No uncertainty required.
- Electrical Delay:** One-way delay between the SMA connector and the antenna feed point. No uncertainty required.
- SAR measured:** SAR measured at the stated antenna input power.
- SAR normalized:** SAR as measured, normalized to an input power of 1 W at the antenna connector.
- SAR for nominal TSL parameters:** The measured TSL parameters are used to calculate the nominal SAR result.

The reported uncertainty of measurement is stated as the standard uncertainty of measurement multiplied by the coverage factor  $k=2$ , which for a normal distribution corresponds to a coverage probability of approximately 95%.

## Measurement Conditions

DASY system configuration, as far as not given on page 1.

<b>DASY Version</b>	DASY5	V52.10.0
<b>Extrapolation</b>	Advanced Extrapolation	
<b>Phantom</b>	Modular Flat Phantom	
<b>Distance Dipole Center - TSL</b>	15 mm	with Spacer
<b>Zoom Scan Resolution</b>	dx, dy, dz = 5 mm	
<b>Frequency</b>	835 MHz $\pm$ 1 MHz	

## Head TSL parameters

The following parameters and calculations were applied.

	Temperature	Permittivity	Conductivity
<b>Nominal Head TSL parameters</b>	22.0 °C	41.5	0.90 mho/m
<b>Measured Head TSL parameters</b>	(22.0 $\pm$ 0.2) °C	41.1 $\pm$ 6 %	0.91 mho/m $\pm$ 6 %
<b>Head TSL temperature change during test</b>	< 0.5 °C	----	----

## SAR result with Head TSL

<b>SAR averaged over 1 cm<sup>3</sup> (1 g) of Head TSL</b>	Condition	
SAR measured	250 mW input power	2.44 W/kg
SAR for nominal Head TSL parameters	normalized to 1W	<b>9.66 W/kg <math>\pm</math> 17.0 % (k=2)</b>

<b>SAR averaged over 10 cm<sup>3</sup> (10 g) of Head TSL</b>	condition	
SAR measured	250 mW input power	1.57 W/kg
SAR for nominal Head TSL parameters	normalized to 1W	<b>6.23 W/kg <math>\pm</math> 16.5 % (k=2)</b>

## Body TSL parameters

The following parameters and calculations were applied.

	Temperature	Permittivity	Conductivity
<b>Nominal Body TSL parameters</b>	22.0 °C	55.2	0.97 mho/m
<b>Measured Body TSL parameters</b>	(22.0 $\pm$ 0.2) °C	54.5 $\pm$ 6 %	0.99 mho/m $\pm$ 6 %
<b>Body TSL temperature change during test</b>	< 0.5 °C	----	----

## SAR result with Body TSL

<b>SAR averaged over 1 cm<sup>3</sup> (1 g) of Body TSL</b>	Condition	
SAR measured	250 mW input power	2.44 W/kg
SAR for nominal Body TSL parameters	normalized to 1W	<b>9.58 W/kg <math>\pm</math> 17.0 % (k=2)</b>

<b>SAR averaged over 10 cm<sup>3</sup> (10 g) of Body TSL</b>	condition	
SAR measured	250 mW input power	1.60 W/kg
SAR for nominal Body TSL parameters	normalized to 1W	<b>6.31 W/kg <math>\pm</math> 16.5 % (k=2)</b>

## Appendix (Additional assessments outside the scope of SCS 0108)

### Antenna Parameters with Head TSL

Impedance, transformed to feed point	51.3 $\Omega$ - 2.3 j $\Omega$
Return Loss	- 31.7 dB

### Antenna Parameters with Body TSL

Impedance, transformed to feed point	48.4 $\Omega$ - 4.8 j $\Omega$
Return Loss	- 25.8 dB

### General Antenna Parameters and Design

Electrical Delay (one direction)	1.392 ns
----------------------------------	----------

After long term use with 100W radiated power, only a slight warming of the dipole near the feedpoint can be measured.

The dipole is made of standard semirigid coaxial cable. The center conductor of the feeding line is directly connected to the second arm of the dipole. The antenna is therefore short-circuited for DC-signals. On some of the dipoles, small end caps are added to the dipole arms in order to improve matching when loaded according to the position as explained in the "Measurement Conditions" paragraph. The SAR data are not affected by this change. The overall dipole length is still according to the Standard.

No excessive force must be applied to the dipole arms, because they might bend or the soldered connections near the feedpoint may be damaged.

### Additional EUT Data

Manufactured by	SPEAG
Manufactured on	March 27, 2012

## DASY5 Validation Report for Head TSL

Date: 26.03.2018

Test Laboratory: SPEAG, Zurich, Switzerland

**DUT: Dipole 835 MHz; Type: D835V2; Serial: D835V2 - SN:4d151**

Communication System: UID 0 - CW; Frequency: 835 MHz

Medium parameters used:  $f = 835$  MHz;  $\sigma = 0.91$  S/m;  $\epsilon_r = 41.1$ ;  $\rho = 1000$  kg/m<sup>3</sup>

Phantom section: Flat Section

Measurement Standard: DASY5 (IEEE/IEC/ANSI C63.19-2011)

DASY52 Configuration:

- Probe: EX3DV4 - SN7349; ConvF(9.9, 9.9, 9.9); Calibrated: 30.12.2017;
- Sensor-Surface: 1.4mm (Mechanical Surface Detection)
- Electronics: DAE4 Sn601; Calibrated: 26.10.2017
- Phantom: Flat Phantom 4.9 (front); Type: QD 00L P49 AA; Serial: 1001
- DASY52 52.10.0(1446); SEMCAD X 14.6.10(7417)

**Dipole Calibration for Head Tissue/Pin=250 mW, d=15mm/Zoom Scan (7x7x7)/Cube 0:**

Measurement grid: dx=5mm, dy=5mm, dz=5mm

Reference Value = 63.64 V/m; Power Drift = -0.06 dB

Peak SAR (extrapolated) = 3.78 W/kg

**SAR(1 g) = 2.44 W/kg; SAR(10 g) = 1.57 W/kg**

Maximum value of SAR (measured) = 3.32 W/kg



0 dB = 3.32 W/kg = 5.21 dBW/kg

# Impedance Measurement Plot for Head TSL

CH1 S11 1 U FS 1: 51.285  $\Omega$  -2.3125  $\Omega$  82.424 pF 26 Mar 2018 09:10:38  
 835.000 000 MHz

\*  
 Del  
 Cor  
 Avg  
 16  
 H1 d

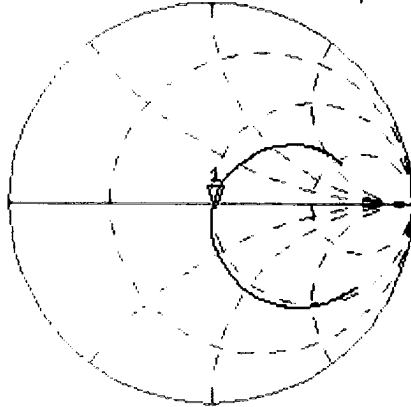

CH2 S11 LOG 5 dB/REF -20 dB 1:-31.655 dB 835.000 000 MHz

Cor  
 Avg  
 16  
 H1 d

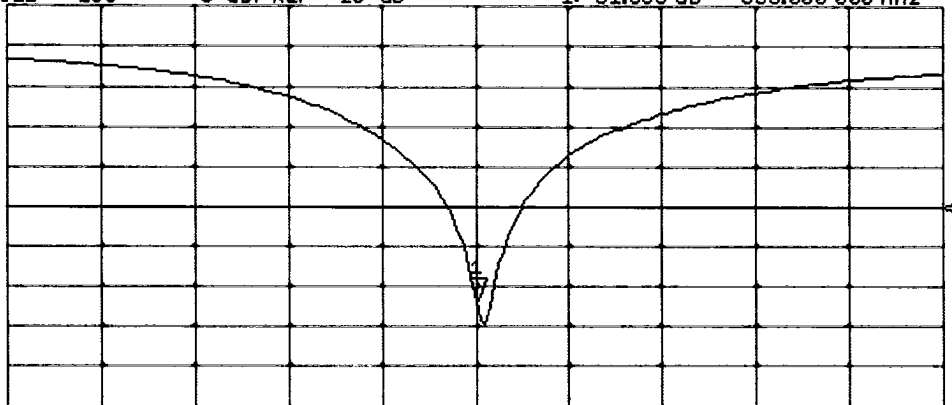

START 635.000 000 MHz STOP 1 035.000 000 MHz

# DASY5 Validation Report for Body TSL

Date: 26.03.2018

Test Laboratory: SPEAG, Zurich, Switzerland

**DUT: Dipole 835 MHz; Type: D835V2; Serial: D835V2 - SN:4d151**

Communication System: UID 0 - CW; Frequency: 835 MHz

Medium parameters used:  $f = 835 \text{ MHz}$ ;  $\sigma = 0.99 \text{ S/m}$ ;  $\epsilon_r = 54.5$ ;  $\rho = 1000 \text{ kg/m}^3$

Phantom section: Flat Section

Measurement Standard: DASY5 (IEEE/IEC/ANSI C63.19-2011)

DASY52 Configuration:

- Probe: EX3DV4 - SN7349; ConvF(10.05, 10.05, 10.05); Calibrated: 30.12.2017;
- Sensor-Surface: 1.4mm (Mechanical Surface Detection)
- Electronics: DAE4 Sn601; Calibrated: 26.10.2017
- Phantom: Flat Phantom 4.9 (Back); Type: QD 00R P49 AA; Serial: 1005
- DASY52 52.10.0(1446); SEMCAD X 14.6.10(7417)

## Dipole Calibration for Body Tissue/Pin=250 mW, d=15mm/Zoom Scan (7x7x7)/Cube 0:

Measurement grid:  $dx=5\text{mm}$ ,  $dy=5\text{mm}$ ,  $dz=5\text{mm}$

Reference Value = 60.45 V/m; Power Drift = -0.07 dB

Peak SAR (extrapolated) = 3.64 W/kg

**SAR(1 g) = 2.44 W/kg; SAR(10 g) = 1.6 W/kg**

Maximum value of SAR (measured) = 3.21 W/kg

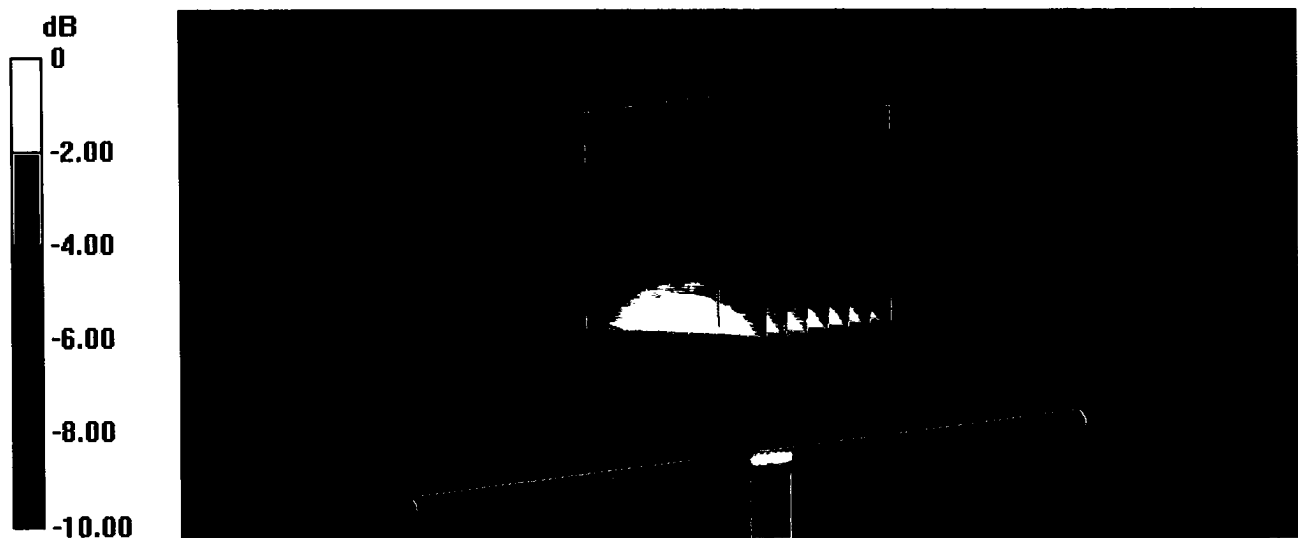

0 dB = 3.21 W/kg = 5.07 dBW/kg

# Impedance Measurement Plot for Body TSL

26 Mar 2018 09:06:56  
CH1 S11 1 U FS 1: 48.365  $\Omega$  -4.7500  $\Omega$  40.127 pF 835.000 000 MHz

\*  
De1  
Cor

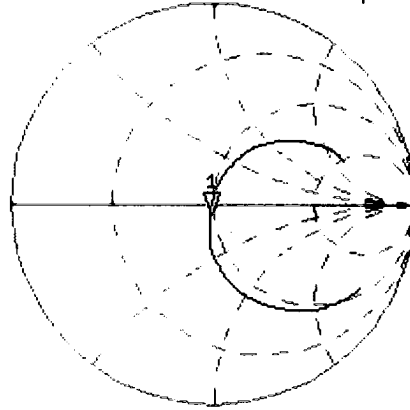

Avg  
16

H1d

CH2 S11 LOG 5 dB/ REF -20 dB 1: -25.849 dB 835.000 000 MHz

Cor

Avg  
16

H1d

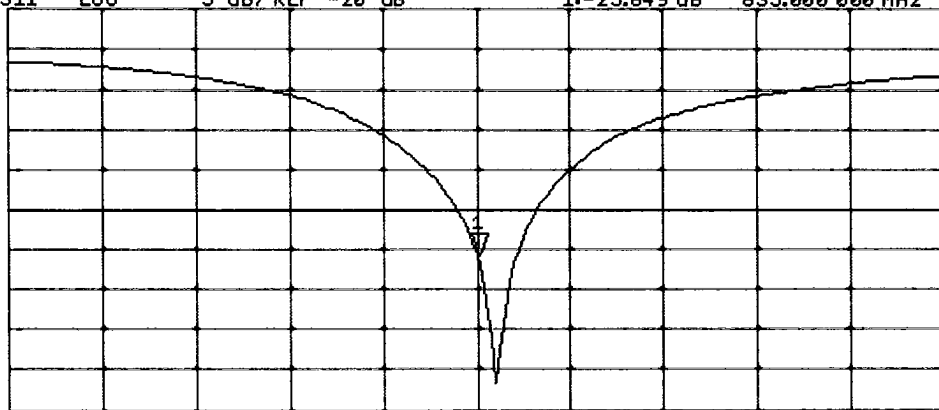

START 635.000 000 MHz

STOP 1 035.000 000 MHz





In Collaboration with  
**s p e a g**  
CALIBRATION LABORATORY



中国认可  
国际互认  
校准  
CALIBRATION  
CNAS L0570

Add: No.51 Xueyuan Road, Haidian District, Beijing, 100191, China  
Tel: +86-10-62304633-2079 Fax: +86-10-62304633-2504  
E-mail: cttl@chinattl.com http://www.chinattl.cn

Client **Sporton**

Certificate No: **Z18-60049**

## CALIBRATION CERTIFICATE

Object **D1900V2 - SN: 5d170**

Calibration Procedure(s) **FF-Z11-003-01**  
**Calibration Procedures for dipole validation kits**

Calibration date: **March 25, 2018**

This calibration Certificate documents the traceability to national standards, which realize the physical units of measurements(SI). The measurements and the uncertainties with confidence probability are given on the following pages and are part of the certificate.

All calibrations have been conducted in the closed laboratory facility: environment temperature(22±3)°C and humidity<70%.

Calibration Equipment used (M&TE critical for calibration)

Primary Standards	ID #	Cal Date(Calibrated by, Certificate No.)	Scheduled Calibration
Power Meter NRVD	102083	01-Nov-17 (CTTL, No.J17X08756)	Oct-18
Power sensor NRV-Z5	100542	01-Nov-17 (CTTL, No.J17X08756)	Oct-18
Reference Probe EX3DV4	SN 7464	12-Sep-17(SPEAG,No.EX3-7464_Sep17)	Sep-18
DAE4	SN 1525	02-Oct-17(SPEAG,No.DAE4-1525_Oct17)	Oct-18
Secondary Standards	ID #	Cal Date(Calibrated by, Certificate No.)	Scheduled Calibration
Signal Generator E4438C	MY49071430	23-Jan-18 (CTTL, No.J18X00560)	Jan-19
NetworkAnalyzer E5239A	MY55491241	29-Jun-17 (CTTL, No.J18X00561)	Jun-18

	Name	Function
Calibrated by:	Zhao Jing	SAR Test Engineer
Reviewed by:	Lin Hao	SAR Test Engineer
Approved by:	Qi Dianyuan	SAR Project Leader

Signature

Issued: March 27, 2018

This calibration certificate shall not be reproduced except in full without written approval of the laboratory.



Add: No.51 Xueyuan Road, Haidian District, Beijing, 100191, China  
Tel: +86-10-62304633-2079 Fax: +86-10-62304633-2504  
E-mail: cttl@chinattl.com http://www.chinattl.cn

**lossary:**

TSL	tissue simulating liquid
ConvF	sensitivity in TSL / NORM <sub>x,y,z</sub>
N/A	not applicable or not measured

**Calibration is Performed According to the Following Standards:**

- a) IEEE Std 1528-2013, "IEEE Recommended Practice for Determining the Peak Spatial-Averaged Specific Absorption Rate (SAR) in the Human Head from Wireless Communications Devices: Measurement Techniques", June 2013
- b) IEC 62209-1, "Measurement procedure for assessment of specific absorption rate of human exposure to radio frequency fields from hand-held and body-mounted wireless communication devices- Part 1: Device used next to the ear (Frequency range of 300MHz to 6GHz)", July 2016
- c) IEC 62209-2, "Procedure to measure the Specific Absorption Rate (SAR) For wireless communication devices used in close proximity to the human body (frequency range of 30MHz to 6GHz)", March 2010
- d) KDB865664, SAR Measurement Requirements for 100 MHz to 6 GHz

**Additional Documentation:**

- e) DASY4/5 System Handbook

**Methods Applied and Interpretation of Parameters:**

- *Measurement Conditions:* Further details are available from the Validation Report at the end of the certificate. All figures stated in the certificate are valid at the frequency indicated.
- *Antenna Parameters with TSL:* The dipole is mounted with the spacer to position its feed point exactly below the center marking of the flat phantom section, with the arms oriented parallel to the body axis.
- *Feed Point Impedance and Return Loss:* These parameters are measured with the dipole positioned under the liquid filled phantom. The impedance stated is transformed from the measurement at the SMA connector to the feed point. The Return Loss ensures low reflected power. No uncertainty required.
- *Electrical Delay:* One-way delay between the SMA connector and the antenna feed point. No uncertainty required.
- *SAR measured:* SAR measured at the stated antenna input power.
- *SAR normalized:* SAR as measured, normalized to an input power of 1 W at the antenna connector.
- *SAR for nominal TSL parameters:* The measured TSL parameters are used to calculate the nominal SAR result.

The reported uncertainty of measurement is stated as the standard uncertainty of Measurement multiplied by the coverage factor  $k=2$ , which for a normal distribution Corresponds to a coverage probability of approximately 95%.



Add: No.51 Xueyuan Road, Haidian District, Beijing, 100191, China  
Tel: +86-10-62304633-2079 Fax: +86-10-62304633-2504  
E-mail: cttl@chinattl.com http://www.chinattl.cn

### Measurement Conditions

DASY system configuration, as far as not given on page 1.

DASY Version	DASY52	52.10.0.1446
Extrapolation	Advanced Extrapolation	
Phantom	Triple Flat Phantom 5.1C	
Distance Dipole Center - TSL	10 mm	with Spacer
Zoom Scan Resolution	dx, dy, dz = 5 mm	
Frequency	1900 MHz ± 1 MHz	

### Head TSL parameters

The following parameters and calculations were applied.

	Temperature	Permittivity	Conductivity
Nominal Head TSL parameters	22.0 °C	40.0	1.40 mho/m
Measured Head TSL parameters	(22.0 ± 0.2) °C	38.9 ± 6 %	1.39 mho/m ± 6 %
Head TSL temperature change during test	<1.0 °C	----	----

### SAR result with Head TSL

SAR averaged over 1 cm <sup>3</sup> (1 g) of Head TSL	Condition	
SAR measured	250 mW input power	9.97 mW / g
SAR for nominal Head TSL parameters	normalized to 1W	<b>39.9 mW / g ± 18.8 % (k=2)</b>
SAR averaged over 10 cm <sup>3</sup> (10 g) of Head TSL	Condition	
SAR measured	250 mW input power	5.14 mW / g
SAR for nominal Head TSL parameters	normalized to 1W	<b>20.6 mW / g ± 18.7 % (k=2)</b>

### Body TSL parameters

The following parameters and calculations were applied.

	Temperature	Permittivity	Conductivity
Nominal Body TSL parameters	22.0 °C	53.3	1.52 mho/m
Measured Body TSL parameters	(22.0 ± 0.2) °C	54.7 ± 6 %	1.49 mho/m ± 6 %
Body TSL temperature change during test	<1.0 °C	----	----

### SAR result with Body TSL

SAR averaged over 1 cm <sup>3</sup> (1 g) of Body TSL	Condition	
SAR measured	250 mW input power	9.98 mW / g
SAR for nominal Body TSL parameters	normalized to 1W	<b>40.7 mW / g ± 18.8 % (k=2)</b>
SAR averaged over 10 cm <sup>3</sup> (10 g) of Body TSL	Condition	
SAR measured	250 mW input power	5.17 mW / g
SAR for nominal Body TSL parameters	normalized to 1W	<b>20.9 mW / g ± 18.7 % (k=2)</b>



Add: No.51 Xueyuan Road, Haidian District, Beijing, 100191, China  
Tel: +86-10-62304633-2079 Fax: +86-10-62304633-2504  
E-mail: cttl@chinattl.com http://www.chinattl.cn

## Appendix (Additional assessments outside the scope of CNAS L0570)

### Antenna Parameters with Head TSL

Impedance, transformed to feed point	52.6Ω+ 4.18jΩ
Return Loss	- 26.4dB

### Antenna Parameters with Body TSL

Impedance, transformed to feed point	48.1Ω+ 4.53jΩ
Return Loss	- 26.0dB

### General Antenna Parameters and Design

Electrical Delay (one direction)	1.107 ns
----------------------------------	----------

After long term use with 100W radiated power, only a slight warming of the dipole near the feedpoint can be measured.

The dipole is made of standard semirigid coaxial cable. The center conductor of the feeding line is directly connected to the second arm of the dipole. The antenna is therefore short-circuited for DC-signals. On some of the dipoles, small end caps are added to the dipole arms in order to improve matching when loaded according to the position as explained in the "Measurement Conditions" paragraph. The SAR data are not affected by this change. The overall dipole length is still according to the Standard.

No excessive force must be applied to the dipole arms, because they might bend or the soldered connections near the feedpoint may be damaged.

### Additional EUT Data

Manufactured by	SPEAG
-----------------	-------



Add: No.51 Xueyuan Road, Haidian District, Beijing, 100191, China  
Tel: +86-10-62304633-2079 Fax: +86-10-62304633-2504  
E-mail: cttl@chinattl.com http://www.chinattl.cn

**DASY5 Validation Report for Head TSL**

Date: 03.23.2018

Test Laboratory: CTTL, Beijing, China

**DUT: Dipole 1900 MHz; Type: D1900V2; Serial: D1900V2 - SN: 5d170**

Communication System: UID 0, CW; Frequency: 1900 MHz; Duty Cycle: 1:1

Medium parameters used:  $f = 1900$  MHz;  $\sigma = 1.386$  S/m;  $\epsilon_r = 38.9$ ;  $\rho = 1000$  kg/m<sup>3</sup>

Phantom section: Center Section

Measurement Standard: DASY5 (IEEE/IEC/ANSI C63.19-2007)

DASY5 Configuration:

- Probe: EX3DV4 - SN7464; ConvF(8.39, 8.39, 8.39); Calibrated: 9/12/2017;
- Sensor-Surface: 1.4mm (Mechanical Surface Detection)
- Electronics: DAE4 Sn1525; Calibrated: 10/2/2017
- Phantom: Triple Flat Phantom 5.1C; Type: QD 000 P51 CA; Serial: 1161/1
- Measurement SW: DASY52, Version 52.10 (0); SEMCAD X Version 14.6.10 (7417)

**System Performance Check/Zoom Scan (7x7x7) (7x7x7)/Cube 0: Measurement grid:**

$dx=5$ mm,  $dy=5$ mm,  $dz=5$ mm

Reference Value = 101.9 V/m; Power Drift = 0.00 dB

Peak SAR (extrapolated) = 19.1 W/kg

**SAR(1 g) = 9.97 W/kg; SAR(10 g) = 5.14 W/kg**

Maximum value of SAR (measured) = 15.8 W/kg

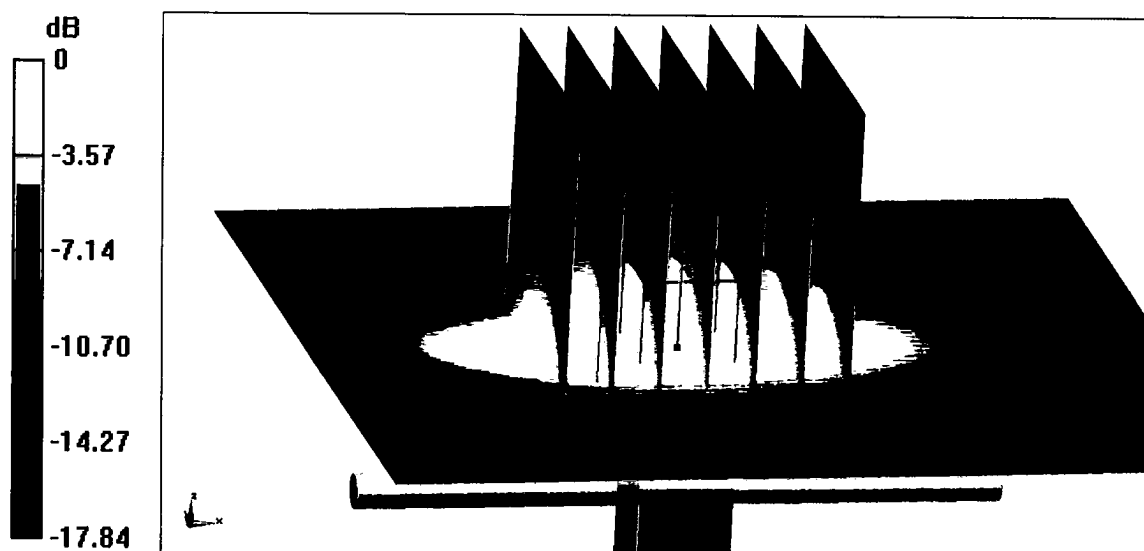

**0 dB = 15.8 W/kg = 11.99 dBW/kg**



Add: No.51 Xueyuan Road, Haidian District, Beijing, 100191, China  
Tel: +86-10-62304633-2079 Fax: +86-10-62304633-2504  
E-mail: cttl@chinattl.com http://www.chinattl.cn

### Impedance Measurement Plot for Head TSL

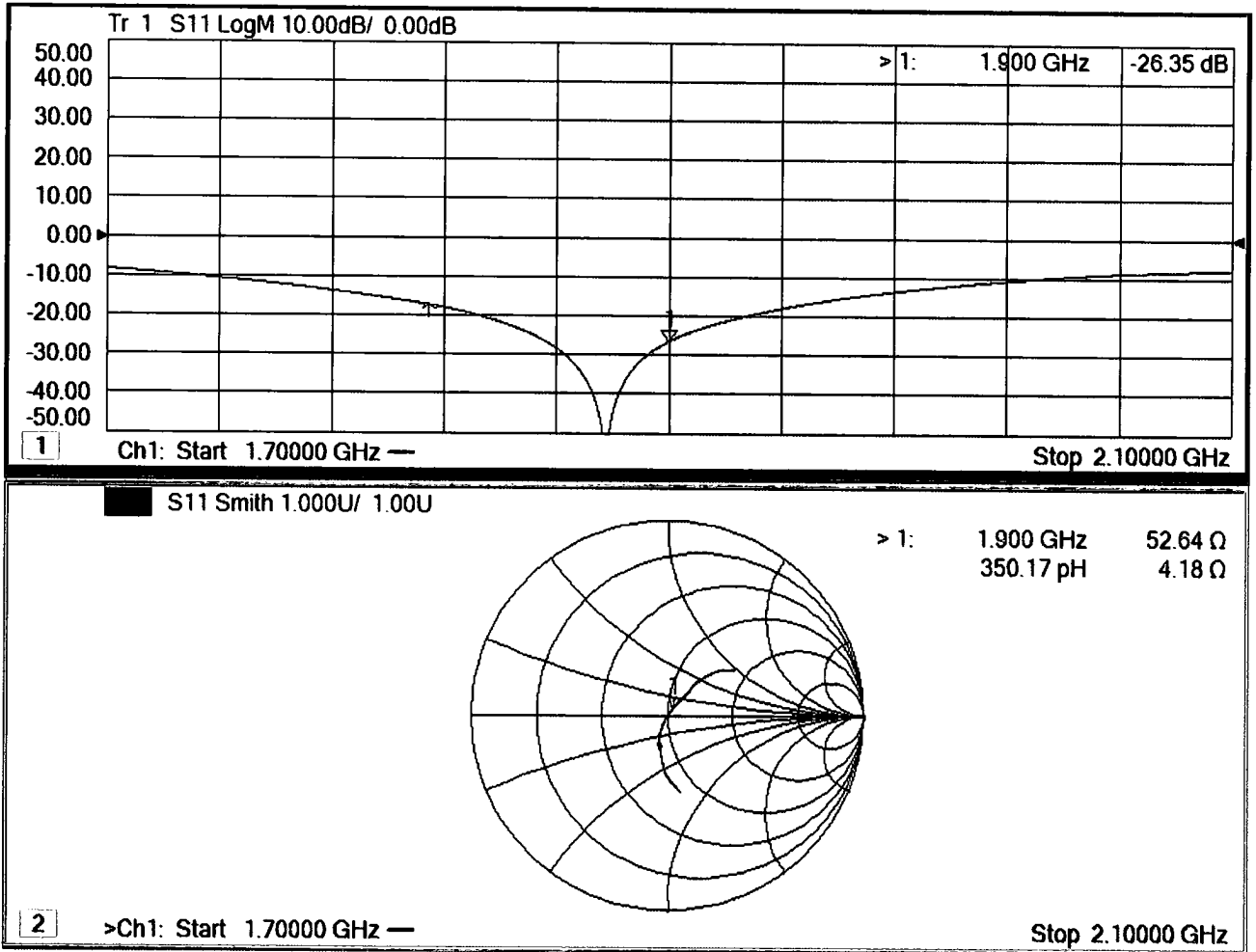



Add: No.51 Xueyuan Road, Haidian District, Beijing, 100191, China  
Tel: +86-10-62304633-2079 Fax: +86-10-62304633-2504  
E-mail: cttl@chinattl.com http://www.chinattl.cn

**DASY5 Validation Report for Body TSL**

Date: 03.25.2018

Test Laboratory: CTTL, Beijing, China

**DUT: Dipole 1900 MHz; Type: D1900V2; Serial: D1900V2 - SN: 5d170**

Communication System: UID 0, CW; Frequency: 1900 MHz; Duty Cycle: 1:1

Medium parameters used:  $f = 1900$  MHz;  $\sigma = 1.488$  S/m;  $\epsilon_r = 54.73$ ;  $\rho = 1000$  kg/m<sup>3</sup>

Phantom section: Right Section

Measurement Standard: DASY5 (IEEE/IEC/ANSI C63.19-2007)

DASY5 Configuration:

- Probe: EX3DV4 - SN7464; ConvF(8.32, 8.32, 8.32); Calibrated: 9/12/2017;
- Sensor-Surface: 1.4mm (Mechanical Surface Detection)
- Electronics: DAE4 Sn1525; Calibrated: 10/2/2017
- Phantom: Triple Flat Phantom 5.1C; Type: QD 000 P51 CA; Serial: 1161/1
- Measurement SW: DASY52, Version 52.10 (0); SEMCAD X Version 14.6.10 (7417)

**System Performance Check/Zoom Scan (7x7x7) (7x7x7)/Cube 0: Measurement grid:**

dx=5mm, dy=5mm, dz=5mm

Reference Value = 98.38 V/m; Power Drift = -0.02 dB

Peak SAR (extrapolated) = 18.4 W/kg

**SAR(1 g) = 9.98 W/kg; SAR(10 g) = 5.17 W/kg**

Maximum value of SAR (measured) = 15.5 W/kg

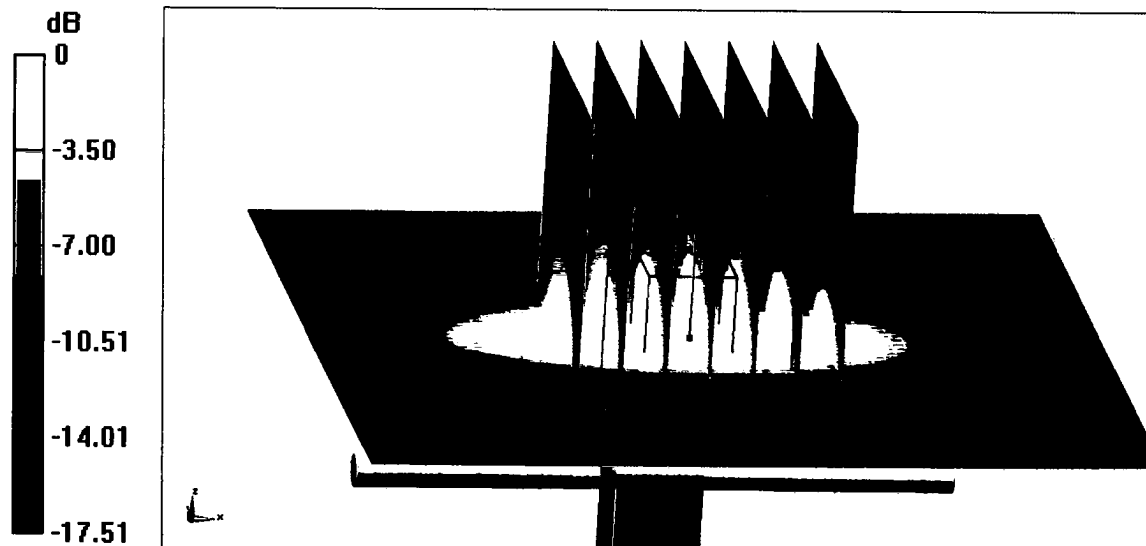

**0 dB = 15.5 W/kg = 11.90 dBW/kg**



Add: No.51 Xueyuan Road, Haidian District, Beijing, 100191, China  
Tel: +86-10-62304633-2079 Fax: +86-10-62304633-2504  
E-mail: cttl@chinattl.com http://www.chinattl.cn

### Impedance Measurement Plot for Body TSL

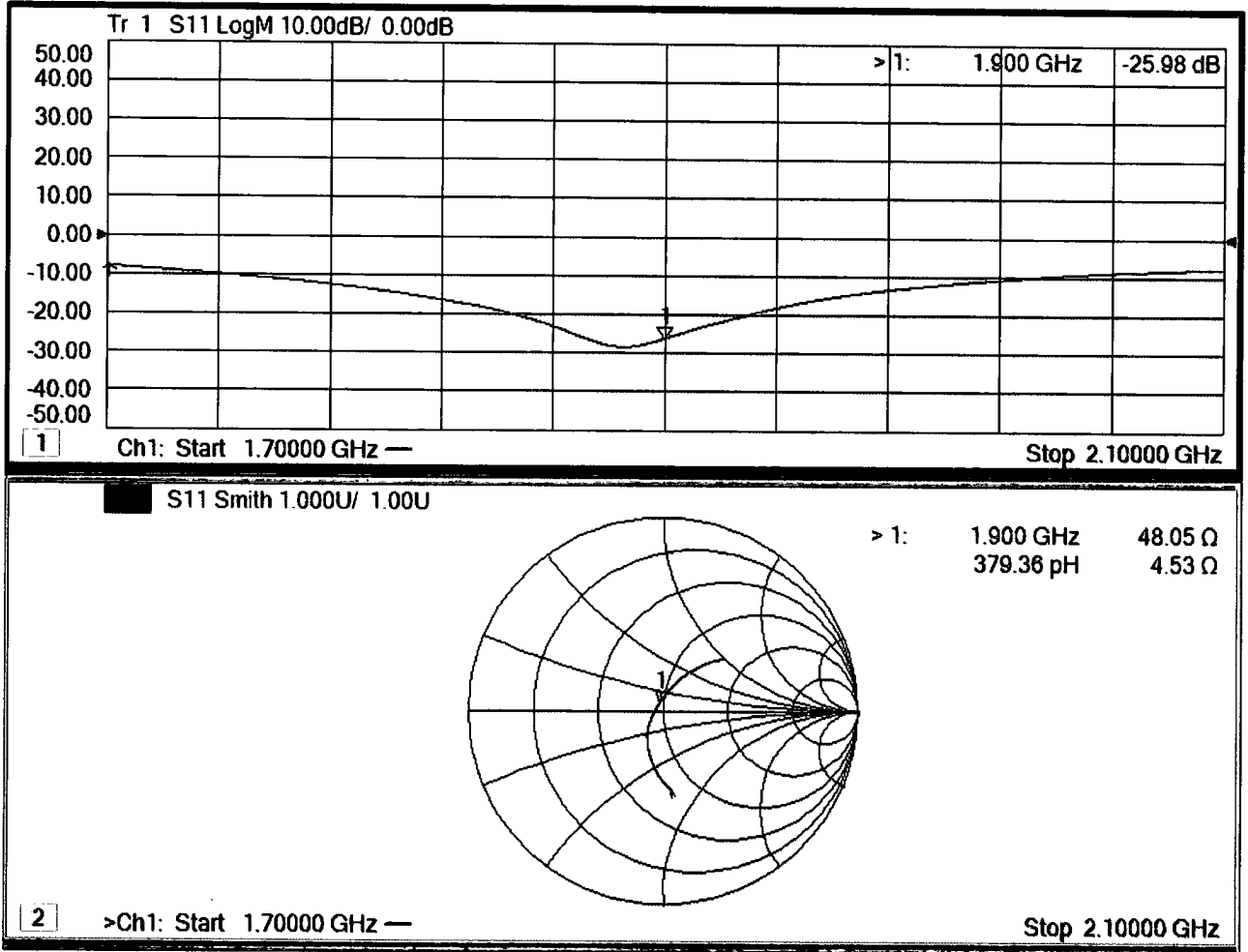





Add: No.51 Xueyuan Road, Haidian District, Beijing, 100191, China  
Tel: +86-10-62304633-2079 Fax: +86-10-62304633-2504  
E-mail: cttl@chinattl.com http://www.chinattl.cn

Client **Sporton**

Certificate No: **Z18-60045**

## CALIBRATION CERTIFICATE

Object **D2450V2 - SN: 908**

Calibration Procedure(s) **FF-Z11-003-01**  
**Calibration Procedures for dipole validation kits**

Calibration date: **March 22, 2018**

This calibration Certificate documents the traceability to national standards, which realize the physical units of measurements(SI). The measurements and the uncertainties with confidence probability are given on the following pages and are part of the certificate.

All calibrations have been conducted in the closed laboratory facility: environment temperature(22±3)°C and humidity<70%.

Calibration Equipment used (M&TE critical for calibration)

Primary Standards	ID #	Cal Date(Calibrated by, Certificate No.)	Scheduled Calibration
Power Meter NRVD	102083	01-Nov-17 (CTTL, No.J17X08756)	Oct-18
Power sensor NRV-Z5	100542	01-Nov-17 (CTTL, No.J17X08756)	Oct-18
Reference Probe EX3DV4	SN 7464	12-Sep-17(SPEAG,No.EX3-7464_Sep17)	Sep-18
DAE4	SN 1525	02-Oct-17(SPEAG,No.DAE4-1525_Oct17)	Oct-18
Secondary Standards	ID #	Cal Date(Calibrated by, Certificate No.)	Scheduled Calibration
Signal Generator E4438C	MY49071430	23-Jan-18 (CTTL, No.J18X00560)	Jan-19
NetworkAnalyzer E5239A	MY55491241	29-Jun-17 (CTTL, No.J18X00561)	Jun-18

	Name	Function	Signature
Calibrated by:	Zhao Jing	SAR Test Engineer	
Reviewed by:	Lin Hao	SAR Test Engineer	
Approved by:	Qi Dianyuan	SAR Project Leader	

Issued: March 25, 2018

This calibration certificate shall not be reproduced except in full without written approval of the laboratory.



In Collaboration with

**s p e a g**  
**CALIBRATION LABORATORY**

Add: No.51 Xueyuan Road, Haidian District, Beijing, 100191, China  
Tel: +86-10-62304633-2079 Fax: +86-10-62304633-2504  
E-mail: cttl@chinattl.com http://www.chinattl.cn

### Glossary:

TSL	tissue simulating liquid
ConvF	sensitivity in TSL / NORM <sub>x,y,z</sub>
N/A	not applicable or not measured

### Calibration is Performed According to the Following Standards:

- IEEE Std 1528-2013, "IEEE Recommended Practice for Determining the Peak Spatial-Averaged Specific Absorption Rate (SAR) in the Human Head from Wireless Communications Devices: Measurement Techniques", June 2013
- IEC 62209-1, "Measurement procedure for assessment of specific absorption rate of human exposure to radio frequency fields from hand-held and body-mounted wireless communication devices- Part 1: Device used next to the ear (Frequency range of 300MHz to 6GHz)", July 2016
- IEC 62209-2, "Procedure to measure the Specific Absorption Rate (SAR) For wireless communication devices used in close proximity to the human body (frequency range of 30MHz to 6GHz)", March 2010
- KDB865664, SAR Measurement Requirements for 100 MHz to 6 GHz

### Additional Documentation:

- DASY4/5 System Handbook

### Methods Applied and Interpretation of Parameters:

- Measurement Conditions:** Further details are available from the Validation Report at the end of the certificate. All figures stated in the certificate are valid at the frequency indicated.
- Antenna Parameters with TSL:** The dipole is mounted with the spacer to position its feed point exactly below the center marking of the flat phantom section, with the arms oriented parallel to the body axis.
- Feed Point Impedance and Return Loss:** These parameters are measured with the dipole positioned under the liquid filled phantom. The impedance stated is transformed from the measurement at the SMA connector to the feed point. The Return Loss ensures low reflected power. No uncertainty required.
- Electrical Delay:** One-way delay between the SMA connector and the antenna feed point. No uncertainty required.
- SAR measured:** SAR measured at the stated antenna input power.
- SAR normalized:** SAR as measured, normalized to an input power of 1 W at the antenna connector.
- SAR for nominal TSL parameters:** The measured TSL parameters are used to calculate the nominal SAR result.

The reported uncertainty of measurement is stated as the standard uncertainty of Measurement multiplied by the coverage factor  $k=2$ , which for a normal distribution Corresponds to a coverage probability of approximately 95%.



Add: No.51 Xueyuan Road, Haidian District, Beijing, 100191, China  
 Tel: +86-10-62304633-2079 Fax: +86-10-62304633-2504  
 E-mail: cttl@chinattl.com http://www.chinattl.cn

### Measurement Conditions

DASY system configuration, as far as not given on page 1.

DASY Version	DASY52	52.10.0.1446
Extrapolation	Advanced Extrapolation	
Phantom	Triple Flat Phantom 5.1C	
Distance Dipole Center - TSL	10 mm	with Spacer
Zoom Scan Resolution	dx, dy, dz = 5 mm	
Frequency	2450 MHz ± 1 MHz	

### Head TSL parameters

The following parameters and calculations were applied.

	Temperature	Permittivity	Conductivity
Nominal Head TSL parameters	22.0 °C	39.2	1.80 mho/m
Measured Head TSL parameters	(22.0 ± 0.2) °C	40.3 ± 6 %	1.84 mho/m ± 6 %
Head TSL temperature change during test	<1.0 °C	----	----

### SAR result with Head TSL

SAR averaged over 1 cm <sup>3</sup> (1 g) of Head TSL	Condition	
SAR measured	250 mW input power	13.0 mW / g
SAR for nominal Head TSL parameters	normalized to 1W	51.8 mW / g ± 18.8 % (k=2)
SAR averaged over 10 cm <sup>3</sup> (10 g) of Head TSL	Condition	
SAR measured	250 mW input power	6.04 mW / g
SAR for nominal Head TSL parameters	normalized to 1W	24.1 mW / g ± 18.7 % (k=2)

### Body TSL parameters

The following parameters and calculations were applied.

	Temperature	Permittivity	Conductivity
Nominal Body TSL parameters	22.0 °C	52.7	1.95 mho/m
Measured Body TSL parameters	(22.0 ± 0.2) °C	51.3 ± 6 %	2.00 mho/m ± 6 %
Body TSL temperature change during test	<1.0 °C	----	----

### SAR result with Body TSL

SAR averaged over 1 cm <sup>3</sup> (1 g) of Body TSL	Condition	
SAR measured	250 mW input power	12.9 mW / g
SAR for nominal Body TSL parameters	normalized to 1W	50.7 mW / g ± 18.8 % (k=2)
SAR averaged over 10 cm <sup>3</sup> (10 g) of Body TSL	Condition	
SAR measured	250 mW input power	5.92 mW / g
SAR for nominal Body TSL parameters	normalized to 1W	23.4 mW / g ± 18.7 % (k=2)



Add: No.51 Xueyuan Road, Haidian District, Beijing, 100191, China  
Tel: +86-10-62304633-2079 Fax: +86-10-62304633-2504  
E-mail: cttl@chinattl.com http://www.chinattl.cn

## Appendix (Additional assessments outside the scope of CNAS L0570)

### Antenna Parameters with Head TSL

Impedance, transformed to feed point	55.6Ω+ 3.68jΩ
Return Loss	- 24.0dB

### Antenna Parameters with Body TSL

Impedance, transformed to feed point	53.8Ω+ 3.05jΩ
Return Loss	- 26.6dB

### General Antenna Parameters and Design

Electrical Delay (one direction)	1.062 ns
----------------------------------	----------

After long term use with 100W radiated power, only a slight warming of the dipole near the feedpoint can be measured.

The dipole is made of standard semirigid coaxial cable. The center conductor of the feeding line is directly connected to the second arm of the dipole. The antenna is therefore short-circuited for DC-signals. On some of the dipoles, small end caps are added to the dipole arms in order to improve matching when loaded according to the position as explained in the "Measurement Conditions" paragraph. The SAR data are not affected by this change. The overall dipole length is still according to the Standard.

No excessive force must be applied to the dipole arms, because they might bend or the soldered connections near the feedpoint may be damaged.

### Additional EUT Data

Manufactured by	SPEAG
-----------------	-------



Add: No.51 Xueyuan Road, Haidian District, Beijing, 100191, China  
 Tel: +86-10-62304633-2079 Fax: +86-10-62304633-2504  
 E-mail: cttl@chinattl.com http://www.chinattl.cn

**DASY5 Validation Report for Head TSL**

Date: 03.22.2018

Test Laboratory: CTTL, Beijing, China

**DUT: Dipole 2450 MHz; Type: D2450V2; Serial: D2450V2 - SN: 908**

Communication System: UID 0, CW; Frequency: 2450 MHz; Duty Cycle: 1:1

Medium parameters used:  $f = 2450$  MHz;  $\sigma = 1.841$  S/m;  $\epsilon_r = 40.32$ ;  $\rho = 1000$  kg/m<sup>3</sup>

Phantom section: Center Section

Measurement Standard: DASY5 (IEEE/IEC/ANSI C63.19-2007)

DASY5 Configuration:

- Probe: EX3DV4 - SN7464; ConvF(7.89, 7.89, 7.89); Calibrated: 9/12/2017;
- Sensor-Surface: 1.4mm (Mechanical Surface Detection)
- Electronics: DAE4 Sn1525; Calibrated: 10/2/2017
- Phantom: Triple Flat Phantom 5.1C; Type: QD 000 P51 CA; Serial: 1161/1
- Measurement SW: DASY52, Version 52.10 (0); SEMCAD X Version 14.6.10 (7417)

**Dipole Calibration/Zoom Scan (7x7x7) (7x7x7)/Cube 0: Measurement grid: dx=5mm, dy=5mm, dz=5mm**

Reference Value = 100.0 V/m; Power Drift = 0.02 dB

Peak SAR (extrapolated) = 26.9W/kg

**SAR(1 g) = 13 W/kg; SAR(10 g) = 6.04 W/kg**

Maximum value of SAR (measured) = 21.8 W/kg

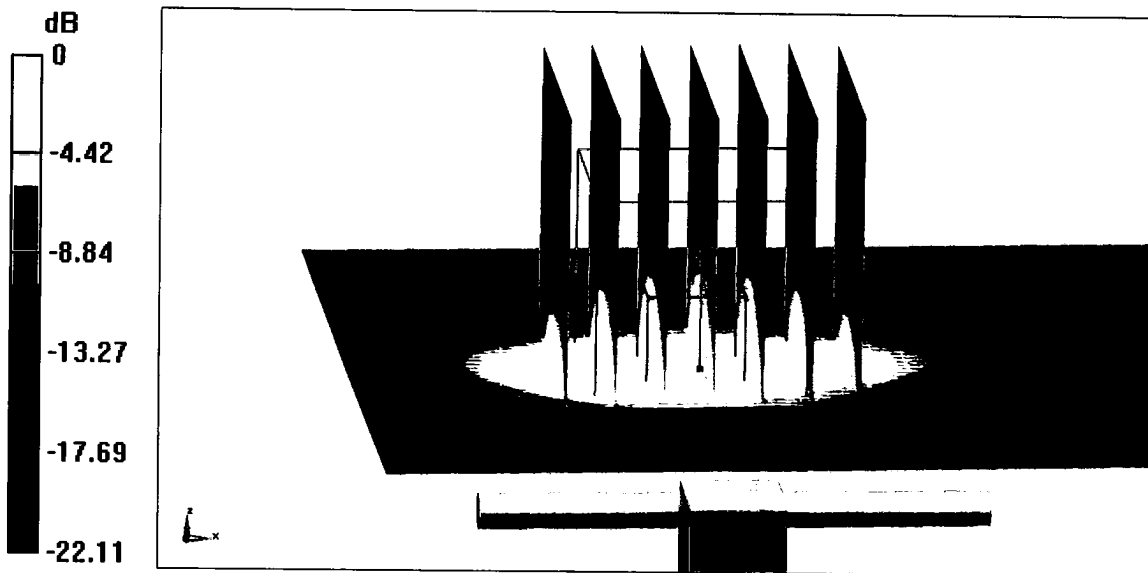

**0 dB = 21.8 W/kg = 13.38 dBW/kg**



Add: No.51 Xueyuan Road, Haidian District, Beijing, 100191, China  
Tel: +86-10-62304633-2079 Fax: +86-10-62304633-2504  
E-mail: cttl@chinattl.com http://www.chinattl.cn

### Impedance Measurement Plot for Head TSL

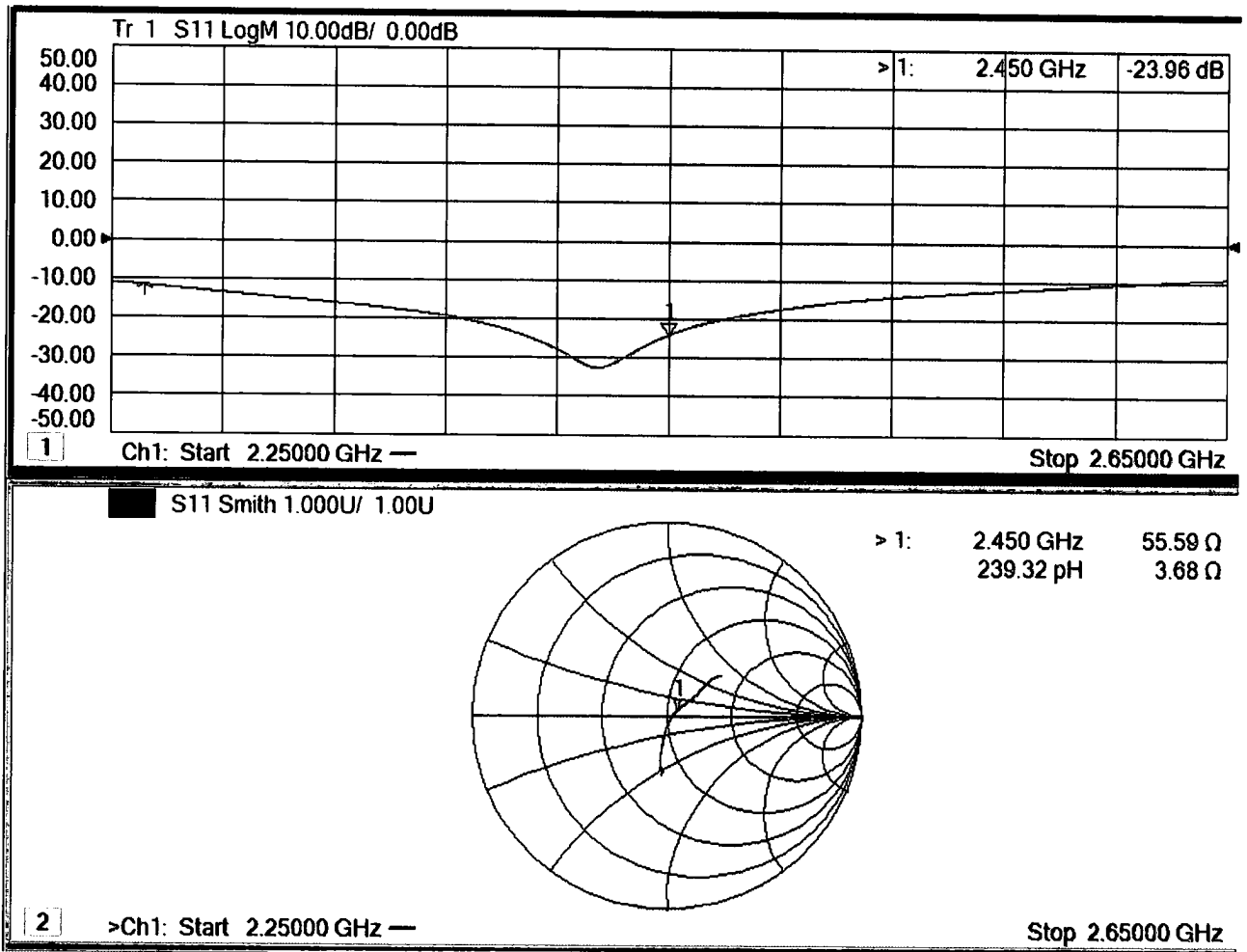



In Collaboration with

**s p e a g**  
**CALIBRATION LABORATORY**

Add: No.51 Xueyuan Road, Haidian District, Beijing, 100191, China  
Tel: +86-10-62304633-2079 Fax: +86-10-62304633-2504  
E-mail: cttl@chinattl.com http://www.chinattl.cn

### DASY5 Validation Report for Body TSL

Date: 03.22.2018

Test Laboratory: CTTL, Beijing, China

**DUT: Dipole 2450 MHz; Type: D2450V2; Serial: D2450V2 - SN: 908**

Communication System: UID 0, CW; Frequency: 2450 MHz; Duty Cycle: 1:1

Medium parameters used:  $f = 2450$  MHz;  $\sigma = 1.998$  S/m;  $\epsilon_r = 51.28$ ;  $\rho = 1000$  kg/m<sup>3</sup>

Phantom section: Left Section

Measurement Standard: DASY5 (IEEE/IEC/ANSI C63.19-2007)

DASY5 Configuration:

- Probe: EX3DV4 - SN7464; ConvF(8.09, 8.09, 8.09); Calibrated: 9/12/2017;
- Sensor-Surface: 1.4mm (Mechanical Surface Detection)
- Electronics: DAE4 Sn1525; Calibrated: 10/2/2017
- Phantom: Triple Flat Phantom 5.1C; Type: QD 000 P51 CA; Serial: 1161/1
- Measurement SW: DASY52, Version 52.10 (0); SEMCAD X Version 14.6.10 (7417)

**Dipole Calibration/Zoom Scan (7x7x7) (7x7x7)/Cube 0:** Measurement grid: dx=5mm, dy=5mm, dz=5mm

Reference Value = 98.11 V/m; Power Drift = -0.04 dB

Peak SAR (extrapolated) = 27.2 W/kg

**SAR(1 g) = 12.9 W/kg; SAR(10 g) = 5.92 W/kg**

Maximum value of SAR (measured) = 21.6 W/kg

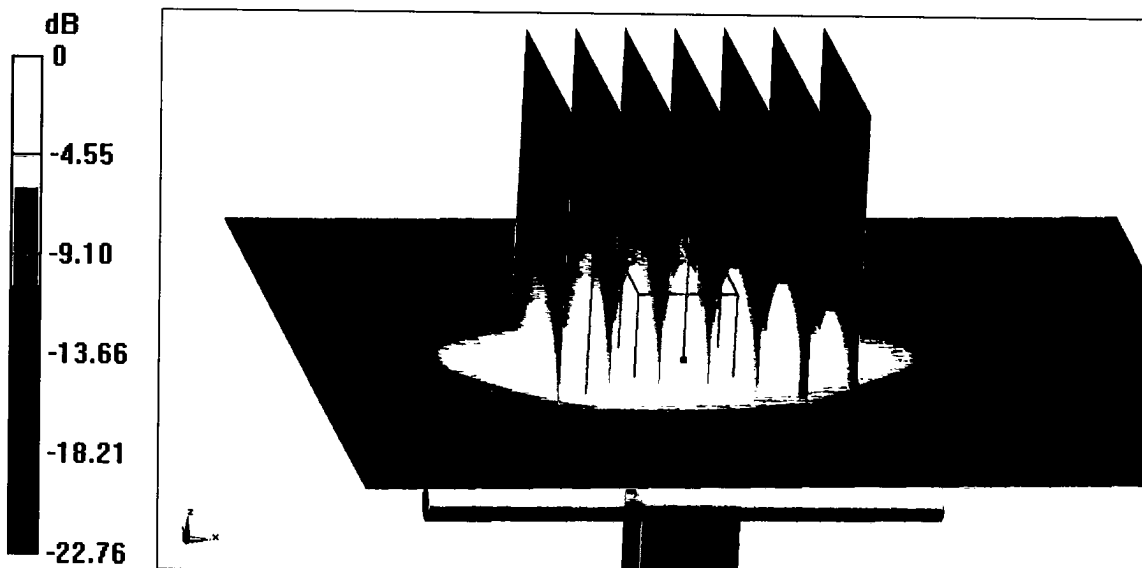

**0 dB = 21.6 W/kg = 13.34 dBW/kg**







Add: No.51 Xueyuan Road, Haidian District, Beijing, 100191, China  
Tel: +86-10-62304633-2079 Fax: +86-10-62304633-2504  
E-mail: cttl@chinattl.com http://www.chinattl.cn

Client **Sporton**

Certificate No: **Z18-60490**

## CALIBRATION CERTIFICATE

Object: D2600V2 - SN: 1061

Calibration Procedure(s): FF-Z11-003-01  
Calibration Procedures for dipole validation kits

Calibration date: December 7, 2018

This calibration Certificate documents the traceability to national standards, which realize the physical units of measurements(SI). The measurements and the uncertainties with confidence probability are given on the following pages and are part of the certificate.

All calibrations have been conducted in the closed laboratory facility: environment temperature(22±3)°C and humidity<70%.

Calibration Equipment used (M&TE critical for calibration)

Primary Standards	ID #	Cal Date(Calibrated by, Certificate No.)	Scheduled Calibration
Power Meter NRVD	102196	07-Mar-18 (CTTL, No.J18X01510)	Mar-19
Power sensor NRV-Z5	100596	07-Mar-18 (CTTL, No.J18X01510)	Mar-19
Reference Probe EX3DV4	SN 7514	27-Aug-18(SPEAG,No.EX3-7514_Aug18)	Aug-19
DAE4	SN 1555	20-Aug-18(SPEAG,No.DAE4-1555_Aug18)	Aug-19
Secondary Standards	ID #	Cal Date(Calibrated by, Certificate No.)	Scheduled Calibration
Signal Generator E4438C	MY49071430	23-Jan-18 (CTTL, No.J18X00560)	Jan-19
Network Analyzer E5071C	MY46110673	24-Jan-18 (CTTL, No.J18X00561)	Jan-19

	Name	Function	Signature
Calibrated by:	Zhao Jing	SAR Test Engineer	
Reviewed by:	Lin Hao	SAR Test Engineer	
Approved by:	Qi Dianyuan	SAR Project Leader	

Issued: December 10, 2018

This calibration certificate shall not be reproduced except in full without written approval of the laboratory.



Add: No.51 Xueyuan Road, Haidian District, Beijing, 100191, China  
Tel: +86-10-62304633-2079 Fax: +86-10-62304633-2504  
E-mail: cttl@chinattl.com http://www.chinattl.cn

**Glossary:**

TSL	tissue simulating liquid
ConvF	sensitivity in TSL / NORM <sub>x,y,z</sub>
N/A	not applicable or not measured

**Calibration is Performed According to the Following Standards:**

- a) IEEE Std 1528-2013, "IEEE Recommended Practice for Determining the Peak Spatial-Averaged Specific Absorption Rate (SAR) in the Human Head from Wireless Communications Devices: Measurement Techniques", June 2013
- b) IEC 62209-1, "Measurement procedure for assessment of specific absorption rate of human exposure to radio frequency fields from hand-held and body-mounted wireless communication devices- Part 1: Device used next to the ear (Frequency range of 300MHz to 6GHz)", July 2016
- c) IEC 62209-2, "Procedure to measure the Specific Absorption Rate (SAR) For wireless communication devices used in close proximity to the human body (frequency range of 30MHz to 6GHz)", March 2010
- d) KDB865664, SAR Measurement Requirements for 100 MHz to 6 GHz

**Additional Documentation:**

- e) DASY4/5 System Handbook

**Methods Applied and Interpretation of Parameters:**

- *Measurement Conditions:* Further details are available from the Validation Report at the end of the certificate. All figures stated in the certificate are valid at the frequency indicated.
- *Antenna Parameters with TSL:* The dipole is mounted with the spacer to position its feed point exactly below the center marking of the flat phantom section, with the arms oriented parallel to the body axis.
- *Feed Point Impedance and Return Loss:* These parameters are measured with the dipole positioned under the liquid filled phantom. The impedance stated is transformed from the measurement at the SMA connector to the feed point. The Return Loss ensures low reflected power. No uncertainty required.
- *Electrical Delay:* One-way delay between the SMA connector and the antenna feed point. No uncertainty required.
- *SAR measured:* SAR measured at the stated antenna input power.
- *SAR normalized:* SAR as measured, normalized to an input power of 1 W at the antenna connector.
- *SAR for nominal TSL parameters:* The measured TSL parameters are used to calculate the nominal SAR result.

The reported uncertainty of measurement is stated as the standard uncertainty of Measurement multiplied by the coverage factor  $k=2$ , which for a normal distribution Corresponds to a coverage probability of approximately 95%.