



# FCC RF Test Report

**APPLICANT** : Motorola Mobility LLC  
**EQUIPMENT** : Mobile Cellular Phone  
**BRAND NAME** : Motorola  
**MODEL NAME** : XT1970-1,XT1970-2  
**FCC ID** : IHDT56XT1  
**STANDARD** : FCC Part 15 Subpart E §15.407  
**CLASSIFICATION** : (NII) Unlicensed National Information Infrastructure

The product was received on Dec. 20, 2018 and testing was completed on Jan. 30, 2019. We, Sporton International (Kunshan) Inc., would like to declare that the tested sample has been evaluated in accordance with the test procedures and has been in compliance with the applicable technical standards.

The test results in this report apply exclusively to the tested model / sample. Without written approval of Sporton International (Kunshan) Inc., the test report shall not be reproduced except in full.



Approved by: James Huang / Manager

**Sporton International (Kunshan) Inc.**  
**No. 1098, Pengxi North Road, Kunshan Economic Development Zone,**  
**Jiangsu Province 215335, China**



# TABLE OF CONTENTS

**REVISION HISTORY .....3**

**SUMMARY OF TEST RESULT .....4**

**1 GENERAL DESCRIPTION.....5**

    1.1 Applicant .....5

    1.2 Manufacturer .....5

    1.3 Product Feature of Equipment Under Test .....5

    1.4 Product Specification of Equipment Under Test.....6

    1.5 Modification of EUT .....6

    1.6 Specification of Accessory .....7

    1.7 Testing Location .....9

    1.8 Applicable Standards .....9

**2 TEST CONFIGURATION OF EQUIPMENT UNDER TEST ..... 10**

    2.1 Carrier Frequency and Channel ..... 10

    2.2 Test Mode ..... 12

    2.3 Connection Diagram of Test System ..... 14

    2.4 Support Unit used in test configuration and system ..... 14

    2.5 EUT Operation Test Setup ..... 15

    2.6 Measurement Results Explanation Example ..... 15

**3 TEST RESULT ..... 16**

    3.1 26dB & 99% Occupied Bandwidth Measurement..... 16

    3.2 Maximum Conducted Output Power Measurement ..... 18

    3.3 Power Spectral Density Measurement ..... 20

    3.4 Unwanted Emissions Measurement ..... 23

    3.5 AC Conducted Emission Measurement ..... 28

    3.6 Automatically Discontinue Transmission ..... 30

    3.7 Antenna Requirements ..... 31

**4 LIST OF MEASURING EQUIPMENT ..... 32**

**5 UNCERTAINTY OF EVALUATION..... 33**

**APPENDIX A. CONDUCTED TEST RESULTS**

**APPENDIX B. AC CONDUCTED EMISSION TEST RESULT**

**APPENDIX C. RADIATED SPURIOUS EMISSION**

**APPENDIX D. DUTY CYCLE PLOTS**

**APPENDIX E. SETUP PHOTOGRAPHS**



## REVISION HISTORY

REPORT NO.	VERSION	DESCRIPTION	ISSUED DATE
FR8D2002D	Rev. 01	Initial issue of report	Mar. 01, 2019



### SUMMARY OF TEST RESULT

Report Section	FCC Rule	Description	Limit	Result	Remark
3.1	2.1049 & 15.403(i)	26dB & 99% Bandwidth	-	Pass	-
3.2	15.407(a)	Maximum Conducted Output Power	≤ 24 dBm	Pass	-
3.3	15.407(a)	Power Spectral Density	≤ 11 dBm	Pass	-
3.4	15.407(b)	Unwanted Emissions	15.407(b) & 15.209(a)	Pass	Under limit 3.06 dB at 5149.92 MHz
3.5	15.207	AC Conducted Emission	15.207(a)	Pass	Under limit 7.57 dB at 0.158 MHz
3.6	15.407(c)	Automatically Discontinue Transmission	Discontinue Transmission	Pass	-
3.7	15.203 & 15.407(a)	Antenna Requirement	N/A	Pass	-



# 1 General Description

## 1.1 Applicant

Motorola Mobility LLC  
222 W,Merchandise Mart Plaza, Chicago IL 60654 USA

## 1.2 Manufacturer

Motorola Mobility LLC  
222 W,Merchandise Mart Plaza, Chicago IL 60654 USA

## 1.3 Product Feature of Equipment Under Test

Product Feature	
Equipment	Mobile Cellular Phone
Brand Name	Motorola
Model Name	XT1970-1, XT1970-2
FCC ID	IHDT56XT1
EUT supports Radios application	GSM/GPRS/EGPRS/WCDMA/HSPA/DC-HSDPA/ HSPA+(16QAM uplink is not supported)/LTE WLAN 2.4GHz 802.11b/g/n HT20/HT40 WLAN 5GHz 802.11a/n HT20/HT40 WLAN 5GHz 802.11ac VHT20/VHT40/VHT80 Bluetooth BR/EDR/LE NFC/GNSS/FM Receiver
IMEI Code	Radiation: N/A Conducted: 352170100017578/352170100017586 Conduction: 352170100023196/352170100023204
HW Version	DVT2
SW Version	PSA29.76
EUT Stage	Identical Prototype

**Remark:**

1. The above EUT's information was declared by manufacturer. Please refer to the specifications or user's manual for more detailed description.
2. There are two types of EUT sample 1 and sample 2, the differences between two samples are only for SIM slot, sample 1(model name XT1970-1) is dual SIM slot, sample 2(model name XT1970-2) is single SIM slot. According to the difference, we evaluate is not affect RF performance, so only choose sample 1 to perform RF test.



### 1.4 Product Specification of Equipment Under Test

Standards-related Product Specification	
<b>Tx/Rx Frequency Range</b>	5180 MHz ~ 5240 MHz 5260 MHz ~ 5320 MHz 5500 MHz ~ 5720 MHz
<b>Maximum Output Power to Antenna</b>	<p><b>&lt;5180 MHz ~ 5240 MHz&gt;</b>  802.11a : 18.07 dBm / 0.0641 W  802.11n HT20 : 18.38 dBm / 0.0689 W  802.11n HT40 : 17.03 dBm / 0.0505 W  802.11ac VHT20 : 18.34 dBm / 0.0682 W  802.11ac VHT40 : 17.02 dBm / 0.0504 W  802.11ac VHT80 : 15.34 dBm / 0.0342 W</p> <p><b>&lt;5260 MHz ~ 5320 MHz&gt;</b>  802.11a : 18.58 dBm / 0.0721 W  802.11n HT20 : 18.65 dBm / 0.0733 W  802.11n HT40 : 17.34 dBm / 0.0542 W  802.11ac VHT20 : 18.62 dBm / 0.0728 W  802.11ac VHT40 : 17.32 dBm / 0.0540 W  802.11ac VHT80 : 15.83 dBm / 0.0383 W</p> <p><b>&lt;5500 MHz ~ 5720 MHz &gt;</b>  802.11a : 18.87 dBm / 0.0771 W  802.11n HT20 : 18.99 dBm / 0.0793 W  802.11n HT40 : 17.53 dBm / 0.0566 W  802.11ac VHT20 : 18.91 dBm / 0.0778 W  802.11ac VHT40 : 17.30 dBm / 0.0537 W  802.11ac VHT80 : 16.59 dBm / 0.0456 W</p>
<b>99% Occupied Bandwidth</b>	802.11a : 18.78 MHz 802.11n HT20 : 20.18MHz 802.11n HT40 : 41.56MHz 802.11ac VHT80 : 80.32 MHz
<b>Antenna Type / Gain</b>	<p><b>&lt;5150 MHz ~ 5250 MHz&gt;</b>  Monopole Antenna with gain -1.0 dBi</p> <p><b>&lt;5250 MHz ~ 5350 MHz&gt;</b>  Monopole Antenna with gain -1.2 dBi</p> <p><b>&lt;5470 MHz ~ 5725 MHz&gt;</b>  Monopole Antenna with gain -1.2 dBi</p>
<b>Type of Modulation</b>	802.11a/n : OFDM (BPSK / QPSK / 16QAM / 64QAM) 802.11ac : OFDM (BPSK / QPSK / 16QAM / 64QAM / 256QAM)

**Note:** For 802.11n HT20 / ac VHT20 and 802.11n HT40 / ac VHT40 mode, the whole testing have assessed only 802.11an HT20/HT40 by referring to their maximum conducted power.

### 1.5 Modification of EUT

No modifications are made to the EUT during all test items.



## 1.6 Specification of Accessory

Specification of Accessory			
AC Adapter 1(US)	Brand Name	Motorola (Salom)	Model Name SC-51
	Power Rating	I/P: 100-240 Vac, 600mA O/P: 5Vdc,3000mA; 9Vdc,2000mA; 12Vdc,1500mA	
AC Adapter 1(EU)	Brand Name	Motorola (Salom)	Model Name SC-52
	Power Rating	I/P: 100-240 Vac, 600mA O/P: 5Vdc,3000mA; 9Vdc,2000mA; 12Vdc,1500mA	
AC Adapter 1(UK)	Brand Name	Motorola (Salom)	Model Name SC-53
	Power Rating	I/P: 100-240 Vac, 600mA O/P: 5Vdc,3000mA; 9Vdc,2000mA; 12Vdc,1500mA	
AC Adapter 1(IN)	Brand Name	Motorola (Salom)	Model Name SC-54
	Power Rating	I/P: 100-240 Vac, 600mA O/P: 5Vdc,3000mA; 9Vdc,2000mA; 12Vdc,1500mA	
AC Adapter 1(AU)	Brand Name	Motorola (Salom)	Model Name SC-55
	Power Rating	I/P: 100-240 Vac, 600mA O/P: 5Vdc,3000mA; 9Vdc,2000mA; 12Vdc,1500mA	
AC Adapter 1(AR)	Brand Name	Motorola (Salom)	Model Name SC-56
	Power Rating	I/P: 100-240 Vac, 600mA O/P: 5Vdc,3000mA; 9Vdc,2000mA; 12Vdc,1500mA	
AC Adapter 1(BR)	Brand Name	Motorola (Salom)	Model Name SC-57
	Power Rating	I/P: 100-240 Vac, 600mA O/P: 5Vdc,3000mA; 9Vdc,2000mA; 12Vdc,1500mA	
AC Adapter 1(PRC)	Brand Name	Motorola (Salom)	Model Name SC-58
	Power Rating	I/P: 100-240 Vac, 600mA O/P: 5Vdc,3000mA; 9Vdc,2000mA; 12Vdc,1500mA	
AC Adapter 1(Chile)	Brand Name	Motorola (Salom)	Model Name SC-52
	Power Rating	I/P: 100-240 Vac, 600mA O/P: 5Vdc,3000mA; 9Vdc,2000mA; 12Vdc,1500mA	
AC Adapter 2(US)	Brand Name	Motorola (Chenyang)	Model Name SC-51
	Power Rating	I/P: 100-240 Vac, 600mA O/P: 5Vdc,3000mA; 9Vdc,2000mA; 12Vdc,1500mA	
AC Adapter 2(EU)	Brand Name	Motorola (Chenyang)	Model Name SC-52
	Power Rating	I/P: 100-240 Vac, 600mA O/P: 5Vdc,3000mA; 9Vdc,2000mA; 12Vdc,1500mA	
AC Adapter 2(UK)	Brand Name	Motorola (Chenyang)	Model Name SC-53
	Power Rating	I/P: 100-240 Vac, 600mA O/P: 5Vdc,3000mA; 9Vdc,2000mA; 12Vdc,1500mA	
AC Adapter 2(AU)	Brand Name	Motorola (Chenyang)	Model Name SC-55
	Power Rating	I/P: 100-240 Vac, 600mA O/P: 5Vdc,3000mA; 9Vdc,2000mA; 12Vdc,1500mA	
AC Adapter 2(AR)	Brand Name	Motorola (Chenyang)	Model Name SC-56
	Power Rating	I/P: 100-240 Vac, 600mA O/P: 5Vdc,3000mA; 9Vdc,2000mA; 12Vdc,1500mA	



AC Adapter 2(PRC)	Brand Name	Motorola (Chenyang)	Model Name	SC-58
	Power Rating	I/P: 100-240 Vac, 600mA O/P: 5Vdc,3000mA; 9Vdc,2000mA; 12Vdc,1500mA		
AC Adapter 3(BR)	Brand Name	Motorola (Salom/Flex)	Model Name	SC-57
	Power Rating	I/P: 100-240 Vac, 600mA O/P: 5Vdc,3000mA; 9Vdc,2000mA; 12Vdc,1500mA		
AC Adapter 4(BR)	Brand Name	Motorola (Tenpao/Cliptech)	Model Name	SC-57
	Power Rating	I/P: 100-240 Vac, 600mA O/P: 5Vdc,3000mA; 9Vdc,2000mA; 12Vdc,1500mA		
Battery	Brand Name	Motorola (ATL)	Model Name	KR40
	Power Rating	3.8Vdc,3500mAh	Type	Li-ion, Polymer
Earphone 1	Brand Name	Motorola (Lyand)	Model Name	SH38C37773
	Signal Line	1.1 meter, non-shielded cable, without ferrite core		
Earphone 2	Brand Name	Motorola (jiahe)	Model Name	SH38C44959
	Signal Line	1.1 meter, non-shielded cable, without ferrite core		
USB Cable 1	Brand Name	Motorola (LiQi)	Model Name	L32B-053000100/L32 B-053000100L
	Signal Line	1.0 meter, shielded cable, without ferrite core		
USB Cable 2	Brand Name	Motorola (Saibao)	Model Name	S32B-053000100/S32B -053000100L
	Signal Line	1.0 meter, shielded cable, without ferrite core		
USB Cable 3	Brand Name	Motorola (I SHENG)	Model Name	SC18C28955
	Signal Line	1.0 meter, shielded cable, without ferrite core		





### 1.7 Testing Location

Sporton International (Kunshan) Inc. is accredited to ISO 17025 by National Voluntary Laboratory Accreditation Program (NVLAP code: 600155-0).

<b>Test Site</b>	Sporton International (Kunshan) Inc.		
<b>Test Site Location</b>	No. 1098, Pengxi North Road, Kunshan Economic Development Zone, Jiangsu Province 215335, China TEL : 86-512-57900158 FAX : 86-512-57900958		
<b>Test Site No.</b>	<b>Sporton Site No.</b>	<b>FCC designation No.</b>	<b>FCC Test Firm Registration No.</b>
	TH01-KS CO01-KS 03CH05-KS	CN5013	630927

**Note:** The test site complies with ANSI C63.4 2014 requirement.

### 1.8 Applicable Standards

According to the specifications of the manufacturer, the EUT must comply with the requirements of the following standards:

- ♦ 47 CFR Part 15 Subpart E
- ♦ FCC KDB 789033 D02 General UNII Test Procedures New Rules v02r01.
- ♦ ANSI C63.10-2013

**Remark:**

1. All test items were verified and recorded according to the standards and without any deviation during the test.
2. This EUT has also been tested and complied with the requirements of FCC Part 15, Subpart B, recorded in a separate test report.



## 2 Test Configuration of Equipment Under Test

- a. The EUT has been associated with peripherals and configuration operated in a manner tended to maximize its emission characteristics in a typical application. Frequency range investigated: conduction emission (150 kHz to 30 MHz), radiation emission (9 kHz to the 10th harmonic of the highest fundamental frequency or to 40 GHz, whichever is lower). For radiated measurement, pre-scanned in three orthogonal panels, X, Y, Z. The worst cases (X plane) were recorded in this report.
- b. AC power line Conducted Emission was tested under maximum output power.

### 2.1 Carrier Frequency and Channel

Frequency Band	Channel	Freq. (MHz)	Channel	Freq. (MHz)
5150-5250 MHz Band 1 (U-NII-1)	36	5180	44	5220
	38*	5190	46*	5230
	40	5200	48	5240
	42 <sup>#</sup>	5210		
5250-5350 MHz Band 2 (U-NII-2A)	52	5260	60	5300
	54*	5270	62*	5310
	56	5280	64	5320
	58 <sup>#</sup>	5290		
5470-5725 MHz Band 3 (U-NII-2C)	100	5500	112	5560
	102*	5510	116	5580
	104	5520	132	5660
	106 <sup>#</sup>	5530	134*	5670
	108	5540	136	5680
	110*	5550	140	5700



Frequency Band	Channel	Freq. (MHz)	Channel	Freq. (MHz)
TDWR Channel	118*	5590	124	5620
	120	5600	126*	5630
	122 <sup>#</sup>	5610	128	5640

Frequency Band	Channel	Freq. (MHz)	Channel	Freq. (MHz)
Straddle Channel	138 <sup>#</sup>	5690	144	5720
	142*	5710		

Note:

1. The above Frequency and Channel in "\*" were 802.11n HT40 and 802.11ac VHT40.
2. The above Frequency and Channel in "<sup>#</sup>" were 802.11ac VHT80.



## 2.2 Test Mode

Final test modes are considering the modulation and worse data rates as below table.

Modulation	Data Rate
802.11a	6 Mbps
802.11n HT20	MCS0
802.11n HT40	MCS0
802.11ac VHT80	MCS0

Test Cases	
<b>AC Conducted Emission</b>	Mode 1 : GSM 850 Idle + Bluetooth Link + WLAN Link (5G) + Earphone 2 + USB Cable 2(Charging from adapter 4)
<b>Remark:</b> For Radiated Test Cases, The tests were performance with Adapter 4, Earphone 2, USB Cable 2 .	



Ch. #		Band I : 5150-5250 MHz	Band II : 5250-5350 MHz	Band III : 5470-5725MHz
		802.11a	802.11a	802.11a
L	Low	36	52	100
M	Middle	44	60	116
H	High	48	64	140
Straddle		-	-	144

Ch. #		Band I : 5150-5250 MHz	Band II : 5250-5350 MHz	Band III : 5470-5725MHz
		802.11n HT20	802.11n HT20	802.11n HT20
L	Low	36	52	100
M	Middle	44	60	116
H	High	48	64	140
Straddle		-	-	144

Ch. #		Band I : 5150-5250 MHz	Band II : 5250-5350 MHz	Band III : 5470-5725MHz
		802.11n HT40	802.11n HT40	802.11n HT40
L	Low	38	54	102
M	Middle	-	-	110
H	High	46	62	134
Straddle		-	-	142

Ch. #		Band I : 5150-5250 MHz	Band II : 5250-5350 MHz	Band III : 5470-5725MHz
		802.11ac VHT80	802.11ac VHT80	802.11ac VHT80
L	Low	-	-	106
M	Middle	42	58	-
H	High	-	-	-
Straddle		-	-	138

### 2.3 Connection Diagram of Test System

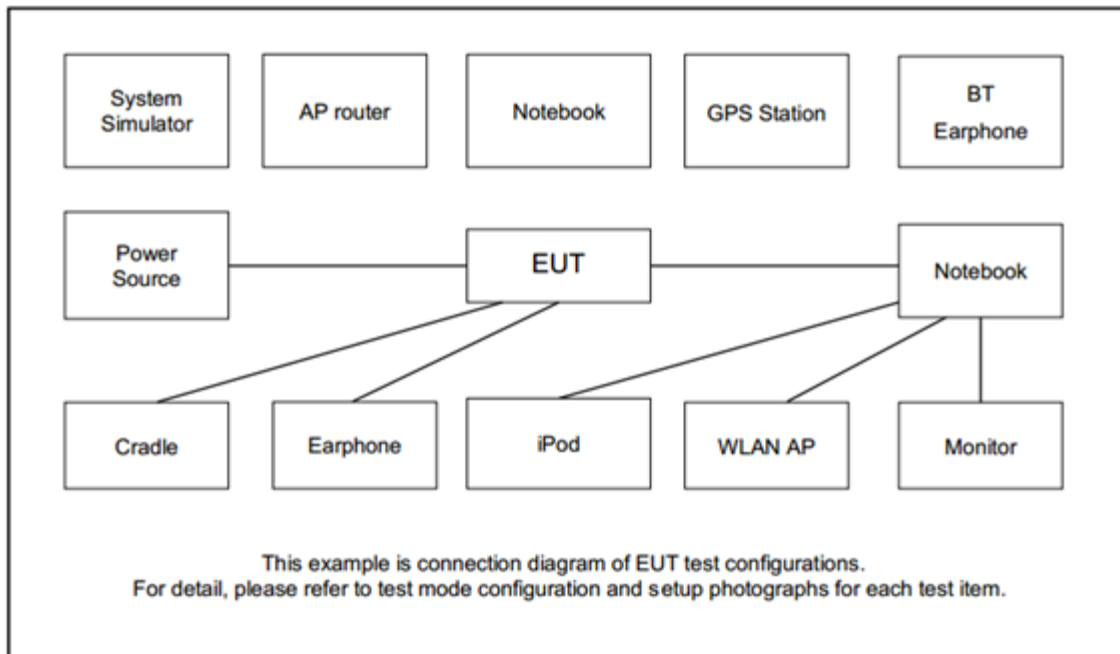

### 2.4 Support Unit used in test configuration and system

Item	Equipment	Trade Name	Model Name	FCC ID	Data Cable	Power Cord
1.	LTE Base Station	Anritsu	MT8820C	N/A	N/A	Unshielded, 1.8m
2.	WLAN AP	D-link	DIR-855	KA2DIR855A2	N/A	Unshielded, 1.8 m
3.	Bluetooth Earphone	Lenovo	LBH308	N/A	N/A	N/A
4.	Notebook	Lenovo	G480	PRC4	N/A	AC I/P: Unshielded, 1.8m DC O/P: Shielded, 1.8 m
5.	SD Card	Kingston	8GB	N/A	N/A	N/A



## 2.5 EUT Operation Test Setup

For WLAN RF test items, an engineering test program was provided and enabled to make EUT continuously transmit/receive.

For AC power line conducted emissions, the EUT was set to connect with the Notebook under large package sizes transmission.

## 2.6 Measurement Results Explanation Example

**For all conducted test items:**

The offset level is set in the spectrum analyzer to compensate the RF cable loss and attenuator factor between EUT conducted output port and spectrum analyzer. With the offset compensation, the spectrum analyzer reading level is exactly the EUT RF output level.

Example :

The spectrum analyzer offset is derived from RF cable loss.

*Offset = RF cable loss + attenuator factor.*

Following shows an offset computation example with cable loss 7.7 dB

$$\begin{aligned} \text{Offset(dB)} &= \text{RF cable loss(dB)} + \text{attenuator factor(dB)}. \\ &= 7.7 \text{ (dB)} \end{aligned}$$

### 3 Test Result

#### 3.1 26dB & 99% Occupied Bandwidth Measurement

##### 3.1.1 Description of 26dB & 99% Occupied Bandwidth

This section is for reporting purpose only.

There is no restriction limits for bandwidth.

For Straddle Channel, According to KDB 789033 D02 General UNII Test Procedures New Rules v02r01, If the power and PSD of the devices are uniform and comply with the lower limits specified for the U-NII-2 bands, a single measurement over the entire emission bandwidth can be performed to show compliance.

##### 3.1.2 Measuring Instruments

The measuring equipment is listed in the section 4 of this test report.

##### 3.1.3 Test Procedures

1. The testing follows FCC KDB 789033 D02 General UNII Test Procedures New Rules v02r01. Section C) Emission bandwidth
2. Set RBW = approximately 1% of the emission bandwidth.
3. Set the VBW > RBW.
4. Detector = Peak.
5. Trace mode = max hold
6. Measure the maximum width of the emission that is 26 dB down from the peak of the emission. Compare this with the RBW setting of the analyzer. Readjust RBW and repeat measurement as needed until the RBW/EBW ratio is approximately 1%.
7. For 99% Bandwidth Measurement, the spectrum analyzer's resolution bandwidth (RBW) is set 1MHz and set the Video bandwidth (VBW)  $\geq 3 * RBW$ .
8. Measure and record the results in the test report.

##### 3.1.4 Test Setup

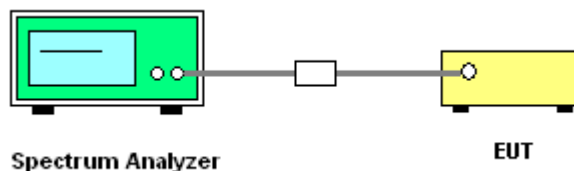

##### 3.1.5 Test Result of 26dB & 99% Occupied Bandwidth

Please refer to Appendix A.



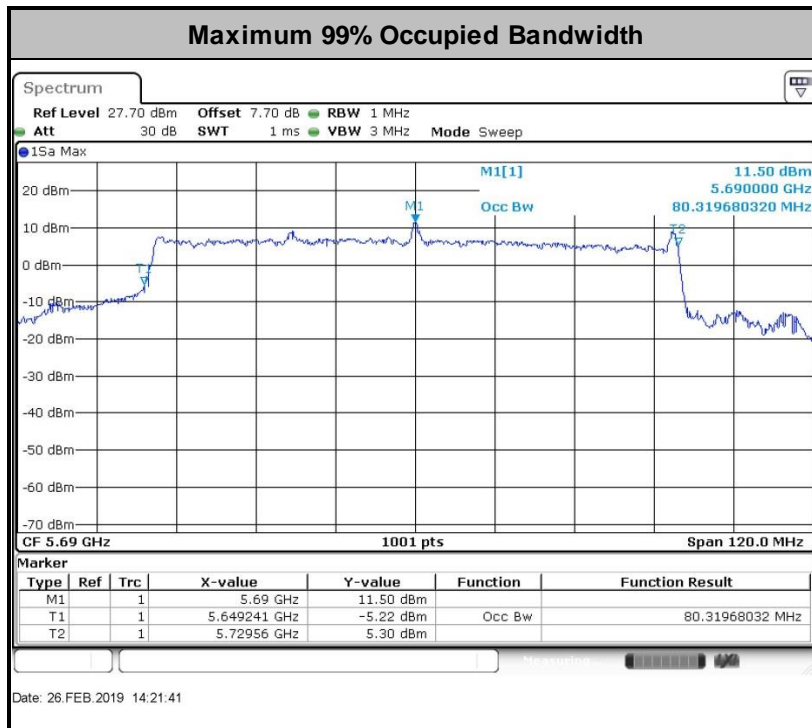
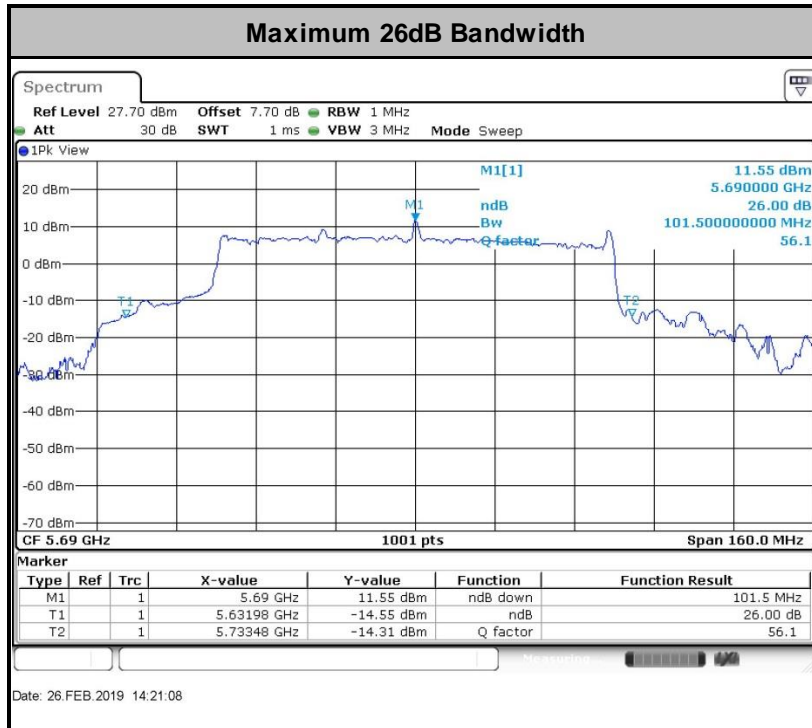

**Note:** The occupied channel bandwidth is maintained within the band of operation for all of the modulations.



## 3.2 Maximum Conducted Output Power Measurement

### 3.2.1 Limit of Maximum Conducted Output Power

<FCC 14-30 CFR 15.407>

For mobile and portable client devices in the 5.15–5.25 GHz band, the maximum conducted output power over the frequency band of operation shall not exceed 250 mW.

For the 5.25–5.725 GHz bands, the maximum conducted output power over the frequency bands of operation shall not exceed the lesser of 250 mW or  $11 + 10 \log B$ , dBm, where B is the 26 dB emission bandwidth in megahertz.

For the 5.47–5.6 GHz and 5.65–5.725 GHz band, the maximum conducted output power shall not exceed 250 mW or  $11 + 10 \log_{10} B$ , dBm, whichever power is less. The maximum e.i.r.p. shall not exceed 1.0 W or  $17 + 10 \log_{10} B$ , dBm, whichever is less. B is the 99% emission bandwidth in megahertz.

For Straddle Channel, According to KDB 789033 D02 General UNII Test Procedures New Rules v02r01, If the power and PSD of the devices are uniform and comply with the lower limits specified for the U-NII-2 bands, a single measurement over the entire emission bandwidth can be performed to show compliance.

If transmitting antennas of directional gain greater than 6 dBi are used, the peak output power shall be reduced by the amount in dB that the directional gain of the antenna exceeds 6 dBi.

Note that U-NII-2 band, devices with a maximum e.i.r.p. greater than 500 mW shall implement TPC in order to have the capability to operate at least 6 dB below the maximum permitted e.i.r.p. of 1 W.

### 3.2.2 Measuring Instruments

The measuring equipment is listed in the section 4 of this test report.

### 3.2.3 Test Procedures

The testing follows Method PM of FCC KDB 789033 D02 General UNII Test Procedures New Rules v02r01.

Method PM (Measurement using an RF average power meter):

1. Measurement is performed using a wideband RF power meter.
2. The EUT is configured to transmit continuously with a consistent duty cycle at its maximum power control level.
3. Measure the average power of the transmitter, and the average power is corrected with duty factor,  $10 \log(1/x)$ , where  $x$  is the duty cycle.

For Straddle Channel, According to KDB 789033 D02 General UNII Test Procedures New Rules v02r01, If the power and PSD of the devices are uniform and comply with the lower limits specified for the U-NII-2 bands, a single measurement over the entire emission bandwidth can be performed to show compliance.

### 3.2.4 Test Setup

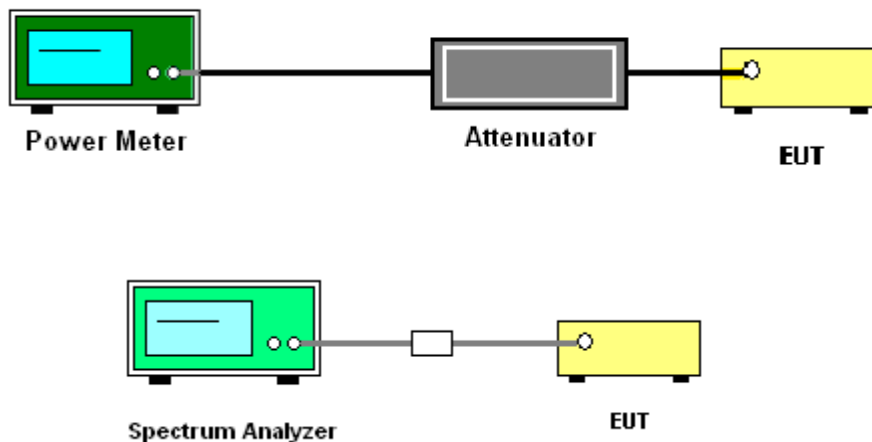

### 3.2.5 Test Result of Maximum Conducted Output Power

Please refer to Appendix A.



### 3.3 Power Spectral Density Measurement

#### 3.3.1 Limit of Power Spectral Density

<FCC 14-30 CFR 15.407>

For mobile and portable client devices in the 5.15–5.25 GHz band, the maximum power spectral density shall not exceed 11dBm in any 1 megahertz band.

For the 5.25–5.725 GHz bands, the maximum power spectral density shall not exceed 11 dBm in any 1 megahertz band.

For Straddle Channel, According to KDB 789033 D02 General UNII Test Procedures New Rules v02r01, If the power and PSD of the devices are uniform and comply with the lower limits specified for the U-NII-2 bands, a single measurement over the entire emission bandwidth can be performed to show compliance.

If transmitting antennas of directional gain greater than 6 dBi are used, the peak output power shall be reduced by the amount in dB that the directional gain of the antenna exceeds 6 dBi.

#### 3.3.2 Measuring Instruments

The measuring equipment is listed in the section 4 of this test report.

### 3.3.3 Test Procedures

The testing follows FCC KDB 789033 D02 General UNII Test Procedures New Rules v02r01.  
Section F) Maximum power spectral density.

#### # Method SA-2 #

(trace averaging across on and off times of the EUT transmissions, followed by duty cycle correction).

- Measure the duty cycle.
  - Set span to encompass the entire emission bandwidth (EBW) of the signal.
  - Set RBW = 1 MHz.
  - Set VBW  $\geq$  3 MHz.
  - Number of points in sweep  $\geq$  2 Span / RBW.
  - Sweep time = auto.
  - Detector = RMS
  - Trace average at least 100 traces in power averaging mode.
  - Add  $10 \log(1/x)$ , where  $x$  is the duty cycle, to the measured power in order to compute the average power during the actual transmission times. For example, add  $10 \log(1/0.25) = 6$  dB if the duty cycle is 25 percent.
1. The RF output of EUT was connected to the spectrum analyzer by a low loss cable.
  2. Each plot has already offset with cable loss, and attenuator loss. Measure the PPSD and record it.

### 3.3.4 Test Setup

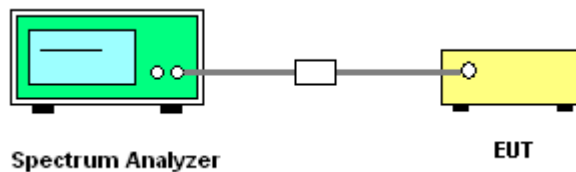



### 3.3.5 Test Result of Power Spectral Density

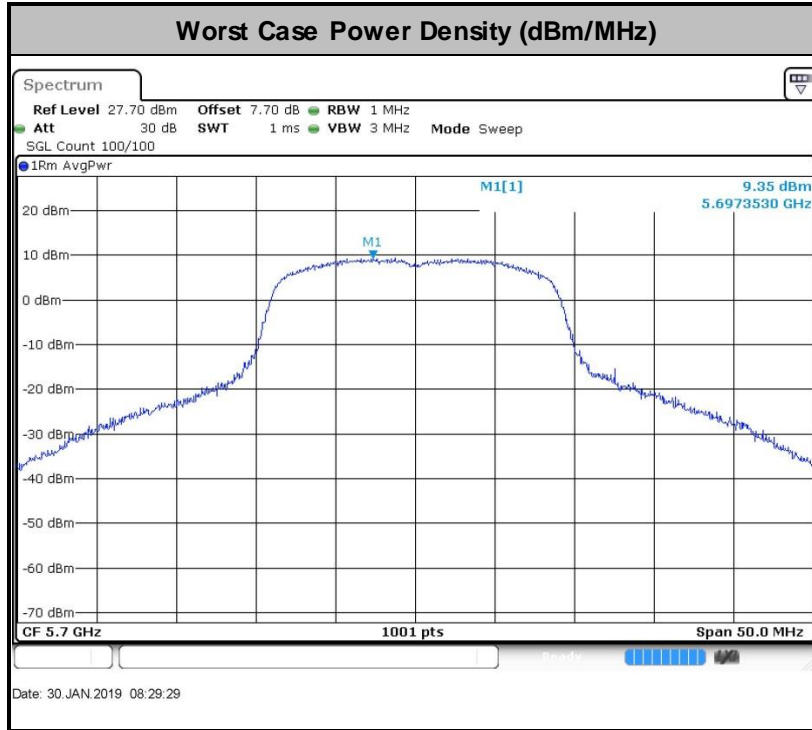



### 3.4 Unwanted Emissions Measurement

This section is to measure unwanted emissions through radiated measurement for band edge spurious emissions and out of band emissions measurement.

#### 3.4.1 Limit of Unwanted Emissions

- (1) For transmitters operating in the 5150-5250 MHz band: all emissions outside of the 5150-5350 MHz band shall not exceed an EIRP of -27dBm/MHz.

For transmitters operating in the 5250-5350 MHz band: all emissions outside of the 5150-5350 MHz band shall not exceed an EIRP of -27 dBm/MHz. Devices operating in the 5250-5350 MHz band that generate emissions in the 5150-5250 MHz band must meet all applicable technical requirements for operation in the 5150-5250 MHz band (including indoor use) or alternatively meet an out-of-band emission EIRP limit of -27 dBm/MHz in the 5150-5250 MHz band.

For transmitters operating in the 5470-5600 MHz and 5650-5725MHz band: all emissions outside of the 5470-5600 MHz and 5650-5725MHz band shall not exceed an EIRP of -27 dBm/MHz.

- (2) Unwanted spurious emissions fallen in restricted bands shall comply with the general field strength limits as below table,

Frequency (MHz)	Field Strength (microvolts/meter)	Measurement Distance (meters)
0.009 – 0.490	2400/F(kHz)	300
0.490 – 1.705	24000/F(kHz)	30
1.705 – 30.0	30	30
30 – 88	100	3
88 – 216	150	3
216 - 960	200	3
Above 960	500	3



EIRP (dBm)	Field Strength at 3m (dBμV/m)
- 27	68.2

**Note:** The following formula is used to convert the EIRP to field strength.

$$EIRP = E_{Meas} + 20\log (d_{Meas}) - 104.7$$

where

EIRP is the equivalent isotropically radiated power, in dBm

$E_{Meas}$  is the field strength of the emission at the measurement distance, in dBμV/m

$d_{Meas}$  is the measurement distance, in m

### 3.4.2 Measuring Instruments

The measuring equipment is listed in the section 4 of this test report.





### 3.4.3 Test Procedures

1. The testing follows FCC KDB 789033 D02 General UNII Test Procedures New Rules v02r01. Section G) Unwanted emissions measurement.
  - (1) Procedure for Unwanted Emissions Measurements Below 1000MHz
    - RBW = 120 kHz
    - VBW = 300 kHz
    - Detector = Peak
    - Trace mode = max hold
  - (2) Procedure for Peak Unwanted Emissions Measurements Above 1000 MHz
    - RBW = 1 MHz
    - VBW  $\geq$  3 MHz
    - Detector = Peak
    - Sweep time = auto
    - Trace mode = max hold
  - (3) Procedures for Average Unwanted Emissions Measurements Above 1000MHz
    - RBW = 1 MHz
    - VBW = 10 Hz, when duty cycle is no less than 98 percent.
    - VBW  $\geq$  1/T, when duty cycle is less than 98 percent where T is the minimum transmission duration over which the transmitter is on and is transmitting at its maximum power control level for the tested mode of operation.
2. The EUT was placed on a turntable with 0.8 meter for frequency below 1GHz and 1.5 meter for frequency above 1GHz respectively above ground.
3. The EUT was set 3 meters from the interference receiving antenna which was mounted on the top of a variable height antenna tower.
4. The antenna is a broadband antenna and its height is adjusted between one meter and four meters above ground to find the maximum value of the field strength for both horizontal polarization and vertical polarization of the antenna.
5. For each suspected emission, the EUT was arranged to its worst case and then adjust the antenna tower (from 1 m to 4 m) and turntable (from 0 degree to 360 degrees) to find the maximum reading.
6. For testing below 1GHz, if the emission level of the EUT in peak mode was 3 dB lower than the limit specified, then peak values of EUT will be reported, otherwise, the emissions will be repeated one by one using the CISPR quasi-peak method and reported.
7. For testing above 1GHz, the emission level of the EUT in peak mode was 20dB lower than average limit (that means the emission level in average mode also complies with the limit in average mode), then peak values of EUT will be reported, otherwise, the emissions will be measured in average mode again and reported.

### 3.4.4 Test Setup

For radiated emissions below 30MHz

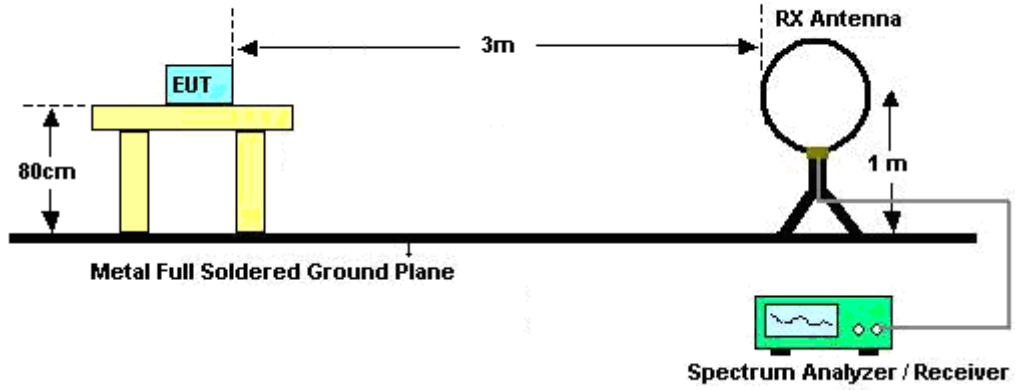

For radiated emissions from 30MHz to 1GHz

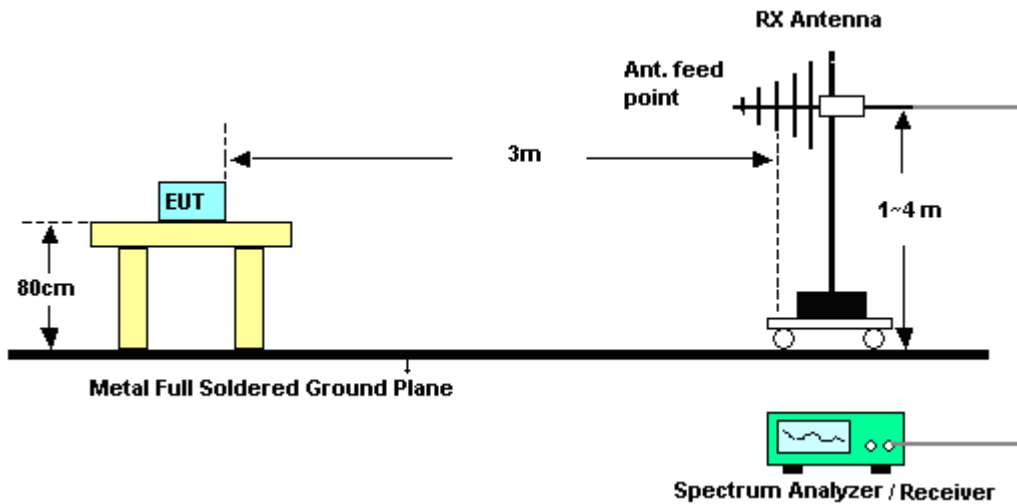

For radiated emissions above 1GHz

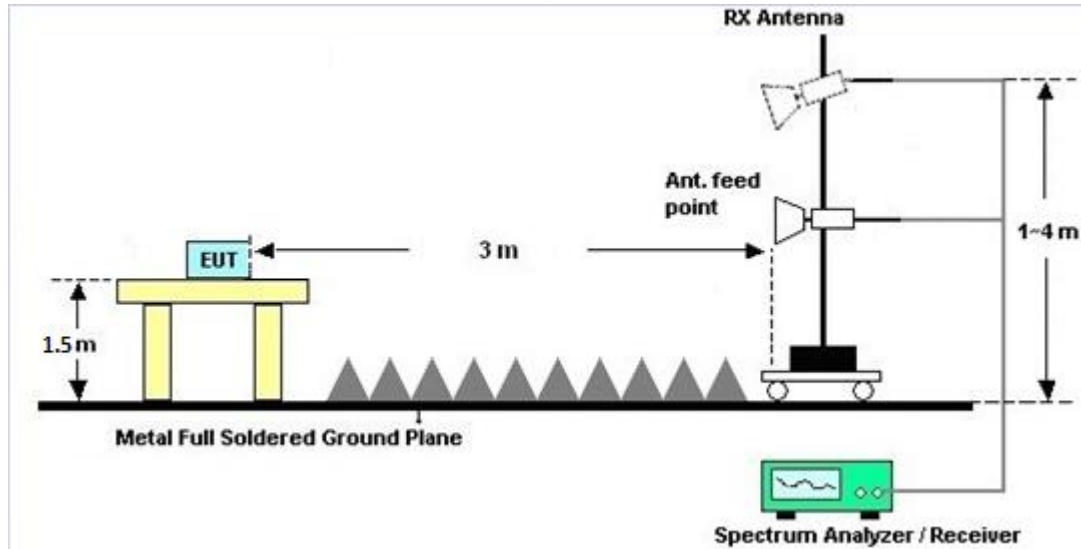

### 3.4.5 Test Results of Radiated Spurious Emissions (9 kHz ~ 30 MHz)

The low frequency, which started from 9 kHz to 30MHz, was pre-scanned and the result which was 20dB lower than the limit line was not reported.

There is a comparison data of both open-field test site and semi-Anechoic chamber, and the result came out very similar.

### 3.4.6 Test Result of Radiated Spurious at Band Edges

Please refer to Appendix C.

### 3.4.7 Duty Cycle

Please refer to Appendix D.

### 3.4.8 Test Result of Radiated Spurious Emissions (30MHz ~ 10th Harmonic)

Please refer to Appendix C.



### 3.5 AC Conducted Emission Measurement

#### 3.5.1 Limit of AC Conducted Emission

For equipment that is designed to be connected to the public utility (AC) power line, the radio frequency voltage that is conducted back onto the AC power line on any frequency or frequencies within the band 150 kHz to 30 MHz shall not exceed the limits in the following table.

Frequency of emission (MHz)	Conducted limit (dBµV)	
	Quasi-peak	Average
0.15-0.5	66 to 56*	56 to 46*
0.5-5	56	46
5-30	60	50

\*Decreases with the logarithm of the frequency.

#### 3.5.2 Measuring Instruments

The measuring equipment is listed in the section 4 of this test report.

#### 3.5.3 Test Procedures

1. The EUT was placed 0.4 meter from the conducting wall of the shielding room was kept at least 80 centimeters from any other grounded conducting surface.
2. Connect EUT to the power mains through a line impedance stabilization network (LISN).
3. All the support units are connecting to the other LISN.
4. The LISN provides 50 ohm coupling impedance for the measuring instrument.
5. The FCC states that a 50 ohm, 50 microhenry LISN should be used.
6. Both sides of AC line were checked for maximum conducted interference.
7. The frequency range from 150 kHz to 30 MHz was searched.
8. Set the test-receiver system to Peak Detect Function and specified bandwidth with Maximum Hold Mode.

### 3.5.4 Test Setup

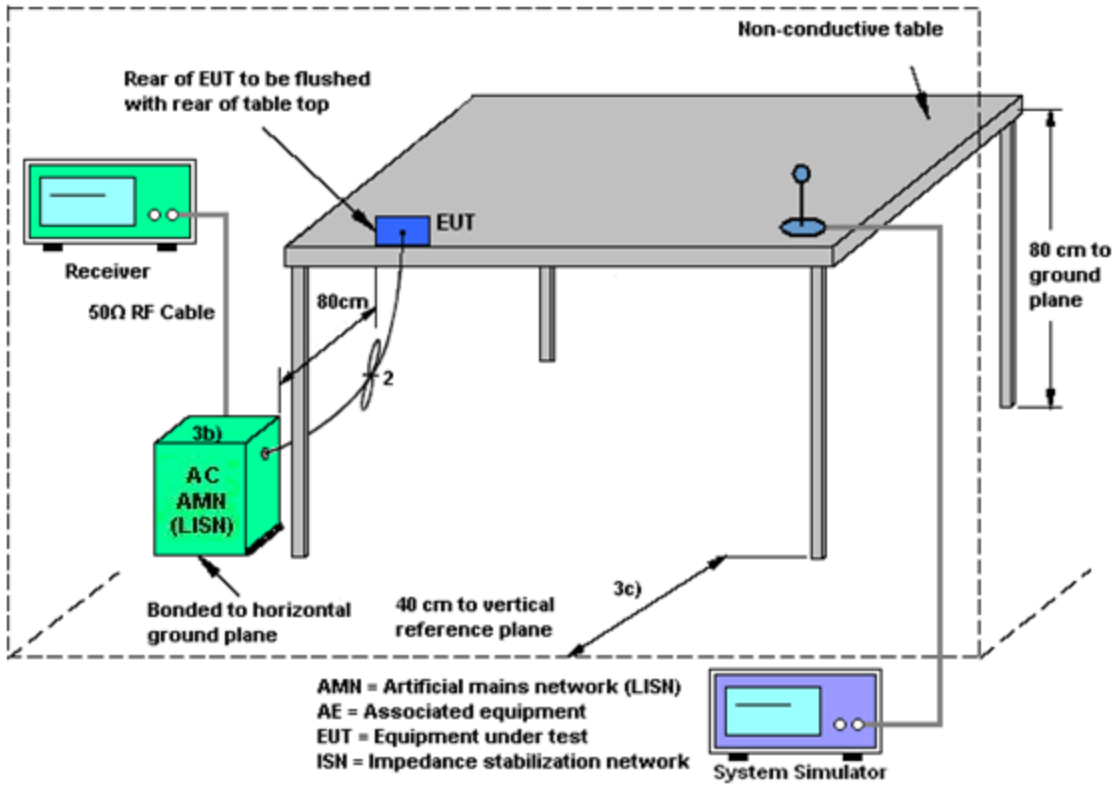

### 3.5.5 Test Result of AC Conducted Emission

Please refer to Appendix B.



## **3.6 Automatically Discontinue Transmission**

### **3.6.1 Limit of Automatically Discontinue Transmission**

The device shall automatically discontinue transmission in case of either absence of information to transmit or operational failure. These provisions are not intended to preclude the transmission of control or signaling information or the use of repetitive codes used by certain digital technologies to complete frame or burst intervals. Applicants shall include in their application for equipment authorization to describe how this requirement is met.

### **3.6.2 Measuring Instruments**

The measuring equipment is listed in the section 4 of this test report.

### **3.6.3 Test Result of Automatically Discontinue Transmission**

While the EUT is not transmitting any information, the EUT can automatically discontinue transmission and become standby mode for power saving. The EUT can detect the controlling signal of ACK message transmitting from remote device and verify whether it shall resend or discontinue transmission.



## **3.7 Antenna Requirements**

### **3.7.1 Standard Applicable**

If transmitting antenna directional gain is greater than 6 dBi, both the peak transmit power and the peak power spectral density shall be reduced by the amount in dB that the directional gain of the antenna exceeds 6 dBi.

### **3.7.2 Antenna Anti-Replacement Construction**

An embedded-in antenna design is used.

### **3.7.3 Antenna Gain**

The antenna peak gain of EUT is less than 6 dBi. Therefore, it is not necessary to reduce maximum peak output power limit.



## 4 List of Measuring Equipment

Instrument	Manufacturer	Model No.	Serial No.	Characteristics	Calibration Date	Test Date	Due Date	Remark
Spectrum Analyzer	R&S	FSV40	101040	10Hz~40GHz	Aug. 07, 2018	Jan. 30, 2019~ Feb. 26, 2019	Aug. 06, 2019	Conducted (TH01-KS)
Pulse Power Sensor	Anritsu	MA2411B	0917070	300MHz~40GHz	Jan. 14, 2019	Jan. 30, 2019~ Feb. 26, 2019	Jan. 13, 2020	Conducted (TH01-KS)
Power Meter	Anritsu	ML2495A	1005002	50MHz Bandwidth	Jan. 14, 2019	Jan. 30, 2019~ Feb. 26, 2019	Jan. 13, 2020	Conducted (TH01-KS)
Thermal Chamber	Hongzhan	LP-150U	H20140114 40	-40~+150°C 20%~95%RH	Jun. 27, 2018	Jan. 30, 2019~ Feb. 26, 2019	Jun. 26, 2019	Conducted (TH01-KS)
EMI Test Receiver	Keysight	N9038A	MY572901 51	3Hz~8.5GHz;Ma x 30dBm	Jun. 25.2018	Jan. 28, 2019	Jun. 24. 2019	Radiation (03CH05-KS)
EXA Spectrum Analyzer	Keysight	N9010A	MY551502 44	10Hz~44GHz	Apr. 17, 2018	Jan. 28, 2019	Apr. 16, 2019	Radiation (03CH05-KS)
Loop Antenna	R&S	HFH2-Z2	100321	9kHz~30MHz	Oct. 19, 2018	Jan. 28, 2019	Oct. 18, 2019	Radiation (03CH05-KS)
Bilog Antenna	TeseQ	CBL6111D	49922	30MHz~1GHz	Jun. 12, 2018	Jan. 28, 2019	Jun. 11, 2019	Radiation (03CH05-KS)
Double Ridge Horn Antenna	ETS-Lindgren	3117	75959	1GHz~18GHz	Mar. 16, 2018	Jan. 28, 2019	Mar. 15, 2019	Radiation (03CH05-KS)
SHF-EHF Horn	Schwarzbeck	BBHA 9170	BBHA1702 49	15GHz~40GHz	Feb. 07, 2018	Jan. 28, 2019	Feb. 06, 2019	Radiation (03CH05-KS)
Amplifier	com-power	PA-103A	161069	1MHz ~1000MHz / 32 dB	Apr. 17, 2018	Jan. 28, 2019	Apr. 16, 2019	Radiation (03CH05-KS)
Amplifier	MITEQ	TTA1840-35- HG	1887435	18~40GHz	Feb. 8, 2018	Jan. 28, 2019	Feb. 7, 2019	Radiation (03CH05-KS)
high gain Amplifier	MITEQ	AMF-7D-0010 1800-30-10P	2025788	1Ghz~18Ghz	Apr. 17. 2018	Jan. 28, 2019	Apr. 16, 2019	Radiation (03CH05-KS)
AC Power Source	Chroma	61601	F10409000 4	N/A	NCR	Jan. 28, 2019	NCR	Radiation (03CH05-KS)
Turn Table	ChamPro	EM 1000-T	060762-T	0~360 degree	NCR	Jan. 28, 2019	NCR	Radiation (03CH05-KS)
Antenna Mast	ChamPro	EM 1000-A	060762-A	1 m~4 m	NCR	Jan. 28, 2019	NCR	Radiation (03CH05-KS)
EMI Receiver	R&S	ESC17	100768	9kHz~7GHz;	Apr. 19, 2018	Jan. 18, 2019	Apr. 18, 2019	Conduction (CO01-KS)
AC LISN	MessTec	AN3016	060103	9kHz~30MHz	Oct. 12, 2018	Jan. 18, 2019	Oct. 11, 2019	Conduction (CO01-KS)
AC LISN (for auxiliary equipment)	MessTec	AN3016	060105	9kHz~30MHz	Nov. 19, 2018	Jan. 18, 2019	Nov. 18, 2019	Conduction (CO01-KS)
AC Power Source	Chroma	61602	ABP00000 0811	AC 0V~300V, 45Hz~1000Hz	Oct. 12, 2018	Jan. 18, 2019	Oct. 11, 2019	Conduction (CO01-KS)





## 5 Uncertainty of Evaluation

The measurement uncertainties shown below were calculated in accordance with the requirements of ANSI 63.10-2013. All the measurement uncertainty value were shown with a coverage K=2 to indicate 95% level of confidence. The measurement data show herein meets or exceeds the CISPR measurement uncertainty values specified in CISPR 16-4-2 and can be compared directly to specified limit to determine compliance.

### Uncertainty of Conducted Emission Measurement (150kHz ~ 30MHz)

Measuring Uncertainty for a Level of Confidence of 95% (U = 2Uc(y))	2.9dB
---	-------

### Uncertainty of Radiated Emission Measurement (30 MHz ~ 1000 MHz)

Measuring Uncertainty for a Level of Confidence of 95% (U = 2Uc(y))	5.0 dB
---	--------

### Uncertainty of Radiated Emission Measurement (1000 MHz ~ 18000 MHz)

Measuring Uncertainty for a Level of Confidence of 95% (U = 2Uc(y))	5.0 dB
---	--------

### Uncertainty of Radiated Emission Measurement (18000 MHz ~ 40000 MHz)

Measuring Uncertainty for a Level of Confidence of 95% (U = 2Uc(y))	5.0 dB
---	--------



## **Appendix A. Conducted Test Results**

Test Engineer:	iron yao	Temperature:	21~25	°C
Test Date:	2019/1/30~2019/2/26	Relative Humidity:	51~54	%

**TEST RESULTS DATA**  
**26dB and 99% OBW**

Band I										
Mod.	Data Rate	NTX	CH.	Freq. (MHz)	99% Bandwidth (MHz)	26 dB Bandwidth (MHz)	IC 99% Bandwidth Power Limit (dBm)	IC 99% Bandwidth EIRP Limit (dBm)		
11a	6Mbps	1	36	5180	18.03	22.18	-	22.56		
11a	6Mbps	1	44	5220	18.23	22.53	-	22.61		
11a	6Mbps	1	48	5240	18.13	22.58	-	22.58		
HT20	MCS0	1	36	5180	18.88	23.83	-	22.76		
HT20	MCS0	1	44	5220	19.28	24.53	-	22.85		
HT20	MCS0	1	48	5240	19.28	24.63	-	22.85		
HT40	MCS0	1	38	5190	39.86	58.08	-	23.01		
HT40	MCS0	1	46	5230	39.83	55.56	-	23.01		
VHT80	MCS0	1	42	5210	79.12	92.87	-	23.01		

**TEST RESULTS DATA**  
**Average Power Table**

FCC Band I										
Mod.	Data Rate	NTX	CH.	Freq. (MHz)	Duty Factor (dB)	Average Conducted Power (dBm)	FCC Conducted Power Limit (dBm)	DG (dBi)		Pass/Fail
11a	6Mbps	1	36	5180	0.21	18.05	24.00	-1.00		Pass
11a	6Mbps	1	44	5220	0.21	18.07	24.00	-1.00		Pass
11a	6Mbps	1	48	5240	0.21	18.05	24.00	-1.00		Pass
HT20	MCS0	1	36	5180	0.23	18.38	24.00	-1.00		Pass
HT20	MCS0	1	44	5220	0.23	18.05	24.00	-1.00		Pass
HT20	MCS0	1	48	5240	0.23	18.25	24.00	-1.00		Pass
HT40	MCS0	1	38	5190	0.55	17.03	24.00	-1.00		Pass
HT40	MCS0	1	46	5230	0.55	16.93	24.00	-1.00		Pass
VHT20	MCS0	1	36	5180	0.19	18.34	24.00	-1.00		Pass
VHT20	MCS0	1	44	5220	0.19	18.05	24.00	-1.00		Pass
VHT20	MCS0	1	48	5240	0.19	18.30	24.00	-1.00		Pass
VHT40	MCS0	1	38	5190	0.57	17.02	24.00	-1.00		Pass
VHT40	MCS0	1	46	5230	0.57	16.95	24.00	-1.00		Pass
VHT80	MCS0	1	42	5210	1.17	15.34	24.00	-1.00		Pass

**TEST RESULTS DATA**  
**Power Spectral Density**

FCC Band I										
Mod.	Data Rate	N <sub>TX</sub>	CH.	Freq. (MHz)	Duty Factor (dB)	Average Power Density (dBm/MHz)	Average PSD Limit (dBm/MHz)	DG (dBi)	-	Pass/Fail
11a	6Mbps	1	36	5180	0.21	8.84	11.00	-1.00		Pass
11a	6Mbps	1	44	5220	0.21	9.07	11.00	-1.00		Pass
11a	6Mbps	1	48	5240	0.21	8.60	11.00	-1.00		Pass
HT20	MCS0	1	36	5180	0.23	9.15	11.00	-1.00		Pass
HT20	MCS0	1	44	5220	0.23	8.77	11.00	-1.00		Pass
HT20	MCS0	1	48	5240	0.23	8.98	11.00	-1.00		Pass
HT40	MCS0	1	38	5190	0.55	4.39	11.00	-1.00		Pass
HT40	MCS0	1	46	5230	0.55	4.03	11.00	-1.00		Pass
VHT80	MCS0	1	42	5210	1.17	0.82	11.00	-1.00		Pass

**TEST RESULTS DATA**  
**26dB and 99% OBW**

Band II										
Mod.	Data Rate	N <sub>TX</sub>	CH.	Freq. (MHz)	99% Bandwidth (MHz)	26 dB Bandwidth (MHz)	IC 99% Bandwidth Power Limit (dBm)	IC 99% Bandwidth EIRP Limit (dBm)	FCC 26dB Bandwidth Power Limit (dBm)	Note
11a	6M bps	1	52	5260	18.08	22.68	23.57	29.57	23.98	
11a	6M bps	1	60	5300	17.98	22.63	23.55	29.55	23.98	
11a	6M bps	1	64	5320	18.28	22.48	23.62	29.62	23.98	
HT20	MCS 0	1	52	5260	19.08	24.03	23.81	29.81	23.98	
HT20	MCS 0	1	60	5300	19.38	24.53	23.87	29.87	23.98	
HT20	MCS 0	1	64	5320	19.08	24.08	23.81	29.81	23.98	
HT40	MCS 0	1	54	5270	40.26	57.36	23.98	30.00	23.98	
HT40	MCS 0	1	62	5310	39.96	53.32	23.98	30.00	23.98	
VHT80	MCS 0	1	58	5290	79.60	89.83	23.98	30.00	23.98	

**TEST RESULTS DATA**  
**Average Power Table**

FCC Band II										
Mod.	Data Rate	N <sub>TX</sub>	CH.	Freq. (MHz)	Duty Factor (dB)	Average Conducted Power (dBm)	FCC Conducted Power Limit (dBm)	DG (dBi)	EIRP Power Limit (dBm)	Pass/Fail
11a	6M bps	1	52	5260	0.21	18.19	23.98	-1.20	26.99	Pass
11a	6M bps	1	60	5300	0.21	18.57	23.98	-1.20	26.99	Pass
11a	6M bps	1	64	5320	0.21	18.58	23.98	-1.20	26.99	Pass
HT20	MCS 0	1	52	5260	0.23	18.30	23.98	-1.20	26.99	Pass
HT20	MCS 0	1	60	5300	0.23	18.57	23.98	-1.20	26.99	Pass
HT20	MCS 0	1	64	5320	0.23	18.65	23.98	-1.20	26.99	Pass
HT40	MCS 0	1	54	5270	0.55	17.07	23.98	-1.20	26.99	Pass
HT40	MCS 0	1	62	5310	0.55	17.34	23.98	-1.20	26.99	Pass
VHT20	MCS 0	1	52	5260	0.19	18.40	23.98	-1.20	26.99	Pass
VHT20	MCS 0	1	60	5300	0.19	18.60	23.98	-1.20	26.99	Pass
VHT20	MCS 0	1	64	5320	0.19	18.62	23.98	-1.20	26.99	Pass
VHT40	MCS 0	1	54	5270	0.57	17.25	23.98	-1.20	26.99	Pass
VHT40	MCS 0	1	62	5310	0.57	17.32	23.98	-1.20	26.99	Pass
VHT80	MCS 0	1	58	5290	1.17	15.83	23.98	-1.20	26.99	Pass



**TEST RESULTS DATA**  
**Power Spectral Density**

Band II										
Mod.	Data Rate	N <sub>TX</sub>	CH.	Freq. (MHz)	Duty Factor (dB)	Average Power Density (dBm/MHz)	Average PSD Limit (dBm/MHz)	DG (dBi)		Pass/Fail
11a	6M bps	1	52	5260	0.21	8.60	11.00	-1.20		Pass
11a	6M bps	1	60	5300	0.21	8.94	11.00	-1.20		Pass
11a	6M bps	1	64	5320	0.21	9.01	11.00	-1.20		Pass
HT20	MCS 0	1	52	5260	0.23	8.94	11.00	-1.20		Pass
HT20	MCS 0	1	60	5300	0.23	9.10	11.00	-1.20		Pass
HT20	MCS 0	1	64	5320	0.23	9.35	11.00	-1.20		Pass
HT40	MCS 0	1	54	5270	0.55	3.79	11.00	-1.20		Pass
HT40	MCS 0	1	62	5310	0.55	4.26	11.00	-1.20		Pass
VHT80	MCS 0	1	58	5290	1.17	0.10	11.00	-1.20		Pass

**TEST RESULTS DATA**  
**26dB and 99% OBW**

Band III										
Mod.	Data Rate	N <sub>TX</sub>	CH.	Freq. (MHz)	99% Bandwidth (MHz)	26 dB Bandwidth (MHz)	IC 99% Bandwidth Power Limit (dBm)	IC 99% Bandwidth EIRP Limit (dBm)	FCC 26dB Bandwidth Power Limit (dBm)	Note
11a	6M bps	1	100	5500	18.18	22.53	23.60	29.60	23.98	
11a	6M bps	1	116	5580	18.58	22.63	23.69	29.69	23.98	
11a	6M bps	1	140	5700	18.78	25.87	23.74	29.74	23.98	
11a	6M bps	1	144	5720	18.68	25.72	23.71	29.71	23.98	
HT20	MCS 0	1	100	5500	19.08	25.03	23.81	29.81	23.98	
HT20	MCS 0	1	116	5580	19.63	26.02	23.93	29.93	23.98	
HT20	MCS 0	1	140	5700	20.18	28.92	23.98	30.00	23.98	
HT20	MCS 0	1	144	5720	19.98	27.07	23.98	30.00	23.98	
HT40	MCS 0	1	102	5510	40.26	63.03	23.98	30.00	23.98	
HT40	MCS 0	1	110	5550	40.36	63.12	23.98	30.00	23.98	
HT40	MCS 0	1	134	5670	41.56	63.30	23.98	30.00	23.98	
HT40	MCS0	1	142	5710	41.26	62.67	23.98	30.00	23.98	
VHT80	MCS 0	1	106	5530	79.48	97.82	23.98	30.00	23.98	
VHT80	MCS 0	1	122	5610	79.72	100.86	23.98	30.00	23.98	
VHT80	MCS0	1	138	5690	80.32	101.50	23.98	30.00	23.98	

**TEST RESULTS DATA**  
**Average Power Table**

FCC Band III										
Mod.	Data Rate	N <sub>TX</sub>	CH.	Freq. (MHz)	Duty Factor (dB)	Average Conducted Power (dBm)	FCC Conducted Power Limit (dBm)	DG (dBi)	EIRP Power Limit (dBm)	Pass/Fail
11a	6M bps	1	100	5500	0.21	17.87	23.98	-1.20	26.99	Pass
11a	6M bps	1	116	5580	0.21	18.87	23.98	-1.20	26.99	Pass
11a	6M bps	1	140	5700	0.21	18.77	23.98	-1.20	26.99	Pass
11a	6M bps	1	144	5720	0.21	18.17	23.98	-1.20	26.99	Pass
HT20	MCS 0	1	100	5500	0.23	18.06	23.98	-1.20	26.99	Pass
HT20	MCS 0	1	116	5580	0.23	18.99	23.98	-1.20	26.99	Pass
HT20	MCS 0	1	140	5700	0.23	18.97	23.98	-1.20	26.99	Pass
HT20	MCS 0	1	144	5720	0.23	18.60	23.98	-1.20	26.99	Pass
HT40	MCS 0	1	102	5510	0.55	16.69	23.98	-1.20	26.99	Pass
HT40	MCS 0	1	110	5550	0.55	17.09	23.98	-1.20	26.99	Pass
HT40	MCS0	1	134	5670	0.55	17.53	23.98	-1.20	26.99	Pass
HT40	MCS 0	1	142	5710	0.55	17.26	23.98	-1.20	26.99	Pass
VHT20	MCS 0	1	100	5500	0.19	17.93	23.98	-1.20	26.99	Pass
VHT20	MCS 0	1	116	5580	0.19	18.82	23.98	-1.20	26.99	Pass
VHT20	MCS 0	1	140	5700	0.19	18.91	23.98	-1.20	26.99	Pass
VHT20	MCS 0	1	144	5720	0.19	18.78	23.98	-1.20	26.99	Pass
VHT40	MCS 0	1	102	5510	0.57	16.71	23.98	-1.20	26.99	Pass
VHT40	MCS 0	1	110	5550	0.57	17.30	23.98	-1.20	26.99	Pass
VHT40	MCS 0	1	134	5670	0.57	17.39	23.98	-1.20	26.99	Pass
VHT40	MCS0	1	142	5670	0.57	17.28	23.98	-1.20	26.99	Pass
VHT80	MCS 0	1	106	5530	1.17	15.70	23.98	-1.20	26.99	Pass
VHT80	MCS 0	1	122	5610	1.17	16.55	23.98	-1.20	26.99	Pass
VHT80	MCS 0	1	138	5690	1.17	16.59	23.98	-1.20	26.99	Pass

***TEST RESULTS DATA***  
***Power Spectral Density***

Band III										
Mod.	Data Rate	N <sub>TX</sub>	CH.	Freq. (MHz)	Duty Factor (dB)	Average Power Density (dBm/MHz)	Average PSD Limit (dBm/MHz)	DG (dBi)		Pass/Fail
11a	6M bps	1	100	5500	0.21	8.34	11.00	-1.20		Pass
11a	6M bps	1	116	5580	0.21	8.90	11.00	-1.20		Pass
11a	6M bps	1	140	5700	0.21	9.34	11.00	-1.20		Pass
11a	6Mbps	1	100	5500	0.21	7.63	11.00	-1.20		Pass
HT20	MCS 0	1	116	5580	0.23	8.91	11.00	-1.20		Pass
HT20	MCS 0	1	116	5580	0.23	9.44	11.00	-1.20		Pass
HT20	MCS 0	1	140	5700	0.23	9.58	11.00	-1.20		Pass
HT20	MCS 0	1	144	5720	0.23	7.17	11.00	-1.20		Pass
HT40	MCS 0	1	102	5510	0.55	3.76	11.00	-1.20		Pass
HT40	MCS 0	1	110	5550	0.55	4.55	11.00	-1.20		Pass
HT40	MCS 0	1	134	5670	0.55	4.56	11.00	-1.20		Pass
HT40	MCS0	1	142	5710	0.55	2.77	11.00	-1.20		Pass
VHT80	MCS 0	1	106	5530	1.17	-0.20	11.00	-1.20		Pass
VHT80	MCS 0	1	122	5610	1.17	0.26	11.00	-1.20		Pass
VHT80	MCS0	1	138	5690	1.17	0.08	11.00	-1.20		Pass



## Appendix B. AC Conducted Emission Test Results

Test Engineer :	Amos Zhao	Temperature :	23.3~24.2°C
		Relative Humidity :	38~40 %
Test Voltage :	120Vac / 60Hz	Phase :	Line
Remark :	All emissions not reported here are more than 10 dB below the prescribed limit.		

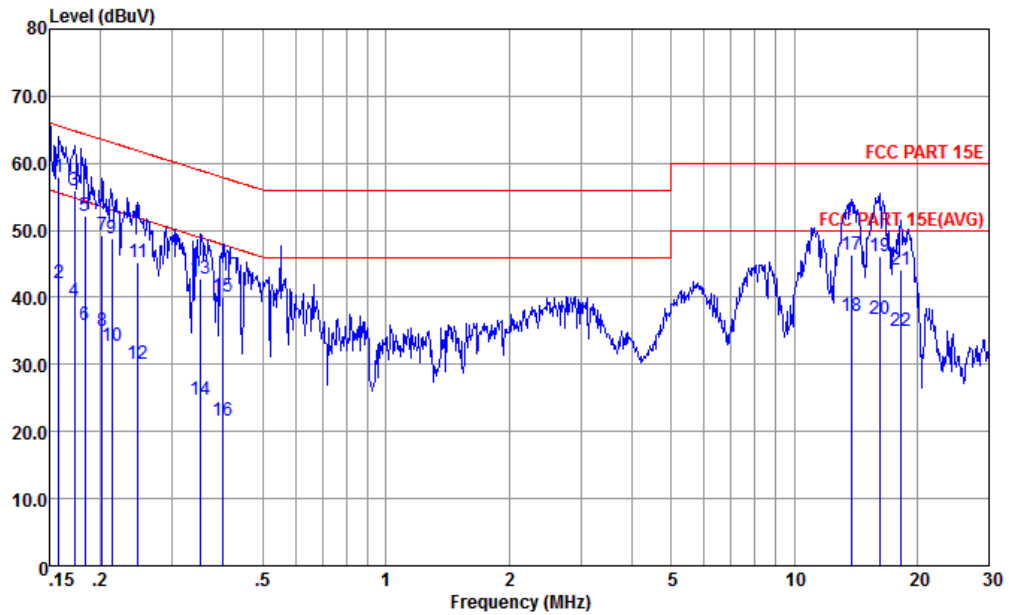

Site : CO01-KS  
 Condition : FCC PART 15E LISN-L-181013-060103 LINE

	Freq	Level	Over Limit	Limit Line	Read Level	LISN Factor	Cable Loss	Remark
	MHz	dBuV	dB	dBuV	dBuV	dB	dB	
1 *	0.158	57.99	-7.57	65.56	47.30	0.23	10.46	QP
2	0.158	42.19	-13.37	55.56	31.50	0.23	10.46	Average
3	0.173	55.85	-8.96	64.81	45.20	0.23	10.42	QP
4	0.173	39.45	-15.36	54.81	28.80	0.23	10.42	Average
5	0.183	52.12	-12.21	64.33	41.50	0.22	10.40	QP
6	0.183	35.82	-18.51	54.33	25.20	0.22	10.40	Average
7	0.202	49.18	-14.36	63.54	38.60	0.22	10.36	QP
8	0.202	35.08	-18.46	53.54	24.50	0.22	10.36	Average
9	0.213	48.78	-14.32	63.10	38.20	0.22	10.36	QP
10	0.213	32.78	-20.32	53.10	22.20	0.22	10.36	Average
11	0.247	45.16	-16.70	61.86	34.60	0.22	10.34	QP
12	0.247	30.16	-21.70	51.86	19.60	0.22	10.34	Average
13	0.352	42.71	-16.20	58.91	32.20	0.23	10.28	QP
14	0.352	24.71	-24.20	48.91	14.20	0.23	10.28	Average
15	0.400	40.09	-17.77	57.86	29.59	0.23	10.27	QP
16	0.400	21.69	-26.17	47.86	11.19	0.23	10.27	Average
17	13.768	46.32	-13.68	60.00	35.61	0.33	10.38	QP
18	13.768	37.32	-12.68	50.00	26.61	0.33	10.38	Average
19	16.226	46.02	-13.98	60.00	35.20	0.40	10.42	QP
20	16.226	36.72	-13.28	50.00	25.90	0.40	10.42	Average
21	18.232	44.12	-15.88	60.00	33.20	0.46	10.46	QP
22	18.232	35.02	-14.98	50.00	24.10	0.46	10.46	Average



Test Engineer :	Amos Zhao	Temperature :	23.3~24.2°C
		Relative Humidity :	38~40 %
Test Voltage :	120Vac / 60Hz	Phase :	Neutral
Remark :	All emissions not reported here are more than 10 dB below the prescribed limit.		

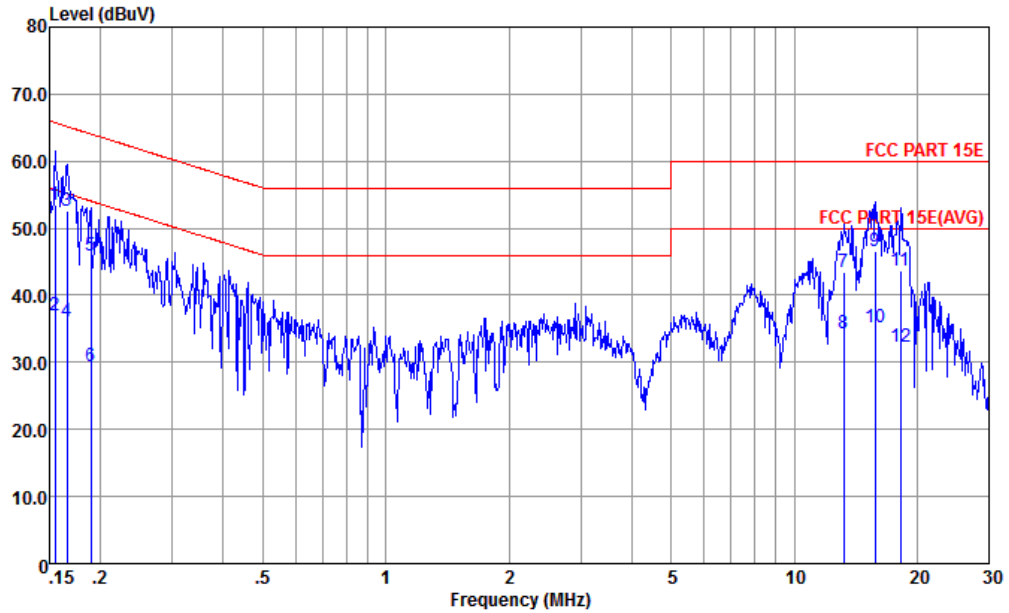

Site : CO01-KS  
 Condition : FCC PART 15E LISN-N-181013-060103 NEUTRAL

	Freq	Level	Over Limit	Limit Line	Read Level	LISN Factor	Cable Loss	Remark
	MHz	dBuV	dB	dBuV	dBuV	dB	dB	
1 *	0.155	53.57	-12.17	65.74	42.89	0.21	10.47	QP
2	0.155	36.97	-18.77	55.74	26.29	0.21	10.47	Average
3	0.166	52.55	-12.61	65.16	41.90	0.21	10.44	QP
4	0.166	36.15	-19.01	55.16	25.50	0.21	10.44	Average
5	0.189	45.89	-18.17	64.06	35.31	0.20	10.38	QP
6	0.189	29.49	-24.57	54.06	18.91	0.20	10.38	Average
7	13.197	43.53	-16.47	60.00	32.90	0.25	10.38	QP
8	13.197	34.23	-15.77	50.00	23.60	0.25	10.38	Average
9	15.801	46.60	-13.40	60.00	35.90	0.29	10.41	QP
10	15.801	35.30	-14.70	50.00	24.60	0.29	10.41	Average
11	18.232	43.68	-16.32	60.00	32.91	0.31	10.46	QP
12	18.232	32.38	-17.62	50.00	21.61	0.31	10.46	Average



### Appendix C. Radiated Spurious Emission

#### Band 1 - 5150~5250MHz

#### 5150.WIFI 802.11a (Band Edge @ 3m)

WIFI	Note	Frequency	Level	Over	Limit	Read	Antenna	Cable	Preamp	Ant	Table	Peak	Pol.
Ant.				Limit	Line	Level	Factor	Loss	Factor	Pos	Pos	Avg.	
1		( MHz )	( dBμV/m )	( dB )	( dBμV/m )	(dBμV)	( dB/m )	( dB )	( dB )	( cm )	( deg )	(P/A)	(H/V)
802.11a CH 36 5180MHz		5119.36	54.04	-19.96	74	44.28	34.23	8.14	32.61	133	296	P	H
		5138.4	43.65	-10.35	54	33.85	34.27	8.14	32.61	133	296	A	H
	*	5176	100.34	-	-	90.41	34.37	8.17	32.61	133	296	P	H
		5176	93.24	-	-	83.31	34.37	8.17	32.61	133	296	A	H
		5123.04	54.23	-19.77	74	44.43	34.27	8.14	32.61	105	37	P	V
		5147.2	44.22	-9.78	54	34.39	34.3	8.14	32.61	105	37	A	V
	*	5184	102.59	-	-	92.66	34.37	8.17	32.61	105	37	P	V
		5184	95.2	-	-	85.27	34.37	8.17	32.61	105	37	A	V
Remark	1. No other spurious found. 2. All results are PASS against Peak and Average limit line.												



**Band 1 5150~5250MHz**  
**WIFI 802.11a (Harmonic @ 3m)**

WIFI Ant.	Note	Frequency ( MHz )	Level ( dBμV/m )	Over Limit ( dB )	Limit Line ( dBμV/m )	Read Level ( dBμV )	Antenna Factor ( dB/m )	Cable Loss ( dB )	Preamp Factor ( dB )	Ant Pos ( cm )	Table Pos ( deg )	Peak Avg. ( P/A )	Pol. ( H/V )
802.11a CH 36		10360	43.04	-25.26	68.3	56.56	37.67	11.87	63.06	150	360	P	H
5180MHz		10360	42.92	-25.38	68.3	56.44	37.67	11.87	63.06	150	360	P	V
802.11a CH 44		10440	43.62	-24.68	68.3	57	37.73	11.93	63.04	150	360	P	H
5220MHz		10440	44.84	-23.46	68.3	58.22	37.73	11.93	63.04	150	360	P	V
802.11a CH 48		10480	42.76	-25.54	68.3	56.04	37.78	11.97	63.03	150	360	P	H
5240MHz		10480	43.19	-25.11	68.3	56.47	37.78	11.97	63.03	150	360	P	V
Remark	1. No other spurious found. 2. All results are PASS against Peak and Average limit line.												





**Band 1 5150~5250MHz  
WIFI 802.11n HT20 (Band Edge @ 3m)**

WIFI	Note	Frequency	Level	Over	Limit	Read	Antenna	Cable	Preamp	Ant	Table	Peak	Pol.
Ant.				Limit	Line	Level	Factor	Loss	Factor	Pos	Pos	Avg.	
1		( MHz )	( dBμV/m )	( dB )	( dBμV/m )	(dBμV)	( dB/m )	( dB )	( dB )	( cm )	( deg )	(P/A)	(H/V)
802.11n HT20 CH 36 5180MHz		5113.76	53.62	-20.38	74	43.9	34.23	8.1	32.61	344	315	P	H
		5139.68	43.02	-10.98	54	33.19	34.3	8.14	32.61	344	315	A	H
	*	5176	97.1	-	-	87.17	34.37	8.17	32.61	344	315	P	H
		5176	89.39	-	-	79.46	34.37	8.17	32.61	344	315	A	H
		5115.36	53.85	-20.15	74	44.09	34.23	8.14	32.61	100	42	P	V
		5148.96	43.26	-10.74	54	33.43	34.3	8.14	32.61	100	42	A	V
	*	5178	99.64	-	-	89.71	34.37	8.17	32.61	100	42	P	V
	5178	92.2	-	-	82.27	34.37	8.17	32.61	100	42	A	V	
<b>Remark</b>	1. No other spurious found. 2. All results are PASS against Peak and Average limit line.												



Band 1 5150~5250MHz
WIFI 802.11n HT20 (Harmonic @ 3m)

Table with 14 columns: WIFI Ant., Note, Frequency, Level, Over Limit, Limit Line, Read Level, Antenna Factor, Cable Loss, Preamp Factor, Ant Pos, Table Pos, Peak Avg, Pol. (P/A)(H/V). Rows include test results for channels 36, 44, and 48.



**Band 1 5150~5250MHz  
WIFI 802.11n HT40 (Band Edge @ 3m)**

WIFI	Note	Frequency	Level	Over	Limit	Read	Antenna	Cable	Preamp	Ant	Table	Peak	Pol.
Ant.				Limit	Line	Level	Factor	Loss	Factor	Pos	Pos	Avg.	
1		( MHz )	( dBμV/m )	( dB )	( dBμV/m )	(dBμV)	( dB/m )	( dB )	( dB )	( cm )	( deg )	(P/A)	(H/V)
<b>802.11n HT40 CH 38 5190MHz</b>		5139.2	53.64	-20.36	74	43.84	34.27	8.14	32.61	101	297	P	H
		5144.8	43.37	-10.63	54	33.54	34.3	8.14	32.61	101	297	A	H
	*	5184	91.89	-	-	81.96	34.37	8.17	32.61	101	297	P	H
		5184	84.43	-	-	74.5	34.37	8.17	32.61	101	297	A	H
		5395.68	50.82	-23.18	74	40.4	34.7	8.32	32.6	101	297	P	H
		5350.32	42.01	-11.99	54	31.61	34.7	8.3	32.6	101	297	A	H
		5147.68	56.7	-17.3	74	46.87	34.3	8.14	32.61	102	14	P	V
		5149.92	44.6	-9.4	54	34.77	34.3	8.14	32.61	102	14	A	V
	*	5206	95.35	-	-	85.36	34.4	8.2	32.61	102	14	P	V
		5206	88.19	-	-	78.2	34.4	8.2	32.61	102	14	A	V
		5350.14	50.92	-23.08	74	40.52	34.7	8.3	32.6	102	14	P	V
		5350.5	42.23	-11.77	54	31.83	34.7	8.3	32.6	102	14	A	V
<b>Remark</b>	1. No other spurious found. 2. All results are PASS against Peak and Average limit line.												



Band 1 5150~5250MHz
WIFI 802.11n HT40 (Harmonic @ 3m)

Table with 14 columns: WIFI Ant., Note, Frequency (MHz), Level (dBµV/m), Over Limit (dB), Limit Line (dBµV/m), Read Level (dBµV), Antenna Factor (dB/m), Cable Loss (dB), Preamp Factor (dB), Ant Pos (cm), Table Pos (deg), Peak Avg. (P/A), Pol. (H/V). Rows include data for 802.11n HT40 CH 38 (5190MHz) and CH 46 (5230MHz).



**Band 1 5150~5250MHz**  
**WIFI 802.11ac VHT80 (Band Edge @ 3m)**

WIFI	Note	Frequency	Level	Over	Limit	Read	Antenna	Cable	Preamp	Ant	Table	Peak	Pol.
Ant.				Limit	Line	Level	Factor	Loss	Factor	Pos	Pos	Avg.	
1		( MHz )	( dBμV/m )	( dB )	( dBμV/m )	(dBμV)	( dB/m )	( dB )	( dB )	( cm )	( deg )	(P/A)	(H/V)
802.11ac VHT80 CH 42 5210MHz		5149.28	61.97	-12.03	74	52.14	34.3	8.14	32.61	118	298	P	H
		5149.92	49.34	-4.66	54	39.51	34.3	8.14	32.61	118	298	A	H
	*	5210	88.95	-	-	78.93	34.43	8.2	32.61	118	298	P	H
		5210	79.62	-	-	69.6	34.43	8.2	32.61	118	298	A	H
		5398.92	51.84	-22.16	74	41.42	34.7	8.32	32.6	118	298	P	H
		5369.76	42.29	-11.71	54	31.89	34.7	8.3	32.6	118	298	A	H
		5149.6	64.78	-9.22	74	54.95	34.3	8.14	32.61	100	61	P	V
		5149.92	50.94	-3.06	54	41.11	34.3	8.14	32.61	100	61	A	V
	*	5250	90.15	-	-	80.02	34.5	8.23	32.6	100	61	P	V
		5250	81.66	-	-	71.53	34.5	8.23	32.6	100	61	A	V
		5369.76	51.22	-22.78	74	40.82	34.7	8.3	32.6	100	61	P	V
		5381.1	42.5	-11.5	54	32.1	34.7	8.3	32.6	100	61	A	V
Remark	1. No other spurious found. 2. All results are PASS against Peak and Average limit line.												



Band 1 5150~5250MHz
WIFI 802.11ac VHT80 (Harmonic @ 3m)

Table with 14 columns: WIFI Ant., Note, Frequency, Level, Over Limit, Limit Line, Read Level, Antenna Factor, Cable Loss, Preamp Factor, Ant Pos, Table Pos, Peak Avg., Pol. (H/V). Rows include 802.11ac VHT80 CH 42 5210MHz and Remark section.



Band 2 - 5250~5350MHz

WIFI 802.11a (Band Edge @ 3m)

WIFI Ant.	Note	Frequency ( MHz )	Level ( dBμV/m )	Over Limit ( dB )	Limit Line ( dBμV/m )	Read Level ( dBμV )	Antenna Factor ( dB/m )	Cable Loss ( dB )	Preamp Factor ( dB )	Ant Pos ( cm )	Table Pos ( deg )	Peak Avg. ( P/A )	Pol. ( H/V )
802.11a CH 64 5320MHz	*	5318	100.29	-	-	89.99	34.63	8.27	32.6	111	297	P	H
		5318	92.79	-	-	82.49	34.63	8.27	32.6	111	297	A	H
		5368.3	51.67	-22.33	74	41.27	34.7	8.3	32.6	111	297	P	H
		5350	42.75	-11.25	54	32.35	34.7	8.3	32.6	111	297	A	H
	*	5318	102.28	-	-	91.98	34.63	8.27	32.6	106	360	P	V
		5318	94.77	-	-	84.47	34.63	8.27	32.6	106	360	A	V
		5354.2	52.95	-21.05	74	42.55	34.7	8.3	32.6	106	360	P	V
		5351.2	42.87	-11.13	54	32.47	34.7	8.3	32.6	106	360	A	V
Remark	1. No other spurious found. 2. All results are PASS against Peak and Average limit line.												



Band 2 5250~5350MHz
WIFI 802.11a (Harmonic @ 3m)

Table with 14 columns: WIFI Ant., Note, Frequency, Level, Over Limit, Limit Line, Read Level, Antenna Factor, Cable Loss, Preamp Factor, Ant Pos, Table Pos, Peak Avg, Pol. (P/A)(H/V). Rows include data for channels 52, 60, and 64 at various frequencies (10520, 10600.01, 10640 MHz).

- 1. No other spurious found.
2. All results are PASS against Peak and Average limit line.





Band 2 5250~5350MHz
WIFI 802.11n HT20 (Band Edge @ 3m)

Table with 14 columns: WIFI, Note, Frequency, Level, Over, Limit, Read, Antenna, Cable, Preamp, Ant, Table, Peak, Pol. It contains test data for 802.11n HT20 CH 64 across various frequencies (5318, 5366.5, 5368.8, 5324, 5324, 5360.4, 5350.2 MHz) and includes a Remark section at the bottom.



**Band 2 5250~5350MHz**  
**WIFI 802.11n HT20 (Harmonic @ 3m)**

WIFI Ant.	Note	Frequency ( MHz )	Level ( dBμV/m )	Over Limit ( dB )	Limit Line ( dBμV/m )	Read Level ( dBμV )	Antenna Factor ( dB/m )	Cable Loss ( dB )	Preamp Factor ( dB )	Ant Pos ( cm )	Table Pos ( deg )	Peak Avg. (P/A)	Pol. (H/V)
802.11n HT20		10520	42.97	-25.33	68.3	56.18	37.82	12	63.03	150	360	P	H
CH 52		10520	43.56	-24.74	68.3	56.77	37.82	12	63.03	150	360	P	V
5260MHz													
802.11n HT20		10600.01	43.61	-30.39	74	56.66	37.9	12.06	63.01	150	360	P	H
CH 60		10600	44.56	-29.44	74	57.61	37.9	12.06	63.01	150	360	P	V
5300MHz													
802.11n HT20		10640	43.23	-30.77	74	56.24	37.9	12.09	63	150	360	P	H
CH 64		10640	43.91	-30.09	74	56.92	37.9	12.09	63	150	360	P	V
5320MHz													
Remark	1. No other spurious found. 2. All results are PASS against Peak and Average limit line.												



**Band 2 5250~5350MHz  
WIFI 802.11n HT40 (Band Edge @ 3m)**

WIFI	Note	Frequency	Level	Over	Limit	Read	Antenna	Cable	Preamp	Ant	Table	Peak	Pol.
Ant.				Limit	Line	Level	Factor	Loss	Factor	Pos	Pos	Avg.	
1		( MHz )	( dBμV/m )	( dB )	( dBμV/m )	(dBμV)	( dB/m )	( dB )	( dB )	( cm )	( deg )	(P/A)	(H/V)
802.11n HT40 CH 62 5310MHz		5122.08	52.54	-21.46	74	42.78	34.23	8.14	32.61	108	296	P	H
		5113.28	43.08	-10.92	54	33.36	34.23	8.1	32.61	108	296	A	H
	*	5304	91.79	-	-	81.54	34.6	8.25	32.6	108	296	P	H
		5304	84.37	-	-	74.12	34.6	8.25	32.6	108	296	A	H
		5388.4	51.09	-22.91	74	40.67	34.7	8.32	32.6	108	296	P	H
		5385.1	42.27	-11.73	54	31.87	34.7	8.3	32.6	108	296	A	H
		5110.72	52.38	-21.62	74	42.66	34.23	8.1	32.61	100	13	P	V
		5149.99	43.14	-10.86	54	33.31	34.3	8.14	32.61	100	13	A	V
	*	5294	95.23	-	-	84.98	34.6	8.25	32.6	100	13	P	V
		5294	87.78	-	-	77.53	34.6	8.25	32.6	100	13	A	V
		5370.6	52.37	-21.63	74	41.97	34.7	8.3	32.6	100	13	P	V
	5372.8	42.88	-11.12	54	32.48	34.7	8.3	32.6	100	13	A	V	
Remark	1. No other spurious found. 2. All results are PASS against Peak and Average limit line.												



**Band 2 5250~5350MHz  
WIFI 802.11n HT40 (Harmonic @ 3m)**

WIFI Ant.	Note	Frequency ( MHz )	Level ( dBμV/m )	Over Limit ( dB )	Limit Line ( dBμV/m )	Read Level ( dBμV )	Antenna Factor ( dB/m )	Cable Loss ( dB )	Preamp Factor ( dB )	Ant Pos ( cm )	Table Pos ( deg )	Peak Avg. (P/A)	Pol. (H/V)
802.11n HT40		10540	44.09	-24.21	68.3	57.25	37.83	12.03	63.02	150	360	P	H
CH 54 5270MHz		10540	42.91	-25.39	68.3	56.07	37.83	12.03	63.02	150	360	P	V
802.11n HT40		10620	42.42	-31.58	74	55.44	37.9	12.09	63.01	150	360	P	H
CH 62 5310MHz		10620	43.46	-30.54	74	56.48	37.9	12.09	63.01	150	360	P	V
Remark	1. No other spurious found. 2. All results are PASS against Peak and Average limit line.												



**Band 2 5250~5350MHz**  
**WIFI 802.11ac VHT80 (Band Edge @ 3m)**

WIFI	Note	Frequency	Level	Over	Limit	Read	Antenna	Cable	Preamp	Ant	Table	Peak	Pol.
Ant.				Limit	Line	Level	Factor	Loss	Factor	Pos	Pos	Avg.	
1		( MHz )	( dBμV/m )	( dB )	( dBμV/m )	(dBμV)	( dB/m )	( dB )	( dB )	( cm )	( deg )	(P/A)	(H/V)
802.11ac VHT80 CH 58 5290MHz		5121.12	53.2	-20.8	74	43.44	34.23	8.14	32.61	100	84	P	H
		5115.68	43.46	-10.54	54	33.7	34.23	8.14	32.61	100	84	A	H
	*	5290	89.49	-	-	79.27	34.57	8.25	32.6	100	84	P	H
		5290	77.18	-	-	66.96	34.57	8.25	32.6	100	84	A	H
		5350.5	59.63	-14.37	74	49.23	34.7	8.3	32.6	100	84	P	H
		5350.7	48.04	-5.96	54	37.64	34.7	8.3	32.6	100	84	A	H
		5104.16	53.08	-20.92	74	43.39	34.2	8.1	32.61	100	16	P	V
		5120	43.63	-10.37	54	33.87	34.23	8.14	32.61	100	16	A	V
	*	5290	90.91	-	-	80.69	34.57	8.25	32.6	100	16	P	V
		5290	81.51	-	-	71.29	34.57	8.25	32.6	100	16	A	V
		5350.8	62.83	-11.17	74	52.43	34.7	8.3	32.6	100	16	P	V
	5350.5	50.64	-3.36	54	40.24	34.7	8.3	32.6	100	16	A	V	
Remark	1. No other spurious found. 2. All results are PASS against Peak and Average limit line.												



Band 2 5250~5350MHz
WIFI 802.11ac VHT80 (Harmonic @ 3m)

Table with 14 columns: WIFI Ant., Note, Frequency, Level, Over Limit, Limit Line, Read Level, Antenna Factor, Cable Loss, Preamp Factor, Ant Pos, Table Pos, Peak Avg., Pol. (P/A)(H/V). Rows include 802.11ac VHT80 CH 58 5290MHz and a Remark section.



Band 3 - 5470~5725MHz

WIFI 802.11a (Band Edge @ 3m)

WIFI	Note	Frequency	Level	Over	Limit	Read	Antenna	Cable	Preamp	Ant	Table	Peak	Pol.
Ant.				Limit	Line	Level	Factor	Loss	Factor	Pos	Pos	Avg.	
1		( MHz )	( dBμV/m )	( dB )	( dBμV/m )	( dBμV )	( dB/m )	( dB )	( dB )	( cm )	( deg )	(P/A)	(H/V)
802.11a CH 100 5500MHz		5445.68	51.77	-22.23	74	41.3	34.7	8.36	32.59	102	83	P	H
		5464.4	51.29	-17.01	68.3	40.82	34.7	8.36	32.59	102	83	P	H
		5458.96	42.41	-11.59	54	31.94	34.7	8.36	32.59	102	83	A	H
	*	5498	92.76	-	-	82.25	34.7	8.4	32.59	102	83	P	H
		5498	85.52	-	-	75.01	34.7	8.4	32.59	102	83	A	H
		5391.28	52.97	-21.03	74	42.55	34.7	8.32	32.6	100	357	P	V
		5466.64	51.53	-16.77	68.3	41.02	34.7	8.4	32.59	100	357	P	V
		5384.88	42.88	-11.12	54	32.48	34.7	8.3	32.6	100	357	A	V
	*	5502	98.01	-	-	87.5	34.7	8.4	32.59	100	357	P	V
	5502	90.87	-	-	80.36	34.7	8.4	32.59	100	357	A	V	
802.11a CH 140 5700MHz	*	5702	88.62	-	-	77.82	34.73	8.61	32.54	100	79	P	H
		5702	81.5	-	-	70.7	34.73	8.61	32.54	100	79	A	H
		5737.24	53.43	-14.87	68.3	42.51	34.8	8.61	32.49	100	79	P	H
	*	5702	93.61	-	-	82.81	34.73	8.61	32.54	100	8	P	V
		5702	85.84	-	-	75.04	34.73	8.61	32.54	100	8	A	V
	5742.2	54.34	-13.96	68.3	43.39	34.8	8.64	32.49	100	8	P	V	
Remark	1. No other spurious found. 2. All results are PASS against Peak and Average limit line.												



**Band 3 - 5470~5725MHz**  
**WIFI 802.11a (Harmonic @ 3m)**

WIFI Ant.	Note	Frequency ( MHz )	Level ( dBμV/m )	Over Limit ( dB )	Limit Line ( dBμV/m )	Read Level ( dBμV )	Antenna Factor ( dB/m )	Cable Loss ( dB )	Preamp Factor ( dB )	Ant Pos ( cm )	Table Pos ( deg )	Peak Avg. (P/A)	Pol. (H/V)
802.11a CH 100		11000	43.97	-30.03	74	56.63	37.9	12.37	62.93	150	360	P	H
5500MHz		11000	43.17	-30.83	74	55.83	37.9	12.37	62.93	150	360	P	V
802.11a CH 116		11160	43.58	-30.42	74	56.07	37.9	12.51	62.9	150	360	P	H
5580MHz		11160	43.53	-30.47	74	56.02	37.9	12.51	62.9	150	360	P	V
802.11a CH 140		11400	42.03	-31.97	74	54.2	38	12.68	62.85	150	360	P	H
5700MHz		11400	41.97	-32.03	74	54.14	38	12.68	62.85	150	360	P	V
Remark	1. No other spurious found. 2. All results are PASS against Peak and Average limit line.												





**Band 3 - 5470~5725MHz  
WIFI 802.11n HT20 (Band Edge @ 3m)**

WIFI	Note	Frequency	Level	Over	Limit	Read	Antenna	Cable	Preamp	Ant	Table	Peak	Pol.
Ant.				Limit	Line	Level	Factor	Loss	Factor	Pos	Pos	Avg.	
1		( MHz )	( dBμV/m )	( dB )	( dBμV/m )	(dBμV)	( dB/m )	( dB )	( dB )	( cm )	( deg )	(P/A)	(H/V)
802.11n HT20 CH 100 5500MHz		5390.64	51.02	-22.98	74	40.6	34.7	8.32	32.6	317	316	P	H
		5462.96	51.9	-16.4	68.3	41.43	34.7	8.36	32.59	317	316	P	H
		5384.72	41.88	-12.12	54	31.48	34.7	8.3	32.6	317	316	A	H
	*	5498	92.86	-	-	82.35	34.7	8.4	32.59	317	316	P	H
		5498	85.27	-	-	74.76	34.7	8.4	32.59	317	316	A	H
		5370.16	52.52	-21.48	74	42.12	34.7	8.3	32.6	100	14	P	V
		5469.36	52.05	-16.25	68.3	41.54	34.7	8.4	32.59	100	14	P	V
		5419.76	42.4	-11.6	54	31.98	34.7	8.32	32.6	100	14	A	V
	*	5496	97.02	-	-	86.51	34.7	8.4	32.59	100	14	P	V
	5496	89.51	-	-	79	34.7	8.4	32.59	100	14	A	V	
802.11n HT20 CH 140 5700MHz		5764.36	53.94	-14.36	68.3	42.94	34.83	8.64	32.47	100	77	P	H
	*	5704	88.71	-	-	77.91	34.73	8.61	32.54	100	77	P	H
		5704	84.82	-	-	74.02	34.73	8.61	32.54	100	77	A	H
		5730.04	54.56	-13.74	68.3	43.69	34.77	8.61	32.51	103	11	P	V
	*	5704	94.17	-	-	83.37	34.73	8.61	32.54	103	11	P	V
	5704	86.99	-	-	76.19	34.73	8.61	32.54	103	11	A	V	
Remark	1. No other spurious found. 2. All results are PASS against Peak and Average limit line.												



**Band 3 - 5470~5725MHz**  
**WIFI 802.11n HT20 (Harmonic @ 3m)**

WIFI Ant.	Note	Frequency ( MHz )	Level ( dBμV/m )	Over Limit ( dB )	Limit Line ( dBμV/m )	Read Level ( dBμV )	Antenna Factor ( dB/m )	Cable Loss ( dB )	Preamp Factor ( dB )	Ant Pos ( cm )	Table Pos ( deg )	Peak Avg. (P/A)	Pol. (H/V)
802.11n HT20		11000	42.91	-31.09	74	55.57	37.9	12.37	62.93	150	360	P	H
CH 100 5500MHz		11000	43.42	-30.58	74	56.08	37.9	12.37	62.93	150	360	P	V
802.11n HT20		11160	44.23	-29.77	74	56.72	37.9	12.51	62.9	150	360	P	H
CH 116 5580MHz		11160	44.54	-29.46	74	57.03	37.9	12.51	62.9	150	360	P	V
802.11n HT20		11400	42.41	-31.59	74	54.58	38	12.68	62.85	150	360	P	H
CH 140 5700MHz		11400	43.65	-30.35	74	55.82	38	12.68	62.85	150	360	P	V
Remark	1. No other spurious found. 2. All results are PASS against Peak and Average limit line.												



**Band 3 - 5470~5725MHz**  
**WIFI 802.11n HT40 (Band Edge @ 3m)**

WIFI	Note	Frequency	Level	Over	Limit	Read	Antenna	Cable	Preamp	Ant	Table	Peak	Pol.
Ant.				Limit	Line	Level	Factor	Loss	Factor	Pos	Pos	Avg.	
1		( MHz )	( dBμV/m )	( dB )	( dBμV/m )	( dBμV )	( dB/m )	( dB )	( dB )	( cm )	( deg )	(P/A)	(H/V)
802.11n HT40 CH 102 5510MHz		5447.12	51.41	-22.59	74	40.94	34.7	8.36	32.59	100	298	P	H
		5461.36	52.79	-15.51	68.3	42.32	34.7	8.36	32.59	100	298	P	H
		5459.6	42.97	-11.03	54	32.5	34.7	8.36	32.59	100	298	A	H
	*	5494	86.3	-	-	75.79	34.7	8.4	32.59	100	298	P	H
		5494	77.62	-	-	67.11	34.7	8.4	32.59	100	298	A	H
		5731.16	52.97	-15.33	68.3	42.08	34.77	8.61	32.49	100	298	P	H
		5459.76	56.31	-17.69	74	45.84	34.7	8.36	32.59	103	14	P	V
		5460.4	56.01	-12.29	68.3	45.54	34.7	8.36	32.59	103	14	P	V
		5459.76	43.82	-10.18	54	33.35	34.7	8.36	32.59	103	14	A	V
	*	5494	90.61	-	-	80.1	34.7	8.4	32.59	103	14	P	V
		5494	83.4	-	-	72.89	34.7	8.4	32.59	103	14	A	V
		5755.48	53.21	-15.09	68.3	42.23	34.83	8.64	32.49	103	14	P	V
802.11n HT40 CH 134 5670MHz		5396.24	51.63	-22.37	74	41.21	34.7	8.32	32.6	102	77	P	H
		5466.32	49.94	-18.36	68.3	39.43	34.7	8.4	32.59	102	77	P	H
		5448.88	42.16	-11.84	54	31.69	34.7	8.36	32.59	102	77	A	H
	*	5654	84.14	-	-	73.45	34.7	8.55	32.56	102	77	P	H
		5654	76.75	-	-	66.06	34.7	8.55	32.56	102	77	A	H
		5748.36	53.23	-15.07	68.3	42.28	34.8	8.64	32.49	102	77	P	H
		5395.28	51.53	-22.47	74	41.11	34.7	8.32	32.6	100	16	P	V
		5463.76	50.74	-17.56	68.3	40.27	34.7	8.36	32.59	100	16	P	V
		5438.64	42.13	-11.87	54	31.66	34.7	8.36	32.59	100	16	A	V
	*	5656	89.26	-	-	78.57	34.7	8.55	32.56	100	16	P	V
		5656	81.89	-	-	71.2	34.7	8.55	32.56	100	16	A	V
		5749.88	53.28	-15.02	68.3	42.33	34.8	8.64	32.49	100	16	P	V
Remark	1. No other spurious found. 2. All results are PASS against Peak and Average limit line.												



Band 3 - 5470~5725MHz
WIFI 802.11n HT40 (Harmonic @ 3m)

Table with 14 columns: WIFI Ant., Note, Frequency (MHz), Level (dBµV/m), Over Limit (dB), Limit Line (dBµV/m), Read Level (dBµV), Antenna Factor (dB/m), Cable Loss (dB), Preamp Factor (dB), Ant Pos (cm), Table Pos (deg), Peak Avg. (P/A), Pol. (H/V). Rows include data for channels 102, 110, and 134.



**Band 3 - 5470~5725MHz**  
**WIFI 802.11ac VHT80 (Band Edge @ 3m)**

WIFI	Note	Frequency	Level	Over	Limit	Read	Antenna	Cable	Preamp	Ant	Table	Peak	Pol.
Ant.				Limit	Line	Level	Factor	Loss	Factor	Pos	Pos	Avg.	
1		( MHz )	( dBμV/m )	( dB )	( dBμV/m )	( dBμV )	( dB/m )	( dB )	( dB )	( cm )	( deg )	(P/A)	(H/V)
802.11ac VHT80 CH 106 5530MHz		5458.96	53.46	-20.54	74	42.99	34.7	8.36	32.59	108	80	P	H
		5469.68	61.25	-7.05	68.3	50.74	34.7	8.4	32.59	108	80	P	H
		5445.36	43.46	-10.54	54	32.99	34.7	8.36	32.59	108	80	A	H
	*	5530	81.12	-	-	70.57	34.7	8.44	32.59	108	80	P	H
		5530	73.72	-	-	63.17	34.7	8.44	32.59	108	80	A	H
		5730.52	54.11	-14.19	68.3	43.22	34.77	8.61	32.49	108	80	P	H
		5452.4	53.91	-20.09	74	43.44	34.7	8.36	32.59	104	12	P	V
		5466.96	63.45	-4.85	68.3	52.94	34.7	8.4	32.59	104	12	P	V
		5458	44.64	-9.36	54	34.17	34.7	8.36	32.59	104	12	A	V
	*	5530	88.53	-	-	77.98	34.7	8.44	32.59	104	12	P	V
		5530	79.15	-	-	68.6	34.7	8.44	32.59	104	12	A	V
	5726.36	52.79	-15.51	68.3	41.92	34.77	8.61	32.51	104	12	P	V	
802.11ac VHT80 CH 122 5610MHz		5373.36	51.54	-22.46	74	41.33	34.7	8.3	32.79	101	304	P	H
		5469.36	50.8	-17.5	68.3	40.44	34.7	8.4	32.74	101	304	P	H
	*	5447.76	43.01	-10.99	54	32.71	34.7	8.36	32.76	101	304	A	H
		5572	80.26	-	-	69.78	34.67	8.48	32.67	101	304	P	H
		5572	72.5	-	-	62.02	34.67	8.48	32.67	101	304	A	H
		5751.88	54.13	-14.17	68.3	43.52	34.83	8.64	32.86	101	304	P	H
		5424.56	51.66	-22.34	74	41.23	34.7	8.32	32.59	101	12	P	V
		5464.24	50.47	-17.83	68.3	40	34.7	8.36	32.59	101	12	P	V
		5388.72	42.82	-11.18	54	32.4	34.7	8.32	32.6	101	12	A	V
	*	5592	87.72	-	-	77.15	34.63	8.52	32.58	101	12	P	V
		5592	80.58	-	-	70.01	34.63	8.52	32.58	101	12	A	V
	5761.56	53.6	-14.7	68.3	42.6	34.83	8.64	32.47	101	12	P	V	
Remark	1. No other spurious found. 2. All results are PASS against Peak and Average limit line.												



Band 3 5470~5725MHz
WIFI 802.11ac VHT80 (Harmonic @ 3m)

Table with 14 columns: WIFI Ant., Note, Frequency (MHz), Level (dBµV/m), Over Limit (dB), Limit Line (dBµV/m), Read Level (dBµV), Antenna Factor (dB/m), Cable Loss (dB), Preamp Factor (dB), Ant Pos (cm), Table Pos (deg), Peak Avg. (P/A), Pol. (H/V). Rows include 802.11ac VHT80 CH 106 5530MHz and CH 122 5610MHz.



Band 3 - Straddle Channel
WIFI 802.11a (Band Edge @ 3m)

Table with 14 columns: WIFI Ant., Note, Frequency, Level, Over Limit, Limit Line, Read Level, Antenna Factor, Cable Loss, Preamp Factor, Ant Pos, Table Pos, Peak Avg., Pol. (P/A)(H/V). Rows include test data for 802.11a CH 144 5720MHz and a Remark section.



Band 3 - Straddle Channel
WIFI 802.11a (Harmonic @ 3m)

Table with 14 columns: WIFI Ant., Note, Frequency, Level, Over Limit, Limit Line, Read Level, Antenna Factor, Cable Loss, Preamp Factor, Ant Pos, Table Pos, Peak Avg., Pol. (P/A)(H/V). Rows include data for 802.11a CH 144 at 11440 MHz and a Remark section.





Band 3 - Straddle Channel
WIFI 802.11n HT20 (Band Edge @ 3m)

Table with 14 columns: WIFI, Note, Frequency, Level, Over, Limit, Read, Antenna, Cable, Preamp, Ant, Table, Peak, Pol. It contains test results for 802.11n HT20 CH 144 at 5720MHz.



Band 3 - Straddle Channel
WIFI 802.11n HT20 (Harmonic @ 3m)

Table with 14 columns: WIFI Ant., Note, Frequency, Level, Over Limit, Limit Line, Read Level, Antenna Factor, Cable Loss, Preamp Factor, Ant Pos, Table Pos, Peak Avg., Pol. (H/V). Rows include test data for 802.11n HT20 CH 144 and a Remark section.



Band 3 - Straddle Channel
WIFI 802.11n HT40 (Band Edge @ 3m)

Table with 14 columns: WIFI, Note, Frequency, Level, Over, Limit, Read, Antenna, Cable, Preamp, Ant, Table, Peak, Pol. It contains test results for 802.11n HT40 and CH 142 at 5714 MHz and 5692 MHz.



Band 3 - Straddle Channel
WIFI 802.11n HT40 (Harmonic @ 3m)

Table with 14 columns: WIFI Ant., Note, Frequency, Level, Over Limit, Limit Line, Read Level, Antenna Factor, Cable Loss, Preamp Factor, Ant Pos, Table Pos, Peak Avg., Pol. (H/V). Rows include test results for 802.11n HT40 CH 142 at 5710MHz and a Remark section.



Band 3 - Straddle Channel
WIFI 802.11ac VHT80 (Band Edge @ 3m)

Table with 14 columns: WIFI, Note, Frequency, Level, Over, Limit, Read, Antenna, Cable, Preamp, Ant, Table, Peak, Pol. It contains test data for 802.11ac VHT80 and CH 138 at 5690MHz, and a Remark section.



**Band 3 - Straddle Channel**  
**WIFI 802.11ac VHT80 (Harmonic @ 3m)**

WIFI Ant.	Note	Frequency ( MHz )	Level ( dB $\mu$ V/m )	Over Limit ( dB )	Limit Line ( dB $\mu$ V/m )	Read Level ( dB $\mu$ V )	Antenna Factor ( dB/m )	Cable Loss ( dB )	Preamp Factor ( dB )	Ant Pos ( cm )	Table Pos ( deg )	Peak Avg. (P/A)	Pol. (H/V)
802.11ac VHT80 CH 138 5690MHz		11380	42.53	-31.47	74	54.75	37.98	12.65	62.85	150	360	P	H
		11380	42.51	-31.49	74	54.73	37.98	12.65	62.85	150	360	P	V
Remark	1. No other spurious found. 2. All results are PASS against Peak and Average limit line.												



Emission below 1GHz

WIFI 802.11ac VHT80 (LF @ 3m)

WIFI	Note	Frequency	Level	Over	Limit	Read	Antenna	Cable	Preamp	Ant	Table	Peak	Pol.
Ant.				Limit	Line	Level	Factor	Loss	Factor	Pos	Pos	Avg.	
1		( MHz )	( dBμV/m )	( dB )	( dBμV/m )	(dBμV)	( dB/m )	( dB )	( dB )	( cm )	( deg )	(P/A)	(H/V)
802.11ac VHT80 LF		30	18.71	-21.29	40	25.58	24.5	0.61	31.98	100	0	P	H
		179.38	15.24	-28.26	43.5	30.57	15.23	1.36	31.92	-	-	P	H
		218.18	20.06	-25.94	46	35.31	15.12	1.55	31.92	-	-	P	H
		290.93	16.6	-29.4	46	27.99	18.86	1.81	32.06	-	-	P	H
		417.03	20.03	-25.97	46	28.24	21.88	2.06	32.15	-	-	P	H
		970.9	24.63	-29.37	54	25.09	27.18	3.15	30.79	-	-	P	H
		39.7	30.03	-9.97	40	42.53	18.8	0.66	31.96	100	0	P	V
		74.62	17.39	-22.61	40	35.61	12.78	0.9	31.9	-	-	P	V
		188.11	13.65	-29.85	43.5	28.92	15.24	1.4	31.91	-	-	P	V
		367.56	16.22	-29.78	46	25.6	20.77	1.94	32.09	-	-	P	V
		569.32	20.16	-25.84	46	26.05	23.96	2.52	32.37	-	-	P	V
		967.02	24.71	-29.29	54	25.26	27.14	3.14	30.83	-	-	P	V
Remark	1. No other spurious found. 2. All results are PASS against limit line.												



**Note symbol**

*	<b>Fundamental Frequency</b> which can be ignored. However, the level of any unwanted emissions shall not exceed the level of the fundamental frequency.
!	Test result is <b>over limit</b> line.
P/A	<b>Peak</b> or <b>Average</b>
H/V	<b>Horizontal</b> or <b>Vertical</b>





A calculation example for radiated spurious emission is shown as below:

WIFI	Note	Frequency	Level	Over	Limit	Read	Antenna	Cable	Preamp	Ant	Table	Peak	Pol.
Ant.				Limit	Line	Level	Factor	Loss	Factor	Pos	Pos	Avg.	
1		( MHz )	( dBμV/m )	( dB )	( dBμV/m )	( dBμV )	( dB/m )	( dB )	( dB )	( cm )	( deg )	( P/A )	( H/V )
802.11b		2390	55.45	-18.55	74	54.51	32.22	4.58	35.86	103	308	P	H
CH 01													
2412MHz		2390	43.54	-10.46	54	42.6	32.22	4.58	35.86	103	308	A	H

- Level(dBμV/m) =  
Antenna Factor(dB/m) + Cable Loss(dB) + Read Level(dBμV) - Preamp Factor(dB)
- Over Limit(dB) = Level(dBμV/m) – Limit Line(dBμV/m)

**For Peak Limit @ 2390MHz:**

- Level(dBμV/m)  
= Antenna Factor(dB/m) + Cable Loss(dB) + Read Level(dBμV) - Preamp Factor(dB)  
= 32.22(dB/m) + 4.58(dB) + 54.51(dBμV) – 35.86 (dB)  
= 55.45 (dBμV/m)
- Over Limit(dB)  
= Level(dBμV/m) – Limit Line(dBμV/m)  
= 55.45(dBμV/m) – 74(dBμV/m)  
= -18.55(dB)

**For Average Limit @ 2390MHz:**

- Level(dBμV/m)  
= Antenna Factor(dB/m) + Cable Loss(dB) + Read Level(dBμV) - Preamp Factor(dB)  
= 32.22(dB/m) + 4.58(dB) + 42.6(dBμV) – 35.86 (dB)  
= 43.54 (dBμV/m)
- Over Limit(dB)  
= Level(dBμV/m) – Limit Line(dBμV/m)  
= 43.54(dBμV/m) – 54(dBμV/m)  
= -10.46(dB)

Both peak and average measured complies with the limit line, so test result is “PASS”.



## Appendix D. Duty Cycle Plots

Band	Duty Cycle(%)	T(ms)	1/T(kHz)	VBW Setting
802.11a	95.17	1.428	0.701	0.75Khz
5GHz 802.11n HT20	94.87	1.341	0.746	0.75Khz
5GHz 802.11n HT40	88.10	0.665	1.503	1.6Khz
5GHz 802.11ac V HT80	76.35	0.328	3.053	3.3Khz



802.11a

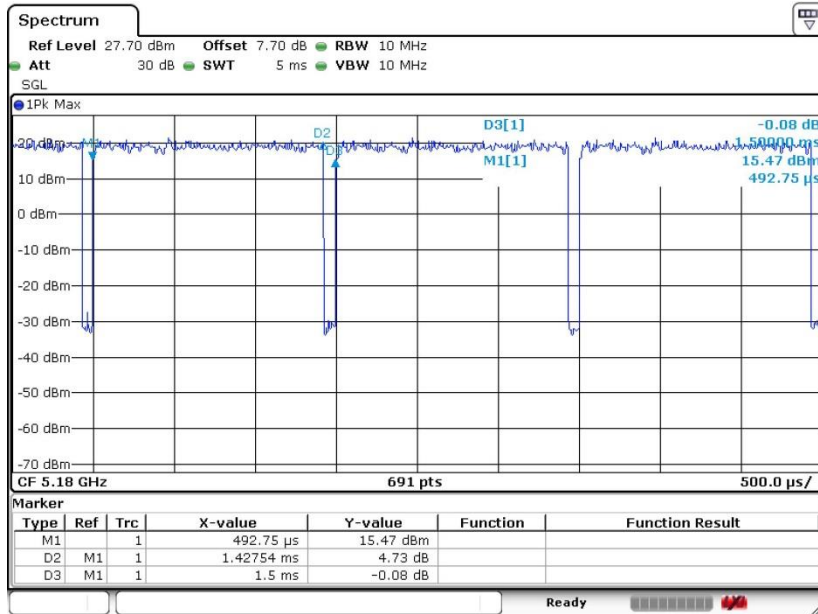

802.11n HT20

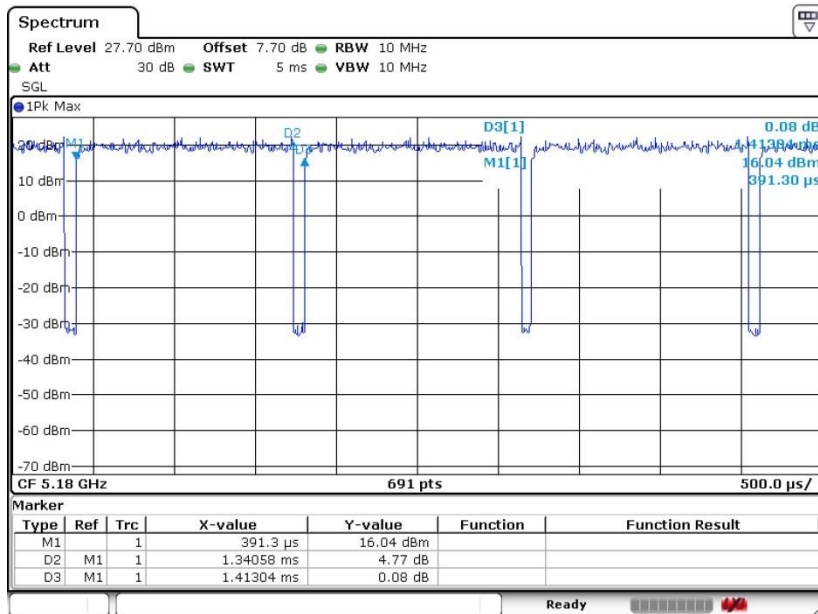



802.11n HT40

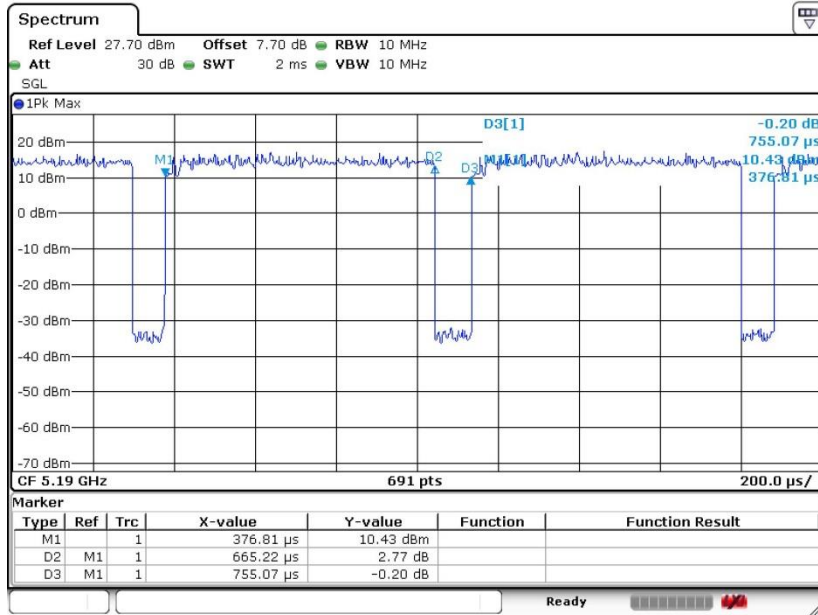

802.11ac VHT80

