



FCC RF Test Report

APPLICANT : Motorola Mobility LLC
EQUIPMENT : Mobile Cellular Phone
BRAND NAME : Motorola
MODEL NAME : XT1955-2
FCC ID : IHDT56XQ3
STANDARD : 47 CFR Part 2, 22(H), 24(E), 27(L) , 27(M)
CLASSIFICATION : PCS Licensed Transmitter Held to Ear (PCE)

The product was received on Sep. 06, 2018 and completely tested on Oct. 08, 2018. We, Sporton International (Kunshan) Inc., would like to declare that the tested sample has been evaluated in accordance with the procedures given in ANSI C63.26-2015 and shown compliance with the applicable technical standards.

The test results in this report apply exclusively to the tested model / sample. Without written approval of Sporton International (Kunshan) Inc., the test report shall not be reproduced except in full.



Approved by: James Huang / Manager

Sporton International (Kunshan) Inc.
No. 1098, Pengxi North Road, Kunshan Economic Development Zone,
Jiangsu Province 215335, China



TABLE OF CONTENTS

REVISION HISTORY..... 3
SUMMARY OF TEST RESULT 4
1 GENERAL DESCRIPTION 5
1.1 Applicant 5
1.2 Manufacturer 5
1.3 Product Feature of Equipment Under Test..... 5
1.4 Product Specification of Equipment Under Test..... 6
1.5 Specification of Accessory 7
1.6 Modification of EUT 7
1.7 Maximum ERP/EIRP Power, Frequency Tolerance, and Emission Designator 8
1.8 Testing Location 11
1.9 Applicable Standards..... 11
2 TEST CONFIGURATION OF EQUIPMENT UNDER TEST 12
2.1 Test Mode 12
2.2 Connection Diagram of Test System 14
2.3 Support Unit used in test configuration and system 14
2.4 Measurement Results Explanation Example 14
2.5 Frequency List of Low/Middle/High Channels 15
3 CONDUCTED TEST ITEMS 18
3.1 Measuring Instruments 18
3.2 Test Setup 18
3.3 Test Result of Conducted Test 18
3.4 Conducted Output Power and ERP/EIRP 19
3.5 Peak-to-Average Ratio 20
3.6 Occupied Bandwidth 21
3.7 Conducted Band Edge 22
3.8 Conducted Spurious Emission 24
3.9 Frequency Stability 25
4 RADIATED TEST ITEMS 26
4.1 Measuring Instruments 26
4.2 Test Setup 26
4.3 Test Result of Radiated Test 26
4.4 Radiated Spurious Emission 27
5 LIST OF MEASURING EQUIPMENT 28
6 UNCERTAINTY OF EVALUATION 29
APPENDIX A. TEST RESULTS OF CONDUCTED TEST
APPENDIX B. TEST RESULTS OF RADIATED TEST
APPENDIX C. TEST SETUP PHOTOGRAPHS



REVISION HISTORY

REPORT NO.	VERSION	DESCRIPTION	ISSUED DATE
FG890604-02B	Rev. 01	Initial issue of report	Oct. 29, 2018



SUMMARY OF TEST RESULT

Report Section	FCC Rule	Description	Limit	Result	Remark
3.4	§2.1046	Conducted Output Power	Reporting Only	PASS	-
	§22.913(a)(5)	Effective Radiated Power (Band 5)	ERP < 7 Watt	PASS	
	§24.232(c) §27.50(h)(2)	Equivalent Isotropic Radiated Power (Band 2) (Band 7)	EIRP < 2Watt	PASS	
	§27.50(d)(4)	Equivalent Isotropic Radiated Power (Band 4) (Band 66)	EIRP < 1Watt	PASS	
3.5	§24.232(d)	Peak-to-Average Ratio	<13 dB	PASS	-
3.6	§2.1049	Occupied Bandwidth	Reporting Only	PASS	-
3.7	§2.1051 §22.917(a) §24.238(a) §27.53(h)	Conducted Band Edge Measurement (Band 2) (Band 4) (Band 5) (Band 66)	< 43+10log ₁₀ (P[Watts])	PASS	-
	§27.53(m)(4)	Conducted Band Edge Measurement (Band 7)	§27.53(m)(4)		
3.8	§2.1051 §22.917(a) §24.238(a) §27.53(h)	Conducted Spurious Emission (Band 2) (Band 4) (Band 5) (Band 66)	< 43+10log ₁₀ (P[Watts])	PASS	-
	§2.1051 §27.53(m)(4)	Conducted Spurious Emission (Band 7)	< 55+10log ₁₀ (P[Watts])		
3.9	§2.1055 §22.355	Frequency Stability Temperature & Voltage	< 2.5 ppm for Part 22H	PASS	-
	§2.1055 §24.235 §27.54		Within Authorized Band		
4.4	§2.1053 §22.917(a) §24.238(a) §27.53(h)	Radiated Spurious Emission (Band 2) (Band 4) (Band 5) (Band 66)	< 43+10log ₁₀ (P[Watts])	PASS	Under limit 20.79 dB at 10104.000 MHz
	§2.1053 §27.53(m)(4)	Radiated Spurious Emission (Band 7)	< 55+10log ₁₀ (P[Watts])		



1 General Description

1.1 Applicant

Motorola Mobility LLC
222 W,Merchandise Mart Plaza, Chicago IL 60654 USA

1.2 Manufacturer

Motorola Mobility LLC
222 W,Merchandise Mart Plaza, Chicago IL 60654 USA

1.3 Product Feature of Equipment Under Test

Product Feature	
Equipment	Mobile Cellular Phone
Brand Name	Motorola
Model Name	XT1955-2
FCC ID	IHDT56XQ3
EUT supports Radios application	GSM/GPRS/EGPRS/WCDMA/HSPA/DC-HSDPA/HSPA+(16 QAM not support uplink)/LTE WLAN 2.4GHz 802.11b/g/n HT20/HT40 Bluetooth BR/EDR/LE
IMEI Code	Conducted: 359520090006986/359520090006978 Radiation: 359520090005392/359520090005400
HW Version	DVT2
SW Version	fastboot_ocean_oem_userdebug_9_PPO29.36_b671_intcfg-test-keys_oem.tar
EUT Stage	Identical Prototype

Note: There are two types of EUT, the differences between two samples are only for SIM slot, the sample 1 is dual SIM slot, the sample 2 is single SIM slot. According to the difference, we evaluate the sample 1 to perform full test.



1.4 Product Specification of Equipment Under Test

Standards-related Product Specification	
Tx Frequency	LTE Band 2 : 1850.7 MHz ~ 1909.3 MHz LTE Band 4 : 1710.7 MHz ~ 1754.3 MHz LTE Band 5 : 824.7 MHz ~ 848.3 MHz LTE Band 7 : 2502.5 MHz ~ 2567.5 MHz LTE Band 66 : 1710.7 MHz ~ 1779.3 MHz
Rx Frequency	LTE Band 2 : 1930.7 MHz ~ 1989.3 MHz LTE Band 4 : 2110.7 MHz ~ 2154.3 MHz LTE Band 5 : 869.7 MHz ~ 893.3 MHz LTE Band 7 : 2622.5MHz ~ 2687.5 MHz LTE Band 66 : 2110.7 MHz~ 2179.3 MHz
Bandwidth	LTE Band 2 : 1.4MHz / 3MHz / 5MHz / 10MHz / 15MHz / 20MHz LTE Band 4 : 1.4MHz / 3MHz / 5MHz / 10MHz / 15MHz / 20MHz LTE Band 5 : 1.4MHz / 3MHz / 5MHz / 10MHz LTE Band 7 : 5MHz / 10MHz / 15MHz / 20MHz LTE Band 66 : 1.4MHz / 3MHz / 5MHz / 10MHz / 15MHz / 20MHz
Maximum Output Power to Antenna	LTE Band 2 : 23.46 dBm LTE Band 4 : 23.49 dBm LTE Band 5 : 23.05 dBm LTE Band 7 : 23.29 dBm LTE Band 66 : 23.30 dBm
Antenna Gain	LTE Band 2 : 1.8 dBi LTE Band 4 : 0.9 dBi LTE Band 5 : -1.0 dBi LTE Band 7 : -1.0 dBi LTE Band 66 : 0.9 dBi
Type of Modulation	QPSK / 16QAM / 64QAM

1.5 Specification of Accessory

Specification of Accessory				
AC Adapter 1 (US)	Brand Name	Motorola(Salom)	Model Name	SC-51
	Power Rating	I/P: 100 - 240 Vac, 0.6A, O/P: 5Vdc -3000mA; 9Vdc -2000mA;12Vdc -1500mA		
AC Adapter 1 (EU)	Brand Name	Motorola(Salom)	Model Name	SC-52
	Power Rating	I/P: 100 - 240 Vac, 0.6A, O/P: 5Vdc -3000mA; 9Vdc -2000mA;12Vdc -1500mA		
AC Adapter 1 (AR)	Brand Name	Motorola(Salom)	Model Name	SC-56
	Power Rating	I/P: 100 - 240 Vac, 0.6A, O/P: 5Vdc -3000mA; 9Vdc -2000mA;12Vdc -1500mA		
AC Adapter 2 (US)	Brand Name	Motorola(Chenyang)	Model Name	SC-51
	Power Rating	I/P: 100 - 240 Vac, 0.6A, O/P: 5Vdc -3000mA; 9Vdc -2000mA;12Vdc -1500mA		
AC Adapter 2 (EU)	Brand Name	Motorola(Chenyang)	Model Name	SC-52
	Power Rating	I/P: 100 - 240 Vac, 0.6A, O/P: 5Vdc -3000mA; 9Vdc -2000mA;12Vdc -1500mA		
AC Adapter 2 (AR)	Brand Name	Motorola(Chenyang)	Model Name	SC-56
	Power Rating	I/P: 100 - 240 Vac, 0.6A, O/P: 5Vdc -3000mA; 9Vdc -2000mA;12Vdc -1500mA		
Earphone	Brand Name	Motorola(Lianyun)	Model Name	LYM500B-36C-003
	Signal Line	1.2 meter, non-shielded cable, without ferrite core		
USB Cable	Brand Name	Motorola(Saibao)	Model Name	711310002491
	Signal Line	1.0 meter, shielded cable, without ferrite core		
Battery	Brand Name	Motorola (SCUD)	Model Name	JK50
	Power Rating	3.8Vdc,5000mAh	Type	Li-ion

1.6 Modification of EUT

No modifications are made to the EUT during all test items.



1.7 Maximum ERP/EIRP Power, Frequency Tolerance, and Emission Designator

LTE Band 2		QPSK			16QAM		
BW (MHz)	Frequency Range (MHz)	Emission Designator (99%OBW)	Frequency Tolerance (ppm)	Maximum EIRP(W)	Emission Designator (99%OBW)	Frequency Tolerance (ppm)	Maximum EIRP(W)
1.4	1850.7 ~ 1909.3	1M09G7D	-	0.3148	1M10W7D	-	0.2679
3	1851.5 ~ 1908.5	2M72G7D	-	0.3141	2M72W7D	-	0.2692
5	1852.5 ~ 1907.5	4M50G7D	-	0.3199	4M50W7D	-	0.2748
10	1855.0 ~ 1905.0	9M03G7D	0.0028	0.3319	9M05W7D	-	0.2812
15	1857.5 ~ 1902.5	13M4G7D	-	0.3334	13M5W7D	-	0.2884
20	1860.0 ~ 1900.0	18M4G7D	-	0.3357	18M5W7D	-	0.2871
LTE Band 2		64QAM					
BW (MHz)	Frequency Range (MHz)	Emission Designator (99%OBW)	Frequency Tolerance (ppm)		Maximum EIRP(W)		
1.4	1850.7 ~ 1909.3	1M10W7D	-		0.2084		
3	1851.5 ~ 1908.5	2M73W7D	-		0.2070		
5	1852.5 ~ 1907.5	4M78W7D	-		0.2094		
10	1855.0 ~ 1905.0	9M03W7D	-		0.2158		
15	1857.5 ~ 1902.5	13M5W7D	-		0.2213		
20	1860.0 ~ 1900.0	18M5W7D	-		0.2113		
LTE Band 5		QPSK			16QAM		
BW (MHz)	Frequency Range (MHz)	Emission Designator (99%OBW)	Frequency Tolerance (ppm)	Maximum ERP(W)	Emission Designator (99%OBW)	Frequency Tolerance (ppm)	Maximum ERP(W)
1.4	824.7 ~ 848.3	1M10G7D	-	0.0935	1M10W7D	-	0.0787
3	825.5 ~ 847.5	2M73G7D	-	0.0912	2M74W7D	-	0.0789
5	826.5 ~ 846.5	4M52G7D	-	0.0927	4M51W7D	-	0.0791
10	829.0 ~ 844.0	9M09G7D	0.0077	0.0977	9M03W7D	-	0.0822



LTE Band 5		64QAM					
BW (MHz)	Frequency Range (MHz)	Emission Designator (99%OBW)	Frequency Tolerance (ppm)	Maximum ERP(W)			
1.4	824.7 ~ 848.3	1M10W7D	-	0.0619			
3	825.5 ~ 847.5	2M73W7D	-	0.0592			
5	826.5 ~ 846.5	4M50W7D	-	0.0610			
10	829.0 ~ 844.0	9M09W7D	-	0.0634			
LTE Band 7		QPSK			16QAM		
BW (MHz)	Frequency Range (MHz)	Emission Designator (99%OBW)	Frequency Tolerance (ppm)	Maximum EIRP(W)	Emission Designator (99%OBW)	Frequency Tolerance (ppm)	Maximum EIRP(W)
5	2502.5 ~ 2567.5	4M50G7D	-	0.1644	4M50W7D	-	0.1403
10	2505.0 ~ 2565.0	9M05G7D	0.0027	0.1690	9M07W7D	-	0.1409
15	2507.5 ~ 2562.5	13M4G7D	-	0.1663	13M5W7D	-	0.1377
20	2510.0 ~ 2560.0	18M4G7D	-	0.1694	18M5W7D	-	0.1400
LTE Band 7		64QAM					
BW (MHz)	Frequency Range (MHz)	Emission Designator (99%OBW)	-		Maximum EIRP(W)		
5	2502.5 ~ 2567.5	4M50W7D	-		0.1096		
10	2505.0 ~ 2565.0	9M07W7D	-		0.1119		
15	2507.5 ~ 2562.5	13M5W7D	-		0.1072		
20	2510.0 ~ 2560.0	18M5W7D	-		0.1089		

LTE Band 4/66		QPSK			16QAM		
BW (MHz)	Frequency Range (MHz)	Emission Designator (99%OBW)	Frequency Tolerance (ppm)	Maximum EIRP(W)	Emission Designator (99%OBW)	Frequency Tolerance (ppm)	Maximum EIRP(W)
1.4	1710.7 ~ 1779.3	1M10G7D	-	0.2594	1M09W7D	-	0.2178
3	1711.5 ~ 1778.5	2M73G7D	-	0.2506	2M73W7D	-	0.2163
5	1712.5 ~ 1777.5	4M51G7D	-	0.2606	4M51W7D	-	0.2188
10	1715.0 ~ 1775.0	9M09G7D	0.0034	0.2432	9M01W7D	-	0.2163
15	1717.5 ~ 1772.5	13M4G7D	-	0.2594	13M5W7D	-	0.2188
20	1720.0 ~ 1770.0	18M4G7D	-	0.2630	18M4W7D	-	0.2188



LTE Band 4/66		64QAM		
BW (MHz)	Frequency Range (MHz)	Emission Designator (99%OBW)	Frequency Tolerance (ppm)	Maximum EIRP(W)
1.4	1710.7 ~ 1779.3	1M10W7D	-	0.1679
3	1711.5 ~ 1778.5	2M73W7D	-	0.1706
5	1712.5 ~ 1777.5	4M51W7D	-	0.1738
10	1715.0 ~ 1775.0	9M03W7D	-	0.1854
15	1717.5 ~ 1772.5	13M4W7D	-	0.1871
20	1720.0 ~ 1770.0	18M5W7D	-	0.1730

Note:

1. LTE Band 66 overlaps the entire frequency range of LTE Band 4. Therefore, the test results provided in this report covers Band 66 as well as Band 4.



1.8 Testing Location

Sporton International (Kunshan) Inc. is accredited to ISO 17025 by National Voluntary Laboratory Accreditation Program (NVLAP code: 600155-0).

Test Site	Sporton International (Kunshan) Inc.		
Test Site Location	No. 1098, Pengxi North Road, Kunshan Economic Development Zone, Jiangsu Province 215335, China TEL : 86-512-57900158 FAX : 86-512-57900958		
Test Site No.	Sporton Site No.	FCC designation No.	FCC Test Firm Registration No.
	TH01-KS 03CH05-KS	CN5013	630927

1.9 Applicable Standards

According to the specifications of the manufacturer, the EUT must comply with the requirements of the following standards:

- ♦ 47 CFR Part 2, 22(H), 24(E), 27(L), 27(M)
- ♦ ANSI C63.26-2015
- ♦ FCC KDB 971168 D01 Power Meas License Digital Systems v03r01
- ♦ FCC KDB 412172 D01 Determining ERP and EIRP v01r01

Remark:

1. All test items were verified and recorded according to the standards and without any deviation during the test.
2. This EUT has also been tested and complied with the requirements of FCC Part 15, Subpart B, recorded in a separate test report.



2 Test Configuration of Equipment Under Test

2.1 Test Mode

Antenna port conducted and radiated test items listed below are performed according to KDB 971168 D01 Power Meas License Digital Systems v03r01 with maximum output power.

Radiated measurements are performed by rotating the EUT in three different orthogonal test planes to find the maximum emission.

Test Items	Band	Bandwidth (MHz)						Modulation			RB #			Test Channel		
		1.4	3	5	10	15	20	QPS K	16QA M	64QA M	1	Hal f	Ful l	L	M	H
Max. Output Power	2	v	v	v	v	v	v	v	v	v	v	v	v	v	v	v
	5	v	v	v	v	-	-	v	v	v	v	v	v	v	v	v
	7	-	-	v	v	v	v	v	v	v	v	v	v	v	v	v
	66	v	v	v	v	v	v	v	v	v	v	v	v	v	v	v
Peak-to-Average Ratio	2						v	v	v	v	v		v	v	v	v
	5				v	-	-	v	v	v	v		v	v	v	v
	7	-	-				v	v	v	v	v		v	v	v	v
	66						v	v	v	v	v		v	v	v	v
26dB and 99% Bandwidth	2	v	v	v	v	v	v	v	v	v			v	v	v	v
	5	v	v	v	v	-	-	v	v	v			v	v	v	v
	7	-	-	v	v	v	v	v	v	v			v	v	v	v
	66	v	v	v	v	v	v	v	v	v			v	v	v	v
Conducted Band Edge	2	v	v	v	v	v	v	v	v	v	v		v	v		v
	5	v	v	v	v	-	-	v	v	v	v		v	v		v
	7	-	-	v	v	v	v	v	v	v	v		v	v		v
	66	v	v	v	v	v	v	v	v	v	v		v	v		v



Test Items	Band	Bandwidth (MHz)						Modulation			RB #			Test Channel		
		1.4	3	5	10	15	20	QPS K	16QA M	64QA M	1	Half	Full	L	M	H
Conducted Spurious Emission	2	v	v	v	v	v	v	v	v	v	v			v	v	v
	5	v	v	v	v	-	-	v	v	v	v			v	v	v
	7	-	-	v	v	v	v	v	v	v	v			v	v	v
	66	v	v	v	v	v	v	v	v	v	v			v	v	v
Frequency Stability	2				v			v					v		v	
	5				v	-	-	v					v		v	
	7	-	-		v			v					v		v	
	66				v			v					v		v	
E.R.P / E.I.R.P	2	v	v	v	v	v	v	v	v	v	v			v	v	v
	5	v	v	v	v	-	-	v	v	v	v			v	v	v
	7	-	-	v	v	v	v	v	v	v	v			v	v	v
	66	v	v	v	v	v	v	v	v	v	v			v	v	v
Radiated Spurious Emission	2	Worst Case												v		
	5	Worst Case												v		
	7	Worst Case												v		
	66	Worst Case												v		
Note	<ol style="list-style-type: none"> The mark "v" means that this configuration is chosen for testing The mark "-" means that this bandwidth is not supported. The device is investigated from 30MHz to 10 times of fundamental signal for radiated spurious emission test under different RB size/offset and modulations in exploratory test. Subsequently, only the worst case emissions are reported. LTE Band 66 overlaps the entire frequency range of LTE Band 4. Therefore, the test results provided in this report covers Band 66 as well as Band 4. 															

2.2 Connection Diagram of Test System

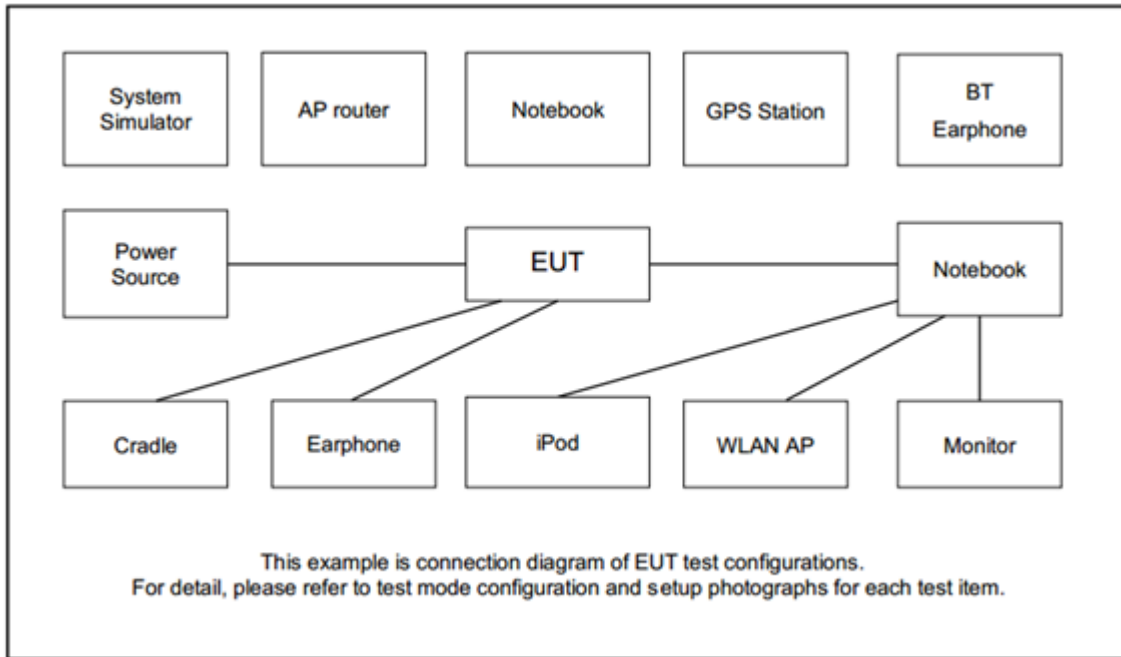

2.3 Support Unit used in test configuration and system

Item	Equipment	Trade Name	Model No.	FCC ID	Data Cable	Power Cord
1.	LTE Base Station	Anritsu	MT8820C	N/A	N/A	Unshielded, 1.8 m
2.	DC Power Supply	GW INSTRON	GPS-3030D	N/A	N/A	Unshielded, 1.8 m

2.4 Measurement Results Explanation Example

For all conducted test items:

The offset level is set in the spectrum analyzer to compensate the RF cable loss and attenuator factor between EUT conducted output port and spectrum analyzer. With the offset compensation, the spectrum analyzer reading level is exactly the EUT RF output level.

The spectrum analyzer offset is derived from RF cable loss and attenuator factor.

Offset = RF cable loss.

Following shows an offset computation example with cable loss 5.0 dB.

Example :

$$\begin{aligned} \text{Offset(dB)} &= \text{RF cable loss(dB)}. \\ &= 5.0 \text{ (dB)} \end{aligned}$$



2.5 Frequency List of Low/Middle/High Channels

LTE Band 2 Channel and Frequency List				
BW [MHz]	Channel/Frequency(MHz)	Lowest	Middle	Highest
20	Channel	18700	18900	19100
	Frequency	1860	1880	1900
15	Channel	18675	18900	19125
	Frequency	1857.5	1880	1902.5
10	Channel	18650	18900	19150
	Frequency	1855	1880	1905
5	Channel	18625	18900	19175
	Frequency	1852.5	1880	1907.5
3	Channel	18615	18900	19185
	Frequency	1851.5	1880	1908.5
1.4	Channel	18607	18900	19193
	Frequency	1850.7	1880	1909.3

LTE Band 4 Channel and Frequency List				
BW [MHz]	Channel/Frequency(MHz)	Lowest	Middle	Highest
20	Channel	20050	20175	20300
	Frequency	1720	1732.5	1745
15	Channel	20025	20175	20325
	Frequency	1717.5	1732.5	1747.5
10	Channel	20000	20175	20350
	Frequency	1715	1732.5	1750
5	Channel	19975	20175	20375
	Frequency	1712.5	1732.5	1752.5
3	Channel	19965	20175	20385
	Frequency	1711.5	1732.5	1753.5
1.4	Channel	19957	20175	20393
	Frequency	1710.7	1732.5	1754.3



LTE Band 5 Channel and Frequency List				
BW [MHz]	Channel/Frequency(MHz)	Lowest	Middle	Highest
10	Channel	20450	20525	20600
	Frequency	829	836.5	844
5	Channel	20425	20525	20625
	Frequency	826.5	836.5	846.5
3	Channel	20415	20525	20635
	Frequency	825.5	836.5	847.5
1.4	Channel	20407	20525	20643
	Frequency	824.7	836.5	848.3

LTE Band 7 Channel and Frequency List				
BW [MHz]	Channel/Frequency(MHz)	Lowest	Middle	Highest
20	Channel	20850	21100	21350
	Frequency	2510	2535	2560
15	Channel	20825	21100	21375
	Frequency	2507.5	2535	2562.5
10	Channel	20800	21100	21400
	Frequency	2505	2535	2565
5	Channel	20775	21100	21425
	Frequency	2502.5	2535	2567.5



LTE Band 66 Channel and Frequency List				
BW [MHz]	Channel/Frequency(MHz)	Lowest	Middle	Highest
20	Channel	132072	132322	132572
	Frequency	1720	1745	1770
15	Channel	132047	132322	132597
	Frequency	1717.5	1745	1772.5
10	Channel	132022	132322	132622
	Frequency	1715	1745	1775
5	Channel	131997	132322	132647
	Frequency	1712.5	1745	1777.5
3	Channel	131987	132322	132657
	Frequency	1711.5	1745	1778.5
1.4	Channel	131979	132322	132665
	Frequency	1710.7	1745	1779.3

3 Conducted Test Items

3.1 Measuring Instruments

See list of measuring instruments of this test report.

3.2 Test Setup

3.2.1 Conducted Output Power

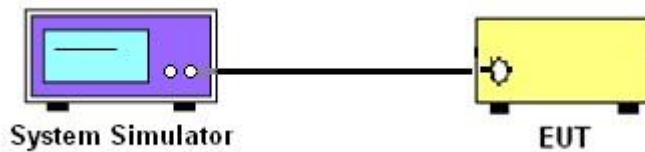

3.2.2 Peak-to-Average Ratio, Occupied Bandwidth ,Conducted Band-Edge and Conducted Spurious Emission



3.2.3 Frequency Stability

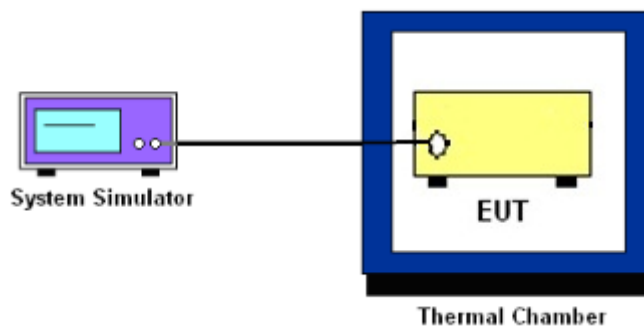

3.3 Test Result of Conducted Test

Please refer to Appendix A.



3.4 Conducted Output Power and ERP/EIRP

3.4.1 Description of the Conducted Output Power Measurement and ERP/EIRP Measurement

A system simulator was used to establish communication with the EUT. Its parameters were set to force the EUT transmitting at maximum output power. The measured power in the radio frequency on the transmitter output terminals shall be reported.

The ERP of mobile transmitters must not exceed 7 Watts for LTE Band 5.

The EIRP of mobile transmitters must not exceed 2 Watts for LTE Band 2 and Band 7

The EIRP of mobile transmitters must not exceed 1 Watts for LTE Band 4 and Band 66.

According to KDB 412172 D01 Power Approach,

$EIRP = P_T + G_T - L_C$, $ERP = EIRP - 2.15$, where

P_T = transmitter output power in dBm

G_T = gain of the transmitting antenna in dBi

L_C = signal attenuation in the connecting cable between the transmitter and antenna in dB

3.4.2 Test Procedures

1. The testing follows ANSI C63.26 Section 5.2
2. The transmitter output port was connected to the system simulator.
3. Set EUT at maximum power through the system simulator.
4. Select lowest, middle, and highest channels for each band and different modulation.
5. Measure and record the power level from the system simulator.



3.5 Peak-to-Average Ratio

3.5.1 Description of the PAR Measurement

Power Complementary Cumulative Distribution Function (CCDF) curves provide a means for characterizing the power peaks of a digitally modulated signal on a statistical basis. A CCDF curve depicts the probability of the peak signal amplitude exceeding the average power level. Most contemporary measurement instrumentation include the capability to produce CCDF curves for an input signal provided that the instrument's resolution bandwidth can be set wide enough to accommodate the entire input signal bandwidth. In measuring transmissions in this band using an average power technique, the peak-to-average ratio (PAR) of the transmission may not exceed 13 dB.

3.5.2 Test Procedures

1. The testing follows ANSI C63.26 Section 5.2.3.4 (CCDF).
2. The EUT was connected to spectrum and system simulator via a power divider.
3. Set the CCDF (Complementary Cumulative Distribution Function) option in spectrum analyzer.
4. The highest RF powers were measured and recorded the maximum PAPR level associated with a probability of 0.1 %.
5. Record the deviation as Peak to Average Ratio.



3.6 Occupied Bandwidth

3.6.1 Description of Occupied Bandwidth Measurement

The occupied bandwidth is the width of a frequency band such that, below the lower and above the upper frequency limits, the mean powers emitted are each equal to a specified percentage 0.5% of the total mean transmitted power.

The 26 dB emission bandwidth is defined as the frequency range between two points, one above and one below the carrier frequency, at which the spectral density of the emission is attenuated 26 dB below the maximum in-band spectral density of the modulated signal. Spectral density (power per unit bandwidth) is to be measured with a detector of resolution bandwidth equal to approximately 1.0% of the emission bandwidth.

3.6.2 Test Procedures

1. The testing follows ANSI C63.26 Section 5.4
2. The EUT was connected to spectrum analyzer and system simulator via a power divider.
3. The spectrum analyzer center frequency is set to the nominal EUT channel center frequency. The span range for the spectrum analyzer shall be between two and five times the anticipated OBW.
4. The nominal resolution bandwidth (RBW) shall be in the range of 1 to 5 % of the anticipated OBW, and the VBW shall be at least 3 times the RBW.
5. Set the detection mode to peak, and the trace mode to max hold.
6. Determine the reference value: Set the EUT to transmit a modulated signal. Allow the trace to stabilize. Set the spectrum analyzer marker to the highest level of the displayed trace.
(this is the reference value)
7. Determine the “-26 dB down amplitude” as equal to (Reference Value – X).
8. Place two markers, one at the lowest and the other at the highest frequency of the envelope of the spectral display such that each marker is at or slightly below the “-X dB down amplitude” determined in step 6. If a marker is below this “-X dB down amplitude” value it shall be placed as close as possible to this value. The OBW is the positive frequency difference between the two markers.
9. Use the 99 % power bandwidth function of the spectrum analyzer and report the measured bandwidth.



3.7 Conducted Band Edge

3.7.1 Description of Conducted Band Edge Measurement

22.917(a)

For operations in the 824 – 849 MHz band, the FCC limit is $43 + 10\log_{10}(P[\text{Watts}])$ dB below the transmitter power $P(\text{Watts})$ in a 100kHz bandwidth. However, in the 1MHz bands immediately outside and adjacent to the licensee's frequency block, a resolution bandwidth of at least one percent of the emission bandwidth of the fundamental emission of the transmitter may be employed.

24.238 (a)

For operations in the 1850-1910 and 1930-1990 MHz band, the FCC limit is $43 + 10\log_{10}(P[\text{Watts}])$ dB below the transmitter power $P(\text{Watts})$ in a 1MHz bandwidth. However, in the 1 MHz bands immediately outside and adjacent to the frequency block a resolution bandwidth of at least one percent of the emission bandwidth of the fundamental emission of the transmitter may be employed.

27.53 (h)

For operations in the 1710 – 1755 MHz band, the FCC limit is $43 + 10\log_{10}(P[\text{Watts}])$ dB below the transmitter power $P(\text{Watts})$ in a 1 MHz bandwidth. However, in the 1MHz bands immediately outside and adjacent to the licensee's frequency block, a resolution bandwidth of at least one percent of the emission bandwidth of the fundamental emission of the transmitter may be employed.

27.53(m)(4)

For mobile digital stations, the attenuation factor shall be not less than $40 + 10 \log (P)$ dB on all frequencies between the channel edge and 5 megahertz from the channel edge, $43 + 10 \log (P)$ dB on all frequencies between 5 megahertz and X megahertz from the channel edge, and $55 + 10 \log (P)$ dB on all frequencies more than X megahertz from the channel edge, where X is the greater of 6 megahertz or the actual emission bandwidth as defined in paragraph (m)(6) of this section. In addition, the attenuation factor shall not be less that $43 + 10 \log (P)$ dB on all frequencies between 2490.5 MHz and 2496 MHz and $55 + 10 \log (P)$ dB at or below 2490.5 MHz. Mobile Satellite Service licensees operating on frequencies below 2495 MHz may also submit a documented interference complaint against BRS licensees operating on channel BRS Channel 1 on the same terms and conditions as adjacent channel BRS or EBS licensees.



3.7.2 Test Procedures

1. The testing follows ANSI C63.26 section 5.7
2. The EUT was connected to spectrum analyzer and system simulator via a power divider.
3. The band edges of low and high channels for the highest RF powers were measured.
4. Set RBW \geq 1% EBW in the 1MHz band immediately outside and adjacent to the band edge.
5. Beyond the 1 MHz band from the band edge, RBW=1MHz was used
6. Set spectrum analyzer with RMS detector.
7. The RF fundamental frequency should be excluded against the limit line in the operating frequency band.
8. Checked that all the results comply with the emission limit line.

Example:

The limit line is derived from $43 + 10\log(P)$ dB below the transmitter power P(Watts)
= P(W)- [43 + 10log(P)] (dB)
= [30 + 10log(P)] (dBm) - [43 + 10log(P)] (dB) = -13dBm.

9. For LTE Band 7, the other 40 dB, and 55 dB have additionally applied same calculation above.



3.8 Conducted Spurious Emission

3.8.1 Description of Conducted Spurious Emission Measurement

The power of any emission outside of the authorized operating frequency ranges must be lower than the transmitter power (P) by a factor of at least $43 + 10 \log (P)$ dB.

For Band 7:

The power of any emission outside of the authorized operating frequency ranges must be lower than the transmitter power (P) by a factor of at least $55 + 10 \log (P)$ dB.

It is measured by means of a calibrated spectrum analyzer and scanned from 30 MHz up to a frequency including its 10th harmonic.

3.8.2 Test Procedures

1. The testing follows ANSI C63.26 section 5.7
2. The EUT was connected to spectrum analyzer and system simulator via a power divider.
3. The RF output of EUT was connected to the spectrum analyzer by RF cable and attenuator. The path loss was compensated to the results for each measurement.
4. The middle channel for the highest RF power within the transmitting frequency was measured.
5. The conducted spurious emission for the whole frequency range was taken.
6. Make the measurement with the spectrum analyzer's RBW = 1MHz, VBW = 3MHz.
7. Set spectrum analyzer with RMS detector.
8. Taking the record of maximum spurious emission.
9. The RF fundamental frequency should be excluded against the limit line in the operating frequency band.
10. The limit line is derived from $43 + 10\log(P)$ dB below the transmitter power P(Watts)
 $= P(W) - [43 + 10\log(P)]$ (dB)
 $= [30 + 10\log(P)]$ (dBm) - $[43 + 10\log(P)]$ (dB)
 $= -13$ dBm.
11. For Band 7
The limit line is derived from $55 + 10\log(P)$ dB below the transmitter power P(Watts)
 $= P(W) - [55 + 10\log(P)]$ (dB)
 $= [30 + 10\log(P)]$ (dBm) - $[55 + 10\log(P)]$ (dB)
 $= -25$ dBm.



3.9 Frequency Stability

3.9.1 Description of Frequency Stability Measurement

The frequency stability shall be measured by variation of ambient temperature and variation of primary supply voltage to ensure that the fundamental emission stays within the authorized frequency block. The frequency stability of the transmitter shall be maintained within $\pm 0.00025\%$ ($\pm 2.5\text{ppm}$) of the center frequency.

3.9.2 Test Procedures for Temperature Variation

1. The testing follows ANSI C63.26 section 5.6.4
2. The EUT was set up in the thermal chamber and connected with the system simulator.
3. With power OFF, the temperature was decreased to -30°C and the EUT was stabilized before testing. Power was applied and the maximum change in frequency was recorded within one minute.
4. With power OFF, the temperature was raised in 10°C step up to 50°C . The EUT was stabilized at each step for at least half an hour. Power was applied and the maximum frequency change was recorded within one minute.

3.9.3 Test Procedures for Voltage Variation

1. The testing follows ANSI C63.26 section 5.6.5
2. The EUT was placed in a temperature chamber at $20\pm 5^{\circ}\text{C}$ and connected with the system simulator.
3. The power supply voltage to the EUT was varied from 85% to 115% of the nominal value for other than hand carried battery equipment.
4. For hand carried, battery powered equipment, reduce the primary ac or dc supply voltage to the battery operating end point, which shall be specified by the manufacturer.
5. The variation in frequency was measured for the worst case.

4 Radiated Test Items

4.1 Measuring Instruments

See list of measuring instruments of this test report.

4.2 Test Setup

4.2.1 For radiated test from 30MHz to 1GHz

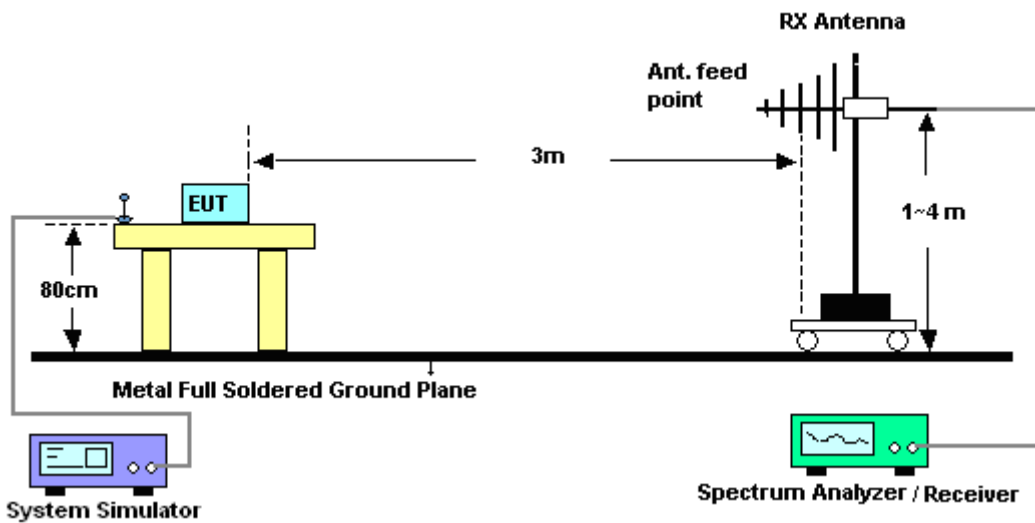

4.2.2 For radiated test above 1GHz

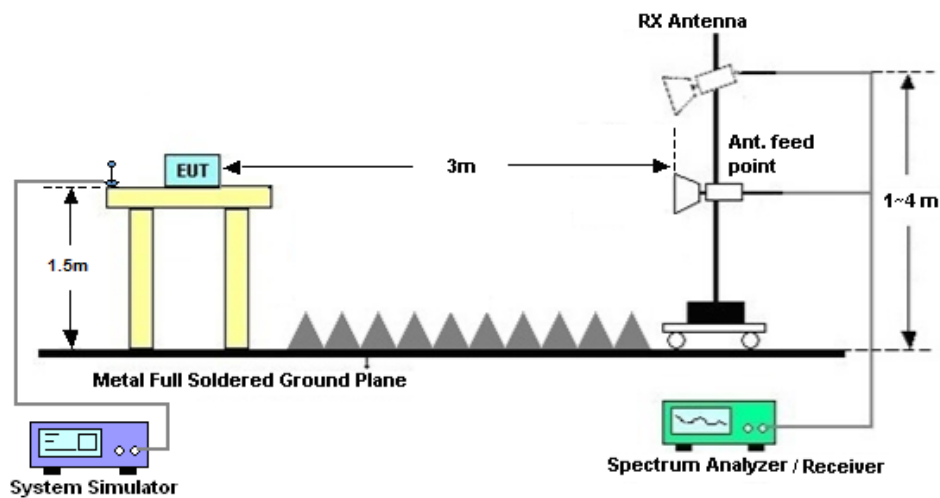

4.3 Test Result of Radiated Test

Please refer to Appendix B.



4.4 Radiated Spurious Emission

4.4.1 Description of Radiated Spurious Emission

The radiated spurious emission was measured by substitution method according to ANSI C63.26. The power of any emission outside of the authorized operating frequency ranges must be attenuated below the transmitter power (P) by a factor of at least $43 + 10 \log (P)$ dB.

For Band 7

The power of any emission outside of the authorized operating frequency ranges must be attenuated below the transmitter power (P) by a factor of at least $55 + 10 \log (P)$ dB.

The spectrum is scanned from 30 MHz up to a frequency including its 10th harmonic.

4.4.2 Test Procedures

1. The testing follows ANSI C63.26 Section 5.5
2. The EUT was placed on a turntable with 0.8 meter height for frequency below 1GHz and 1.5 meter height for frequency above 1GHz respectively above ground.
3. The EUT was set 3 meters from the receiving antenna mounted on the antenna tower.
4. The table was rotated 360 degrees to determine the position of the highest spurious emission.
5. The height of the receiving antenna is varied between 1m to 4m to search the maximum spurious emission for both horizontal and vertical polarizations.
6. During the measurement, the system simulator parameters were set to force the EUT transmitting at maximum output power.
7. Make the measurement with the spectrum analyzer's RBW = 1MHz, VBW = 3MHz, taking the record of maximum spurious emission.
8. A horn antenna was substituted in place of the EUT and was driven by a signal generator.
9. Tune the output power of signal generator to the same emission level with EUT maximum spurious emission.
10. $EIRP (dBm) = S.G. Power - Tx Cable Loss + Tx Antenna Gain$
11. $ERP (dBm) = EIRP - 2.15$
12. The RF fundamental frequency should be excluded against the limit line in the operating frequency band.

The limit line is derived from $43 + 10\log(P)$ dB below the transmitter power P(Watts)
 $= P(W) - [43 + 10\log(P)] (dB)$
 $= [30 + 10\log(P)] (dBm) - [43 + 10\log(P)] (dB)$
 $= -13dBm.$

13. For Band 7:

The limit line is derived from $55 + 10\log(P)$ dB below the transmitter power P(Watts)



5 List of Measuring Equipment

Instrument	Manufacturer	Model No.	Serial No.	Characteristics	Calibration Date	Test Date	Due Date	Remark
Spectrum Analyzer	R&S	FSP40	100319	9kHz~40GHz	Oct. 12, 2017	Sep. 16, 2018~ Sep. 19, 2018	Oct. 11, 2018	Conducted (TH01-KS)
Thermal Chamber	Ten Billion	TTC-B3S	TBN-960502	-40~+150°C	Oct. 12, 2017	Sep. 16, 2018~ Sep. 19, 2018	Oct. 11, 2018	Conducted (TH01-KS)
EXA Spectrum Analyzer	Keysight	N9010A	MY55150244	10Hz-44GHz	Apr. 17, 2018	Sep. 21, 2018~ Oct. 08, 2018	Apr. 16, 2019	Radiation (03CH05-KS)
Bilog Antenna	TeseQ	CBL6111D	49922	30MHz-1GHz	Jan. 29, 2018	Sep. 21, 2018~ Oct. 08, 2018	Jan. 28, 2019	Radiation (03CH05-KS)
Double Ridge Horn Antenna	ETS-Lindgren	3117	75959	1GHz~18GHz	Jan. 21, 2018	Sep. 21, 2018~ Oct. 08, 2018	Jan. 20, 2019	Radiation (03CH05-KS)
SHF-EHF Horn	Schwarzbeck	BBHA 9170	BBHA170249	15GHz~40GHz	Feb. 07, 2018	Sep. 21, 2018~ Oct. 08, 2018	Feb. 06, 2019	Radiation (03CH05-KS)
Amplifier	com-power	PA-103A	161069	1MHz ~1000MHz / 32 dB	Apr. 17, 2018	Sep. 21, 2018~ Oct. 08, 2018	Apr. 16, 2019	Radiation (03CH05-KS)
Amplifier	MITEQ	TTA1840-35 -HG	1887435	18~40GHz	Oct. 12, 2017	Sep. 21, 2018~ Oct. 08, 2018	Oct. 11, 2018	Radiation (03CH05-KS)
high gain Amplifier	MITEQ	AMF-7D-00 101800-30-1 0P	2025788	1Ghz-18Ghz	Apr. 17, 2018	Sep. 21, 2018~ Oct. 08, 2018	Apr. 16, 2019	Radiation (03CH05-KS)
Amplifier	Agilent	8449B	3008A02370	1GHz~26.5GHz	Oct. 12, 2017	Sep. 21, 2018~ Oct. 08, 2018	Oct. 11, 2018	Radiation (03CH05-KS)
AC Power Source	Chroma	61601	F104090004	N/A	NCR	Sep. 21, 2018~ Oct. 08, 2018	NCR	Radiation (03CH05-KS)
Turn Table	ChamPro	EM 1000-T	060762-T	0~360 degree	NCR	Sep. 21, 2018~ Oct. 08, 2018	NCR	Radiation (03CH05-KS)
Antenna Mast	ChamPro	EM 1000-A	060762-A	1 m~4 m	NCR	Sep. 21, 2018~ Oct. 08, 2018	NCR	Radiation (03CH05-KS)

NCR: No Calibration Required



6 Uncertainty of Evaluation

Uncertainty of Radiated Emission Measurement (30 MHz ~ 1000 MHz)

Measuring Uncertainty for a Level of Confidence of 95% ($U = 2Uc(y)$)	2.5 dB
---	--------

Uncertainty of Radiated Emission Measurement (1 GHz ~ 40 GHz)

Measuring Uncertainty for a Level of Confidence of 95% ($U = 2Uc(y)$)	2.0 dB
---	--------



Appendix A. Test Results of Conducted Test

Conducted Output Power(Average power)

LTE Band 2 Maximum Average Power [dBm]						
BW [MHz]	RB Size	RB Offset	Mod	Lowest	Middle	Highest
20	1	0	QPSK	23.43	23.40	23.46
20	1	49		23.09	23.12	23.21
20	1	99		23.21	23.21	23.37
20	50	0		22.12	22.15	22.19
20	50	24		22.04	22.04	22.13
20	50	50		22.10	22.12	22.19
20	100	0		22.10	22.23	22.27
20	1	0	16-QAM	22.64	22.78	22.69
20	1	49		22.30	22.31	22.32
20	1	99		22.52	22.46	22.50
20	50	0		21.08	21.15	21.17
20	50	24		21.01	21.06	21.10
20	50	50		21.05	21.13	21.23
20	100	0		21.05	21.01	21.15
20	1	0	64-QAM	21.36	21.41	21.45
20	1	49		20.99	20.95	21.09
20	1	99		21.34	21.29	21.44
20	50	0		20.08	20.10	20.16
20	50	24		19.99	20.00	20.08
20	50	50		20.06	20.05	20.15
20	100	0		20.02	20.01	20.14
15	1	0	QPSK	23.25	23.33	23.42
15	1	37		22.98	22.98	23.08
15	1	74		23.30	23.29	23.43
15	36	0		22.08	22.14	22.15
15	36	20		22.08	22.02	22.15
15	36	39		22.05	22.09	22.20
15	75	0		22.12	22.07	22.19



15	1	0	16-QAM	22.71	22.76	22.80
15	1	37		22.23	22.17	22.30
15	1	74		22.75	22.66	22.69
15	36	0		21.10	21.10	21.12
15	36	20		21.14	21.05	21.17
15	36	39		21.03	21.08	21.12
15	75	0		21.10	21.08	21.31
15	1	0	64-QAM	21.51	21.53	21.65
15	1	37		21.53	21.48	21.60
15	1	74		21.57	21.51	21.55
15	36	0		20.10	20.09	20.12
15	36	20		20.11	19.99	20.16
15	36	39		20.01	20.02	20.11
15	75	0		20.11	20.06	20.25



LTE Band 2 Maximum Average Power [dBm]						
BW [MHz]	RB Size	RB Offset	Mod	Lowest	Middle	Highest
10	1	0	QPSK	23.34	23.36	23.41
10	1	25		23.00	22.91	23.08
10	1	49		23.21	23.31	23.40
10	25	0		22.11	22.13	22.22
10	25	12		22.09	22.07	22.18
10	25	25		22.18	22.09	22.23
10	50	0		22.12	22.09	22.20
10	1	0	16-QAM	22.65	22.69	22.68
10	1	25		22.40	22.34	22.43
10	1	49		22.54	22.66	22.67
10	25	0		21.10	21.04	21.21
10	25	12		21.08	21.01	21.13
10	25	25		21.08	21.03	21.17
10	50	0		21.12	21.03	21.16
10	1	0	64-QAM	21.45	21.54	21.48
10	1	25		21.24	21.12	21.27
10	1	49		21.47	21.48	21.50
10	25	0		20.18	20.09	20.26
10	25	12		20.13	20.09	20.21
10	25	25		20.17	20.09	20.23
10	50	0		20.09	20.08	20.18
5	1	0	QPSK	23.21	23.15	23.25
5	1	12		22.97	22.96	23.08
5	1	24		23.08	22.99	23.19
5	12	0		22.11	22.07	22.19
5	12	7		22.06	22.03	22.12
5	12	13		22.03	22.00	22.15
5	25	0		22.07	22.04	22.20



5	1	0	16-QAM	22.45	22.49	22.59
5	1	12		22.22	22.21	22.40
5	1	24		22.31	22.31	22.49
5	12	0		21.18	21.16	21.30
5	12	7		21.13	21.13	21.25
5	12	13		21.08	21.11	21.20
5	25	0		21.01	21.02	21.19
5	1	0	64-QAM	21.27	21.26	21.41
5	1	12		21.21	21.17	21.28
5	1	24		21.19	21.09	21.29
5	12	0		20.15	20.14	20.23
5	12	7		20.14	20.11	20.24
5	12	13		20.13	20.01	20.17
5	25	0		20.08	20.12	20.24



LTE Band 2 Maximum Average Power [dBm]						
BW [MHz]	RB Size	RB Offset	Mod	Lowest	Middle	Highest
3	1	0	QPSK	22.96	23.05	23.12
3	1	8		22.93	23.05	23.17
3	1	14		22.90	22.93	23.06
3	8	0		22.05	22.04	22.14
3	8	4		22.12	22.06	22.17
3	8	7		22.01	21.99	22.15
3	15	0		22.06	22.05	22.17
3	1	0	16-QAM	22.30	22.29	22.50
3	1	8		22.26	22.26	22.50
3	1	14		22.20	22.21	22.44
3	8	0		21.10	21.21	21.29
3	8	4		21.10	21.11	21.25
3	8	7		21.06	21.15	21.23
3	15	0		21.02	21.04	21.19
3	1	0	64-QAM	21.16	21.15	21.30
3	1	8		21.16	21.10	21.36
3	1	14		21.13	21.09	21.31
3	8	0		20.05	19.97	20.17
3	8	4		20.05	19.99	20.15
3	8	7		20.03	19.94	20.14
3	15	0		19.97	20.02	20.17
1.4	1	0	QPSK	22.99	22.93	23.11
1.4	1	3		23.00	23.02	23.18
1.4	1	5		22.96	22.87	23.09
1.4	3	0		23.02	23.01	23.05
1.4	3	1		23.12	23.02	23.12
1.4	3	3		23.06	22.99	23.07
1.4	6	0		21.99	21.98	22.16



1.4	1	0	16-QAM	22.35	22.23	22.39
1.4	1	3		22.43	22.30	22.48
1.4	1	5		22.33	22.20	22.45
1.4	3	0		22.08	22.14	22.17
1.4	3	1		22.19	22.15	22.25
1.4	3	3		22.02	22.09	22.19
1.4	6	0		21.07	21.00	21.14
1.4	1	0	64-QAM	21.38	21.08	21.21
1.4	1	3		21.39	21.12	21.30
1.4	1	5		21.26	21.07	21.20
1.4	3	0		21.09	21.08	21.20
1.4	3	1		21.09	21.10	21.22
1.4	3	3		21.06	21.04	21.14
1.4	6	0		19.97	19.96	20.09



LTE Band 4 Maximum Average Power [dBm]						
BW [MHz]	RB Size	RB Offset	Mod	Lowest	Middle	Highest
20	1	0	QPSK	22.71	22.87	22.86
20	1	49		22.77	23.00	23.14
20	1	99		22.71	22.86	22.91
20	50	0		21.89	21.85	21.86
20	50	24		22.00	21.85	21.96
20	50	50		21.85	21.85	21.80
20	100	0		21.89	21.89	21.83
20	1	0	16-QAM	22.12	22.20	22.16
20	1	49		22.28	22.10	22.29
20	1	99		22.10	22.16	22.27
20	50	0		20.93	20.80	20.83
20	50	24		20.94	20.86	20.93
20	50	50		20.81	20.83	20.80
20	100	0		20.83	20.72	20.90
20	1	0	64QAM	21.62	21.01	20.97
20	1	49		21.58	21.50	20.90
20	1	99		21.35	20.97	21.10
20	50	0		19.89	19.78	19.79
20	50	24		19.94	19.81	19.91
20	50	50		19.80	19.81	19.76
20	100	0		19.83	19.75	19.88
15	1	0	QPSK	23.03	22.91	22.97
15	1	37		22.81	22.76	22.89
15	1	74		22.81	22.81	22.89
15	36	0		22.03	21.88	21.98
15	36	20		21.94	21.90	21.96
15	36	39		21.85	21.82	21.93
15	75	0		21.90	21.79	21.95
15	1	0	16-QAM	22.41	22.34	22.37
15	1	37		21.97	21.89	22.11
15	1	74		22.18	22.24	22.30
15	36	0		21.03	20.95	21.00
15	36	20		20.95	20.91	21.00
15	36	39		20.85	20.86	20.90



15	75	0		20.97	20.84	20.93
15	1	0	64QAM	21.25	21.14	21.16
15	1	37		21.37	21.20	21.40
15	1	74		21.02	21.01	21.13
15	36	0		20.01	19.91	19.99
15	36	20		19.94	19.87	20.00
15	36	39		19.84	19.85	19.90
15	75	0		19.98	19.84	19.94



LTE Band 4 Maximum Average Power [dBm]						
BW [MHz]	RB Size	RB Offset	Mod	Lowest	Middle	Highest
10	1	0	QPSK	23.25	23.23	23.40
10	1	25		23.01	22.95	22.98
10	1	49		23.49	23.33	23.40
10	25	0		22.06	22.06	22.14
10	25	12		22.05	21.98	22.15
10	25	25		22.14	22.05	22.26
10	50	0		22.01	22.00	22.14
10	1	0	16-QAM	22.45	22.50	22.41
10	1	25		22.32	22.21	22.44
10	1	49		22.44	22.42	22.40
10	25	0		20.99	20.95	21.07
10	25	12		20.97	20.94	21.07
10	25	25		21.05	20.97	21.15
10	50	0		21.11	20.97	21.12
10	1	0	64QAM	21.39	21.31	21.52
10	1	25		21.21	21.05	21.17
10	1	49		21.62	21.49	21.67
10	25	0		20.04	20.03	20.17
10	25	12		20.03	19.99	20.13
10	25	25		20.10	20.06	20.27
10	50	0		20.05	19.97	20.11
5	1	0	QPSK	23.10	23.04	23.20
5	1	12		22.97	22.93	23.05
5	1	24		23.05	22.95	23.17
5	12	0		22.07	21.93	22.18
5	12	7		22.03	21.95	22.14
5	12	13		22.03	21.91	22.10
5	25	0		22.07	21.96	22.14
5	1	0	16-QAM	22.45	22.40	22.42
5	1	12		22.04	22.00	22.17
5	1	24		22.33	22.24	22.40
5	12	0		21.14	21.01	21.27
5	12	7		21.07	21.03	21.23



5	12	13	64QAM	21.06	21.06	21.19
5	25	0		20.99	20.90	21.05
5	1	0		21.25	21.25	21.34
5	1	12		21.20	21.07	21.27
5	1	24		21.14	21.01	21.29
5	12	0		20.09	19.99	20.19
5	12	7		20.06	20.04	20.16
5	12	13		20.07	19.99	20.20
5	25	0		20.05	19.97	20.16



LTE Band 4 Maximum Average Power [dBm]						
BW [MHz]	RB Size	RB Offset	Mod	Lowest	Middle	Highest
3	1	0	QPSK	22.96	22.85	23.07
3	1	8		22.89	22.94	23.16
3	1	14		22.84	22.88	23.06
3	8	0		22.06	22.02	22.09
3	8	4		22.07	21.97	22.14
3	8	7		22.01	21.96	22.10
3	15	0		21.99	21.93	22.10
3	1	0	16-QAM	22.26	22.30	22.42
3	1	8		22.30	22.26	22.47
3	1	14		22.19	22.21	22.34
3	8	0		21.11	21.10	21.24
3	8	4		21.09	21.04	21.23
3	8	7		21.04	21.09	21.24
3	15	0		21.05	20.94	21.11
3	1	0	64QAM	21.06	21.03	21.18
3	1	8		21.09	21.02	21.24
3	1	14		21.03	21.07	21.19
3	8	0		19.99	19.94	20.14
3	8	4		19.99	19.95	20.15
3	8	7		19.96	19.89	20.07
3	15	0		20.01	19.92	20.15
1.4	1	0	QPSK	22.93	22.79	22.98
1.4	1	3		23.00	22.92	23.12
1.4	1	5		22.95	22.85	23.04
1.4	3	0		23.01	22.86	23.06
1.4	3	1		23.08	22.90	23.08
1.4	3	3		23.00	22.84	23.05
1.4	6	0		21.96	21.85	22.07
1.4	1	0	16-QAM	22.31	22.27	22.34
1.4	1	3		22.36	22.25	22.44
1.4	1	5		22.33	22.13	22.35
1.4	3	0		22.03	22.00	22.21
1.4	3	1		22.11	22.05	22.24



1.4	3	3	64QAM	21.97	22.00	22.20
1.4	6	0		20.98	20.91	21.12
1.4	1	0		21.31	21.02	21.23
1.4	1	3		21.37	20.99	21.20
1.4	1	5		21.29	20.94	21.20
1.4	3	0		21.10	20.96	21.16
1.4	3	1		21.01	20.99	21.21
1.4	3	3		21.02	20.95	21.10
1.4	6	0		19.97	19.90	20.06



LTE Band 5 Maximum Average Power [dBm]						
BW [MHz]	RB Size	RB Offset	Mod	Lowest	Middle	Highest
10	1	0	QPSK	22.98	22.73	22.72
10	1	25		22.59	22.59	22.66
10	1	49		23.05	23.00	23.02
10	25	0		21.80	21.54	21.63
10	25	12		21.78	21.62	21.71
10	25	25		21.78	21.69	21.74
10	50	0		21.76	21.58	21.73
10	1	0	16-QAM	22.21	22.01	21.99
10	1	25		22.02	21.83	21.97
10	1	49		22.30	22.23	22.23
10	25	0		20.77	20.53	20.63
10	25	12		20.69	20.57	20.70
10	25	25		20.76	20.68	20.71
10	50	0		20.76	20.54	20.70
10	1	0	64-QAM	21.05	20.90	20.83
10	1	25		20.85	20.67	20.80
10	1	49		21.10	21.11	21.17
10	25	0		19.76	19.52	19.61
10	25	12		19.72	19.55	19.65
10	25	25		19.78	19.69	19.78
10	50	0		19.73	19.55	19.71
5	1	0	QPSK	22.82	22.66	22.66
5	1	12		22.65	22.46	22.62
5	1	24		22.67	22.55	22.66
5	12	0		21.79	21.55	21.69
5	12	7		21.77	21.55	21.70
5	12	13		21.74	21.49	21.66
5	25	0		21.74	21.59	21.67



5	1	0	16-QAM	22.13	21.89	21.93
5	1	12		21.97	21.70	21.85
5	1	24		21.96	21.83	21.97
5	12	0		20.80	20.57	20.69
5	12	7		20.78	20.59	20.71
5	12	13		20.77	20.58	20.71
5	25	0		20.72	20.53	20.62
5	1	0	64-QAM	21.00	20.77	20.80
5	1	12		20.88	20.71	20.91
5	1	24		20.84	20.72	20.79
5	12	0		19.79	19.55	19.67
5	12	7		19.77	19.55	19.69
5	12	13		19.75	19.57	19.74
5	25	0		19.72	19.59	19.68



LTE Band 5 Maximum Average Power [dBm]						
BW [MHz]	RB Size	RB Offset	Mod	Lowest	Middle	Highest
3	1	0	QPSK	22.75	22.46	22.65
3	1	8		22.69	22.54	22.64
3	1	14		22.63	22.51	22.57
3	8	0		21.77	21.48	21.65
3	8	4		21.75	21.55	21.68
3	8	7		21.72	21.52	21.63
3	15	0		21.70	21.56	21.63
3	1	0	16-QAM	22.12	21.75	21.90
3	1	8		22.11	21.88	21.91
3	1	14		21.96	21.88	21.87
3	8	0		20.83	20.58	20.75
3	8	4		20.80	20.64	20.76
3	8	7		20.79	20.60	20.75
3	15	0		20.73	20.48	20.66
3	1	0	64-QAM	20.82	20.62	20.81
3	1	8		20.87	20.67	20.80
3	1	14		20.83	20.70	20.74
3	8	0		19.73	19.50	19.61
3	8	4		19.71	19.53	19.65
3	8	7		19.65	19.46	19.64
3	15	0		19.70	19.53	19.69
1.4	1	0	QPSK	22.77	22.46	22.56
1.4	1	3		22.85	22.55	22.66
1.4	1	5		22.77	22.45	22.60
1.4	3	0		22.83	22.46	22.61
1.4	3	1		22.86	22.54	22.70
1.4	3	3		22.83	22.50	22.63
1.4	6	0		21.77	21.52	21.65



1.4	1	0	16-QAM	22.02	21.74	21.87
1.4	1	3		22.11	21.78	21.90
1.4	1	5		21.99	21.77	21.86
1.4	3	0		21.82	21.58	21.73
1.4	3	1		21.83	21.66	21.76
1.4	3	3		21.75	21.51	21.71
1.4	6	0		20.83	20.53	20.69
1.4	1	0	64-QAM	20.93	20.65	20.77
1.4	1	3		21.07	20.66	20.83
1.4	1	5		20.96	20.60	20.75
1.4	3	0		20.83	20.57	20.65
1.4	3	1		20.77	20.61	20.79
1.4	3	3		20.78	20.57	20.68
1.4	6	0		19.73	19.52	19.65



LTE Band 7 Maximum Average Power [dBm]						
BW [MHz]	RB Size	RB Offset	Mod	Lowest	Middle	Highest
20	1	0	QPSK	23.29	23.04	23.04
20	1	49		23.20	23.09	23.14
20	1	99		23.14	22.98	23.09
20	50	0		22.26	22.14	22.12
20	50	24		21.99	22.20	22.20
20	50	50		22.15	22.20	22.22
20	100	0		22.30	22.28	22.21
20	1	0	16-QAM	22.43	22.29	22.30
20	1	49		22.46	22.41	22.45
20	1	99		22.41	22.24	22.29
20	50	0		21.28	21.13	21.16
20	50	24		21.29	21.21	21.26
20	50	50		21.22	21.22	21.26
20	100	0		21.27	21.18	21.24
20	1	0	64-QAM	21.36	21.24	21.22
20	1	49		21.37	21.16	21.28
20	1	99		21.32	21.21	21.23
20	50	0		20.26	20.17	20.13
20	50	24		20.31	20.23	20.23
20	50	50		20.24	20.22	20.23
20	100	0		20.34	20.18	20.23
15	1	0	QPSK	23.03	22.93	22.94
15	1	37		23.16	23.04	23.21
15	1	74		23.07	23.03	23.13
15	36	0		22.31	22.15	22.24
15	36	20		22.32	22.22	22.36
15	36	39		22.30	22.26	22.24
15	75	0		22.29	22.16	22.24



15	1	0	16-QAM	22.39	22.21	22.28
15	1	37		22.31	22.24	22.36
15	1	74		22.27	22.29	22.31
15	36	0		21.29	21.20	21.28
15	36	20		21.31	21.22	21.32
15	36	39		21.28	21.26	21.26
15	75	0		21.27	21.24	21.29
15	1	0	64-QAM	21.25	21.14	21.22
15	1	37		21.30	21.27	21.30
15	1	74		21.21	21.25	21.22
15	36	0		20.28	20.16	20.21
15	36	20		20.30	20.22	20.32
15	36	39		20.27	20.27	20.21
15	75	0		20.28	20.24	20.28



LTE Band 7 Maximum Average Power [dBm]						
BW [MHz]	RB Size	RB Offset	Mod	Lowest	Middle	Highest
10	1	0	QPSK	23.28	23.23	23.24
10	1	25		23.19	23.10	23.22
10	1	49		23.27	23.25	22.15
10	25	0		22.21	22.16	22.23
10	25	12		22.14	22.10	22.14
10	25	25		22.19	22.07	22.19
10	50	0		22.11	22.09	22.15
10	1	0	16-QAM	22.42	22.45	22.41
10	1	25		22.29	22.26	22.31
10	1	49		22.49	22.42	22.41
10	25	0		21.21	21.07	21.20
10	25	12		21.20	21.10	21.19
10	25	25		21.19	21.05	21.18
10	50	0		21.24	21.14	21.20
10	1	0	64-QAM	21.49	21.35	21.33
10	1	25		21.27	21.18	21.21
10	1	49		21.43	21.37	21.36
10	25	0		20.22	20.11	20.20
10	25	12		20.20	20.11	20.21
10	25	25		20.20	20.07	20.19
10	50	0		20.20	20.07	20.18
5	1	0	QPSK	23.13	23.09	23.14
5	1	12		23.11	23.01	23.16
5	1	24		23.11	22.99	23.13
5	12	0		22.22	22.15	22.21
5	12	7		22.22	22.13	22.20
5	12	13		22.14	22.10	22.16
5	25	0		22.25	22.14	22.20



5	1	0	16-QAM	22.47	22.31	22.42
5	1	12		22.33	22.21	22.29
5	1	24		22.37	22.32	22.40
5	12	0		21.29	21.15	21.22
5	12	7		21.23	21.14	21.19
5	12	13		21.24	21.09	21.21
5	25	0		21.24	21.13	21.20
5	1	0	64-QAM	21.40	21.25	21.31
5	1	12		21.18	21.16	21.23
5	1	24		21.24	21.16	21.29
5	12	0		20.27	20.13	20.19
5	12	7		20.23	20.13	20.18
5	12	13		20.23	20.08	20.23
5	25	0		20.24	20.14	20.19



LTE Band 66 Maximum Average Power [dBm]						
BW [MHz]	RB Size	RB Offset	Mod	Lowest	Middle	Highest
20	1	0	QPSK	22.89	22.89	22.83
20	1	49		22.82	22.79	22.80
20	1	99		23.04	23.30	23.18
20	50	0		22.06	21.92	21.94
20	50	24		22.10	22.11	21.98
20	50	50		22.03	21.92	21.96
20	100	0		22.07	22.10	21.93
20	1	0	16-QAM	22.46	22.22	22.37
20	1	49		22.29	22.18	22.17
20	1	99		22.45	22.50	22.50
20	50	0		21.06	20.86	20.86
20	50	24		21.07	20.94	20.97
20	50	50		20.95	20.91	20.93
20	100	0		20.94	20.96	20.96
20	1	0	64-QAM	21.29	21.02	21.05
20	1	49		21.24	21.09	21.02
20	1	99		21.48	21.44	21.37
20	50	0		19.99	19.80	19.90
20	50	24		20.04	19.89	19.91
20	50	50		19.91	19.87	19.93
20	100	0		19.96	19.96	19.99
15	1	0	QPSK	23.20	23.24	23.19
15	1	37		22.89	22.89	22.86
15	1	74		23.20	23.06	23.09
15	36	0		22.16	22.02	22.07
15	36	20		22.00	21.91	21.86
15	36	39		22.01	21.84	21.89
15	75	0		22.10	21.96	21.89



15	1	0	16-QAM	22.48	22.45	22.48
15	1	37		22.23	22.28	22.12
15	1	74		22.43	22.50	22.36
15	36	0		21.17	21.00	21.10
15	36	20		21.08	21.01	20.98
15	36	39		21.09	20.91	20.91
15	75	0		21.07	20.95	20.84
15	1	0	64-QAM	21.52	21.52	21.40
15	1	37		21.81	21.79	21.51
15	1	74		21.67	21.82	21.68
15	36	0		20.11	19.97	20.05
15	36	20		20.02	19.98	19.90
15	36	39		19.98	19.92	19.87
15	75	0		20.03	19.95	19.88



LTE Band 66 Maximum Average Power [dBm]						
BW [MHz]	RB Size	RB Offset	Mod	Lowest	Middle	Highest
10	1	0	QPSK	22.59	22.46	22.54
10	1	25		22.96	22.79	22.74
10	1	49		22.94	22.91	22.93
10	25	0		22.14	21.95	21.83
10	25	12		22.27	22.08	22.06
10	25	25		22.16	22.04	21.92
10	50	0		22.17	22.00	21.91
10	1	0	16-QAM	22.01	22.06	22.05
10	1	25		22.40	22.27	22.12
10	1	49		22.40	22.45	22.42
10	25	0		21.12	20.94	20.87
10	25	12		21.29	21.07	21.04
10	25	25		21.25	21.13	21.02
10	50	0		21.23	21.02	20.94
10	1	0	64-QAM	21.31	21.29	21.29
10	1	25		21.61	21.60	21.50
10	1	49		21.71	21.78	21.58
10	25	0		20.12	19.85	19.81
10	25	12		20.26	20.07	20.04
10	25	25		20.13	20.00	19.88
10	50	0		20.17	19.99	19.89
5	1	0	QPSK	23.26	23.01	23.02
5	1	12		23.13	22.93	22.86
5	1	24		23.18	22.94	22.87
5	12	0		22.30	22.03	22.02
5	12	7		22.21	22.05	21.93
5	12	13		22.11	22.01	21.82
5	25	0		22.21	22.04	21.90



5	1	0	16-QAM	22.48	22.45	22.33
5	1	12		22.45	22.44	22.28
5	1	24		22.50	22.30	22.22
5	12	0		21.33	21.06	21.05
5	12	7		21.22	21.07	20.95
5	12	13		21.16	21.03	20.92
5	25	0		21.15	21.03	20.89
5	1	0	64-QAM	21.50	21.19	21.22
5	1	12		21.18	21.12	21.02
5	1	24		21.40	21.12	21.10
5	12	0		20.27	20.04	19.99
5	12	7		20.23	20.07	19.95
5	12	13		20.19	20.00	19.88
5	25	0		20.17	20.04	19.90



LTE Band 66 Maximum Average Power [dBm]						
BW [MHz]	RB Size	RB Offset	Mod	Lowest	Middle	Highest
3	1	0	QPSK	23.09	22.91	22.83
3	1	8		23.04	23.01	22.81
3	1	14		22.94	22.93	22.82
3	8	0		22.22	21.90	21.88
3	8	4		22.18	22.04	21.93
3	8	7		22.15	21.98	21.86
3	15	0		22.13	21.97	21.86
3	1	0	16-QAM	22.37	22.36	22.12
3	1	8		22.34	22.45	22.28
3	1	14		22.29	22.34	22.15
3	8	0		21.31	20.95	20.95
3	8	4		21.22	21.03	20.90
3	8	7		21.14	20.97	20.84
3	15	0		21.17	21.03	20.90
3	1	0	64-QAM	21.27	21.31	21.00
3	1	8		21.26	21.42	20.96
3	1	14		21.11	21.36	20.95
3	8	0		20.17	19.91	19.89
3	8	4		20.16	20.03	19.93
3	8	7		20.09	19.94	19.87
3	15	0		20.14	19.98	19.85
1.4	1	0	QPSK	23.10	22.78	22.88
1.4	1	3		23.14	22.91	22.93
1.4	1	5		23.08	22.87	22.85
1.4	3	0		23.19	22.86	22.82
1.4	3	1		23.24	23.05	22.86
1.4	3	3		23.15	22.93	22.84
1.4	6	0		22.14	21.94	21.86



1.4	1	0	16-QAM	22.36	22.21	22.12
1.4	1	3		22.48	22.37	22.17
1.4	1	5		22.34	22.29	22.13
1.4	3	0		22.23	21.93	21.85
1.4	3	1		22.28	22.16	21.86
1.4	3	3		22.24	22.01	21.79
1.4	6	0		21.14	20.95	20.87
1.4	1	0	64-QAM	21.22	21.19	20.97
1.4	1	3		21.23	21.35	20.98
1.4	1	5		21.21	21.26	21.00
1.4	3	0		21.35	20.94	20.94
1.4	3	1		21.28	21.00	20.99
1.4	3	3		21.26	21.04	20.92
1.4	6	0		20.22	19.91	19.78



ERP/EIRP

LTE Band 2 (GT - LC = 1.80 dBi) QPSK									
Bandwidth	1.4M			3M			5M		
Channel	18607	18900	19193	18615	18900	19185	18625	18900	19175
	(Low)	(Mid)	(High)	(Low)	(Mid)	(High)	(Low)	(Mid)	(High)
Frequency	1850.7	1880	1909.3	1851.5	1880	1908.5	1852.5	1880	1907.5
(MHz)									
Conducted Power (dBm)	23.00	23.02	23.18	22.93	23.05	23.17	23.21	23.15	23.25
Conducted Power (Watts)	0.1995	0.2004	0.2080	0.1963	0.2018	0.2075	0.2094	0.2065	0.2113
EIRP(dBm)	24.80	24.82	24.98	24.73	24.85	24.97	25.01	24.95	25.05
EIRP(Watts)	0.3020	0.3034	0.3148	0.2972	0.3055	0.3141	0.3170	0.3126	0.3199

LTE Band 2 (GT - LC = 1.80 dBi) QPSK									
Bandwidth	10M			15M			20M		
Channel	18650	18900	19150	18675	18900	19125	18650	18900	19100
	(Low)	(Mid)	(High)	(Low)	(Mid)	(High)	(Low)	(Mid)	(High)
Frequency	1855	1880	1905	1857.5	1880	1902.5	1860	1880	1900
(MHz)									
Conducted Power (dBm)	23.34	23.36	23.41	23.30	23.29	23.43	23.43	23.40	23.46
Conducted Power (Watts)	0.2158	0.2168	0.2193	0.2138	0.2133	0.2203	0.2203	0.2188	0.2218
EIRP(dBm)	25.14	25.16	25.21	25.10	25.09	25.23	25.23	25.20	25.26
EIRP(Watts)	0.3266	0.3281	0.3319	0.3236	0.3228	0.3334	0.3334	0.3311	0.3357



LTE Band 2 (GT - LC = 1.80 dBi) 16QAM									
Bandwidth	1.4M			3M			5M		
Channel	18607	18900	19193	18615	18900	19185	18625	18900	19175
	(Low)	(Mid)	(High)	(Low)	(Mid)	(High)	(Low)	(Mid)	(High)
Frequency (MHz)	1850.7	1880	1909.3	1851.5	1880	1908.5	1852.5	1880	1907.5
Conducted Power (dBm)	22.43	22.30	22.48	22.30	22.29	22.50	22.45	22.49	22.59
Conducted Power (Watts)	0.1750	0.1698	0.1770	0.1698	0.1694	0.1778	0.1758	0.1774	0.1816
EIRP(dBm)	24.23	24.10	24.28	24.10	24.09	24.30	24.25	24.29	24.39
EIRP(Watts)	0.2649	0.2570	0.2679	0.2570	0.2564	0.2692	0.2661	0.2685	0.2748

LTE Band 2 (GT - LC = 1.80 dBi) 16QAM									
Bandwidth	10M			15M			20M		
Channel	18650	18900	19150	18675	18900	19125	18650	18900	19100
	(Low)	(Mid)	(High)	(Low)	(Mid)	(High)	(Low)	(Mid)	(High)
Frequency (MHz)	1855	1880	1905	1857.5	1880	1902.5	1860	1880	1900
Conducted Power (dBm)	22.65	22.69	22.68	22.71	22.76	22.80	22.64	22.78	22.69
Conducted Power (Watts)	0.1841	0.1858	0.1854	0.1866	0.1888	0.1905	0.1837	0.1897	0.1858
EIRP(dBm)	24.45	24.49	24.48	24.51	24.56	24.60	24.44	24.58	24.49
EIRP(Watts)	0.2786	0.2812	0.2805	0.2825	0.2858	0.2884	0.2780	0.2871	0.2812



LTE Band 2 (GT - LC = 1.80 dBi) 64QAM									
Bandwidth	1.4M			3M			5M		
Channel	18607	18900	19193	18615	18900	19185	18625	18900	19175
	(Low)	(Mid)	(High)	(Low)	(Mid)	(High)	(Low)	(Mid)	(High)
Frequency (MHz)	1850.7	1880	1909.3	1851.5	1880	1908.5	1852.5	1880	1907.5
Conducted Power (dBm)	21.39	21.12	21.30	21.16	21.10	21.36	21.27	21.26	21.41
Conducted Power (Watts)	0.1377	0.1294	0.1349	0.1306	0.1288	0.1368	0.1340	0.1337	0.1384
EIRP(dBm)	23.19	22.92	23.10	22.96	22.90	23.16	23.07	23.06	23.21
EIRP(Watts)	0.2084	0.1959	0.2042	0.1977	0.1950	0.2070	0.2028	0.2023	0.2094

LTE Band 2 (GT - LC = 1.80 dBi) 64QAM									
Bandwidth	10M			15M			20M		
Channel	18650	18900	19150	18675	18900	19125	18650	18900	19100
	(Low)	(Mid)	(High)	(Low)	(Mid)	(High)	(Low)	(Mid)	(High)
Frequency (MHz)	1855	1880	1905	1857.5	1880	1902.5	1860	1880	1900
Conducted Power (dBm)	21.45	21.54	21.48	21.51	21.53	21.65	21.36	21.41	21.45
Conducted Power (Watts)	0.1396	0.1426	0.1406	0.1416	0.1422	0.1462	0.1368	0.1384	0.1396
EIRP(dBm)	23.25	23.34	23.28	23.31	23.33	23.45	23.16	23.21	23.25
EIRP(Watts)	0.2113	0.2158	0.2128	0.2143	0.2153	0.2213	0.2070	0.2094	0.2113



LTE Band 5 (GT - LC = -1.00 dBi) QPSK									
Bandwidth	1.4M			3M			5M		
Channel	20407	20525	20643	20415	20525	20635	20425	20525	20625
	(Low)	(Mid)	(High)	(Low)	(Mid)	(High)	(Low)	(Mid)	(High)
Frequency (MHz)	824.7	836.5	848.3	825.5	836.5	847.5	826.5	836.5	846.5
Conducted Power (dBm)	22.86	22.54	22.70	22.75	22.46	22.65	22.82	22.66	22.66
Conducted Power (Watts)	0.1932	0.1795	0.1862	0.1884	0.1762	0.1841	0.1914	0.1845	0.1845
ERP(dBm)	19.71	19.39	19.55	19.60	19.31	19.50	19.67	19.51	19.51
ERP(Watts)	0.0935	0.0869	0.0902	0.0912	0.0853	0.0891	0.0927	0.0893	0.0893

LTE Band 5 (GT - LC = -1.00 dBi) QPSK			
Bandwidth	10M		
Channel	20450	20525	20600
	(Low)	(Mid)	(High)
Frequency (MHz)	829	836.5	844
Conducted Power (dBm)	23.05	23.00	23.02
Conducted Power (Watts)	0.2018	0.1995	0.2004
ERP(dBm)	19.90	19.85	19.87
ERP(Watts)	0.0977	0.0966	0.0971



LTE Band 5 (GT - LC = -1.00 dBi) 16QAM									
Bandwidth	1.4M			3M			5M		
Channel	20407	20525	20643	20415	20525	20635	20425	20525	20625
	(Low)	(Mid)	(High)	(Low)	(Mid)	(High)	(Low)	(Mid)	(High)
Frequency (MHz)	824.7	836.5	848.3	825.5	836.5	847.5	826.5	836.5	846.5
Conducted Power (dBm)	22.11	21.78	21.90	22.12	21.75	21.90	22.13	21.89	21.93
Conducted Power (Watts)	0.1626	0.1507	0.1549	0.1629	0.1496	0.1549	0.1633	0.1545	0.1560
ERP(dBm)	18.96	18.63	18.75	18.97	18.60	18.75	18.98	18.74	18.78
ERP(Watts)	0.0787	0.0729	0.0750	0.0789	0.0724	0.0750	0.0791	0.0748	0.0755

LTE Band 5 (GT - LC = -1.00 dBi) 16QAM			
Bandwidth	10M		
Channel	20450	20525	20600
	(Low)	(Mid)	(High)
Frequency (MHz)	829	836.5	844
Conducted Power (dBm)	22.30	22.23	22.23
Conducted Power (Watts)	0.1698	0.1671	0.1671
ERP(dBm)	19.15	19.08	19.08
ERP(Watts)	0.0822	0.0809	0.0809



LTE Band 5 (G _T - L _C = -1.00 dBi) 64QAM									
Bandwidth	1.4M			3M			5M		
Channel	20407	20525	20643	20415	20525	20635	20425	20525	20625
	(Low)	(Mid)	(High)	(Low)	(Mid)	(High)	(Low)	(Mid)	(High)
Frequency (MHz)	824.7	836.5	848.3	825.5	836.5	847.5	826.5	836.5	846.5
Conducted Power (dBm)	21.07	20.66	20.83	20.87	20.67	20.80	21.00	20.77	20.80
Conducted Power (Watts)	0.1279	0.1164	0.1211	0.1222	0.1167	0.1202	0.1259	0.1194	0.1202
ERP(dBm)	17.92	17.51	17.68	17.72	17.52	17.65	17.85	17.62	17.65
ERP(Watts)	0.0619	0.0564	0.0586	0.0592	0.0565	0.0582	0.0610	0.0578	0.0582

LTE Band 5 (G _T - L _C = -1.00 dBi) 64QAM			
Bandwidth	10M		
Channel	20450	20525	20600
	(Low)	(Mid)	(High)
Frequency (MHz)	829	836.5	844
Conducted Power (dBm)	21.10	21.11	21.17
Conducted Power (Watts)	0.1288	0.1291	0.1309
ERP(dBm)	17.95	17.96	18.02
ERP(Watts)	0.0624	0.0625	0.0634



LTE Band 7 (GT - LC = -1.00 dBi) QPSK			
Bandwidth	5M		
Channel	20775	21100	21425
	(Low)	(Mid)	(High)
Frequency	2502.5	2535	2567.5
(MHz)			
Conducted Power (dBm)	23.11	23.01	23.16
Conducted Power (Watts)	0.2046	0.2000	0.2070
EIRP(dBm)	22.11	22.01	22.16
EIRP(Watts)	0.1626	0.1589	0.1644

LTE Band 7 (GT - LC = -1.00 dBi) QPSK									
Bandwidth	10M			15M			20M		
Channel	20800	21100	21400	20825	21100	21375	20850	21100	21350
	(Low)	(Mid)	(High)	(Low)	(Mid)	(High)	(Low)	(Mid)	(High)
Frequency	2505	2535	2565	2507.5	2535	2562.5	2510	2535	2560
(MHz)									
Conducted Power (dBm)	23.28	23.23	23.24	23.16	23.04	23.21	23.29	23.04	23.04
Conducted Power (Watts)	0.2128	0.2104	0.2109	0.2070	0.2014	0.2094	0.2133	0.2014	0.2014
EIRP(dBm)	22.28	22.23	22.24	22.16	22.04	22.21	22.29	22.04	22.04
EIRP(Watts)	0.1690	0.1671	0.1675	0.1644	0.1600	0.1663	0.1694	0.1600	0.1600



LTE Band 7 (GT - LC = -1.00 dBi) 16QAM			
Bandwidth	5M		
Channel	20775	21100	21425
	(Low)	(Mid)	(High)
Frequency (MHz)	2502.5	2535	2567.5
	Conducted Power (dBm)	22.47	22.31
Conducted Power (Watts)	0.1766	0.1702	0.1746
EIRP(dBm)	21.47	21.31	21.42
EIRP(Watts)	0.1403	0.1352	0.1387

LTE Band 7 (GT - LC = -1.00 dBi) 16QAM									
Bandwidth	10M			15M			20M		
Channel	20800	21100	21400	20825	21100	21375	20850	21100	21350
	(Low)	(Mid)	(High)	(Low)	(Mid)	(High)	(Low)	(Mid)	(High)
Frequency (MHz)	2505	2535	2565	2507.5	2535	2562.5	2510	2535	2560
	Conducted Power (dBm)	22.49	22.42	22.41	22.39	22.21	22.28	22.46	22.41
Conducted Power (Watts)	0.1774	0.1746	0.1742	0.1734	0.1663	0.1690	0.1762	0.1742	0.1758
EIRP(dBm)	21.49	21.42	21.41	21.39	21.21	21.28	21.46	21.41	21.45
EIRP(Watts)	0.1409	0.1387	0.1384	0.1377	0.1321	0.1343	0.1400	0.1384	0.1396



LTE Band 7 (G _T - L _C = -1.00 dBi) 64QAM			
Bandwidth	5M		
Channel	20775	21100	21425
	(Low)	(Mid)	(High)
Frequency (MHz)	2502.5	2535	2567.5
	Conducted Power (dBm)	21.40	21.25
Conducted Power (Watts)	0.1380	0.1334	0.1352
EIRP(dBm)	20.40	20.25	20.31
EIRP(Watts)	0.1096	0.1059	0.1074

LTE Band 7 (G _T - L _C = -1.00 dBi) 64QAM									
Bandwidth	10M			15M			20M		
Channel	20800	21100	21400	20825	21100	21375	20850	21100	21350
	(Low)	(Mid)	(High)	(Low)	(Mid)	(High)	(Low)	(Mid)	(High)
Frequency (MHz)	2505	2535	2565	2507.5	2535	2562.5	2510	2535	2560
	Conducted Power (dBm)	21.49	21.35	21.33	21.30	21.27	21.30	21.37	21.16
Conducted Power (Watts)	0.1409	0.1365	0.1358	0.1349	0.1340	0.1349	0.1371	0.1306	0.1343
EIRP(dBm)	20.49	20.35	20.33	20.30	20.27	20.30	20.37	20.16	20.28
EIRP(Watts)	0.1119	0.1084	0.1079	0.1072	0.1064	0.1072	0.1089	0.1038	0.1067



LTE Band 66 (GT - LC = 0.9 dBi) QPSK									
Bandwidth	1.4M			3M			5M		
Channel	131979	132322	132665	131987	132322	132657	131997	132322	132647
	(Low)	(Mid)	(High)	(Low)	(Mid)	(High)	(Low)	(Mid)	(High)
Frequency (MHz)	1710.7	1745	1779.3	1711.5	1745	1778.5	1712.5	1745	1777.5
Conducted Power (dBm)	23.24	23.05	22.86	23.09	22.91	22.83	23.26	23.01	23.02
Conducted Power (Watts)	0.2109	0.2018	0.1932	0.2037	0.1954	0.1919	0.2118	0.2000	0.2004
EIRP(dBm)	24.14	23.95	23.76	23.99	23.81	23.73	24.16	23.91	23.92
EIRP(Watts)	0.2594	0.2483	0.2377	0.2506	0.2404	0.2360	0.2606	0.2460	0.2466

LTE Band 66 (GT - LC = 0.9 dBi) QPSK									
Bandwidth	10M			15M			20M		
Channel	132022	132322	132622	132047	132322	132597	132072	132322	132572
	(Low)	(Mid)	(High)	(Low)	(Mid)	(High)	(Low)	(Mid)	(Mid)
Frequency (MHz)	1715	1745	1775	1717.5	1745	1772.5	1720	1745	1770
Conducted Power (dBm)	22.96	22.79	22.74	23.20	23.24	23.19	23.04	23.30	23.18
Conducted Power (Watts)	0.1977	0.1901	0.1879	0.2089	0.2109	0.2084	0.2014	0.2138	0.2080
EIRP(dBm)	23.86	23.69	23.64	24.10	24.14	24.09	23.94	24.20	24.08
EIRP(Watts)	0.2432	0.2339	0.2312	0.2570	0.2594	0.2564	0.2477	0.2630	0.2559



LTE Band 66 (GT - LC = 0.9 dBi) 16QAM									
Bandwidth	1.4M			3M			5M		
Channel	131979	132322	132665	131987	132322	132657	131997	132322	132647
	(Low)	(Mid)	(High)	(Low)	(Mid)	(High)	(Low)	(Mid)	(High)
Frequency (MHz)	1710.7	1745	1779.3	1711.5	1745	1778.5	1712.5	1745	1777.5
Conducted Power (dBm)	22.48	22.37	22.17	22.34	22.45	22.28	22.50	22.30	22.22
Conducted Power (Watts)	0.1770	0.1726	0.1648	0.1714	0.1758	0.1690	0.1778	0.1698	0.1667
EIRP(dBm)	23.38	23.27	23.07	23.24	23.35	23.18	23.40	23.20	23.12
EIRP(Watts)	0.2178	0.2123	0.2028	0.2109	0.2163	0.2080	0.2188	0.2089	0.2051

LTE Band 66 (GT - LC = 0.9 dBi) 16QAM									
Bandwidth	10M			15M			20M		
Channel	132022	132322	132622	132047	132322	132597	132072	132322	132572
	(Low)	(Mid)	(High)	(Low)	(Mid)	(High)	(Low)	(Mid)	(Mid)
Frequency (MHz)	1715	1745	1775	1717.5	1745	1772.5	1720	1745	1770
Conducted Power (dBm)	22.40	22.45	22.42	22.43	22.50	22.36	22.45	22.50	22.50
Conducted Power (Watts)	0.1738	0.1758	0.1746	0.1750	0.1778	0.1722	0.1758	0.1778	0.1778
EIRP(dBm)	23.30	23.35	23.32	23.33	23.40	23.26	23.35	23.40	23.40
EIRP(Watts)	0.2138	0.2163	0.2148	0.2153	0.2188	0.2118	0.2163	0.2188	0.2188



LTE Band 66 (GT - LC = 0.9 dBi) 64QAM									
Bandwidth	1.4M			3M			5M		
Channel	131979	132322	132665	131987	132322	132657	131997	132322	132647
	(Low)	(Mid)	(High)	(Low)	(Mid)	(High)	(Low)	(Mid)	(High)
Frequency (MHz)	1710.7	1745	1779.3	1711.5	1745	1778.5	1712.5	1745	1777.5
Conducted Power (dBm)	21.23	21.35	20.98	21.26	21.42	20.96	21.50	21.19	21.22
Conducted Power (Watts)	0.1327	0.1365	0.1253	0.1337	0.1387	0.1247	0.1413	0.1315	0.1324
EIRP(dBm)	22.13	22.25	21.88	22.16	22.32	21.86	22.40	22.09	22.12
EIRP(Watts)	0.1633	0.1679	0.1542	0.1644	0.1706	0.1535	0.1738	0.1618	0.1629

LTE Band 66 (GT - LC = 0.9 dBi) 64QAM									
Bandwidth	10M			15M			20M		
Channel	132022	132322	132622	132047	132322	132597	132072	132322	132572
	(Low)	(Mid)	(High)	(Low)	(Mid)	(High)	(Low)	(Mid)	(Mid)
Frequency (MHz)	1715	1745	1775	1717.5	1745	1772.5	1720	1745	1770
Conducted Power (dBm)	21.71	21.78	21.58	21.67	21.82	21.68	21.48	21.44	21.37
Conducted Power (Watts)	0.1483	0.1507	0.1439	0.1469	0.1521	0.1472	0.1406	0.1393	0.1371
EIRP(dBm)	22.61	22.68	22.48	22.57	22.72	22.58	22.38	22.34	22.27
EIRP(Watts)	0.1824	0.1854	0.1770	0.1807	0.1871	0.1811	0.1730	0.1714	0.1687



Peak-to-Average Ratio

Mode	LTE Band 2 / 20MHz				
Mod.	QPSK		16QAM		Limit: 13dB
RB Size	1RB	Full RB	1RB	Full RB	Result
Lowest CH	4.84	5.16	5.83	6.09	PASS
Middle CH	4.55	5.01	5.3	6.14	
Highest CH	4.67	4.93	5.65	5.94	

Mode	LTE Band 2 / 20MHz			
Mod.	64QAM		Limit: 13dB	
RB Size	1RB	Full RB	Result	
Lowest CH	5.51	6.09	PASS	
Middle CH	5.13	6.09		
Highest CH	5.62	5.94		

Mode	LTE Band 5 / 10MHz				
Mod.	QPSK		16QAM		Limit: 13dB
RB Size	1RB	Full RB	1RB	Full RB	Result
Lowest CH	4.38	5.04	5.39	5.97	PASS
Middle CH	4.64	5.07	5.39	5.97	
Highest CH	4.43	5.1	5.01	5.91	

Mod.	64QAM		Limit: 13dB	
RB Size	1RB	Full RB	Result	
Lowest CH	5.07	5.94	PASS	
Middle CH	5.68	5.94		
Highest CH	5.36	5.97		



Mode	LTE Band 7 / 20MHz				
Mod.	QPSK		16QAM		Limit: 13dB
RB Size	1RB	Full RB	1RB	Full RB	Result
Lowest CH	3.25	4.7	4.17	5.71	PASS
Middle CH	3.33	4.67	4	5.62	
Highest CH	3.42	4.61	4.17	5.65	
Mod.	64QAM		Limit: 13dB		
RB Size	1RB	Full RB	Result		
Lowest CH	4.2	5.59	PASS		
Middle CH	4.14	5.54			
Highest CH	4.23	5.59			

Mode	LTE Band 66 / 20MHz				
Mod.	QPSK		16QAM		Limit: 13dB
RB Size	1RB	Full RB	1RB	Full RB	Result
Lowest CH	4.75	4.9	5.33	5.94	PASS
Middle CH	4.78	4.96	5.8	6	
Highest CH	4.72	5.13	5.3	6.09	
Mode	LTE Band 2 / 20MHz				
Mod.	64QAM		Limit: 13dB		
RB Size	1RB	Full RB	Result		
Lowest CH	6.58	6.55	PASS		
Middle CH	6.81	6.61			
Highest CH	6.46	6.64			



LTE Band 2 / 20MHz / QPSK

Lowest Channel / 1RB

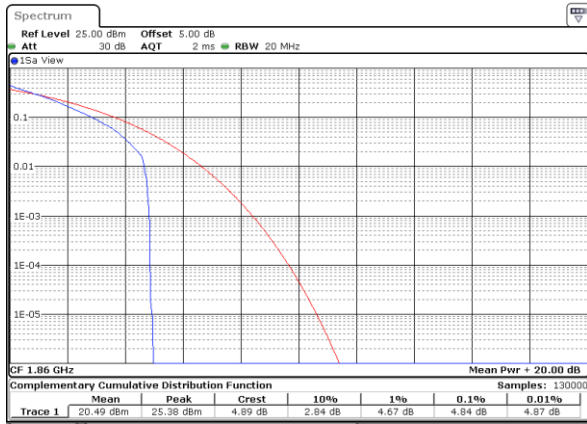

Date: 16 SEP 2018 11:24:33

Lowest Channel / Full RB

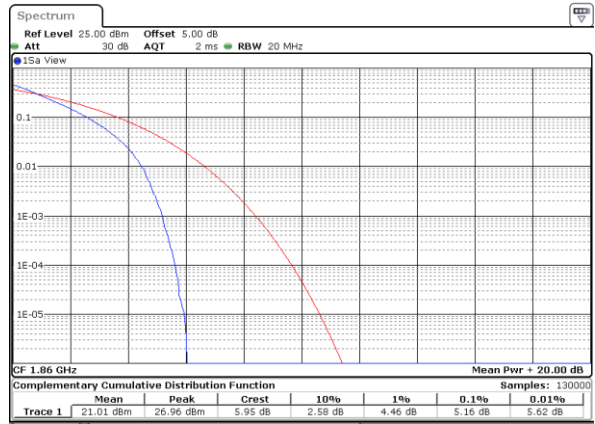

Date: 16 SEP 2018 11:24:46

Middle Channel / 1RB

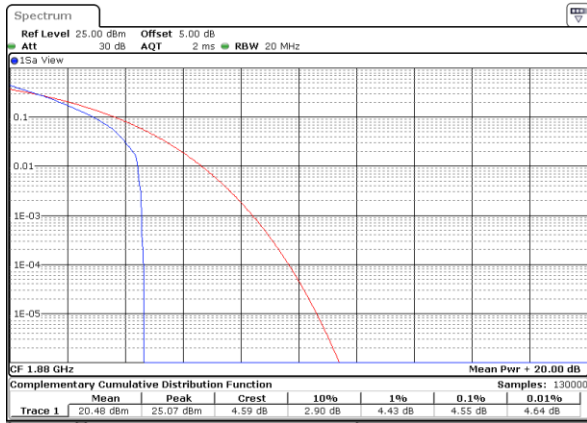

Date: 16 SEP 2018 11:25:37

Middle Channel / Full RB

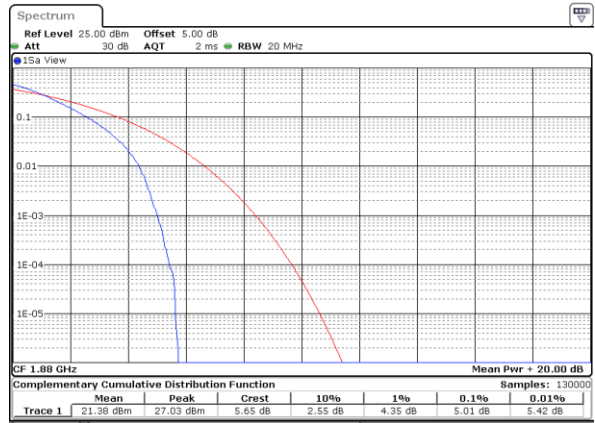

Date: 16 SEP 2018 11:25:23

Highest Channel / 1RB



Date: 16 SEP 2018 11:26:16

Highest Channel / Full RB



Date: 16 SEP 2018 11:26:30



LTE Band 2 / 20MHz / 16QAM

Lowest Channel / 1RB



Date: 16 SEP 2018 10:24:36

Lowest Channel / Full RB

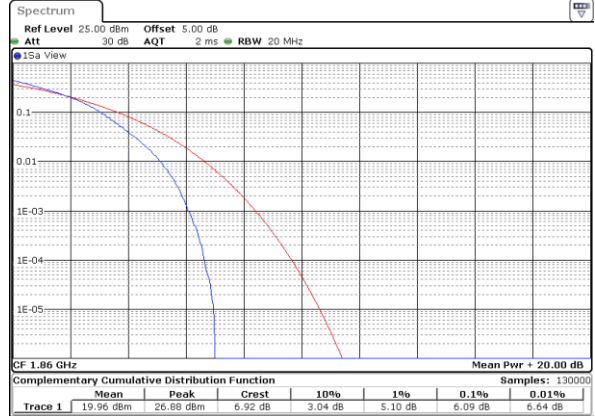

Date: 16 SEP 2018 10:24:45

Middle Channel / 1RB



Date: 16 SEP 2018 10:24:54

Middle Channel / Full RB

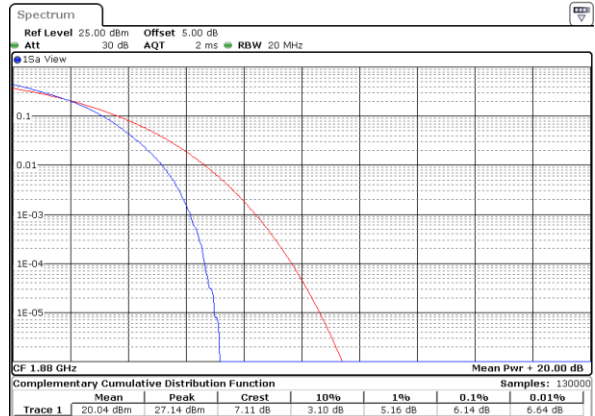

Date: 16 SEP 2018 10:25:03

Highest Channel / 1RB



Date: 16 SEP 2018 10:25:13

Highest Channel / Full RB

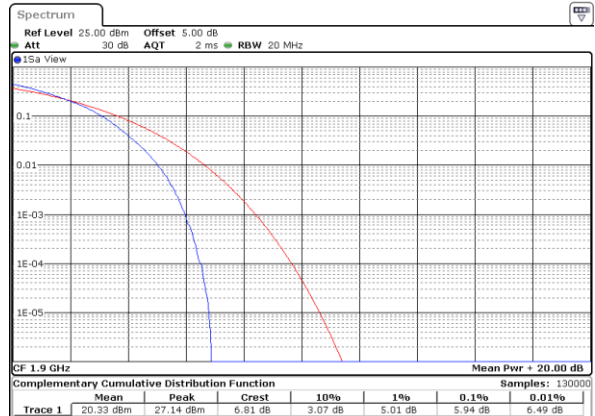

Date: 16 SEP 2018 10:25:22



LTE Band 2 / 20MHz / 64QAM

Lowest Channel / 1RB

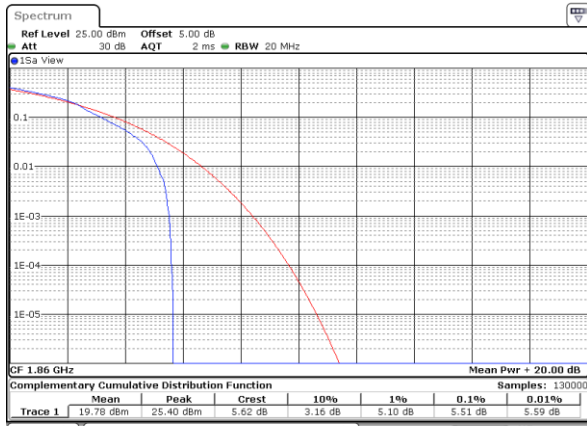

Date: 16 SEP 2018 11:24:17

Lowest Channel / Full RB

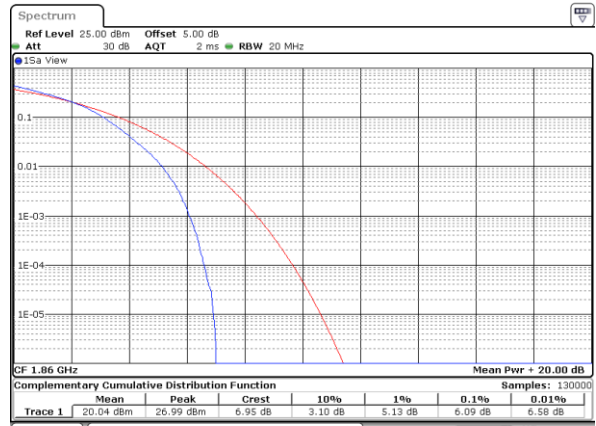

Date: 16 SEP 2018 11:31:47

Middle Channel / 1RB

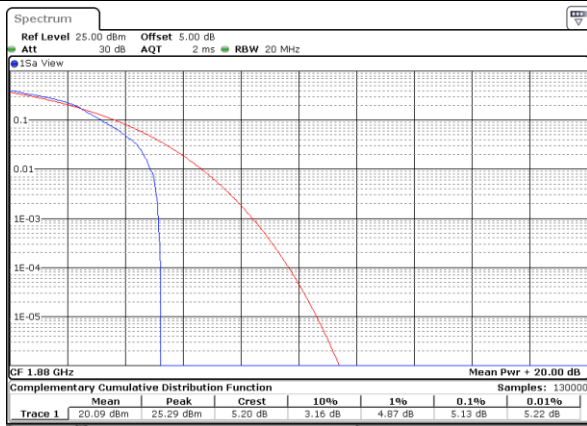

Date: 16 SEP 2018 11:25:51

Middle Channel / Full RB



Date: 16 SEP 2018 11:25:10

Highest Channel / 1RB



Date: 16 SEP 2018 11:26:05

Highest Channel / Full RB

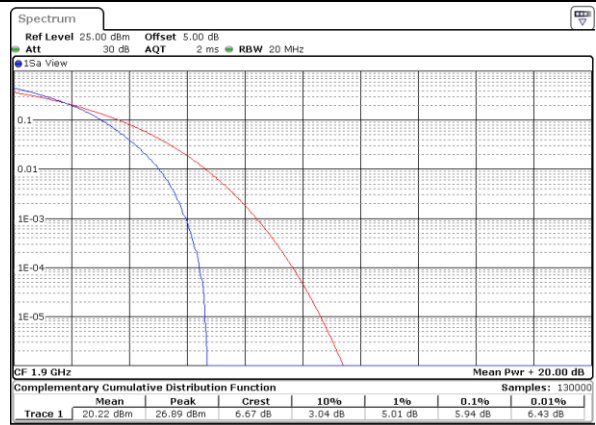

Date: 16 SEP 2018 11:32:11



LTE Band 5 / 10MHz / QPSK

Lowest Channel / 1RB

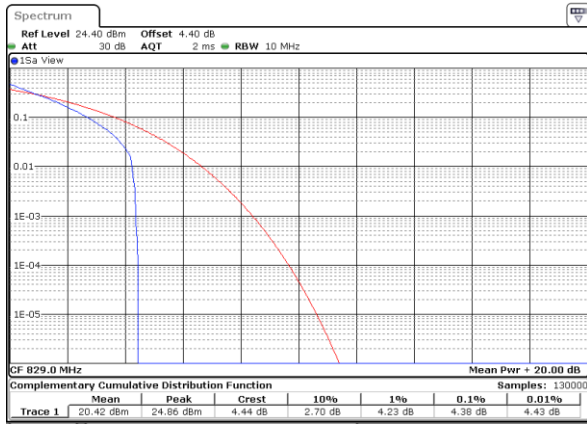

Date: 16 SEP 2018 16:02:14

Lowest Channel / Full RB

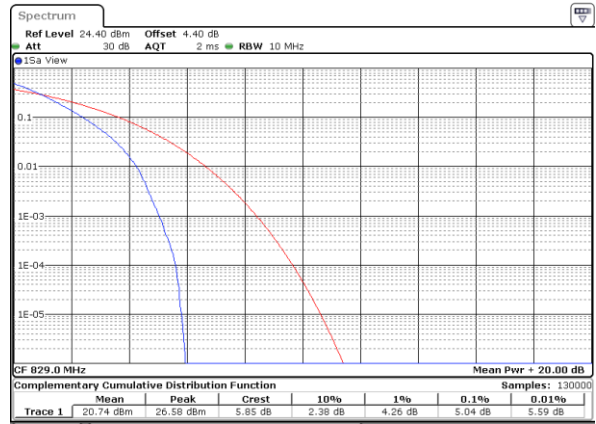

Date: 16 SEP 2018 16:07:20

Middle Channel / 1RB

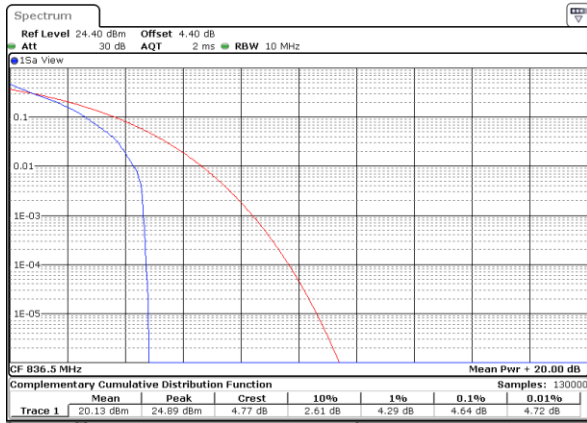

Date: 16 SEP 2018 16:07:39

Middle Channel / Full RB

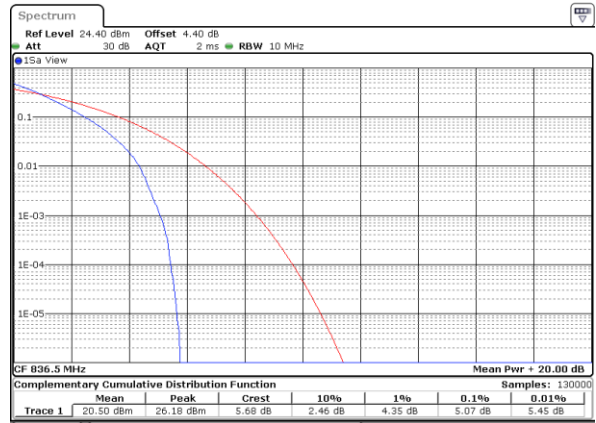

Date: 16 SEP 2018 16:07:59

Highest Channel / 1RB

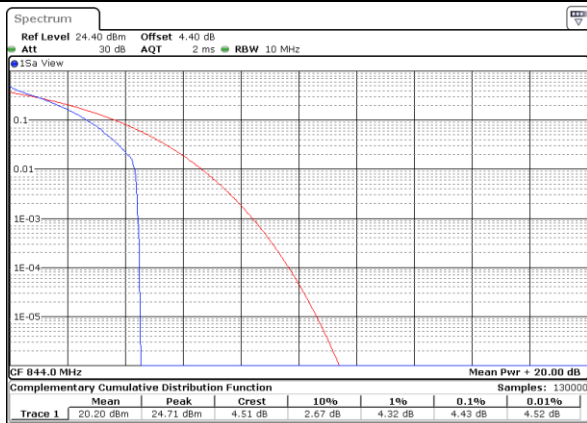

Date: 16 SEP 2018 16:08:17

Highest Channel / Full RB

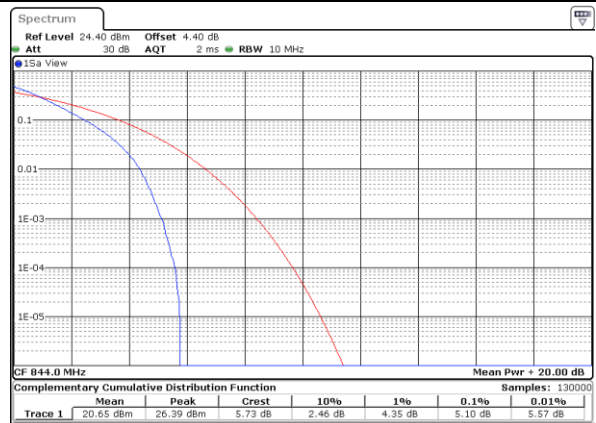

Date: 16 SEP 2018 16:08:36



LTE Band 5 / 10MHz / 16QAM

Lowest Channel / 1RB

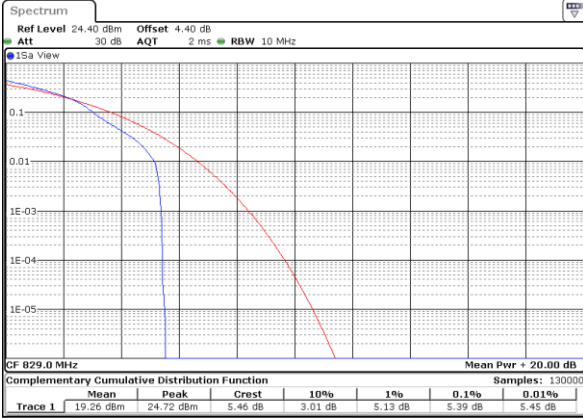

Date: 16 SEP 2018 15:01:20

Lowest Channel / Full RB

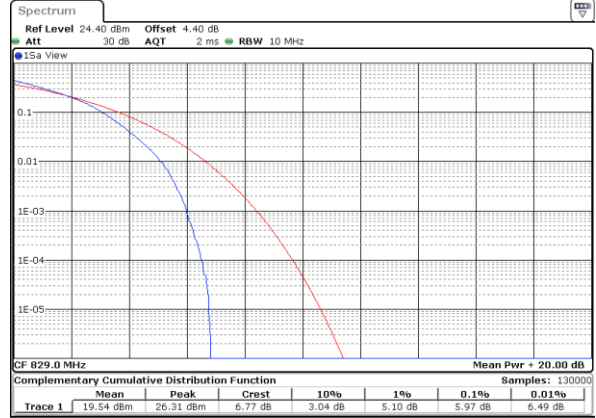

Date: 16 SEP 2018 15:01:33

Middle Channel / 1RB

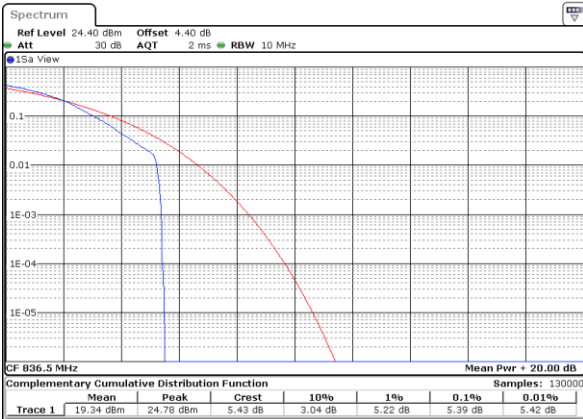

Date: 16 SEP 2018 15:01:42

Middle Channel / Full RB

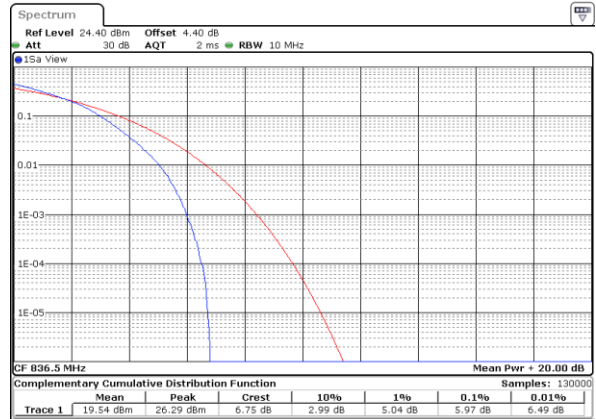

Date: 16 SEP 2018 15:01:53

Highest Channel / 1RB

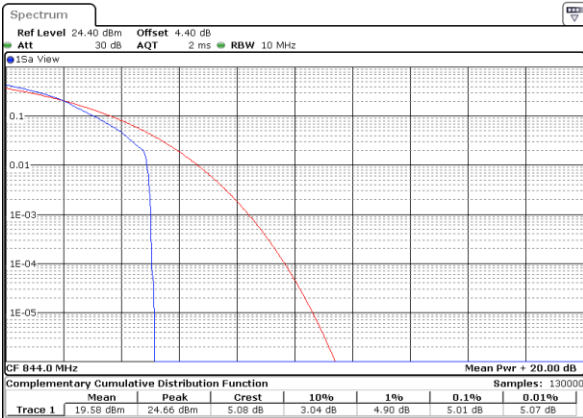

Date: 16 SEP 2018 15:05:04

Highest Channel / Full RB

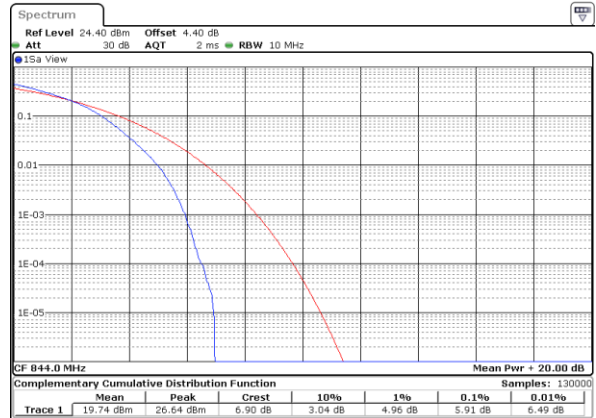

Date: 16 SEP 2018 15:05:13



LTE Band 5 / 10MHz / 64QAM

Lowest Channel / 1RB

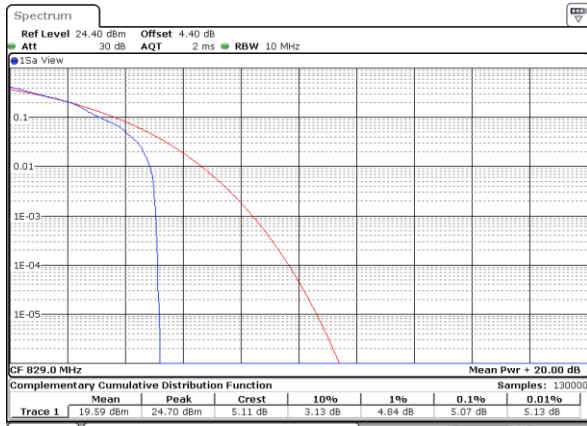

Date: 16 SEP 2018 16:02:25

Lowest Channel / Full RB

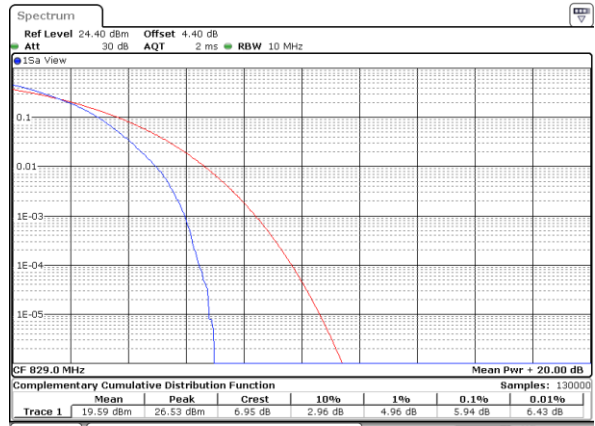

Date: 16 SEP 2018 16:07:29

Middle Channel / 1RB

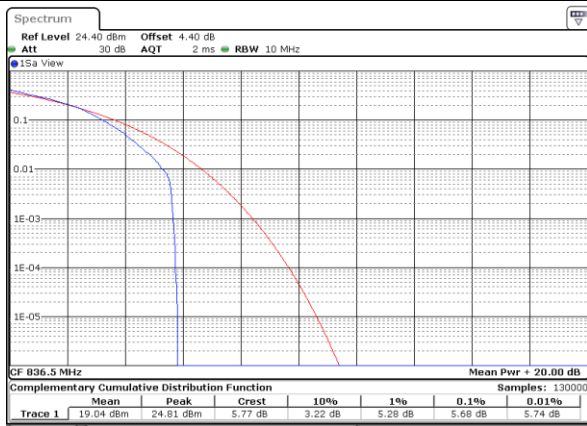

Date: 16 SEP 2018 16:07:49

Middle Channel / Full RB



Date: 16 SEP 2018 16:08:08

Highest Channel / 1RB

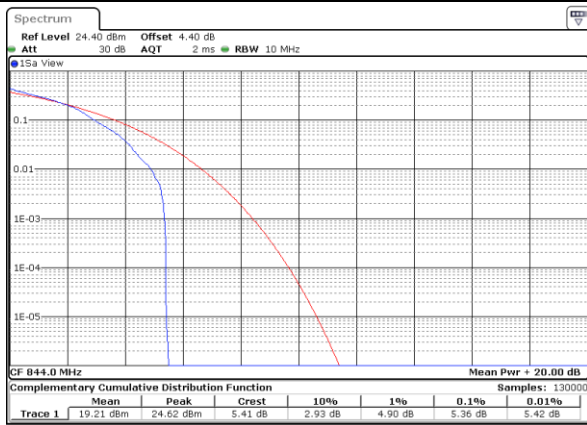

Date: 16 SEP 2018 16:08:26

Highest Channel / Full RB

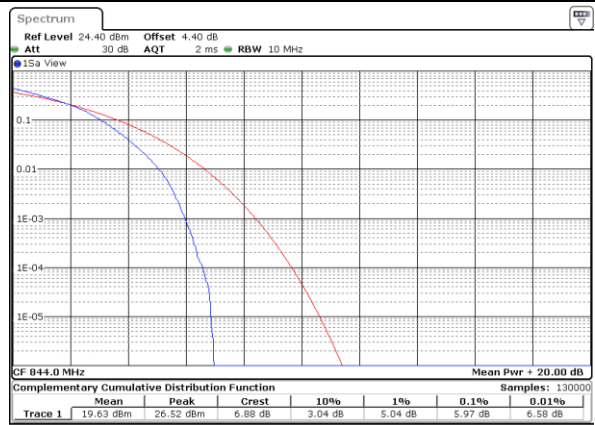

Date: 16 SEP 2018 16:09:04



LTE Band 7 / 20MHz / QPSK

Lowest Channel / 1RB

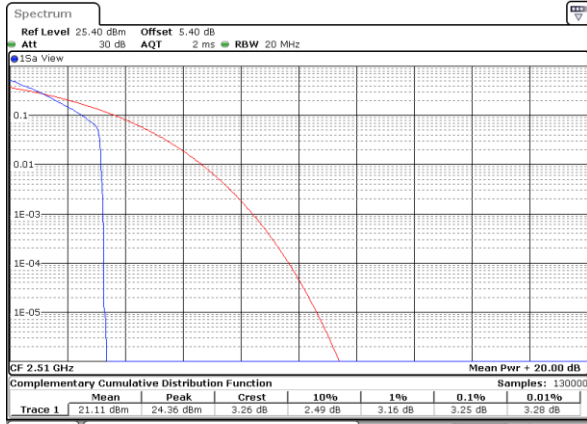

Date: 19 SEP 2018 09:43:02

Lowest Channel / Full RB

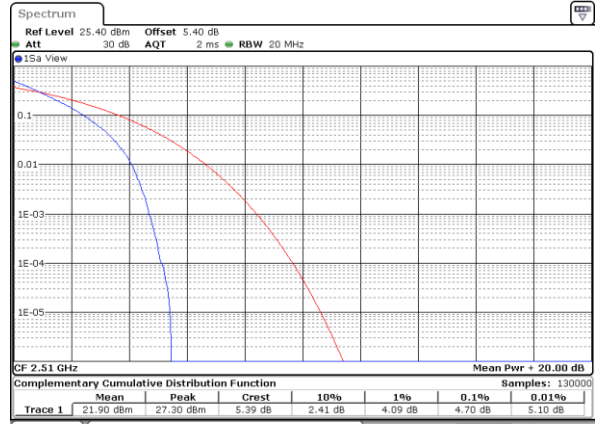

Date: 19 SEP 2018 09:43:30

Middle Channel / 1RB

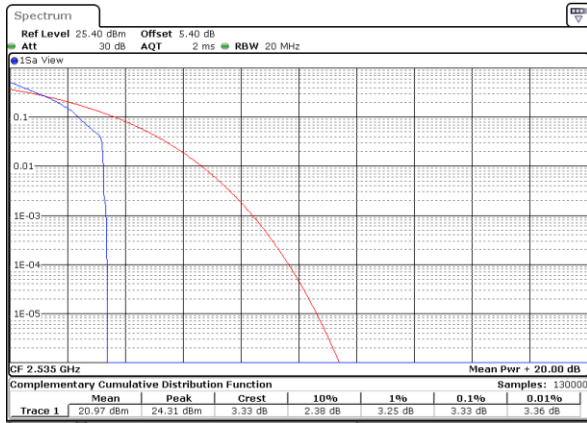

Date: 19 SEP 2018 09:44:09

Middle Channel / Full RB

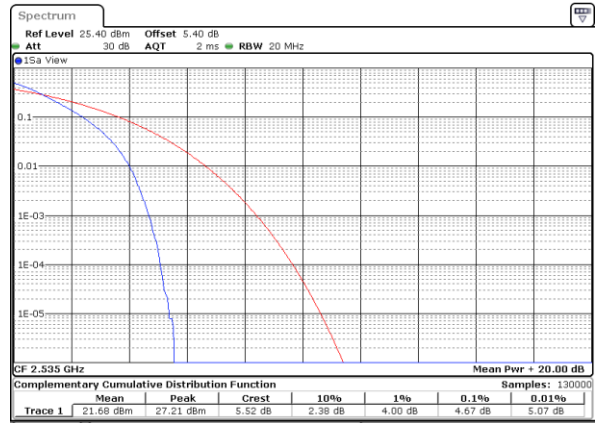

Date: 19 SEP 2018 09:43:39

Highest Channel / 1RB

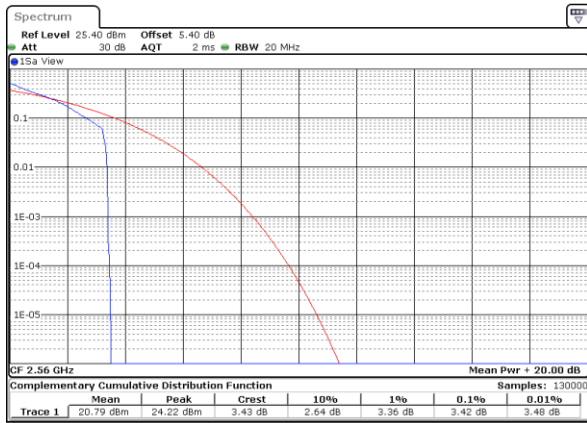

Date: 19 SEP 2018 09:44:18

Highest Channel / Full RB

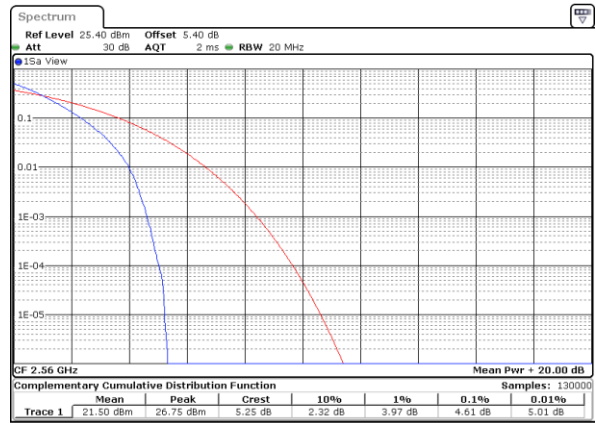

Date: 19 SEP 2018 09:44:46



LTE Band 7 / 20MHz / 16QAM

Lowest Channel / 1RB

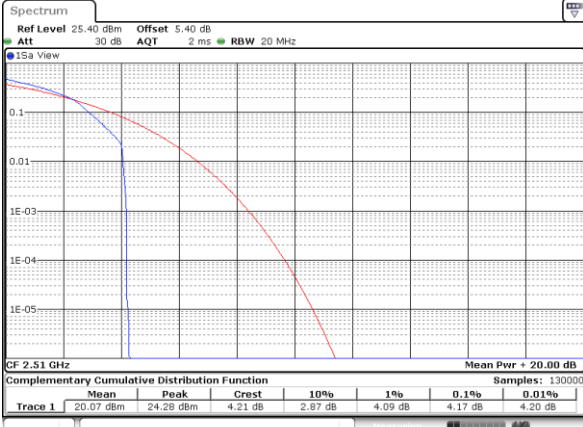

Date: 19 SEP 2018 09:43:12

Lowest Channel / Full RB

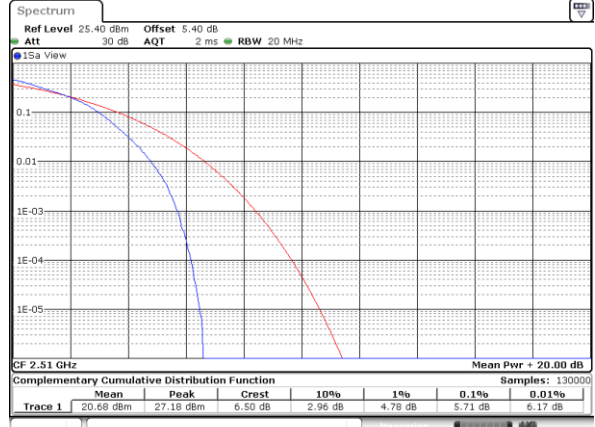

Date: 19 SEP 2018 09:43:20

Middle Channel / 1RB

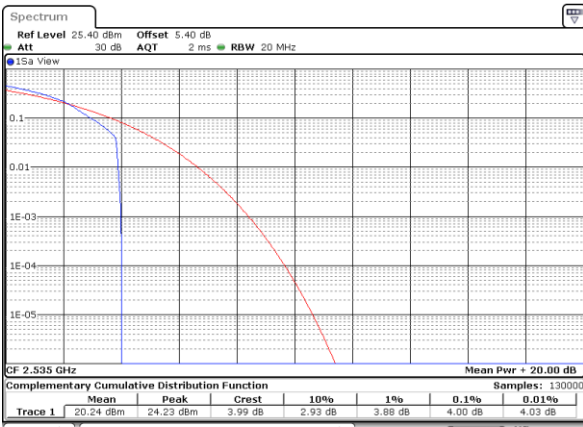

Date: 19 SEP 2018 09:44:00

Middle Channel / Full RB

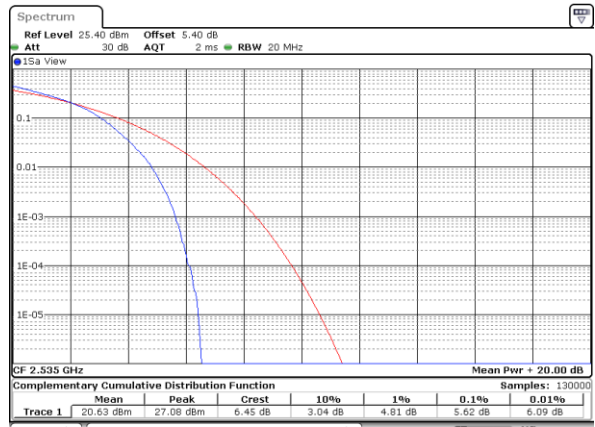

Date: 19 SEP 2018 09:43:51

Highest Channel / 1RB

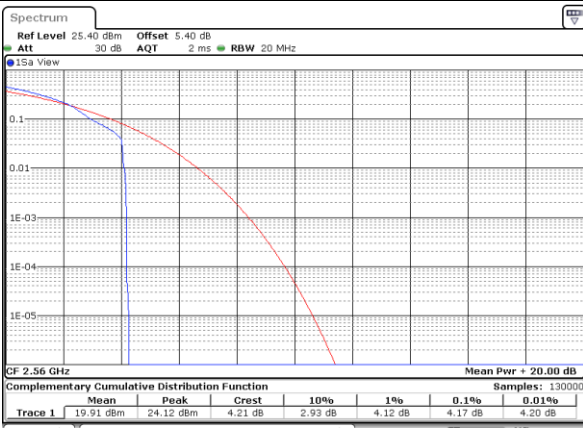

Date: 19 SEP 2018 09:44:27

Highest Channel / Full RB

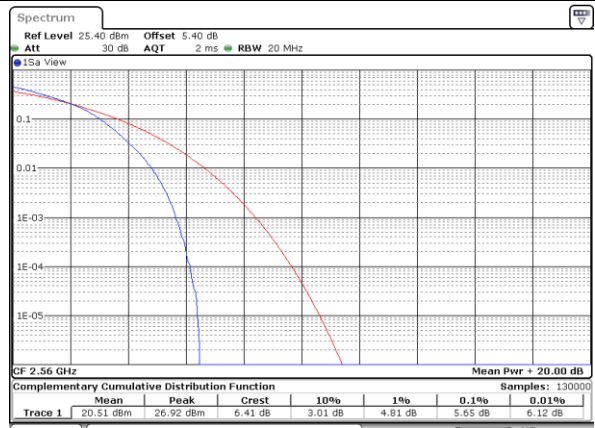

Date: 19 SEP 2018 09:44:36



LTE Band 7 / 20MHz / 64QAM

Lowest Channel / 1RB

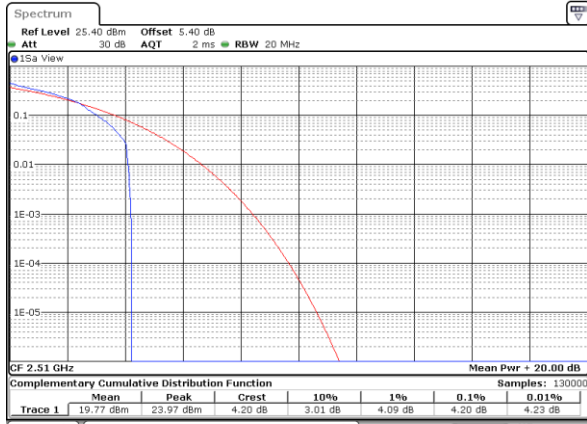

Date: 19 SEP 2018 10:02:03

Lowest Channel / Full RB

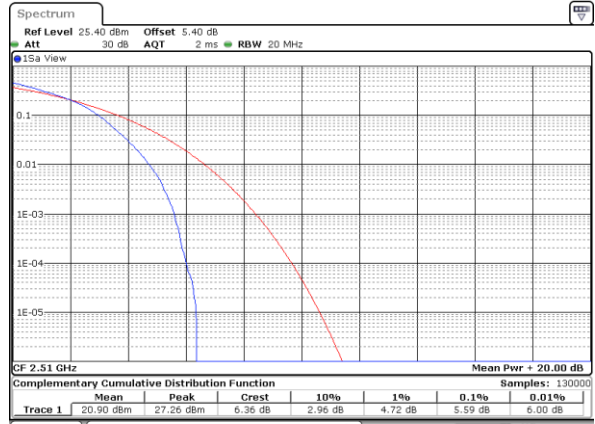

Date: 19 SEP 2018 10:02:12

Middle Channel / 1RB

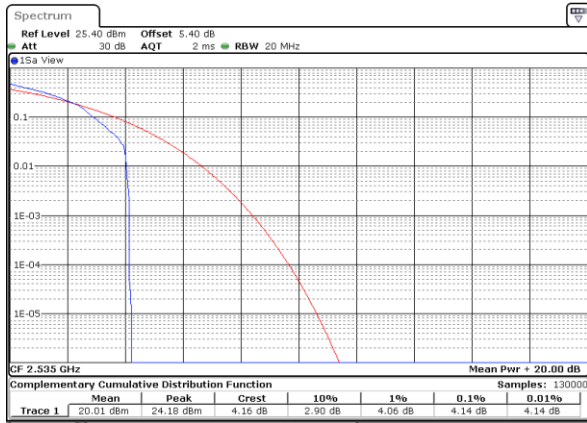

Date: 19 SEP 2018 10:02:31

Middle Channel / Full RB

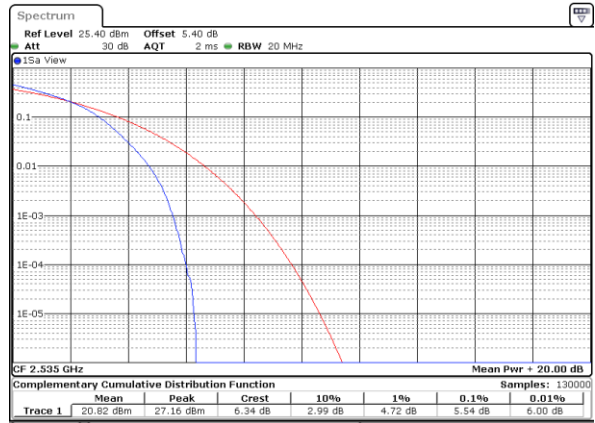

Date: 19 SEP 2018 10:02:22

Highest Channel / 1RB



Date: 19 SEP 2018 10:02:40

Highest Channel / Full RB



Date: 19 SEP 2018 10:02:49



LTE Band 66 / 20MHz / QPSK

Lowest Channel / 1RB

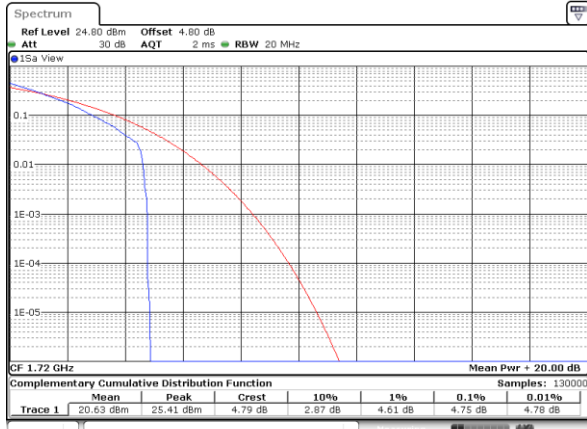

Date: 19 SEP 2018 15:10:25

Lowest Channel / Full RB

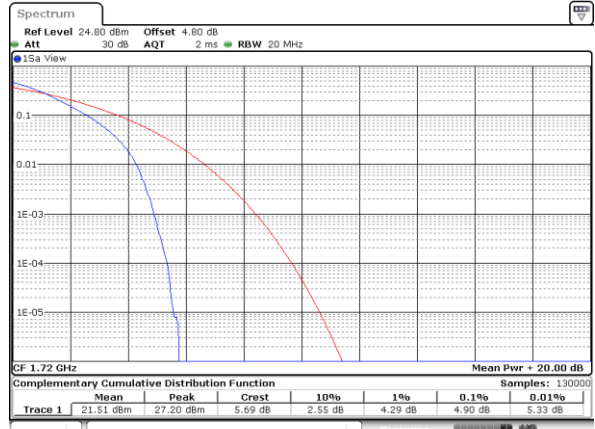

Date: 19 SEP 2018 15:11:46

Middle Channel / 1RB

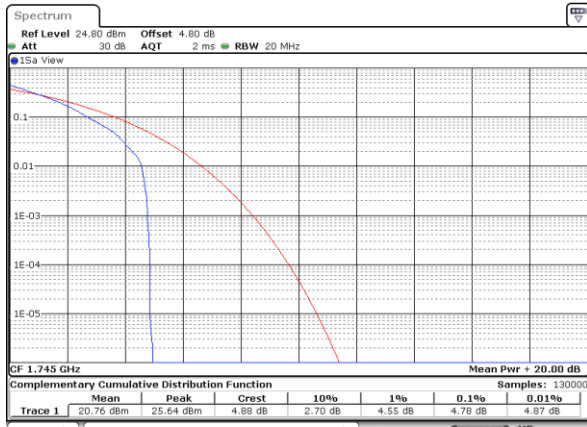

Date: 19 SEP 2018 15:09:50

Middle Channel / Full RB

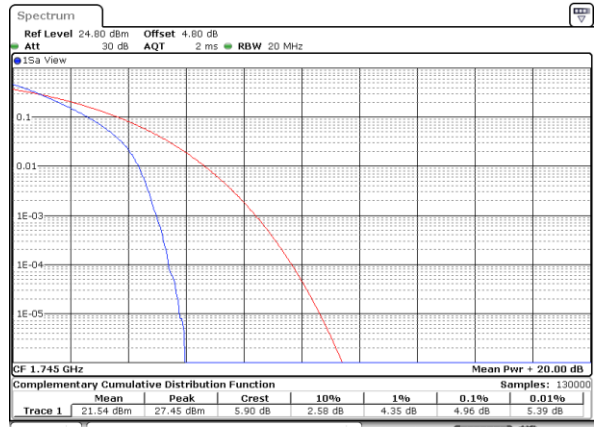

Date: 19 SEP 2018 15:08:43

Highest Channel / 1RB

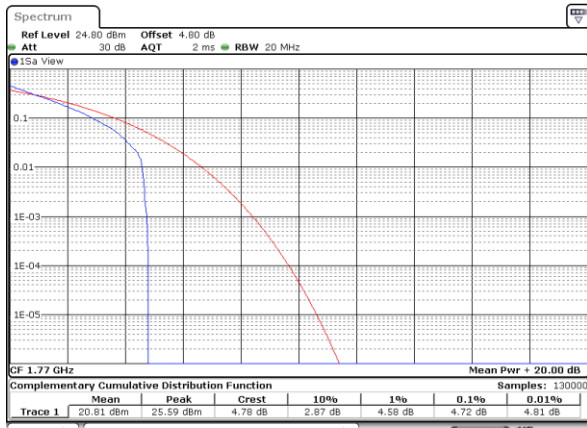

Date: 19 SEP 2018 15:07:10

Highest Channel / Full RB

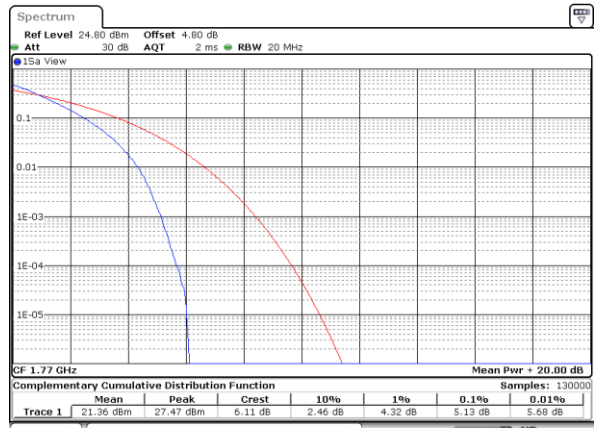

Date: 19 SEP 2018 15:08:12



LTE Band 66 / 20MHz / 16QAM

Lowest Channel / 1RB

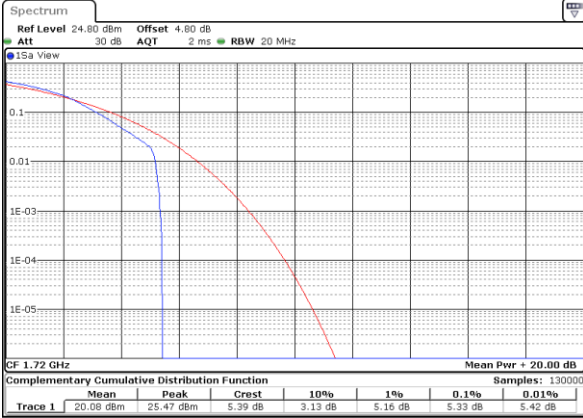

Date: 19 SEP 2018 15:10:51

Lowest Channel / Full RB

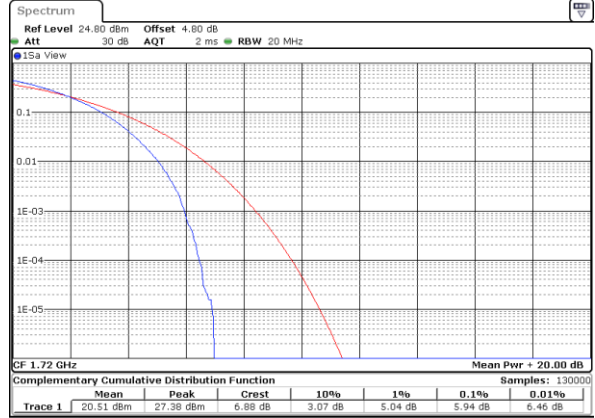

Date: 19 SEP 2018 15:11:34

Middle Channel / 1RB

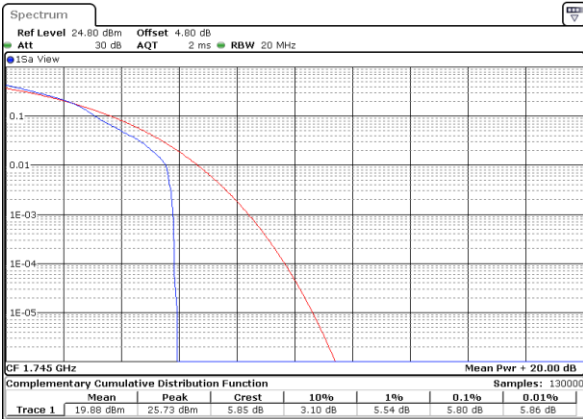

Date: 19 SEP 2018 15:09:40

Middle Channel / Full RB

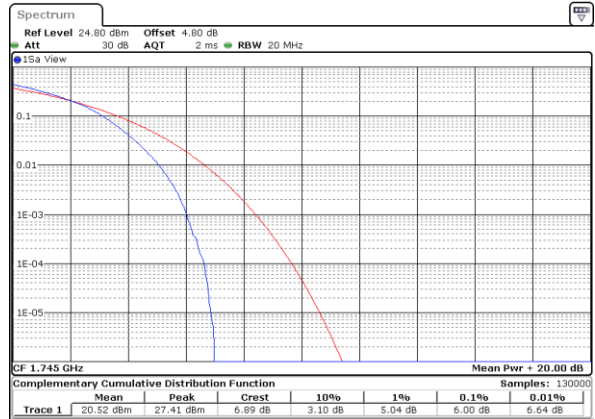

Date: 19 SEP 2018 15:08:55

Highest Channel / 1RB

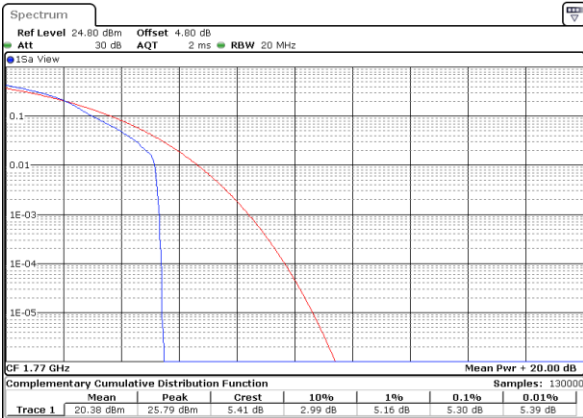

Date: 19 SEP 2018 15:07:25

Highest Channel / Full RB

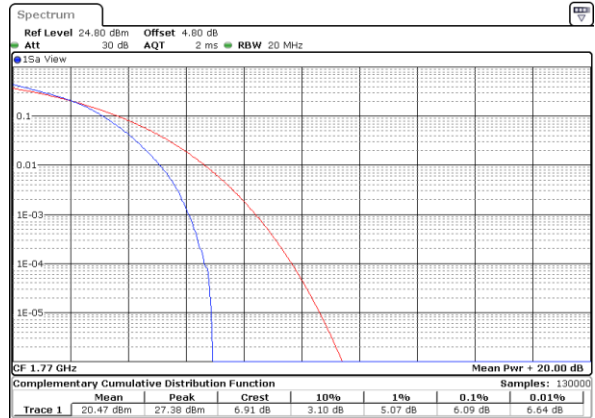

Date: 19 SEP 2018 15:08:02



LTE Band 2 / 20MHz / 64QAM

Lowest Channel / 1RB

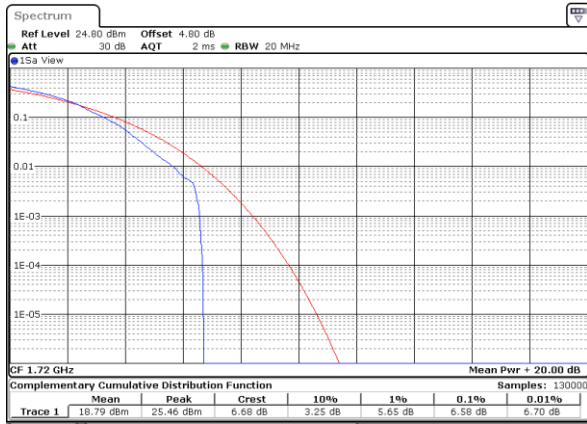

Date: 19 SEP 2018 15:11:06

Lowest Channel / Full RB

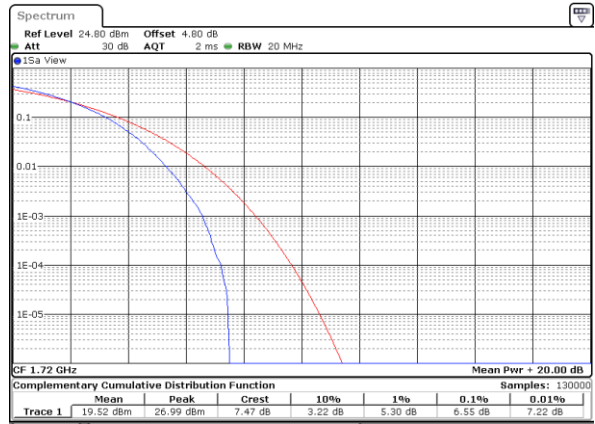

Date: 19 SEP 2018 15:11:20

Middle Channel / 1RB

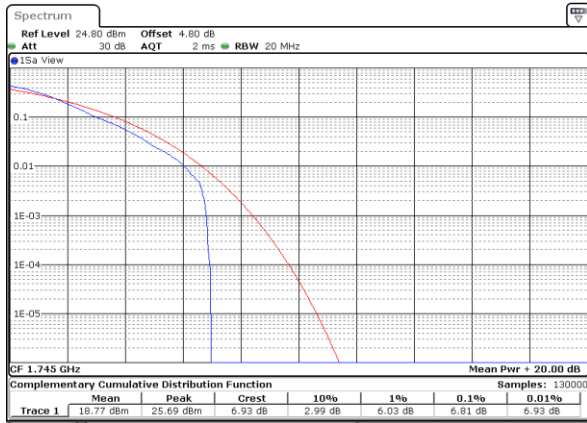

Date: 19 SEP 2018 15:09:30

Middle Channel / Full RB



Date: 19 SEP 2018 15:09:17

Highest Channel / 1RB



Date: 19 SEP 2018 15:07:35

Highest Channel / Full RB



Date: 19 SEP 2018 15:07:50



26dB Bandwidth

Mode	LTE Band 2 : 26dB BW(MHz)											
BW	1.4MHz		3MHz		5MHz		10MHz		15MHz		20MHz	
Mod.	QPSK	16QAM	QPSK	16QAM	QPSK	16QAM	QPSK	16QAM	QPSK	16QAM	QPSK	16QAM
Lowest CH	1.228	1.276	3.033	3.039	4.805	4.865	9.95	9.85	14.476	14.535	20.18	20.18
Middle CH	1.259	1.253	2.967	2.973	4.925	4.915	9.73	10.03	14.266	14.625	20.26	20.18
Highest CH	1.262	1.262	3.015	2.997	4.965	4.885	10.03	9.85	14.505	14.296	20.14	20.1
Mode	LTE Band 2 : 26dB BW(MHz)											
BW	1.4MHz		3MHz		5MHz		10MHz		15MHz		20MHz	
Mod.	64QAM		64QAM		64QAM		64QAM		64QAM		64QAM	
Lowest CH	1.262		2.955		4.925		9.850		14.356		20.140	
Middle CH	1.278		3.027		4.885		9.930		14.535		20.260	
Highest CH	1.276		3.015		4.865		9.690		14.535		20.220	

Mode	LTE Band 5 : 26dB BW(MHz)											
BW	1.4MHz		3MHz		5MHz		10MHz		15MHz		20MHz	
Mod.	QPSK	16QAM	QPSK	16QAM	QPSK	16QAM	QPSK	16QAM	QPSK	16QAM	QPSK	16QAM
Lowest CH	1.309	1.284	3.021	2.991	4.825	4.855	9.69	9.79	-	-	-	-
Middle CH	1.295	1.256	3.009	3.021	4.895	4.815	9.81	9.83	-	-	-	-
Highest CH	1.287	1.262	3.027	3.015	4.965	4.885	9.71	9.69	-	-	-	-
Mode	LTE Band 5 : 26dB BW(MHz)											
BW	1.4MHz		3MHz		5MHz		10MHz		-		-	
Mod.	64QAM		64QAM		64QAM		64QAM		-		-	
Lowest CH	1.281		3.051		4.975		9.850		-		-	
Middle CH	1.264		2.973		4.925		9.830		-		-	
Highest CH	1.278		3.003		4.925		9.850		-		-	



LTE Band 7 : 26dB BW(MHz)												
Mode	LTE Band 7 : 26dB BW(MHz)											
BW	1.4MHz		3MHz		5MHz		10MHz		15MHz		20MHz	
Mod.	QPSK	16QAM	QPSK	16QAM	QPSK	16QAM	QPSK	16QAM	QPSK	16QAM	QPSK	16QAM
Lowest CH	-	-	-	-	4.965	4.965	9.81	9.91	14.176	14.535	20.18	20.18
Middle CH	-	-	-	-	4.865	4.865	9.93	9.87	14.416	14.476	20.22	20.06
Highest CH	-	-	-	-	4.855	4.925	9.87	9.87	14.505	14.565	20.5	20.18

LTE Band 7 : 26dB BW(MHz)												
Mode	LTE Band 7 : 26dB BW(MHz)											
BW	1.4MHz		3MHz		5MHz		10MHz		15MHz		20MHz	
Mod.					64QAM		64QAM		64QAM		64QAM	
Lowest CH	-	-	-	-	4.975		9.93		14.326		20.1	
Middle CH	-	-	-	-	4.915		9.91		14.446		20.06	
Highest CH	-	-	-	-	4.955		9.87		14.296		20.1	

LTE Band 66 : 26dB BW(MHz)												
Mode	LTE Band 66 : 26dB BW(MHz)											
BW	1.4MHz		3MHz		5MHz		10MHz		15MHz		20MHz	
Mod.	QPSK	16QAM	QPSK	16QAM	QPSK	16QAM	QPSK	16QAM	QPSK	16QAM	QPSK	16QAM
Lowest CH	1.281	1.259	2.985	2.997	4.855	4.895	9.85	9.91	14.356	14.146	20.14	20.06
Middle CH	1.309	1.292	3.027	3.009	4.945	4.905	9.77	9.77	14.386	14.146	20.14	20.22
Highest CH	1.264	1.284	3.009	3.051	4.925	4.935	9.67	9.91	14.416	14.236	20.26	20.3

LTE Band 66 : 26dB BW(MHz)												
Mode	LTE Band 66 : 26dB BW(MHz)											
BW	1.4MHz		3MHz		5MHz		10MHz		15MHz		20MHz	
Mod.	64QAM		64QAM		64QAM		64QAM		64QAM		64QAM	
Lowest CH	1.276		3.021		4.985		9.67		14.476		20.1	
Middle CH	1.281		2.991		4.875		9.93		14.236		20.14	
Highest CH	1.309		3.045		4.875		9.95		14.296		20.14	



LTE Band 2

Lowest Channel / 1.4MHz / QPSK

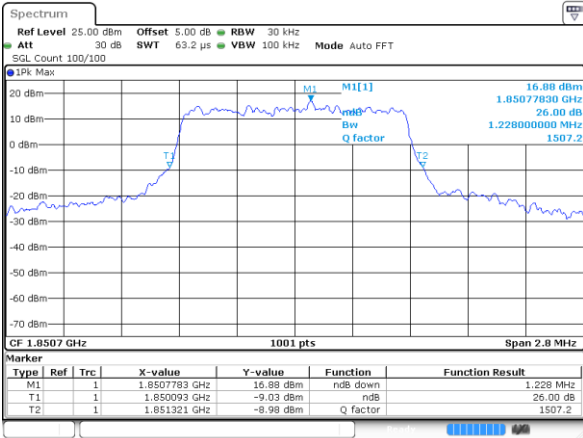

Date: 16 SEP 2018 08:27:18

Lowest Channel / 1.4MHz / 16QAM

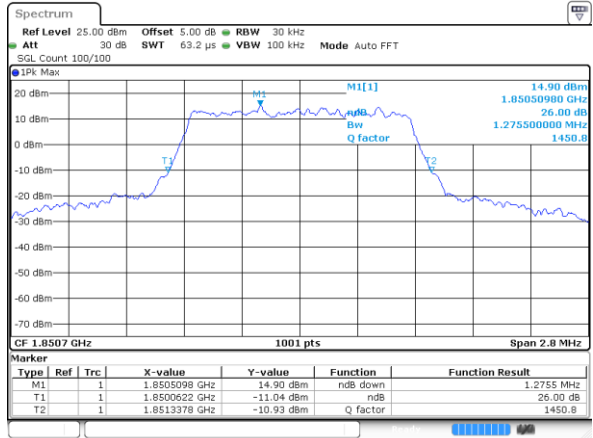

Date: 16 SEP 2018 08:27:29

Middle Channel / 1.4MHz / QPSK

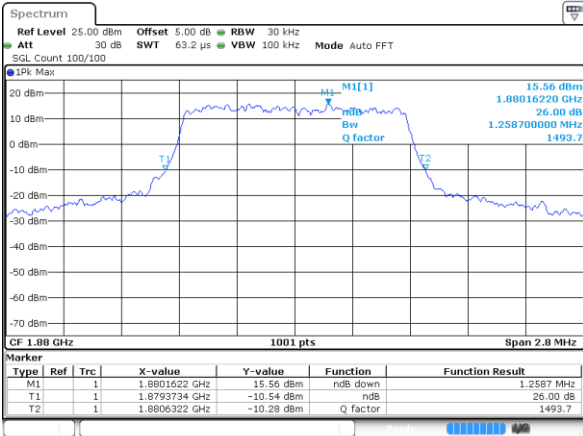

Date: 16 SEP 2018 08:34:26

Middle Channel / 1.4MHz / 16QAM

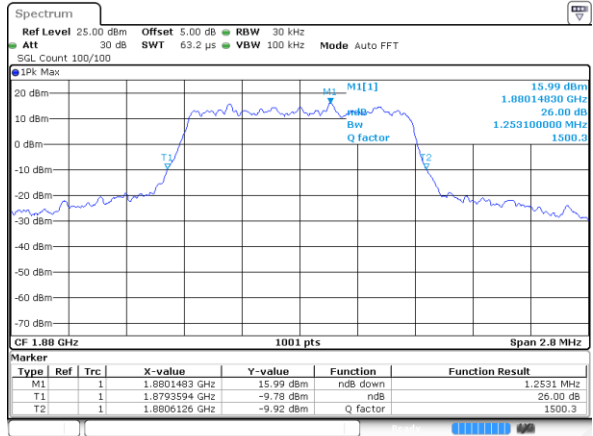

Date: 16 SEP 2018 08:34:37

Highest Channel / 1.4MHz / QPSK

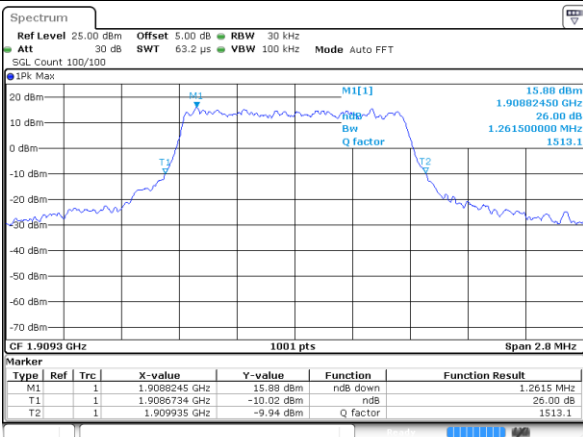

Date: 16 SEP 2018 08:37:01

Highest Channel / 1.4MHz / 16QAM

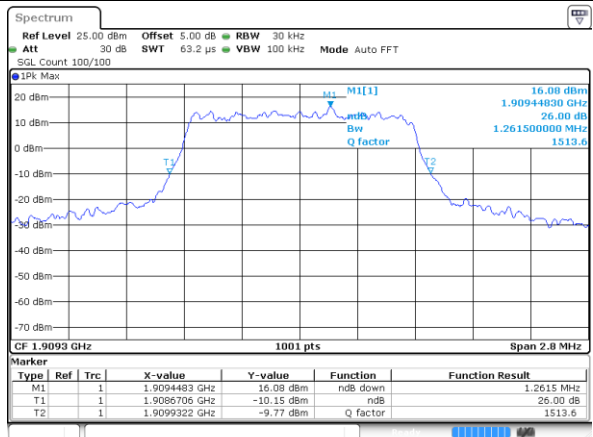

Date: 16 SEP 2018 08:37:12



LTE Band 2

Lowest Channel / 3MHz / QPSK

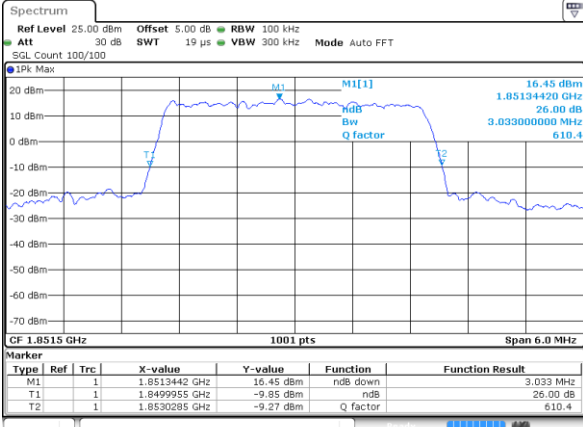

Date: 16 SEP 2018 08:44:10

Lowest Channel / 3MHz / 16QAM

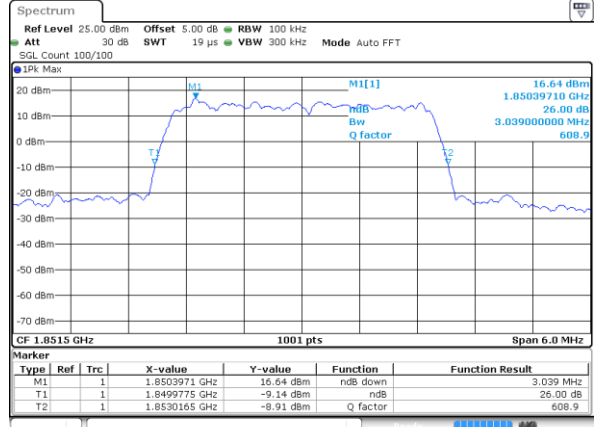

Date: 16 SEP 2018 08:44:20

Middle Channel / 3MHz / QPSK

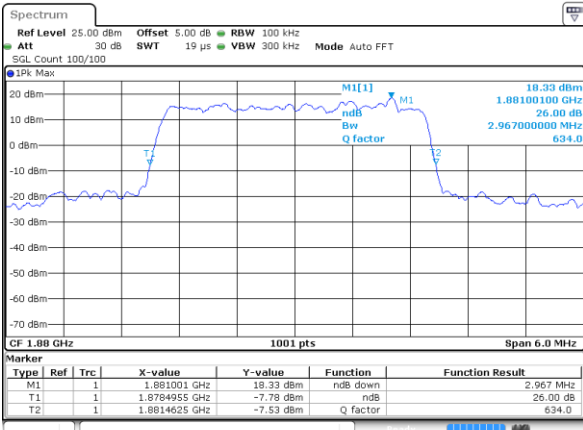

Date: 16 SEP 2018 08:51:18

Middle Channel / 3MHz / 16QAM

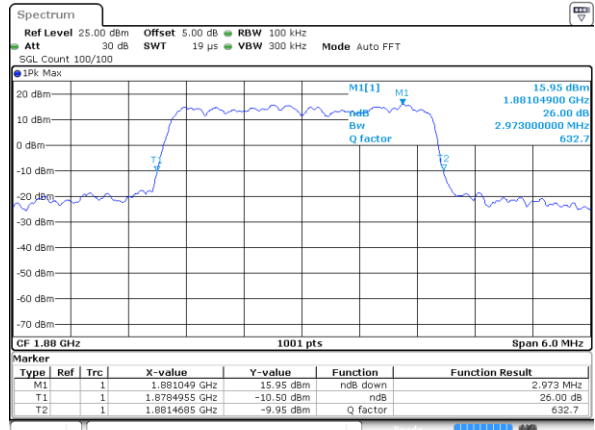

Date: 16 SEP 2018 08:51:29

Highest Channel / 3MHz / QPSK

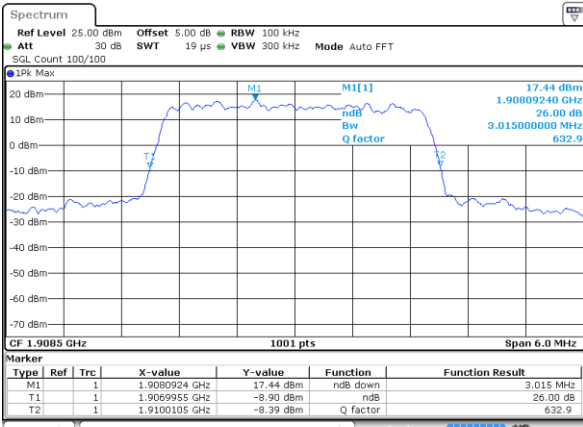

Date: 16 SEP 2018 08:53:53

Highest Channel / 3MHz / 16QAM

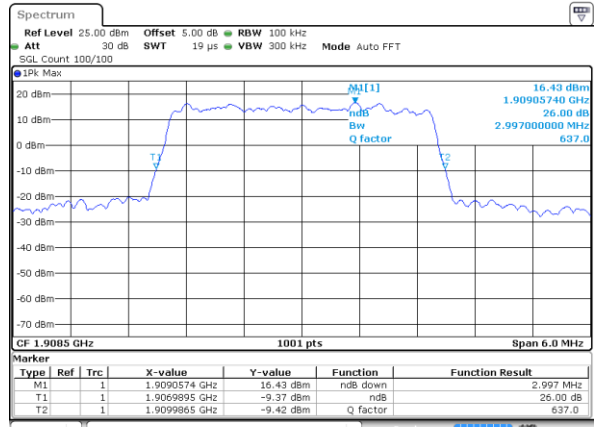

Date: 16 SEP 2018 08:54:03



LTE Band 2

Lowest Channel / 5MHz / QPSK

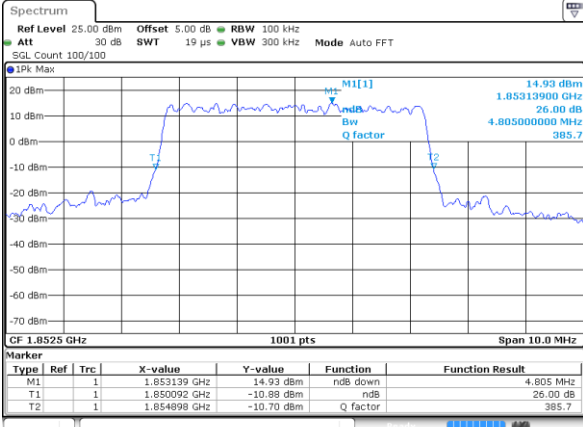

Date: 16 SEP 2018 09:09:37

Lowest Channel / 5MHz / 16QAM

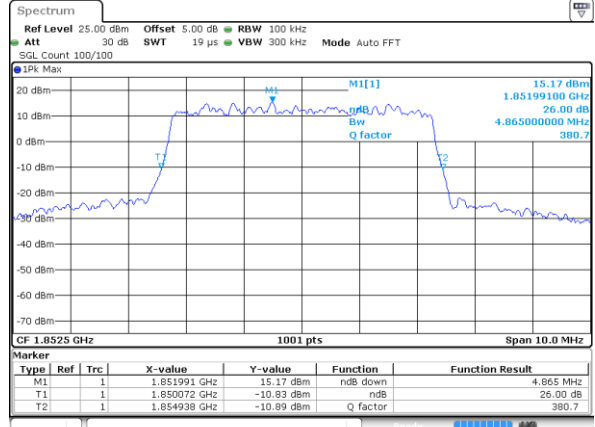

Date: 16 SEP 2018 09:09:49

Middle Channel / 5MHz / QPSK

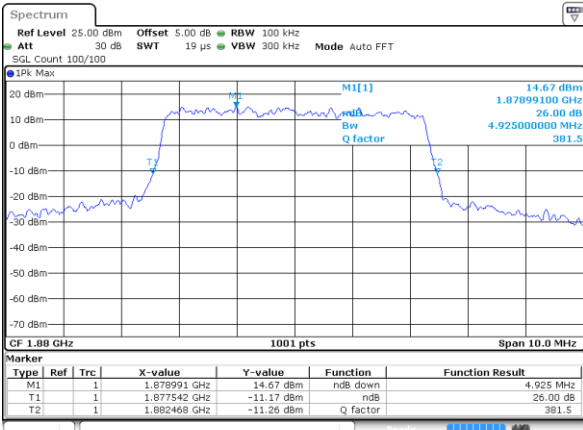

Date: 16 SEP 2018 09:12:19

Middle Channel / 5MHz / 16QAM

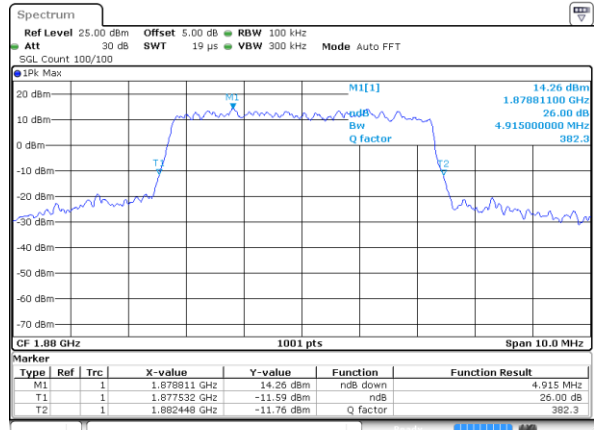

Date: 16 SEP 2018 09:12:31

Highest Channel / 5MHz / QPSK

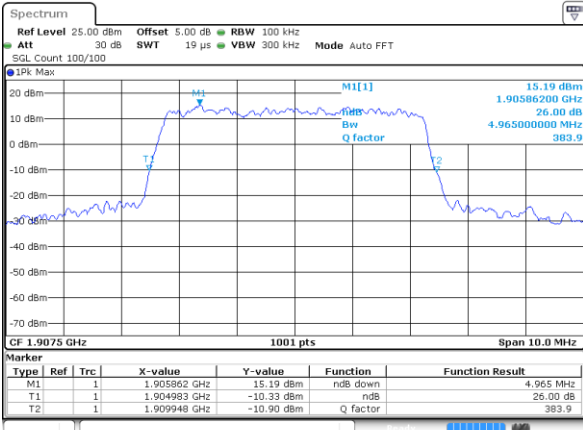

Date: 16 SEP 2018 09:14:57

Highest Channel / 5MHz / 16QAM

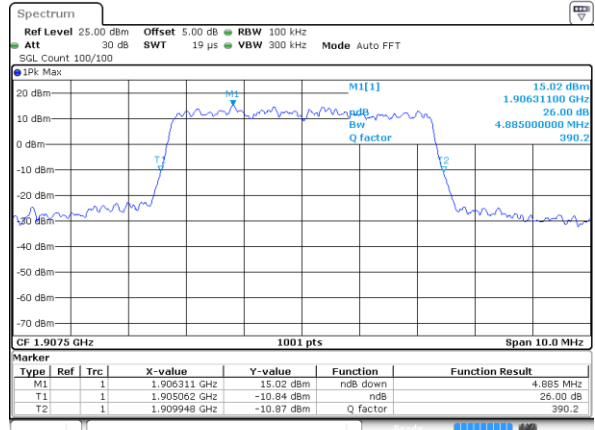

Date: 16 SEP 2018 09:15:07