



FCC RADIO TEST REPORT

FCC ID : IHDT56XP4
Equipment : Mobile Cellular Phone
Brand Name : Motorola
Model Name : XT1962-6
Applicant : Motorola Mobility LLC
222 W,Merchandise Mart Plaza, Chicago IL
60654 USA
Manufacturer : Motorola Mobility LLC
222 W,Merchandise Mart Plaza, Chicago IL
60654 USA
Standard : FCC Part 15 Subpart E §15.407

The product was received on Sep. 08, 2018 and testing was started from Oct. 06, 2018 and completed on Oct. 19, 2018. We, SPORTON INTERNATIONAL INC., would like to declare that the tested sample has been evaluated in accordance with the test procedures and has been in compliance with the applicable technical standards.

The report must not be used by the client to claim product certification, approval, or endorsement by TAF or any agency of government.

The test results in this variant report apply exclusively to the tested model / sample. Without written approval of SPORTON INTERNATIONAL INC. EMC & Wireless Communications Laboratory, the test report shall not be reproduced except in full.

Approved by: Joseph Lin

SPORTON INTERNATIONAL INC. EMC & Wireless Communications Laboratory
No. 52, Huaya 1st Rd., Guishan Dist., Taoyuan City, Taiwan (R.O.C.)



Table of Contents

History of this test report..... 3

Summary of Test Result..... 4

1 General Description 5

 1.1 Product Feature of Equipment Under Test..... 5

 1.2 Product Specification of Equipment Under Test..... 7

 1.3 Modification of EUT 7

 1.4 Testing Location 8

 1.5 Applicable Standards..... 8

2 Test Configuration of Equipment Under Test 9

 2.1 Carrier Frequency and Channel 9

 2.2 Test Mode..... 10

 2.3 Connection Diagram of Test System..... 10

 2.4 EUT Operation Test Setup 10

3 Test Result 11

 3.1 Maximum Conducted Output Power Measurement 11

 3.2 Unwanted Emissions Measurement..... 13

 3.3 Automatically Discontinue Transmission 18

 3.4 Antenna Requirements..... 19

4 List of Measuring Equipment..... 20

5 Uncertainty of Evaluation 22

Appendix A. Conducted Test Results

Appendix B. Radiated Spurious Emission

Appendix C. Radiated Spurious Emission Plots

Appendix D. Duty Cycle Plots



Summary of Test Result

Report Clause	Ref Std. Clause	Test Items	Result (PASS/FAIL)	Remark
-	15.403(i)	26dB Bandwidth	Not Required	-
-	2.1049	99% Occupied Bandwidth	Reporting only	-
3.1	15.407(a)	Maximum Conducted Output Power	Pass	-
-	15.407(a)	Power Spectral Density	Not Required	-
3.2	15.407(b)	Unwanted Emissions	Pass	Under limit 3.16 dB at 5350.080 MHz
-	15.207	AC Conducted Emission	Not Required	-
3.3	15.407(c)	Automatically Discontinue Transmission	Pass	-
3.4	15.203 15.407(a)	Antenna Requirement	Pass	-
Remark: 1. Not required means after assessing, test items are not necessary to carry out. 2. This is a variant report. All the test cases were performed on original report which can be referred to Sporton Report Number FR890804-01D.				

Reviewed by: Wii Chang

Report Producer: Natasha Hsieh



1 General Description

1.1 Product Feature of Equipment Under Test

Product Feature	
Equipment	Mobile Cellular Phone
Brand Name	Motorola
Model Name	XT1962-6
FCC ID	IHDT56XP4
IMEI Code	Conducted : IMEI 1: 355579090011036 IMEI 2: 355579090011044 Radiation : IMEI 1: 355579090013313 IMEI 2: 355579090013321
EUT supports Radios application	GSM/EGPRS/WCDMA/HSPA/LTE/GNSS/FM WLAN 11b/g/n HT20 WLAN 11a/n HT20/HT40 Bluetooth BR/EDR/LE
HW Version	DVT1B
EUT Stage	Identical Prototype

Remark: The above EUT's information was declared by manufacturer.



Accessory List	
AC Adapter 1	Brand Name : Motorola
	Model Name : SC-51
	Manufacturer : Salom
AC Adapter 1	Brand Name : Motorola
	Model Name : SC-52
	Manufacturer : Salom
AC Adapter 1	Brand Name : Motorola
	Model Name : SC-53
	Manufacturer : Salom
AC Adapter 1	Brand Name : Motorola
	Model Name : SC-55
	Manufacturer : Salom
AC Adapter 1 (IN)	Brand Name : Motorola
	Model Name : SC-55
	Manufacturer : Salom
AC Adapter 1 (IN Local Build)	Brand Name : Motorola
	Model Name : SC-54
	Manufacturer : Flex
AC Adapter 2	Brand Name : Motorola
	Model Name : SC-51
	Manufacturer : Chenyang
AC Adapter 2	Brand Name : Motorola
	Model Name : SC-52
	Manufacturer : Chenyang
AC Adapter 2	Brand Name : Motorola
	Model Name : SC-53
	Manufacturer : Chenyang
AC Adapter 2	Brand Name : Motorola
	Model Name : SC-55
	Manufacturer : Chenyang
AC Adapter 2 (IN Local Build)	Brand Name : Motorola
	Model Name : SC-54
	Manufacturer : Chenyang
Battery	Brand Name : Motorola
	Model Name : JG30
	Manufacturer : Amperex
Earphone	Brand Name : Motorola
	Model Name : SH38C37773
	Manufacturer : Lyand
USB Cable 1	Brand Name : Cabletech
	Model Name : SKN6473A
USB Cable 2	Brand Name : Saibao
	Model Name : SKN6473A
USB Cable 3	Brand Name : Luxshare
	Model Name : SKN6473A



1.2 Product Specification of Equipment Under Test

Standards-related Product Specification	
Tx/Rx Frequency Range	5180 MHz ~ 5240 MHz 5260 MHz ~ 5320 MHz 5500 MHz ~ 5720 MHz
Maximum Output Power to Antenna	<5180 MHz ~ 5240 MHz> 802.11a : 14.43 dBm / 0.0277 W 802.11n HT20 : 14.29 dBm / 0.0269 W 802.11n HT40 : 14.05 dBm / 0.0254 W <5260 MHz ~ 5320 MHz> 802.11a : 14.20 dBm / 0.0263 W 802.11n HT20 : 14.30 dBm / 0.0269 W 802.11n HT40 : 14.27 dBm / 0.0267 W <5500 MHz ~ 5700 MHz > 802.11a : 14.32 dBm / 0.0270 W 802.11n HT20 : 14.21 dBm / 0.0264 W 802.11n HT40 : 14.40 dBm / 0.0275 W
Antenna Type / Gain	<5150 MHz ~ 5250 MHz> IFA Antenna with gain 0.0 dBi <5250 MHz ~ 5350 MHz> IFA Antenna with gain 0.0 dBi <5470 MHz ~ 5725 MHz> IFA Antenna with gain 0.0 dBi
Type of Modulation	802.11a/n : OFDM (BPSK / QPSK / 16QAM / 64QAM)

Remark: The WLAN operation in 5600 MHz ~ 5650 MHz is notched.

1.3 Modification of EUT

No modifications are made to the EUT during all test items.



1.4 Testing Location

Sporton Lab is accredited to ISO 17025 by Taiwan Accreditation Foundation (TAF code : 1190) and the FCC designation No. TW1190 and TW0007 under the FCC 2.948(e) by Mutual Recognition Agreement (MRA) in FCC Test.

Test Site	SPORTON INTERNATIONAL INC.
Test Site Location	No.52, Huaya 1st Rd., Guishan Dist., Taoyuan City, Taiwan (R.O.C.) TEL: +886-3-327-3456 FAX: +886-3-328-4978
Test Site No.	Sporton Site No.
	TH05-HY

Note: The test site complies with ANSI C63.4 2014 requirement.

Test Site	SPORTON INTERNATIONAL INC.
Test Site Location	No.58, Aly. 75, Ln. 564, Wenhua 3rd, Rd., Guishan Dist., Taoyuan City, Taiwan (R.O.C.) TEL: +886-3-327-0868 FAX: +886-3-327-0855
Test Site No.	Sporton Site No.
	03CH11-HY

Note: The test site complies with ANSI C63.4 2014 requirement.

1.5 Applicable Standards

According to the specifications of the manufacturer, the EUT must comply with the requirements of the following standards:

- ♦ FCC Part 15 Subpart E
- ♦ FCC KDB 789033 D02 General UNII Test Procedures New Rules v02r01.
- ♦ FCC KDB 414788 D01 Radiated Test Site v01r01.
- ♦ ANSI C63.10-2013

Remark:

1. All test items were verified and recorded according to the standards and without any deviation during the test.
2. This EUT has also been tested and complied with the requirements of FCC Part 15, Subpart B, recorded in a separate test report.

2 Test Configuration of Equipment Under Test

- a. The EUT has been associated with peripherals and configuration operated in a manner tended to maximize its emission characteristics in a typical application. Frequency range investigated: radiation emission (9 kHz to the 10th harmonic of the highest fundamental frequency or to 40 GHz, whichever is lower). For radiated measurement, pre-scanned in three orthogonal panels, X, Y, Z. The worst cases (X plane) were recorded in this report.

2.1 Carrier Frequency and Channel

Frequency Band	Channel	Freq. (MHz)	Channel	Freq. (MHz)
5150-5250 MHz Band 1 (U-NII-1)	36	5180	44	5220
	38*	5190	46*	5230
	40	5200	48	5240
	-	-		

Frequency Band	Channel	Freq. (MHz)	Channel	Freq. (MHz)
5250-5350 MHz Band 2 (U-NII-2A)	52	5260	60	5300
	54*	5270	62*	5310
	56	5280	64	5320
	-	-		

Frequency Band	Channel	Freq. (MHz)	Channel	Freq. (MHz)
5470-5725 MHz Band 3 (U-NII-2C)	100	5500	112	5560
	102*	5510	116	5580
	104	5520	132	5660
	-	-	134*	5670
	108	5540	136	5680
	110*	5550	140	5700

Note: The above Frequency and Channel in "*" were 802.11n HT40.

2.2 Test Mode

Final test modes are considering the modulation and worse data rates as below table.

Modulation	Data Rate
802.11a	6 Mbps
802.11n HT20	MCS0
802.11n HT40	MCS0

Remark: For Radiated Test Cases, the tests were performed with Adapter 1 and USB Cable 1 Type C

Ch. #		Band I : 5150-5250 MHz	Band II : 5250-5350 MHz	Band III : 5470-5725MHz
		802.11n HT40	802.11n HT40	802.11n HT40
L	Low	38	-	-
M	Middle	-	-	-
H	High	-	62	134

2.3 Connection Diagram of Test System

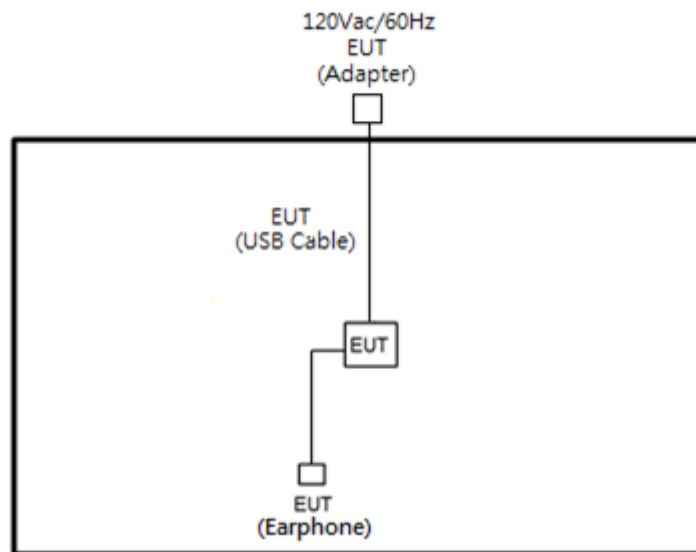

2.4 EUT Operation Test Setup

The RF test items, utility “CMD” was installed in Notebook which was programmed in order to make the EUT get into the engineering modes to provide channel selection, power level, data rate and the application type and for continuous transmitting signals.



3 Test Result

3.1 Maximum Conducted Output Power Measurement

3.1.1 Limit of Maximum Conducted Output Power

<FCC 14-30 CFR 15.407>

For the 5.15–5.25 GHz bands:

- For mobile and portable client devices in the 5.15–5.25 GHz band, the maximum conducted output power over the frequency band of operation shall not exceed 250 mW. For an indoor access point operating in the band 5.15-5.25 GHz, the maximum conducted output power over the frequency band of operation shall not exceed 1 W.

For the 5.25–5.725 GHz bands:

- The maximum conducted output power over the frequency bands of operation shall not exceed the lesser of 250 mW or $11 \text{ dBm} + 10 \log B$, where B is the 26 dB emission bandwidth in megahertz.

If transmitting antennas of directional gain greater than 6 dBi are used, the peak output power shall be reduced by the amount in dB that the directional gain of the antenna exceeds 6 dBi.

Note that U-NII-2 band, devices with a maximum e.i.r.p. greater than 500 mW shall implement TPC in order to have the capability to operate at least 6 dB below the maximum permitted e.i.r.p. of 1 W.

3.1.2 Measuring Instruments

See list of measuring equipment of this test report.

3.1.3 Test Procedures

The testing follows Method PM of FCC KDB 789033 D02 General UNII Test Procedures New Rules v02r01.

Method PM (Measurement using an RF average power meter):

1. Measurement is performed using a wideband RF power meter.
2. The EUT is configured to transmit continuously with a consistent duty cycle at its maximum power control level.
3. Measure the average power of the transmitter, and the average power is corrected with duty factor, $10 \log(1/x)$, where x is the duty cycle.

3.1.4 Test Setup

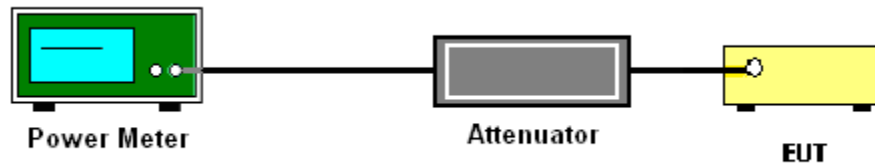

3.1.5 Test Result of Maximum Conducted Output Power

Please refer to Appendix A.



3.2 Unwanted Emissions Measurement

This section is to measure unwanted emissions through radiated measurement for band edge spurious emissions and out of band emissions measurement.

3.2.1 Limit of Unwanted Emissions

- (1) For transmitters operating in the 5150-5250 MHz band: all emissions outside of the 5150-5350 MHz band shall not exceed an EIRP of -27dBm/MHz.

For transmitters operating in the 5250-5350 MHz band: all emissions outside of the 5150-5350 MHz band shall not exceed an EIRP of -27 dBm/MHz. Devices operating in the 5250-5350 MHz band that generate emissions in the 5150-5250 MHz band must meet all applicable technical requirements for operation in the 5150-5250 MHz band (including indoor use) or alternatively meet an out-of-band emission EIRP limit of -27 dBm/MHz in the 5150-5250 MHz band.

For transmitters operating in the 5470-5600 MHz and 5650-5725MHz band: all emissions outside of the 5470-5600 MHz and 5650-5725MHz band shall not exceed an EIRP of -27 dBm/MHz.

- (2) Unwanted spurious emissions fallen in restricted bands shall comply with the general field strength limits as below table,

Frequency (MHz)	Field Strength (microvolts/meter)	Measurement Distance (meters)
0.009 – 0.490	2400/F(kHz)	300
0.490 – 1.705	24000/F(kHz)	30
1.705 – 30.0	30	30
30 – 88	100	3
88 – 216	150	3
216 - 960	200	3
Above 960	500	3

Note: The following formula is used to convert the EIRP to field strength.

$$E = \frac{1000000\sqrt{30P}}{3} \text{ } \mu\text{V/m, where P is the eirp (Watts)}$$



EIRP (dBm)	Field Strength at 3m (dBμV/m)
- 27	68.3

(3) KDB789033 D02 v02r01 G)2)c)

- (i) Section 15.407(b)(1) to (b)(3) specify the unwanted emission limits for the U-NII-1 and U-NII-2 bands. As specified, emissions above 1000 MHz that are outside of the restricted bands are subject to a peak emission limit of -27 dBm/MHz.³
- (ii) Section 15.407(b)(4) specifies the unwanted emission limit for the U-NII-3 band. A band emissions mask is specified in Section 15.407(b)(4)(i). The emission limits are in terms of a Peak detector. An alternative to the band emissions mask is specified in Section 15.407(b)(4)(ii). The alternative limits are based on the highest antenna gain specified in the filing. There are also marketing and importation restrictions for the devices using the alternative limit.⁴

Note 3: An out-of-band emission that complies with both the average and peak limits of Section 15.209 is not required to satisfy the -27 dBm/MHz peak emission limit.

Note 4: Only devices with antenna gains of 10 dBi or less may be approved using the emission limits specified in Section 15.247(d) till March 2, 2018; all other devices operating in this band must use the mask specified in Section 15.407(b)(4)(i).

3.2.2 Measuring Instruments

See list of measuring equipment of this test report.

3.2.3 Test Procedures

1. The testing follows FCC KDB 789033 D02 General UNII Test Procedures New Rules v02r01. Section G) Unwanted emissions measurement.
 - (1) Procedure for Unwanted Emissions Measurements Below 1000MHz
 - RBW = 120 kHz
 - VBW = 300 kHz
 - Detector = Peak
 - Trace mode = max hold
 - (2) Procedure for Peak Unwanted Emissions Measurements Above 1000 MHz
 - RBW = 1 MHz
 - VBW ≥ 3 MHz
 - Detector = Peak
 - Sweep time = auto
 - Trace mode = max hold



(3) Procedures for Average Unwanted Emissions Measurements Above 1000MHz

- RBW = 1 MHz
 - VBW = 10 Hz, when duty cycle is no less than 98 percent.
 - $VBW \geq 1/T$, when duty cycle is less than 98 percent where T is the minimum transmission duration over which the transmitter is on and is transmitting at its maximum power control level for the tested mode of operation.
2. The EUT was placed on a turntable with 0.8 meter for frequency below 1GHz and 1.5 meter for frequency above 1GHz respectively above ground.
 3. The EUT was set 3 meters from the interference receiving antenna which was mounted on the top of a variable height antenna tower.
 4. The antenna is a broadband antenna and its height is adjusted between one meter and four meters above ground to find the maximum value of the field strength for both horizontal polarization and vertical polarization of the antenna.
 5. For each suspected emission, the EUT was arranged to its worst case and then adjust the antenna tower (from 1 m to 4 m) and turntable (from 0 degree to 360 degrees) to find the maximum reading.
 6. For testing below 1GHz, if the emission level of the EUT in peak mode was 3 dB lower than the limit specified, then peak values of EUT will be reported, otherwise, the emissions will be repeated one by one using the CISPR quasi-peak method and reported.
 7. For testing above 1GHz, the emission level of the EUT in peak mode was 20dB lower than average limit (that means the emission level in average mode also complies with the limit in average mode), then peak values of EUT will be reported, otherwise, the emissions will be measured in average mode again and reported.

3.2.4 Test Setup

For radiated emissions below 30MHz

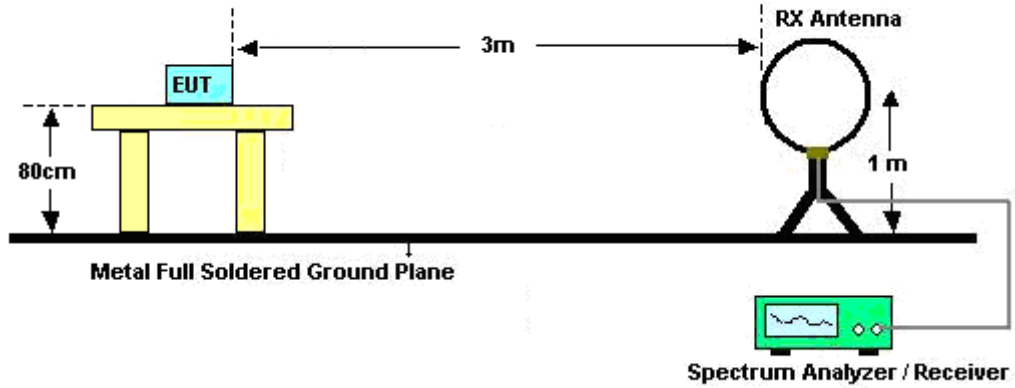

For radiated emissions from 30MHz to 1GHz

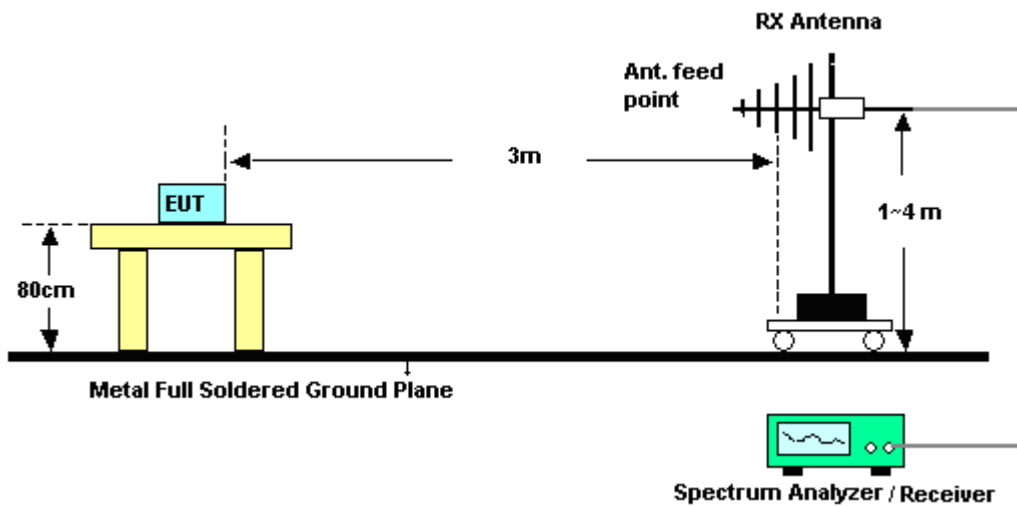

For radiated emissions above 1GHz

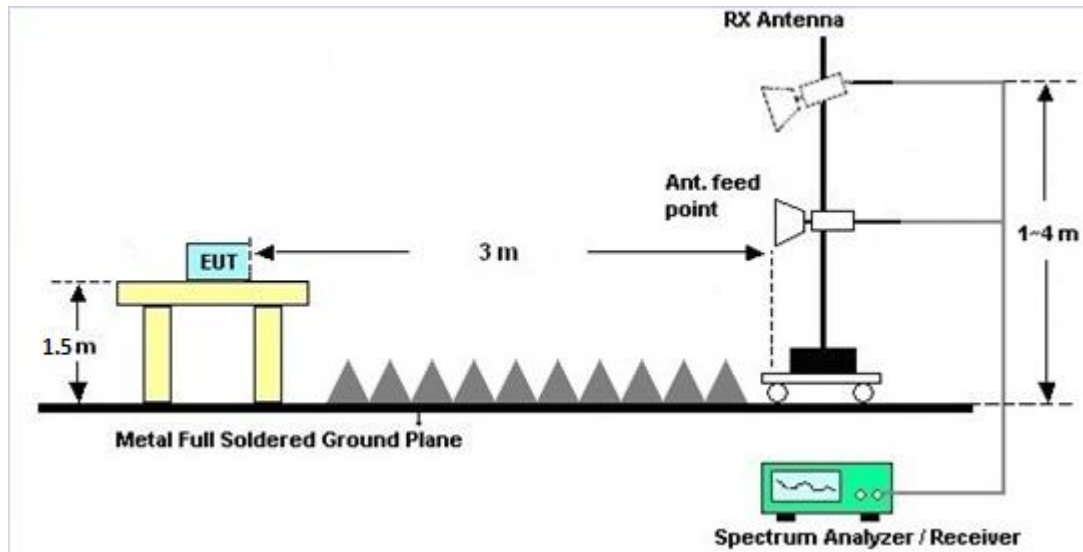

3.2.5 Test Results of Radiated Spurious Emissions (9 kHz ~ 30 MHz)

The low frequency, which started from 9 kHz to 30MHz, was pre-scanned and the result which was 20dB lower than the limit line was not reported.

There is a comparison data of both open-field test site and alternative test site - semi-Anechoic chamber according to 414788 D01 Radiated Test Site v01r01, and the result came out very similar.

3.2.6 Test Result of Radiated Spurious at Band Edges

Please refer to Appendix B and C.

3.2.7 Duty Cycle

Please refer to Appendix D.

3.2.8 Test Result of Radiated Spurious Emissions (30MHz ~ 10th Harmonic)

Please refer to Appendix B and C.



3.3 Automatically Discontinue Transmission

3.3.1 Limit of Automatically Discontinue Transmission

The device shall automatically discontinue transmission in case of either absence of information to transmit or operational failure. These provisions are not intended to preclude the transmission of control or signaling information or the use of repetitive codes used by certain digital technologies to complete frame or burst intervals. Applicants shall include in their application for equipment authorization to describe how this requirement is met.

3.3.2 Measuring Instruments

See list of measuring equipment of this test report.

3.3.3 Test Result of Automatically Discontinue Transmission

While the EUT is not transmitting any information, the EUT can automatically discontinue transmission and become standby mode for power saving. The EUT can detect the controlling signal of ACK message transmitting from remote device and verify whether it shall resend or discontinue transmission.



3.4 Antenna Requirements

3.4.1 Standard Applicable

If transmitting antenna directional gain is greater than 6 dBi, both the peak transmit power and the peak power spectral density shall be reduced by the amount in dB that the directional gain of the antenna exceeds 6 dBi.

3.4.2 Antenna Anti-Replacement Construction

An embedded-in antenna design is used.

3.4.3 Antenna Gain

The antenna peak gain of EUT is less than 6 dBi. Therefore, it is not necessary to reduce maximum peak output power limit.



4 List of Measuring Equipment

Instrument	Manufacturer	Model No.	Serial No.	Characteristics	Calibration Date	Test Date	Due Date	Remark
Hygrometer	Testo	DTM-303A	TP157075	N/A	Mar. 06, 2018	Oct. 19, 2018	Mar. 05, 2019	Conducted (TH05-HY)
Power Meter	Anritsu	ML2495A	1132003	N/A	Aug. 16, 2018	Oct. 19, 2018	Aug. 15, 2019	Conducted (TH05-HY)
Power Sensor	Anritsu	MA2411B	1126017	300MHz~40GHz	Aug. 16, 2018	Oct. 19, 2018	Aug. 15, 2019	Conducted (TH05-HY)
Spectrum Analyzer	Rohde & Schwarz	FSP40	100057	9kHz-40GHz	Nov. 21, 2017	Oct. 19, 2018	Nov. 20, 2018	Conducted (TH05-HY)
Switch Box & RF Cable	Burgeon	ETF-058	EC1300484	N/A	Mar. 01, 2018	Oct. 19, 2018	Feb. 28, 2019	Conducted (TH05-HY)
Loop Antenna	Rohde & Schwarz	HFH2-Z2	100488	9 kHz~30 MHz	Nov. 23, 2017	Oct. 06, 2018~ Oct. 07, 2018	Nov. 22, 2018	Radiation (03CH11-HY)
Bilog Antenna	TESEQ	CBL 6111D&N-6-06	35414&AT-N0602	30MHz~1GHz	Oct. 14, 2017	Oct. 06, 2018~ Oct. 07, 2018	Oct. 13, 2018	Radiation (03CH11-HY)
Preamplifier	Jet-Power	JPA0118-55-303K	1710001800054002	1GHz~18GHz	Apr. 17, 2018	Oct. 06, 2018~ Oct. 07, 2018	Apr. 16, 2019	Radiation (03CH11-HY)
Spectrum Analyzer	Keysight	N9010A	MY54200486	10Hz ~ 44GHz	Oct. 19, 2017	Oct. 06, 2018~ Oct. 07, 2018	Oct. 18, 2018	Radiation (03CH11-HY)
Horn Antenna	SCHWARZBECK	BBHA 9120 D	9120D-1326	1GHz ~ 18GHz	Oct. 16, 2017	Oct. 06, 2018~ Oct. 07, 2018	Oct. 15, 2018	Radiation (03CH11-HY)
Hygrometer	TECPEL	DTN-303B	TP140325	N/A	Oct. 12, 2017	Oct. 06, 2018~ Oct. 07, 2018	Oct. 11, 2018	Radiation (03CH11-HY)
Preamplifier	Keysight	83017A	MY53270080	1GHz~26.5GHz	Jan. 16, 2018	Oct. 06, 2018~ Oct. 07, 2018	Jan. 15, 2020	Radiation (03CH11-HY)
Controller	EMEC	EM 1000	N/A	Control Turn table & Ant Mast	N/A	Oct. 06, 2018~ Oct. 07, 2018	N/A	Radiation (03CH11-HY)
Antenna Mast	EMEC	AM-BS-4500-B	N/A	1~4m	N/A	Oct. 06, 2018~ Oct. 07, 2018	N/A	Radiation (03CH11-HY)
Turn Table	EMEC	TT 2000	N/A	0~360 Degree	N/A	Oct. 06, 2018~ Oct. 07, 2018	N/A	Radiation (03CH11-HY)
Amplifier	MITEQ	TTA1840-35-HG	1871923	18GHz~40GHz, VSWR : 2.5:1 max	Jul. 16, 2018	Oct. 06, 2018~ Oct. 07, 2018	Jul. 15, 2019	Radiation (03CH11-HY)
Amplifier	SONOMA	310N	187312	9kHz~1GHz	Jan. 16, 2018	Oct. 06, 2018~ Oct. 07, 2018	Jan. 15, 2019	Radiation (03CH11-HY)



Instrument	Manufacturer	Model No.	Serial No.	Characteristics	Calibration Date	Test Date	Due Date	Remark
SHF-EHF Horn Antenna	SCHWARZBECK	BBHA 9170	BBHA9170584	18GHz- 40GHz	Nov. 27, 2017	Oct. 06, 2018~ Oct. 07, 2018	Nov. 26, 2018	Radiation (03CH11-HY)
Software	Audix	E3 6.2009-8-24	RK-00104 2	N/A	N/A	Oct. 06, 2018~ Oct. 07, 2018	N/A	Radiation (03CH11-HY)
RF Cable	HUBER + SUHNER	SUCOFLEX 104	MY9837/4 PE	9kHz-30MHz	Mar. 14, 2018	Oct. 06, 2018~ Oct. 07, 2018	Mar. 13, 2019	Radiation (03CH11-HY)
RF Cable	HUBER + SUHNER	SUCOFLEX 102	MY2859/2	30MHz-40GHz	Mar. 14, 2018	Oct. 06, 2018~ Oct. 07, 2018	Mar. 13, 2019	Radiation (03CH11-HY)
RF Cable	HUBER + SUHNER	SUCOFLEX 104	MY9837/4 PE	30M-18G	Mar. 14, 2018	Oct. 06, 2018~ Oct. 07, 2018	Mar. 13, 2019	Radiation (03CH11-HY)
RF Cable	HUBER + SUHNER	SUCOFLEX 102	MY4274/2	30MHz-40GHz	Mar. 14, 2018	Oct. 06, 2018~ Oct. 07, 2018	Mar. 13, 2019	Radiation (03CH11-HY)
Filter	Wainwright	WLK4-1000-1 530-8000-40S S	SN11	1G Low Pass	Sep. 17, 2018	Oct. 06, 2018~ Oct. 07, 2018	Sep. 16, 2019	Radiation (03CH11-HY)
Filter	Wainwright	WHKX12-270 0-3000-18000 -60SS	SN3	2.7G High Pass	Sep. 17, 2018	Oct. 06, 2018~ Oct. 07, 2018	Sep. 16, 2019	Radiation (03CH11-HY)



5 Uncertainty of Evaluation

Uncertainty of Radiated Emission Measurement (30 MHz ~ 1000 MHz)

Measuring Uncertainty for a Level of Confidence of 95% ($U = 2Uc(y)$)	5.20
---	------

Uncertainty of Radiated Emission Measurement (1000 MHz ~ 18000 MHz)

Measuring Uncertainty for a Level of Confidence of 95% ($U = 2Uc(y)$)	5.50
---	------

Uncertainty of Radiated Emission Measurement (18000 MHz ~ 40000 MHz)

Measuring Uncertainty for a Level of Confidence of 95% ($U = 2Uc(y)$)	5.20
---	------

Appendix A. Test Result of Conducted Test Items

Test Engineer:	An An Wu	Temperature:	21~25	°C
Test Date:	2018/10/19	Relative Humidity:	51~54	%

TEST RESULTS DATA
Average Power Table

FCC Band I														
Mod.	Data Rate	NTX	CH.	Freq. (MHz)	Duty Factor (dB)		Average Conducted Power (dBm)			FCC Conducted Power Limit (dBm)		DG (dBi)		Pass/Fail
					Ant 1	Ant 2	Ant 1	Ant 2	SUM	Ant 1	Ant 2	Ant 1	Ant 2	
11a	6Mbps	1	36	5180	0.59	-	13.73	-		24.00	-	0.00	-	Pass
11a	6Mbps	1	44	5220	0.59	-	14.43	-		24.00	-	0.00	-	Pass
11a	6Mbps	1	48	5240	0.59	-	14.40	-		24.00	-	0.00	-	Pass
HT20	MCS0	1	36	5180	0.63	-	13.73	-		24.00	-	0.00	-	Pass
HT20	MCS0	1	44	5220	0.63	-	14.29	-		24.00	-	0.00	-	Pass
HT20	MCS0	1	48	5240	0.63	-	14.07	-		24.00	-	0.00	-	Pass
HT40	MCS0	1	38	5190	0.55	-	10.53	-		24.00	-	0.00	-	Pass
HT40	MCS0	1	46	5230	0.55	-	14.05	-		24.00	-	0.00	-	Pass

TEST RESULTS DATA
Average Power Table

FCC Band II															
Mod.	Data Rate	NTX	CH.	Freq. (MHz)	Duty Factor (dB)		Average Conducted Power (dBm)			FCC Conducted Power Limit (dBm)		DG (dBi)		EIRP Power Limit (dBm)	Pass/Fail
					Ant 1	Ant 2	Ant 1	Ant 2	SUM	Ant 1	Ant 2	Ant 1	Ant 2		
11a	6Mbps	1	52	5260	0.59	-	14.17	-		-	-	0.00	-	26.99	Pass
11a	6Mbps	1	60	5300	0.59	-	14.14	-		-	-	0.00	-	26.99	Pass
11a	6Mbps	1	64	5320	0.59	-	14.20	-		-	-	0.00	-	26.99	Pass
HT20	MCS0	1	52	5260	0.63	-	14.04	-		-	-	0.00	-	26.99	Pass
HT20	MCS0	1	60	5300	0.63	-	14.14	-		-	-	0.00	-	26.99	Pass
HT20	MCS0	1	64	5320	0.63	-	14.30	-		-	-	0.00	-	26.99	Pass
HT40	MCS0	1	54	5270	0.55	-	14.27	-		-	-	0.00	-	26.99	Pass
HT40	MCS0	1	62	5310	0.55	-	11.00	-		-	-	0.00	-	26.99	Pass

TEST RESULTS DATA
Average Power Table

FCC Band III															
Mod.	Data Rate	NTX	CH.	Freq. (MHz)	Duty Factor (dB)		Average Conducted Power (dBm)			FCC Conducted Power Limit (dBm)		DG (dBi)		EIRP Power Limit (dBm)	Pass/Fail
					Ant 1	Ant 2	Ant 1	Ant 2	SUM	Ant 1	Ant 2	Ant 1	Ant 2		
11a	6Mbps	1	100	5500	0.59	-	14.19	-		-	-	0.00	-	26.99	Pass
11a	6Mbps	1	116	5580	0.59	-	14.30	-		-	-	0.00	-	26.99	Pass
11a	6Mbps	1	140	5700	0.59	-	14.32	-		-	-	0.00	-	26.99	Pass
HT20	MCS0	1	100	5500	0.63	-	14.21	-		-	-	0.00	-	26.99	Pass
HT20	MCS0	1	116	5580	0.63	-	13.91	-		-	-	0.00	-	26.99	Pass
HT20	MCS0	1	140	5700	0.63	-	12.44	-		-	-	0.00	-	26.99	Pass
HT40	MCS0	1	102	5510	0.55	-	12.04	-		-	-	0.00	-	26.99	Pass
HT40	MCS0	1	110	5550	0.55	-	14.23	-		-	-	0.00	-	26.99	Pass
HT40	MCS0	1	134	5670	0.55	-	14.40	-		-	-	0.00	-	26.99	Pass



Appendix B. Radiated Spurious Emission

Test Engineer :	HAO HSU and Ken Wu	Temperature :	21~26°C
		Relative Humidity :	51~56%

Band 1 - 5150~5250MHz

WIFI 802.11n HT40 (Band Edge @ 3m)

WIFI Ant.	Note	Frequency (MHz)	Level (dBμV/m)	Over Limit (dB)	Limit Line (dBμV/m)	Read Level (dBμV)	Antenna Factor (dB/m)	Path Loss (dB)	Preamp Factor (dB)	Ant Pos (cm)	Table Pos (deg)	Peak Avg. (P/A)	Pol. (H/V)
802.11n HT40 CH 38 5190MHz		5149.24	57.61	-16.39	74	49.21	31.75	9.68	33.03	105	94	P	H
		5149.76	46.7	-7.3	54	38.3	31.75	9.68	33.03	105	94	A	H
	*	5190	98.34	-	-	89.85	31.78	9.74	33.03	105	94	P	H
	*	5190	89.85	-	-	81.36	31.78	9.74	33.03	105	94	A	H
		5398.4	49.57	-24.43	74	40.75	32	9.84	33.02	105	94	P	H
		5457.48	40.25	-13.75	54	31.33	32.05	9.89	33.02	105	94	A	H
		5150	61.12	-12.88	74	52.71	31.75	9.69	33.03	100	101	P	V
		5150	48.82	-5.18	54	40.41	31.75	9.69	33.03	100	101	A	V
	*	5190	100.75	-	-	92.26	31.78	9.74	33.03	100	101	P	V
	*	5190	92.3	-	-	83.81	31.78	9.74	33.03	100	101	A	V
		5433.96	48.73	-25.27	74	39.85	32.03	9.87	33.02	100	101	P	V
		5435.64	40.45	-13.55	54	31.57	32.03	9.87	33.02	100	101	A	V
Remark	1. No other spurious found. 2. All results are PASS against Peak and Average limit line.												



**Band 1 5150~5250MHz
WIFI 802.11n HT40 (Harmonic @ 3m)**

WIFI Ant.	Note	Frequency	Level	Over Limit	Limit Line	Read Level	Antenna Factor	Path Loss	Preamp Factor	Ant Pos	Table Pos	Peak Avg.	Pol.
1		(MHz)	(dB μ V/m)	(dB)	(dB μ V/m)	(dB μ V)	(dB/m)	(dB)	(dB)	(cm)	(deg)	(P/A)	(H/V)
802.11n HT40 CH 38 5190MHz		10380	45.44	-22.76	68.2	50.59	39.54	15.35	60.04	100	0	P	H
		15570	43.23	-30.77	74	44.52	37.91	18.8	58	100	0	P	H
													H
													H
		10380	45.82	-22.38	68.2	50.97	39.54	15.35	60.04	100	0	P	V
		15570	43.64	-30.36	74	44.93	37.91	18.8	58	100	0	P	V
													V
													V
Remark	1. No other spurious found. 2. All results are PASS against Peak and Average limit line.												



Band 2 - 5250~5350MHz

WIFI 802.11n HT40 (Band Edge @ 3m)

WIFI Ant.	Note	Frequency	Level	Over Limit	Limit Line	Read Level	Antenna Factor	Path Loss	Preamp Factor	Ant Pos	Table Pos	Peak Avg.	Pol.
1		(MHz)	(dBμV/m)	(dB)	(dBμV/m)	(dBμV)	(dB/m)	(dB)	(dB)	(cm)	(deg)	(P/A)	(H/V)
802.11n HT40 CH 62 5310MHz		5020.4	49.32	-24.68	74	41.25	31.62	9.49	33.04	100	65	P	H
		5086.02	41.13	-12.87	54	32.9	31.68	9.59	33.04	100	65	A	H
	*	5310	98.04	-	-	89.35	31.92	9.8	33.03	100	65	P	H
	*	5310	89.37	-	-	80.68	31.92	9.8	33.03	100	65	A	H
		5350.8	57.54	-16.46	74	48.8	31.95	9.82	33.03	100	65	P	H
		5350.56	46.89	-7.11	54	38.15	31.95	9.82	33.03	100	65	A	H
		5114.58	50.03	-23.97	74	41.72	31.72	9.63	33.04	100	239	P	V
		5105.74	41.19	-12.81	54	32.89	31.72	9.62	33.04	100	239	A	V
	*	5310	102.09	-	-	93.4	31.92	9.8	33.03	100	239	P	V
	*	5310	93.23	-	-	84.54	31.92	9.8	33.03	100	239	A	V
		5351.28	58.03	-15.97	74	49.29	31.95	9.82	33.03	100	239	P	V
		5350.08	50.84	-3.16	54	42.1	31.95	9.82	33.03	100	239	A	V
Remark	1. No other spurious found. 2. All results are PASS against Peak and Average limit line.												



**Band 2 5250~5350MHz
WIFI 802.11n HT40 (Harmonic @ 3m)**

WIFI Ant.	Note	Frequency	Level	Over Limit	Limit Line	Read Level	Antenna Factor	Path Loss	Preamp Factor	Ant Pos	Table Pos	Peak Avg.	Pol.
1		(MHz)	(dBμV/m)	(dB)	(dBμV/m)	(dBμV)	(dB/m)	(dB)	(dB)	(cm)	(deg)	(P/A)	(H/V)
802.11n HT40 CH 62		10620	43.92	-30.08	74	49.23	39.8	15.48	60.59	100	0	P	H
		15930	43.15	-30.85	74	44.84	36.89	18.92	57.5	100	0	P	H
													H
													H
5310MHz		10620	45.26	-28.74	74	50.57	39.8	15.48	60.59	100	0	P	V
		15930	42.51	-31.49	74	44.2	36.89	18.92	57.5	100	0	P	V
													V
													V
Remark	1. No other spurious found. 2. All results are PASS against Peak and Average limit line.												



Band 3 - 5470~5725MHz

WIFI 802.11n HT40 (Band Edge @ 3m)

WIFI Ant.	Note	Frequency	Level	Over Limit	Limit Line	Read Level	Antenna Factor	Path Loss	Preamp Factor	Ant Pos	Table Pos	Peak Avg.	Pol.
1		(MHz)	(dBμV/m)	(dB)	(dBμV/m)	(dBμV)	(dB/m)	(dB)	(dB)	(cm)	(deg)	(P/A)	(H/V)
802.11n HT40 CH 134 5670MHz		5413	48.88	-25.12	74	40.03	32.02	9.85	33.02	100	64	P	H
		5467.6	47.42	-20.78	68.2	38.47	32.07	9.9	33.02	100	64	P	H
		5458.15	40.24	-13.76	54	31.32	32.05	9.89	33.02	100	64	A	H
	*	5670	101.32	-	-	91.9	32.41	10.12	33.11	100	64	P	H
	*	5670	93.04	-	-	83.62	32.41	10.12	33.11	100	64	A	H
		5726.5	61.39	-6.81	68.2	51.82	32.5	10.2	33.13	100	64	P	H
		5440.3	49.5	-24.5	74	40.61	32.03	9.88	33.02	100	118	P	V
		5466.9	48.42	-19.78	68.2	39.47	32.07	9.9	33.02	100	118	P	V
		5439.6	40.6	-13.4	54	31.71	32.03	9.88	33.02	100	118	A	V
	*	5670	103.9	-	-	94.48	32.41	10.12	33.11	100	118	P	V
	*	5670	95.49	-	-	86.07	32.41	10.12	33.11	100	118	A	V
	5726.325	62.14	-6.06	68.2	52.57	32.5	10.2	33.13	100	118	P	V	
Remark	1. No other spurious found. 2. All results are PASS against Peak and Average limit line.												



**Band 3 - 5470~5725MHz
WIFI 802.11n HT40 (Harmonic @ 3m)**

WIFI Ant.	Note	Frequency	Level	Over Limit	Limit Line	Read Level	Antenna Factor	Path Loss	Preamp Factor	Ant Pos	Table Pos	Peak Avg.	Pol.
1		(MHz)	(dB μ V/m)	(dB)	(dB μ V/m)	(dB μ V)	(dB/m)	(dB)	(dB)	(cm)	(deg)	(P/A)	(H/V)
802.11n HT40		11340	45.94	-28.06	74	51.59	40.03	15.89	61.57	100	0	P	H
		17010	46.77	-21.43	68.2	43.4	39.76	19.87	56.26	100	0	P	H
													H
													H
CH 134 5670MHz		11340	46.36	-27.64	74	52.01	40.03	15.89	61.57	100	0	P	V
		17010	46.51	-21.69	68.2	43.14	39.76	19.87	56.26	100	0	P	V
													V
													V
Remark	1. No other spurious found. 2. All results are PASS against Peak and Average limit line.												



Emission below 1GHz
WIFI 802.11n HT40 (LF @ 3m)

WIFI Ant.	Note	Frequency	Level	Over Limit	Limit Line	Read Level	Antenna Factor	Path Loss	Preamp Factor	Ant Pos	Table Pos	Peak Avg.	Pol.	
1		(MHz)	(dBμV/m)	(dB)	(dBμV/m)	(dBμV)	(dB/m)	(dB)	(dB)	(cm)	(deg)	(P/A)	(H/V)	
802.11n HT40 LF		34.05	22.96	-17.04	40	32.34	22.31	0.8	32.49	-	-	P	H	
		64.29	18.65	-21.35	40	38.37	11.69	1.08	32.49	-	-	P	H	
		201.99	22.2	-21.3	43.5	37.77	14.89	1.93	32.39	-	-	P	H	
		562.5	27.63	-18.37	46	30.95	25.98	3.13	32.43	-	-	P	H	
		856.5	30.95	-15.05	46	29.98	28.94	3.92	31.89	-	-	P	H	
		959.4	33.34	-12.66	46	29.23	31.07	4.16	31.12	100	0	P	H	
														H
														H
														H
														H
														H
														H
			37.83	34.26	-5.74	40	45.65	20.26	0.84	32.49	100	0	P	V
			48.9	29.54	-10.46	40	46.18	14.9	0.95	32.49	-	-	P	V
			61.05	24.74	-15.26	40	44.61	11.55	1.07	32.49	-	-	P	V
			482.7	28.94	-17.06	46	34.99	23.49	2.83	32.37	-	-	P	V
			867	31.96	-14.04	46	30.79	29.06	3.94	31.83	-	-	P	V
			958	34.48	-11.52	46	30.43	31.02	4.16	31.13	-	-	P	V
														V
														V
													V	
													V	
													V	
													V	
													V	
Remark	1. No other spurious found. 2. All results are PASS against limit line.													



Note symbol

*	Fundamental Frequency which can be ignored. However, the level of any unwanted emissions shall not exceed the level of the fundamental frequency.
!	Test result is over limit line.
P/A	Peak or Average
H/V	Horizontal or Vertical



A calculation example for radiated spurious emission is shown as below:

WIFI	Note	Frequency	Level	Over	Limit	Read	Antenna	Path	Preamp	Ant	Table	Peak	Pol.
Ant.				Limit	Line	Level	Factor	Loss	Factor	Pos	Pos	Avg.	
1		(MHz)	(dBμV/m)	(dB)	(dBμV/m)	(dBμV)	(dB/m)	(dB)	(dB)	(cm)	(deg)	(P/A)	(H/V)
802.11b		2390	55.45	-18.55	74	54.51	32.22	4.58	35.86	103	308	P	H
CH 01													
2412MHz		2390	43.54	-10.46	54	42.6	32.22	4.58	35.86	103	308	A	H

1. Path Loss(dB) = Cable loss(dB) + Filter loss(dB) + Attenuator loss(dB)
2. Level(dBμV/m) = Antenna Factor(dB/m) + Path Loss(dB) + Read Level(dBμV) - Preamp Factor(dB)
3. Over Limit(dB) = Level(dBμV/m) – Limit Line(dBμV/m)

For Peak Limit @ 2390MHz:

1. Level(dBμV/m)
= Antenna Factor(dB/m) + Path Loss(dB) + Read Level(dBμV) - Preamp Factor(dB)
= 32.22(dB/m) + 4.58(dB) + 54.51(dBμV) – 35.86 (dB)
= 55.45 (dBμV/m)
2. Over Limit(dB)
= Level(dBμV/m) – Limit Line(dBμV/m)
= 55.45(dBμV/m) – 74(dBμV/m)
= -18.55(dB)

For Average Limit @ 2390MHz:

1. Level(dBμV/m)
= Antenna Factor(dB/m) + Path Loss(dB) + Read Level(dBμV) - Preamp Factor(dB)
= 32.22(dB/m) + 4.58(dB) + 42.6(dBμV) – 35.86 (dB)
= 43.54 (dBμV/m)
2. Over Limit(dB) = Level(dBμV/m) – Limit Line(dBμV/m)
= 43.54(dBμV/m) – 54(dBμV/m)
= -10.46(dB)

Both peak and average measured complies with the limit line, so test result is “PASS”.



Appendix C. Radiated Spurious Emission

Test Engineer :	HAO HSU and Ken Wu	Temperature :	21~26°C
		Relative Humidity :	51~56%

Note symbol

-L	Low channel location
-R	High channel location



Band 1 - 5150~5250MHz
WIFI 802.11n HT40 (Band Edge @ 3m)

WIFI	Band 1 5150~5250MHz Band Edge @ 3m	
ANT	802.11n HT40 CH38 5190MHz - L	
1	Horizontal	Fundamental
Peak	<p>Site : 03CH11-HY Condition : PEAK_BE_74 3m HORN 91200-HF HORIZONTAL : RBW:1000.000KHz VBW:3000.000KHz SWT:Auto Detector : Peak Project : 890804-04 Setting : 11.5 : #7</p>	<p>Site : 03CH11-HY Condition : PEAK(LINE) 3m HORN 91200-HF HORIZONTAL : RBW:1000.000KHz VBW:3000.000KHz SWT:Auto Detector : Peak Project : 890804-04 Setting : 11.5 : #7</p>
Avg.	<p>Site : 03CH11-HY Condition : AVG_BE_54 3m HORN 91200-HF HORIZONTAL : RBW:1000.000KHz VBW:1.000KHz SWT:Auto Detector : Peak Project : 890804-04 Setting : 11.5 : #7</p>	Left blank

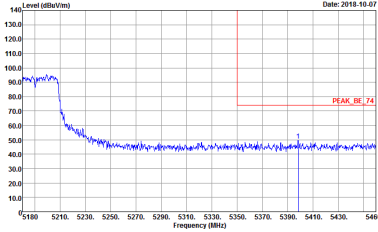
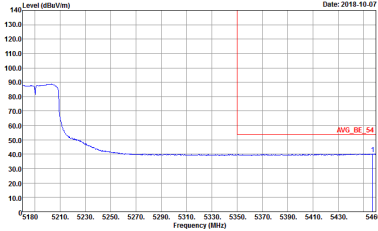

WIFI	Band 1 5150~5250MHz Band Edge @ 3m	
ANT	802.11n HT40 CH38 5190MHz - R	
1	Horizontal	Fundamental
<p>Peak</p>	 <p>Site : 03CH11-HY Condition : PEAK_BE_74 3m HORN 91200-HF HORIZONTAL Detector : Peak Project : 890804-04 Setting : #7</p>	<p>Left blank</p>
<p>Avg.</p>	 <p>Site : 03CH11-HY Condition : AVG_BE_54 3m HORN 91200-HF HORIZONTAL Detector : Peak Project : 890804-04 Setting : #7</p>	<p>Left blank</p>

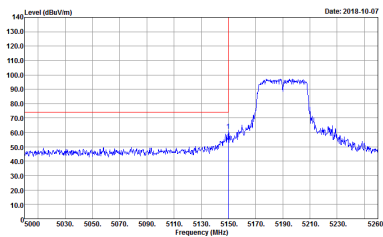
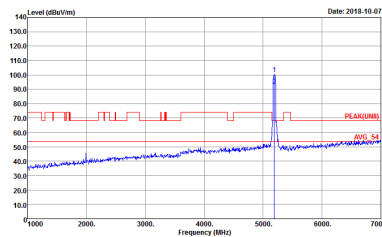
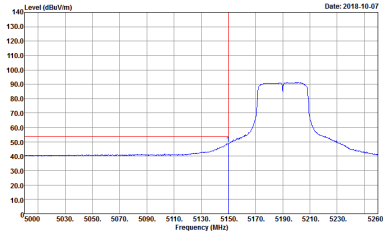

WIFI	Band 1 5150~5250MHz Band Edge @ 3m	
ANT	802.11n HT40 CH38 5190MHz - L	
1	Vertical	Fundamental
Peak	 <p>Site : 03CH11-HY Condition : PEAK_BE_74 3m HORN 91200-HF VERTICAL Detector : Peak Project : 890804-04 Setting : #7</p>	 <p>Site : 03CH11-HY Condition : PEAK(UNII) 3m HORN 91200-HF VERTICAL Detector : Peak Project : 890804-04 Setting : #7</p>
Avg.	 <p>Site : 03CH11-HY Condition : AVG_BE_54 3m HORN 91200-HF VERTICAL Detector : Peak Project : 890804-04 Setting : #7</p>	Left blank

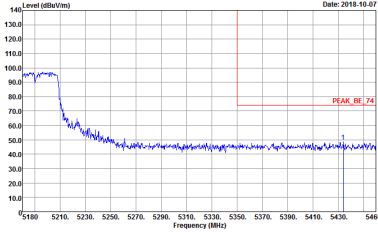
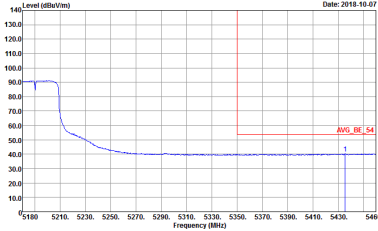

WIFI	Band 1 5150~5250MHz Band Edge @ 3m	
ANT	802.11n HT40 CH38 5190MHz - R	
1	Vertical	Fundamental
<p>Peak</p>	 <p>Site : 03CH11-HY Condition : PEAK_BE_74 3m HORN 91200-HF VERTICAL Detector : Peak Project : 890804-04 Setting : #7</p>	<p>Left blank</p>
<p>Avg.</p>	 <p>Site : 03CH11-HY Condition : AVG_BE_54 3m HORN 91200-HF VERTICAL Detector : Peak Project : 890804-04 Setting : #7</p>	<p>Left blank</p>



Band 1 - 5150~5250MHz
WIFI 802.11n HT40 (Harmonic @ 3m)

WIFI	Band 1 5150~5250MHz Harmonic @ 3m	
ANT	802.11n HT40 CH38 5190MHz	
1	Horizontal	Vertical
Peak Avg.	<p>Site : 03CH11-HY Condition : PEAK(UNIT) 3m HORN 9120D-1HF HORIZONTAL Detector : Peak Project : 890804-04</p>	<p>Site : 03CH11-HY Condition : PEAK(UNIT) 3m HORN 9120D-1HF VERTICAL Detector : Peak Project : 890804-04</p>



Band 2 - 5250~5350MHz
WIFI 802.11n HT40 (Band Edge @ 3m)

WIFI	Band 2 5250~5350MHz Band Edge @ 3m	
ANT	802.11n HT40 CH62 5310 - L	
1	Horizontal	Fundamental
Peak	<p>Site : 03CH11-HY Condition : PEAK_BE_74 3m HORN 91200-HF HORIZONTAL RBW:1000.000KHz VBW:3000.000KHz SWT:Auto Detector : Peak Project : 890804-04 Setting : 11 : #7</p>	<p>Site : 03CH11-HY Condition : PEAK(LINE) 3m HORN 91200-HF HORIZONTAL RBW:1000.000KHz VBW:3000.000KHz SWT:Auto Detector : Peak Project : 890804-04 Setting : 11 : #7</p>
Avg.	<p>Site : 03CH11-HY Condition : AVG_BE_54 3m HORN 91200-HF HORIZONTAL RBW:1000.000KHz VBW:1.000KHz SWT:Auto Detector : Peak Project : 890804-04 Setting : 11 : #7</p>	Left blank

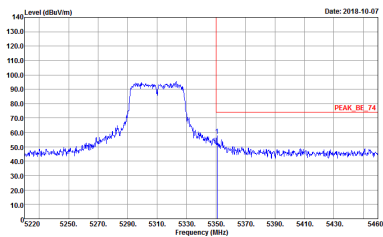
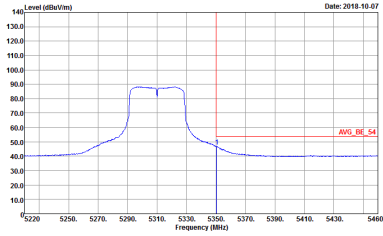

WIFI	Band 2 5250~5350MHz Band Edge @ 3m	
ANT	802.11n HT40 CH62 5310 - R	
1	Horizontal	Fundamental
<p>Peak</p>	 <p>Site : 03CH11-HY Condition : PEAK_BE_74 3m HORN 91200-HF HORIZONTAL Detector : Peak Project : 890804-04 Setting : #7</p>	<p>Left blank</p>
<p>Avg.</p>	 <p>Site : 03CH11-HY Condition : AVG_BE_54 3m HORN 91200-HF HORIZONTAL Detector : Peak Project : 890804-04 Setting : #7</p>	<p>Left blank</p>

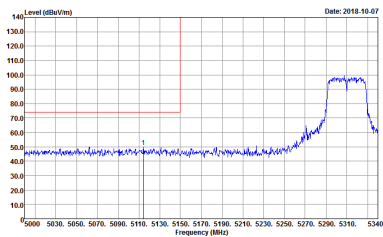
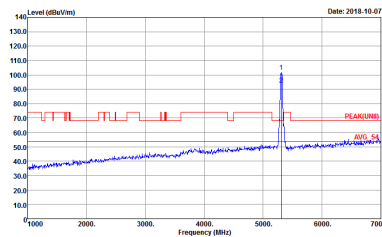
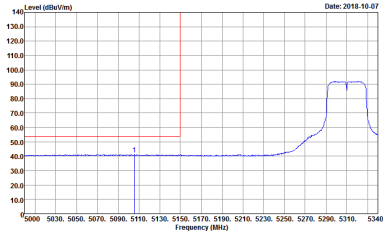

WIFI	Band 2 5250~5350MHz Band Edge @ 3m	
ANT	802.11n HT40 CH62 5310 - L	
1	Vertical	Fundamental
<p>Peak</p>	 <p>Site : 03CH11-HY Condition : PEAK_BE_74 3m HORN 91200-HF VERTICAL : RBW:1000.000KHz VBW:3000.000KHz SWT:Auto Detector : Peak Project : 890804-04 Setting : 11 : #7</p>	 <p>Site : 03CH11-HY Condition : PEAK(UNII) 3m HORN 91200-HF VERTICAL : RBW:1000.000KHz VBW:3000.000KHz SWT:Auto Detector : Peak Project : 890804-04 Setting : 11 : #7</p>
<p>Avg.</p>	 <p>Site : 03CH11-HY Condition : AVG_BE_54 3m HORN 91200-HF VERTICAL : RBW:1000.000KHz VBW:1.000KHz SWT:Auto Detector : Peak Project : 890804-04 Setting : 11 : #7</p>	<p>Left blank</p>

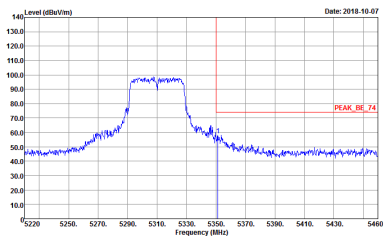
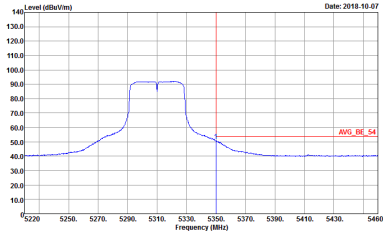

WIFI	Band 2 5250~5350MHz Band Edge @ 3m	
ANT	802.11n HT40 CH62 5310 - R	
1	Vertical	Fundamental
<p>Peak</p>	 <p>Site : 03CH11-HY Condition : PEAK_BE_74 3m HORN 91200-HF VERTICAL Detector : Peak Project : 890804-04 Setting : #7</p>	<p>Left blank</p>
<p>Avg.</p>	 <p>Site : 03CH11-HY Condition : AVG_BE_54 3m HORN 91200-HF VERTICAL Detector : Peak Project : 890804-04 Setting : #7</p>	<p>Left blank</p>



Band 2 - 5250~5350MHz
WIFI 802.11n HT40 (Harmonic @ 3m)

WIFI	Band 2 5250~5350MHz Harmonic @ 3m	
ANT	802.11n HT40 CH62 5310	
1	Horizontal	Vertical
Peak Avg.	<p>Site : 03CH11-HY Condition : PEAR(LINE1) 3m HORN 9120D-HF HORIZONTAL Detector : Peak Project : 890804-04</p>	<p>Site : 03CH11-HY Condition : PEAR(LINE1) 3m HORN 9120D-HF VERTICAL Detector : Peak Project : 890804-04</p>

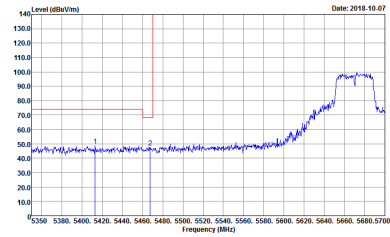
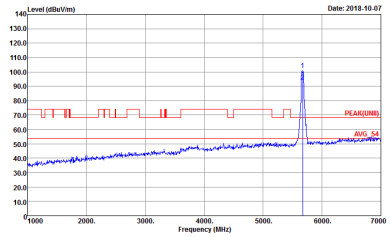
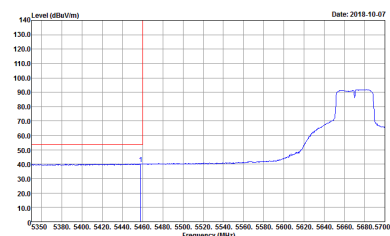

Band 3 - 5470~5725MHz
WIFI 802.11n HT40 (Band Edge @ 3m)

WIFI	Band 3 5470~5725MHz Band Edge @ 3m	
ANT	802.11n HT40 CH134 5670MHz - L	
1	Horizontal	Fundamental
<p align="center">Peak</p>	 <p>Date: 2018-10-07</p> <p>Site : 03CHI1-HY Condition : PEAK_BE(UNIT)_B3 3m HORN 9120D-HF HORIZONTAL Detector : Peak Project : 890804-04 Setting : 15 : #7</p>	 <p>Date: 2018-10-07</p> <p>Site : 03CHI1-HY Condition : PEAK(UNIT) 3m HORN 9120D-HF HORIZONTAL Detector : Peak Project : 890804-04 Setting : 15 : #7</p>
<p align="center">Avg.</p>	 <p>Date: 2018-10-07</p> <p>Site : 03CHI1-HY Condition : AVG_BE(UNIT)_B3 3m HORN 9120D-HF HORIZONTAL Detector : Peak Project : 890804-04 Setting : 15 : #7</p>	<p align="center">Left blank</p>



WIFI	Band 3 5470~5725MHz Band Edge @ 3m	
ANT	802.11n HT40 CH134 5670MHz - R	
1	Horizontal	Fundamental
Peak	<p>Site : D8CH114-F Condition : PEAK_BE([UNIT]), B3 3m HORN 91200-HF HORIZONTAL Detector : Peak Project : 890804-04 Setting : 15 : #7</p>	Left blank



WIFI	Band 3 5470~5725MHz Band Edge @ 3m	
ANT	802.11n HT40 CH134 5670MHz - L	
1	Vertical	Fundamental
<p>Peak</p>	<p>Site : 03CH11-HY Condition : PEAK_BE[UNII], B3 3m HORN 9120D-HF VERTICAL Detector : Peak Project : 890804-04 Setting : #7</p>	<p>Site : 03CH11-HY Condition : PEAK[UNII] 3m HORN 9120D-HF VERTICAL Detector : Peak Project : 890804-04 Setting : #7</p>
<p>Avg.</p>	<p>Site : 03CH11-HY Condition : AVG_BE[UNII], B3 3m HORN 9120D-HF VERTICAL Detector : Peak Project : 890804-04 Setting : #7</p>	<p>Left blank</p>



WIFI	Band 3 5470~5725MHz Band Edge @ 3m	
ANT	802.11n HT40 CH134 5670MHz - R	
1	Vertical	Fundamental
Peak	<p>Site : D8CH11-4-F Condition : PEAK_BE([UNIT]), B3 3m HCRN 91200-HF VERTICAL Detector : Peak Project : 890804-04 Setting : 15 : #7</p>	Left blank



Band 3 - 5470~5725MHz
WIFI 802.11n HT40 (Harmonic @ 3m)

WIFI	Band 3 5470~5725MHz Harmonic @ 3m	
ANT	802.11n HT40 CH134 5670MHz	
1	Horizontal	Vertical
Peak Avg.	<p>Site : 03CH11-HY Condition : PEARQ(UNIT) 3m HORN 9120D-HF HORIZONTAL Detector : Peak Project : 890804-04</p>	<p>Site : 03CH11-HY Condition : PEARQ(UNIT) 3m HORN 9120D-HF VERTICAL Detector : Peak Project : 890804-04</p>



Emission below 1GHz
5GHz WIFI 802.11n HT40 (LF)

WIFI	5GHz WIFI	
ANT	802.11n HT40 LF	
1	Horizontal	Vertical
QP / Peak	<p>Site : 03CH11-HY Condition : QP 3m BE-LOG-6111D-LF_ETC HORIZONTAL Detector : Peak Project : 890804-04</p>	<p>Site : 03CH11-HY Condition : QP 3m BE-LOG-6111D-LF_ETC VERTICAL Detector : Peak Project : 890804-04</p>



Appendix D. Duty Cycle Plots

Band	Duty Cycle (%)	T(us)	1/T(kHz)	VBW Setting	Duty Factor(dB)
802.11a	87.22	1365	0.732	1kHz	0.59
5GHz 802.11n HT20	86.53	1285	0.778	1kHz	0.63
5GHz 802.11n HT40	88.18	1530	0.654	1kHz	0.55

802.11a

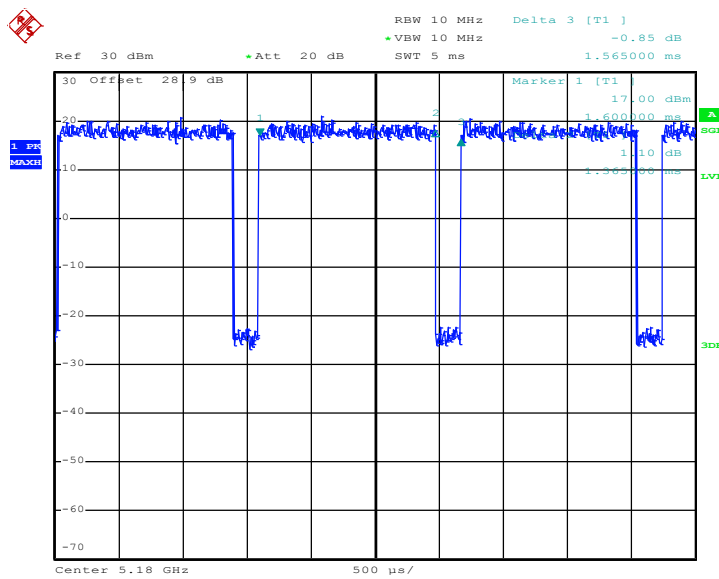

Date: 19.OCT.2018 18:52:19



802.11n HT20

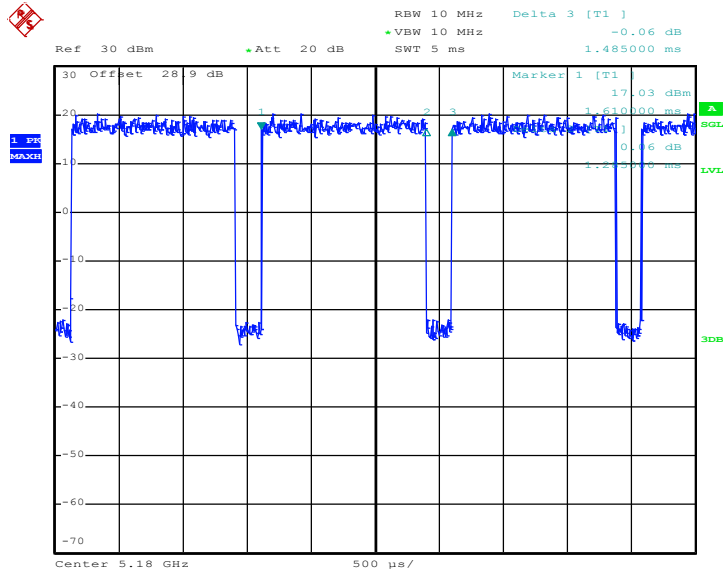

Date: 19.OCT.2018 18:53:19

802.11n HT40

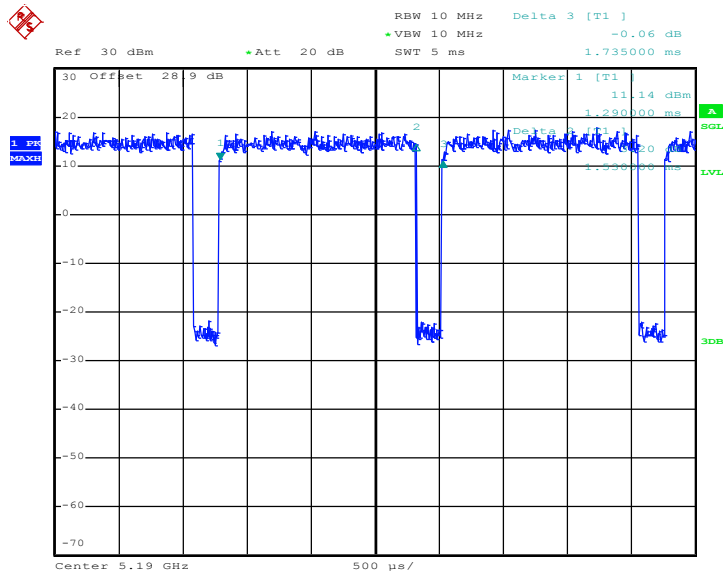

Date: 19.OCT.2018 18:58:59

—THE END—