



# FCC RADIO TEST REPORT

**FCC ID** : IHDT56XP2  
**Equipment** : Mobile Cellular Phone  
**Brand Name** : Motorola  
**Model Name** : XT1962-4  
**Applicant** : Motorola Mobility LLC  
222 W,Merchandise Mart Plaza, Chicago IL  
60654 USA  
**Manufacturer** : Motorola Mobility LLC  
222 W,Merchandise Mart Plaza, Chicago IL  
60654 USA  
**Standard** : FCC Part 15 Subpart E §15.407

The product was received on Sep. 08, 2018 and testing was started from Sep. 20, 2018 and completed on Oct. 09, 2018. We, SPORTON INTERNATIONAL INC., would like to declare that the tested sample has been evaluated in accordance with the test procedures and has been in compliance with the applicable technical standards.

The report must not be used by the client to claim product certification, approval, or endorsement by TAF or any agency of government.

The test results in this report apply exclusively to the tested model / sample. Without written approval of SPORTON INTERNATIONAL INC. EMC & Wireless Communications Laboratory, the test report shall not be reproduced except in full.

Approved by: Joseph Lin

**SPORTON INTERNATIONAL INC. EMC & Wireless Communications Laboratory**  
No. 52, Huaya 1st Rd., Guishan Dist., Taoyuan City, Taiwan (R.O.C.)



## Table of Contents

History of this test report.....	3
Summary of Test Result.....	4
<b>1 General Description .....</b>	<b>5</b>
1.1 Product Feature of Equipment Under Test .....	5
1.2 Product Specification of Equipment Under Test .....	7
1.3 Modification of EUT .....	7
1.4 Testing Location .....	8
1.5 Applicable Standards.....	8
<b>2 Test Configuration of Equipment Under Test.....</b>	<b>9</b>
2.1 Carrier Frequency and Channel .....	9
2.2 Test Mode .....	10
2.3 Connection Diagram of Test System .....	11
2.4 Support Unit used in test configuration and system .....	12
2.5 EUT Operation Test Setup .....	12
2.6 Measurement Results Explanation Example .....	12
<b>3 Test Result .....</b>	<b>13</b>
3.1 26dB & 99% Occupied Bandwidth Measurement.....	13
3.2 Maximum Conducted Output Power Measurement .....	15
3.3 Power Spectral Density Measurement.....	17
3.4 Unwanted Emissions Measurement.....	19
3.5 AC Conducted Emission Measurement .....	24
3.6 Automatically Discontinue Transmission.....	26
3.7 Antenna Requirements.....	27
<b>4 List of Measuring Equipment.....</b>	<b>28</b>
<b>5 Uncertainty of Evaluation.....</b>	<b>30</b>
<b>Appendix A. Conducted Test Results</b>	
<b>Appendix B. AC Conducted Emission Test Result</b>	
<b>Appendix C. Radiated Spurious Emission</b>	
<b>Appendix D. Radiated Spurious Emission Plots</b>	
<b>Appendix E. Duty Cycle Plots</b>	





## Summary of Test Result

Report Clause	Ref Std. Clause	Test Items	Result (PASS/FAIL)	Remark
3.1	15.403(i)	26dB Bandwidth	Pass	-
3.1	2.1049	99% Occupied Bandwidth	Reporting only	-
3.2	15.407(a)	Maximum Conducted Output Power	Pass	-
3.3	15.407(a)	Power Spectral Density	Pass	-
3.4	15.407(b)	Unwanted Emissions	Pass	Under limit 3.21 dB at 5150.000 MHz
3.5	15.207	AC Conducted Emission	Pass	Under limit 17.07 dB at 0.152 MHz
3.6	15.407(c)	Automatically Discontinue Transmission	Pass	-
3.7	15.203 15.407(a)	Antenna Requirement	Pass	-

**Reviewed by: Wii Chang**

**Report Producer: Natasha Hsieh**



# 1 General Description

## 1.1 Product Feature of Equipment Under Test

Product Feature	
Equipment	Mobile Cellular Phone
Brand Name	Motorola
Model Name	XT1962-4
Sample 1	Dual SIM
Sample 2	Single SIM
FCC ID	IHDT56XP2
IMEI Code	<b>Conducted :</b> IMEI 1: 355570090015416 IMEI 2: 355570090015424 <b>Conduction :</b> IMEI 1: 355570090016372 IMEI 2: 355570090016380 <b>Radiation :</b> IMEI 1: 355570090016257 IMEI 2: 355570090016265
EUT supports Radios application	GSM/EGPRS/WCDMA/HSPA/LTE/GNSS/FM WLAN 11b/g/n HT20 WLAN 11a/n HT20/HT40 Bluetooth BR/EDR/LE
HW Version	DVT1-B
EUT Stage	Identical Prototype

Remark: The above EUT's information was declared by manufacturer.



<b>Accessory List</b>	
<b>AC Adapter 1</b>	Brand Name : Motorola
	Model Name : SC-51
	Manufacturer : Salom
<b>AC Adapter 1</b>	Brand Name : Motorola
	Model Name : SC-52
	Manufacturer : Salom
<b>AC Adapter 1</b>	Brand Name : Motorola
	Model Name : SC-57
	Manufacturer : Salom
<b>AC Adapter 1</b>	Brand Name : Motorola
	Model Name : SC-56
	Manufacturer : Salom
<b>AC Adapter 1</b>	Brand Name : Motorola
	Model Name : SC-52
	Manufacturer : Salom
<b>AC Adapter 1</b>	Brand Name : Motorola
	Model Name : SC-57
	Manufacturer : Flex
<b>AC Adapter 2</b>	Brand Name : Motorola
	Model Name : SC-51
	Manufacturer : Chenyang
<b>AC Adapter 2</b>	Brand Name : Motorola
	Model Name : SC-52
	Manufacturer : Chenyang
<b>AC Adapter 2</b>	Brand Name : Motorola
	Model Name : SC-56
	Manufacturer : Chenyang
<b>AC Adapter 2</b>	Brand Name : Motorola
	Model Name : SC-57
	Manufacturer : Cliptech
<b>Battery</b>	Brand Name : Motorola
	Model Name : JG30
	Manufacturer : Amperex
<b>Earphone</b>	Brand Name : Motorola
	Model Name : SH38C37773
	Manufacturer : Lyand
<b>USB Cable 1</b>	Brand Name : Luxshare
	Model Name : SKN6473A
<b>USB Cable 2</b>	Brand Name : Cabletech
	Model Name : SKN6473A
<b>USB Cable 3</b>	Brand Name : Saibao
	Model Name : SKN6473A

## 1.2 Product Specification of Equipment Under Test

Standards-related Product Specification	
<b>Tx/Rx Frequency Range</b>	5180 MHz ~ 5240 MHz 5260 MHz ~ 5320 MHz 5500 MHz ~ 5720 MHz
<b>Maximum Output Power to Antenna</b>	<b>&lt;5180 MHz ~ 5240 MHz&gt;</b> 802.11a : 14.49 dBm / 0.0281 W 802.11n HT20 : 14.47 dBm / 0.0280 W 802.11n HT40 : 14.48 dBm / 0.0281 W <b>&lt;5260 MHz ~ 5320 MHz&gt;</b> 802.11a : 14.39 dBm / 0.0275 W 802.11n HT20 : 14.47 dBm / 0.0280 W 802.11n HT40 : 14.44 dBm / 0.0278 W <b>&lt;5500 MHz ~ 5700 MHz &gt;</b> 802.11a : 14.49 dBm / 0.0281 W 802.11n HT20 : 14.34 dBm / 0.0272 W 802.11n HT40 : 14.47 dBm / 0.0280 W
<b>99% Occupied Bandwidth</b>	802.11a : 18.00 MHz 802.11n HT20 : 18.75 MHz 802.11n HT40 : 37.00 MHz
<b>Antenna Type / Gain</b>	<b>&lt;5150 MHz ~ 5250 MHz&gt;</b> IFA Antenna with gain 0.0 dBi <b>&lt;5250 MHz ~ 5350 MHz&gt;</b> IFA Antenna with gain 0.0 dBi <b>&lt;5470 MHz ~ 5725 MHz&gt;</b> IFA Antenna with gain 0.0 dBi
<b>Type of Modulation</b>	802.11a/n : OFDM (BPSK / QPSK / 16QAM / 64QAM)

Remark: The WLAN operation in 5600 MHz ~ 5650 MHz is notched.

## 1.3 Modification of EUT

No modifications are made to the EUT during all test items.



### 1.4 Testing Location

Sporton Lab is accredited to ISO 17025 by Taiwan Accreditation Foundation (TAF code : 1190) and the FCC designation No. TW1190 and TW0007 under the FCC 2.948(e) by Mutual Recognition Agreement (MRA) in FCC Test.

<b>Test Site</b>	SPORTON INTERNATIONAL INC.	
<b>Test Site Location</b>	No.52, Huaya 1st Rd., Guishan Dist., Taoyuan City, Taiwan (R.O.C.) TEL: +886-3-327-3456 FAX: +886-3-328-4978	
<b>Test Site No.</b>	<b>Sporton Site No.</b>	
	TH05-HY	CO05-HY

**Note:** The test site complies with ANSI C63.4 2014 requirement.

<b>Test Site</b>	SPORTON INTERNATIONAL INC.	
<b>Test Site Location</b>	No.58, Aly. 75, Ln. 564, Wenhua 3rd, Rd., Guishan Dist., Taoyuan City, Taiwan (R.O.C.) TEL: +886-3-327-0868 FAX: +886-3-327-0855	
<b>Test Site No.</b>	<b>Sporton Site No.</b>	
	03CH11-HY	

**Note:** The test site complies with ANSI C63.4 2014 requirement.

### 1.5 Applicable Standards

According to the specifications of the manufacturer, the EUT must comply with the requirements of the following standards:

- ♦ FCC Part 15 Subpart E
- ♦ FCC KDB 789033 D02 General UNII Test Procedures New Rules v02r01.
- ♦ FCC KDB 414788 D01 Radiated Test Site v01r01.
- ♦ ANSI C63.10-2013

**Remark:**

1. All test items were verified and recorded according to the standards and without any deviation during the test.
2. This EUT has also been tested and complied with the requirements of FCC Part 15, Subpart B, recorded in a separate test report.





## 2 Test Configuration of Equipment Under Test

- a. The EUT has been associated with peripherals and configuration operated in a manner tended to maximize its emission characteristics in a typical application. Frequency range investigated: conduction emission (150 kHz to 30 MHz), radiation emission (9 kHz to the 10th harmonic of the highest fundamental frequency or to 40 GHz, whichever is lower). For radiated measurement, pre-scanned in three orthogonal panels, X, Y, Z. The worst cases (X plane) were recorded in this report.
- b. AC power line Conducted Emission was tested under maximum output power.

### 2.1 Carrier Frequency and Channel

Frequency Band	Channel	Freq. (MHz)	Channel	Freq. (MHz)
5150-5250 MHz Band 1 (U-NII-1)	36	5180	44	5220
	38*	5190	46*	5230
	40	5200	48	5240
	-	-		

Frequency Band	Channel	Freq. (MHz)	Channel	Freq. (MHz)
5250-5350 MHz Band 2 (U-NII-2A)	52	5260	60	5300
	54*	5270	62*	5310
	56	5280	64	5320
	-	-		

Frequency Band	Channel	Freq. (MHz)	Channel	Freq. (MHz)
5470-5725 MHz Band 3 (U-NII-2C)	100	5500	112	5560
	102*	5510	116	5580
	104	5520	132	5660
	-	-	134*	5670
	108	5540	136	5680
	110*	5550	140	5700

**Note:** The above Frequency and Channel in "\*" were 802.11n HT40.



## 2.2 Test Mode

Final test modes are considering the modulation and worse data rates as below table.

Modulation	Data Rate
802.11a	6 Mbps
802.11n HT20	MCS0
802.11n HT40	MCS0

Test Cases	
<b>AC Conducted Emission</b>	Mode 1 : GSM850 Idle + Bluetooth Link + WLAN (5GHz) Link + MP3 + Earphone + Battery + USB Cable 1 Type C (Charging from Adapter 1)
<b>Remark:</b> For Radiated Test Cases, the tests were performed with Adapter 1 and USB Cable 1 Type C for Sample 1.	

Ch. #		Band I : 5150-5250 MHz	Band II : 5250-5350 MHz	Band III : 5470-5725MHz
		802.11a	802.11a	802.11a
L	Low	36	52	100
M	Middle	44	60	116
H	High	48	64	140

Ch. #		Band I : 5150-5250 MHz	Band II : 5250-5350 MHz	Band III : 5470-5725MHz
		802.11n HT20	802.11n HT20	802.11n HT20
L	Low	36	52	100
M	Middle	44	60	116
H	High	48	64	140

Ch. #		Band I : 5150-5250 MHz	Band II : 5250-5350 MHz	Band III : 5470-5725MHz
		802.11n HT40	802.11n HT40	802.11n HT40
L	Low	38	54	102
M	Middle	-	-	110
H	High	46	62	134

## 2.3 Connection Diagram of Test System

<WLAN Tx Mode>

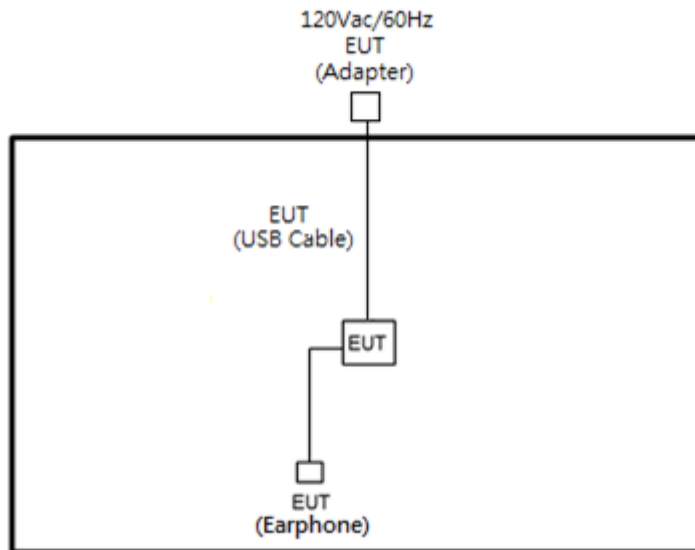

<AC Conducted Emission Mode>

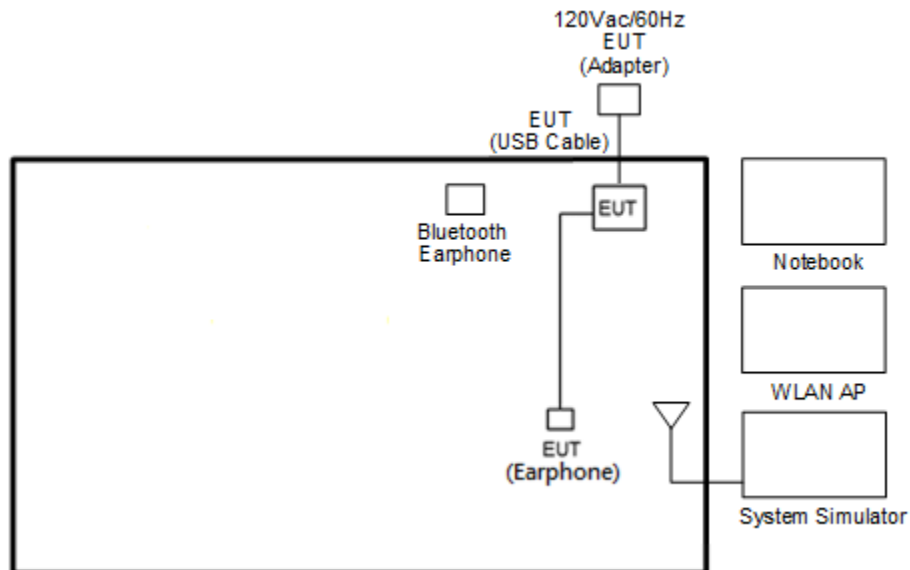

## 2.4 Support Unit used in test configuration and system

Item	Equipment	Trade Name	Model Name	FCC ID	Data Cable	Power Cord
1.	System Simulator	Anritsu	MT8820C	N/A	N/A	Unshielded, 1.8 m
2.	Bluetooth Earphone	Sony Ericsson	MW600	PY700A2029	N/A	N/A
3.	WLAN AP	ASUS	RT-AC66U	MSQ-RTAC66U	N/A	Unshielded, 1.8 m
4.	Notebook	DELL	P20G	FCC DoC	N/A	AC I/P: Unshielded, 1.2 m DC O/P: Shielded, 1.8 m
5.	SD Card	SanDisk	MicroSD HC	FCC DoC	N/A	N/A

## 2.5 EUT Operation Test Setup

The RF test items, utility “CMD” was installed in Notebook which was programmed in order to make the EUT get into the engineering modes to provide channel selection, power level, data rate and the application type and for continuous transmitting signals.

## 2.6 Measurement Results Explanation Example

**For all conducted test items:**

The offset level is set in the spectrum analyzer to compensate the RF cable loss and attenuator factor between EUT conducted output port and spectrum analyzer. With the offset compensation, the spectrum analyzer reading level is exactly the EUT RF output level.

Example :

The spectrum analyzer offset is derived from RF cable loss and attenuator factor.

*Offset = RF cable loss + attenuator factor.*

Following shows an offset computation example with cable loss 4.2 dB and 10dB attenuator.

$$\begin{aligned}
 \text{Offset(dB)} &= \text{RF cable loss(dB)} + \text{attenuator factor(dB)}. \\
 &= 4.2 + 10 = 14.2 \text{ (dB)}
 \end{aligned}$$

### 3 Test Result

#### 3.1 26dB & 99% Occupied Bandwidth Measurement

##### 3.1.1 Description of 26dB & 99% Occupied Bandwidth

This section is for reporting purpose only.

There is no restriction limits for bandwidth.

##### 3.1.2 Measuring Instruments

See list of measuring equipment of this test report.

##### 3.1.3 Test Procedures

1. The testing follows FCC KDB 789033 D02 General UNII Test Procedures New Rules v02r01. Section C) Emission bandwidth
2. Set RBW = approximately 1% of the emission bandwidth.
3. Set the VBW > RBW.
4. Detector = Peak.
5. Trace mode = max hold
6. Measure the maximum width of the emission that is 26 dB down from the peak of the emission. Compare this with the RBW setting of the analyzer. Readjust RBW and repeat measurement as needed until the RBW/EBW ratio is approximately 1%.
7. For 99% Bandwidth Measurement, the spectrum analyzer's resolution bandwidth (RBW) is set 1-5% of the emission bandwidth and set the Video bandwidth (VBW)  $\geq 3 * RBW$ .
8. Measure and record the results in the test report.

##### 3.1.4 Test Setup

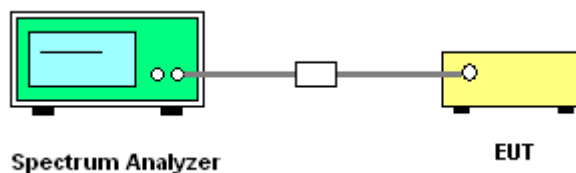

##### 3.1.5 Test Result of 26dB & 99% Occupied Bandwidth

Please refer to Appendix A.

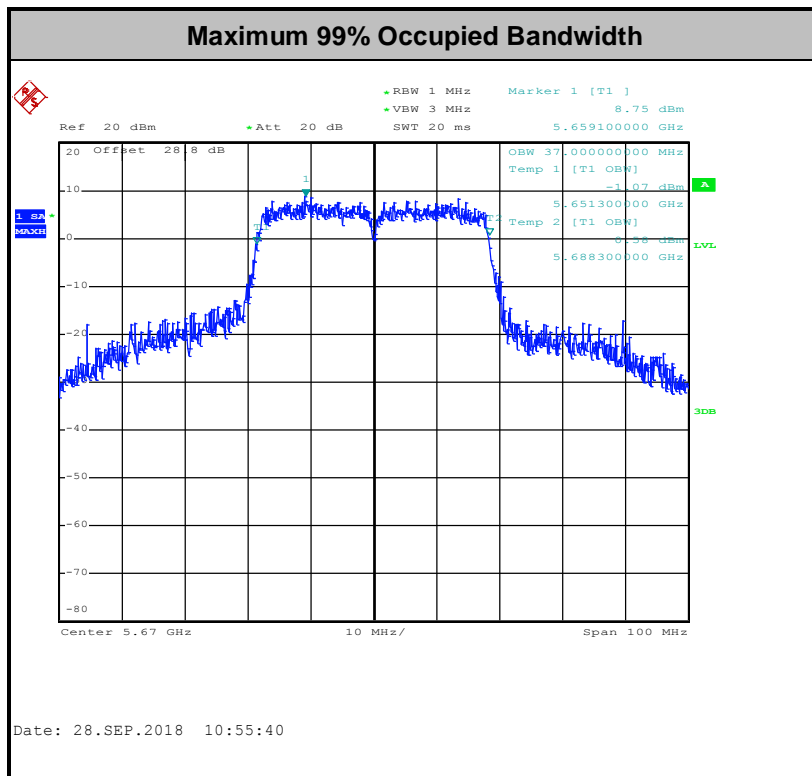
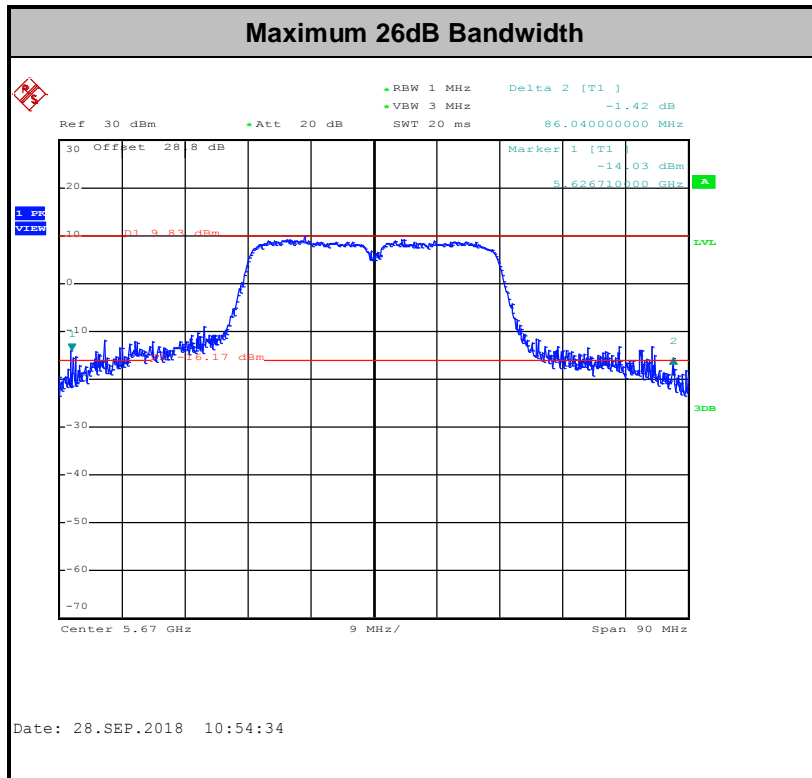

**Note:** The occupied channel bandwidth is maintained within the band of operation for all of the modulations.



## 3.2 Maximum Conducted Output Power Measurement

### 3.2.1 Limit of Maximum Conducted Output Power

<FCC 14-30 CFR 15.407>

**For the 5.15–5.25 GHz bands:**

- For mobile and portable client devices in the 5.15–5.25 GHz band, the maximum conducted output power over the frequency band of operation shall not exceed 250 mW. For an indoor access point operating in the band 5.15-5.25 GHz, the maximum conducted output power over the frequency band of operation shall not exceed 1 W.

**For the 5.25–5.725 GHz bands:**

- The maximum conducted output power over the frequency bands of operation shall not exceed the lesser of 250 mW or  $11 \text{ dBm} + 10 \log B$ , where B is the 26 dB emission bandwidth in megahertz.

If transmitting antennas of directional gain greater than 6 dBi are used, the peak output power shall be reduced by the amount in dB that the directional gain of the antenna exceeds 6 dBi.

Note that U-NII-2 band, devices with a maximum e.i.r.p. greater than 500 mW shall implement TPC in order to have the capability to operate at least 6 dB below the maximum permitted e.i.r.p. of 1 W.

### 3.2.2 Measuring Instruments

See list of measuring equipment of this test report.

### 3.2.3 Test Procedures

The testing follows Method PM of FCC KDB 789033 D02 General UNII Test Procedures New Rules v02r01.

Method PM (Measurement using an RF average power meter):

1. Measurement is performed using a wideband RF power meter.
2. The EUT is configured to transmit continuously with a consistent duty cycle at its maximum power control level.
3. Measure the average power of the transmitter, and the average power is corrected with duty factor,  $10 \log(1/x)$ , where x is the duty cycle.

### 3.2.4 Test Setup

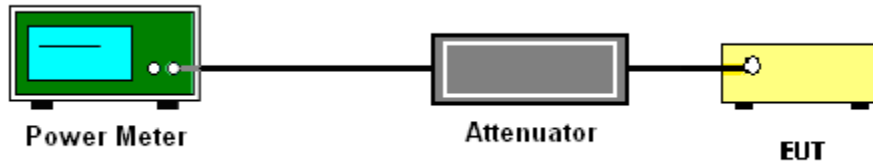

### 3.2.5 Test Result of Maximum Conducted Output Power

Please refer to Appendix A.





### 3.3 Power Spectral Density Measurement

#### 3.3.1 Limit of Power Spectral Density

<FCC 14-30 CFR 15.407>

**For the 5.15–5.25 GHz bands:**

For mobile and portable client devices in the 5.15–5.25 GHz band, the maximum power spectral density shall not exceed 11 dBm in any 1.0 MHz band. For an indoor access point operating in the band 5.15-5.25 GHz, the maximum power spectral density shall not exceed 17 dBm in any 1.0 MHz band.

**For the 5.25–5.725 GHz bands:**

The maximum power spectral density shall not exceed 11 dBm in any 1.0 MHz band.

If transmitting antennas of directional gain greater than 6 dBi are used, the peak output power shall be reduced by the amount in dB that the directional gain of the antenna exceeds 6 dBi.

#### 3.3.2 Measuring Instruments

See list of measuring equipment of this test report.

#### 3.3.3 Test Procedures

The testing follows FCC KDB 789033 D02 General UNII Test Procedures New Rules v02r01. Section F) Maximum power spectral density.

**# Method SA-2 #**

(trace averaging across on and off times of the EUT transmissions, followed by duty cycle correction).

- Measure the duty cycle.
  - Set span to encompass the entire emission bandwidth (EBW) of the signal.
  - Set RBW = 1 MHz.
  - Set VBW  $\geq$  3 MHz.
  - Number of points in sweep  $\geq$  2 Span / RBW.
  - Sweep time = auto.
  - Detector = RMS
  - Trace average at least 100 traces in power averaging mode.
  - Add  $10 \log(1/x)$ , where x is the duty cycle, to the measured power in order to compute the average power during the actual transmission times. For example, add  $10 \log(1/0.25) = 6$  dB if the duty cycle is 25 percent.
1. The RF output of EUT was connected to the spectrum analyzer by a low loss cable.
  2. Each plot has already offset with cable loss, and attenuator loss. Measure the PPSD and record it.





### 3.4 Unwanted Emissions Measurement

This section is to measure unwanted emissions through radiated measurement for band edge spurious emissions and out of band emissions measurement.

#### 3.4.1 Limit of Unwanted Emissions

- (1) For transmitters operating in the 5150-5250 MHz band: all emissions outside of the 5150-5350 MHz band shall not exceed an EIRP of -27dBm/MHz.

For transmitters operating in the 5250-5350 MHz band: all emissions outside of the 5150-5350 MHz band shall not exceed an EIRP of -27 dBm/MHz. Devices operating in the 5250-5350 MHz band that generate emissions in the 5150-5250 MHz band must meet all applicable technical requirements for operation in the 5150-5250 MHz band (including indoor use) or alternatively meet an out-of-band emission EIRP limit of -27 dBm/MHz in the 5150-5250 MHz band.

For transmitters operating in the 5470-5600 MHz and 5650-5725MHz band: all emissions outside of the 5470-5600 MHz and 5650-5725MHz band shall not exceed an EIRP of -27 dBm/MHz.

- (2) Unwanted spurious emissions fallen in restricted bands shall comply with the general field strength limits as below table,

Frequency (MHz)	Field Strength (microvolts/meter)	Measurement Distance (meters)
0.009 – 0.490	2400/F(kHz)	300
0.490 – 1.705	24000/F(kHz)	30
1.705 – 30.0	30	30
30 – 88	100	3
88 – 216	150	3
216 - 960	200	3
Above 960	500	3

**Note:** The following formula is used to convert the EIRP to field strength.

$$E = \frac{1000000\sqrt{30P}}{3} \mu\text{V/m, where P is the eirp (Watts)}$$



EIRP (dBm)	Field Strength at 3m (dBµV/m)
- 27	68.3

(3) KDB789033 D02 v02r01 G)2)c)

- (i) Section 15.407(b)(1) to (b)(3) specify the unwanted emission limits for the U-NII-1 and U-NII-2 bands. As specified, emissions above 1000 MHz that are outside of the restricted bands are subject to a peak emission limit of -27 dBm/MHz.<sup>3</sup>
- (ii) Section 15.407(b)(4) specifies the unwanted emission limit for the U-NII-3 band. A band emissions mask is specified in Section 15.407(b)(4)(i). The emission limits are in terms of a Peak detector. An alternative to the band emissions mask is specified in Section 15.407(b)(4)(ii). The alternative limits are based on the highest antenna gain specified in the filing. There are also marketing and importation restrictions for the devices using the alternative limit.<sup>4</sup>

**Note 3:** An out-of-band emission that complies with both the average and peak limits of Section 15.209 is not required to satisfy the -27 dBm/MHz peak emission limit.

**Note 4:** Only devices with antenna gains of 10 dBi or less may be approved using the emission limits specified in Section 15.247(d) till March 2, 2018; all other devices operating in this band must use the mask specified in Section 15.407(b)(4)(i).

### 3.4.2 Measuring Instruments

See list of measuring equipment of this test report.

### 3.4.3 Test Procedures

1. The testing follows FCC KDB 789033 D02 General UNII Test Procedures New Rules v02r01. Section G) Unwanted emissions measurement.
  - (1) Procedure for Unwanted Emissions Measurements Below 1000MHz
    - RBW = 120 kHz
    - VBW = 300 kHz
    - Detector = Peak
    - Trace mode = max hold
  - (2) Procedure for Peak Unwanted Emissions Measurements Above 1000 MHz
    - RBW = 1 MHz
    - VBW ≥ 3 MHz
    - Detector = Peak
    - Sweep time = auto
    - Trace mode = max hold



(3) Procedures for Average Unwanted Emissions Measurements Above 1000MHz

- RBW = 1 MHz
  - VBW = 10 Hz, when duty cycle is no less than 98 percent.
  - $VBW \geq 1/T$ , when duty cycle is less than 98 percent where T is the minimum transmission duration over which the transmitter is on and is transmitting at its maximum power control level for the tested mode of operation.
2. The EUT was placed on a turntable with 0.8 meter for frequency below 1GHz and 1.5 meter for frequency above 1GHz respectively above ground.
  3. The EUT was set 3 meters from the interference receiving antenna which was mounted on the top of a variable height antenna tower.
  4. The antenna is a broadband antenna and its height is adjusted between one meter and four meters above ground to find the maximum value of the field strength for both horizontal polarization and vertical polarization of the antenna.
  5. For each suspected emission, the EUT was arranged to its worst case and then adjust the antenna tower (from 1 m to 4 m) and turntable (from 0 degree to 360 degrees) to find the maximum reading.
  6. For testing below 1GHz, if the emission level of the EUT in peak mode was 3 dB lower than the limit specified, then peak values of EUT will be reported, otherwise, the emissions will be repeated one by one using the CISPR quasi-peak method and reported.
  7. For testing above 1GHz, the emission level of the EUT in peak mode was 20dB lower than average limit (that means the emission level in average mode also complies with the limit in average mode), then peak values of EUT will be reported, otherwise, the emissions will be measured in average mode again and reported.

### 3.4.4 Test Setup

For radiated emissions below 30MHz

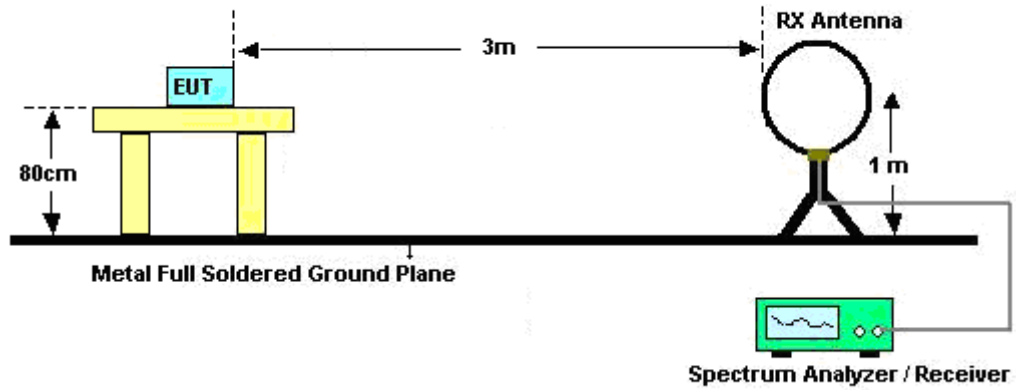

For radiated emissions from 30MHz to 1GHz

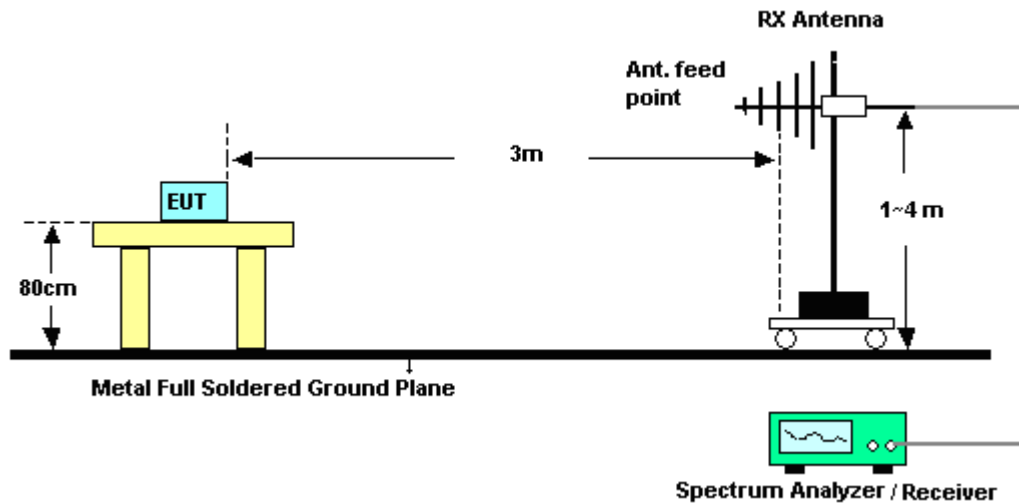

For radiated emissions above 1GHz

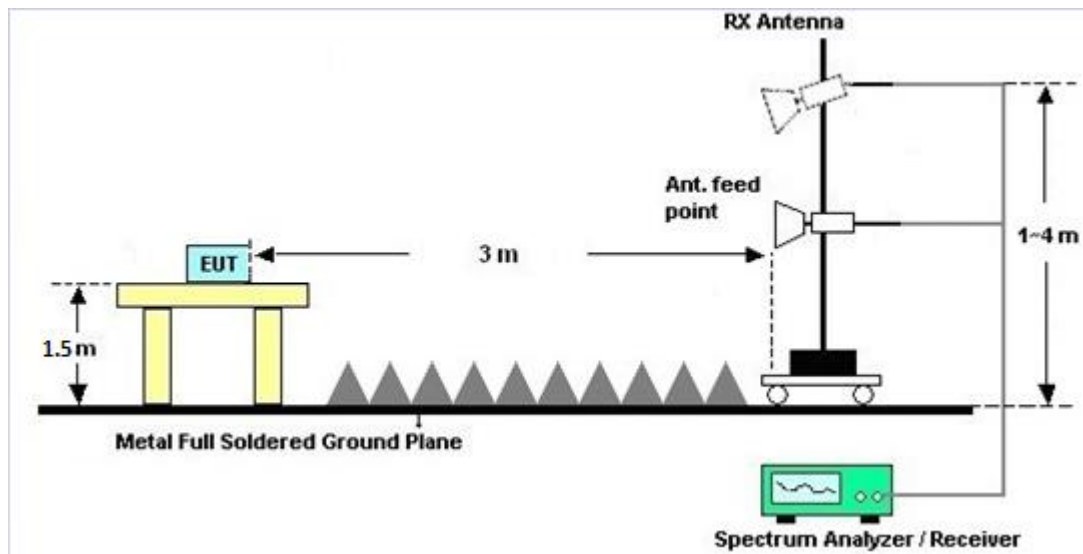

### 3.4.5 Test Results of Radiated Spurious Emissions (9 kHz ~ 30 MHz)

The low frequency, which started from 9 kHz to 30MHz, was pre-scanned and the result which was 20dB lower than the limit line was not reported.

There is a comparison data of both open-field test site and alternative test site - semi-Anechoic chamber according to 414788 D01 Radiated Test Site v01r01, and the result came out very similar.

### 3.4.6 Test Result of Radiated Spurious at Band Edges

Please refer to Appendix C and D.

### 3.4.7 Duty Cycle

Please refer to Appendix E.

### 3.4.8 Test Result of Radiated Spurious Emissions (30MHz ~ 10th Harmonic)

Please refer to Appendix C and D.



### 3.5 AC Conducted Emission Measurement

#### 3.5.1 Limit of AC Conducted Emission

For equipment that is designed to be connected to the public utility (AC) power line, the radio frequency voltage that is conducted back onto the AC power line on any frequency or frequencies within the band 150 kHz to 30 MHz shall not exceed the limits in the following table.

Frequency of emission (MHz)	Conducted limit (dB $\mu$ V)	
	Quasi-peak	Average
0.15-0.5	66 to 56*	56 to 46*
0.5-5	56	46
5-30	60	50

\*Decreases with the logarithm of the frequency.

#### 3.5.2 Measuring Instruments

See list of measuring equipment of this test report.

#### 3.5.3 Test Procedures

1. The EUT was placed 0.4 meter from the conducting wall of the shielding room was kept at least 80 centimeters from any other grounded conducting surface.
2. Connect EUT to the power mains through a line impedance stabilization network (LISN).
3. All the support units are connecting to the other LISN.
4. The LISN provides 50 ohm coupling impedance for the measuring instrument.
5. The FCC states that a 50 ohm, 50 microhenry LISN should be used.
6. Both sides of AC line were checked for maximum conducted interference.
7. The frequency range from 150 kHz to 30 MHz was searched.
8. Set the test-receiver system to Peak Detect Function and specified bandwidth with Maximum Hold Mode.



### 3.5.4 Test Setup

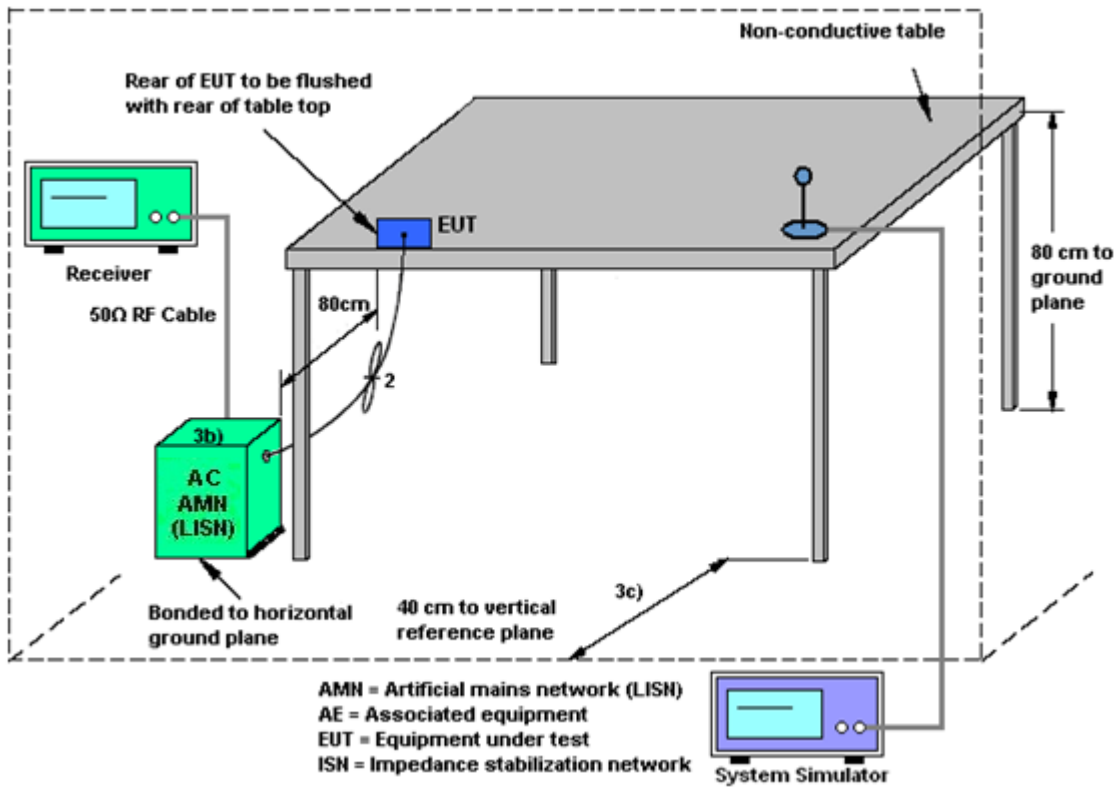

### 3.5.5 Test Result of AC Conducted Emission

Please refer to Appendix B.



## **3.6 Automatically Discontinue Transmission**

### **3.6.1 Limit of Automatically Discontinue Transmission**

The device shall automatically discontinue transmission in case of either absence of information to transmit or operational failure. These provisions are not intended to preclude the transmission of control or signaling information or the use of repetitive codes used by certain digital technologies to complete frame or burst intervals. Applicants shall include in their application for equipment authorization to describe how this requirement is met.

### **3.6.2 Measuring Instruments**

See list of measuring equipment of this test report.

### **3.6.3 Test Result of Automatically Discontinue Transmission**

While the EUT is not transmitting any information, the EUT can automatically discontinue transmission and become standby mode for power saving. The EUT can detect the controlling signal of ACK message transmitting from remote device and verify whether it shall resend or discontinue transmission.



## **3.7 Antenna Requirements**

### **3.7.1 Standard Applicable**

If transmitting antenna directional gain is greater than 6 dBi, both the peak transmit power and the peak power spectral density shall be reduced by the amount in dB that the directional gain of the antenna exceeds 6 dBi.

### **3.7.2 Antenna Anti-Replacement Construction**

An embedded-in antenna design is used.

### **3.7.3 Antenna Gain**

The antenna peak gain of EUT is less than 6 dBi. Therefore, it is not necessary to reduce maximum peak output power limit.



## 4 List of Measuring Equipment

Instrument	Manufacturer	Model No.	Serial No.	Characteristics	Calibration Date	Test Date	Due Date	Remark
Hygrometer	Testo	DTM-303A	TP157075	N/A	Mar. 06, 2018	Sep. 20, 2018~ Oct. 09, 2018	Mar. 05, 2019	Conducted (TH05-HY)
Power Meter	Anritsu	ML2495A	1132003	N/A	Aug. 16, 2018	Sep. 20, 2018~ Oct. 09, 2018	Aug. 15, 2019	Conducted (TH05-HY)
Power Sensor	Anritsu	MA2411B	1126017	300MHz~40GHz	Aug. 16, 2018	Sep. 20, 2018~ Oct. 09, 2018	Aug. 15, 2019	Conducted (TH05-HY)
Spectrum Analyzer	Rohde & Schwarz	FSP40	100057	9kHz-40GHz	Nov. 21, 2017	Sep. 20, 2018~ Oct. 09, 2018	Nov. 20, 2018	Conducted (TH05-HY)
Signal Analyzer	Rohde & Schwarz	FSV40	101397	10Hz~40GHz	Nov. 07, 2017	Sep. 20, 2018~ Oct. 09, 2018	Nov. 06, 2018	Conducted (TH05-HY)
Switch Box & RF Cable	Burgeon	ETF-058	EC130048 4	N/A	Mar. 01, 2018	Sep. 20, 2018~ Oct. 09, 2018	Feb. 28, 2019	Conducted (TH05-HY)
AC Power Source	ChainTek	APC-1000W	N/A	N/A	N/A	Oct. 04, 2018	N/A	Conduction (CO05-HY)
EMI Test Receiver	Rohde & Schwarz	ESR3	102388	9KHz~3.6GHz	Dec. 08, 2017	Oct. 04, 2018	Dec. 07, 2018	Conduction (CO05-HY)
Hygrometer	Testo	608-H1	34913912	N/A	Mar. 06, 2018	Oct. 04, 2018	Mar. 05, 2019	Conduction (CO05-HY)
LISN	Rohde & Schwarz	ENV216	100080	9kHz~30MHz	Nov. 30, 2017	Oct. 04, 2018	Nov. 29, 2018	Conduction (CO05-HY)
Software	Rohde & Schwarz	EMC32 V10.30	N/A	N/A	N/A	Oct. 04, 2018	N/A	Conduction (CO05-HY)
LF Cable	HUBER + SUHNER	RG-214/U	LF01	N/A	Jan. 03, 2018	Oct. 04, 2018	Jan. 02, 2019	Conduction (CO05-HY)
Pulse Limiter	Rohde & Schwarz	ESH3-Z2	100851	N/A	Jan. 03, 2018	Oct. 04, 2018	Jan. 02, 2019	Conduction (CO05-HY)
Loop Antenna	Rohde & Schwarz	HFH2-Z2	100488	9 kHz~30 MHz	Nov. 23, 2017	Oct. 01, 2018~ Oct. 06, 2018	Nov. 22, 2018	Radiation (03CH11-HY)
Bilog Antenna	TESEQ	CBL 6111D&N-6-0 6	35414&AT- N0602	30MHz~1GHz	Oct. 14, 2017	Oct. 01, 2018~ Oct. 06, 2018	Oct. 13, 2018	Radiation (03CH11-HY)
Preamplifier	Jet-Power	JPA0118-55-3 03K	171000180 0054002	1GHz~18GHz	Apr. 17, 2018	Oct. 01, 2018~ Oct. 06, 2018	Apr. 16, 2019	Radiation (03CH11-HY)
Spectrum Analyzer	Keysight	N9010A	MY542004 86	10Hz ~ 44GHz	Oct. 19, 2017	Oct. 01, 2018~ Oct. 06, 2018	Oct. 18, 2018	Radiation (03CH11-HY)
Horn Antenna	SCHWARZBE CK	BBHA 9120 D	9120D-132 6	1GHz ~ 18GHz	Oct. 16, 2017	Oct. 01, 2018~ Oct. 06, 2018	Oct. 15, 2018	Radiation (03CH11-HY)
Hygrometer	TECPEL	DTN-303B	TP140325	N/A	Oct. 12, 2017	Oct. 01, 2018~ Oct. 06, 2018	Oct. 11, 2018	Radiation (03CH11-HY)
Preamplifier	Keysight	83017A	MY532700 80	1GHz~26.5GHz	Jan. 16, 2018	Oct. 01, 2018~ Oct. 06, 2018	Jan. 15, 2020	Radiation (03CH11-HY)
Spectrum Analyzer	Keysight	N9010A	MY542004 86	10Hz ~ 44GHz	Oct. 19, 2017	Oct. 01, 2018~ Oct. 06, 2018	Oct. 18, 2018	Radiation (03CH11-HY)



Instrument	Manufacturer	Model No.	Serial No.	Characteristics	Calibration Date	Test Date	Due Date	Remark
Controller	EMEC	EM 1000	N/A	Control Turn table & Ant Mast	N/A	Oct. 01, 2018~ Oct. 06, 2018	N/A	Radiation (03CH11-HY)
Antenna Mast	EMEC	AM-BS-4500-B	N/A	1~4m	N/A	Oct. 01, 2018~ Oct. 06, 2018	N/A	Radiation (03CH11-HY)
Turn Table	EMEC	TT 2000	N/A	0~360 Degree	N/A	Oct. 01, 2018~ Oct. 06, 2018	N/A	Radiation (03CH11-HY)
Amplifier	MITEQ	TTA1840-35-HG	1871923	18GHz~40GHz, VSWR : 2.5:1 max	Jul. 16, 2018	Oct. 01, 2018~ Oct. 06, 2018	Jul. 15, 2019	Radiation (03CH11-HY)
SHF-EHF Horn Antenna	SCHWARZBECK	BBHA 9170	BBHA9170 584	18GHz- 40GHz	Nov. 27, 2017	Oct. 01, 2018~ Oct. 06, 2018	Nov. 26, 2018	Radiation (03CH11-HY)
Software	Audix	E3 6.2009-8-24	RK-00104 2	N/A	N/A	Oct. 01, 2018~ Oct. 06, 2018	N/A	Radiation (03CH11-HY)
RF Cable	HUBER + SUHNER	SUCOFLEX 104	MY9837/4 PE	9kHz-30MHz	Mar. 14, 2018	Oct. 01, 2018~ Oct. 06, 2018	Mar. 13, 2019	Radiation (03CH11-HY)
RF Cable	HUBER + SUHNER	SUCOFLEX 102	MY2859/2	30MHz-40GHz	Mar. 14, 2018	Oct. 01, 2018~ Oct. 06, 2018	Mar. 13, 2019	Radiation (03CH11-HY)
RF Cable	HUBER + SUHNER	SUCOFLEX 104	MY9837/4 PE	30M-18G	Mar. 14, 2018	Oct. 01, 2018~ Oct. 06, 2018	Mar. 13, 2019	Radiation (03CH11-HY)
RF Cable	HUBER + SUHNER	SUCOFLEX 102	MY4274/2	30MHz-40GHz	Mar. 14, 2018	Oct. 01, 2018~ Oct. 06, 2018	Mar. 13, 2019	Radiation (03CH11-HY)
Filter	Wainwright	WLK4-1000-1 530-8000-40S S	SN11	1G Low Pass	Sep. 17, 2018	Oct. 01, 2018~ Oct. 06, 2018	Sep. 16, 2019	Radiation (03CH11-HY)
Filter	Wainwright	WHKX12-270 0-3000-18000 -60SS	SN3	2.7G High Pass	Sep. 17, 2018	Oct. 01, 2018~ Oct. 06, 2018	Sep. 16, 2019	Radiation (03CH11-HY)



## 5 Uncertainty of Evaluation

### Uncertainty of Conducted Emission Measurement (150kHz ~ 30MHz)

Measuring Uncertainty for a Level of Confidence of 95% ( $U = 2Uc(y)$ )	2.20
---	------

### Uncertainty of Radiated Emission Measurement (30 MHz ~ 1000 MHz)

Measuring Uncertainty for a Level of Confidence of 95% ( $U = 2Uc(y)$ )	5.20
---	------

### Uncertainty of Radiated Emission Measurement (1000 MHz ~ 18000 MHz)

Measuring Uncertainty for a Level of Confidence of 95% ( $U = 2Uc(y)$ )	5.50
---	------

### Uncertainty of Radiated Emission Measurement (18000 MHz ~ 40000 MHz)

Measuring Uncertainty for a Level of Confidence of 95% ( $U = 2Uc(y)$ )	5.20
---	------

**Appendix A. Test Result of Conducted Test Items**

Test Engineer:	Shiang Wang	Temperature:	21~25	°C
Test Date:	2018/9/20~2018/10/09	Relative Humidity:	51~54	%

**TEST RESULTS DATA**  
**26dB and 99% OBW**

Band I													
Mod.	Data Rate	NTX	CH.	Freq. (MHz)	99% Bandwidth (MHz)		26 dB Bandwidth (MHz)		IC 99% Bandwidth Power Limit (dBm)		IC 99% Bandwidth EIRP Limit (dBm)		Note
					Ant 1	Ant 2	Ant 1	Ant 2	Ant 1	Ant 2	Ant 1	Ant 2	
11a	6Mbps	1	36	5180	17.60	-	41.82	-	-	-	22.46	-	
11a	6Mbps	1	44	5220	17.80	-	43.91	-	-	-	22.50	-	
11a	6Mbps	1	48	5240	17.55	-	43.00	-	-	-	22.44	-	
HT20	MCS0	1	36	5180	18.50	-	45.70	-	-	-	22.67	-	
HT20	MCS0	1	44	5220	18.75	-	46.70	-	-	-	22.73	-	
HT20	MCS0	1	48	5240	18.40	-	44.95	-	-	-	22.65	-	
HT40	MCS0	1	38	5190	36.90	-	82.04	-	-	-	23.01	-	
HT40	MCS0	1	46	5230	36.80	-	79.92	-	-	-	23.01	-	



**TEST RESULTS DATA**  
**Average Power Table**

FCC Band I														
Mod.	Data Rate	NTX	CH.	Freq. (MHz)	Duty Factor (dB)		Average Conducted Power (dBm)			FCC Conducted Power Limit (dBm)		DG (dBi)		Pass/Fail
					Ant 1	Ant 2	Ant 1	Ant 2	SUM	Ant 1	Ant 2	Ant 1	Ant 2	
11a	6Mbps	1	36	5180	0.56	-	13.96	-		24.00	-	0.00	-	Pass
11a	6Mbps	1	44	5220	0.56	-	14.44	-		24.00	-	0.00	-	Pass
11a	6Mbps	1	48	5240	0.56	-	14.49	-		24.00	-	0.00	-	Pass
HT20	MCS0	1	36	5180	0.63	-	13.97	-		24.00	-	0.00	-	Pass
HT20	MCS0	1	44	5220	0.63	-	14.47	-		24.00	-	0.00	-	Pass
HT20	MCS0	1	48	5240	0.63	-	14.22	-		24.00	-	0.00	-	Pass
HT40	MCS0	1	38	5190	0.60	-	10.71	-		24.00	-	0.00	-	Pass
HT40	MCS0	1	46	5230	0.60	-	14.48	-		24.00	-	0.00	-	Pass

**TEST RESULTS DATA**  
**Power Spectral Density**

FCC Band I														
Mod.	Data Rate	NTX	CH.	Freq. (MHz)	Duty Factor (dB)		Average Power Density (dBm/MHz)			Average PSD Limit (dBm/MHz)		DG (dBi)		Pass /Fail
					Ant 1	Ant 2	Ant 1	Ant 2	SUM	Ant 1	Ant 2	Ant 1	Ant 2	
11a	6Mbps	1	36	5180	0.56	-	2.55	-		11.00	-	0.00	-	Pass
11a	6Mbps	1	44	5220	0.56	-	4.00	-		11.00	-	0.00	-	Pass
11a	6Mbps	1	48	5240	0.56	-	3.94	-		11.00	-	0.00	-	Pass
HT20	MCS0	1	36	5180	0.63	-	2.41	-		11.00	-	0.00	-	Pass
HT20	MCS0	1	44	5220	0.63	-	4.06	-		11.00	-	0.00	-	Pass
HT20	MCS0	1	48	5240	0.63	-	3.17	-		11.00	-	0.00	-	Pass
HT40	MCS0	1	38	5190	0.60	-	-3.75	-		11.00	-	0.00	-	Pass
HT40	MCS0	1	46	5230	0.60	-	-0.28	-		11.00	-	0.00	-	Pass

**TEST RESULTS DATA**  
**26dB and 99% OBW**

Band II															
Mod.	Data Rate	NTX	CH.	Freq. (MHz)	99% Bandwidth (MHz)		26 dB Bandwidth (MHz)		IC 99% Bandwidth Power Limit (dBm)		IC 99% Bandwidth EIRP Limit (dBm)		FCC 26dB Bandwidth Power Limit (dBm)		Note
					Ant 1	Ant 2	Ant 1	Ant 2	Ant 1	Ant 2	Ant 1	Ant 2	Ant 1	Ant 2	
11a	6Mbps	1	52	5260	17.75	-	40.50	-	23.49	-	29.49	-	23.98	-	
11a	6Mbps	1	60	5300	17.60	-	40.80	-	23.46	-	29.46	-	23.98	-	
11a	6Mbps	1	64	5320	17.50	-	40.80	-	23.43	-	29.43	-	23.98	-	
HT20	MCS0	1	52	5260	18.55	-	43.85	-	23.68	-	29.68	-	23.98	-	
HT20	MCS0	1	60	5300	18.55	-	44.55	-	23.68	-	29.68	-	23.98	-	
HT20	MCS0	1	64	5320	18.60	-	44.50	-	23.70	-	29.70	-	23.98	-	
HT40	MCS0	1	54	5270	36.90	-	82.16	-	23.98	-	30.00	-	23.98	-	
HT40	MCS0	1	62	5310	36.90	-	77.28	-	23.98	-	30.00	-	23.98	-	

**TEST RESULTS DATA**  
**Average Power Table**

FCC Band II															
Mod.	Data Rate	NTX	CH.	Freq. (MHz)	Duty Factor (dB)		Average Conducted Power (dBm)			FCC Conducted Power Limit (dBm)		DG (dBi)		EIRP Power Limit (dBm)	Pass/Fail
					Ant 1	Ant 2	Ant 1	Ant 2	SUM	Ant 1	Ant 2	Ant 1	Ant 2		
11a	6Mbps	1	52	5260	0.56	-	14.31	-		23.98	-	0.00	-	26.99	Pass
11a	6Mbps	1	60	5300	0.56	-	14.28	-		23.98	-	0.00	-	26.99	Pass
11a	6Mbps	1	64	5320	0.56	-	14.39	-		23.98	-	0.00	-	26.99	Pass
HT20	MCS0	1	52	5260	0.63	-	14.40	-		23.98	-	0.00	-	26.99	Pass
HT20	MCS0	1	60	5300	0.63	-	14.44	-		23.98	-	0.00	-	26.99	Pass
HT20	MCS0	1	64	5320	0.63	-	14.47	-		23.98	-	0.00	-	26.99	Pass
HT40	MCS0	1	54	5270	0.60	-	14.44	-		23.98	-	0.00	-	26.99	Pass
HT40	MCS0	1	62	5310	0.60	-	11.34	-		23.98	-	0.00	-	26.99	Pass

**TEST RESULTS DATA**  
**Power Spectral Density**

Band II														
Mod.	Data Rate	NTX	CH.	Freq. (MHz)	Duty Factor (dB)		Average Power Density (dBm/MHz)			Average PSD Limit (dBm/MHz)		DG (dBi)		Pass /Fail
					Ant 1	Ant 2	Ant 1	Ant 2	SUM	Ant 1	Ant 2	Ant 1	Ant 2	
11a	6Mbps	1	52	5260	0.56	-	3.59	-		11.00	-	0.00	-	Pass
11a	6Mbps	1	60	5300	0.56	-	3.48	-		11.00	-	0.00	-	Pass
11a	6Mbps	1	64	5320	0.56	-	3.38	-		11.00	-	0.00	-	Pass
HT20	MCS0	1	52	5260	0.63	-	3.32	-		11.00	-	0.00	-	Pass
HT20	MCS0	1	60	5300	0.63	-	3.20	-		11.00	-	0.00	-	Pass
HT20	MCS0	1	64	5320	0.63	-	3.22	-		11.00	-	0.00	-	Pass
HT40	MCS0	1	54	5270	0.60	-	-0.09	-		11.00	-	0.00	-	Pass
HT40	MCS0	1	62	5310	0.60	-	-3.48	-		11.00	-	0.00	-	Pass

**TEST RESULTS DATA**  
**26dB and 99% OBW**

Band III																
Mod.	Data Rate	NTX	CH.	Freq. (MHz)	99% Bandwidth In U-NII 2C (MHz)		26 dB Bandwidth In U-NII 2C (MHz)		IC 99% Bandwidth Power Limit (dBm)		IC 99% Bandwidth EIRP Limit (dBm)		FCC 26dB Bandwidth Power Limit (dBm)		6 dB Bandwidth for Straddle Channel (MHz)	
					Ant 1	Ant 2	Ant 1	Ant 2	Ant 1	Ant 2	Ant 1	Ant 2	Ant 1	Ant 2	Ant 1	Ant 2
11a	6Mbps	1	100	5500	17.50	-	41.18	-	23.43	-	29.43	-	23.98	-	----	----
11a	6Mbps	1	116	5580	17.45	-	42.73	-	23.42	-	29.42	-	23.98	-	----	----
11a	6Mbps	1	140	5700	18.00	-	41.90	-	23.55	-	29.55	-	23.98	-	----	----
HT20	MCS0	1	100	5500	18.40	-	44.25	-	23.65	-	29.65	-	23.98	-	----	----
HT20	MCS0	1	116	5580	18.50	-	44.80	-	23.67	-	29.67	-	23.98	-	----	----
HT20	MCS0	1	140	5700	18.65	-	45.80	-	23.71	-	29.71	-	23.98	-	----	----
HT40	MCS0	1	102	5510	36.70	-	82.34	-	23.98	-	30.00	-	23.98	-	----	----
HT40	MCS0	1	110	5550	36.80	-	72.46	-	23.98	-	30.00	-	23.98	-	----	----
HT40	MCS0	1	134	5670	37.00	-	86.04	-	23.98	-	30.00	-	23.98	-	----	----

**TEST RESULTS DATA**  
**Average Power Table**

FCC Band III															
Mod.	Data Rate	NTX	CH.	Freq. (MHz)	Duty Factor (dB)		Average Conducted Power (dBm)			FCC Conducted Power Limit (dBm)		DG (dBi)		EIRP Power Limit (dBm)	Pass/Fail
					Ant 1	Ant 2	Ant 1	Ant 2	SUM	Ant 1	Ant 2	Ant 1	Ant 2		
11a	6Mbps	1	100	5500	0.56	-	14.21	-		23.98	-	0.00	-	26.99	Pass
11a	6Mbps	1	116	5580	0.56	-	14.45	-		23.98	-	0.00	-	26.99	Pass
11a	6Mbps	1	140	5700	0.56	-	14.49	-		23.98	-	0.00	-	26.99	Pass
HT20	MCS0	1	100	5500	0.63	-	14.34	-		23.98	-	0.00	-	26.99	Pass
HT20	MCS0	1	116	5580	0.63	-	14.19	-		23.98	-	0.00	-	26.99	Pass
HT20	MCS0	1	140	5700	0.63	-	12.70	-		23.98	-	0.00	-	26.99	Pass
HT40	MCS0	1	102	5510	0.60	-	12.21	-		23.98	-	0.00	-	26.99	Pass
HT40	MCS0	1	110	5550	0.60	-	14.38	-		23.98	-	0.00	-	26.99	Pass
HT40	MCS0	1	134	5670	0.60	-	14.47	-		23.98	-	0.00	-	26.99	Pass

***TEST RESULTS DATA***  
***Power Spectral Density***

Band III														
Mod.	Data Rate	NTX	CH.	Freq. (MHz)	Duty Factor (dB)		Average Power Density (dBm/MHz)			Average PSD Limit (dBm/MHz)		DG (dBi)		Pass /Fail
					Ant 1	Ant 2	Ant 1	Ant 2	SUM	Ant 1	Ant 2	Ant 1	Ant 2	
11a	6Mbps	1	100	5500	0.56	-	2.59	-		11.00	-	0.00	-	Pass
11a	6Mbps	1	116	5580	0.56	-	3.18	-		11.00	-	0.00	-	Pass
11a	6Mbps	1	140	5700	0.56	-	3.31	-		11.00	-	0.00	-	Pass
HT20	MCS0	1	100	5500	0.63	-	2.98	-		11.00	-	0.00	-	Pass
HT20	MCS0	1	116	5580	0.63	-	3.32	-		11.00	-	0.00	-	Pass
HT20	MCS0	1	140	5700	0.63	-	1.18	-		11.00	-	0.00	-	Pass
HT40	MCS0	1	102	5510	0.60	-	-1.19	-		11.00	-	0.00	-	Pass
HT40	MCS0	1	110	5550	0.60	-	-0.32	-		11.00	-	0.00	-	Pass
HT40	MCS0	1	134	5670	0.60	-	-0.04	-		11.00	-	0.00	-	Pass





## Appendix B. AC Conducted Emission Test Results

Test Engineer :	Rick Lin	Temperature :	23~24°C
		Relative Humidity :	60~61%

## EUT Information

Report NO : 890804-01  
 Test Mode : Mode 1  
 Test Voltage : 120Vac/60Hz  
 Phase : Line

Full Spectrum

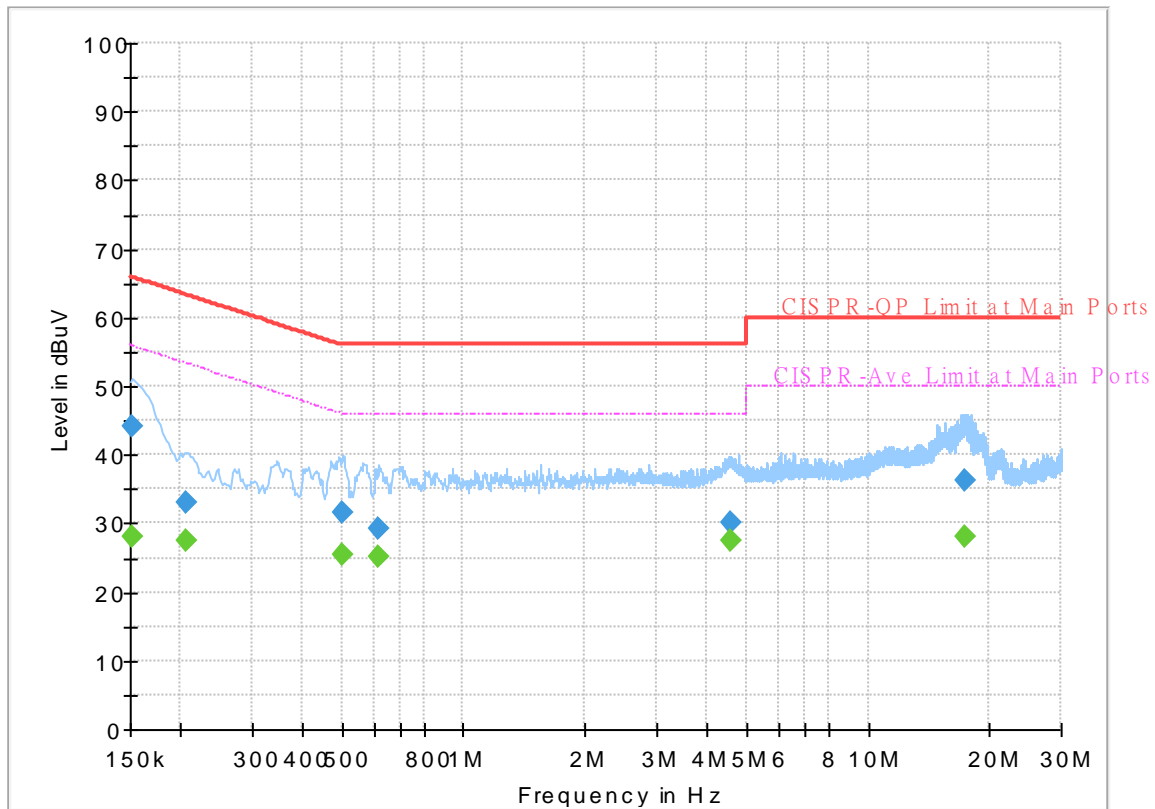

## Final\_Result

Frequency (MHz)	QuasiPeak (dBuV)	CAverage (dBuV)	Limit (dBuV)	Margin (dB)	Line	Filter	Corr. (dB)
0.152250	---	28.00	55.88	27.88	L1	OFF	19.5
0.152250	44.22	---	65.88	21.66	L1	OFF	19.5
0.206250	---	27.53	53.36	25.83	L1	OFF	19.5
0.206250	33.18	---	63.36	30.18	L1	OFF	19.5
0.503250	---	25.55	46.00	20.45	L1	OFF	19.5
0.503250	31.68	---	56.00	24.32	L1	OFF	19.5
0.618000	---	25.11	46.00	20.89	L1	OFF	19.6
0.618000	29.11	---	56.00	26.89	L1	OFF	19.6
4.582500	---	27.48	46.00	18.52	L1	OFF	19.7
4.582500	30.14	---	56.00	25.86	L1	OFF	19.7
17.436750	---	27.93	50.00	22.07	L1	OFF	20.2
17.436750	36.29	---	60.00	23.71	L1	OFF	20.2

## EUT Information

Report NO : 890804-01  
 Test Mode : Mode 1  
 Test Voltage : 120Vac/60Hz  
 Phase : Neutral

Full Spectrum

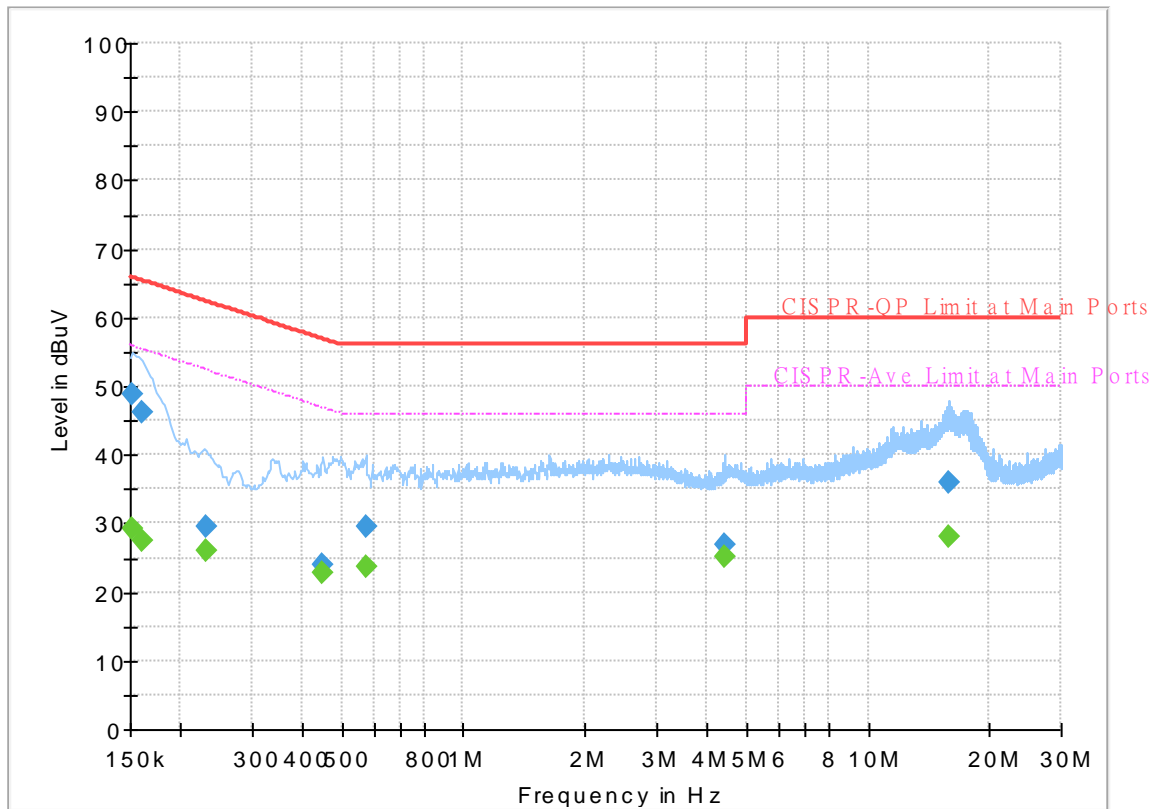

## Final\_Result

Frequency (MHz)	QuasiPeak (dBuV)	CAverage (dBuV)	Limit (dBuV)	Margin (dB)	Line	Filter	Corr. (dB)
0.152250	---	29.11	55.88	26.77	N	OFF	19.5
0.152250	48.81	---	65.88	17.07	N	OFF	19.5
0.161250	---	27.48	55.40	27.92	N	OFF	19.5
0.161250	46.34	---	65.40	19.06	N	OFF	19.5
0.231000	---	25.91	52.41	26.50	N	OFF	19.5
0.231000	29.50	---	62.41	32.91	N	OFF	19.5
0.449250	---	22.70	46.89	24.19	N	OFF	19.5
0.449250	24.08	---	56.89	32.81	N	OFF	19.5
0.573000	---	23.62	46.00	22.38	N	OFF	19.5
0.573000	29.64	---	56.00	26.36	N	OFF	19.5
4.440750	---	25.08	46.00	20.92	N	OFF	19.7
4.440750	26.92	---	56.00	29.08	N	OFF	19.7
15.891000	---	28.08	50.00	21.92	N	OFF	20.2
15.891000	35.85	---	60.00	24.15	N	OFF	20.2



## Appendix B. Radiated Spurious Emission

Test Engineer :	Hao Hsu, Ken Wu, and Chuan Zhu	Temperature :	21~26°C
		Relative Humidity :	51~56%

**Band 1 - 5150~5250MHz**  
**WIFI 802.11a (Band Edge @ 3m)**

WIFI Ant.	Note	Frequency ( MHz )	Level ( dBμV/m )	Over Limit ( dB )	Limit Line ( dBμV/m )	Read Level ( dBμV )	Antenna Factor ( dB/m )	Path Loss ( dB )	Preamp Factor ( dB )	Ant Pos ( cm )	Table Pos ( deg )	Peak Avg. ( P/A )	Pol. ( H/V )	
802.11a CH 36 5180MHz		5147.42	58	-16	74	49.6	31.75	9.68	33.03	100	89	P	H	
		5150	47.22	-6.78	54	38.81	31.75	9.69	33.03	100	89	A	H	
	*	5180	103.92	-	-	95.44	31.78	9.73	33.03	100	89	P	H	
	*	5180	95.95	-	-	87.47	31.78	9.73	33.03	100	89	A	H	
													H	
			5145.08	59.87	-14.13	74	51.47	31.75	9.68	33.03	100	105	P	V
			5149.5	49.1	-4.9	54	40.7	31.75	9.68	33.03	100	105	A	V
	*		5180	107.54	-	-	99.06	31.78	9.73	33.03	100	105	P	V
	*		5180	99.48	-	-	91	31.78	9.73	33.03	100	105	A	V
														V
802.11a CH 44 5220MHz		5127.14	50.98	-23.02	74	42.63	31.73	9.65	33.03	100	62	P	H	
		5099.58	41.3	-12.7	54	33.03	31.7	9.61	33.04	100	62	A	H	
	*	5220	104.15	-	-	95.59	31.82	9.77	33.03	100	62	P	H	
	*	5220	96.4	-	-	87.84	31.82	9.77	33.03	100	62	A	H	
			5434.9	49.36	-24.64	74	40.48	32.03	9.87	33.02	100	62	P	H
			5425.18	40.11	-13.89	54	31.25	32.02	9.86	33.02	100	62	A	H
			5124.54	51.19	-22.81	74	42.84	31.73	9.65	33.03	100	109	P	V
			5086.06	41.2	-12.8	54	32.97	31.68	9.59	33.04	100	109	A	V
	*		5220	109.23	-	-	100.67	31.82	9.77	33.03	100	109	P	V
	*		5220	100.47	-	-	91.91	31.82	9.77	33.03	100	109	A	V
			5439.22	50.68	-23.32	74	41.79	32.03	9.88	33.02	100	109	P	V
			5438.14	40.11	-13.89	54	31.23	32.03	9.87	33.02	100	109	A	V



<b>802.11a CH 48 5240MHz</b>		5076.44	50.13	-23.87	74	41.92	31.68	9.57	33.04	100	58	P	H
		5083.98	41.07	-12.93	54	32.84	31.68	9.59	33.04	100	58	A	H
	*	5240	103.91	-	-	95.33	31.83	9.78	33.03	100	58	P	H
	*	5240	96.27	-	-	87.69	31.83	9.78	33.03	100	58	A	H
		5403.85	49.73	-24.27	74	40.91	32	9.84	33.02	100	58	P	H
		5440.3	40.13	-13.87	54	31.24	32.03	9.88	33.02	100	58	A	H
		5055.38	51.85	-22.15	74	43.68	31.67	9.54	33.04	103	106	P	V
		5046.28	41.29	-12.71	54	33.15	31.65	9.53	33.04	103	106	A	V
	*	5240	108.69	-	-	100.11	31.83	9.78	33.03	103	106	P	V
	*	5240	100.51	-	-	91.93	31.83	9.78	33.03	103	106	A	V
		5440.3	50.02	-23.98	74	41.13	32.03	9.88	33.02	103	106	P	V
		5454.61	40.22	-13.78	54	31.3	32.05	9.89	33.02	103	106	A	V
<b>Remark</b>	<ol style="list-style-type: none"> <li>1. No other spurious found.</li> <li>2. All results are PASS against Peak and Average limit line.</li> </ol>												



**Band 1 5150~5250MHz**  
**WIFI 802.11a (Harmonic @ 3m)**

WIFI Ant. 1	Note	Frequency ( MHz )	Level ( dBμV/m )	Over Limit ( dB )	Limit Line ( dBμV/m )	Read Level ( dBμV )	Antenna Factor ( dB/m )	Path Loss ( dB )	Preamp Factor ( dB )	Ant Pos ( cm )	Table Pos ( deg )	Peak Avg. ( P/A )	Pol. ( H/V )
802.11a CH 36 5180MHz		10360	45.23	-22.97	68.2	50.39	39.51	15.34	60.01	100	0	P	H
		15540	44.15	-29.85	74	45.41	38	18.79	58.05	100	0	P	H
													H
													H
		10360	45.38	-22.82	68.2	50.54	39.51	15.34	60.01	100	0	P	V
		15540	43.94	-30.06	74	45.2	38	18.79	58.05	100	0	P	V
													V
													V
802.11a CH 44 5220MHz		10440	44.93	-23.27	68.2	50.08	39.61	15.39	60.15	100	0	P	H
		15660	46.31	-27.69	74	47.69	37.67	18.83	57.88	100	0	P	H
													H
													H
		10440	44.7	-23.5	68.2	49.85	39.61	15.39	60.15	100	0	P	V
		15660	44.32	-29.68	74	45.7	37.67	18.83	57.88	100	0	P	V
													V
													V
802.11a CH 48 5240MHz		10480	44.84	-23.36	68.2	50.01	39.68	15.41	60.26	100	0	P	H
		15720	43.57	-30.43	74	45.04	37.47	18.85	57.79	100	0	P	H
													H
													H
		10480	46.46	-21.74	68.2	51.63	39.68	15.41	60.26	100	0	P	V
		15720	43.07	-30.93	74	44.54	37.47	18.85	57.79	100	0	P	V
													V
													V
<b>Remark</b>	1. No other spurious found. 2. All results are PASS against Peak and Average limit line.												



**Band 1 5150~5250MHz**  
**WIFI 802.11n HT20 (Band Edge @ 3m)**

WIFI Ant. 1	Note	Frequency ( MHz )	Level ( dBμV/m )	Over Limit ( dB )	Limit Line ( dBμV/m )	Read Level ( dBμV )	Antenna Factor ( dB/m )	Path Loss ( dB )	Preamp Factor ( dB )	Ant Pos ( cm )	Table Pos ( deg )	Peak Avg. ( P/A )	Pol. ( H/V )	
802.11n HT20 CH 36 5180MHz		5149.76	60.36	-13.64	74	51.96	31.75	9.68	33.03	100	89	P	H	
		5149.5	47.91	-6.09	54	39.51	31.75	9.68	33.03	100	89	A	H	
	*	5180	103.57	-	-	95.09	31.78	9.73	33.03	100	89	P	H	
	*	5180	95.89	-	-	87.41	31.78	9.73	33.03	100	89	A	H	
													H	
														H
			5150	59.59	-14.41	74	51.18	31.75	9.69	33.03	100	116	P	V
			5150	50.11	-3.89	54	41.7	31.75	9.69	33.03	100	116	A	V
		*	5180	107.46	-	-	98.98	31.78	9.73	33.03	100	116	P	V
		*	5180	99.1	-	-	90.62	31.78	9.73	33.03	100	116	A	V
													V	
													V	
802.11n HT20 CH 44 5220MHz		5141.44	50.58	-23.42	74	42.19	31.75	9.67	33.03	100	60	P	H	
		5072.28	41.08	-12.92	54	32.87	31.68	9.57	33.04	100	60	A	H	
	*	5220	103.45	-	-	94.89	31.82	9.77	33.03	100	60	P	H	
	*	5220	95.83	-	-	87.27	31.82	9.77	33.03	100	60	A	H	
			5372.26	50.09	-23.91	74	41.32	31.97	9.83	33.03	100	60	P	H
			5431.66	40.17	-13.83	54	31.29	32.03	9.87	33.02	100	60	A	H
			5111.28	50.29	-23.71	74	41.98	31.72	9.63	33.04	100	106	P	V
			5143	41.28	-12.72	54	32.89	31.75	9.67	33.03	100	106	A	V
		*	5220	109.13	-	-	100.57	31.82	9.77	33.03	100	106	P	V
		*	5220	100.45	-	-	91.89	31.82	9.77	33.03	100	106	A	V
		5418.16	48.72	-25.28	74	39.86	32.02	9.86	33.02	100	106	P	V	
		5451.1	40.22	-13.78	54	31.3	32.05	9.89	33.02	100	106	A	V	



<b>802.11n</b>  <b>HT20</b>  <b>CH 48</b>  <b>5240MHz</b>		5048.88	50.34	-23.66	74	42.2	31.65	9.53	33.04	100	61	P	H
		5057.72	41.01	-12.99	54	32.83	31.67	9.55	33.04	100	61	A	H
	*	5240	104.34	-	-	95.76	31.83	9.78	33.03	100	61	P	H
	*	5240	95.31	-	-	86.73	31.83	9.78	33.03	100	61	A	H
		5457.31	50.45	-23.55	74	41.53	32.05	9.89	33.02	100	61	P	H
		5458.66	40.39	-13.61	54	31.47	32.05	9.89	33.02	100	61	A	H
		5126.36	50.26	-23.74	74	41.91	31.73	9.65	33.03	100	107	P	V
		5085.02	41.17	-12.83	54	32.94	31.68	9.59	33.04	100	107	A	V
	*	5240	107.48	-	-	98.9	31.83	9.78	33.03	100	107	P	V
	*	5240	99.36	-	-	90.78	31.83	9.78	33.03	100	107	A	V
		5394.4	49.8	-24.2	74	41	31.98	9.84	33.02	100	107	P	V
		5450.56	40.5	-13.5	54	31.58	32.05	9.89	33.02	100	107	A	V
<b>Remark</b>	1. No other spurious found. 2. All results are PASS against Peak and Average limit line.												





**Band 1 5150~5250MHz**  
**WIFI 802.11n HT20 (Harmonic @ 3m)**

WIFI Ant. 1	Note	Frequency ( MHz )	Level ( dBμV/m )	Over Limit ( dB )	Limit Line ( dBμV/m )	Read Level ( dBμV )	Antenna Factor ( dB/m )	Path Loss ( dB )	Preamp Factor ( dB )	Ant Pos ( cm )	Table Pos ( deg )	Peak Avg. ( P/A )	Pol. ( H/V )
802.11n HT20 CH 36 5180MHz		10360	45.55	-22.65	68.2	50.71	39.51	15.34	60.01	100	0	P	H
		15540	42.85	-31.15	74	44.11	38	18.79	58.05	100	0	P	H
													H
													H
		10360	45.46	-22.74	68.2	50.62	39.51	15.34	60.01	100	0	P	V
		15540	44.53	-29.47	74	45.79	38	18.79	58.05	100	0	P	V
													V
802.11n HT20 CH 44 5220MHz		10440	44.7	-23.5	68.2	49.85	39.61	15.39	60.15	100	0	P	H
		15660	44.73	-29.27	74	46.11	37.67	18.83	57.88	100	0	P	H
													H
													H
		10440	44.53	-23.67	68.2	49.68	39.61	15.39	60.15	100	0	P	V
		15660	44.38	-29.62	74	45.76	37.67	18.83	57.88	100	0	P	V
													V
802.11n HT20 CH 48 5240MHz		10480	45.82	-22.38	68.2	50.99	39.68	15.41	60.26	100	0	P	H
		15720	44.02	-29.98	74	45.49	37.47	18.85	57.79	100	0	P	H
													H
													H
		10480	44.51	-23.69	68.2	49.68	39.68	15.41	60.26	100	0	P	V
		15720	43.37	-30.63	74	44.84	37.47	18.85	57.79	100	0	P	V
													V
Remark	1. No other spurious found.												
	2. All results are PASS against Peak and Average limit line.												



**Band 1 5150~5250MHz**  
**WIFI 802.11n HT40 (Band Edge @ 3m)**

WIFI Ant. 1	Note	Frequency ( MHz )	Level ( dBμV/m )	Over Limit ( dB )	Limit Line ( dBμV/m )	Read Level ( dBμV )	Antenna Factor ( dB/m )	Path Loss ( dB )	Preamp Factor ( dB )	Ant Pos ( cm )	Table Pos ( deg )	Peak Avg. ( P/A )	Pol. ( H/V )
802.11n HT40 CH 38 5190MHz		5149.24	57.6	-16.4	74	49.2	31.75	9.68	33.03	100	61	P	H
		5149.76	47.72	-6.28	54	39.32	31.75	9.68	33.03	100	61	A	H
	*	5190	97.7	-	-	89.21	31.78	9.74	33.03	100	61	P	H
	*	5190	89.2	-	-	80.71	31.78	9.74	33.03	100	61	A	H
		5457.2	50.41	-23.59	74	41.49	32.05	9.89	33.02	100	61	P	H
		5449.92	40.36	-13.64	54	31.45	32.05	9.88	33.02	100	61	A	H
		5148.72	60.32	-13.68	74	51.92	31.75	9.68	33.03	100	102	P	V
		5150	50.79	-3.21	54	42.38	31.75	9.69	33.03	100	102	A	V
	*	5190	101.04	-	-	92.55	31.78	9.74	33.03	100	102	P	V
	*	5190	92.67	-	-	84.18	31.78	9.74	33.03	100	102	A	V
		5433.68	49.73	-24.27	74	40.85	32.03	9.87	33.02	100	102	P	V
		5458.32	40.25	-13.75	54	31.33	32.05	9.89	33.02	100	102	A	V
802.11n HT40 CH 46 5230MHz		5115.44	51.18	-22.82	74	42.87	31.72	9.63	33.04	100	63	P	H
		5148.98	42.47	-11.53	54	34.07	31.75	9.68	33.03	100	63	A	H
	*	5230	100.89	-	-	92.32	31.83	9.77	33.03	100	63	P	H
	*	5230	92.64	-	-	84.07	31.83	9.77	33.03	100	63	A	H
		5458.12	50.53	-23.47	74	41.61	32.05	9.89	33.02	100	63	P	H
		5451.91	40.1	-13.9	54	31.18	32.05	9.89	33.02	100	63	A	H
		5141.7	52.39	-21.61	74	44	31.75	9.67	33.03	100	105	P	V
		5149.76	43.67	-10.33	54	35.27	31.75	9.68	33.03	100	105	A	V
	*	5230	105.23	-	-	96.66	31.83	9.77	33.03	100	105	P	V
	*	5230	97.22	-	-	88.65	31.83	9.77	33.03	100	105	A	V
	5413.57	50.22	-23.78	74	41.37	32.02	9.85	33.02	100	105	P	V	
	5453.26	40.38	-13.62	54	31.46	32.05	9.89	33.02	100	105	A	V	
<b>Remark</b>	1. No other spurious found. 2. All results are PASS against Peak and Average limit line.												



**Band 1 5150~5250MHz**  
**WIFI 802.11n HT40 (Harmonic @ 3m)**

WIFI Ant. 1	Note	Frequency ( MHz )	Level ( dBμV/m )	Over Limit ( dB )	Limit Line ( dBμV/m )	Read Level (dBμV)	Antenna Factor ( dB/m )	Path Loss ( dB )	Preamp Factor ( dB )	Ant Pos ( cm )	Table Pos ( deg )	Peak Avg. (P/A)	Pol. (H/V)
802.11n HT40 CH 38 5190MHz		10380	45.22	-22.98	68.2	50.37	39.54	15.35	60.04	100	0	P	H
		15570	43.3	-30.7	74	44.59	37.91	18.8	58	100	0	P	H
													H
													H
		10380	45.1	-23.1	68.2	50.25	39.54	15.35	60.04	100	0	P	V
		15570	43.62	-30.38	74	44.91	37.91	18.8	58	100	0	P	V
													V
													V
802.11n HT40 CH 46 5230MHz		10460	44.78	-23.42	68.2	49.94	39.63	15.4	60.19	100	0	P	H
		15690	43.58	-30.42	74	45	37.57	18.84	57.83	100	0	P	H
													H
													H
		10460	44.5	-23.7	68.2	49.66	39.63	15.4	60.19	100	0	P	V
		15690	44	-30	74	45.42	37.57	18.84	57.83	100	0	P	V
													V
													V
<b>Remark</b>	1. No other spurious found. 2. All results are PASS against Peak and Average limit line.												



**Band 2 - 5250~5350MHz**  
**WIFI 802.11a (Band Edge @ 3m)**

WIFI	Note	Frequency	Level	Over	Limit	Read	Antenna	Path	Preamp	Ant	Table	Peak	Pol.
Ant.				Limit	Line	Level	Factor	Loss	Factor	Pos	Pos	Avg.	
1		( MHz )	( dBμV/m )	( dB )	( dBμV/m )	( dBμV )	( dB/m )	( dB )	( dB )	( cm )	( deg )	(P/A)	(H/V)
802.11a CH 52 5260MHz		5102	49.95	-24.05	74	41.68	31.7	9.61	33.04	100	87	P	H
		5089.76	41.07	-12.93	54	32.82	31.7	9.59	33.04	100	87	A	H
	*	5260	103.24	-	-	94.62	31.87	9.78	33.03	100	87	P	H
	*	5260	95.9	-	-	87.28	31.87	9.78	33.03	100	87	A	H
		5442.72	49.72	-24.28	74	40.83	32.03	9.88	33.02	100	87	P	H
		5451.36	40.12	-13.88	54	31.2	32.05	9.89	33.02	100	87	A	H
		5014.62	51	-23	74	42.94	31.62	9.48	33.04	100	105	P	V
		5134.98	41.25	-12.75	54	32.89	31.73	9.66	33.03	100	105	A	V
	*	5260	108.17	-	-	99.55	31.87	9.78	33.03	100	105	P	V
	*	5260	100.23	-	-	91.61	31.87	9.78	33.03	100	105	A	V
		5448.72	49.74	-24.26	74	40.83	32.05	9.88	33.02	100	105	P	V
		5452.8	40.27	-13.73	54	31.35	32.05	9.89	33.02	100	105	A	V
802.11a CH 60 5300MHz		5093.84	50.36	-23.64	74	42.1	31.7	9.6	33.04	100	59	P	H
		5053.38	41.04	-12.96	54	32.89	31.65	9.54	33.04	100	59	A	H
	*	5300	102.99	-	-	94.32	31.9	9.8	33.03	100	59	P	H
	*	5300	95.68	-	-	87.01	31.9	9.8	33.03	100	59	A	H
		5352.72	50.59	-23.41	74	41.85	31.95	9.82	33.03	100	59	P	H
		5352.24	42.73	-11.27	54	33.99	31.95	9.82	33.03	100	59	A	H
		5080.58	50.8	-23.2	74	42.58	31.68	9.58	33.04	100	105	P	V
		5052.02	41.16	-12.84	54	33.01	31.65	9.54	33.04	100	105	A	V
	*	5300	107.92	-	-	99.25	31.9	9.8	33.03	100	105	P	V
	*	5300	99.95	-	-	91.28	31.9	9.8	33.03	100	105	A	V
		5353.44	52.94	-21.06	74	44.2	31.95	9.82	33.03	100	105	P	V
		5352.24	45.81	-8.19	54	37.07	31.95	9.82	33.03	100	105	A	V



<b>802.11a CH 64 5320MHz</b>	*	5320	102.42	-	-	93.72	31.92	9.81	33.03	100	62	P	H
	*	5320	94.52	-	-	85.82	31.92	9.81	33.03	100	62	A	H
		5352.64	56.22	-17.78	74	47.48	31.95	9.82	33.03	100	62	P	H
		5350.08	44.76	-9.24	54	36.02	31.95	9.82	33.03	100	62	A	H
													H
													H
	*	5320	107.14	-	-	98.44	31.92	9.81	33.03	100	116	P	V
	*	5320	99.23	-	-	90.53	31.92	9.81	33.03	100	116	A	V
		5350.24	62.45	-11.55	74	53.71	31.95	9.82	33.03	100	116	P	V
		5350.08	48.47	-5.53	54	39.73	31.95	9.82	33.03	100	116	A	V
													V
													V
<b>Remark</b>	1. No other spurious found. 2. All results are PASS against Peak and Average limit line.												



**Band 2 5250~5350MHz**  
**WIFI 802.11a (Harmonic @ 3m)**

WIFI Ant. 1	Note	Frequency ( MHz )	Level ( dBμV/m )	Over Limit ( dB )	Limit Line ( dBμV/m )	Read Level ( dBμV )	Antenna Factor ( dB/m )	Path Loss ( dB )	Preamp Factor ( dB )	Ant Pos ( cm )	Table Pos ( deg )	Peak Avg. ( P/A )	Pol. ( H/V )
802.11a CH 52 5260MHz		10520	44.9	-23.3	68.2	50.1	39.71	15.43	60.34	100	0	P	H
		15780	43.7	-30.3	74	45.22	37.33	18.86	57.71	100	0	P	H
													H
													H
		10520	45.17	-23.03	68.2	50.37	39.71	15.43	60.34	100	0	P	V
		15780	42.85	-31.15	74	44.37	37.33	18.86	57.71	100	0	P	V
													V
													V
802.11a CH 60 5300MHz		10600	43.57	-30.43	74	48.86	39.78	15.48	60.55	100	0	P	H
		15900	42.74	-31.26	74	44.38	36.99	18.91	57.54	100	0	P	H
													H
													H
		10600	43.92	-30.08	74	49.21	39.78	15.48	60.55	100	0	P	V
		15900	42.88	-31.12	74	44.52	36.99	18.91	57.54	100	0	P	V
													V
													V
802.11a CH 64 5320MHz		10640	42.5	-31.5	74	47.83	39.81	15.49	60.63	100	0	P	H
		15960	41.82	-32.18	74	43.54	36.8	18.93	57.45	100	0	P	H
													H
													H
		10640	43.5	-30.5	74	48.83	39.81	15.49	60.63	100	0	P	V
		15960	42.63	-31.37	74	44.35	36.8	18.93	57.45	100	0	P	V
													V
													V
<b>Remark</b>	1. No other spurious found. 2. All results are PASS against Peak and Average limit line.												



**Band 2 5250~5350MHz**  
**WIFI 802.11n HT20 (Band Edge @ 3m)**

WIFI Ant. 1	Note	Frequency ( MHz )	Level ( dBμV/m )	Over Limit ( dB )	Limit Line ( dBμV/m )	Read Level ( dBμV )	Antenna Factor ( dB/m )	Path Loss ( dB )	Preamp Factor ( dB )	Ant Pos ( cm )	Table Pos ( deg )	Peak Avg. ( P/A )	Pol. ( H/V )
802.11n HT20 CH 52 5260MHz		5140.08	51.08	-22.92	74	42.69	31.75	9.67	33.03	100	90	P	H
		5098.6	41.28	-12.72	54	33.01	31.7	9.61	33.04	100	90	A	H
	*	5260	104.32	-	-	95.7	31.87	9.78	33.03	100	90	P	H
	*	5260	96.12	-	-	87.5	31.87	9.78	33.03	100	90	A	H
		5389.2	49.17	-24.83	74	40.37	31.98	9.84	33.02	100	90	P	H
		5454.96	40.42	-13.58	54	31.5	32.05	9.89	33.02	100	90	A	H
		5069.36	51.01	-22.99	74	42.82	31.67	9.56	33.04	100	97	P	V
		5097.92	41.29	-12.71	54	33.02	31.7	9.61	33.04	100	97	A	V
	*	5260	108.59	-	-	99.97	31.87	9.78	33.03	100	97	P	V
	*	5260	99.92	-	-	91.3	31.87	9.78	33.03	100	97	A	V
		5350.08	50.02	-23.98	74	41.28	31.95	9.82	33.03	100	97	P	V
		5453.28	40.91	-13.09	54	31.99	32.05	9.89	33.02	100	97	A	V
802.11n HT20 CH 60 5300MHz		5091.46	49.46	-24.54	74	41.2	31.7	9.6	33.04	100	88	P	H
		5059.5	41.06	-12.94	54	32.88	31.67	9.55	33.04	100	88	A	H
	*	5300	103.7	-	-	95.03	31.9	9.8	33.03	100	88	P	H
	*	5300	95.87	-	-	87.2	31.9	9.8	33.03	100	88	A	H
		5352.72	50.19	-23.81	74	41.45	31.95	9.82	33.03	100	88	P	H
		5352	42.97	-11.03	54	34.23	31.95	9.82	33.03	100	88	A	H
		5045.9	50.25	-23.75	74	42.11	31.65	9.53	33.04	100	106	P	V
		5052.02	41.08	-12.92	54	32.93	31.65	9.54	33.04	100	106	A	V
	*	5300	107.73	-	-	99.06	31.9	9.8	33.03	100	106	P	V
	*	5300	99.37	-	-	90.7	31.9	9.8	33.03	100	106	A	V
	5352.96	51.45	-22.55	74	42.71	31.95	9.82	33.03	100	106	P	V	
	5352.24	45.7	-8.3	54	36.96	31.95	9.82	33.03	100	106	A	V	



<b>802.11n</b> <b>HT20</b> <b>CH 64</b> <b>5320MHz</b>	*	5320	102.22	-	-	93.52	31.92	9.81	33.03	114	118	P	H
	*	5320	94.63	-	-	85.93	31.92	9.81	33.03	114	118	A	H
		5350.08	56.72	-17.28	74	47.98	31.95	9.82	33.03	114	118	P	H
		5350.08	45.51	-8.49	54	36.77	31.95	9.82	33.03	114	118	A	H
													H
													H
	*	5320	108.26	-	-	99.56	31.92	9.81	33.03	100	116	P	V
	*	5320	99.01	-	-	90.31	31.92	9.81	33.03	100	116	A	V
		5354.4	62.84	-11.16	74	54.1	31.95	9.82	33.03	100	116	P	V
		5350.4	48.74	-5.26	54	40	31.95	9.82	33.03	100	116	A	V
													V
													V
<b>Remark</b>	1. No other spurious found. 2. All results are PASS against Peak and Average limit line.												





**Band 2 5250~5350MHz**  
**WIFI 802.11n HT20 (Harmonic @ 3m)**

WIFI Ant. 1	Note	Frequency ( MHz )	Level ( dBμV/m )	Over Limit ( dB )	Limit Line ( dBμV/m )	Read Level ( dBμV )	Antenna Factor ( dB/m )	Path Loss ( dB )	Preamp Factor ( dB )	Ant Pos ( cm )	Table Pos ( deg )	Peak Avg. ( P/A )	Pol. ( H/V )
802.11n HT20 CH 52 5260MHz		10520	44.64	-23.56	68.2	49.84	39.71	15.43	60.34	100	0	P	H
		15780	43.55	-30.45	74	45.07	37.33	18.86	57.71	100	0	P	H
													H
													H
		10520	44.84	-23.36	68.2	50.04	39.71	15.43	60.34	100	0	P	V
		15780	43.73	-30.27	74	45.25	37.33	18.86	57.71	100	0	P	V
													V
802.11n HT20 CH 60 5300MHz		10600	43.6	-30.4	74	48.89	39.78	15.48	60.55	100	0	P	H
		15900	43.3	-30.7	74	44.94	36.99	18.91	57.54	100	0	P	H
													H
													H
		10600	43	-31	74	48.29	39.78	15.48	60.55	100	0	P	V
		15900	42.96	-31.04	74	44.6	36.99	18.91	57.54	100	0	P	V
													V
802.11n HT20 CH 64 5320MHz		10640	43.48	-30.52	74	48.81	39.81	15.49	60.63	100	0	P	H
		15960	43.06	-30.94	74	44.78	36.8	18.93	57.45	100	0	P	H
													H
													H
		10640	43.83	-30.17	74	49.16	39.81	15.49	60.63	100	0	P	V
		15960	42	-32	74	43.72	36.8	18.93	57.45	100	0	P	V
													V
Remark	1. No other spurious found.												
	2. All results are PASS against Peak and Average limit line.												



**Band 2 5250~5350MHz**  
**WIFI 802.11n HT40 (Band Edge @ 3m)**

WIFI Ant. 1	Note	Frequency ( MHz )	Level ( dBμV/m )	Over Limit ( dB )	Limit Line ( dBμV/m )	Read Level ( dBμV )	Antenna Factor ( dB/m )	Path Loss ( dB )	Preamp Factor ( dB )	Ant Pos ( cm )	Table Pos ( deg )	Peak Avg. ( P/A )	Pol. ( H/V )
802.11n HT40 CH 54 5270MHz		5020.06	52.4	-21.6	74	44.33	31.62	9.49	33.04	100	63	P	H
		5071.06	41.44	-12.56	54	33.24	31.67	9.57	33.04	100	63	A	H
	*	5270	101.01	-	-	92.38	31.87	9.79	33.03	100	63	P	H
	*	5270	92.71	-	-	84.08	31.87	9.79	33.03	100	63	A	H
		5359.92	52.02	-21.98	74	43.28	31.95	9.82	33.03	100	63	P	H
		5351.04	41.06	-12.94	54	32.32	31.95	9.82	33.03	100	63	A	H
		5093.5	51.14	-22.86	74	42.88	31.7	9.6	33.04	100	98	P	V
		5061.88	41.22	-12.78	54	33.04	31.67	9.55	33.04	100	98	A	V
	*	5270	105.07	-	-	96.44	31.87	9.79	33.03	100	98	P	V
	*	5270	96.56	-	-	87.93	31.87	9.79	33.03	100	98	A	V
		5366.88	52.39	-21.61	74	43.62	31.97	9.83	33.03	100	98	P	V
		5350.08	43.17	-10.83	54	34.43	31.95	9.82	33.03	100	98	A	V
	802.11n HT40 CH 62 5310MHz		5063.92	49.76	-24.24	74	41.57	31.67	9.56	33.04	100	91	P
		5049.3	41.05	-12.95	54	32.91	31.65	9.53	33.04	100	91	A	H
*		5310	98.23	-	-	89.54	31.92	9.8	33.03	100	91	P	H
*		5310	89.26	-	-	80.57	31.92	9.8	33.03	100	91	A	H
		5350.08	54.1	-19.9	74	45.36	31.95	9.82	33.03	100	91	P	H
		5350.08	47.1	-6.9	54	38.36	31.95	9.82	33.03	100	91	A	H
		5099.96	49.79	-24.21	74	41.52	31.7	9.61	33.04	100	110	P	V
		5085	41.11	-12.89	54	32.88	31.68	9.59	33.04	100	110	A	V
*		5310	102.61	-	-	93.92	31.92	9.8	33.03	100	110	P	V
*		5310	93.24	-	-	84.55	31.92	9.8	33.03	100	110	A	V
	5352.96	62.77	-11.23	74	54.03	31.95	9.82	33.03	100	110	P	V	
	5350.08	50.7	-3.3	54	41.96	31.95	9.82	33.03	100	110	A	V	
<b>Remark</b>	1. No other spurious found. 2. All results are PASS against Peak and Average limit line.												



**Band 2 5250~5350MHz**  
**WIFI 802.11n HT40 (Harmonic @ 3m)**

WIFI Ant. 1	Note	Frequency ( MHz )	Level ( dBμV/m )	Over Limit ( dB )	Limit Line ( dBμV/m )	Read Level ( dBμV )	Antenna Factor ( dB/m )	Path Loss ( dB )	Preamp Factor ( dB )	Ant Pos ( cm )	Table Pos ( deg )	Peak Avg. ( P/A )	Pol. ( H/V )
802.11n HT40 CH 54 5270MHz		10540	43.9	-24.3	68.2	49.1	39.73	15.45	60.38	100	0	P	H
		15810	42.78	-31.22	74	44.34	37.23	18.88	57.67	100	0	P	H
													H
													H
		10540	44.32	-23.88	68.2	49.52	39.73	15.45	60.38	100	0	P	V
		15810	43.14	-30.86	74	44.7	37.23	18.88	57.67	100	0	P	V
													V
802.11n HT40 CH 62 5310MHz		10620	43.15	-30.85	74	48.46	39.8	15.48	60.59	100	0	P	H
		15930	41.62	-32.38	74	43.31	36.89	18.92	57.5	100	0	P	H
													H
													H
		10620	43.54	-30.46	74	48.85	39.8	15.48	60.59	100	0	P	V
		15930	42.74	-31.26	74	44.43	36.89	18.92	57.5	100	0	P	V
													V
Remark	1. No other spurious found.												
	2. All results are PASS against Peak and Average limit line.												



**Band 3 - 5470~5725MHz**  
**WIFI 802.11a (Band Edge @ 3m)**

WIFI	Note	Frequency	Level	Over	Limit	Read	Antenna	Path	Preamp	Ant	Table	Peak	Pol.	
Ant.				Limit	Line	Level	Factor	Loss	Factor	Pos	Pos	Avg.		
1		( MHz )	( dBμV/m )	( dB )	( dBμV/m )	( dBμV )	( dB/m )	( dB )	( dB )	( cm )	( deg )	(P/A)	(H/V)	
802.11a CH 100 5500MHz		5459.76	50.94	-23.06	74	42.02	32.05	9.89	33.02	100	62	P	H	
		5470	53.55	-14.65	68.2	44.6	32.07	9.9	33.02	100	62	P	H	
		5448.08	41.45	-12.55	54	32.54	32.05	9.88	33.02	100	62	A	H	
	*	5500	100.84	-	-	91.83	32.1	9.93	33.02	100	62	P	H	
	*	5500	92.25	-	-	83.24	32.1	9.93	33.02	100	62	A	H	
														H
			5460.08	53.2	-15	68.2	44.28	32.05	9.89	33.02	100	105	P	V
			5470	59.68	-8.52	68.2	50.73	32.07	9.9	33.02	100	105	P	V
			5447.6	44.3	-9.7	54	35.39	32.05	9.88	33.02	100	105	A	V
	*		5500	105.17	-	-	96.16	32.1	9.93	33.02	100	105	P	V
	*		5500	97.31	-	-	88.3	32.1	9.93	33.02	100	105	A	V
														V
802.11a CH 116 5580MHz		5457.28	49.59	-24.41	74	40.67	32.05	9.89	33.02	100	63	P	H	
		5462.8	48.66	-19.54	68.2	39.71	32.07	9.9	33.02	100	63	P	H	
		5432.32	40.25	-13.75	54	31.37	32.03	9.87	33.02	100	63	A	H	
	*	5580	103.61	-	-	94.46	32.22	10	33.07	100	63	P	H	
	*	5580	94.13	-	-	84.98	32.22	10	33.07	100	63	A	H	
			5764.055	49.69	-18.51	68.2	40.03	32.57	10.25	33.16	100	63	P	H
			5373.52	50.27	-23.73	74	41.49	31.97	9.83	33.02	114	112	P	V
			5468.8	50.23	-17.97	68.2	41.28	32.07	9.9	33.02	114	112	P	V
			5452	40.44	-13.56	54	31.52	32.05	9.89	33.02	114	112	A	V
	*		5580	107.9	-	-	98.75	32.22	10	33.07	114	112	P	V
	*		5580	98.62	-	-	89.47	32.22	10	33.07	114	112	A	V
			5748.305	48.94	-19.26	68.2	39.33	32.53	10.23	33.15	114	112	P	V



<b>802.11a</b> <b>CH 140</b> <b>5700MHz</b>	*	5700	100.54	-	-	91.06	32.44	10.16	33.12	100	63	P	H
	*	5700	92.55	-	-	83.07	32.44	10.16	33.12	100	63	A	H
		5726.12	55.59	-12.61	68.2	46.02	32.5	10.2	33.13	100	63	P	H
													H
													H
													H
	*	5700	105.31	-	-	95.83	32.44	10.16	33.12	100	114	P	V
	*	5700	97.17	-	-	87.69	32.44	10.16	33.12	100	114	A	V
		5725.4	59.02	-9.18	68.2	49.45	32.5	10.2	33.13	100	114	P	V
													V
													V
													V
<b>Remark</b>	1. No other spurious found. 2. All results are PASS against Peak and Average limit line.												



**Band 3 - 5470~5725MHz**  
**WIFI 802.11a (Harmonic @ 3m)**

WIFI Ant. 1	Note	Frequency ( MHz )	Level ( dBμV/m )	Over Limit ( dB )	Limit Line ( dBμV/m )	Read Level (dBμV)	Antenna Factor ( dB/m )	Path Loss ( dB )	Preamp Factor ( dB )	Ant Pos ( cm )	Table Pos ( deg )	Peak Avg. (P/A)	Pol. (H/V)
802.11a CH 100 5500MHz		11000	45.26	-28.74	74	50.96	40.1	15.7	61.5	100	0	P	H
		16500	44.82	-23.38	68.2	44.21	38.5	19.41	57.3	100	0	P	H
													H
													H
		11000	46.21	-27.79	74	51.91	40.1	15.7	61.5	100	0	P	V
		16500	43.84	-24.36	68.2	43.23	38.5	19.41	57.3	100	0	P	V
													V
													V
802.11a CH 116 5580MHz		11160	46.21	-27.79	74	51.88	40.07	15.79	61.53	100	0	P	H
		16740	47.01	-21.19	68.2	45.12	39.08	19.63	56.82	100	0	P	H
													H
													H
		11160	46.14	-27.86	74	51.81	40.07	15.79	61.53	100	0	P	V
		16740	44.89	-23.31	68.2	43	39.08	19.63	56.82	100	0	P	V
													V
													V
802.11a CH 140 5700MHz		11400	44.78	-29.22	74	50.42	40.02	15.92	61.58	100	0	P	H
		17100	46.4	-21.8	68.2	42.46	40.06	19.96	56.08	100	0	P	H
													H
													H
		11400	45.02	-28.98	74	50.66	40.02	15.92	61.58	100	0	P	V
		17100	47.65	-20.55	68.2	43.71	40.06	19.96	56.08	100	0	P	V
													V
													V
<b>Remark</b>	1. No other spurious found. 2. All results are PASS against Peak and Average limit line.												



**Band 3 - 5470~5725MHz**  
**WIFI 802.11n HT20 (Band Edge @ 3m)**

WIFI Ant. 1	Note	Frequency ( MHz )	Level ( dBμV/m )	Over Limit ( dB )	Limit Line ( dBμV/m )	Read Level ( dBμV )	Antenna Factor ( dB/m )	Path Loss ( dB )	Preamp Factor ( dB )	Ant Pos ( cm )	Table Pos ( deg )	Peak Avg. ( P/A )	Pol. ( H/V )	
802.11n HT20 CH 100 5500MHz		5454	51.64	-22.36	74	42.72	32.05	9.89	33.02	103	62	P	H	
		5465.84	57.93	-10.27	68.2	48.98	32.07	9.9	33.02	103	62	P	H	
		5448.08	42.27	-11.73	54	33.36	32.05	9.88	33.02	103	62	A	H	
	*	5500	99.8	-	-	90.79	32.1	9.93	33.02	103	62	P	H	
	*	5500	91.71	-	-	82.7	32.1	9.93	33.02	103	62	A	H	
														H
			5459.92	54.45	-19.55	74	45.53	32.05	9.89	33.02	100	115	P	V
			5467.44	61.97	-6.23	68.2	53.02	32.07	9.9	33.02	100	115	P	V
			5448.24	45.52	-8.48	54	36.61	32.05	9.88	33.02	100	115	A	V
	*		5500	106.81	-	-	97.8	32.1	9.93	33.02	100	115	P	V
	*		5500	98.02	-	-	89.01	32.1	9.93	33.02	100	115	A	V
													V	
802.11n HT20 CH 116 5580MHz		5424.88	49.85	-24.15	74	40.99	32.02	9.86	33.02	100	60	P	H	
		5464	49.48	-18.72	68.2	40.53	32.07	9.9	33.02	100	60	P	H	
		5458.96	40.45	-13.55	54	31.53	32.05	9.89	33.02	100	60	A	H	
	*	5580	102.19	-	-	93.04	32.22	10	33.07	100	60	P	H	
	*	5580	94.68	-	-	85.53	32.22	10	33.07	100	60	A	H	
			5735.705	51.12	-17.08	68.2	41.53	32.53	10.21	33.15	100	60	P	H
			5451.04	49.78	-24.22	74	40.86	32.05	9.89	33.02	100	106	P	V
			5460.4	49.18	-19.02	68.2	40.26	32.05	9.89	33.02	100	106	P	V
			5428.24	40.32	-13.68	54	31.45	32.02	9.87	33.02	100	106	A	V
	*		5580	105.71	-	-	96.56	32.22	10	33.07	100	106	P	V
	*		5580	97.86	-	-	88.71	32.22	10	33.07	100	106	A	V
		5756.18	50.5	-17.7	68.2	40.85	32.57	10.24	33.16	100	106	P	V	



<b>802.11n</b> <b>HT20</b> <b>CH 140</b> <b>5700MHz</b>	*	5700	101.91	-	-	92.43	32.44	10.16	33.12	100	63	P	H
	*	5700	92.97	-	-	83.49	32.44	10.16	33.12	100	63	A	H
		5725.16	61.65	-6.55	68.2	52.08	32.5	10.2	33.13	100	63	P	H
													H
													H
													H
	*	5700	105.11	-	-	95.63	32.44	10.16	33.12	100	114	P	V
	*	5700	96.37	-	-	86.89	32.44	10.16	33.12	100	114	A	V
		5725	63.3	-4.9	68.2	53.73	32.5	10.2	33.13	100	114	P	V
													V
													V
													V
<b>Remark</b>	1. No other spurious found. 2. All results are PASS against Peak and Average limit line.												





**Band 3 - 5470~5725MHz**  
**WIFI 802.11n HT20 (Harmonic @ 3m)**

WIFI Ant. 1	Note	Frequency ( MHz )	Level ( dBμV/m )	Over Limit ( dB )	Limit Line ( dBμV/m )	Read Level ( dBμV )	Antenna Factor ( dB/m )	Path Loss ( dB )	Preamp Factor ( dB )	Ant Pos ( cm )	Table Pos ( deg )	Peak Avg. ( P/A )	Pol. ( H/V )
802.11n HT20 CH 100 5500MHz		11000	45.28	-28.72	74	50.98	40.1	15.7	61.5	100	0	P	H
		16500	44.8	-23.4	68.2	44.19	38.5	19.41	57.3	100	0	P	H
													H
													H
		11000	44.49	-29.51	74	50.19	40.1	15.7	61.5	100	0	P	V
		16500	43.73	-24.47	68.2	43.12	38.5	19.41	57.3	100	0	P	V
													V
802.11n HT20 CH 116 5580MHz		11160	47.21	-26.79	74	52.88	40.07	15.79	61.53	100	0	P	H
		16740	45.83	-22.37	68.2	43.94	39.08	19.63	56.82	100	0	P	H
													H
													H
		11160	46.09	-27.91	74	51.76	40.07	15.79	61.53	100	0	P	V
		16740	45.3	-22.9	68.2	43.41	39.08	19.63	56.82	100	0	P	V
													V
802.11n HT20 CH 140 5700MHz		11400	45.64	-28.36	74	51.28	40.02	15.92	61.58	100	0	P	H
		17100	46.75	-21.45	68.2	42.81	40.06	19.96	56.08	100	0	P	H
													H
													H
		11400	44.95	-29.05	74	50.59	40.02	15.92	61.58	100	0	P	V
		17100	47.35	-20.85	68.2	43.41	40.06	19.96	56.08	100	0	P	V
													V
Remark	1. No other spurious found.												
	2. All results are PASS against Peak and Average limit line.												



**Band 3 - 5470~5725MHz  
WIFI 802.11n HT40 (Band Edge @ 3m)**

WIFI Ant. 1	Note	Frequency ( MHz )	Level ( dBμV/m )	Over Limit ( dB )	Limit Line ( dBμV/m )	Read Level ( dBμV )	Antenna Factor ( dB/m )	Path Loss ( dB )	Preamp Factor ( dB )	Ant Pos ( cm )	Table Pos ( deg )	Peak Avg. ( P/A )	Pol. ( H/V )
802.11n HT40 CH 102 5510MHz		5459.44	51.69	-22.31	74	42.77	32.05	9.89	33.02	100	63	P	H
		5464.48	58.6	-9.6	68.2	49.65	32.07	9.9	33.02	100	63	P	H
		5459.92	42.22	-11.78	54	33.3	32.05	9.89	33.02	100	63	A	H
	*	5510	97.01	-	-	88	32.1	9.94	33.03	100	63	P	H
	*	5510	88.8	-	-	79.79	32.1	9.94	33.03	100	63	A	H
		5763.74	50.74	-17.46	68.2	41.08	32.57	10.25	33.16	100	63	P	H
		5458	53.34	-20.66	74	44.42	32.05	9.89	33.02	101	115	P	V
		5467.12	63.38	-4.82	68.2	54.43	32.07	9.9	33.02	101	115	P	V
		5459.92	44.56	-9.44	54	35.64	32.05	9.89	33.02	101	115	A	V
	*	5510	100.29	-	-	91.28	32.1	9.94	33.03	101	115	P	V
	*	5510	92.43	-	-	83.42	32.1	9.94	33.03	101	115	A	V
		5757.44	50.12	-18.08	68.2	40.47	32.57	10.24	33.16	101	115	P	V
802.11n HT40 CH 110 5550MHz		5392.96	50.44	-23.56	74	41.64	31.98	9.84	33.02	100	63	P	H
		5467.36	49.71	-18.49	68.2	40.76	32.07	9.9	33.02	100	63	P	H
		5447.44	40.82	-13.18	54	31.91	32.05	9.88	33.02	100	63	A	H
	*	5550	99.13	-	-	90.01	32.19	9.98	33.05	100	63	P	H
	*	5550	91.04	-	-	81.92	32.19	9.98	33.05	100	63	A	H
		5741.06	52.39	-15.81	68.2	42.79	32.53	10.22	33.15	100	63	P	H
		5442.64	50.69	-23.31	74	41.8	32.03	9.88	33.02	100	119	P	V
		5470	52.56	-15.64	68.2	43.61	32.07	9.9	33.02	100	119	P	V
		5446.72	41.48	-12.52	54	32.57	32.05	9.88	33.02	100	119	A	V
	*	5550	103.13	-	-	94.01	32.19	9.98	33.05	100	119	P	V
	*	5550	94.82	-	-	85.7	32.19	9.98	33.05	100	119	A	V
		5749.25	50.63	-17.57	68.2	41.02	32.53	10.23	33.15	100	119	P	V



<b>802.11n</b>  <b>HT40</b>  <b>CH 134</b>  <b>5670MHz</b>		5459.55	51.12	-22.88	74	42.2	32.05	9.89	33.02	100	63	P	H
		5465.15	50.83	-17.37	68.2	41.88	32.07	9.9	33.02	100	63	P	H
		5454.65	40.21	-13.79	54	31.29	32.05	9.89	33.02	100	63	A	H
	*	5670	100.8	-	-	91.38	32.41	10.12	33.11	100	63	P	H
	*	5670	92.33	-	-	82.91	32.41	10.12	33.11	100	63	A	H
		5726.85	58.03	-10.17	68.2	48.46	32.5	10.2	33.13	100	63	P	H
		5438.2	49.61	-24.39	74	40.73	32.03	9.87	33.02	100	118	P	V
		5464.8	48.92	-19.28	68.2	39.97	32.07	9.9	33.02	100	118	P	V
		5459.9	40.55	-13.45	54	31.63	32.05	9.89	33.02	100	118	A	V
	*	5670	104.73	-	-	95.31	32.41	10.12	33.11	100	118	P	V
	*	5670	96.14	-	-	86.72	32.41	10.12	33.11	100	118	A	V
		5726.675	64.52	-3.68	68.2	54.95	32.5	10.2	33.13	100	118	P	V
<b>Remark</b>	1. No other spurious found. 2. All results are PASS against Peak and Average limit line.												



**Band 3 - 5470~5725MHz**  
**WIFI 802.11n HT40 (Harmonic @ 3m)**

WIFI Ant. 1	Note	Frequency ( MHz )	Level ( dBμV/m )	Over Limit ( dB )	Limit Line ( dBμV/m )	Read Level ( dBμV )	Antenna Factor ( dB/m )	Path Loss ( dB )	Preamp Factor ( dB )	Ant Pos ( cm )	Table Pos ( deg )	Peak Avg. ( P/A )	Pol. ( H/V )
802.11n HT40 CH 102 5510MHz		11020	45.42	-28.58	74	51.11	40.1	15.71	61.5	100	0	P	H
		16530	44.24	-23.96	68.2	43.45	38.58	19.44	57.23	100	0	P	H
													H
													H
		11020	45.46	-28.54	74	51.15	40.1	15.71	61.5	100	0	P	V
		16530	43.69	-24.51	68.2	42.9	38.58	19.44	57.23	100	0	P	V
802.11n HT40 CH 110 5550MHz		11100	45.35	-28.65	74	51.04	40.08	15.75	61.52	100	0	P	H
		16650	44.33	-23.87	68.2	42.9	38.87	19.55	56.99	100	0	P	H
													H
													H
		11100	45.16	-28.84	74	50.85	40.08	15.75	61.52	100	0	P	V
		16650	44.49	-23.71	68.2	43.06	38.87	19.55	56.99	100	0	P	V
802.11n HT40 CH 134 5670MHz		11340	45.75	-28.25	74	51.4	40.03	15.89	61.57	100	0	P	H
		17010	46.71	-21.49	68.2	43.34	39.76	19.87	56.26	100	0	P	H
													H
													H
		11340	45.86	-28.14	74	51.51	40.03	15.89	61.57	100	0	P	V
		17010	46.51	-21.69	68.2	43.14	39.76	19.87	56.26	100	0	P	V
Remark	1. No other spurious found.												
	2. All results are PASS against Peak and Average limit line.												



Emission below 1GHz  
WIFI 802.11n HT40 (LF @ 3m)

WIFI	Note	Frequency	Level	Over	Limit	Read	Antenna	Path	Preamp	Ant	Table	Peak	Pol.	
Ant.				Limit	Line	Level	Factor	Loss	Factor	Pos	Pos	Avg.		
1		( MHz )	( dBμV/m )	( dB )	( dBμV/m )	( dBμV )	( dB/m )	( dB )	( dB )	( cm )	( deg )	( P/A )	( H/V )	
802.11n HT40 LF		37.83	24.22	-15.78	40	35.61	20.26	0.84	32.49			P	H	
		63.21	22.42	-17.58	40	42.19	11.64	1.07	32.49			P	H	
		181.47	22.59	-20.91	43.5	38.42	14.72	1.86	32.41			P	H	
		482.7	28.48	-17.52	46	34.53	23.49	2.83	32.37			P	H	
		783.7	31.45	-14.55	46	31.93	28.02	3.73	32.23			P	H	
		954.5	33.79	-12.21	46	30	30.81	4.14	31.16	100	0	P	H	
														H
														H
														H
														H
														H
														H
			36.48	35.04	-4.96	40	45.92	20.79	0.82	32.49	100	0	P	V
			49.98	30.94	-9.06	40	48.41	14.07	0.95	32.49			P	V
			71.31	26.19	-13.81	40	45.34	12.16	1.18	32.49			P	V
			564.6	27.45	-18.55	46	30.83	25.92	3.13	32.43			P	V
			857.2	31.62	-14.38	46	30.61	28.97	3.92	31.88			P	V
			950.3	33.94	-12.06	46	30.4	30.61	4.13	31.2			P	V
														V
														V
													V	
													V	
													V	
													V	
													V	
Remark	1. No other spurious found. 2. All results are PASS against limit line.													



**Note symbol**

*	<b>Fundamental Frequency</b> which can be ignored. However, the level of any unwanted emissions shall not exceed the level of the fundamental frequency.
!	Test result is <b>over limit</b> line.
P/A	<b>Peak</b> or <b>Average</b>
H/V	<b>Horizontal</b> or <b>Vertical</b>



A calculation example for radiated spurious emission is shown as below:

WIFI	Note	Frequency	Level	Over	Limit	Read	Antenna	Path	Preamp	Ant	Table	Peak	Pol.
Ant.				Limit	Line	Level	Factor	Loss	Factor	Pos	Pos	Avg.	
1		( MHz )	( dBμV/m )	( dB )	( dBμV/m )	( dBμV )	( dB/m )	( dB )	( dB )	( cm )	( deg )	( P/A )	( H/V )
802.11b		2390	55.45	-18.55	74	54.51	32.22	4.58	35.86	103	308	P	H
CH 01													
2412MHz		2390	43.54	-10.46	54	42.6	32.22	4.58	35.86	103	308	A	H

1. Path Loss(dB) = Cable loss(dB) + Filter loss(dB) + Attenuator loss(dB)
2. Level(dBμV/m) = Antenna Factor(dB/m) + Path Loss(dB) + Read Level(dBμV) - Preamp Factor(dB)
3. Over Limit(dB) = Level(dBμV/m) – Limit Line(dBμV/m)

**For Peak Limit @ 2390MHz:**

1. Level(dBμV/m)  
= Antenna Factor(dB/m) + Path Loss(dB) + Read Level(dBμV) - Preamp Factor(dB)  
= 32.22(dB/m) + 4.58(dB) + 54.51(dBμV) – 35.86 (dB)  
= 55.45 (dBμV/m)
2. Over Limit(dB)  
= Level(dBμV/m) – Limit Line(dBμV/m)  
= 55.45(dBμV/m) – 74(dBμV/m)  
= -18.55(dB)

**For Average Limit @ 2390MHz:**

1. Level(dBμV/m)  
= Antenna Factor(dB/m) + Path Loss(dB) + Read Level(dBμV) - Preamp Factor(dB)  
= 32.22(dB/m) + 4.58(dB) + 42.6(dBμV) – 35.86 (dB)  
= 43.54 (dBμV/m)
2. Over Limit(dB) = Level(dBμV/m) – Limit Line(dBμV/m)  
= 43.54(dBμV/m) – 54(dBμV/m)  
= -10.46(dB)

**Both peak and average measured complies with the limit line, so test result is “PASS”.**



## Appendix D. Radiated Spurious Emission

Test Engineer :	Hao Hsu, Ken Wu, and Chuan Zhu	Temperature :	21~26°C
		Relative Humidity :	51~56%

### Note symbol

-L	Low channel location
-R	High channel location





Band 1 - 5150~5250MHz
WIFI 802.11a (Band Edge @ 3m)

Table with 2 columns (WIFI, ANT) and 2 rows (Peak, Avg.). It contains spectral plots for 'Horizontal' and 'Fundamental' views, and a 'Left blank' view. Each plot shows Level (dBuV/m) vs Frequency (MHz) with technical parameters like Site, Condition, Detector, Project, and Setting.



WIFI	Band 1 5150~5250MHz Band Edge @ 3m	
ANT	802.11a CH36 5180MHz	
1	Vertical	Fundamental
Peak	<p>Site : 03CH11-HY            Condition : PEAK_BE_74 3m HORN 91200-HF VERTICAL            RBW:1000.000KHz VBW:3000.000KHz SWT:Auto            Detector : Peak            Project : 890804-01            Setting : 14.5</p>	<p>Site : 03CH11-HY            Condition : PEAK(UNII) 3m HORN 91200-HF VERTICAL            RBW:1000.000KHz VBW:3000.000KHz SWT:Auto            Detector : Peak            Project : 890804-01            Setting : 14.5</p>
Avg.	<p>Site : 03CH11-HY            Condition : AVG_BE_54 3m HORN 91200-HF VERTICAL            RBW:1000.000KHz VBW:1000KHz SWT:Auto            Detector : Peak            Project : 890804-01            Setting : 14.5</p>	Left blank



WIFI	Band 1 5150~5250MHz Band Edge @ 3m	
ANT	802.11a CH44 5220MHz - L	
1	Horizontal	Fundamental
Peak	<p>Site : 03CH11-HY            Condition : PEAK_BE_74 3m HORN 91200-HF HORIZONTAL            RBW:1000.000KHz VBW:3000.000KHz SWT:Auto            Detector : Peak            Project : 890804-01</p>	<p>Site : 03CH11-HY            Condition : PEAK(UNII) 3m HORN 91200-HF HORIZONTAL            RBW:1000.000KHz VBW:3000.000KHz SWT:Auto            Detector : Peak            Project : 890804-01</p>
Avg.	<p>Site : 03CH11-HY            Condition : AVG_BE_54 3m HORN 91200-HF HORIZONTAL            RBW:1000.000KHz VBW:1000KHz SWT:Auto            Detector : Peak            Project : 890804-01</p>	Left blank

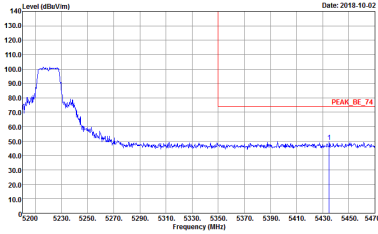
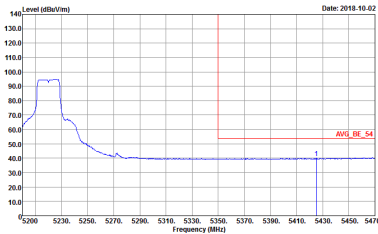

WIFI	Band 1 5150~5250MHz Band Edge @ 3m	
ANT	802.11a CH44 5220MHz - R	
1	Horizontal	Fundamental
<p><b>Peak</b></p>	 <p>Site : 03CH11-HY            Condition : PEAK_BE_74 3m HORN 91200-HF HORIZONTAL            RBW:1000.000KHz VBW:3000.000KHz SWF:Auto            Detector : Peak            Project : 890804-01</p>	<p>Left blank</p>
<p><b>Avg.</b></p>	 <p>Site : 03CH11-HY            Condition : AVG_BE_54 3m HORN 91200-HF HORIZONTAL            RBW:1000.000KHz VBW:1000KHz SWF:Auto            Detector : Peak            Project : 890804-01</p>	<p>Left blank</p>

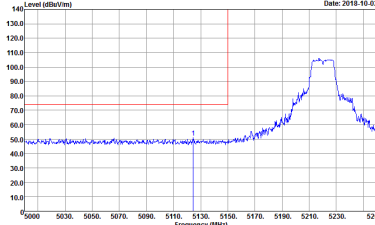
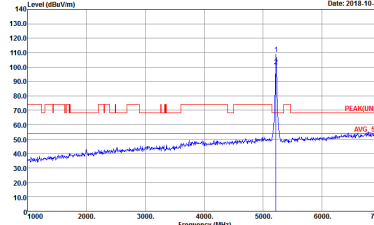
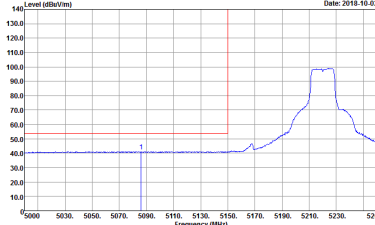

WIFI	Band 1 5150~5250MHz Band Edge @ 3m	
ANT	802.11a CH44 5220MHz - L	
1	Vertical	Fundamental
Peak	 <p>Site : 03CH11-HY            Condition : PEAK_BE_74 3m HORN 91200-HF VERTICAL            RBW:1000.000KHz VBW:3000.000KHz SWT:Auto            Detector : Peak            Project : 890804-01</p>	 <p>Site : 03CH11-HY            Condition : PEAK(UNII) 3m HORN 91200-HF VERTICAL            RBW:1000.000KHz VBW:3000.000KHz SWT:Auto            Detector : Peak            Project : 890804-01</p>
Avg.	 <p>Site : 03CH11-HY            Condition : AVG_BE_54 3m HORN 91200-HF VERTICAL            RBW:1000.000KHz VBW:1000KHz SWT:Auto            Detector : Peak            Project : 890804-01</p>	Left blank

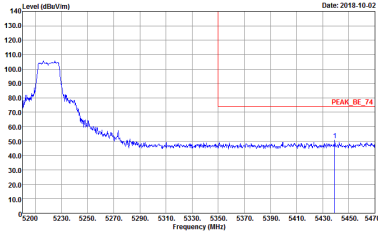
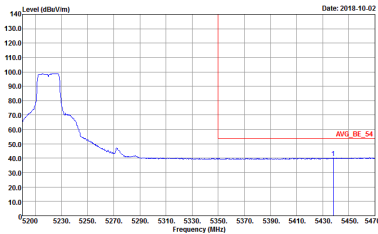

WIFI	Band 1 5150~5250MHz Band Edge @ 3m	
ANT	802.11a CH44 5220MHz - R	
1	Vertical	Fundamental
<p><b>Peak</b></p>	 <p>Site : 03CH11-HY            Condition : PEAK_BE_74 3m HORN 91200-HF VERTICAL            RBW:1000.000KHz VBW:3000.000KHz SWF:Auto            Detector : Peak            Project : 890804-01</p>	<p>Left blank</p>
<p><b>Avg.</b></p>	 <p>Site : 03CH11-HY            Condition : AVG_BE_54 3m HORN 91200-HF VERTICAL            RBW:1000.000KHz VBW:1000KHz SWF:Auto            Detector : Peak            Project : 890804-01</p>	<p>Left blank</p>



WIFI	Band 1 5150~5250MHz Band Edge @ 3m	
ANT	802.11a CH48 5240MHz - L	
1	Horizontal	Fundamental
Peak	<p>Site : 03CH11-HY            Condition : PEAK_BE_74 3m HORN 91200-HF HORIZONTAL            RBW:1000.000KHz VBW:3000.000KHz SWT:Auto            Detector : Peak            Project : 890804-01</p>	<p>Site : 03CH11-HY            Condition : PEAK(UNII) 3m HORN 91200-HF HORIZONTAL            RBW:1000.000KHz VBW:3000.000KHz SWT:Auto            Detector : Peak            Project : 890804-01</p>
Avg.	<p>Site : 03CH11-HY            Condition : AVG_BE_54 3m HORN 91200-HF HORIZONTAL            RBW:1000.000KHz VBW:1000KHz SWT:Auto            Detector : Peak            Project : 890804-01</p>	Left blank



WIFI	Band 1 5150~5250MHz Band Edge @ 3m	
ANT	802.11a CH48 5240MHz - R	
1	Horizontal	Fundamental
<p><b>Peak</b></p>	<p>Site : 03CH11-HY            Condition : PEAK_BE_74 3m HORN 91200-HF HORIZONTAL            RBW:1000.000KHz VBW:3000.000KHz SWF:Auto            Detector : Peak            Project : 890804-01</p>	<p>Left blank</p>
<p><b>Avg.</b></p>	<p>Site : 03CH11-HY            Condition : AVG_BE_54 3m HORN 91200-HF HORIZONTAL            RBW:1000.000KHz VBW:1000KHz SWF:Auto            Detector : Peak            Project : 890804-01</p>	<p>Left blank</p>





WIFI	Band 1 5150~5250MHz Band Edge @ 3m	
ANT	802.11a CH48 5240MHz - L	
1	Vertical	Fundamental
Peak	<p>Site : 03CH11-HY            Condition : PEAK_BE_74 3m HORN 91200-HF VERTICAL            : RBW:1000.000KHz VBW:3000.000KHz SWT:Auto            Detector : Peak            Project : 890804-01</p>	<p>Site : 03CH11-HY            Condition : PEAK(UNII) 3m HORN 91200-HF VERTICAL            : RBW:1000.000KHz VBW:3000.000KHz SWT:Auto            Detector : Peak            Project : 890804-01</p>
Avg.	<p>Site : 03CH11-HY            Condition : AVG_BE_54 3m HORN 91200-HF VERTICAL            : RBW:1000.000KHz VBW:1000KHz SWT:Auto            Detector : Peak            Project : 890804-01</p>	Left blank



WIFI	Band 1 5150~5250MHz Band Edge @ 3m	
ANT	802.11a CH48 5240MHz - R	
1	Vertical	Fundamental
<p><b>Peak</b></p>	<p>Site : 03CH11-HY            Condition : PEAK_BE_74 3m HORN 91200-HF VERTICAL            RBW:1000.000KHz VBW:3000.000KHz SWF:Auto            Detector : Peak            Project : 890804-01</p>	<p>Left blank</p>
<p><b>Avg.</b></p>	<p>Site : 03CH11-HY            Condition : AVG_BE_54 3m HORN 91200-HF VERTICAL            RBW:1000.000KHz VBW:1000KHz SWF:Auto            Detector : Peak            Project : 890804-01</p>	<p>Left blank</p>

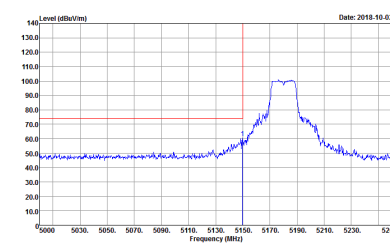
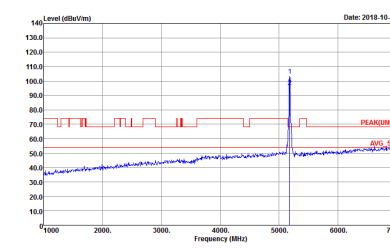
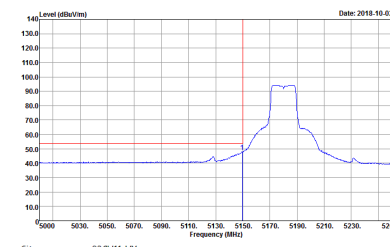

**Band 1 5150~5250MHz**  
**WIFI 802.11n HT20 (Band Edge @ 3m)**

WIFI	Band 1 5150~5250MHz Band Edge @ 3m	
ANT	802.11n HT20 CH36 5180MHz	
1	Horizontal	Fundamental
<p><b>Peak</b></p>	 <p>Site : 03CH11-HY            Condition : PEAK_BE_74 3m HORN 91200-HF HORIZONTAL            Detector : Peak            Project : 890804-01            Setting : 14.5</p>	 <p>Site : 03CH11-HY            Condition : PEAK(UNIT) 3m HORN 91200-HF HORIZONTAL            Detector : Peak            Project : 890804-01            Setting : 14.5</p>
<p><b>Avg.</b></p>	 <p>Site : 03CH11-HY            Condition : AVG_BE_54 3m HORN 91200-HF HORIZONTAL            Detector : Peak            Project : 890804-01            Setting : 14.5</p>	<p><b>Left blank</b></p>



WIFI	Band 1 5150~5250MHz Band Edge @ 3m	
ANT	802.11n HT20 CH36 5180MHz	
1	Vertical	Fundamental
Peak	<p>Site : 03CH11-HY            Condition : PEAK_BE_74 3m HORN 91200-HF VERTICAL            RBW:1000.000KHz VBW:3000.000KHz SWT:Auto            Detector : Peak            Project : 890804-01            Setting : 14.5</p>	<p>Site : 03CH11-HY            Condition : PEAK(UNII) 3m HORN 91200-HF VERTICAL            RBW:1000.000KHz VBW:3000.000KHz SWT:Auto            Detector : Peak            Project : 890804-01            Setting : 14.5</p>
Avg.	<p>Site : 03CH11-HY            Condition : AVG_BE_54 3m HORN 91200-HF VERTICAL            RBW:1000.000KHz VBW:1000KHz SWT:Auto            Detector : Peak            Project : 890804-01            Setting : 14.5</p>	Left blank

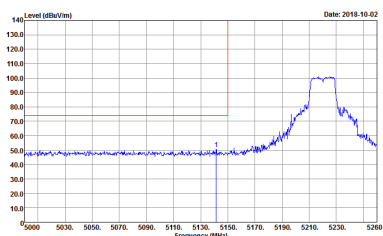
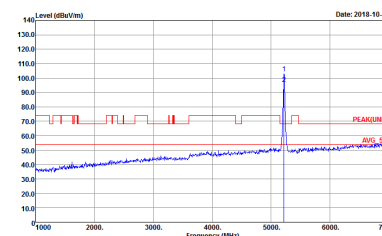
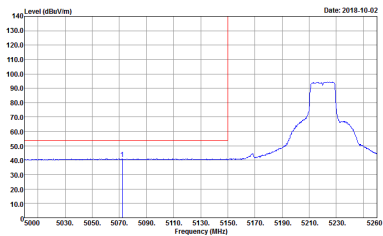

WIFI	Band 1 5150~5250MHz Band Edge @ 3m	
ANT	802.11n HT20 CH44 5220MHz - L	
1	Horizontal	Fundamental
Peak	 <p>Site : 03CH11-HY            Condition : PEAK_BE_74 3m HORN 91200-HF HORIZONTAL            : RBW:1000.000KHz VBW:3000.000KHz SWT:Auto            Detector : Peak            Project : 890804-01</p>	 <p>Site : 03CH11-HY            Condition : PEAK(UNII) 3m HORN 91200-HF HORIZONTAL            : RBW:1000.000KHz VBW:3000.000KHz SWT:Auto            Detector : Peak            Project : 890804-01</p>
Avg.	 <p>Site : 03CH11-HY            Condition : AVG_BE_54 3m HORN 91200-HF HORIZONTAL            : RBW:1000.000KHz VBW:1000KHz SWT:Auto            Detector : Peak            Project : 890804-01</p>	Left blank

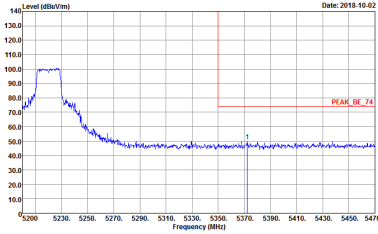
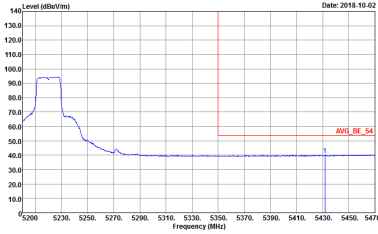

WIFI	Band 1 5150~5250MHz Band Edge @ 3m	
ANT	802.11n HT20 CH44 5220MHz - R	
1	Horizontal	Fundamental
<p><b>Peak</b></p>	 <p>Site : 03CH11-HY            Condition : PEAK_BE_74 3m HORN 91200-HF HORIZONTAL            RBW:1000.000KHz VBW:3000.000KHz SWF:Auto            Detector : Peak            Project : 890804-01</p>	<p>Left blank</p>
<p><b>Avg.</b></p>	 <p>Site : 03CH11-HY            Condition : AVG_BE_54 3m HORN 91200-HF HORIZONTAL            RBW:1000.000KHz VBW:1000KHz SWF:Auto            Detector : Peak            Project : 890804-01</p>	<p>Left blank</p>

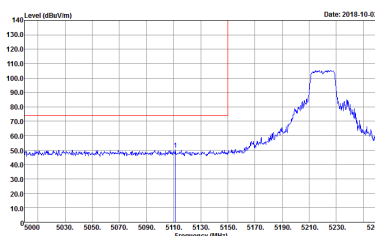
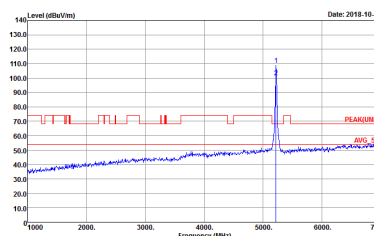
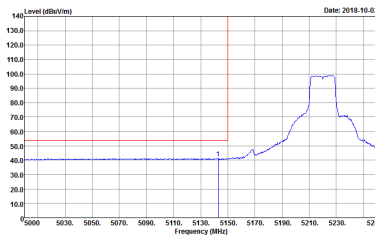

WIFI	Band 1 5150~5250MHz Band Edge @ 3m	
ANT	802.11n HT20 CH44 5220MHz - L	
1	Vertical	Fundamental
Peak	 <p>Site : 03CH11-HY            Condition : PEAK_BE_74 3m HORN 91200-HF VERTICAL            RBW:1000.000KHz VBW:3000.000KHz SWT:Auto            Detector : Peak            Project : 890804-01</p>	 <p>Site : 03CH11-HY            Condition : PEAK(UNII) 3m HORN 91200-HF VERTICAL            RBW:1000.000KHz VBW:3000.000KHz SWT:Auto            Detector : Peak            Project : 890804-01</p>
Avg.	 <p>Site : 03CH11-HY            Condition : AVG_BE_54 3m HORN 91200-HF VERTICAL            RBW:1000.000KHz VBW:1000KHz SWT:Auto            Detector : Peak            Project : 890804-01</p>	Left blank

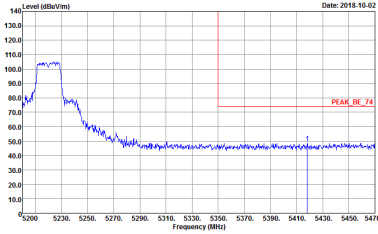
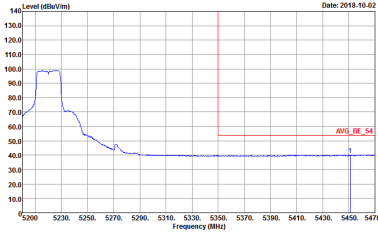

WIFI	Band 1 5150~5250MHz Band Edge @ 3m	
ANT	802.11n HT20 CH44 5220MHz - R	
1	Vertical	Fundamental
<p><b>Peak</b></p>	 <p>Site : 03CH11-HY            Condition : PEAK_BE_74 3m HORN 91200-HF VERTICAL            RBW:1000.000KHz VBW:3000.000KHz SWF:Auto            Detector : Peak            Project : 890804-01</p>	<p>Left blank</p>
<p><b>Avg.</b></p>	 <p>Site : 03CH11-HY            Condition : AVG_BE_54 3m HORN 91200-HF VERTICAL            RBW:1000.000KHz VBW:1000KHz SWF:Auto            Detector : Peak            Project : 890804-01</p>	<p>Left blank</p>



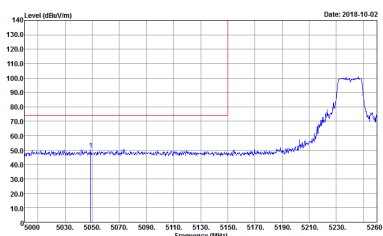
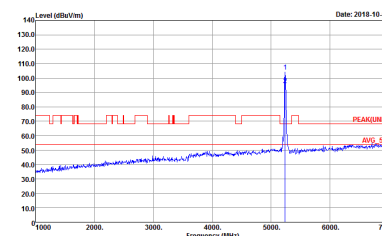
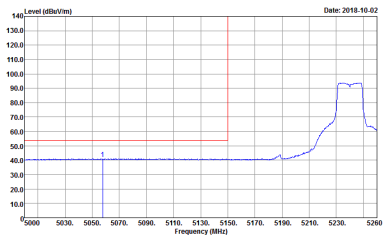

WIFI	Band 1 5150~5250MHz Band Edge @ 3m	
ANT	802.11n HT20 CH48 5240MHz - L	
1	Horizontal	Fundamental
Peak	 <p>Site : 03CH11-HY            Condition : PEAK_BE_74 3m HORN 91200-HF HORIZONTAL            RBW:1000.000KHz VBW:3000.000KHz SWT:Auto            Detector : Peak            Project : 890804-01</p>	 <p>Site : 03CH11-HY            Condition : PEAK(UNII) 3m HORN 91200-HF HORIZONTAL            RBW:1000.000KHz VBW:3000.000KHz SWT:Auto            Detector : Peak            Project : 890804-01</p>
Avg.	 <p>Site : 03CH11-HY            Condition : AVG_BE_54 3m HORN 91200-HF HORIZONTAL            RBW:1000.000KHz VBW:1000KHz SWT:Auto            Detector : Peak            Project : 890804-01</p>	Left blank

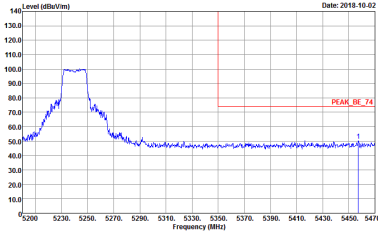
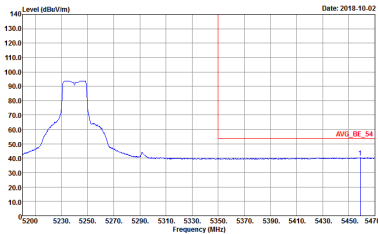

WIFI	Band 1 5150~5250MHz Band Edge @ 3m	
ANT	802.11n HT20 CH48 5240MHz - R	
1	Horizontal	Fundamental
<p><b>Peak</b></p>	 <p>Site : 03CH11-HY            Condition : PEAK_BE_74 3m HORN 91200-HF HORIZONTAL            RBW:1000.000KHz VBW:3000.000KHz SWF:Auto            Detector : Peak            Project : 890804-01</p>	<p>Left blank</p>
<p><b>Avg.</b></p>	 <p>Site : 03CH11-HY            Condition : AVG_BE_54 3m HORN 91200-HF HORIZONTAL            RBW:1000.000KHz VBW:1000KHz SWF:Auto            Detector : Peak            Project : 890804-01</p>	<p>Left blank</p>



WIFI	Band 1 5150~5250MHz Band Edge @ 3m	
ANT	802.11n HT20 CH48 5240MHz - L	
1	Vertical	Fundamental
Peak	<p>Site : 03CH11-HY            Condition : PEAK_BE_74 3m HORN 91200-HF VERTICAL            RBW:1000.000KHz VBW:3000.000KHz SWT:Auto            Detector : Peak            Project : 890804-01</p>	<p>Site : 03CH11-HY            Condition : PEAK(UNII) 3m HORN 91200-HF VERTICAL            RBW:1000.000KHz VBW:3000.000KHz SWT:Auto            Detector : Peak            Project : 890804-01</p>
Avg.	<p>Site : 03CH11-HY            Condition : AVG_BE_54 3m HORN 91200-HF VERTICAL            RBW:1000.000KHz VBW:1000KHz SWT:Auto            Detector : Peak            Project : 890804-01</p>	Left blank



WIFI	Band 1 5150~5250MHz Band Edge @ 3m	
ANT	802.11n HT20 CH48 5240MHz - R	
1	Vertical	Fundamental
<p><b>Peak</b></p>	<p>Site : 03CH11-HY            Condition : PEAK_BE_74 3m HORN 91200-HF VERTICAL            RBW:1000.000KHz VBW:3000.000KHz SWF:Auto            Detector : Peak            Project : 890804-01</p>	<p>Left blank</p>
<p><b>Avg.</b></p>	<p>Site : 03CH11-HY            Condition : AVG_BE_54 3m HORN 91200-HF VERTICAL            RBW:1000.000KHz VBW:1000KHz SWF:Auto            Detector : Peak            Project : 890804-01</p>	<p>Left blank</p>

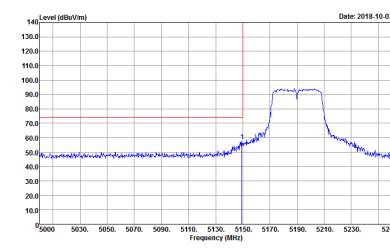
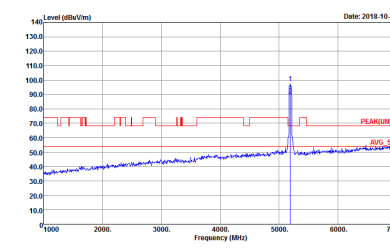
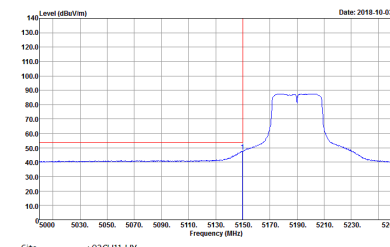

**Band 1 5150~5250MHz**  
**WIFI 802.11n HT40 (Band Edge @ 3m)**

WIFI	Band 1 5150~5250MHz Band Edge @ 3m	
ANT	802.11n HT40 CH38 5190MHz - L	
1	Horizontal	Fundamental
<p><b>Peak</b></p>	 <p>Site : 03CH11-HY            Condition : PEAK_BE_74 3m HORN 91200-HF HORIZONTAL            Detector : Peak            Project : 890804-01            Setting : 11.5</p>	 <p>Site : 03CH11-HY            Condition : PEAK(UNIT) 3m HORN 91200-HF HORIZONTAL            Detector : Peak            Project : 890804-01            Setting : 11.5</p>
<p><b>Avg.</b></p>	 <p>Site : 03CH11-HY            Condition : AVG_BE_54 3m HORN 91200-HF HORIZONTAL            Detector : Peak            Project : 890804-01            Setting : 11.5</p>	<p><b>Left blank</b></p>

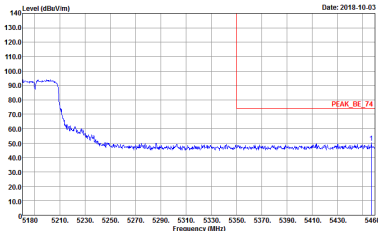
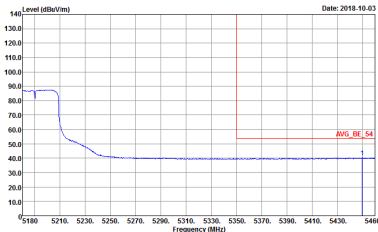

WIFI	Band 1 5150~5250MHz Band Edge @ 3m	
ANT	802.11n HT40 CH38 5190MHz - R	
1	Horizontal	Fundamental
<p><b>Peak</b></p>	 <p>Site : 03CH11-HY            Condition : PEAK_BE_74 3m HORN 91200-HF HORIZONTAL            RBW:1000.000KHz VBW:3000.000KHz SWF:Auto            Detector : Peak            Project : 890804-01            Setting : 11.5</p>	<p>Left blank</p>
<p><b>Avg.</b></p>	 <p>Site : 03CH11-HY            Condition : AVG_BE_54 3m HORN 91200-HF HORIZONTAL            RBW:1000.000KHz VBW:1000KHz SWF:Auto            Detector : Peak            Project : 890804-01            Setting : 11.5</p>	<p>Left blank</p>

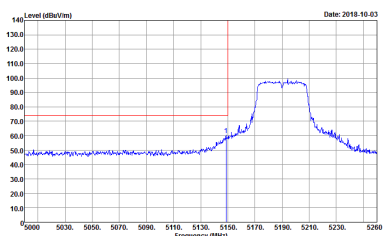
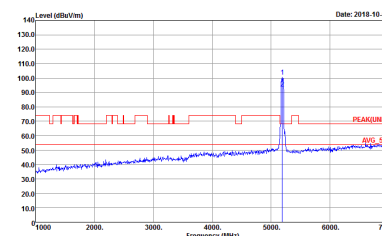
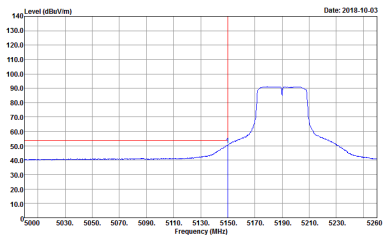

WIFI	Band 1 5150~5250MHz Band Edge @ 3m	
ANT	802.11n HT40 CH38 5190MHz - L	
1	Vertical	Fundamental
Peak	 <p>Site : 03CH11-HY            Condition : PEAK_BE_74 3m HORN 91200-HF VERTICAL            RBW:1000.000kHz VBW:3000.000kHz SWT:Auto            Detector : Peak            Project : 890804-01            Setting : 11.5</p>	 <p>Site : 03CH11-HY            Condition : PEAK(UNII) 3m HORN 91200-HF VERTICAL            RBW:1000.000kHz VBW:3000.000kHz SWT:Auto            Detector : Peak            Project : 890804-01            Setting : 11.5</p>
Avg.	 <p>Site : 03CH11-HY            Condition : AVG_BE_54 3m HORN 91200-HF VERTICAL            RBW:1000.000kHz VBW:1000kHz SWT:Auto            Detector : Peak            Project : 890804-01            Setting : 11.5</p>	Left blank

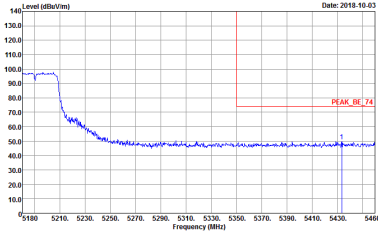
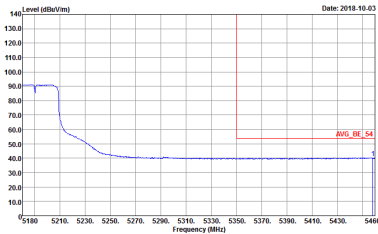

WIFI	Band 1 5150~5250MHz Band Edge @ 3m	
ANT	802.11n HT40 CH38 5190MHz - R	
1	Vertical	Fundamental
<p><b>Peak</b></p>	 <p>Site : 03CH11-HY            Condition : PEAK_BE_74 3m HORN 91200-HF VERTICAL            RBW:1000.000KHz VBW:3000.000KHz SWF:Auto            Detector : Peak            Project : 890804-01            Setting : 11.5</p>	<p>Left blank</p>
<p><b>Avg.</b></p>	 <p>Site : 03CH11-HY            Condition : AVG_BE_54 3m HORN 91200-HF VERTICAL            RBW:1000.000KHz VBW:1000KHz SWF:Auto            Detector : Peak            Project : 890804-01            Setting : 11.5</p>	<p>Left blank</p>



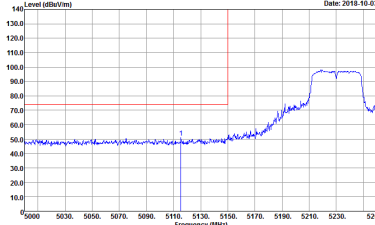
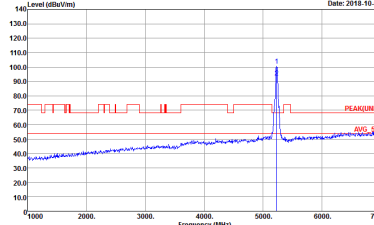
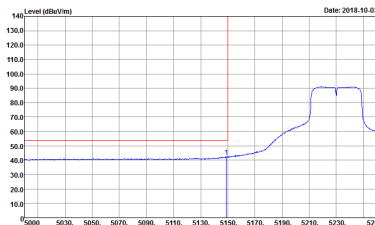

WIFI	Band 1 5150~5250MHz Band Edge @ 3m	
ANT	802.11n HT40 CH46 5230MHz - L	
1	Horizontal	Fundamental
Peak	 <p>Site : 03CH11-HY            Condition : PEAK_BE_74 3m HORN 91200-HF HORIZONTAL            RBW:1000.000KHz VBW:3000.000KHz SWT:Auto            Detector : Peak            Project : 890804-01            Setting : 15</p>	 <p>Site : 03CH11-HY            Condition : PEAK(UNII) 3m HORN 91200-HF HORIZONTAL            RBW:1000.000KHz VBW:3000.000KHz SWT:Auto            Detector : Peak            Project : 890804-01            Setting : 15</p>
Avg.	 <p>Site : 03CH11-HY            Condition : AVG_BE_54 3m HORN 91200-HF HORIZONTAL            RBW:1000.000KHz VBW:1000KHz SWT:Auto            Detector : Peak            Project : 890804-01            Setting : 15</p>	Left blank



WIFI	Band 1 5150~5250MHz Band Edge @ 3m	
ANT	802.11n HT40 CH46 5230MHz - R	
1	Horizontal	Fundamental
Peak	<p>Site : 03CH11-HY Condition : PEAK_BE_74 3m HORN 91200-HF HORIZONTAL RBW:1000.000KHz VBW:3000.000KHz SWF:Auto Detector : Peak Project : 890804-01 Setting : 15</p>	Left blank
Avg.	<p>Site : 03CH11-HY Condition : AVG_BE_54 3m HORN 91200-HF HORIZONTAL RBW:1000.000KHz VBW:1000KHz SWF:Auto Detector : Peak Project : 890804-01 Setting : 15</p>	Left blank



WIFI	Band 1 5150~5250MHz Band Edge @ 3m	
ANT	802.11n HT40 CH46 5230MHz - L	
1	Vertical	Fundamental
Peak	<p>Site : 03CH11-HY            Condition : PEAK_BE_74 3m HORN 91200-HF VERTICAL            RBW:1000.000kHz VBW:3000.000kHz SWT:Auto            Detector : Peak            Project : 890804-01            Setting : 15</p>	<p>Site : 03CH11-HY            Condition : PEAK(UNII) 3m HORN 91200-HF VERTICAL            RBW:1000.000kHz VBW:3000.000kHz SWT:Auto            Detector : Peak            Project : 890804-01            Setting : 15</p>
Avg.	<p>Site : 03CH11-HY            Condition : AVG_BE_54 3m HORN 91200-HF VERTICAL            RBW:1000.000kHz VBW:1000kHz SWT:Auto            Detector : Peak            Project : 890804-01            Setting : 15</p>	Left blank

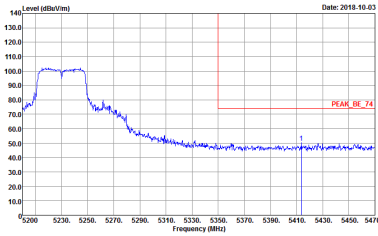
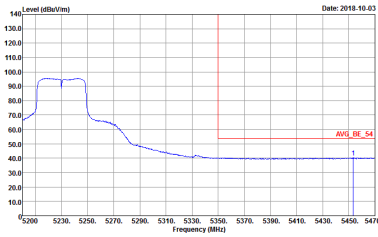

WIFI	Band 1 5150~5250MHz Band Edge @ 3m	
ANT	802.11n HT40 CH46 5230MHz - R	
1	Vertical	Fundamental
<p><b>Peak</b></p>	 <p>Site : 03CH11-HY            Condition : PEAK_BE_74 3m HORN 91200-HF VERTICAL            RBW:1000.000KHz VBW:3000.000KHz SWF:Auto            Detector : Peak            Project : 890804-01            Setting : 15</p>	<p>Left blank</p>
<p><b>Avg.</b></p>	 <p>Site : 03CH11-HY            Condition : AVG_BE_54 3m HORN 91200-HF VERTICAL            RBW:1000.000KHz VBW:1000KHz SWF:Auto            Detector : Peak            Project : 890804-01            Setting : 15</p>	<p>Left blank</p>



Band 1 - 5150~5250MHz
WIFI 802.11a (Harmonic @ 3m)

Table with 2 columns: Horizontal and Vertical. Each column contains a graph of Level (dBuV/m) vs Frequency (MHz) and associated test parameters like Site, Condition, Detector, and Project.

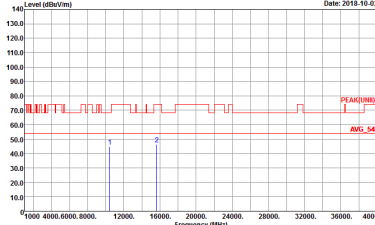
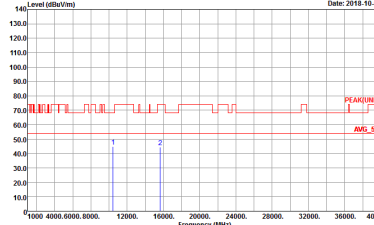

WIFI	Band 1 5150~5250MHz Harmonic @ 3m	
ANT	802.11a CH44 5220MHz	
1	Horizontal	Vertical
<p>Peak Avg.</p>	 <p>Site : 03CH11-HY Condition : PEAK(UNED) 3m HORN 9120D-HF HORIZONTAL Detector : Peak Project : 890804-01</p>	 <p>Site : 03CH11-HY Condition : PEAK(UNED) 3m HORN 9120D-HF VERTICAL Detector : Peak Project : 890804-01</p>



WIFI	Band 1 5150~5250MHz Harmonic @ 3m	
ANT	802.11a CH48 5240MHz	
1	Horizontal	Vertical
<b>Peak</b> <b>Avg.</b>	<p>Site : 03CH11-HY Condition : PEAK(UNED) 3m HORN 91200-HF HORIZONTAL Detector : Peak Project : 890804-01</p>	<p>Site : 03CH11-HY Condition : PEAK(UNED) 3m HORN 91200-HF VERTICAL Detector : Peak Project : 890804-01</p>



**Band 1 5150~5250MHz  
WIFI 802.11n HT20 (Harmonic @ 3m)**

<b>WIFI</b>	<b>Band 1 5150~5250MHz Harmonic @ 3m</b>	
<b>ANT</b>	<b>802.11n HT20 CH36 5180MHz</b>	
<b>1</b>	<b>Horizontal</b>	<b>Vertical</b>
<b>Peak</b> <b>Avg.</b>	<p>Site : 03CH11-HY Condition : PEAK(UNII) 3m HORN 91200-HF HORIZONTAL Detector : Peak Project : 890804.01</p>	<p>Site : 03CH11-HY Condition : PEAK(UNII) 3m HORN 91200-HF VERTICAL Detector : Peak Project : 890804.01</p>





WIFI	Band 1 5150~5250MHz Harmonic @ 3m	
ANT	802.11n HT20 CH44 5220MHz	
1	Horizontal	Vertical
<b>Peak</b> <b>Avg.</b>	<p>Site : 03CH11-HY Condition : PEAK(UNED) 3m HORN 91200-HF HORIZONTAL Detector : Peak Project : 890804-01</p>	<p>Site : 03CH11-HY Condition : PEAK(UNED) 3m HORN 91200-HF VERTICAL Detector : Peak Project : 890804-01</p>



WIFI	Band 1 5150~5250MHz Harmonic @ 3m	
ANT	802.11n HT20 CH48 5240MHz	
1	Horizontal	Vertical
<b>Peak</b> <b>Avg.</b>	<p>Site : 03CH11-HY Condition : PEAK(UNED) 3m HORN 91200-HF HORIZONTAL Detector : Peak Project : 890804-01</p>	<p>Site : 03CH11-HY Condition : PEAK(UNED) 3m HORN 91200-HF VERTICAL Detector : Peak Project : 890804-01</p>



**Band 1 5150~5250MHz  
WIFI 802.11n HT40 (Harmonic @ 3m)**

<b>WIFI</b>	<b>Band 1 5150~5250MHz Harmonic @ 3m</b>	
<b>ANT</b>	<b>802.11n HT40 CH38 5190MHz</b>	
<b>1</b>	<b>Horizontal</b>	<b>Vertical</b>
<b>Peak</b> <b>Avg.</b>	<p>Site : 03CH11-HY Condition : PEAK(UNII) 3m HORN 91200-HF HORIZONTAL Detector : Peak Project : 890804.01</p>	<p>Site : 03CH11-HY Condition : PEAK(UNII) 3m HORN 91200-HF VERTICAL Detector : Peak Project : 890804.01</p>

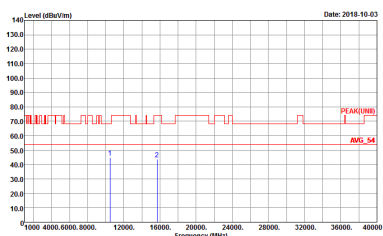
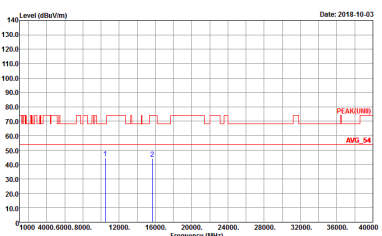

WIFI	Band 1 5150~5250MHz Harmonic @ 3m	
ANT	802.11n HT40 CH46 5230MHz	
1	Horizontal	Vertical
<p>Peak</p> <p>Avg.</p>	 <p>Site : 03CH11-HY          Condition : PEAK(UNED) 3m HORN 91200-HF HORIZONTAL          Detector : Peak          Project : 890804-01</p>	 <p>Site : 03CH11-HY          Condition : PEAK(UNED) 3m HORN 91200-HF VERTICAL          Detector : Peak          Project : 890804-01</p>

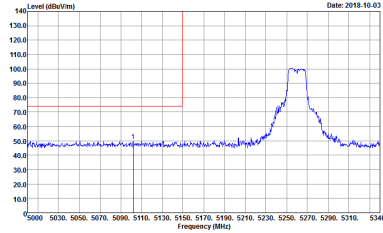
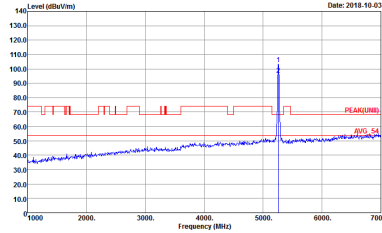
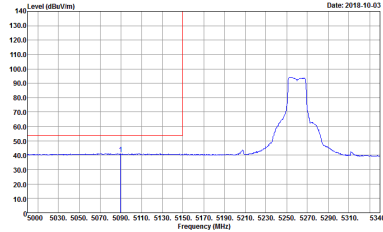

**Band 2 - 5250~5350MHz**  
**WIFI 802.11a (Band Edge @ 3m)**

WIFI	Band 2 5250~5350MHz Band Edge @ 3m	
ANT	802.11a CH52 5260MHz - L	
1	Horizontal	Fundamental
<p align="center"><b>Peak</b></p>	 <p>Site : 03CH11-HY            Condition : PEAK_BE_74 3m HORN 9120D-HF HORIZONTAL            Detector : Peak            Project : 890804-01</p>	 <p>Site : 03CH11-HY            Condition : PEAK(LINII) 3m HORN 9120D-HF HORIZONTAL            Detector : Peak            Project : 890804-01</p>
<p align="center"><b>Avg.</b></p>	 <p>Site : 03CH11-HY            Condition : AVG_BE_54 3m HORN 9120D-HF HORIZONTAL            Detector : Peak            Project : 890804-01</p>	<p align="center"><b>Left blank</b></p>

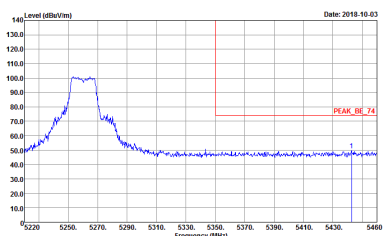
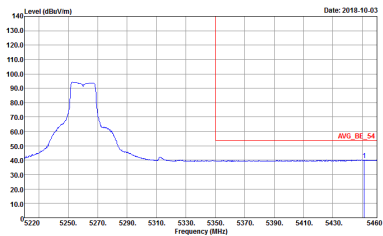

WIFI	Band 2 5250~5350MHz Band Edge @ 3m	
ANT	802.11a CH52 5260MHz - R	
1	Horizontal	Fundamental
<p><b>Peak</b></p>	 <p>Site : 03CH11-HY            Condition : PEAK_BE_74 3m HORN 91200-HF HORIZONTAL            RBW:1000.000KHz VBW:3000.000KHz SWF:Auto            Detector : Peak            Project : 890804-01</p>	<p>Left blank</p>
<p><b>Avg.</b></p>	 <p>Site : 03CH11-HY            Condition : AVG_BE_54 3m HORN 91200-HF HORIZONTAL            RBW:1000.000KHz VBW:1000KHz SWF:Auto            Detector : Peak            Project : 890804-01</p>	<p>Left blank</p>



WIFI	Band 2 5250~5350MHz Band Edge @ 3m	
ANT	802.11a CH52 5260MHz - L	
1	Vertical	Fundamental
Peak	<p>Site : 03CH11-HY            Condition : PEAK_BE_74 3m HORN 91200-HF VERTICAL            RBW:1000.000KHz VBW:3000.000KHz SWT:Auto            Detector : Peak            Project : 890804-01</p>	<p>Site : 03CH11-HY            Condition : PEAK(UNII) 3m HORN 91200-HF VERTICAL            RBW:1000.000KHz VBW:3000.000KHz SWT:Auto            Detector : Peak            Project : 890804-01</p>
Avg.	<p>Site : 03CH11-HY            Condition : AVG_BE_54 3m HORN 91200-HF VERTICAL            RBW:1000.000KHz VBW:1000KHz SWT:Auto            Detector : Peak            Project : 890804-01</p>	Left blank

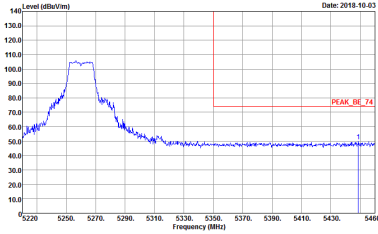
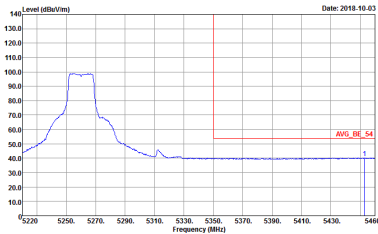

WIFI	Band 2 5250~5350MHz Band Edge @ 3m	
ANT	802.11a CH52 5260MHz - R	
1	Vertical	Fundamental
<p><b>Peak</b></p>	 <p>Site : 03CH11-HY            Condition : PEAK_BE_74 3m HORN 91200-HF VERTICAL            RBW:1000.000KHz VBW:3000.000KHz SWF:Auto            Detector : Peak            Project : 890804-01</p>	<p>Left blank</p>
<p><b>Avg.</b></p>	 <p>Site : 03CH11-HY            Condition : AVG_BE_54 3m HORN 91200-HF VERTICAL            RBW:1000.000KHz VBW:1000KHz SWF:Auto            Detector : Peak            Project : 890804-01</p>	<p>Left blank</p>



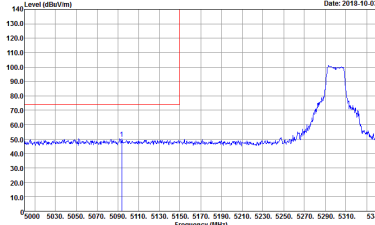
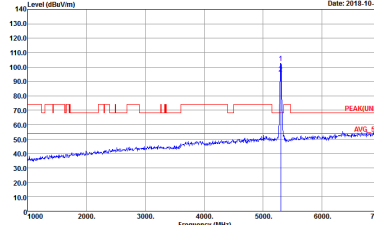
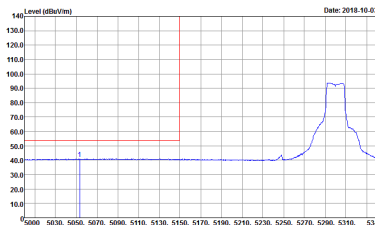

WIFI	Band 2 5250~5350MHz Band Edge @ 3m	
ANT	802.11a CH60 5300MHz - L	
1	Horizontal	Fundamental
Peak	 <p>Site : 03CH11-HY            Condition : PEAK_BE_74 3m HORN 91200-HF HORIZONTAL            RBW:1000.000KHz VBW:3000.000KHz SWT:Auto            Detector : Peak            Project : 890804-01</p>	 <p>Site : 03CH11-HY            Condition : PEAK(UNII) 3m HORN 91200-HF HORIZONTAL            RBW:1000.000KHz VBW:3000.000KHz SWT:Auto            Detector : Peak            Project : 890804-01</p>
Avg.	 <p>Site : 03CH11-HY            Condition : AVG_BE_54 3m HORN 91200-HF HORIZONTAL            RBW:1000.000KHz VBW:1000KHz SWT:Auto            Detector : Peak            Project : 890804-01</p>	Left blank

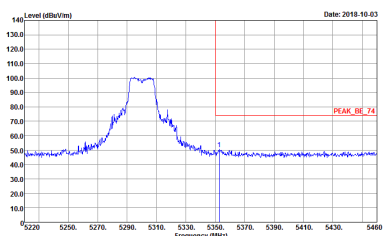
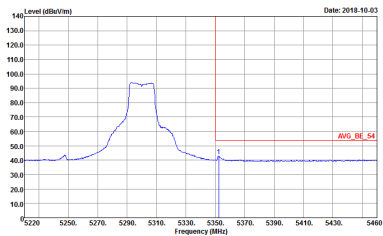

WIFI	Band 2 5250~5350MHz Band Edge @ 3m	
ANT	802.11a CH60 5300MHz - R	
1	Horizontal	Fundamental
<p><b>Peak</b></p>	 <p>Site : 03CH11-HY            Condition : PEAK_BE_74 3m HORN 91200-HF HORIZONTAL            RBW:1000.000KHz VBW:3000.000KHz SWF:Auto            Detector : Peak            Project : 890804-01</p>	<p>Left blank</p>
<p><b>Avg.</b></p>	 <p>Site : 03CH11-HY            Condition : AVG_BE_54 3m HORN 91200-HF HORIZONTAL            RBW:1000.000KHz VBW:1000KHz SWF:Auto            Detector : Peak            Project : 890804-01</p>	<p>Left blank</p>



WIFI	Band 2 5250~5350MHz Band Edge @ 3m	
ANT	802.11a CH60 5300MHz - L	
1	Vertical	Fundamental
Peak	<p>Site : 03CH11-HY            Condition : PEAK_BE_74 3m HORN 91200-HF VERTICAL            : RBW:1000.000KHz VBW:3000.000KHz SWT:Auto            Detector : Peak            Project : 890804-01</p>	<p>Site : 03CH11-HY            Condition : PEAK(UNII) 3m HORN 91200-HF VERTICAL            : RBW:1000.000KHz VBW:3000.000KHz SWT:Auto            Detector : Peak            Project : 890804-01</p>
Avg.	<p>Site : 03CH11-HY            Condition : AVG_BE_54 3m HORN 91200-HF VERTICAL            : RBW:1000.000KHz VBW:1000KHz SWT:Auto            Detector : Peak            Project : 890804-01</p>	Left blank

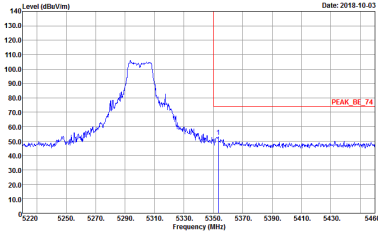
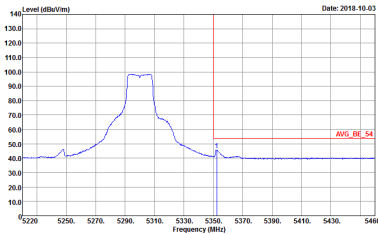

WIFI	Band 2 5250~5350MHz Band Edge @ 3m	
ANT	802.11a CH60 5300MHz - R	
1	Vertical	Fundamental
<p><b>Peak</b></p>	 <p>Site : 03CH11-HY            Condition : PEAK_BE_74 3m HORN 91200-HF VERTICAL            RBW:1000.000kHz VBW:3000.000kHz SWF:Auto            Detector : Peak            Project : 890804-01</p>	<p>Left blank</p>
<p><b>Avg.</b></p>	 <p>Site : 03CH11-HY            Condition : AVG_BE_54 3m HORN 91200-HF VERTICAL            RBW:1000.000kHz VBW:1.000kHz SWF:Auto            Detector : Peak            Project : 890804-01</p>	<p>Left blank</p>

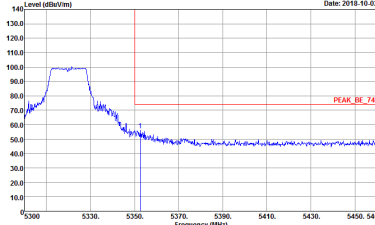
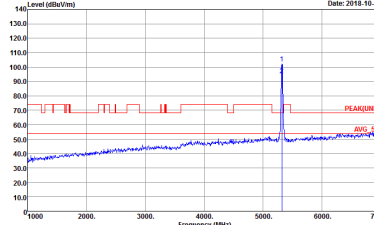
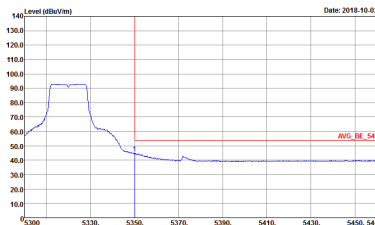

WIFI	Band 2 5250~5350MHz Band Edge @ 3m	
ANT	802.11a CH64 5320MHz	
1	Horizontal	Fundamental
<p><b>Peak</b></p>	 <p>Site : 03CH11-HY            Condition : PEAK_BE_74 3m HORN 91200-HF HORIZONTAL            Detector : Peak            Project : 890804-01            Setting : 14</p>	 <p>Site : 03CH11-HY            Condition : PEAK(UNII) 3m HORN 91200-HF HORIZONTAL            Detector : Peak            Project : 890804-01            Setting : 14</p>
<p><b>Avg.</b></p>	 <p>Site : 03CH11-HY            Condition : AVG_BE_54 3m HORN 91200-HF HORIZONTAL            Detector : Peak            Project : 890804-01            Setting : 14</p>	<p><b>Left blank</b></p>

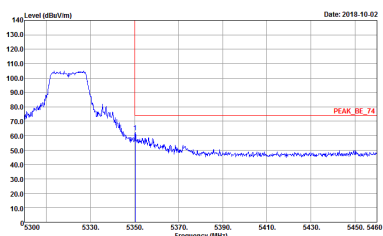
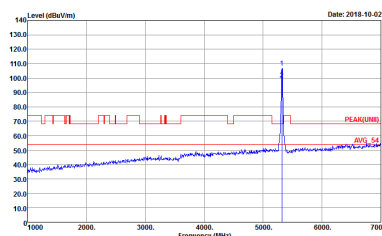
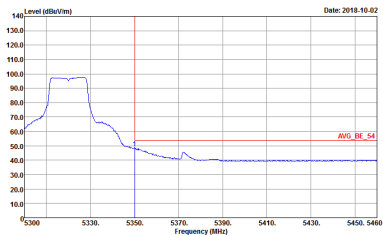

WIFI	Band 2 5250~5350MHz Band Edge @ 3m	
ANT	802.11a CH64 5320MHz	
1	Vertical	Fundamental
<p><b>Peak</b></p>	 <p>Site : 03CH11-HY            Condition : PEAK_BE_74 3m HORN 91200-HF VERTICAL            RBW:1000.000KHz VBW:3000.000KHz SWT:Auto            Detector : Peak            Project : 890804-01            Setting : 14</p>	 <p>Site : 03CH11-HY            Condition : PEAK(U)B 3m HORN 91200-HF VERTICAL            RBW:1000.000KHz VBW:3000.000KHz SWT:Auto            Detector : Peak            Project : 890804-01            Setting : 14</p>
<p><b>Avg.</b></p>	 <p>Site : 03CH11-HY            Condition : AVG_BE_54 3m HORN 91200-HF VERTICAL            RBW:1000.000KHz VBW:1000KHz SWT:Auto            Detector : Peak            Project : 890804-01            Setting : 14</p>	<p><b>Left blank</b></p>

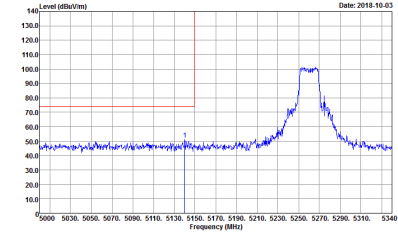
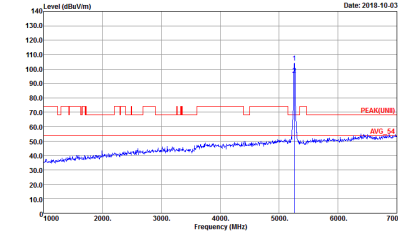
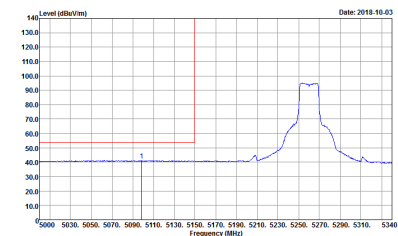

**Band 2 5250~5350MHz**  
**WIFI 802.11n HT20 (Band Edge @ 3m)**

WIFI	Band 2 5250~5350MHz Band Edge @ 3m	
ANT	802.11n HT20 CH52 5260MHz - L	
<p align="center"><b>1</b></p>	<p align="center"><b>Horizontal</b></p>  <p>Site : 03CH11-HY          Condition : PEAK_BE_74 3m HORN 91200-HF HORIZONTAL          Detector : RBW:1000.000kHz VBW:3000.000kHz SWT:Auto          Project : 890804-01</p>	<p align="center"><b>Fundamental</b></p>  <p>Site : 03CH11-HY          Condition : PEAK(LIMB) 3m HORN 91200-HF HORIZONTAL          Detector : RBW:1000.000kHz VBW:3000.000kHz SWT:Auto          Project : 890804-01</p>
<p align="center"><b>Peak</b></p>	<p align="center"><b>Avg.</b></p>  <p>Site : 03CH11-HY          Condition : AVG_BE_54 3m HORN 91200-HF HORIZONTAL          Detector : Peak          Project : 890804-01</p>	<p align="center"><b>Left blank</b></p>

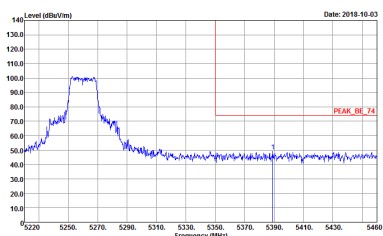
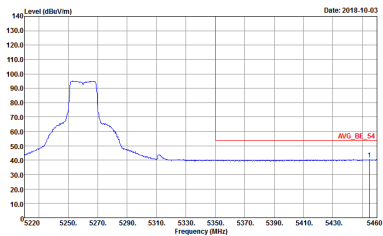

WIFI	Band 2 5250~5350MHz Band Edge @ 3m	
ANT	802.11n HT20 CH52 5260MHz - R	
1	Horizontal	Fundamental
<p><b>Peak</b></p>	 <p>Site : 03CH11-HY            Condition : PEAK_BE_74 3m HORN 91200-HF HORIZONTAL            RBW:1000.000KHz VBW:3000.000KHz SWF:Auto            Detector : Peak            Project : 890804-01</p>	<p>Left blank</p>
<p><b>Avg.</b></p>	 <p>Site : 03CH11-HY            Condition : AVG_BE_54 3m HORN 91200-HF HORIZONTAL            RBW:1000.000KHz VBW:1000KHz SWF:Auto            Detector : Peak            Project : 890804-01</p>	<p>Left blank</p>



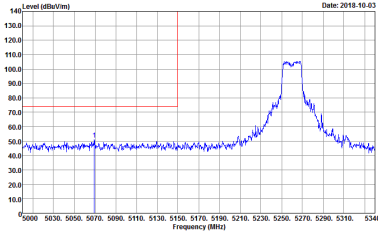
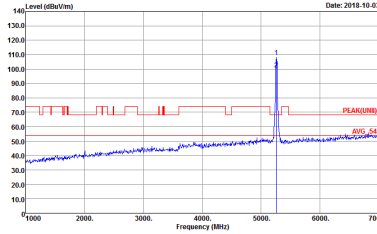
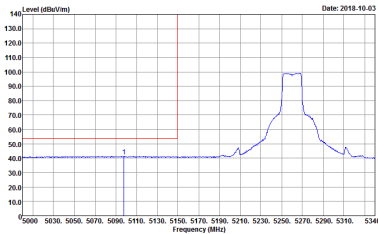

WIFI	Band 2 5250~5350MHz Band Edge @ 3m	
ANT	802.11n HT20 CH52 5260MHz - L	
1	Vertical	Fundamental
Peak	 <p>Site : 03CH11-HY            Condition : PEAK_BE_74 3m HORN 91200-HF VERTICAL            RBW:1000.000KHz VBW:3000.000KHz SWT:Auto            Detector : Peak            Project : 890804-01</p>	 <p>Site : 03CH11-HY            Condition : PEAK(UNII) 3m HORN 91200-HF VERTICAL            RBW:1000.000KHz VBW:3000.000KHz SWT:Auto            Detector : Peak            Project : 890804-01</p>
Avg.	 <p>Site : 03CH11-HY            Condition : AVG_BE_54 3m HORN 91200-HF VERTICAL            RBW:1000.000KHz VBW:1000KHz SWT:Auto            Detector : Peak            Project : 890804-01</p>	Left blank

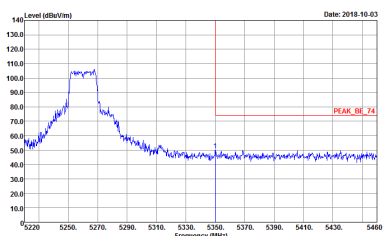
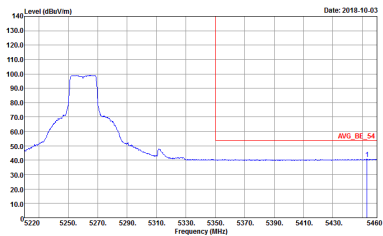

WIFI	Band 2 5250~5350MHz Band Edge @ 3m	
ANT	802.11n HT20 CH52 5260MHz - R	
1	Vertical	Fundamental
<p><b>Peak</b></p>	 <p>Site : 03CH11-HY            Condition : PEAK_BE_74 3m HORN 91200-HF VERTICAL            RBW:1000.000KHz VBW:3000.000KHz SWF:Auto            Detector : Peak            Project : 890804-01</p>	<p>Left blank</p>
<p><b>Avg.</b></p>	 <p>Site : 03CH11-HY            Condition : AVG_BE_54 3m HORN 91200-HF VERTICAL            RBW:1000.000KHz VBW:1000KHz SWF:Auto            Detector : Peak            Project : 890804-01</p>	<p>Left blank</p>



WIFI	Band 2 5250~5350MHz Band Edge @ 3m	
ANT	802.11n HT20 CH60 5300MHz - L	
1	Horizontal	Fundamental
Peak	<p>Site : 03CH11-HY            Condition : PEAK_BE_74 3m HORN 91200-HF HORIZONTAL            RBW:1000.000KHz VBW:3000.000KHz SWT:Auto            Detector : Peak            Project : 890804-01</p>	<p>Site : 03CH11-HY            Condition : PEAK(UNII) 3m HORN 91200-HF HORIZONTAL            RBW:1000.000KHz VBW:3000.000KHz SWT:Auto            Detector : Peak            Project : 890804-01</p>
Avg.	<p>Site : 03CH11-HY            Condition : AVG_BE_54 3m HORN 91200-HF HORIZONTAL            RBW:1000.000KHz VBW:1000KHz SWT:Auto            Detector : Peak            Project : 890804-01</p>	Left blank

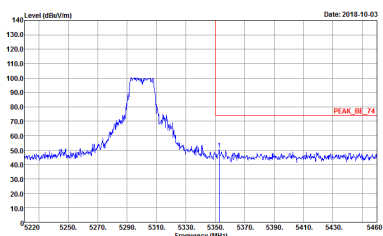
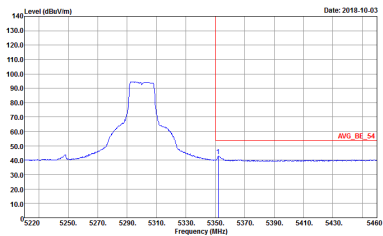

WIFI	Band 2 5250~5350MHz Band Edge @ 3m	
ANT	802.11n HT20 CH60 5300MHz - R	
1	Horizontal	Vertical
<p><b>Peak</b></p>	 <p>Site : 03CH11-HY            Condition : PEAK_BE_74 3m HORN 91200-HF HORIZONTAL            RBW:1000.000KHz VBW:3000.000KHz SWF:Auto            Detector : Peak            Project : 890804-01</p>	<p>Left blank</p>
<p><b>Avg.</b></p>	 <p>Site : 03CH11-HY            Condition : AVG_BE_54 3m HORN 91200-HF HORIZONTAL            RBW:1000.000KHz VBW:1000KHz SWF:Auto            Detector : Peak            Project : 890804-01</p>	<p>Left blank</p>

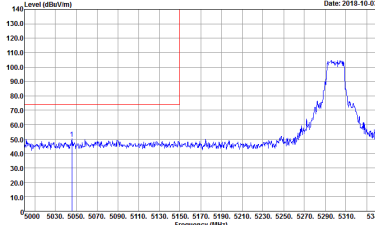
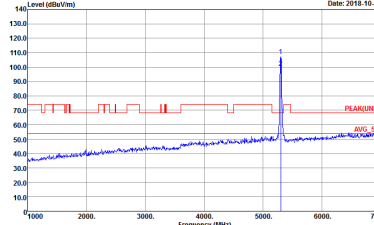
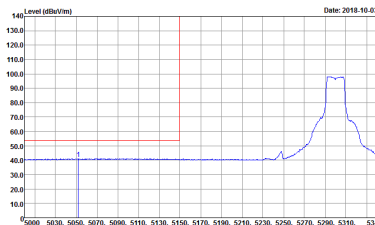

WIFI	Band 2 5250~5350MHz Band Edge @ 3m	
ANT	802.11n HT20 CH60 5300MHz - L	
1	Vertical	Fundamental
Peak	 <p>Site : 03CH11-HY            Condition : PEAK_BE_74 3m HORN 91200-HF VERTICAL            RBW:1000.000KHz VBW:3000.000KHz SWT:Auto            Detector : Peak            Project : 890804-01</p>	 <p>Site : 03CH11-HY            Condition : PEAK(UNII) 3m HORN 91200-HF VERTICAL            RBW:1000.000KHz VBW:3000.000KHz SWT:Auto            Detector : Peak            Project : 890804-01</p>
Avg.	 <p>Site : 03CH11-HY            Condition : AVG_BE_54 3m HORN 91200-HF VERTICAL            RBW:1000.000KHz VBW:1000KHz SWT:Auto            Detector : Peak            Project : 890804-01</p>	Left blank

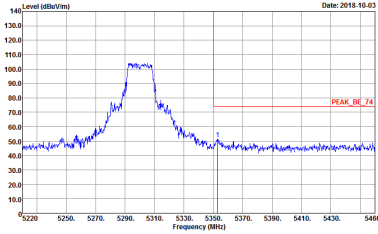
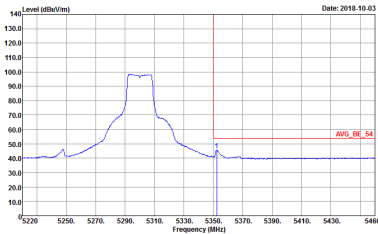

WIFI	Band 2 5250~5350MHz Band Edge @ 3m	
ANT	802.11n HT20 CH60 5300MHz - R	
1	Vertical	Fundamental
<p><b>Peak</b></p>	 <p>Site : 03CH11-HY            Condition : PEAK_BE_74 3m HORN 91200-HF VERTICAL            RBW:1000.000KHz VBW:3000.000KHz SWF:Auto            Detector : Peak            Project : 890804-01</p>	<p>Left blank</p>
<p><b>Avg.</b></p>	 <p>Site : 03CH11-HY            Condition : AVG_BE_54 3m HORN 91200-HF VERTICAL            RBW:1000.000KHz VBW:1000KHz SWF:Auto            Detector : Peak            Project : 890804-01</p>	<p>Left blank</p>

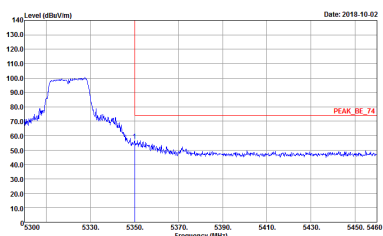
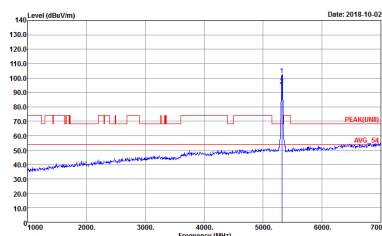
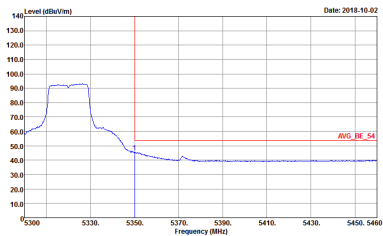

WIFI	Band 2 5250~5350MHz Band Edge @ 3m	
ANT	802.11n HT20 CH64 5320MHz	
1	Horizontal	Fundamental
<p><b>Peak</b></p>	 <p>Site : 03CH11-HY            Condition : PEAK_BE_74 3m HORN 91200-HF HORIZONTAL            Detector : Peak            Project : 890804-01            Setting : 14</p>	 <p>Site : 03CH11-HY            Condition : PEAK(UNII) 3m HORN 91200-HF HORIZONTAL            Detector : Peak            Project : 890804-01            Setting : 14</p>
<p><b>Avg.</b></p>	 <p>Site : 03CH11-HY            Condition : AVG_BE_54 3m HORN 91200-HF HORIZONTAL            Detector : Peak            Project : 890804-01            Setting : 14</p>	<p><b>Left blank</b></p>

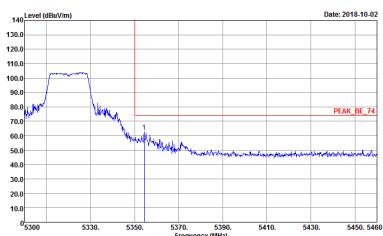
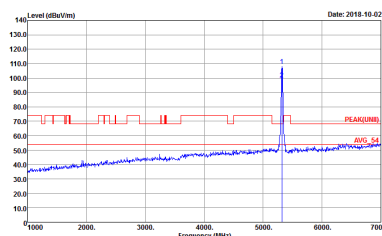
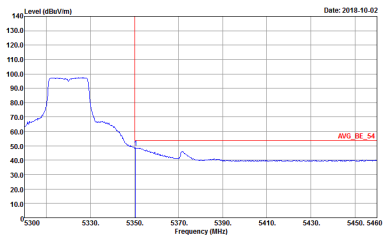

WIFI	Band 2 5250~5350MHz Band Edge @ 3m	
ANT	802.11n HT20 CH64 5320MHz	
1	Vertical	Fundamental
<p><b>Peak</b></p>	 <p>Site : 03CH11-HY            Condition : PEAK_BE_74 3m HORN 9120D-HF VERTICAL            RBW:1000.000KHz VBW:3000.000KHz SWT:Auto            Detector : Peak            Project : 890804-01            Setting : 14</p>	 <p>Site : 03CH11-HY            Condition : PEAK(FUN) 3m HORN 9120D-HF VERTICAL            RBW:1000.000KHz VBW:3000.000KHz SWT:Auto            Detector : Peak            Project : 890804-01            Setting : 14</p>
<p><b>Avg.</b></p>	 <p>Site : 03CH11-HY            Condition : AVG_BE_54 3m HORN 9120D-HF VERTICAL            RBW:1000.000KHz VBW:1000KHz SWT:Auto            Detector : Peak            Project : 890804-01            Setting : 14</p>	<p>Left blank</p>





**Band 2 5250~5350MHz**  
**WIFI 802.11n HT40 (Band Edge @ 3m)**

WIFI	Band 2 5250~5350MHz Band Edge @ 3m	
ANT	802.11n HT40 CH54 5270 - L	
1	Horizontal	Fundamental
<p><b>Peak</b></p>	<p>Site : 03CH11-HY          Condition : PEAK_BE_74 3m HORN 91200-HF HORIZONTAL          RBW:1000.000KHz VBW:3000.000KHz SWT:Auto          Detector : Peak          Project : 890804-01          Setting : 14.5</p>	<p>Site : 03CH11-HY          Condition : PEAK(UM) 3m HORN 91200-HF HORIZONTAL          RBW:1000.000KHz VBW:3000.000KHz SWT:Auto          Detector : Peak          Project : 890804-01          Setting : 14.5</p>
<p><b>Avg.</b></p>	<p>Site : 03CH11-HY          Condition : AVG_BE_54 3m HORN 91200-HF HORIZONTAL          RBW:1000.000KHz VBW:1.000KHz SWT:Auto          Detector : Peak          Project : 890804-01          Setting : 14.5</p>	<p><b>Left blank</b></p>

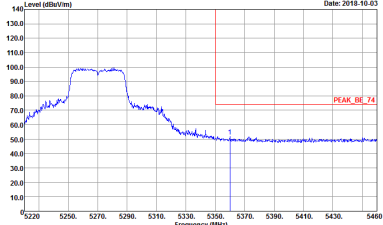
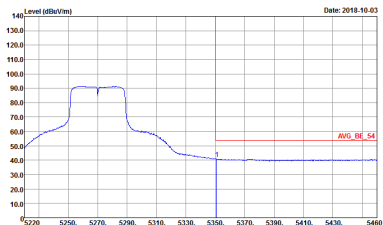

WIFI	Band 2 5250~5350MHz Band Edge @ 3m	
ANT	802.11n HT40 CH54 5270 - R	
1	Horizontal	Fundamental
<p><b>Peak</b></p>	 <p>Site : 03CH11-HY            Condition : PEAK_BE_74 3m HORN 91200-HF HORIZONTAL            RBW:1000.000KHz VBW:3000.000KHz SWF:Auto            Detector : Peak            Project : 890804-01            Setting : 14.5</p>	<p>Left blank</p>
<p><b>Avg.</b></p>	 <p>Site : 03CH11-HY            Condition : AVG_BE_54 3m HORN 91200-HF HORIZONTAL            RBW:1000.000KHz VBW:1000KHz SWF:Auto            Detector : Peak            Project : 890804-01            Setting : 14.5</p>	<p>Left blank</p>

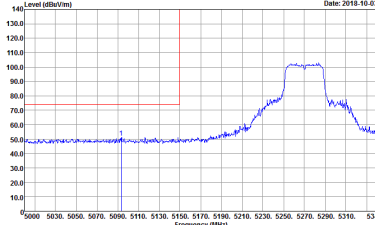
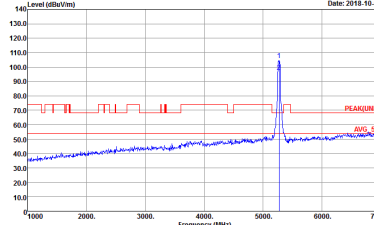
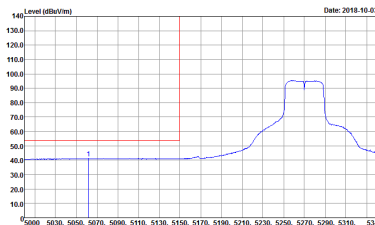

WIFI	Band 2 5250~5350MHz Band Edge @ 3m	
ANT	802.11n HT40 CH54 5270 - L	
1	Vertical	Vertical
Peak	 <p>Site : 03CH11-HY            Condition : PEAK_BE_74 3m HORN 91200-HF VERTICAL            RBW:1000.000KHz VBW:3000.000KHz SWT:Auto            Detector : Peak            Project : 890804-01            Setting : 14.5</p>	 <p>Site : 03CH11-HY            Condition : PEAK(UNII) 3m HORN 91200-HF VERTICAL            RBW:1000.000KHz VBW:3000.000KHz SWT:Auto            Detector : Peak            Project : 890804-01            Setting : 14.5</p>
Avg.	 <p>Site : 03CH11-HY            Condition : AVG_BE_54 3m HORN 91200-HF VERTICAL            RBW:1000.000KHz VBW:1000KHz SWT:Auto            Detector : Peak            Project : 890804-01            Setting : 14.5</p>	Left blank

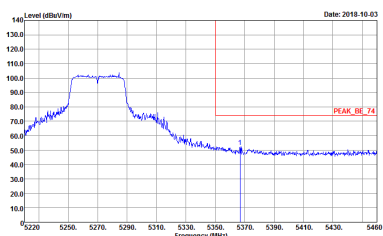
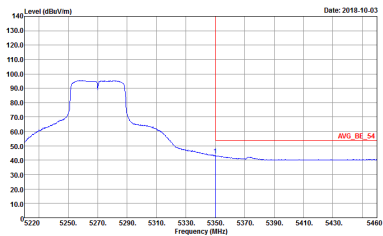

WIFI	Band 2 5250~5350MHz Band Edge @ 3m	
ANT	802.11n HT40 CH54 5270 - R	
1	Vertical	Vertical
<p><b>Peak</b></p>	 <p>Site : 03CH11-HY            Condition : PEAK_BE_74 3m HORN 91200-HF VERTICAL            RBW:1000.000KHz VBW:3000.000KHz SWF:Auto            Detector : Peak            Project : 890804-01            Setting : 14.5</p>	<p>Left blank</p>
<p><b>Avg.</b></p>	 <p>Site : 03CH11-HY            Condition : AVG_BE_54 3m HORN 91200-HF VERTICAL            RBW:1000.000KHz VBW:1000KHz SWF:Auto            Detector : Peak            Project : 890804-01            Setting : 14.5</p>	<p>Left blank</p>

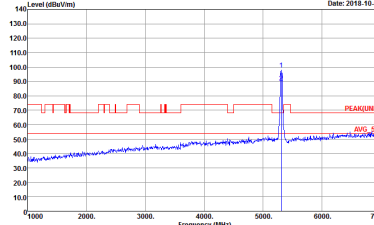

WIFI	Band 2 5250~5350MHz Band Edge @ 3m	
ANT	802.11n HT40 CH62 5310 - L	
1	Horizontal	Fundamental
<p><b>Peak</b></p>	 <p>Site : 03CH11-HY            Condition : PEAK_BE_74 3m HORN 91200-HF HORIZONTAL            RBW:1000.000KHz VBW:3000.000KHz SWT:Auto            Detector : Peak            Project : 890804-01            Setting : II</p>	 <p>Site : 03CH11-HY            Condition : PEAK(UNII) 3m HORN 91200-HF HORIZONTAL            RBW:1000.000KHz VBW:3000.000KHz SWT:Auto            Detector : Peak            Project : 890804-01            Setting : II</p>
<p><b>Avg.</b></p>	 <p>Site : 03CH11-HY            Condition : AVG_BE_54 3m HORN 91200-HF HORIZONTAL            RBW:1000.000KHz VBW:1000KHz SWT:Auto            Detector : Peak            Project : 890804-01            Setting : II</p>	<p><b>Left blank</b></p>

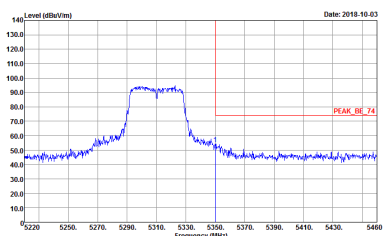
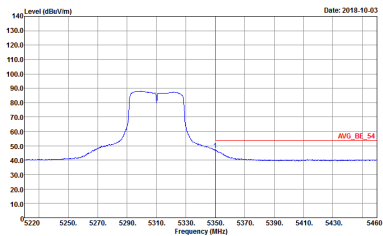

WIFI	Band 2 5250~5350MHz Band Edge @ 3m	
ANT	802.11n HT40 CH62 5310 - R	
1	Horizontal	Fundamental
<p><b>Peak</b></p>	 <p>Site : 03CH11-HY            Condition : PEAK_BE_74 3m HORN 91200-HF HORIZONTAL            RBW:1000.000KHz VBW:3000.000KHz SWF:Auto            Detector : Peak            Project : 890804-01            Setting : II</p>	<p>Left blank</p>
<p><b>Avg.</b></p>	 <p>Site : 03CH11-HY            Condition : AVG_BE_54 3m HORN 91200-HF HORIZONTAL            RBW:1000.000KHz VBW:1.000KHz SWF:Auto            Detector : Peak            Project : 890804-01            Setting : II</p>	<p>Left blank</p>



WIFI	Band 2 5250~5350MHz Band Edge @ 3m	
ANT	802.11n HT40 CH62 5310 - L	
1	Vertical	Fundamental
Peak	<p>Site : 03CH11-HY            Condition : PEAK_BE_74 3m HORN 91200-HF VERTICAL            RBW:1000.000KHz VBW:3000.000KHz SWT:Auto            Detector : Peak            Project : 890804-01            Setting : 11</p>	<p>Site : 03CH11-HY            Condition : PEAK(UNII) 3m HORN 91200-HF VERTICAL            RBW:1000.000KHz VBW:3000.000KHz SWT:Auto            Detector : Peak            Project : 890804-01            Setting : 11</p>
Avg.	<p>Site : 03CH11-HY            Condition : AVG_BE_54 3m HORN 91200-HF VERTICAL            RBW:1000.000KHz VBW:1000KHz SWT:Auto            Detector : Peak            Project : 890804-01            Setting : 11</p>	Left blank

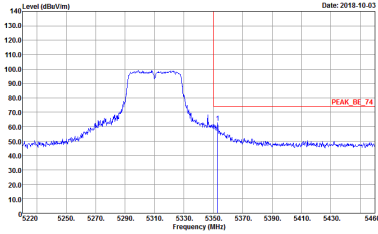
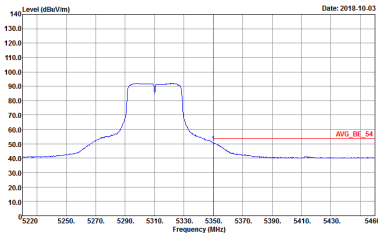

WIFI	Band 2 5250~5350MHz Band Edge @ 3m	
ANT	802.11n HT40 CH62 5310 - R	
1	Vertical	Fundamental
<p><b>Peak</b></p>	 <p>Site : 03CH11-HY            Condition : PEAK_BE_74 3m HORN 91200-HF VERTICAL            RBW:1000.000KHz VBW:3000.000KHz SWF:Auto            Detector : Peak            Project : 890804-01            Setting : II</p>	<p>Left blank</p>
<p><b>Avg.</b></p>	 <p>Site : 03CH11-HY            Condition : AVG_BE_54 3m HORN 91200-HF VERTICAL            RBW:1000.000KHz VBW:1.000KHz SWF:Auto            Detector : Peak            Project : 890804-01            Setting : II</p>	<p>Left blank</p>





**Band 2 - 5250~5350MHz**  
**WIFI 802.11a (Harmonic @ 3m)**

WIFI	Band 2 5250~5350MHz Harmonic @ 3m	
ANT	802.11a CH52 5260MHz	
1	Horizontal	Vertical
<p><b>Peak</b></p> <p><b>Avg.</b></p>	<p>Site : 03CH11-4FY            Condition : PEAK(UNEE) 3m HORN 9120D-HF HORIZONTAL            Detector : Peak            Project : 890804-01</p>	<p>Site : 03CH11-4FY            Condition : PEAK(UNEE) 3m HORN 9120D-HF VERTICAL            Detector : Peak            Project : 890804-01</p>

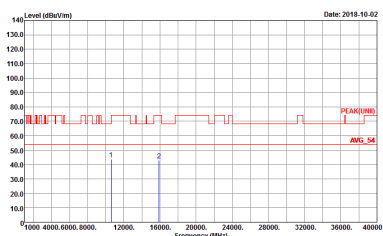
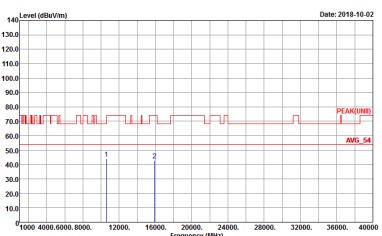

WIFI	Band 2 5250~5350MHz Harmonic @ 3m	
ANT	802.11a CH60 5300MHz	
1	Horizontal	Vertical
<p><b>Peak</b></p> <p><b>Avg.</b></p>	 <p>Site : 03CH11-HY          Condition : PEAK(UNED) 3m HORN 9120D-HF HORIZONTAL          Detector : Peak          Project : 890804-01</p>	 <p>Site : 03CH11-HY          Condition : PEAK(UNED) 3m HORN 9120D-HF VERTICAL          Detector : Peak          Project : 890804-01</p>



WIFI	Band 2 5250~5350MHz Harmonic @ 3m	
ANT	802.11a CH64 5320MHz	
1	Horizontal	Vertical
<b>Peak</b> <b>Avg.</b>	<p>Site : 03CH11-HY Condition : PEAK(UNED) 3m HORN 9120D-HF HORIZONTAL Detector : Peak Project : 890804-01</p>	<p>Site : 03CH11-HY Condition : PEAK(UNED) 3m HORN 9120D-HF VERTICAL Detector : Peak Project : 890804-01</p>



**Band 2 5250~5350MHz  
WIFI 802.11n HT20 (Harmonic @ 3m)**

<b>WIFI</b>	<b>Band 2 5250~5350MHz Harmonic @ 3m</b>	
<b>ANT</b>	<b>802.11n HT20 CH52 5260MHz</b>	
<b>1</b>	<b>Horizontal</b>	<b>Vertical</b>
<b>Peak</b> <b>Avg.</b>	<p>Site : 03CH11-HY Condition : PEAK(UNII) 3m HORN 91200-HF HORIZONTAL Detector : Peak Project : 890804-01</p>	<p>Site : 03CH11-HY Condition : PEAK(UNII) 3m HORN 91200-HF VERTICAL Detector : Peak Project : 890804-01</p>



WIFI	Band 2 5250~5350MHz Harmonic @ 3m	
ANT	802.11n HT20 CH60 5300MHz	
1	Horizontal	Vertical
<b>Peak</b> <b>Avg.</b>	<p>Site : 03CH11-HY Condition : PEAK(UNED) 3m HORN 9120D-HF HORIZONTAL Detector : Peak Project : 890804-01</p>	<p>Site : 03CH11-HY Condition : PEAK(UNED) 3m HORN 9120D-HF VERTICAL Detector : Peak Project : 890804-01</p>



WIFI	Band 2 5250~5350MHz Harmonic @ 3m	
ANT	802.11n HT20 CH64 5320MHz	
1	Horizontal	Vertical
<b>Peak</b> <b>Avg.</b>	<p>Site : 03CH11-HY Condition : PEAK(UNED) 3m HORN 9120D-HF HORIZONTAL Detector : Peak Project : 890804-01</p>	<p>Site : 03CH11-HY Condition : PEAK(UNED) 3m HORN 9120D-HF VERTICAL Detector : Peak Project : 890804-01</p>



**Band 2 5250~5350MHz  
WIFI 802.11n HT40 (Harmonic @ 3m)**

<b>WIFI</b>	<b>Band 2 5250~5350MHz Harmonic @ 3m</b>	
<b>ANT</b>	<b>802.11n HT40 CH54 5270</b>	
<b>1</b>	<b>Horizontal</b>	<b>Vertical</b>
<b>Peak</b> <b>Avg.</b>	<p>Site : 03CH11-HY Condition : PEAK(UNII) 3m HORN 91200-HF HORIZONTAL Detector : Peak Project : 890804.01</p>	<p>Site : 03CH11-HY Condition : PEAK(UNII) 3m HORN 91200-HF VERTICAL Detector : Peak Project : 890804.01</p>



WIFI	Band 2 5250~5350MHz Harmonic @ 3m	
ANT	802.11n HT40 CH62 5310	
1	Horizontal	Vertical
<b>Peak</b> <b>Avg.</b>	<p>Site : 03CH11-HY Condition : PEAK(UNED) 3m HORN 9120D-HF HORIZONTAL Detector : Peak Project : 890804-01</p>	<p>Site : 03CH11-HY Condition : PEAK(UNED) 3m HORN 9120D-HF VERTICAL Detector : Peak Project : 890804-01</p>





**Band 3 - 5470~5725MHz**  
**WIFI 802.11a (Band Edge @ 3m)**

WIFI	Band 3 5470~5725MHz Band Edge @ 3m	
ANT	802.11a CH100 5500MHz	
1	Horizontal	Fundamental
<b>Peak</b>	<p>Site : 03CH11-HY            Condition : PEAK_BE(UNIT)_B3 3m HORN 9120D-HF HORIZONTAL            Detector : Peak            Project : 890804-01</p>	<p>Site : 03CH11-HY            Condition : PEAK(UNIT) 3m HORN 9120D-HF HORIZONTAL            Detector : Peak            Project : 890804-01</p>
<b>Avg.</b>	<p>Site : 03CH11-HY            Condition : AVG_BE(UNIT)_B3 3m HORN 9120D-HF HORIZONTAL            Detector : Peak            Project : 890804-01</p>	Left blank

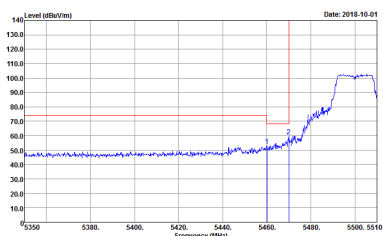
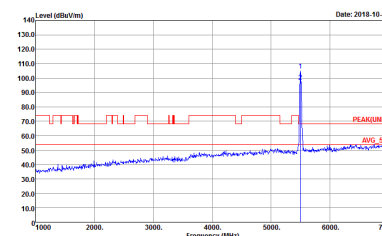
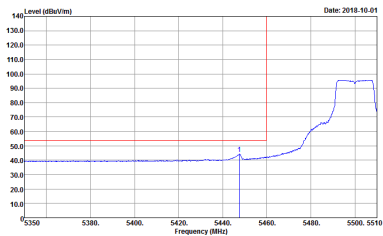

WIFI	Band 3 5470~5725MHz Band Edge @ 3m	
ANT	802.11a CH100 5500MHz	
1	Vertical	Fundamental
Peak	 <p>Site : 03CH11-HY            Condition : PEAK_BE[UNII]_B3 3m HORN 9120D-HF VERTICAL            RBW:1000.000KHz VBW:3000.000KHz SWT:Auto            Detector : Peak            Project : 890804-01</p>	 <p>Site : 03CH11-HY            Condition : PEAK[UNII] 3m HORN 9120D-HF VERTICAL            RBW:1000.000KHz VBW:3000.000KHz SWT:Auto            Detector : Peak            Project : 890804-01</p>
Avg.	 <p>Site : 03CH11-HY            Condition : AVG_BE[UNII]_B3 3m HORN 9120D-HF VERTICAL            RBW:1000.000KHz VBW:1.000KHz SWT:Auto            Detector : Peak            Project : 890804-01</p>	Left blank

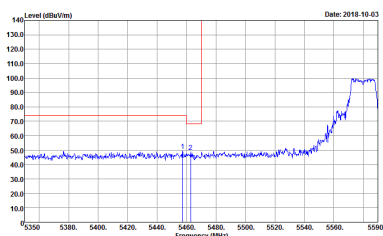
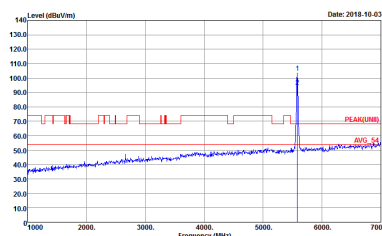
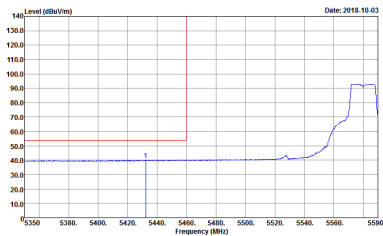

WIFI	Band 3 5470~5725MHz Band Edge @ 3m	
ANT	802.11a CH116 5580MHz - L	
1	Horizontal	Fundamental
<p><b>Peak</b></p>	 <p>Site : 03CH11-HY            Condition : PEAK_BE(UNII)_B3 3m HORN 9120D-HF HORIZONTAL            Detector : Peak            Project : 890804-01</p>	 <p>Site : 03CH11-HY            Condition : PEAK(UNII) 3m HORN 9120D-HF HORIZONTAL            Detector : Peak            Project : 890804-01</p>
<p><b>Avg.</b></p>	 <p>Site : 03CH11-HY            Condition : AVG_BE(UNII)_B3 3m HORN 9120D-HF HORIZONTAL            Detector : Peak            Project : 890804-01</p>	<p><b>Left blank</b></p>



WIFI	Band 3 5470~5725MHz Band Edge @ 3m	
ANT	802.11a CH116 5580MHz - R	
1	Horizontal	Fundamental
Peak	<p>Site : 03CH11-HY Condition : PEAK_BE[UNIT]_B3 3m HORN 91200-HF HORIZONTAL Detector : Peak Project : 890804-01</p>	Left blank

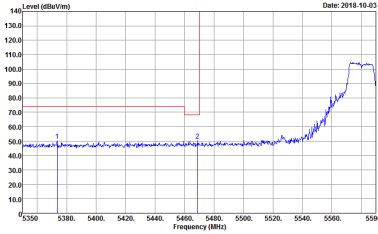
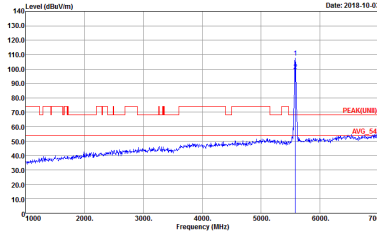
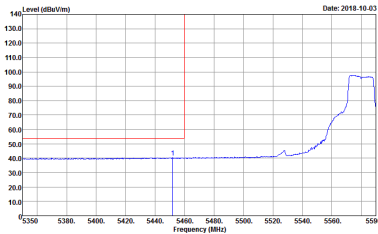

WIFI	Band 3 5470~5725MHz Band Edge @ 3m	
ANT	802.11a CH116 5580MHz - L	
1	Vertical	Fundamental
<p><b>Peak</b></p>	 <p>Site : 03CH11-HY            Condition : PEAK_BE(UNII)_B3 3m HORN 9120D-HF VERTICAL            Detector : Peak            Project : 890804-01</p>	 <p>Site : 03CH11-HY            Condition : PEAK(UNII) 3m HORN 9120D-HF VERTICAL            Detector : Peak            Project : 890804-01</p>
<p><b>Avg.</b></p>	 <p>Site : 03CH11-HY            Condition : AVG_BE(UNII)_B3 3m HORN 9120D-HF VERTICAL            Detector : Peak            Project : 890804-01</p>	<p><b>Left blank</b></p>



WIFI	Band 3 5470~5725MHz Band Edge @ 3m	
ANT	802.11a CH116 5580MHz - R	
1	Vertical	Fundamental
Peak	<p>Site : 03CH11-HY Condition : PEAK_BE[UNIT]_B3 3m HORN 91200-HF VERTICAL Detector : Peak Project : 890804-01</p>	Left blank

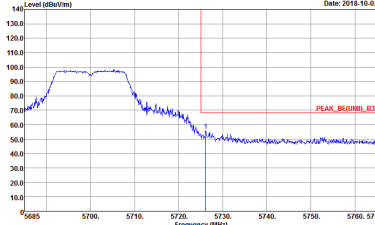
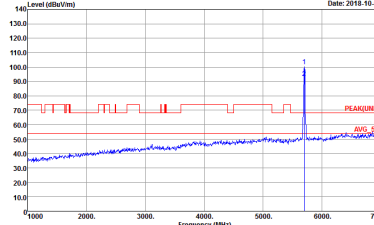

WIFI	Band 3 5470~5725MHz Band Edge @ 3m	
ANT	802.11a CH140 5700MHz	
1	Horizontal	Fundamental
<p><b>Peak</b></p>	 <p>Site : 03CH11-HY            Condition : PEAK_BE[UNII]_B3 3m HORN 91200-HF HORIZONTAL            RBW:1000.000KHz VBW:3000.000KHz SWT:Auto            Detector : Peak            Project : 890804-01</p>	 <p>Site : 03CH11-HY            Condition : PEAK[UNII] 3m HORN 91200-HF HORIZONTAL            RBW:1000.000KHz VBW:3000.000KHz SWT:Auto            Detector : Peak            Project : 890804-01</p>

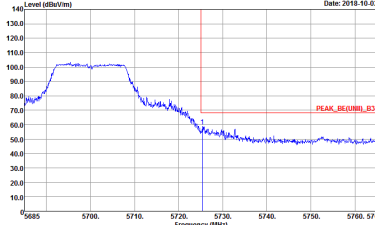
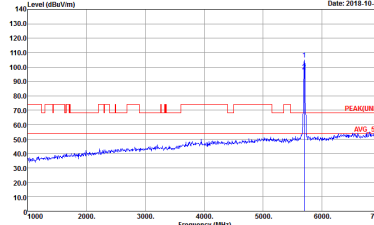

WIFI	Band 3 5470~5725MHz Band Edge @ 3m	
ANT	802.11a CH140 5700MHz	
1	Vertical	Fundamental
Peak	 <p>Site : 03CH11-HY            Condition : PEAK_BE[UNII]_B3 3m HORN 9120D-HF VERTICAL            RBW:1000.000KHz VBW:3000.000KHz SWT:Auto            Detector : Peak            Project : 890804-01</p>	 <p>Site : 03CH11-HY            Condition : PEAK[UNII] 3m HORN 9120D-HF VERTICAL            RBW:1000.000KHz VBW:3000.000KHz SWT:Auto            Detector : Peak            Project : 890804-01</p>





**Band 3 5470~5725MHz  
WIFI 802.11n HT20 (Band Edge @ 3m)**

WIFI	Band 3 5470~5725MHz Band Edge @ 3m	
ANT	802.11n HT20 CH100 5500MHz	
1	Horizontal	Fundamental
<b>Peak</b>	<p>Site : 03CH11-HY Condition : PEAK_BE(UNII)_B3 3m HORN 9120D-HF HORIZONTAL Detector : Peak Project : 890804-01</p>	<p>Site : 03CH11-HY Condition : PEAK(UNII) 3m HORN 9120D-HF HORIZONTAL Detector : Peak Project : 890804-01</p>
<b>Avg.</b>	<p>Site : 03CH11-HY Condition : AVG_BE(UNII)_B3 3m HORN 9120D-HF HORIZONTAL Detector : Peak Project : 890804-01</p>	<b>Left blank</b>

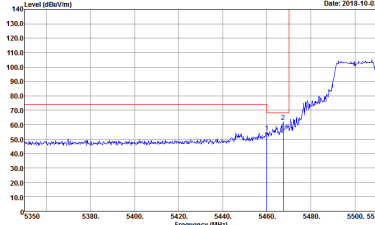
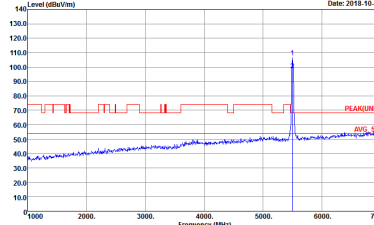
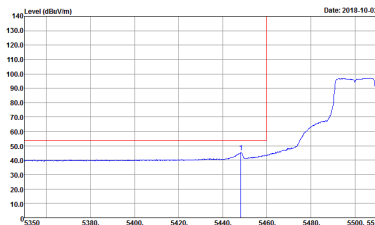

WIFI	Band 3 5470~5725MHz Band Edge @ 3m	
ANT	802.11n HT20 CH100 5500MHz	
1	Vertical	Fundamental
Peak	 <p>Site : 03CH11-HY            Condition : PEAK_BE(UNII)_B3 3m HORN 9120D-HF VERTICAL            Detector : Peak            Project : 890804-01</p>	 <p>Site : 03CH11-HY            Condition : PEAK(UNII) 3m HORN 9120D-HF VERTICAL            Detector : Peak            Project : 890804-01</p>
Avg.	 <p>Site : 03CH11-HY            Condition : AVG_BE(UNII)_B3 3m HORN 9120D-HF VERTICAL            Detector : Peak            Project : 890804-01</p>	Left blank

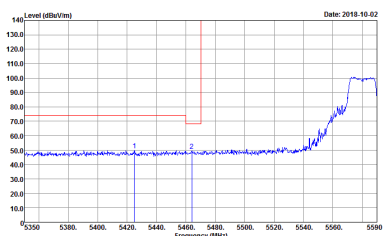
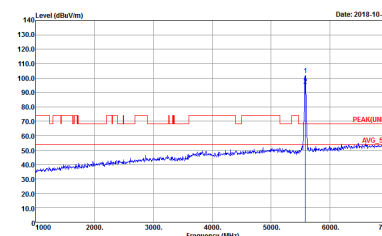
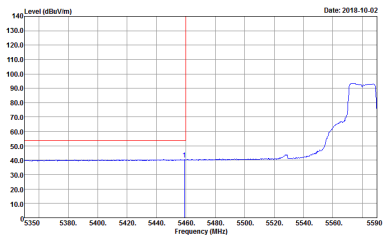

WIFI	Band 3 5470~5725MHz Band Edge @ 3m	
ANT	802.11n HT20 CH116 5580MHz - L	
1	Horizontal	Fundamental
<p><b>Peak</b></p>	 <p>Site : 03CH11-HY            Condition : PEAK_BE[UNII]_B3 3m HORN 9120D-HF HORIZONTAL            RBW:1000.000KHz VBW:3000.000KHz SWT:Auto            Detector : Peak            Project : 890804-01</p>	 <p>Site : 03CH11-HY            Condition : PEAK[UNII] 3m HORN 9120D-HF HORIZONTAL            RBW:1000.000KHz VBW:3000.000KHz SWT:Auto            Detector : Peak            Project : 890804-01</p>
<p><b>Avg.</b></p>	 <p>Site : 03CH11-HY            Condition : AVG_BE[UNII]_B3 3m HORN 9120D-HF HORIZONTAL            RBW:1000.000KHz VBW:1000KHz SWT:Auto            Detector : Peak            Project : 890804-01</p>	<p><b>Left blank</b></p>



WIFI	Band 3 5470~5725MHz Band Edge @ 3m	
ANT	802.11n HT20 CH116 5580MHz - R	
1	Horizontal	Fundamental
Peak	<p>Site : 03CH11-HY Condition : PEAK_BE(UNIT)_B3 3m HORN 91200-HF HORIZONTAL RBW:1000.000KHz VBW:3000.000KHz SWF:Auto Detector : Peak Project : 890804-01</p>	Left blank

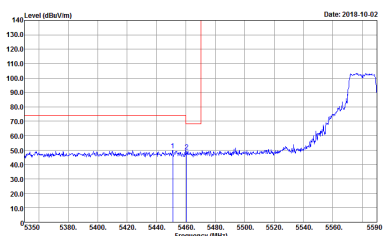
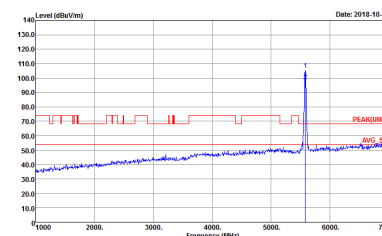
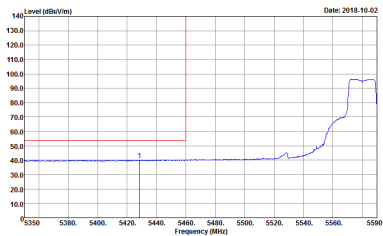

WIFI	Band 3 5470~5725MHz Band Edge @ 3m	
ANT	802.11n HT20 CH116 5580MHz - L	
1	Vertical	Fundamental
Peak	 <p>Site : 03CH11-HY            Condition : PEAK_BE(UNII)_B3 3m HORN 9120D-HF VERTICAL            RBW:1000.000KHz VBW:3000.000KHz SWT:Auto            Detector : Peak            Project : 890804-01</p>	 <p>Site : 03CH11-HY            Condition : PEAK(UNII) 3m HORN 9120D-HF VERTICAL            RBW:1000.000KHz VBW:3000.000KHz SWT:Auto            Detector : Peak            Project : 890804-01</p>
Avg.	 <p>Site : 03CH11-HY            Condition : AVG_BE(UNII)_B3 3m HORN 9120D-HF VERTICAL            RBW:1000.000KHz VBW:1000KHz SWT:Auto            Detector : Peak            Project : 890804-01</p>	Left blank



WIFI	Band 3 5470~5725MHz Band Edge @ 3m	
ANT	802.11n HT20 CH116 5580MHz - R	
1	Vertical	Fundamental
Peak	<p>Site : 03CH11-HY Condition : PEAK_BE(UNIT)_B3 3m HORN 91200-HF VERTICAL RBW:1000.000KHz VBW:3000.000KHz SWF:Auto Detector : Peak Project : 890804-01</p>	Left blank

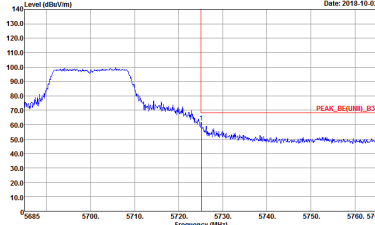
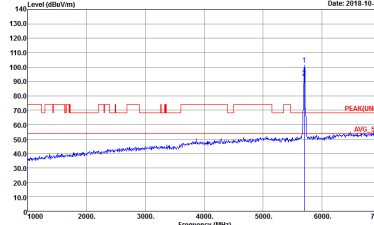

WIFI	Band 3 5470~5725MHz Band Edge @ 3m	
ANT	802.11n HT20 CH140 5700MHz	
1	Horizontal	Fundamental
<p><b>Peak</b></p>	 <p>Site : 03CH11-HY            Condition : PEAK_BE(UNII)_B3 3m HORN 91200-HF HORIZONTAL            Detector : Peak            Project : 890804-01            Setting : 13</p>	 <p>Site : 03CH11-HY            Condition : PEAK(UNII) 3m HORN 91200-HF HORIZONTAL            Detector : Peak            Project : 890804-01            Setting : 13</p>

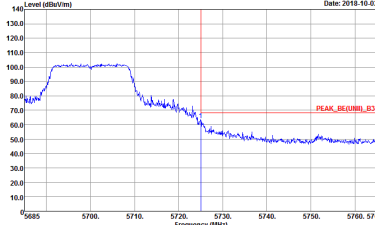
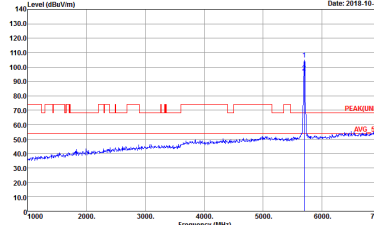

WIFI	Band 3 5470~5725MHz Band Edge @ 3m	
ANT	802.11n HT20 CH140 5700MHz	
1	Vertical	Fundamental
<p><b>Peak.</b></p>	 <p>Site : 03CH11-HY            Condition : PEAK_BE(UNII)_B3 3m HORN 91200-HF VERTICAL            RBW:1000.000KHz VBW:3000.000KHz SWT:Auto            Detector : Peak            Project : 890804-01            Setting : 13</p>	 <p>Site : 03CH11-HY            Condition : PEAK(UNII) 3m HORN 91200-HF VERTICAL            RBW:1000.000KHz VBW:3000.000KHz SWT:Auto            Detector : Peak            Project : 890804-01            Setting : 13</p>



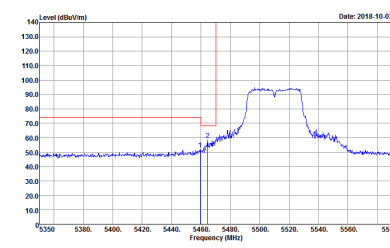
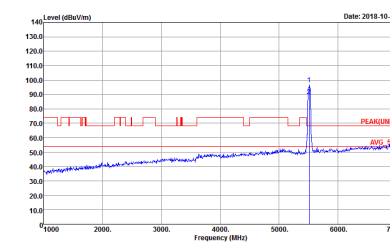
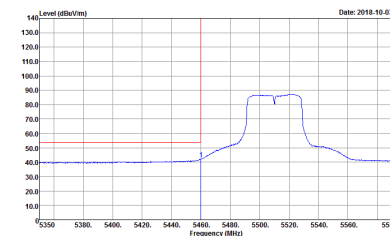

**Band 3 5470~5725MHz**  
**WIFI 802.11n HT40 (Band Edge @ 3m)**

WIFI	Band 3 5470~5725MHz Band Edge @ 3m	
ANT	802.11n HT40 CH102 5510MHz - L	
<p align="center"><b>1</b></p>	<p align="center"><b>Horizontal</b></p>  <p>Site : 03CH11-HY          Condition : PEAK_BE(UNII)_B3 3m HORN 9120D-HF HORIZONTAL          Detector : Peak          Project : 890804-01          Setting : 10.5</p>	<p align="center"><b>Fundamental</b></p>  <p>Site : 03CH11-HY          Condition : PEAK(UNII) 3m HORN 9120D-HF HORIZONTAL          Detector : Peak          Project : 890804-01          Setting : 10.5</p>
<p align="center"><b>Peak</b></p>	 <p>Site : 03CH11-HY          Condition : AVG_BE(UNII)_B3 3m HORN 9120D-HF HORIZONTAL          Detector : Peak          Project : 890804-01          Setting : 10.5</p>	<p align="center"><b>Left blank</b></p>
	<p align="center"><b>Avg.</b></p>	



WIFI	Band 3 5470~5725MHz Band Edge @ 3m	
ANT	802.11n HT40 CH102 5510MHz - R	
1	Horizontal	Fundamental
Peak	<p>Site : 03CH11-HY Condition : PEAK_BE(UNIT)_B3 3m HORN 91200-HF HORIZONTAL Defector : Peak Project : 890804-01 Setting : 10.5</p>	Left blank

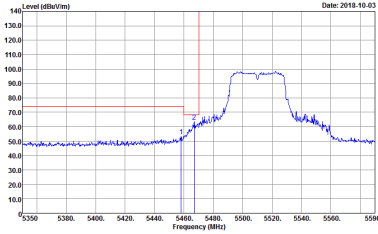
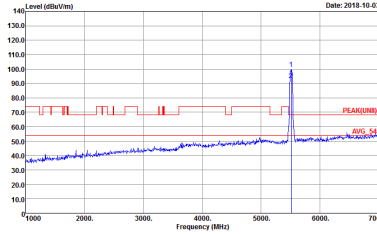
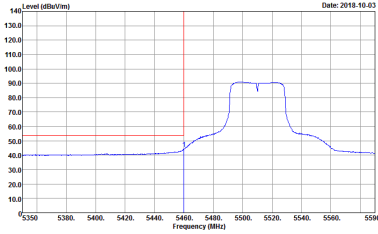

WIFI	Band 3 5470~5725MHz Band Edge @ 3m	
ANT	802.11n HT40 CH102 5510MHz - L	
1	Vertical	Fundamental
Peak	 <p>Site : 03CH11-HY            Condition : PEAK_BE[UNII]_B3 3m HORN 9120D-HF VERTICAL            RBW:1000.000KHz VBW:3000.000KHz SWT:Auto            Detector : Peak            Project : 890804-01            Setting : 10.5</p>	 <p>Site : 03CH11-HY            Condition : PEAK[UNII] 3m HORN 9120D-HF VERTICAL            RBW:1000.000KHz VBW:3000.000KHz SWT:Auto            Detector : Peak            Project : 890804-01            Setting : 10.5</p>
Avg.	 <p>Site : 03CH11-HY            Condition : AVG_BE[UNII]_B3 3m HORN 9120D-HF VERTICAL            RBW:1000.000KHz VBW:1.000KHz SWT:Auto            Detector : Peak            Project : 890804-01            Setting : 10.5</p>	Left blank



WIFI	Band 3 5470~5725MHz Band Edge @ 3m	
ANT	802.11n HT40 CH102 5510MHz - R	
1	Vertical	Fundamental
Peak	<p>Site : 03CH11-HY Condition : PEAK_BE(UNIT)_B3 3m HORN 91200-HF VERTICAL Detector : Peak Project : 890804-01 Setting : 10.5</p>	Left blank

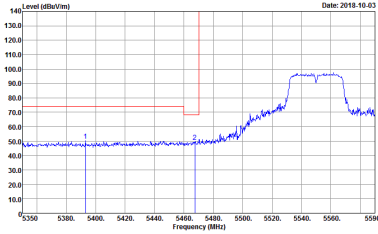
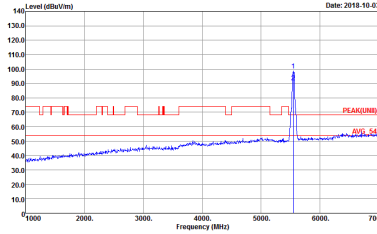
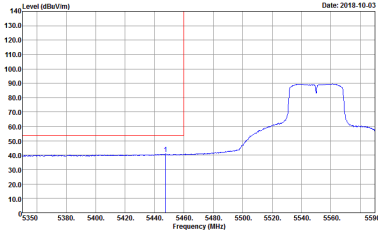

WIFI	Band 3 5470~5725MHz Band Edge @ 3m	
ANT	802.11n HT40 CH110 5550MHz - L	
1	Horizontal	Fundamental
<p><b>Peak</b></p>	 <p>Site : 03CH11-HY            Condition : PEAK_BE(UNII)_B3 3m HORN 9120D-HF HORIZONTAL            RBW:1000.000KHz VBW:3000.000KHz SWT:Auto            Detector : Peak            Project : 890804-01</p>	 <p>Site : 03CH11-HY            Condition : PEAK(UNII) 3m HORN 9120D-HF HORIZONTAL            RBW:1000.000KHz VBW:3000.000KHz SWT:Auto            Detector : Peak            Project : 890804-01</p>
<p><b>Avg.</b></p>	 <p>Site : 03CH11-HY            Condition : AVG_BE(UNII)_B3 3m HORN 9120D-HF HORIZONTAL            RBW:1000.000KHz VBW:1000KHz SWT:Auto            Detector : Peak            Project : 890804-01</p>	<p><b>Left blank</b></p>



WIFI	Band 3 5470~5725MHz Band Edge @ 3m	
ANT	802.11n HT40 CH110 5550MHz - R	
1	Horizontal	Fundamental
Peak	<p>Site : 03CH11-HY Condition : PEAK_BE(UNIT)_B3 3m HORN 91200-HF HORIZONTAL RBW:1000.000KHz VBW:3000.000KHz SWF:Auto Detector : Peak Project : 890804-01</p>	Left blank

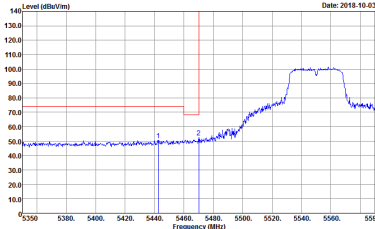
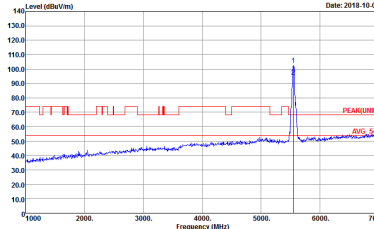
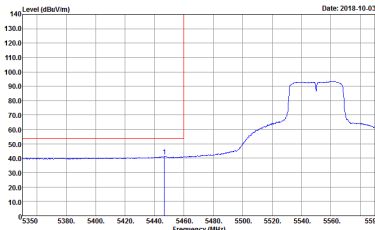

WIFI	Band 3 5470~5725MHz Band Edge @ 3m	
ANT	802.11n HT40 CH110 5550MHz - L	
1	Vertical	Fundamental
Peak	 <p>Site : 03CH11-HY            Condition : PEAK_BE(UNII)_B3 3m HORN 9120D-HF VERTICAL            RBW:1000.000KHz VBW:3000.000KHz SWT:Auto            Detector : Peak            Project : 890804-01</p>	 <p>Site : 03CH11-HY            Condition : PEAK(UNII) 3m HORN 9120D-HF VERTICAL            RBW:1000.000KHz VBW:3000.000KHz SWT:Auto            Detector : Peak            Project : 890804-01</p>
Avg.	 <p>Site : 03CH11-HY            Condition : AVG_BE(UNII)_B3 3m HORN 9120D-HF VERTICAL            RBW:1000.000KHz VBW:1.000KHz SWT:Auto            Detector : Peak            Project : 890804-01</p>	Left blank



WIFI	Band 3 5470~5725MHz Band Edge @ 3m	
ANT	802.11n HT40 CH110 5550MHz - R	
1	Vertical	Fundamental
Peak	<p>Site : 03CH11-HY Condition : PEAK_BE(UNIT)_B3 3m HORN 91200-HF VERTICAL RBW:1000.000KHz VBW:3000.000KHz SWF:Auto Detector : Peak Project : 890804-01</p>	Left blank



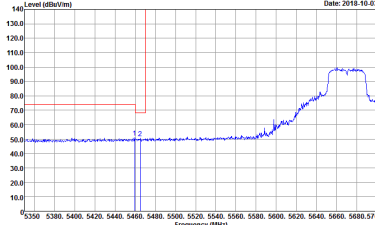
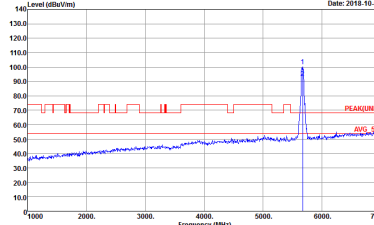
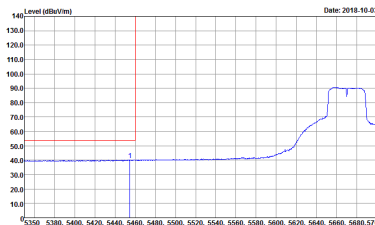

WIFI	Band 3 5470~5725MHz Band Edge @ 3m	
ANT	802.11n HT40 CH134 5670MHz - L	
1	Horizontal	Fundamental
Peak	 <p>Site : 03CH11-HY            Condition : PEAK_BE(UNII)_B3 3m HORN 9120D-HF HORIZONTAL            RBW:1000.000KHz VBW:3000.000KHz SWT:Auto            Detector : Peak            Project : 890804-01</p>	 <p>Site : 03CH11-HY            Condition : PEAK(UNII) 3m HORN 9120D-HF HORIZONTAL            RBW:1000.000KHz VBW:3000.000KHz SWT:Auto            Detector : Peak            Project : 890804-01</p>
Avg.	 <p>Site : 03CH11-HY            Condition : AVG_BE(UNII)_B3 3m HORN 9120D-HF HORIZONTAL            RBW:1000.000KHz VBW:1000KHz SWT:Auto            Detector : Peak            Project : 890804-01</p>	Left blank



WIFI	Band 3 5470~5725MHz Band Edge @ 3m	
ANT	802.11n HT40 CH134 5670MHz - R	
1	Horizontal	Fundamental
Peak	<p>Site : 03CH11-HY Condition : PEAK_BE(UNIT)_B3 3m HORN 91200-HF HORIZONTAL RBW:1000.000KHz VBW:3000.000KHz SWF:Auto Detector : Peak Project : 890804-01</p>	Left blank

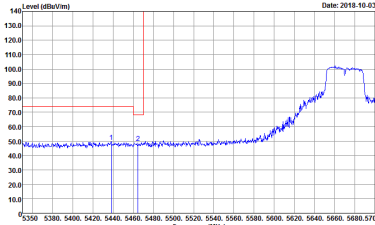
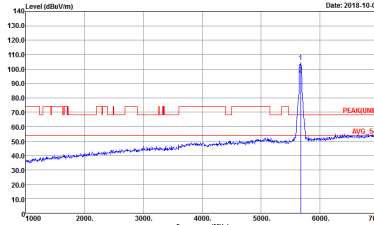
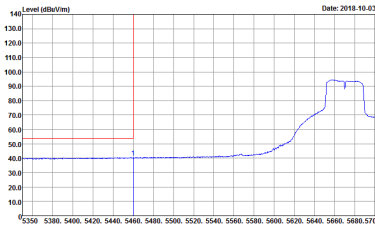

WIFI	Band 3 5470~5725MHz Band Edge @ 3m	
ANT	802.11n HT40 CH134 5670MHz - L	
1	Vertical	Fundamental
Peak	 <p>Site : 03CH11-HY            Condition : PEAK_BE[UNII]_B3 3m HORN 9120D-HF VERTICAL            RBW:1000.000KHz VBW:3000.000KHz SWT:Auto            Detector : Peak            Project : 890804-01</p>	 <p>Site : 03CH11-HY            Condition : PEAK[UNII] 3m HORN 9120D-HF VERTICAL            RBW:1000.000KHz VBW:3000.000KHz SWT:Auto            Detector : Peak            Project : 890804-01</p>
Avg.	 <p>Site : 03CH11-HY            Condition : AVG_BE[UNII]_B3 3m HORN 9120D-HF VERTICAL            RBW:1000.000KHz VBW:1000KHz SWT:Auto            Detector : Peak            Project : 890804-01</p>	Left blank



WIFI	Band 3 5470~5725MHz Band Edge @ 3m	
ANT	802.11n HT40 CH134 5670MHz - R	
1	Vertical	Fundamental
Peak	<p>Site : 03CH11-HY Condition : PEAK_BE(UNIT)_B3 3m HORN 91200-HF VERTICAL RBW:1000.000KHz VBW:3000.000KHz SWF:Auto Detector : Peak Project : 890804-01</p>	Left blank



**Band 3 - 5470~5725MHz**  
**WIFI 802.11a (Harmonic @ 3m)**

WIFI	Band 3 5470~5725MHz Harmonic @ 3m	
ANT	802.11a CH100 5500MHz	
1	Horizontal	Vertical
<p><b>Peak</b></p> <p><b>Avg.</b></p>	<p>Site : 03CH11-4FY          Condition : PEAK(UNEE) 3m HORN 9120D-HF HORIZONTAL          Detector : Peak          Project : 890804-01</p>	<p>Site : 03CH11-4FY          Condition : PEAK(UNEE) 3m HORN 9120D-HF VERTICAL          Detector : Peak          Project : 890804-01</p>



<b>WIFI</b>	<b>Band 3 5470~5725MHz Harmonic @ 3m</b>	
<b>ANT</b>	<b>802.11a CH116 5580MHz</b>	
<b>1</b>	<b>Horizontal</b>	<b>Vertical</b>
<b>Peak</b> <b>Avg.</b>	<p>Site : 03CH11-HY Condition : PEAK(UNED) 3m HORN 9120D-HF HORIZONTAL Detector : Peak Project : 890804-01</p>	<p>Site : 03CH11-HY Condition : PEAK(UNED) 3m HORN 9120D-HF VERTICAL Detector : Peak Project : 890804-01</p>



<b>WIFI</b>	<b>Band 3 5470~5725MHz Harmonic @ 3m</b>	
<b>ANT</b>	<b>802.11a CH140 5700MHz</b>	
<b>1</b>	<b>Horizontal</b>	<b>Vertical</b>
<b>Peak</b> <b>Avg.</b>	<p>Site : 03CH11-HY Condition : PEAK(UNED) 3m HORN 9120D-HF HORIZONTAL Detector : Peak Project : 890804-01</p>	<p>Site : 03CH11-HY Condition : PEAK(UNED) 3m HORN 9120D-HF VERTICAL Detector : Peak Project : 890804-01</p>



Band 3 5470~5725MHz  
WIFI 802.11n HT20 (Harmonic @ 3m)

WIFI	Band 3 5470~5725MHz Harmonic @ 3m	
ANT	802.11n HT20 CH100 5500MHz	
1	Horizontal	Vertical
Peak Avg.	<p>Site : 03CH11-HY Condition : PEAK(UNII) 3m HORN 91200-HF HORIZONTAL Detector : Peak Project : 890804.01</p>	<p>Site : 03CH11-HY Condition : PEAK(UNII) 3m HORN 91200-HF VERTICAL Detector : Peak Project : 890804.01</p>





<b>WIFI</b>	<b>Band 3 5470~5725MHz Harmonic @ 3m</b>	
<b>ANT</b>	<b>802.11n HT20 CH116 5580MHz</b>	
<b>1</b>	<b>Horizontal</b>	<b>Vertical</b>
<b>Peak</b> <b>Avg.</b>	<p>Site : 03CH11-HY Condition : PEAK(UNED) 3m HORN 9120D-HF HORIZONTAL Detector : Peak Project : 890804-01</p>	<p>Site : 03CH11-HY Condition : PEAK(UNED) 3m HORN 9120D-HF VERTICAL Detector : Peak Project : 890804-01</p>



WIFI	Band 3 5470~5725MHz Harmonic @ 3m	
ANT	802.11n HT20 CH140 5700MHz	
1	Horizontal	Vertical
<b>Peak</b> <b>Avg.</b>	<p>Site : 03CH11-HY Condition : PEAK(UNED) 3m HORN 9120D-HF HORIZONTAL Detector : Peak Project : 890804-01</p>	<p>Site : 03CH11-HY Condition : PEAK(UNED) 3m HORN 9120D-HF VERTICAL Detector : Peak Project : 890804-01</p>



**Band 3 5470~5725MHz  
WIFI 802.11n HT40 (Harmonic @ 3m)**

<b>WIFI</b>	<b>Band 3 5470~5725MHz Harmonic @ 3m</b>	
<b>ANT</b>	<b>802.11n HT40 CH102 5510MHz</b>	
<b>1</b>	<b>Horizontal</b>	<b>Vertical</b>
<b>Peak Avg.</b>	<p>Site : 03CH11-HY Condition : PEAK(UNII) 3m HORN 91200-HF HORIZONTAL Detector : Peak Project : 890804.01</p>	<p>Site : 03CH11-HY Condition : PEAK(UNII) 3m HORN 91200-HF VERTICAL Detector : Peak Project : 890804.01</p>



WIFI	Band 3 5470~5725MHz Harmonic @ 3m	
ANT	802.11n HT40 CH110 5550MHz	
1	Horizontal	Vertical
<b>Peak</b> <b>Avg.</b>	<p>Site : 03CH11-HY Condition : PEAK(UNED) 3m HORN 9120D-HF HORIZONTAL Detector : Peak Project : 890804-01</p>	<p>Site : 03CH11-HY Condition : PEAK(UNED) 3m HORN 9120D-HF VERTICAL Detector : Peak Project : 890804-01</p>

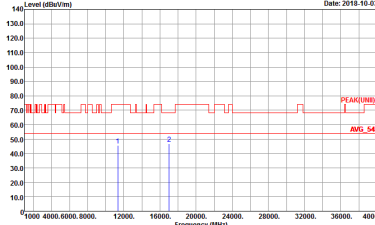
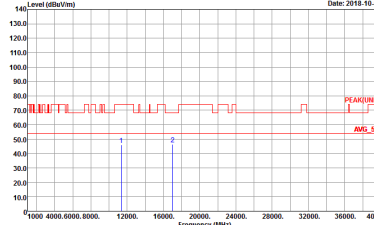

WIFI	Band 3 5470~5725MHz Harmonic @ 3m	
ANT	802.11n HT40 CH134 5670MHz	
1	Horizontal	Vertical
<p>Peak Avg.</p>	 <p>Site : 03CH11-HY Condition : PEAK(UNED) 3m HORN 9120D-HF HORIZONTAL Detector : Peak Project : 890804-01</p>	 <p>Site : 03CH11-HY Condition : PEAK(UNED) 3m HORN 9120D-HF VERTICAL Detector : Peak Project : 890804-01</p>



Emission below 1GHz  
5GHz WIFI 802.11n HT40 (LF)

WIFI	5GHz WIFI	
ANT	802.11n HT40 LF	
1	Horizontal	Vertical
QP / Peak	<p>Site : 03CH11-HY Condition : QP 3m BE-LOG 6111D-LF_ETC HORIZONTAL Detector : Peak Project : 890804-01</p>	<p>Site : 03CH11-HY Condition : QP 3m BE-LOG 6111D-LF_ETC VERTICAL Detector : Peak Project : 890804-01</p>



### Appendix E. Duty Cycle Plots

Band	Duty Cycle (%)	T(us)	1/T(kHz)	VBW Setting	Duty Factor(dB)
802.11a	87.82	1370	0.730	1kHz	0.56
5GHz 802.11n HT20	86.49	1280	0.781	1kHz	0.63
5GHz 802.11n HT40	87.13	1490	0.671	1kHz	0.60

#### 802.11a

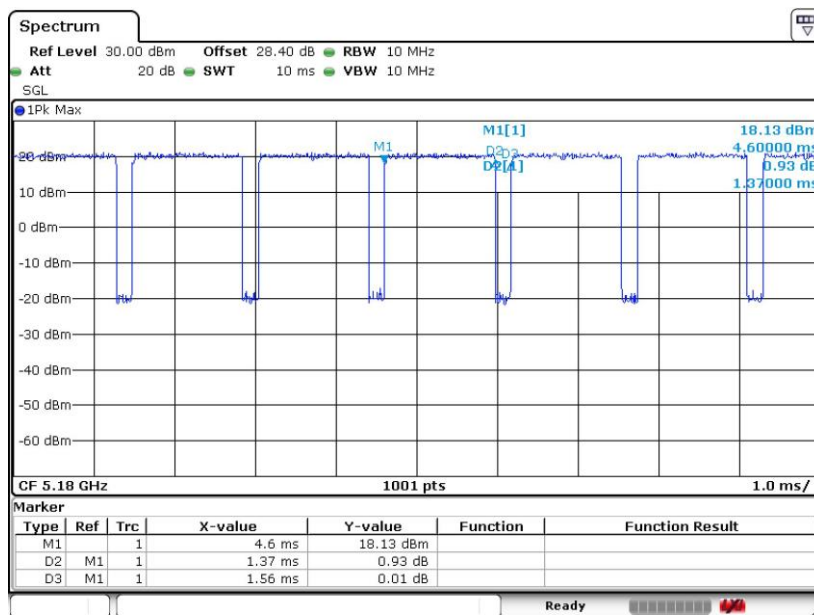

Date: 21.SEP.2018 00:17:07



802.11n HT20

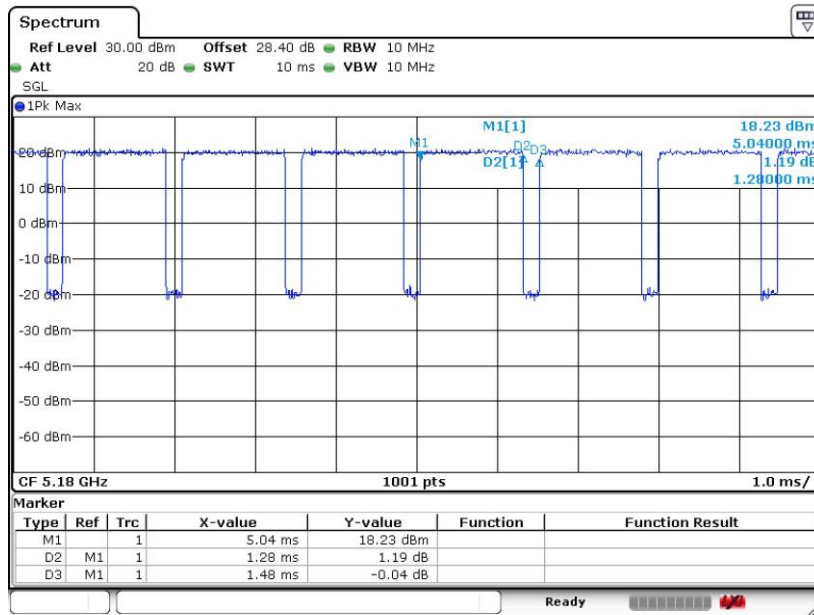

Date: 21.SEP.2018 00:18:19

802.11n HT40

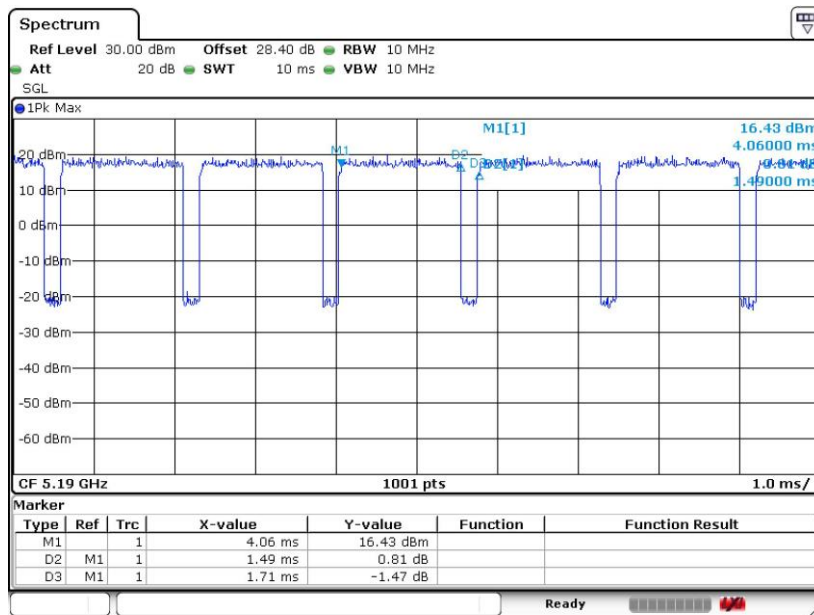

Date: 21.SEP.2018 00:20:16

—THE END—