



FCC RADIO TEST REPORT

FCC ID : IHDT56XP4
Equipment : Mobile Cellular Phone
Brand Name : Motorola
Model Name : XT1962-6
Applicant : Motorola Mobility LLC
222 W,Merchandise Mart Plaza, Chicago IL
60654 USA
Manufacturer : Motorola Mobility LLC
222 W,Merchandise Mart Plaza, Chicago IL
60654 USA
Standard : FCC Part 15 Subpart C §15.247

The product was received on Sep. 08, 2018 and testing was started from Oct. 06, 2018 and completed on Oct. 19, 2018. We, SPORTON INTERNATIONAL INC., would like to declare that the tested sample has been evaluated in accordance with the test procedures and has been in compliance with the applicable technical standards.

The report must not be used by the client to claim product certification, approval, or endorsement by TAF or any agency of government.

The test results in this variant report apply exclusively to the tested model / sample. Without written approval of SPORTON INTERNATIONAL INC. EMC & Wireless Communications Laboratory, the test report shall not be reproduced except in full.

Reviewed by: Joseph Lin

SPORTON INTERNATIONAL INC. EMC & Wireless Communications Laboratory
No. 52, Huaya 1st Rd., Guishan Dist., Taoyuan City, Taiwan (R.O.C.)



Table of Contents

History of this test report.....	3
Summary of Test Result.....	4
1 General Description.....	5
1.1 Product Feature of Equipment Under Test.....	5
1.2 Product Specification of Equipment Under Test.....	7
1.3 Modification of EUT	7
1.4 Testing Location	8
1.5 Applicable Standards.....	8
2 Test Configuration of Equipment Under Test.....	9
2.1 Carrier Frequency Channel	9
2.2 Test Mode.....	10
2.3 Connection Diagram of Test System.....	11
2.4 Support Unit used in test configuration and system.....	11
2.5 EUT Operation Test Setup	11
3 Test Result.....	12
3.1 Output Power Measurement.....	12
3.2 Radiated Band Edges and Spurious Emission Measurement	13
3.3 Antenna Requirements.....	17
4 List of Measuring Equipment	18
5 Uncertainty of Evaluation	20
Appendix A. Conducted Test Results	
Appendix B. Radiated Spurious Emission	
Appendix C. Radiated Spurious Emission Plots	
Appendix D. Duty Cycle Plots	



History of this test report

Report No.	Version	Description	Issued Date
FR890804-04A	01	Initial issue of report	Oct. 30, 2018



Summary of Test Result

Report Clause	Ref Std. Clause	Test Items	Result (PASS/FAIL)	Remark
-	15.247(a)(1)	Number of Channels	Not Required	-
-	15.247(a)(1)	Hopping Channel Separation	Not Required	-
-	15.247(a)(1)	Dwell Time of Each Channel	Not Required	-
-	15.247(a)(1)	20dB Bandwidth	Not Required	-
-	2.1049	99% Occupied Bandwidth	Reporting only	-
3.1	15.247(b)(1)	Peak Output Power	Pass	-
-	15.247(d)	Conducted Band Edges	Not Required	-
-	15.247(d)	Conducted Spurious Emission	Not Required	-
3.2	15.247(d)	Radiated Band Edges and Radiated Spurious Emission	Pass	Under limit 7.71 dB at 36.210 MHz
-	15.207	AC Conducted Emission	Not Required	-
3.3	15.203 & 15.247(b)	Antenna Requirement	Pass	-

Remark:

1. Not required means after assessing, test items are not necessary to carry out.
2. This is a variant report. All the test cases were performed on original report which can be referred to Sporton Report Number FR890804-01A.

Reviewed by: Wii Chang

Report Producer: Natasha Hsieh



1 General Description

1.1 Product Feature of Equipment Under Test

Product Feature	
Equipment	Mobile Cellular Phone
Brand Name	Motorola
Model Name	XT1962-6
FCC ID	IHDT56XP4
IMEI Code	Conducted : IMEI 1: 355579090011036 IMEI 2: 355579090011044 Radiation : IMEI 1: 355579090013313 IMEI 2: 355579090013321
EUT supports Radios application	GSM/EGPRS/WCDMA/HSPA/LTE/GNSS/FM WLAN 11b/g/n HT20 WLAN 11a/n HT20/HT40 Bluetooth BR/EDR/LE
HW Version	DVT1B
EUT Stage	Identical Prototype

Remark: The above EUT's information was declared by manufacturer.



Accessory List	
AC Adapter 1	Brand Name : Motorola
	Model Name : SC-51
	Manufacturer : Salom
AC Adapter 1	Brand Name : Motorola
	Model Name : SC-52
	Manufacturer : Salom
AC Adapter 1	Brand Name : Motorola
	Model Name : SC-53
	Manufacturer : Salom
AC Adapter 1	Brand Name : Motorola
	Model Name : SC-55
	Manufacturer : Salom
AC Adapter 1 (IN)	Brand Name : Motorola
	Model Name : SC-55
	Manufacturer : Salom
AC Adapter 1 (IN Local Build)	Brand Name : Motorola
	Model Name : SC-54
	Manufacturer : Flex
AC Adapter 2	Brand Name : Motorola
	Model Name : SC-51
	Manufacturer : Chenyang
AC Adapter 2	Brand Name : Motorola
	Model Name : SC-52
	Manufacturer : Chenyang
AC Adapter 2	Brand Name : Motorola
	Model Name : SC-53
	Manufacturer : Chenyang
AC Adapter 2	Brand Name : Motorola
	Model Name : SC-55
	Manufacturer : Chenyang
AC Adapter 2 (IN Local Build)	Brand Name : Motorola
	Model Name : SC-54
	Manufacturer : Chenyang
Battery	Brand Name : Motorola
	Model Name : JG30
	Manufacturer : Amperex
Earphone	Brand Name : Motorola
	Model Name : SH38C37773
	Manufacturer : Lyand
USB Cable 1	Brand Name : Cabletech
	Model Name : SKN6473A
USB Cable 2	Brand Name : Saibao
	Model Name : SKN6473A
USB Cable 3	Brand Name : Luxshare
	Model Name : SKN6473A



1.2 Product Specification of Equipment Under Test

Standards-related Product Specification	
Tx/Rx Frequency Range	2402 MHz ~ 2480 MHz
Number of Channels	79
Carrier Frequency of Each Channel	2402+n*1 MHz; n=0~78
Maximum Output Power to Antenna	Bluetooth BR(1Mbps) : 11.06 dBm (0.0128 W) Bluetooth EDR (2Mbps) : 11.08 dBm (0.0128 W) Bluetooth EDR (3Mbps) : 11.46 dBm (0.0140 W)
Antenna Type / Gain	Monopole Antenna type with gain 3.00 dBi
Type of Modulation	Bluetooth BR (1Mbps) : GFSK Bluetooth EDR (2Mbps) : $\pi/4$ -DQPSK Bluetooth EDR (3Mbps) : 8-DPSK

1.3 Modification of EUT

No modifications are made to the EUT during all test items.



1.4 Testing Location

Sporton Lab is accredited to ISO 17025 by Taiwan Accreditation Foundation (TAF code : 1190) and the FCC designation No. TW1190 and TW0007 under the FCC 2.948(e) by Mutual Recognition Agreement (MRA) in FCC Test.

Test Site	SPORTON INTERNATIONAL INC.
Test Site Location	No.52, Huaya 1st Rd., Guishan Dist., Taoyuan City, Taiwan (R.O.C.) TEL: +886-3-327-3456 FAX: +886-3-328-4978
Test Site No.	Sporton Site No.
	TH05-HY

Note: The test site complies with ANSI C63.4 2014 requirement.

Test Site	SPORTON INTERNATIONAL INC.
Test Site Location	No.58, Aly. 75, Ln. 564, Wenhua 3rd, Rd., Guishan Dist., Taoyuan City, Taiwan (R.O.C.) TEL: +886-3-327-0868 FAX: +886-3-327-0855
Test Site No.	Sporton Site No.
	03CH11-HY

Note: The test site complies with ANSI C63.4 2014 requirement.

1.5 Applicable Standards

According to the specifications of the manufacturer, the EUT must comply with the requirements of the following standards:

- ♦ FCC Part 15 Subpart C §15.247
- ♦ FCC KDB Publication No. 558074 D01 DTS Meas. Guidance v05
- ♦ FCC KDB 414788 D01 Radiated Test Site v01r01.
- ♦ ANSI C63.10-2013

Remark:

1. All test items were verified and recorded according to the standards and without any deviation during the test.
2. This EUT has also been tested and complied with the requirements of FCC Part 15, Subpart B, recorded in a separate test report.



2 Test Configuration of Equipment Under Test

2.1 Carrier Frequency Channel

Frequency Band	Channel	Freq. (MHz)	Channel	Freq. (MHz)	Channel	Freq. (MHz)
2400-2483.5 MHz	0	2402	27	2429	54	2456
	1	2403	28	2430	55	2457
	2	2404	29	2431	56	2458
	3	2405	30	2432	57	2459
	4	2406	31	2433	58	2460
	5	2407	32	2434	59	2461
	6	2408	33	2435	60	2462
	7	2409	34	2436	61	2463
	8	2410	35	2437	62	2464
	9	2411	36	2438	63	2465
	10	2412	37	2439	64	2466
	11	2413	38	2440	65	2467
	12	2414	39	2441	66	2468
	13	2415	40	2442	67	2469
	14	2416	41	2443	68	2470
	15	2417	42	2444	69	2471
	16	2418	43	2445	70	2472
	17	2419	44	2446	71	2473
	18	2420	45	2447	72	2474
	19	2421	46	2448	73	2475
	20	2422	47	2449	74	2476
	21	2423	48	2450	75	2477
	22	2424	49	2451	76	2478
	23	2425	50	2452	77	2479
	24	2426	51	2453	78	2480
	25	2427	52	2454	-	-
	26	2428	53	2455	-	-



2.2 Test Mode

- a. The EUT has been associated with peripherals and configuration operated in a manner tended to maximize its emission characteristics in a typical application. Frequency range investigated: radiation emission (9 kHz to the 10th harmonic of the highest fundamental frequency or to 40 GHz, whichever is lower). For radiated measurement, pre-scanned in three orthogonal panels, X, Y, Z. The worst cases (Y plane) were recorded in this report, and the worst mode of radiated spurious emissions is Bluetooth 3Mbps mode, and recorded in this report.

The following summary table is showing all test modes to demonstrate in compliance with the standard.

Summary table of Test Cases	
Test Item	Data Rate / Modulation
Radiated Test Cases	Bluetooth EDR 3Mbps 8-DPSK
	Mode 1: CH78_2480 MHz
Remark:	
1. For radiated test cases, the worst mode data rate 3Mbps was reported only since the highest RF output power in the preliminary tests.	
2. For Radiated Test Cases, the tests were performed with Adapter 1 USB Cable 1 Type C.	

2.3 Connection Diagram of Test System

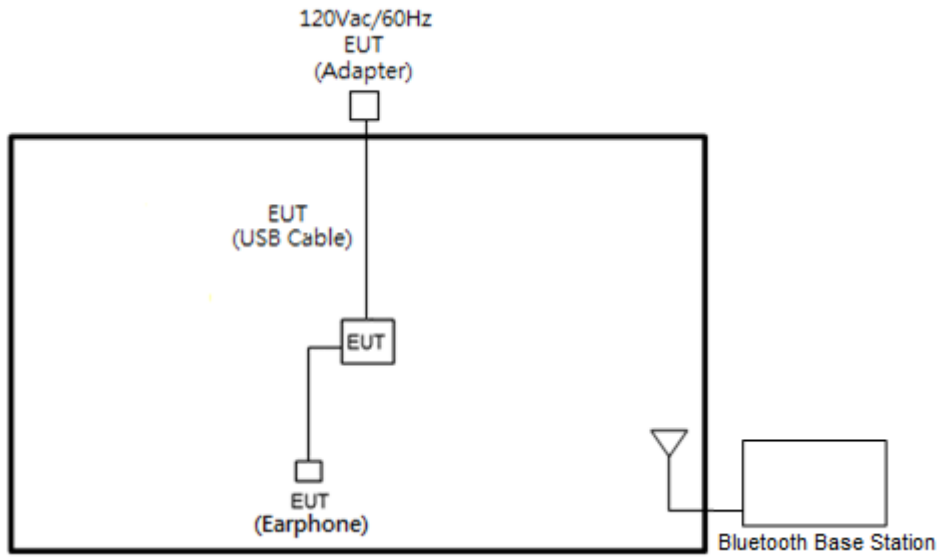

2.4 Support Unit used in test configuration and system

Item	Equipment	Trade Name	Model Name	FCC ID	Data Cable	Power Cord
1.	Bluetooth Base Station	R&S	CBT32	N/A	N/A	Unshielded, 1.8 m

2.5 EUT Operation Test Setup

The RF test items, utility “CMD” was installed in Notebook which was programmed in order to make the EUT get into the engineering modes to contact with base station to provide channel selection, power level, data rate and the application type and for continuous transmitting signals.

3 Test Result

3.1 Output Power Measurement

3.1.1 Limit of Output Power

The maximum peak conducted output power of the intentional radiator shall not exceed the following:

(1) For frequency hopping systems operating in the 2400-2483.5 MHz band employing at least 75 non-overlapping hopping channels, and all frequency hopping systems in the 5725-5850 MHz band: 1 watt. For all other frequency hopping systems in the 2400-2483.5 MHz band 0.125 watts. The power limit for 1Mbps, 2Mbps, 3Mbps and AFH modes are 0.125 watts.

3.1.2 Measuring Instruments

See list of measuring equipment of this test report.

3.1.3 Test Procedures

1. The testing follows ANSI C63.10-2013 clause 7.8.5.
1. The RF output of EUT was connected to the power meter by RF cable and attenuator. The path loss was compensated to the results for each measurement.
2. Set to the maximum power setting and enable the EUT transmit continuously.
3. Measure the conducted output power with cable loss and record the results in the test report.
4. Measure and record the results in the test report.

3.1.4 Test Setup

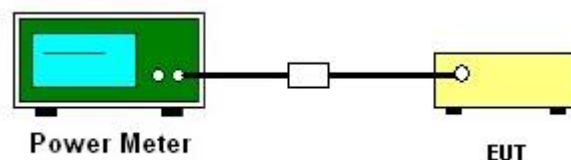

3.1.5 Test Result of Peak Output Power

Please refer to Appendix A.

3.1.6 Test Result of Average Output Power (Reporting Only)

Please refer to Appendix A.



3.2 Radiated Band Edges and Spurious Emission Measurement

3.2.1 Limit of Radiated Band Edges and Spurious Emission

In any 100 kHz bandwidth outside the intentional radiator frequency band, all harmonics/spurious must be at least 20 dB below the highest emission level within the authorized band. In addition, radiated emissions which fall in the restricted bands must also comply with the limits as below.

Frequency (MHz)	Field Strength (microvolts/meter)	Measurement Distance (meters)
0.009 – 0.490	2400/F(kHz)	300
0.490 – 1.705	24000/F(kHz)	30
1.705 – 30.0	30	30
30 – 88	100	3
88 – 216	150	3
216 - 960	200	3
Above 960	500	3

3.2.2 Measuring Instruments

See list of measuring equipment of this test report.



3.2.3 Test Procedures

1. The EUT was placed on a turntable with 0.8 meter for frequency below 1GHz and 1.5 meter for frequency above 1GHz respectively above ground.
2. The EUT was set 3 meters from the interference receiving antenna, which was mounted on the top of a variable height antenna tower.
3. For each suspected emission, the EUT was arranged to its worst case and then tune the Antenna tower (from 1 m to 4 m) and turntable (from 0 degree to 360 degrees) to find the maximum reading. A pre-amp and a high pass filter are used for the test in order to get better signal level to comply with the guidelines.
4. Set to the maximum power setting and enable the EUT transmit continuously.
5. Use the following spectrum analyzer settings:
 - (1) Span shall wide enough to fully capture the emission being measured;
 - (2) Set RBW=100 kHz for $f < 1 \text{ GHz}$, RBW=1MHz for $f > 1\text{GHz}$; VBW \geq RBW; Sweep = auto; Detector function = peak; Trace = max hold for peak
 - (3) For average measurement: use duty cycle correction factor method per 15.35(c).
Duty cycle = On time/100 milliseconds
On time = $N_1 * L_1 + N_2 * L_2 + \dots + N_{n-1} * L_{n-1} + N_n * L_n$
Where N_1 is number of type 1 pulses, L_1 is length of type 1 pulses, etc.
Average Emission Level = Peak Emission Level + $20 * \log(\text{Duty cycle})$
6. Corrected Reading: Antenna Factor + Cable Loss + Read Level - Preamp Factor = Level
7. For testing below 1GHz, if the emission level of the EUT in peak mode was 3 dB lower than the limit specified, then peak values of EUT will be reported, otherwise, the emissions will be repeated one by one using the CISPR quasi-peak method and reported.
8. For testing above 1GHz, the emission level of the EUT in peak mode was 20dB lower than average limit (that means the emission level in average mode also complies with the limit in average mode), then peak values of EUT will be reported, otherwise, the emissions will be measured in average mode again and reported.

Note: The average levels were calculated from the peak level corrected with duty cycle correction factor (-24.76dB) derived from $20 \log(\text{dwell time}/100\text{ms})$. This correction is only for signals that hop with the fundamental signal, such as band-edge and harmonic. Other spurious signals that are independent of the hopping signal would not use this correction.

3.2.4 Test Setup

For radiated emissions below 30MHz

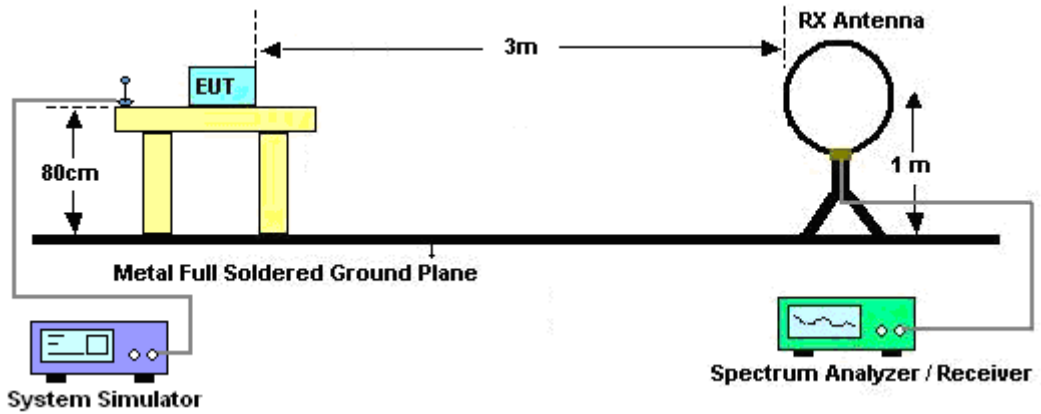

For radiated emissions from 30MHz to 1GHz

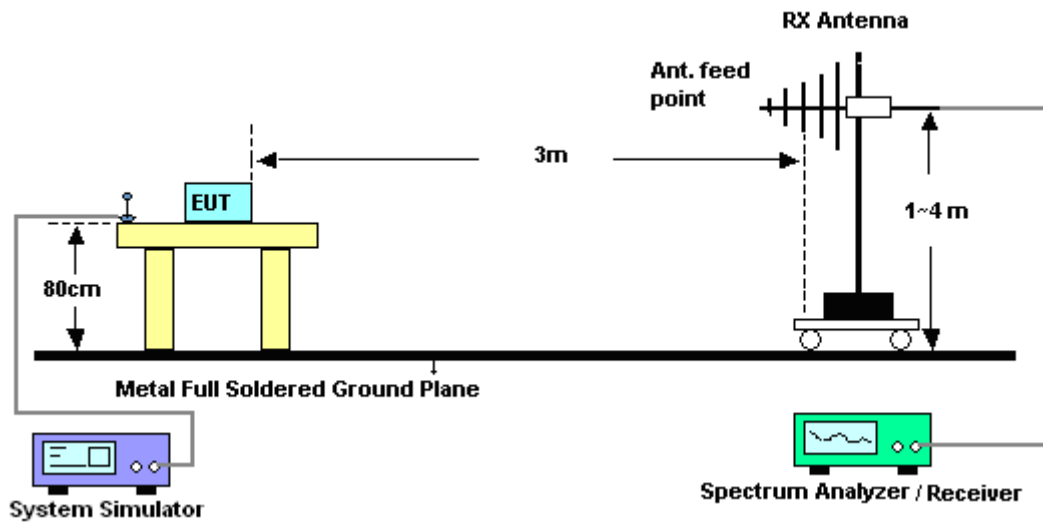

For radiated emissions above 1GHz

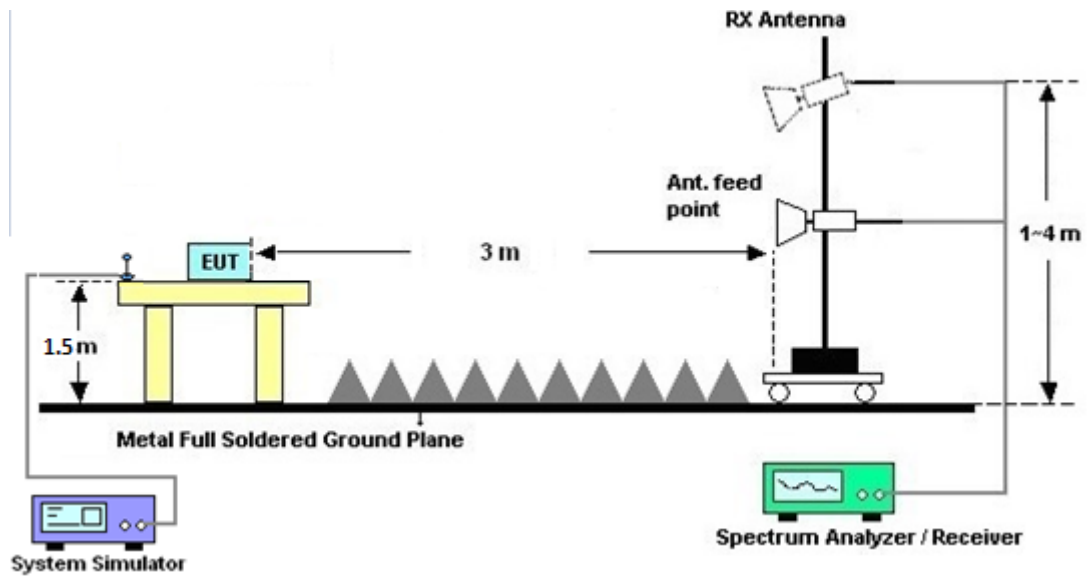

3.2.5 Test Results of Radiated Spurious Emissions (9 kHz ~ 30 MHz)

The low frequency, which started from 9 kHz to 30MHz, was pre-scanned and the result which was 20dB lower than the limit line was not reported.

There is a comparison data of both open-field test site and alternative test site - semi-Anechoic chamber according to 414788 D01 Radiated Test Site v01r01, and the result came out very similar.

3.2.6 Test Result of Radiated Spurious at Band Edges

Please refer to Appendix B and C.

3.2.7 Duty Cycle

Please refer to Appendix D.

3.2.8 Test Result of Radiated Spurious Emission (30MHz ~ 10th Harmonic)

Please refer to Appendix B and C.



3.3 Antenna Requirements

3.3.1 Standard Applicable

If directional gain of transmitting antennas is greater than 6dBi, the power shall be reduced by the same level in dB comparing to gain minus 6dBi. The use of a permanently attached antenna or of an antenna that uses a unique coupling to the intentional radiator shall be considered sufficient to comply with the rule.

3.3.2 Antenna Anti-Replacement Construction

An embedded-in antenna design is used.

3.3.3 Antenna Gain

The antenna peak gain of EUT is less than 6 dBi. Therefore, it is not necessary to reduce maximum peak output power limit.



4 List of Measuring Equipment

Instrument	Manufacturer	Model No.	Serial No.	Characteristics	Calibration Date	Test Date	Due Date	Remark
Hygrometer	Testo	DTM-303A	TP157075	N/A	Mar. 06, 2018	Oct. 19, 2018	Mar. 05, 2019	Conducted (TH05-HY)
Power Meter	Anritsu	ML2495A	1132003	N/A	Aug. 16, 2018	Oct. 19, 2018	Aug. 15, 2019	Conducted (TH05-HY)
Power Sensor	Anritsu	MA2411B	1126017	300MHz~40GHz	Aug. 16, 2018	Oct. 19, 2018	Aug. 15, 2019	Conducted (TH05-HY)
Spectrum Analyzer	Rohde & Schwarz	FSP40	100057	9kHz-40GHz	Nov. 21, 2017	Oct. 19, 2018	Nov. 20, 2018	Conducted (TH05-HY)
Switch Box & RF Cable	Burgeon	ETF-058	EC1300484	N/A	Mar. 01, 2018	Oct. 19, 2018	Feb. 28, 2019	Conducted (TH05-HY)
Loop Antenna	Rohde & Schwarz	HFH2-Z2	100488	9 kHz~30 MHz	Nov. 23, 2017	Oct. 06, 2018~ Oct. 07, 2018	Nov. 22, 2018	Radiation (03CH11-HY)
Bilog Antenna	TESEQ	CBL 6111D&N-6-06	35414&AT-N0602	30MHz~1GHz	Oct. 14, 2017	Oct. 06, 2018~ Oct. 07, 2018	Oct. 13, 2018	Radiation (03CH11-HY)
Preamplifier	Jet-Power	JPA0118-55-303K	1710001800054002	1GHz~18GHz	Apr. 17, 2018	Oct. 06, 2018~ Oct. 07, 2018	Apr. 16, 2019	Radiation (03CH11-HY)
Spectrum Analyzer	Keysight	N9010A	MY54200486	10Hz ~ 44GHz	Oct. 19, 2017	Oct. 06, 2018~ Oct. 07, 2018	Oct. 18, 2018	Radiation (03CH11-HY)
Horn Antenna	SCHWARZBECK	BBHA 9120 D	9120D-1326	1GHz ~ 18GHz	Oct. 16, 2017	Oct. 06, 2018~ Oct. 07, 2018	Oct. 15, 2018	Radiation (03CH11-HY)
Hygrometer	TECPEL	DTN-303B	TP140325	N/A	Oct. 12, 2017	Oct. 06, 2018~ Oct. 07, 2018	Oct. 11, 2018	Radiation (03CH11-HY)
Preamplifier	Keysight	83017A	MY53270080	1GHz~26.5GHz	Jan. 16, 2018	Oct. 06, 2018~ Oct. 07, 2018	Jan. 15, 2020	Radiation (03CH11-HY)
Controller	EMEC	EM 1000	N/A	Control Turn table & Ant Mast	N/A	Oct. 06, 2018~ Oct. 07, 2018	N/A	Radiation (03CH11-HY)
Antenna Mast	EMEC	AM-BS-4500-B	N/A	1~4m	N/A	Oct. 06, 2018~ Oct. 07, 2018	N/A	Radiation (03CH11-HY)
Turn Table	EMEC	TT 2000	N/A	0~360 Degree	N/A	Oct. 06, 2018~ Oct. 07, 2018	N/A	Radiation (03CH11-HY)
Amplifier	MITEQ	TTA1840-35-HG	1871923	18GHz~40GHz, VSWR : 2.5:1 max	Jul. 16, 2018	Oct. 06, 2018~ Oct. 07, 2018	Jul. 15, 2019	Radiation (03CH11-HY)
Amplifier	SONOMA	310N	187312	9kHz~1GHz	Jan. 16, 2018	Oct. 06, 2018~ Oct. 07, 2018	Jan. 15, 2019	Radiation (03CH11-HY)



Instrument	Manufacturer	Model No.	Serial No.	Characteristics	Calibration Date	Test Date	Due Date	Remark
SHF-EHF Horn Antenna	SCHWARZBECK	BBHA 9170	BBHA9170584	18GHz- 40GHz	Nov. 27, 2017	Oct. 06, 2018~ Oct. 07, 2018	Nov. 26, 2018	Radiation (03CH11-HY)
Software	Audix	E3 6.2009-8-24	RK-00104 2	N/A	N/A	Oct. 06, 2018~ Oct. 07, 2018	N/A	Radiation (03CH11-HY)
RF Cable	HUBER + SUHNER	SUCOFLEX 104	MY9837/4 PE	9kHz-30MHz	Mar. 14, 2018	Oct. 06, 2018~ Oct. 07, 2018	Mar. 13, 2019	Radiation (03CH11-HY)
RF Cable	HUBER + SUHNER	SUCOFLEX 102	MY2859/2	30MHz-40GHz	Mar. 14, 2018	Oct. 06, 2018~ Oct. 07, 2018	Mar. 13, 2019	Radiation (03CH11-HY)
RF Cable	HUBER + SUHNER	SUCOFLEX 104	MY9837/4 PE	30M-18G	Mar. 14, 2018	Oct. 06, 2018~ Oct. 07, 2018	Mar. 13, 2019	Radiation (03CH11-HY)
RF Cable	HUBER + SUHNER	SUCOFLEX 102	MY4274/2	30MHz-40GHz	Mar. 14, 2018	Oct. 06, 2018~ Oct. 07, 2018	Mar. 13, 2019	Radiation (03CH11-HY)
Filter	Wainwright	WLK4-1000-1 530-8000-40S S	SN11	1G Low Pass	Sep. 17, 2018	Oct. 06, 2018~ Oct. 07, 2018	Sep. 16, 2019	Radiation (03CH11-HY)
Filter	Wainwright	WHKX12-270 0-3000-18000 -60SS	SN3	2.7G High Pass	Sep. 17, 2018	Oct. 06, 2018~ Oct. 07, 2018	Sep. 16, 2019	Radiation (03CH11-HY)



5 Uncertainty of Evaluation

Uncertainty of Radiated Emission Measurement (30 MHz ~ 1000 MHz)

Measuring Uncertainty for a Level of Confidence of 95% ($U = 2Uc(y)$)	5.20
---	------

Uncertainty of Radiated Emission Measurement (1000 MHz ~ 18000 MHz)

Measuring Uncertainty for a Level of Confidence of 95% ($U = 2Uc(y)$)	5.50
---	------

Uncertainty of Radiated Emission Measurement (18000 MHz ~ 40000 MHz)

Measuring Uncertainty for a Level of Confidence of 95% ($U = 2Uc(y)$)	5.20
---	------

Appendix A. Test Result of Conducted Test Items

Test Engineer:	Shiang Wang	Temperature:	21~25	°C
Test Date:	2018/10/19	Relative Humidity:	51~54	%

TEST RESULTS DATA

Peak Power Table

DH	CH.	NTX	Peak Power (dBm)	Power Limit (dBm)	Test Result
DH1	0	1	9.20	20.97	Pass
	39	1	11.06	20.97	Pass
	78	1	9.97	20.97	Pass
2DH1	0	1	9.25	20.97	Pass
	39	1	11.08	20.97	Pass
	78	1	9.99	20.97	Pass
3DH1	0	1	9.59	20.97	Pass
	39	1	11.46	20.97	Pass
	78	1	10.39	20.97	Pass

TEST RESULTS DATA

Average Power Table
(Reporting Only)

DH	CH.	NTX	Average Power (dBm)	Duty Factor (dB)
DH1	0	1	9.03	5.21
	39	1	10.95	5.21
	78	1	9.84	5.21
2DH1	0	1	6.98	5.07
	39	1	8.92	5.07
	78	1	7.84	5.07
3DH1	0	1	7.03	5.12
	39	1	8.97	5.12
	78	1	7.91	5.12



Appendix B. Radiated Spurious Emission

Test Engineer :	HAO HSU and Ken Wu	Temperature :	21~26°C
		Relative Humidity :	51~56%

2.4GHz 2400~2483.5MHz

BT (Band Edge @ 3m)

BT	Note	Frequency	Level	Over	Limit	Read	Antenna	Path	Preamp	Ant	Table	Peak	Pol.	
		(MHz)	(dBμV/m)	(dB)	Limit	Level	Factor	Loss	Factor	Pos	Pos	Avg.		
					Line	(dBμV)	(dB/m)	(dB)	(dB)	(cm)	(deg)	(P/A)	(H/V)	
BT CH 78 2480MHz	*	2480	103.39	-	-	102.96	27.36	6.65	33.58	195	355	P	H	
	*	2480	78.63	-	-	-	-	-	-	-	-	A	H	
		2483.56	47.65	-26.35	74	47.21	27.36	6.66	33.58	195	355	P	H	
		2483.56	22.89	-31.11	54	-	-	-	-	-	-	A	H	
													H	
														H
	*	2480	100.24	-	-	-	99.81	27.36	6.65	33.58	199	119	P	V
	*	2480	75.48	-	-	-	-	-	-	-	-	-	A	V
		2483.56	45.49	-28.51	74	45.05	27.36	6.66	33.58	199	119	P	V	
		2483.56	20.73	-33.27	54	-	-	-	-	-	-	-	A	V
														V
														V
Remark	<ol style="list-style-type: none"> No other spurious found. All results are PASS against Peak and Average limit line. 													



2.4GHz 2400~2483.5MHz

BT (Harmonic @ 3m)

BT	Note	Frequency	Level	Over	Limit	Read	Antenna	Path	Preamp	Ant	Table	Peak	Pol.
		(MHz)	(dBμV/m)	(dB)	Line	Level	Factor	Loss	Factor	Pos	Pos	Avg.	
					(dBμV/m)	(dBμV)	(dB/m)	(dB)	(dB)	(cm)	(deg)	(P/A)	(H/V)
BT CH 78 2480MHz		4960	39.54	-34.46	74	54.26	31.54	10.25	56.51	100	0	P	H
		4960	14.78	-39.22	54	-	-	-	-	-	-	A	H
		7440	43	-31	74	50	36.59	12.47	56.06	100	0	P	H
		7440	18.24	-35.76	54	-	-	-	-	-	-	A	H
		4960	40.27	-33.73	74	54.99	31.54	10.25	56.51	100	0	P	V
		4960	15.51	-38.49	54	-	-	-	-	-	-	A	V
		7440	43.26	-30.74	74	50.26	36.59	12.47	56.06	100	0	P	V
		7440	18.5	-35.5	54	-	-	-	-	-	-	A	V
Remark	1. No other spurious found. 2. All results are PASS against Peak and Average limit line.												



Emission below 1GHz

2.4GHz BT (LF)

BT	Note	Frequency	Level	Over	Limit	Read	Antenna	Path	Preamp	Ant	Table	Peak	Pol.	
		(MHz)	(dBμV/m)	(dB)	(dBμV/m)	(dBμV)	(dB/m)	(dB)	(dB)	(cm)	(deg)	(P/A)	(H/V)	
2.4GHz BT LF		38.1	22.35	-17.65	40	33.73	20.26	0.85	32.49	-	-	P	H	
		51.6	19.2	-20.8	40	37.01	13.71	0.97	32.49	-	-	P	H	
		66.99	20.56	-19.44	40	40.1	11.83	1.12	32.49	-	-	P	H	
		759.2	30.66	-15.34	46	31.39	27.9	3.67	32.3	-	-	P	H	
		860.7	31.7	-14.3	46	30.59	29.04	3.93	31.86	-	-	P	H	
		958	33.54	-12.46	46	29.49	31.02	4.16	31.13	100	0	P	H	
													H	
													H	
													H	
													H	
													H	
													H	
													H	
													H	
			36.21	32.29	-7.71	40	42.66	21.31	0.81	32.49	100	0	P	V
			49.98	32.14	-7.86	40	49.61	14.07	0.95	32.49	-	-	P	V
			69.96	25.64	-14.36	40	44.99	11.97	1.17	32.49	-	-	P	V
			788.6	30.25	-15.75	46	30.66	28.06	3.74	32.21	-	-	P	V
			884.5	32.62	-13.38	46	31.29	29.08	3.99	31.74	-	-	P	V
			945.4	33.51	-12.49	46	30.28	30.36	4.12	31.25	-	-	P	V
													V	
													V	
													V	
													V	
													V	
													V	
Remark	1. No other spurious found. 2. All results are PASS against limit line.													



Note symbol

*	Fundamental Frequency which can be ignored. However, the level of any unwanted emissions shall not exceed the level of the fundamental frequency.
!	Test result is over limit line.
P/A	Peak or Average
H/V	Horizontal or Vertical



A calculation example for radiated spurious emission is shown as below:

BT	Note	Frequency	Level	Over	Limit	Read	Antenna	Path	Preamp	Ant	Table	Peak	Pol.
		(MHz)	(dBμV/m)	(dB)	Line	Level	Factor	Loss	Factor	Pos	Pos	Avg.	
					(dBμV/m)	(dBμV)	(dB/m)	(dB)	(dB)	(cm)	(deg)	(P/A)	(H/V)
BT		2390	55.45	-18.55	74	54.51	32.22	4.58	35.86	103	308	P	H
CH 00		2390	43.54	-10.46	54	42.6	32.22	4.58	35.86	103	308	A	H
2402MHz													

1. Path Loss(dB) = Cable loss(dB) + Filter loss(dB) + Attenuator loss(dB)
2. Level(dBμV/m) =
Antenna Factor(dB/m) + Path Loss(dB) + Read Level(dBμV) - Preamp Factor(dB)
3. Over Limit(dB) = Level(dBμV/m) – Limit Line(dBμV/m)

For Peak Limit @ 2390MHz:

1. Level(dBμV/m)
= Antenna Factor(dB/m) + Path Loss(dB) + Read Level(dBμV) - Preamp Factor(dB)
= 32.22(dB/m) + 4.58(dB) + 54.51(dBμV) – 35.86 (dB)
= 55.45 (dBμV/m)
2. Over Limit(dB)
= Level(dBμV/m) – Limit Line(dBμV/m)
= 55.45(dBμV/m) – 74(dBμV/m)
= -18.55(dB)

For Average Limit @ 2390MHz:

1. Level(dBμV/m)
= Antenna Factor(dB/m) + Path Loss(dB) + Read Level(dBμV) - Preamp Factor(dB)
= 32.22(dB/m) + 4.58(dB) + 42.6(dBμV) – 35.86 (dB)
= 43.54 (dBμV/m)
2. Over Limit(dB)
= Level(dBμV/m) – Limit Line(dBμV/m)
= 43.54(dBμV/m) – 54(dBμV/m)
= -10.46(dB)

Both peak and average measured complies with the limit line, so test result is “PASS”.



Appendix C. Radiated Spurious Emission Plots

Test Engineer :	HAO HSU and Ken Wu	Temperature :	21~26°C
		Relative Humidity :	51~56%

Note symbol

-L	Low channel location
-R	High channel location



2.4GHz 2400~2483.5MHz

BT (Band Edge @ 3m)

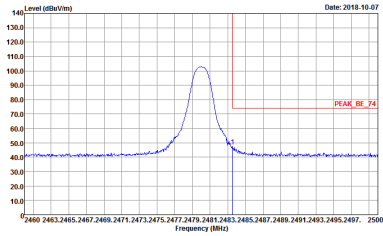
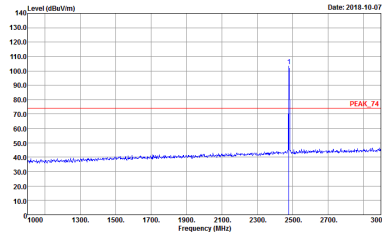
BT	2.4GHz 2400~2483.5MHz Band Edge @ 3m	
	BT CH78 2480MHz	
	Horizontal	Fundamental
Peak	 <p>Date: 2018-10-07</p> <p>PEAK_BE_74</p> <p>Site : 03CH11-HY Condition : PEAK_BE_74 3m HORN 91200-HF HORIZONTAL RBW:1000.000KHz VBW:3000.000KHz SWT:Auto Detector : Peak Project : 890804-04</p>	 <p>Date: 2018-10-07</p> <p>PEAK_74</p> <p>Site : 03CH11-HY Condition : PEAK_74 3m HORN 91200-HF HORIZONTAL RBW:1000.000KHz VBW:3000.000KHz SWT:Auto Detector : Peak Project : 890804-04</p>

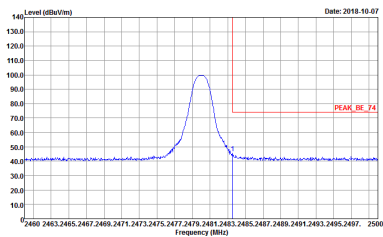
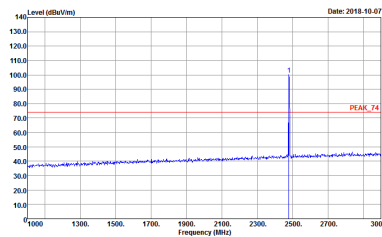

BT	2.4GHz 2400~2483.5MHz Band Edge @ 3m	
BT CH78 2480MHz		
Vertical		Fundamental
Peak	 <p>Site : 03CH11-11Y Condition : PEAK_BE_74 3m HORN 91200-HF VERTICAL : RBW:1000.000KHz VBW:3000.000KHz SWT:Auto Detector : Peak Project : 890804-04</p>	 <p>Site : 03CH11-11Y Condition : PEAK_74 3m HORN 91200-HF VERTICAL : RBW:1000.000KHz VBW:3000.000KHz SWT:Auto Detector : Peak Project : 890804-04</p>



2.4GHz 2400~2483.5MHz

BT (Harmonic @ 3m)

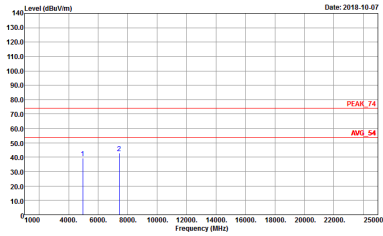
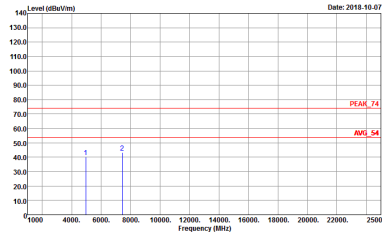
BT	2.4GHz 2400~2483.5MHz Harmonic @ 3m	
BT CH78 2480MHz		
Horizontal		Vertical
<p>Peak</p> <p>Avg.</p>	 <p>Site : 03CH11-HY Condition : PEAK_74 3m HORN 9120D-HF HORIZONTAL Detector : Peak Project : 890804-04</p>	 <p>Site : 03CH11-HY Condition : PEAK_74 3m HORN 9120D-HF VERTICAL Detector : Peak Project : 890804-04</p>



Emission below 1GHz

2.4GHz BT (LF)

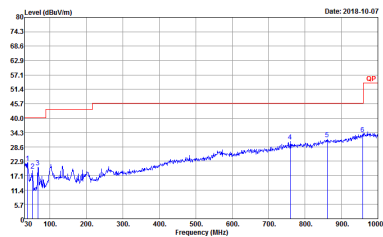
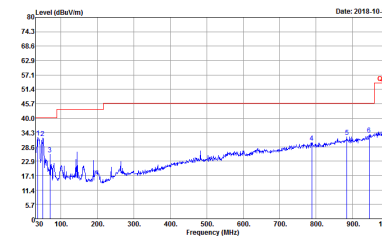
BT	2.4GHz 2400~2483.5MHz	
BT LF		
Horizontal		Vertical
QP / Peak	 <p data-bbox="430 873 686 929">Site : 03CH11-HY Condition : QP 3m BT-LOG-6111D-LF_ETC HORIZONTAL Detector : Peak Project : 890804-04</p>	 <p data-bbox="893 873 1149 929">Site : 03CH11-HY Condition : QP 3m BT-LOG-6111D-LF_ETC VERTICAL Detector : Peak Project : 890804-04</p>

Appendix D. Duty Cycle Plots

3DH5 on time (One Pulse) Plot on Channel 39

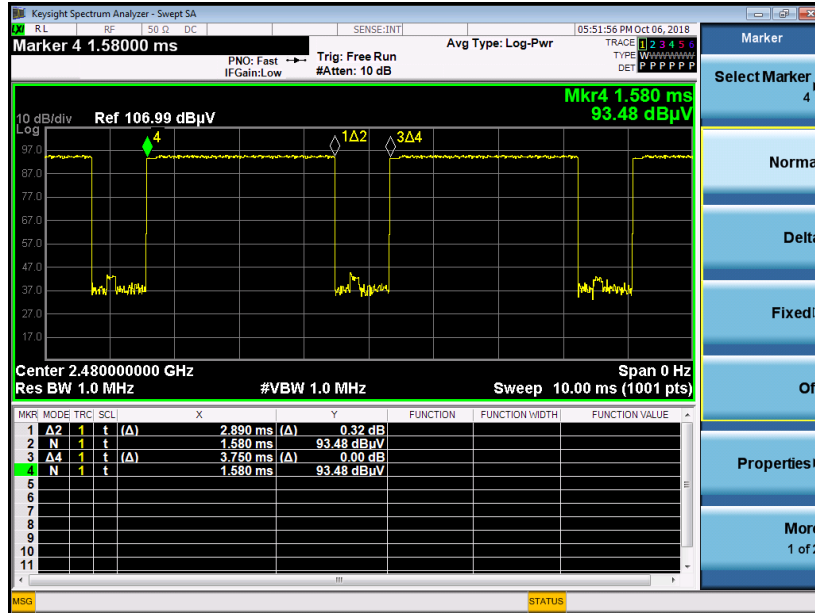

on time (Count Pulses) Plot on Channel 39

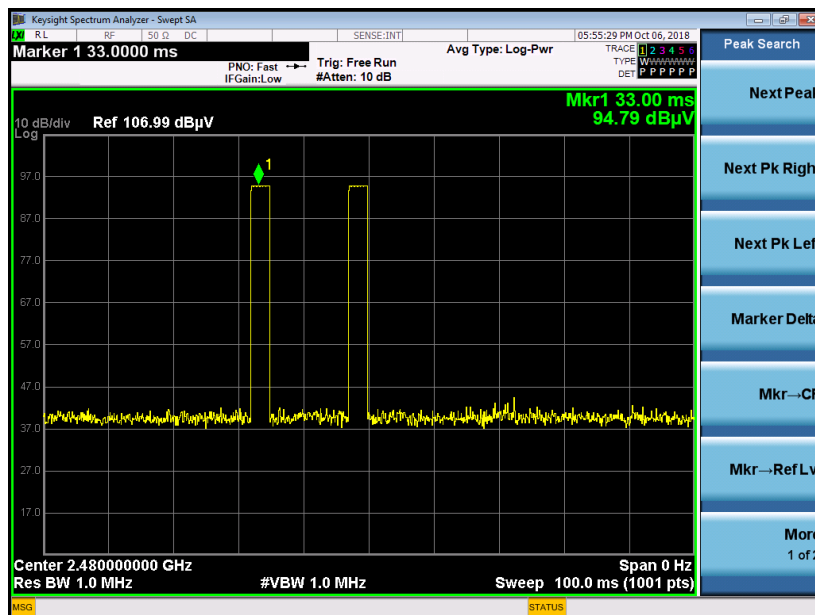

Note:

1. Worst case Duty cycle = on time/100 milliseconds = $2 * 2.89 / 100 = 5.78 \%$
2. Worst case Duty cycle correction factor = $20 * \log(\text{Duty cycle}) = -24.76 \text{ dB}$
3. **3DH5** has the highest duty cycle worst case and is reported.



Duty Cycle Correction Factor Consideration for AFH mode:

Bluetooth normal hopping rate is 1600Hz and reduced to 800Hz in AFH mode; due to the reduced number of hopping frequencies, with the same packet configuration the dwell time in each channel frequency within 100msec period is longer in AFH mode than normal mode.

In AFH mode, the minimum hopping frequencies are 20, to get the longest dwell time DH5 packet is observed; the period to have DH5 packet completing one hopping sequence is

$$2.89 \text{ ms} \times 20 \text{ channels} = 57.8 \text{ ms}$$

There cannot be 2 complete hopping sequences within 100ms period, considering the random hopping behavior, maximum 2 hops can be possibly observed within the period. $[100\text{ms} / 57.6\text{ms}] = 2$ hops

Thus, the maximum possible ON time:

$$2.89 \text{ ms} \times 2 = 5.78 \text{ ms}$$

Worst case Duty Cycle Correction factor, which is derived from the maximum possible ON time,

$$20 \times \log(5.78 \text{ ms}/100\text{ms}) = -24.76 \text{ dB}$$

—————THE END—————