



FCC RADIO TEST REPORT

FCC ID : IHDT56XP3
Equipment : Mobile Cellular Phone
Brand Name : Motorola
Model Name : XT1962-5
Applicant : Motorola Mobility LLC
222 W,Merchandise Mart Plaza, Chicago IL
60654 USA
Manufacturer : Motorola Mobility LLC
222 W,Merchandise Mart Plaza, Chicago IL
60654 USA
Standard : 47 CFR Part 2, 22(H), 24(E), 27

The product was received on Sep. 08, 2018 and testing was started from Sep. 22, 2018 and completed on Sep. 28, 2018. We, SPORTON INTERNATIONAL INC., would like to declare that the tested sample has been evaluated in accordance with the test procedures given in ANSI / TIA-603-E and has been in compliance with the applicable technical standards.

The report must not be used by the client to claim product certification, approval, or endorsement by TAF or any agency of government.

The test results in this variant report apply exclusively to the tested model / sample. Without written approval of SPORTON INTERNATIONAL INC. EMC & Wireless Communications Laboratory, the test report shall not be reproduced except in full.

Approved by: Joseph Lin

SPORTON INTERNATIONAL INC. EMC & Wireless Communications Laboratory

No. 52, Huaya 1st Rd., Guishan Dist., Taoyuan City, Taiwan (R.O.C.)



Table of Contents

History of this test report.....	3
Summary of Test Result	4
1 General Description	5
1.1 Product Feature of Equipment Under Test.....	5
1.2 Product Specification of Equipment Under Test.....	7
1.3 Modification of EUT	8
1.4 Testing Location	8
1.5 Emission Designator.....	8
1.6 Applicable Standards.....	10
2 Test Configuration of Equipment Under Test	11
2.1 Test Mode.....	11
2.2 Connection Diagram of Test System.....	13
2.3 Support Unit used in test configuration and system.....	13
2.4 Measurement Results Explanation Example.....	13
2.5 Frequency List of Low/Middle/High Channels	14
3 Conducted Test Items.....	17
3.1 Measuring Instruments	17
3.2 Conducted Output Power and ERP/EIRP	18
3.3 Peak-to-Average Ratio	19
3.4 Occupied Bandwidth.....	20
3.5 Conducted Band Edge	21
3.6 Conducted Spurious Emission	23
3.7 Frequency Stability	24
4 Radiated Test Items	25
4.1 Measuring Instruments	25
4.2 Radiated Spurious Emission	26
5 List of Measuring Equipment.....	27
6 Uncertainty of Evaluation.....	29
Appendix A. Test Results of Conducted Test	
Appendix B. Test Results of ERP/EIRP and Radiated Test	



History of this test report

Report No.	Version	Description	Issued Date
FG890804-02B	01	Initial issue of report	Oct. 31, 2018



Summary of Test Result

Report Clause	Ref Std. Clause	Test Items	Result (PASS/FAIL)	Remark
3.2	§2.1046	Conducted Output Power	Reporting only	-
	§22.913 (a)(2)	Effective Radiated Power (Band 5) (Band 26)	Pass	
	§24.232 (c) §27.50 (h)(2)	Equivalent Isotropic Radiated Power (Band 2) (Band 7) (Band 38) (Band 41)		
	§27.50 (d)(4)	Equivalent Isotropic Radiated Power (Band 4)		
3.3	§24.232 (d) §27.50 (d)(5)	Peak-to-Average Ratio	Pass	-
3.4	§2.1049	Occupied Bandwidth	Reporting only	-
3.5	§2.1051 §22.917 (a) §24.238 (a) §27.53 (h)	Conducted Band Edge Measurement (Band 2) (Band 4) (Band 5) (Band 26)	Pass	-
	§2.1051 §27.53 (m)(4)	Conducted Band Edge Measurement (Band 7) (Band 38) (Band 41)		
3.6	§2.1051 §22.917 (a) §24.238 (a) §27.53 (h)	Conducted Spurious Emission (Band 2) (Band 4) (Band 5) (Band 26)	Pass	-
	§2.1051 §27.53 (m)(4)	Conducted Spurious Emission (Band 7) (Band 38) (Band 41)		
3.7	§2.1055 §22.355 §24.235 §27.54	Frequency Stability Temperature & Voltage	Pass	-
4.2	§2.1053 §22.917 (a) §24.238 (a) §27.53 (h)	Radiated Spurious Emission (Band 2) (Band 4) (Band 5) (Band 26)	Pass	Under limit 7.04 dB at 7806.000 MHz
	§2.1053 §27.53 (m)(4)	Radiated Spurious Emission (Band 7) (Band 38) (Band 41)		
Remark: This is a variant report. All the test cases were performed on original report which can be referred to Sporton Report Number FG890804C.				

Reviewed by: Wii Chang

Report Producer: Natasha Hsieh



1 General Description

1.1 Product Feature of Equipment Under Test

Product Feature	
Equipment	Mobile Cellular Phone
Brand Name	Motorola
Model Name	XT1962-5
Sample 1	Dual SIM
Sample 2	Single SIM
FCC ID	IHDT56XP3
IMEI Code	Conducted : IMEI 1: 359505090011474 IMEI 2: 359505090011482 Radiation : IMEI 1: 359505090015756 IMEI 2: 359505090015764
EUT supports Radios application	GSM/EGPRS/WCDMA/HSPA/LTE/GNSS/NFC/FM WLAN 11b/g/n HT20 WLAN 11a/n HT20/HT40 Bluetooth BR/EDR/LE
HW Version	DVT1B
EUT Stage	Identical Prototype

Remark: The above EUT's information was declared by manufacturer.



Accessory List	
AC Adapter 1	Brand Name : Motorola
	Model Name : SC-51
	Manufacturer : Salom
AC Adapter 1	Brand Name : Motorola
	Model Name : SC-52
	Manufacturer : Salom
AC Adapter 1	Brand Name : Motorola
	Model Name : SC-55
	Manufacturer : Salom
AC Adapter 1	Brand Name : Motorola
	Model Name : SC-53
	Manufacturer : Salom
AC Adapter 2	Brand Name : Motorola
	Model Name : SC-51
	Manufacturer : Chenyang
AC Adapter 2	Brand Name : Motorola
	Model Name : SC-52
	Manufacturer : Chenyang
AC Adapter 2	Brand Name : Motorola
	Model Name : SC-55
	Manufacturer : Chenyang
AC Adapter 2	Brand Name : Motorola
	Model Name : SC-53
	Manufacturer : Chenyang
Battery	Brand Name : Motorola
	Model Name : JG30
	Manufacturer : Amperex
Earphone	Brand Name : Motorola
	Model Name : SH38C37773
	Manufacturer : Lyand
USB Cable 1	Brand Name : Cabletech
	Model Name : SKN6473A
USB Cable 2	Brand Name : Saibao
	Model Name : SKN6473A
USB Cable 3	Brand Name : Luxshare
	Model Name : SKN6473A



1.2 Product Specification of Equipment Under Test

Standards-related Product Specification	
Tx Frequency	LTE Band 2: 1850.7 MHz ~ 1909.3 MHz LTE Band 4: 1710.7 MHz ~ 1754.3 MHz LTE Band 5: 824.7 MHz ~ 848.3 MHz LTE Band 7: 2502.5 MHz ~ 2567.5 MHz LTE Band 26: 814.7 MHz ~ 848.3 MHz LTE Band 38: 2572.5 MHz ~ 2617.5 MHz LTE Band 41: 2498.5 MHz ~ 2687.5 MHz
Rx Frequency	LTE Band 2: 1930.7 MHz ~ 1989.3 MHz LTE Band 4: 2110.7 MHz ~ 2154.3 MHz LTE Band 5: 869.7 MHz ~ 893.3 MHz LTE Band 7: 2622.5 MHz ~ 2687.5 MHz LTE Band 26: 869.7 MHz ~ 893.3 MHz LTE Band 38: 2572.5 MHz ~ 2617.5 MHz LTE Band 41: 2498.5 MHz ~ 2687.5 MHz
Bandwidth	LTE Band 2: 1.4MHz / 3MHz / 5MHz / 10MHz / 15MHz / 20MHz LTE Band 4: 1.4MHz / 3MHz / 5MHz / 10MHz / 15MHz / 20MHz LTE Band 5: 1.4MHz / 3MHz / 5MHz / 10MHz LTE Band 7: 5MHz / 10MHz / 15MHz / 20MHz LTE Band 26: 1.4MHz / 3MHz / 5MHz / 10MHz / 15MHz LTE Band 38: 5MHz / 10MHz / 15MHz / 20MHz LTE Band 41: 5MHz / 10MHz / 15MHz / 20MHz
Maximum Output Power to Antenna	LTE Band 2: 22.61 dBm LTE Band 4: 22.91 dBm LTE Band 5: 23.28 dBm LTE Band 7: 23.05 dBm LTE Band 26: 23.24 dBm LTE Band 38: 23.20 dBm LTE Band 41: 23.95 dBm
Antenna Type	Fixed Internal Antenna and Dipole Antenna
Antenna Gain	<Main Antenna> LTE Band 2: 2.0 dBi LTE Band 4: 2.0 dBi LTE Band 5: 0.0 dBi LTE Band 26: 0.0 dBi <Aux. Antenna> LTE Band 7: 3.0 dBi LTE Band 38: 3.0 dBi LTE Band 41: 3.0 dBi
Type of Modulation	QPSK / 16QAM



1.3 Modification of EUT

No modifications are made to the EUT during all test items.

1.4 Testing Location

Sporton Lab is accredited to ISO 17025 by Taiwan Accreditation Foundation (TAF code : 1190) and the FCC designation No. TW1190 under the FCC 2.948(e) by Mutual Recognition Agreement (MRA) in FCC Test.

Test Site	SPORTON INTERNATIONAL INC.	
Test Site Location	No.52, Huaya 1st Rd., Guishan Dist., Taoyuan City, Taiwan (R.O.C.) TEL: +886-3-327-3456 FAX: +886-3-328-4978	
Test Site No.	Sporton Site No.	
	TH05-HY	03CH07-HY

Note: The test site complies with ANSI C63.4 2014 requirement.

1.5 Emission Designator

LTE Band 2		QPSK			16QAM		
BW (MHz)	Frequency Range (MHz)	Emission Designator (99%OBW)	Frequency Tolerance (ppm)	Maximum EIRP(W)	Emission Designator (99%OBW)	Frequency Tolerance (ppm)	Maximum EIRP(W)
1.4	1850.7 ~ 1909.3	-	-	0.2767	-	-	0.2636
3	1851.5 ~ 1908.5	-	-	0.2742	-	-	0.2673
5	1852.5 ~ 1907.5	-	-	0.2729	-	-	0.2642
10	1855.0 ~ 1905.0	-	-	0.2799	-	-	0.2582
15	1857.5 ~ 1902.5	-	-	0.2891	-	-	0.2723
20	1860.0 ~ 1900.0	-	-	0.2754	-	-	0.2624
LTE Band 4		QPSK			16QAM		
BW (MHz)	Frequency Range (MHz)	Emission Designator (99%OBW)	Frequency Tolerance (ppm)	Maximum EIRP(W)	Emission Designator (99%OBW)	Frequency Tolerance (ppm)	Maximum EIRP(W)
1.4	1710.7 ~ 1754.3	-	-	0.3027	-	-	0.2904
3	1711.5 ~ 1753.5	-	-	0.3034	-	-	0.2877
5	1712.5 ~ 1752.5	-	-	0.3041	-	-	0.2972
10	1715.0 ~ 1750.0	-	-	0.2944	-	-	0.2786
15	1717.5 ~ 1747.5	-	-	0.3027	-	-	0.3090
20	1720.0 ~ 1745.0	-	-	0.3097	-	-	0.2831



LTE Band 5		QPSK			16QAM		
BW (MHz)	Frequency Range (MHz)	Emission Designator (99%OBW)	Frequency Tolerance (ppm)	Maximum ERP(W)	Emission Designator (99%OBW)	Frequency Tolerance (ppm)	Maximum ERP(W)
1.4	824.7 ~ 848.3	-	-	0.1282	-	-	0.1086
3	825.5 ~ 847.5	-	-	0.1285	-	-	0.1097
5	826.5 ~ 846.5	-	-	0.1276	-	-	0.1091
10	829.0 ~ 844.0	-	-	0.1297	-	-	0.1005
LTE Band 7		QPSK			16QAM		
BW (MHz)	Frequency Range (MHz)	Emission Designator (99%OBW)	Frequency Tolerance (ppm)	Maximum EIRP(W)	Emission Designator (99%OBW)	Frequency Tolerance (ppm)	Maximum EIRP(W)
5	2502.5 ~ 2567.5	-	-	0.4018	-	-	0.3428
10	2505.0 ~ 2565.0	-	-	0.4027	-	-	0.3388
15	2507.5 ~ 2562.5	-	-	0.3890	-	-	0.3436
20	2510.0 ~ 2560.0	-	-	0.3899	-	-	0.3170
LTE Band 26		QPSK			16QAM		
BW (MHz)	Frequency Range (MHz)	Emission Designator (99%OBW)	Frequency Tolerance (ppm)	Maximum ERP(W)	Emission Designator (99%OBW)	Frequency Tolerance (ppm)	Maximum ERP(W)
1.4	824.7~848.3	-	-	0.1178	-	-	0.1135
3	825.5~847.5	-	-	0.1250	-	-	0.1047
5	826.5~846.5	-	-	0.1239	-	-	0.1057
10	829.0~844.0	-	-	0.1219	-	-	0.1156
15	831.5~841.5	-	-	0.1285	-	-	0.1104
LTE Band 38		QPSK			16QAM		
BW (MHz)	Frequency Range (MHz)	Emission Designator (99%OBW)	Frequency Tolerance (ppm)	Maximum EIRP(W)	Emission Designator (99%OBW)	Frequency Tolerance (ppm)	Maximum EIRP(W)
5	2572.5~2617.5	-	-	0.3936	-	-	0.3258
10	2575.0~2615.0	-	-	0.3908	-	-	0.3221
15	2577.5~2612.5	-	-	0.4169	-	-	0.3289
20	2580.0~2610.0	-	-	0.3936	-	-	0.3327
LTE Band 41		QPSK			16QAM		
BW (MHz)	Frequency Range (MHz)	Emission Designator (99%OBW)	Frequency Tolerance (ppm)	Maximum EIRP(W)	Emission Designator (99%OBW)	Frequency Tolerance (ppm)	Maximum EIRP(W)
5	2498.5~2687.5	4M50G7D	-	0.4624	4M50W7D	-	0.3006
10	2501.0~2685.0	9M07G7D	0.0014	0.4764	9M09W7D	-	0.2992
15	2503.5~2682.5	13M5G7D	-	0.4898	13M5W7D	-	0.3373
20	2506.0~2680.0	18M4G7D	-	04955	18M3W7D	-	0.3311



1.6 Applicable Standards

According to the specifications of the manufacturer, the EUT must comply with the requirements of the following standards:

- ♦ ANSI C63.26-2015
- ♦ ANSI / TIA-603-E
- ♦ 47 CFR Part 2, 22(H), 24(E), 27
- ♦ FCC KDB 971168 D01 Power Meas. License Digital Systems v03r01
- ♦ FCC KDB 412172 D01 Determining ERP and EIRP v01r01

Remark:

1. All test items were verified and recorded according to the standards and without any deviation during the test.
2. This EUT has also been tested and complied with the requirements of FCC Part 15, Subpart B, recorded in a separate test report.



2 Test Configuration of Equipment Under Test

2.1 Test Mode

Antenna port conducted and radiated test items listed below are performed according to KDB 971168 D01 Power Meas. License Digital Systems v03r01 with maximum output power.

For radiated measurement, pre-scanned in three orthogonal panels, X, Y, Z. The worst cases (X plane for Band 26 and 41, Z plan for Band 2, 4, 5, 7, 26, 38, and 41) were recorded in this report.

Test Items	Band	Bandwidth (MHz)						Modulation			RB #			Test Channel		
		1.4	3	5	10	15	20	QPSK	16QAM	64QAM	1	Half	Full	L	M	H
Max. Output Power	2	v	v	v	v	v	v	v	v	v	v	v	v	v	v	v
	4	v	v	v	v	v	v	v	v	v	v	v	v	v	v	v
	5	v	v	v	v	-	-	v	v	v	v	v	v	v	v	v
	7	-	-	v	v	v	v	v	v	v	v	v	v	v	v	v
	26	v	v	v	v	v	-	v	v	v	v	v	v	v	v	v
	38	-	-	v	v	v	v	v	v	v	v	v	v	v	v	v
	41	-	-	v	v	v	v	v	v	v	v	v	v	v	v	v
Peak-to-Average Ratio	41	-	-				v	v	v	v	v		v	v	v	
26dB and 99% Bandwidth	41	-	-	v	v	v	v	v	v	v			v	v	v	
Conducted Band Edge	41	-	-	v	v	v	v	v	v	v	v		v		v	
Conducted Spurious Emission	41	-	-	v	v	v	v	v	v	v	v			v	v	
Frequency Stability	41	-	-		v			v					v		v	



Test Items	Band	Bandwidth (MHz)						Modulation			RB #			Test Channel		
		1.4	3	5	10	15	20	QPSK	16QAM	64QAM	1	Half	Full	L	M	H
E.R.P / E.I.R.P	2	v	v	v	v	v	v	v	v	v	v			v	v	v
	4	v	v	v	v	v	v	v	v	v	v			v	v	v
	5	v	v	v	v	-	-	v	v	v	v			v	v	v
	7	-	-	v	v	v	v	v	v	v	v			v	v	v
	26	v	v	v	v	v	-	v	v	v	v			v	v	v
	38	-	-	v	v	v	v	v	v	v	v			v	v	v
	41	-	-	v	v	v	v	v	v	v	v			v	v	v
Radiated Spurious Emission	2	Worst Case											v	v	v	
	4	Worst Case											v	v	v	
	5	Worst Case											v	v	v	
	7	Worst Case											v	v	v	
	26	Worst Case											v	v	v	
	38	Worst Case											v	v	v	
	41	Worst Case											v	v	v	
Remark	<ol style="list-style-type: none"> The mark "v" means that this configuration is chosen for testing The mark "-" means that this bandwidth is not supported. The device is investigated from 30MHz to 10 times of fundamental signal for radiated spurious emission test under different RB size/offset and modulations in exploratory test. Subsequently, only the worst case emissions are reported. All the radiated test cases were performed with Adapter 1, USB Cable 1 Type C and Sample 1. 															

2.2 Connection Diagram of Test System

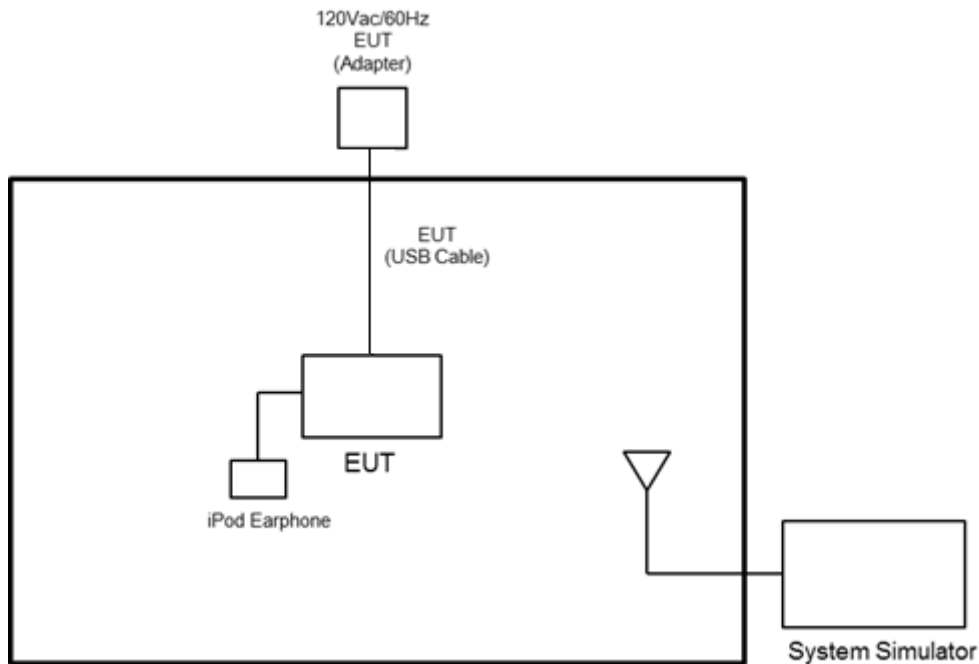

2.3 Support Unit used in test configuration and system

Item	Equipment	Trade Name	Model No.	FCC ID	Data Cable	Power Cord
1.	LTE Base Station	Anritsu	MT8820C	N/A	N/A	Unshielded, 1.8 m
2.	System Simulator	R&S	CMU 200	N/A	N/A	Unshielded, 1.8 m

2.4 Measurement Results Explanation Example

For all conducted test items:

The offset level is set in the spectrum analyzer to compensate the RF cable loss and attenuator factor between EUT conducted output port and spectrum analyzer. With the offset compensation, the spectrum analyzer reading level is exactly the EUT RF output level.

The spectrum analyzer offset is derived from RF cable loss and attenuator factor.

Offset = RF cable loss + attenuator factor.

Following shows an offset computation example with cable loss 4.2 dB and 10dB attenuator.

Example :

$$\begin{aligned} \text{Offset(dB)} &= \text{RF cable loss(dB)} + \text{attenuator factor(dB)} \\ &= 4.2 + 10 = 14.2 \text{ (dB)} \end{aligned}$$



2.5 Frequency List of Low/Middle/High Channels

LTE Band 2 Channel and Frequency List				
BW [MHz]	Channel/Frequency(MHz)	Lowest	Middle	Highest
20	Channel	18700	18900	19100
	Frequency	1860	1880	1900
15	Channel	18675	18900	19125
	Frequency	1857.5	1880	1902.5
10	Channel	18650	18900	19150
	Frequency	1855	1880	1905
5	Channel	18625	18900	19175
	Frequency	1852.5	1880	1907.5
3	Channel	18615	18900	19185
	Frequency	1851.5	1880	1908.5
1.4	Channel	18607	18900	19193
	Frequency	1850.7	1880	1909.3

LTE Band 4 Channel and Frequency List				
BW [MHz]	Channel/Frequency(MHz)	Lowest	Middle	Highest
20	Channel	20050	20175	20300
	Frequency	1720	1732.5	1745
15	Channel	20025	20175	20325
	Frequency	1717.5	1732.5	1747.5
10	Channel	20000	20175	20350
	Frequency	1715	1732.5	1750
5	Channel	19975	20175	20375
	Frequency	1712.5	1732.5	1752.5
3	Channel	19965	20175	20385
	Frequency	1711.5	1732.5	1753.5
1.4	Channel	19957	20175	20393
	Frequency	1710.7	1732.5	1754.3



LTE Band 5 Channel and Frequency List				
BW [MHz]	Channel/Frequency(MHz)	Lowest	Middle	Highest
10	Channel	20450	20525	20600
	Frequency	829	836.5	844
5	Channel	20425	20525	20625
	Frequency	826.5	836.5	846.5
3	Channel	20415	20525	20635
	Frequency	825.5	836.5	847.5
1.4	Channel	20407	20525	20643
	Frequency	824.7	836.5	848.3

LTE Band 7 Channel and Frequency List				
BW [MHz]	Channel/Frequency(MHz)	Lowest	Middle	Highest
20	Channel	20850	21100	21350
	Frequency	2510	2535	2560
15	Channel	20825	21100	21375
	Frequency	2507.5	2535	2562.5
10	Channel	20800	21100	21400
	Frequency	2505	2535	2565
5	Channel	20775	21100	21425
	Frequency	2502.5	2535	2567.5



LTE Band 26 Channel and Frequency List				
BW [MHz]	Channel/Frequency(MHz)	Lowest	Middle	Highest
15	Channel	26865	26915	26965
	Frequency	831.5	836.5	841.5
10	Channel	26840	26915	26990
	Frequency	829.0	836.5	844.0
5	Channel	26815	26915	27015
	Frequency	826.5	836.5	846.5
3	Channel	26805	26915	27025
	Frequency	825.5	836.5	847.5
1.4	Channel	26797	26915	27033
	Frequency	824.7	836.5	848.3

LTE Band 38 Channel and Frequency List				
BW [MHz]	Channel/Frequency(MHz)	Lowest	Middle	Highest
20	Channel	37850	38000	38150
	Frequency	2580.0	2595.0	2610.0
15	Channel	37825	38000	38175
	Frequency	2577.5	2595.0	2612.5
10	Channel	37800	38000	38200
	Frequency	2575.0	2595.0	2615.0
5	Channel	37775	38000	38225
	Frequency	2572.5	2595.0	2617.5

LTE Band 41 2535MHz ~ 2655MHz Channel and Frequency List				
BW [MHz]	Channel/Frequency(MHz)	Lowest	Middle	Highest
20	Channel	40140	40640	41140
	Frequency	2545.0	2595.0	2645.0
15	Channel	40115	40640	41165
	Frequency	2542.5	2595.0	2647.5
10	Channel	40090	40640	41190
	Frequency	2540.0	2595.0	2650.0
5	Channel	40065	40640	41215
	Frequency	2537.5	2595.0	2652.5

3 Conducted Test Items

3.1 Measuring Instruments

See list of measuring instruments of this test report.

3.1.1 Test Setup

3.1.2 Conducted Output Power

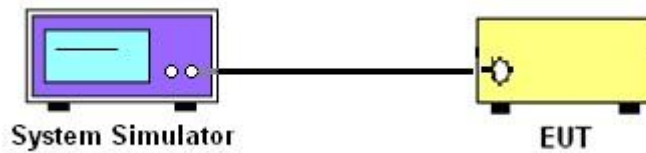

3.1.3 Peak-to-Average Ratio, Occupied Bandwidth ,Conducted Band-Edge and Conducted Spurious Emission

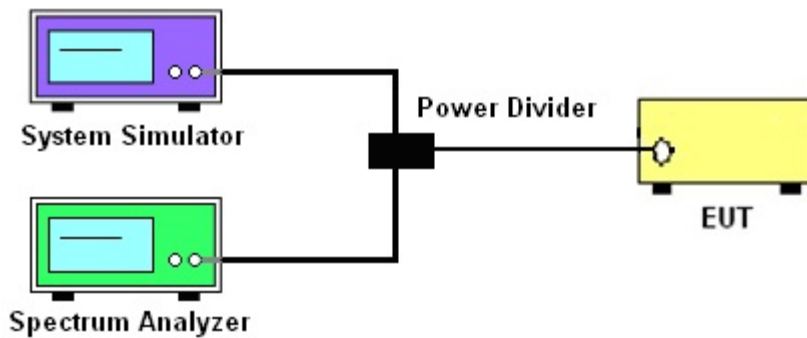

3.1.4 Frequency Stability

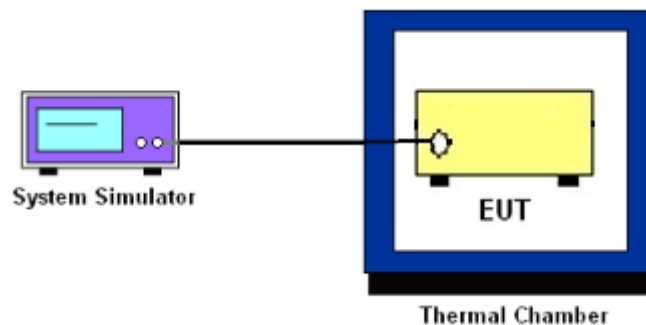

3.1.5 Test Result of Conducted Test

Please refer to Appendix A.



3.2 Conducted Output Power and ERP/EIRP

3.2.1 Description of the Conducted Output Power Measurement and ERP/EIRP Measurement

A system simulator was used to establish communication with the EUT. Its parameters were set to force the EUT transmitting at maximum output power. The measured power in the radio frequency on the transmitter output terminals shall be reported.

The ERP of mobile transmitters must not exceed 7 Watts for LTE Band 5 and Band 26.

The EIRP of mobile transmitters must not exceed 2 Watts for LTE Band 2 and Band 7 and Band 38 and Band 41.

The EIRP of mobile transmitters must not exceed 1 Watts for LTE Band 4.

According to KDB 412172 D01 Power Approach,

$EIRP = P_T + G_T - L_C$, $ERP = EIRP - 2.15$, where

P_T = transmitter output power in dBm

G_T = gain of the transmitting antenna in dBi

L_C = signal attenuation in the connecting cable between the transmitter and antenna in dB

3.2.2 Test Procedures

1. The transmitter output port was connected to the system simulator.
2. Set EUT at maximum power through the system simulator.
3. Select lowest, middle, and highest channels for each band and different modulation.
4. Measure and record the power level from the system simulator.



3.3 Peak-to-Average Ratio

3.3.1 Description of the PAR Measurement

Power Complementary Cumulative Distribution Function (CCDF) curves provide a means for characterizing the power peaks of a digitally modulated signal on a statistical basis. A CCDF curve depicts the probability of the peak signal amplitude exceeding the average power level. Most contemporary measurement instrumentation include the capability to produce CCDF curves for an input signal provided that the instrument's resolution bandwidth can be set wide enough to accommodate the entire input signal bandwidth. In measuring transmissions in this band using an average power technique, the peak-to-average ratio (PAR) of the transmission may not exceed 13 dB.

3.3.2 Test Procedures

The testing follows FCC KDB 971168 D01 v03r01 Section 5.7.1

1. The EUT was connected to spectrum and system simulator via a power divider.
2. Set the CCDF (Complementary Cumulative Distribution Function) option in spectrum analyzer.
3. The highest RF powers were measured and recorded the maximum PAPR level associated with a probability of 0.1 %.
4. Record the deviation as Peak to Average Ratio.



3.4 Occupied Bandwidth

3.4.1 Description of Occupied Bandwidth Measurement

The occupied bandwidth is the width of a frequency band such that, below the lower and above the upper frequency limits, the mean powers emitted are each equal to a specified percentage 0.5% of the total mean transmitted power.

The 26 dB emission bandwidth is defined as the frequency range between two points, one above and one below the carrier frequency, at which the spectral density of the emission is attenuated 26 dB below the maximum in-band spectral density of the modulated signal. Spectral density (power per unit bandwidth) is to be measured with a detector of resolution bandwidth equal to approximately 1.0% of the emission bandwidth.

3.4.2 Test Procedures

The testing follows FCC KDB 971168 D01 v03r01 Section 4.2

1. The EUT was connected to spectrum analyzer and system simulator via a power divider.
2. The spectrum analyzer center frequency is set to the nominal EUT channel center frequency. The span range for the spectrum analyzer shall be between two and five times the anticipated OBW.
3. The nominal resolution bandwidth (RBW) shall be in the range of 1 to 5 % of the anticipated OBW, and the VBW shall be at least 3 times the RBW.
4. Set the detection mode to peak, and the trace mode to max hold.
5. Determine the reference value: Set the EUT to transmit a modulated signal. Allow the trace to stabilize. Set the spectrum analyzer marker to the highest level of the displayed trace.
(this is the reference value)
6. Determine the “-26 dB down amplitude” as equal to (Reference Value – X).
7. Place two markers, one at the lowest and the other at the highest frequency of the envelope of the spectral display such that each marker is at or slightly below the “-X dB down amplitude” determined in step 6. If a marker is below this “-X dB down amplitude” value it shall be placed as close as possible to this value. The OBW is the positive frequency difference between the two markers.
8. Use the 99 % power bandwidth function of the spectrum analyzer and report the measured bandwidth.



3.5 Conducted Band Edge

3.5.1 Description of Conducted Band Edge Measurement

22.917(a)

For operations in the 824 – 849 MHz band, the FCC limit is $43 + 10\log_{10}(P[\text{Watts}])$ dB below the transmitter power $P(\text{Watts})$ in a 100kHz bandwidth. However, in the 1MHz bands immediately outside and adjacent to the licensee's frequency block, a resolution bandwidth of at least one percent of the emission bandwidth of the fundamental emission of the transmitter may be employed.

24.238 (a)

For operations in the 1850-1910 and 1930-1990 MHz band, the FCC limit is $43 + 10\log_{10}(P[\text{Watts}])$ dB below the transmitter power $P(\text{Watts})$ in a 1MHz bandwidth. However, in the 1 MHz bands immediately outside and adjacent to the frequency block a resolution bandwidth of at least one percent of the emission bandwidth of the fundamental emission of the transmitter may be employed.

27.53 (h)

For operations in the 1710 – 1755 MHz band, the FCC limit is $43 + 10\log_{10}(P[\text{Watts}])$ dB below the transmitter power $P(\text{Watts})$ in a 1 MHz bandwidth. However, in the 1MHz bands immediately outside and adjacent to the licensee's frequency block, a resolution bandwidth of at least one percent of the emission bandwidth of the fundamental emission of the transmitter may be employed.

27.53(m)(4)

For mobile digital stations, the attenuation factor shall be not less than $40 + 10 \log (P)$ dB on all frequencies between the channel edge and 5 megahertz from the channel edge, $43 + 10 \log (P)$ dB on all frequencies between 5 megahertz and X megahertz from the channel edge, and $55 + 10 \log (P)$ dB on all frequencies more than X megahertz from the channel edge, where X is the greater of 6 megahertz or the actual emission bandwidth as defined in paragraph (m)(6) of this section. In addition, the attenuation factor shall not be less that $43 + 10 \log (P)$ dB on all frequencies between 2490.5 MHz and 2496 MHz and $55 + 10 \log (P)$ dB at or below 2490.5 MHz. Mobile Satellite Service licensees operating on frequencies below 2495 MHz may also submit a documented interference complaint against BRS licensees operating on channel BRS Channel 1 on the same terms and conditions as adjacent channel BRS or EBS licensees.



3.5.2 Test Procedures

The testing follows FCC KDB 971168 D01 v03r01 Section 6.0.

1. The EUT was connected to spectrum analyzer and system simulator via a power divider.
2. The band edges of low and high channels for the highest RF powers were measured.
3. Set RBW \geq 1% EBW in the 1MHz band immediately outside and adjacent to the band edge.
4. Beyond the 1 MHz band from the band edge, RBW=1MHz was used.
5. Set spectrum analyzer with RMS detector.
6. The RF fundamental frequency should be excluded against the limit line in the operating frequency band.
7. Checked that all the results comply with the emission limit line.
The limit line is derived from $43 + 10\log(P)$ dB below the transmitter power P(Watts)
8. For LTE Band 7, 38, 41, the other 40 dB, and 55 dB have additionally applied same calculation above.



3.6 Conducted Spurious Emission

3.6.1 Description of Conducted Spurious Emission Measurement

The power of any emission outside of the authorized operating frequency ranges must be lower than the transmitter power (P) by a factor of at least $43 + 10 \log (P)$ dB.

For Band 7,38,41:

The power of any emission outside of the authorized operating frequency ranges must be lower than the transmitter power (P) by a factor of at least $55 + 10 \log (P)$ dB.

It is measured by means of a calibrated spectrum analyzer and scanned from 30 MHz up to a frequency including its 10th harmonic.

3.6.2 Test Procedures

The testing follows FCC KDB 971168 D01 v03r01 Section 6.0.

1. The EUT was connected to spectrum analyzer and system simulator via a power divider.
2. The RF output of EUT was connected to the spectrum analyzer by RF cable and attenuator.
The path loss was compensated to the results for each measurement.
3. The middle channel for the highest RF power within the transmitting frequency was measured.
4. The conducted spurious emission for the whole frequency range was taken.
5. Make the measurement with the spectrum analyzer's RBW = 1MHz, VBW = 3MHz.
6. Set spectrum analyzer with RMS detector.
7. Taking the record of maximum spurious emission.
8. The RF fundamental frequency should be excluded against the limit line in the operating frequency band.
9. The limit line is derived from $43 + 10\log(P)$ dB below the transmitter power P(Watts)
10. For Band 7, 38, 41
The limit line is derived from $55 + 10\log(P)$ dB below the transmitter power P(Watts)



3.7 Frequency Stability

3.7.1 Description of Frequency Stability Measurement

22.355

The frequency stability shall be measured by variation of ambient temperature and variation of primary supply voltage to ensure that the fundamental emission stays within the authorized frequency block. The frequency stability of the transmitter shall be maintained within $\pm 0.00025\%$ ($\pm 2.5\text{ppm}$) of the center frequency.

24.235 & 27.54

The frequency stability shall be sufficient to ensure that the fundamental emission stays within the authorized frequency block.

3.7.2 Test Procedures for Temperature Variation

The testing follows FCC KDB 971168 D01 v03r01 Section 9.0.

1. The EUT was set up in the thermal chamber and connected with the system simulator.
2. With power OFF, the temperature was decreased to -30°C and the EUT was stabilized before testing. Power was applied and the maximum change in frequency was recorded within one minute.
3. With power OFF, the temperature was raised in 10°C step up to 50°C . The EUT was stabilized at each step for at least half an hour. Power was applied and the maximum frequency change was recorded within one minute.

3.7.3 Test Procedures for Voltage Variation

The testing follows FCC KDB 971168 D01 v03r01 Section 9.0.

1. The EUT was placed in a temperature chamber at $20\pm 5^{\circ}\text{C}$ and connected with the system simulator.
2. The power supply voltage to the EUT was varied from 85% to 115% of the nominal value measured at the input to the EUT.
3. The variation in frequency was measured for the worst case.

4 Radiated Test Items

4.1 Measuring Instruments

See list of measuring instruments of this test report.

4.1.1 Test Setup

For radiated test from 30MHz to 1GHz

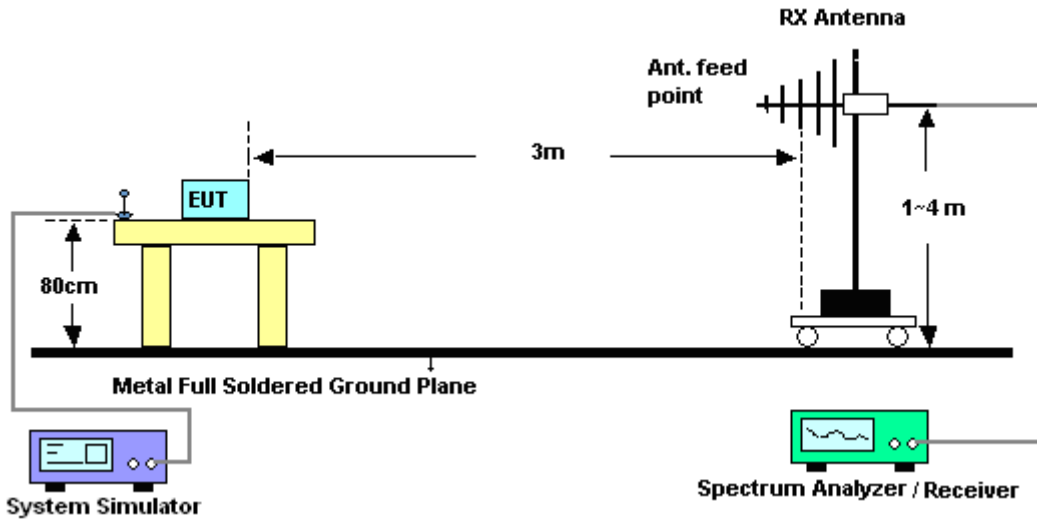

For radiated test above 1GHz

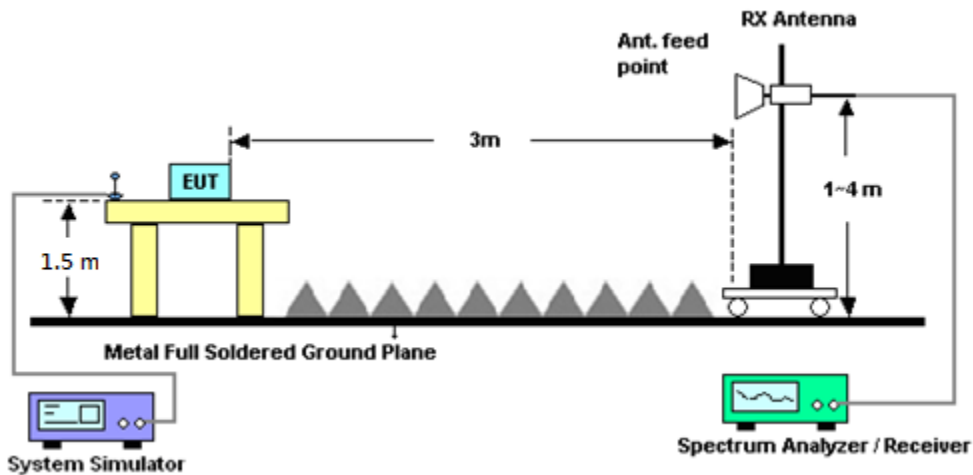

4.1.2 Test Result of Radiated Test

Please refer to Appendix B.



4.2 Radiated Spurious Emission

4.2.1 Description of Radiated Spurious Emission

The radiated spurious emission was measured by substitution method according to ANSI / TIA-603-E. The power of any emission outside of the authorized operating frequency ranges must be attenuated below the transmitter power (P) by a factor of at least $43 + 10 \log (P)$ dB.

For Band 7, 38, 41

The power of any emission outside of the authorized operating frequency ranges must be attenuated below the transmitter power (P) by a factor of at least $55 + 10 \log (P)$ dB.

The spectrum is scanned from 30 MHz up to a frequency including its 10th harmonic.

4.2.2 Test Procedures

The testing follows FCC KDB 971168 D01 v03r01 Section 5.8 and ANSI / TIA-603-E Section 2.2.12.

1. The EUT was placed on a turntable with 0.8 meter for frequency below 1GHz and 1.5 meter for frequency above 1GHz respectively above ground.
2. The EUT was set 3 meters from the receiving antenna, which was mounted on the antenna tower.
3. The table was rotated 360 degrees to determine the position of the highest spurious emission.
4. The height of the receiving antenna is varied between one meter and four meters to search the maximum spurious emission for both horizontal and vertical polarizations.
5. Make the measurement with the spectrum analyzer's RBW = 1MHz, VBW = 3MHz, taking the record of maximum spurious emission.
6. A horn antenna was substituted in place of the EUT and was driven by a signal generator.
7. Tune the output power of signal generator to the same emission level with EUT maximum spurious emission.
8. Taking the record of output power at antenna port.
9. Repeat step 7 to step 8 for another polarization.
10. The RF fundamental frequency should be excluded against the limit line in the operating frequency band.

The limit line is derived from $43 + 10\log(P)$ dB below the transmitter power P(Watts)

11. For Band 7, 38, 41:

The limit line is derived from $55 + 10\log(P)$ dB below the transmitter power P(Watts)

EIRP (dBm) = S.G. Power – Tx Cable Loss + Tx Antenna Gain

ERP (dBm) = EIRP - 2.15



5 List of Measuring Equipment

Instrument	Manufacturer	Model No.	Serial No.	Characteristics	Calibration Date	Test Date	Due Date	Remark
LTE Base Station	Anritsu	MT8820C	620143282 1	GSM/GPRS /WCDMA/LTE	Oct. 13, 2017	Sep. 25, 2018~ Sep. 26, 2018	Oct. 12, 2018	Conducted (TH05-HY)
Programmable Power Supply	GW Instek	PSS-2005	EL890001	1V~20V 0.5A~5A	Oct. 06, 2017	Sep. 25, 2018~ Sep. 26, 2018	Oct. 05, 2018	Conducted (TH05-HY)
Coupler	Warison	1-18GHz 20dB 25WSMA Directional Coupler	#B	1G~18GHz	Dec. 04, 2017	Sep. 25, 2018~ Sep. 26, 2018	Dec. 03, 2018	Conducted (TH05-HY)
Bilog Antenna	TESEQ	CBL 6111D&00800 N1D01N-06	35419&03	30MHz to 1GHz	Dec. 18, 2017	Sep. 22, 2018~ Sep. 28, 2018	Dec. 17, 2018	Radiation (03CH07-HY)
Double Ridge Horn Antenna	ESCO	3117	00211469	1GHz ~ 18GHz	Aug. 06, 2018	Sep. 22, 2018~ Sep. 28, 2018	Aug. 05, 2019	Radiation (03CH07-HY)
Double Ridge Horn Antenna	ESCO	3117	00066583	1GHz ~ 18GHz	Aug. 06, 2018	Sep. 22, 2018~ Sep. 28, 2018	Aug. 05, 2019	Radiation (03CH07-HY)
SHF-EHF Horn Antenna	SCHWARZBECK	BBHA 9170	BBHA9170 251	18GHz- 40GHz	Nov. 10, 2017	Sep. 22, 2018~ Sep. 28, 2018	Nov. 09, 2018	Radiation (03CH07-HY)
Loop Antenna	Rohde & Schwarz	HFH2-Z2	100315	9 kHz~30 MHz	Nov. 10, 2017	Sep. 22, 2018~ Sep. 28, 2018	Nov. 09, 2018	Radiation (03CH07-HY)
Preamplifier	MITEQ	AMF-7D-0010 1800-30-10P	1590075	1GHz ~ 18GHz	Apr. 25, 2018	Sep. 22, 2018~ Sep. 28, 2018	Apr. 24, 2019	Radiation (03CH07-HY)
Amplifier	MITEQ	TTA1840-35-HG	1871923	18GHz~40GHz, VSWR : 2.5:1 max	Jul. 16, 2018	Sep. 22, 2018~ Sep. 28, 2018	Jul. 15, 2019	Radiation (03CH07-HY)
Spectrum Analyzer	Agilent	N9010A	MY534701 18	10Hz~44GHz	Apr. 17, 2018	Sep. 22, 2018~ Sep. 28, 2018	Apr. 16, 2019	Radiation (03CH07-HY)
RF Cable	HUBER + SUHNER	SUCOFLEX 104	MY28655/4 MY24971/4 MY15682/4	30MHz~1GHz	Feb. 27, 2018	Sep. 22, 2018~ Sep. 28, 2018	Feb. 26, 2019	Radiation (03CH07-HY)
RF Cable	HUBER + SUHNER	SUCOFLEX 104	MY28655/4 MY24971/4 MY15682/4	1GHz~18GHz	Feb. 27, 2018	Sep. 22, 2018~ Sep. 28, 2018	Feb. 26, 2019	Radiation (03CH07-HY)
RF Cable	HUBER + SUHNER	SUCOFLEX 102	MY2858/2	18GHz~40GHz	Feb. 27, 2018	Sep. 22, 2018~ Sep. 28, 2018	Feb. 26, 2019	Radiation (03CH07-HY)
Controller	ChainTek	Chaintek 3000	N/A	Control Turn table	N/A	Sep. 22, 2018~ Sep. 28, 2018	N/A	Radiation (03CH07-HY)
Controller	Max-Full	MF7802	MF780208 368	Control Ant Mast	N/A	Sep. 22, 2018~ Sep. 28, 2018	N/A	Radiation (03CH07-HY)
Antenna Mast	Max-Full	MFA520BS	N/A	1m~4m	N/A	Sep. 22, 2018~ Sep. 28, 2018	N/A	Radiation (03CH07-HY)
Turn Table	ChainTek	Chaintek 3000	N/A	0~360 Degree	N/A	Sep. 22, 2018~ Sep. 28, 2018	N/A	Radiation (03CH07-HY)



Instrument	Manufacturer	Model No.	Serial No.	Characteristics	Calibration Date	Test Date	Due Date	Remark
Signal Generator	Rohde & Schwarz	SMF100A	101107	100kHz~40GHz	May. 22, 2018	Sep. 22, 2018~ Sep. 28, 2018	May. 21, 2019	Radiation (03CH07-HY)
Software	Audix	E3 6.2009-8- 24	805040046 56H	N/A	N/A	Sep. 22, 2018~ Sep. 28, 2018	N/A	Radiation (03CH07-HY)
Filter	Microwave	H1G013G1	SN477215	1.0G High Pass	Dec. 07, 2017	Sep. 22, 2018~ Sep. 28, 2018	Dec. 06, 2018	Radiation (03CH07-HY)
Filter	Microwave	H3G018G1	SN477220	3.0G High Pass	Nov. 21, 2017	Sep. 22, 2018~ Sep. 28, 2018	Nov. 20, 2018	Radiation (03CH07-HY)
Notch Filter	Wainwright	WRCT800/96 0-0.2/40-8SS K	SN22	GSM850	Nov. 03, 2017	Sep. 22, 2018~ Sep. 28, 2018	Nov. 02, 2018	Radiation (03CH07-HY)
Notch Filter	Wainwright	WRCT1747.5- 0.4/40-8SS	SN2	DCS 1800	Aug. 22, 2018	Sep. 22, 2018~ Sep. 28, 2018	Aug. 21, 2019	Radiation (03CH07-HY)
Notch Filter	Wainwright	WRCT2500/2 570-10/40-10 SSK	SN1 R	LTE Band7	Aug. 22, 2018	Sep. 22, 2018~ Sep. 28, 2018	Aug. 21, 2019	Radiation (03CH07-HY)
Notch Filter	Wainwright	WRCT698/79 8-10/40 8SSK	SN1	AWS Band	Nov. 08, 2017	Sep. 22, 2018~ Sep. 28, 2018	Nov. 07, 2018	Radiation (03CH07-HY)



6 Uncertainty of Evaluation

Uncertainty of Radiated Emission Measurement (30 MHz ~ 1000 MHz)

Measuring Uncertainty for a Level of Confidence of 95% ($U = 2Uc(y)$)	3.05
---	------

Uncertainty of Radiated Emission Measurement (1 GHz ~ 18 GHz)

Measuring Uncertainty for a Level of Confidence of 95% ($U = 2Uc(y)$)	3.44
---	------

Uncertainty of Radiated Emission Measurement (18 GHz ~ 40 GHz)

Measuring Uncertainty for a Level of Confidence of 95% ($U = 2Uc(y)$)	3.95
---	------



Appendix A. Test Results of Conducted Test

Conducted Output Power(Average power)

LTE Band 2 Maximum Average Power [dBm]						
BW [MHz]	RB Size	RB Offset	Mod	Lowest	Middle	Highest
20	1	0	QPSK	22.40	22.18	22.25
20	1	49		22.27	22.04	22.05
20	1	99		22.34	21.98	22.20
20	50	0		22.15	21.70	21.86
20	50	24		21.86	21.59	21.56
20	50	50		21.81	21.49	21.74
20	100	0		21.93	21.73	21.56
20	1	0	16-QAM	22.19	22.07	22.19
20	1	49		21.99	21.59	22.01
20	1	99		22.17	21.85	21.96
20	50	0		20.97	20.68	20.89
20	50	24		20.88	20.65	20.79
20	50	50		20.87	20.60	20.79
20	100	0		20.78	20.46	20.89
15	1	0	QPSK	22.61	22.30	22.40
15	1	37		22.27	22.05	22.24
15	1	74		22.48	22.23	22.43
15	36	0		22.31	21.96	22.23
15	36	20		21.98	21.56	22.19
15	36	39		21.92	21.68	21.86
15	75	0		22.11	21.80	22.09
15	1	0	16-QAM	22.35	22.19	22.34
15	1	37		22.05	21.93	22.09
15	1	74		22.30	21.76	22.28
15	36	0		21.32	21.00	21.21
15	36	20		20.97	20.86	20.96
15	36	39		20.79	20.95	20.79
15	75	0		21.11	20.82	21.11



LTE Band 2 Maximum Average Power [dBm]						
BW [MHz]	RB Size	RB Offset	Mod	Lowest	Middle	Highest
10	1	0	QPSK	22.30	22.09	22.21
10	1	25		22.47	22.09	22.22
10	1	49		22.20	22.13	22.26
10	25	0		21.99	21.73	21.93
10	25	12		22.02	21.68	21.94
10	25	25		21.80	21.50	21.77
10	50	0		21.88	21.58	21.82
10	1	0		16-QAM	22.03	21.85
10	1	25	22.11		21.84	22.09
10	1	49	21.71		21.39	21.65
10	25	0	20.98		20.68	20.92
10	25	12	21.02		20.68	20.90
10	25	25	20.86		20.51	20.73
10	50	0	20.94		20.62	20.81
5	1	0	QPSK		22.21	21.96
5	1	12		22.33	22.05	22.26
5	1	24		22.36	22.02	22.26
5	12	0		22.01	21.72	21.95
5	12	7		21.96	21.62	21.88
5	12	13		21.94	21.55	21.87
5	25	0		21.99	21.64	21.87
5	1	0		16-QAM	22.22	21.98
5	1	12	22.09		21.81	22.03
5	1	24	22.14		21.81	22.02
5	12	0	20.98		20.75	20.94
5	12	7	21.00		20.71	20.95
5	12	13	20.97		20.62	20.88
5	25	0	20.93		20.61	20.87



LTE Band 2 Maximum Average Power [dBm]						
BW [MHz]	RB Size	RB Offset	Mod	Lowest	Middle	Highest
3	1	0	QPSK	22.35	22.08	22.24
3	1	8		22.38	22.02	22.30
3	1	14		22.34	22.03	22.24
3	8	0		21.99	21.66	21.88
3	8	4		21.96	21.62	21.89
3	8	7		21.93	21.57	21.86
3	15	0		21.91	21.63	21.84
3	1	0		16-QAM	22.27	21.88
3	1	8	22.24		21.83	22.11
3	1	14	22.18		21.82	22.10
3	8	0	20.99		20.71	20.95
3	8	4	21.01		20.74	20.94
3	8	7	20.99		20.61	20.91
3	15	0	21.01		20.68	20.87
1.4	1	0	QPSK		22.42	22.16
1.4	1	3		22.39	22.06	22.31
1.4	1	5		22.32	22.08	22.19
1.4	3	0		22.32	22.02	22.26
1.4	3	1		22.35	22.05	22.24
1.4	3	3		22.33	22.02	22.20
1.4	6	0		21.90	21.62	21.82
1.4	1	0		16-QAM	22.21	21.79
1.4	1	3	22.21		21.82	22.07
1.4	1	5	22.15		21.76	22.00
1.4	3	0	21.87		21.57	21.77
1.4	3	1	21.90		21.61	21.80
1.4	3	3	21.84		21.56	21.79
1.4	6	0	21.08		20.68	20.87



LTE Band 4 Maximum Average Power [dBm]						
BW [MHz]	RB Size	RB Offset	Mod	Lowest	Middle	Highest
20	1	0	QPSK	22.42	22.40	22.50
20	1	49		22.49	22.56	22.41
20	1	99		22.50	22.63	22.91
20	50	0		22.16	21.85	21.84
20	50	24		21.95	21.90	21.95
20	50	50		21.99	21.92	22.05
20	100	0		22.01	21.89	22.06
20	1	0	16-QAM	22.52	22.31	21.96
20	1	49		22.39	22.01	22.21
20	1	99		22.03	22.19	22.17
20	50	0		21.13	20.95	20.84
20	50	24		20.99	20.79	20.89
20	50	50		20.89	20.98	21.06
20	100	0		21.15	20.78	20.89
15	1	0	QPSK	22.81	22.50	22.32
15	1	37		22.68	22.52	22.61
15	1	74		22.59	22.77	22.66
15	36	0		22.60	22.32	22.26
15	36	20		22.21	22.04	22.13
15	36	39		22.03	22.01	22.16
15	75	0		22.29	22.16	22.16
15	1	0	16-QAM	22.29	22.90	22.69
15	1	37		22.20	22.31	22.14
15	1	74		22.36	22.52	22.79
15	36	0		21.53	21.36	21.27
15	36	20		21.20	21.03	21.09
15	36	39		20.99	20.99	21.19
15	75	0		21.27	21.16	21.23



LTE Band 4 Maximum Average Power [dBm]						
BW [MHz]	RB Size	RB Offset	Mod	Lowest	Middle	Highest
10	1	0	QPSK	22.42	22.69	22.46
10	1	25		22.58	22.49	22.69
10	1	49		22.10	22.31	22.48
10	25	0		22.17	21.95	22.10
10	25	12		22.08	22.00	22.19
10	25	25		21.87	21.91	22.18
10	50	0		21.97	21.87	22.14
10	1	0		22.39	22.12	22.27
10	1	25	16-QAM	22.36	22.15	22.45
10	1	49		21.86	21.86	22.24
10	25	0		21.17	20.93	21.10
10	25	12		21.13	20.98	21.17
10	25	25		20.84	20.90	21.12
10	50	0		21.03	20.93	21.13
5	1	0		QPSK	22.16	22.53
5	1	12	22.66		22.43	22.70
5	1	24	22.62		22.52	22.83
5	12	0	22.29		21.96	22.32
5	12	7	22.21		21.97	22.34
5	12	13	22.12		22.01	22.30
5	25	0	22.23		21.99	22.35
5	1	0	16-QAM	22.67	22.33	22.59
5	1	12		22.30	22.09	22.44
5	1	24		22.33	22.26	22.73
5	12	0		21.31	20.98	21.35
5	12	7		21.26	20.98	21.32
5	12	13		21.20	21.00	21.37
5	25	0		21.20	20.99	21.33



LTE Band 4 Maximum Average Power [dBm]						
BW [MHz]	RB Size	RB Offset	Mod	Lowest	Middle	Highest
3	1	0	QPSK	22.56	22.69	22.12
3	1	8		22.75	22.51	22.80
3	1	14		22.57	22.39	22.82
3	8	0		22.22	21.90	22.28
3	8	4		22.18	21.94	22.31
3	8	7		22.19	21.86	22.31
3	15	0		22.22	21.95	22.34
3	1	0		22.54	22.39	22.55
3	1	8	16-QAM	22.37	22.16	22.58
3	1	14		22.41	22.28	22.59
3	8	0		21.30	20.97	21.40
3	8	4		21.30	21.05	21.39
3	8	7		21.23	20.92	21.37
3	15	0		21.24	21.00	21.35
1.4	1	0		QPSK	22.72	22.37
1.4	1	3	22.71		22.48	22.75
1.4	1	5	22.62		22.39	22.77
1.4	3	0	22.69		22.42	22.81
1.4	3	1	22.70		22.46	22.60
1.4	3	3	22.71		22.46	22.61
1.4	6	0	22.20		21.93	22.32
1.4	1	0	16-QAM	22.50	22.23	22.60
1.4	1	3		22.52	22.32	22.63
1.4	1	5		22.43	22.24	22.60
1.4	3	0		22.23	21.95	22.36
1.4	3	1		22.24	21.97	22.39
1.4	3	3		22.25	21.96	22.39
1.4	6	0		21.23	20.99	21.38



LTE Band 5 Maximum Average Power [dBm]						
BW [MHz]	RB Size	RB Offset	Mod	Lowest	Middle	Highest
10	1	0	QPSK	23.00	22.95	22.87
10	1	25		23.28	23.05	22.88
10	1	49		22.86	22.75	22.60
10	25	0		22.14	22.07	21.72
10	25	12		22.25	22.15	21.84
10	25	25		22.10	22.12	21.67
10	50	0		22.16	22.11	21.86
10	1	0		16-QAM	22.09	22.02
10	1	25	22.17		22.15	21.99
10	1	49	22.01		21.66	21.59
10	25	0	21.15		21.15	20.69
10	25	12	21.19		21.27	20.79
10	25	25	21.10		21.10	20.59
10	50	0	21.12		21.05	20.70
5	1	0	QPSK		22.78	22.83
5	1	12		23.21	23.20	22.72
5	1	24		23.20	23.20	22.75
5	12	0		22.30	22.28	21.82
5	12	7		22.28	22.29	21.81
5	12	13		22.25	22.25	21.79
5	25	0		22.30	22.28	21.82
5	1	0		16-QAM	22.52	22.53
5	1	12	22.31		22.38	21.87
5	1	24	22.42		22.45	21.97
5	12	0	21.28		21.35	20.88
5	12	7	21.27		21.30	20.88
5	12	13	21.28		21.29	20.86
5	25	0	21.24		21.25	20.86



LTE Band 5 Maximum Average Power [dBm]						
BW [MHz]	RB Size	RB Offset	Mod	Lowest	Middle	Highest
3	1	0	QPSK	22.85	22.94	22.66
3	1	8		23.24	23.21	22.79
3	1	14		23.21	23.15	22.72
3	8	0		22.28	22.24	21.79
3	8	4		22.27	22.27	21.81
3	8	7		22.28	22.24	21.80
3	15	0		22.26	22.24	21.81
3	1	0		22.42	22.41	22.02
3	1	8	16-QAM	22.48	22.47	22.02
3	1	14		22.43	22.42	21.91
3	8	0		21.33	21.33	20.88
3	8	4		21.34	21.37	20.85
3	8	7		21.31	21.36	20.85
3	15	0		21.25	21.24	20.81
1.4	1	0		QPSK	23.19	23.18
1.4	1	3	23.14		23.23	22.78
1.4	1	5	23.10		23.19	22.72
1.4	3	0	23.19		23.21	22.71
1.4	3	1	23.11		23.21	22.74
1.4	3	3	23.23		23.21	22.72
1.4	6	0	22.22		22.25	21.81
1.4	1	0	16-QAM	22.47	22.38	21.97
1.4	1	3		22.50	22.51	22.04
1.4	1	5		22.40	22.45	21.93
1.4	3	0		22.22	22.22	21.79
1.4	3	1		22.28	22.32	21.87
1.4	3	3		22.15	22.26	21.76
1.4	6	0		21.09	21.30	20.83



LTE Band 7 Maximum Average Power [dBm]						
BW [MHz]	RB Size	RB Offset	Mod	Lowest	Middle	Highest
20	1	0	QPSK	22.91	22.80	22.73
20	1	49		22.59	22.65	22.67
20	1	99		22.69	22.49	22.54
20	50	0		21.78	21.67	21.59
20	50	24		21.63	21.58	21.62
20	50	50		21.70	21.46	21.61
20	100	0		21.67	21.45	21.42
20	1	0		21.96	21.78	22.01
20	1	49	16-QAM	21.85	21.76	21.92
20	1	99		21.94	21.69	21.97
20	50	0		20.67	20.65	20.69
20	50	24		20.60	20.79	20.73
20	50	50		20.74	20.74	20.85
20	100	0		20.67	20.45	20.73
15	1	0		QPSK	22.86	22.60
15	1	37	22.57		22.46	22.67
15	1	74	22.78		22.76	22.90
15	36	0	21.90		21.75	21.92
15	36	20	21.76		21.62	21.86
15	36	39	21.68		21.72	21.84
15	75	0	21.78		21.72	21.91
15	1	0	16-QAM	22.28	22.27	22.36
15	1	37		21.82	21.74	21.91
15	1	74		22.08	22.05	22.14
15	36	0		20.88	20.77	20.93
15	36	20		20.77	20.66	20.82
15	36	39		20.64	20.70	20.79
15	75	0		20.82	20.76	20.92



LTE Band 7 Maximum Average Power [dBm]						
BW [MHz]	RB Size	RB Offset	Mod	Lowest	Middle	Highest
10	1	0	QPSK	22.83	22.76	22.89
10	1	25		23.05	22.90	22.98
10	1	49		22.65	22.54	22.61
10	25	0		22.04	21.93	21.94
10	25	12		22.10	22.00	22.10
10	25	25		21.98	21.85	21.95
10	50	0		21.99	21.93	21.97
10	1	0		16-QAM	21.95	21.91
10	1	25	22.25		22.16	22.30
10	1	49	21.88		21.79	21.88
10	25	0	21.09		20.97	20.95
10	25	12	21.16		20.99	21.08
10	25	25	20.98		20.82	20.99
10	50	0	21.07		20.88	20.95
5	1	0	QPSK		22.92	22.86
5	1	12		22.90	22.95	23.02
5	1	24		22.69	22.99	23.04
5	12	0		22.15	22.05	22.09
5	12	7		22.10	22.03	22.12
5	12	13		22.12	21.98	22.08
5	25	0		22.12	22.02	22.09
5	1	0	16-QAM	22.28	22.22	22.35
5	1	12		22.24	22.17	22.25
5	1	24		22.24	22.22	22.22
5	12	0		21.13	21.06	21.12
5	12	7		21.17	21.05	21.14
5	12	13		21.12	21.00	21.11
5	25	0		21.11	21.02	21.10



LTE Band 26 Maximum Average Power [dBm]						
BW [MHz]	RB Size	RB Offset	Mod	Lowest	Middle	Highest
15	1	0	QPSK	23.01	22.98	22.75
15	1	37		23.24	23.01	22.80
15	1	74		22.94	23.00	22.62
15	36	0		22.14	22.18	21.79
15	36	20		22.12	22.01	21.70
15	36	39		21.79	22.07	21.54
15	75	0		22.12	21.98	21.86
15	1	0	16-QAM	22.43	22.58	22.08
15	1	37		22.27	22.45	21.82
15	1	74		22.22	22.36	21.92
15	36	0		21.19	21.45	20.99
15	36	20		21.09	21.13	20.72
15	36	39		20.96	21.20	20.65
15	75	0		21.08	20.78	20.79
10	1	0	QPSK	22.98	22.91	22.84
10	1	25		23.01	23.00	22.67
10	1	49		22.58	22.98	22.67
10	25	0		22.01	22.09	21.64
10	25	12		22.09	22.18	21.74
10	25	25		21.91	21.78	21.60
10	50	0		21.97	22.01	21.62
10	1	0	16-QAM	21.90	22.03	21.75
10	1	25		22.19	22.15	21.96
10	1	49		21.84	21.83	22.78
10	25	0		21.02	21.25	20.61
10	25	12		21.12	21.18	20.70
10	25	25		20.94	20.79	20.54
10	50	0		20.97	20.79	20.58



LTE Band 26 Maximum Average Power [dBm]						
BW [MHz]	RB Size	RB Offset	Mod	Lowest	Middle	Highest
5	1	0	QPSK	22.78	23.07	22.58
5	1	12		23.02	23.05	22.60
5	1	24		23.08	23.05	22.69
5	12	0		22.16	22.18	21.78
5	12	7		22.15	22.15	21.75
5	12	13		22.12	22.11	21.72
5	25	0		22.15	22.13	21.75
5	1	0	16-QAM	22.29	22.39	21.99
5	1	12		22.23	22.29	21.85
5	1	24		22.29	22.31	21.83
5	12	0		21.16	21.24	20.81
5	12	7		21.17	21.22	20.81
5	12	13		21.16	21.20	20.78
5	25	0		21.10	21.14	20.67
3	1	0	QPSK	22.87	23.12	22.66
3	1	8		23.07	23.10	22.67
3	1	14		22.97	23.02	22.62
3	8	0		22.09	22.12	21.72
3	8	4		22.11	22.12	21.74
3	8	7		22.08	22.09	21.70
3	15	0		22.09	22.10	21.72
3	1	0	16-QAM	22.31	22.35	21.87
3	1	8		22.30	22.30	21.92
3	1	14		22.24	22.26	21.84
3	8	0		21.21	21.25	20.83
3	8	4		21.20	21.26	20.86
3	8	7		21.23	21.21	20.83
3	15	0		21.13	21.12	20.70



LTE Band 26 Maximum Average Power [dBm]						
BW [MHz]	RB Size	RB Offset	Mod	Lowest	Middle	Highest
1.4	1	0	QPSK	22.78	22.77	22.43
1.4	1	3		22.86	22.85	22.48
1.4	1	5		22.83	22.76	22.41
1.4	3	0		22.80	22.83	22.49
1.4	3	1		22.82	22.85	22.46
1.4	3	3		22.76	22.78	22.37
1.4	6	0		22.22	22.33	22.00
1.4	1	0	16-QAM	22.70	22.65	22.31
1.4	1	3		22.70	22.70	22.37
1.4	1	5		22.62	22.62	22.31
1.4	3	0		22.21	22.34	22.07
1.4	3	1		22.28	22.45	22.14
1.4	3	3		22.24	22.30	21.98
1.4	6	0		21.40	21.38	20.94



LTE Band 38 Maximum Average Power [dBm]						
BW [MHz]	RB Size	RB Offset	Mod	Lowest	Middle	Highest
20	1	0	QPSK	22.46	22.60	22.95
20	1	49		22.77	22.68	22.51
20	1	99		22.88	22.74	22.68
20	50	0		21.92	21.80	21.65
20	50	24		21.91	21.82	21.62
20	50	50		22.00	21.82	21.63
20	100	0		22.04	21.82	21.66
20	1	0	16-QAM	22.22	22.13	22.09
20	1	49		22.09	21.97	21.82
20	1	99		22.17	21.99	21.93
20	50	0		20.94	20.84	20.64
20	50	24		20.93	20.85	20.67
20	50	50		21.04	20.85	20.65
20	100	0		21.05	20.84	20.69
15	1	0	QPSK	22.81	22.69	22.59
15	1	37		22.90	22.77	22.49
15	1	74		23.20	22.96	22.85
15	36	0		22.11	22.02	21.80
15	36	20		22.02	21.84	21.57
15	36	39		21.89	21.76	21.64
15	75	0		22.09	21.89	21.68
15	1	0	16-QAM	21.56	21.50	21.90
15	1	37		21.93	21.71	21.43
15	1	74		22.17	22.07	21.96
15	36	0		21.13	21.07	20.83
15	36	20		20.97	20.82	20.62
15	36	39		20.86	20.74	20.63
15	75	0		21.15	20.96	20.66



LTE Band 38 Maximum Average Power [dBm]						
BW [MHz]	RB Size	RB Offset	Mod	Lowest	Middle	Highest
10	1	0	QPSK	22.92	22.81	22.70
10	1	25		22.80	22.57	22.46
10	1	49		22.40	22.18	22.09
10	25	0		21.81	21.68	21.48
10	25	12		21.89	21.75	21.60
10	25	25		21.71	21.47	21.42
10	50	0		21.77	21.64	21.50
10	1	0		21.90	21.79	21.66
10	1	25	16-QAM	22.08	21.94	21.75
10	1	49		21.69	21.50	21.42
10	25	0		20.86	20.69	20.54
10	25	12		20.96	20.76	20.60
10	25	25		20.73	20.53	20.47
10	50	0		20.83	20.64	20.50
5	1	0		QPSK	22.86	22.95
5	1	12	22.77		22.58	22.48
5	1	24	22.77		22.51	22.43
5	12	0	21.86		21.75	21.62
5	12	7	21.90		21.72	21.58
5	12	13	21.87		21.72	21.58
5	25	0	21.88		21.69	21.55
5	1	0	16-QAM	22.13	21.97	21.81
5	1	12		22.13	21.96	21.83
5	1	24		22.08	21.81	21.78
5	12	0		20.94	20.79	20.68
5	12	7		20.93	20.80	20.65
5	12	13		20.92	20.78	20.62
5	25	0		20.90	20.76	20.58



LTE Band 41 Maximum Average Power [dBm]						
BW [MHz]	RB Size	RB Offset	Mod	Lowest	Middle	Highest
20	1	0	QPSK	23.90	23.80	23.59
20	1	49		23.68	23.75	23.27
20	1	99		23.78	23.95	23.34
20	50	0		21.60	21.58	21.51
20	50	24		21.57	21.69	21.56
20	50	50		21.61	21.60	21.50
20	100	0		21.59	21.62	21.56
20	1	0		16-QAM	21.93	22.20
20	1	49	21.80		21.79	21.51
20	1	99	21.88		21.80	21.57
20	50	0	20.65		20.62	20.60
20	50	24	20.64		20.68	20.56
20	50	50	20.63		20.78	20.54
20	100	0	20.62		20.64	20.69
15	1	0	QPSK		23.35	23.46
15	1	37		23.90	23.80	23.40
15	1	74		23.90	23.85	23.58
15	36	0		21.78	21.82	21.55
15	36	20		21.57	21.76	21.53
15	36	39		21.63	21.66	21.59
15	75	0		21.75	21.91	21.51
15	1	0		16-QAM	22.28	22.05
15	1	37	21.54		21.65	21.86
15	1	74	21.97		21.86	21.61
15	36	0	20.79		20.84	20.54
15	36	20	20.61		20.77	20.58
15	36	39	20.63		20.62	20.55
15	75	0	20.75		20.86	20.53



LTE Band 41 Maximum Average Power [dBm]						
BW [MHz]	RB Size	RB Offset	Mod	Lowest	Middle	Highest
10	1	0	QPSK	23.50	23.70	23.39
10	1	25		23.66	23.78	23.48
10	1	49		23.30	23.50	23.50
10	25	0		21.56	21.80	21.58
10	25	12		21.53	21.86	21.51
10	25	25		21.52	21.92	21.59
10	50	0		21.50	21.50	21.56
10	1	0		16-QAM	21.53	21.67
10	1	25	21.76		21.76	21.57
10	1	49	21.56		21.56	21.60
10	25	0	20.59		20.58	20.56
10	25	12	20.58		20.58	20.55
10	25	25	20.56		20.67	20.50
10	50	0	20.50		20.50	20.54
5	1	0	QPSK		23.61	23.49
5	1	12		23.62	23.55	23.35
5	1	24		23.63	23.49	23.40
5	12	0		21.53	21.55	21.55
5	12	7		21.51	21.76	21.56
5	12	13		21.52	21.56	21.56
5	25	0		21.53	21.50	21.50
5	1	0		16-QAM	21.78	21.71
5	1	12	21.71		21.60	21.60
5	1	24	21.69		21.64	21.58
5	12	0	20.64		20.50	20.50
5	12	7	20.60		20.58	20.58
5	12	13	20.57		20.58	20.55
5	25	0	20.57		20.50	20.50



LTE Band 41

Peak-to-Average Ratio

Mode	LTE Band 41 / 20MHz				
Mod.	QPSK		16QAM		Limit: 13dB
RB Size	1RB	Full RB	1RB	Full RB	Result
Lowest CH	3.94	4.87	5.19	5.88	PASS
Middle CH	3.65	4.93	4.99	5.91	
Highest CH	3.83	4.93	5.22	5.91	



LTE Band 41 / 20MHz / QPSK

Lowest Channel / 1RB

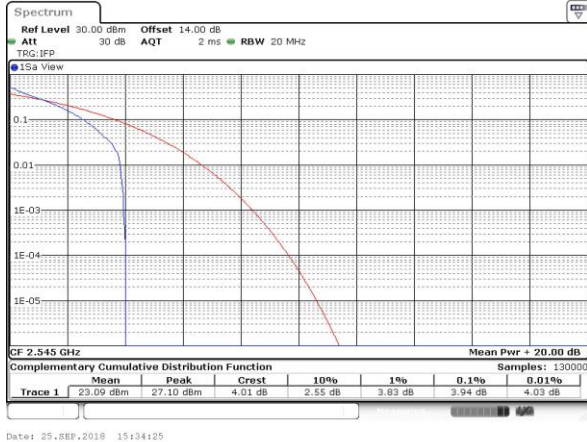

Lowest Channel / Full RB

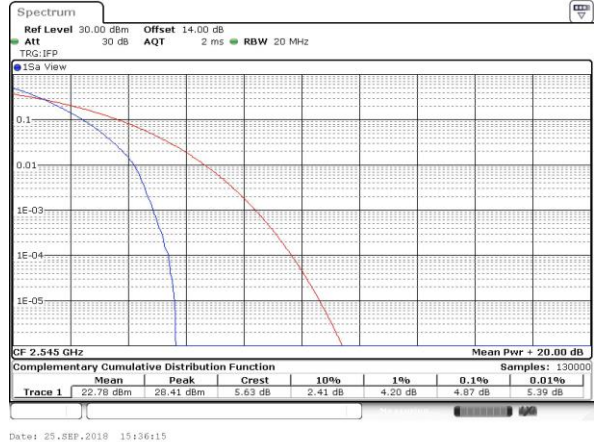

Middle Channel / 1RB

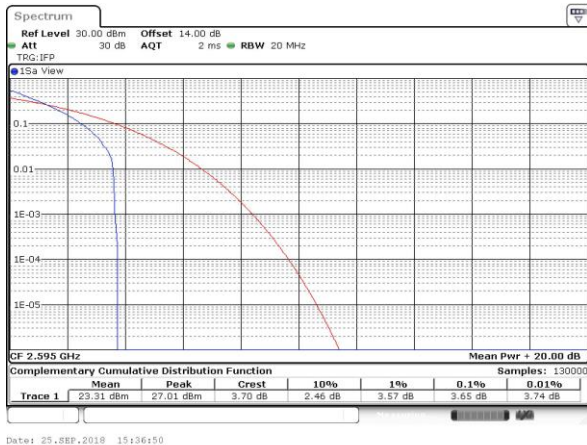

Middle Channel / Full RB

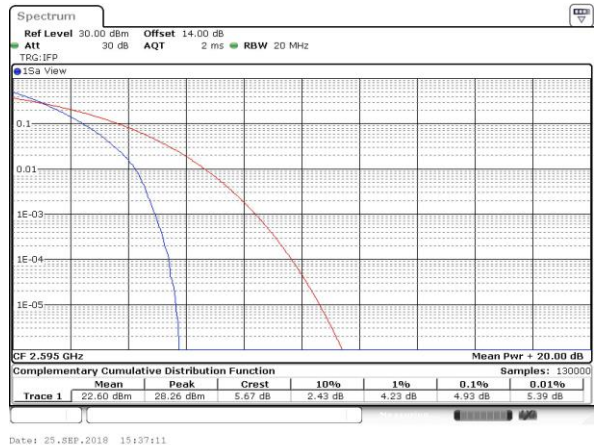

Highest Channel / 1RB

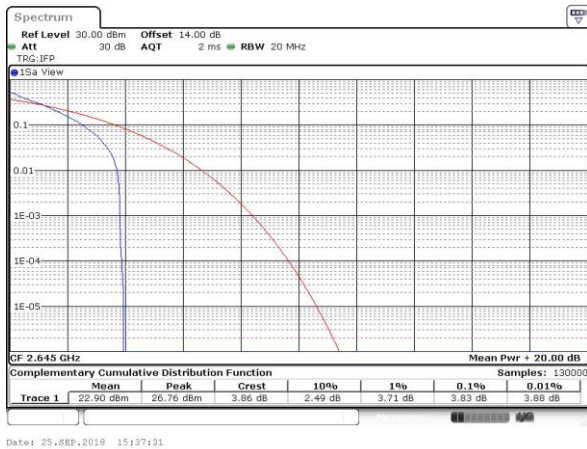

Highest Channel / Full RB

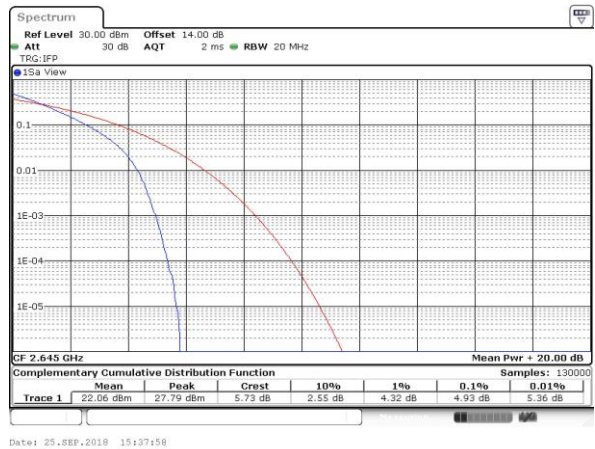



LTE Band 41 / 20MHz / 16QAM

Lowest Channel / 1RB

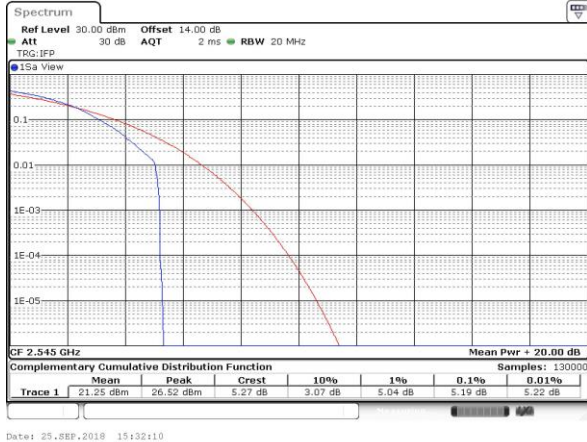

Lowest Channel / Full RB

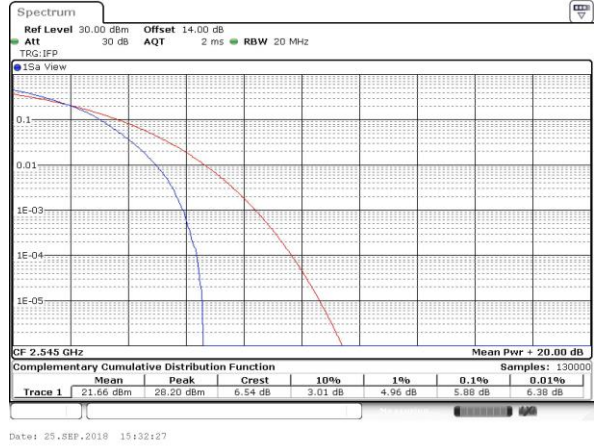

Middle Channel / 1RB

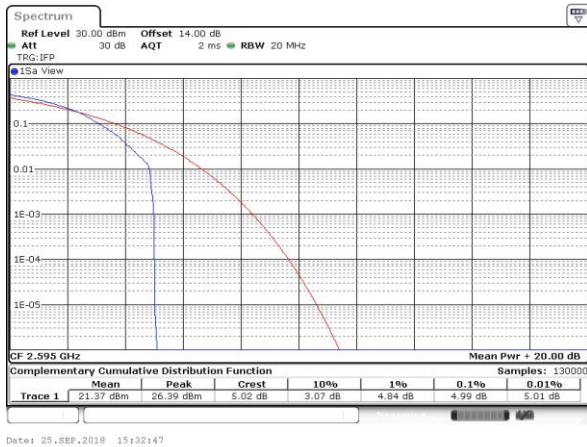

Middle Channel / Full RB

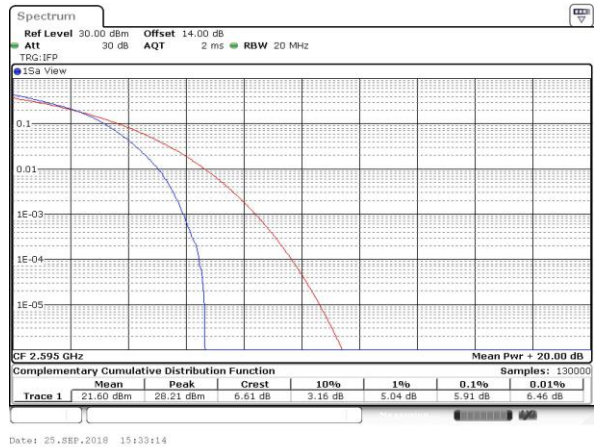

Highest Channel / 1RB

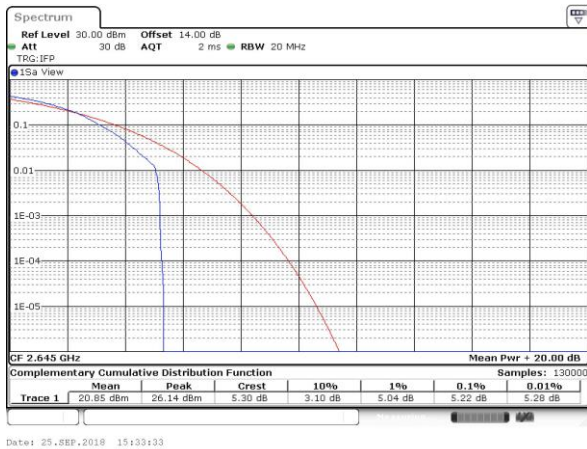

Highest Channel / Full RB

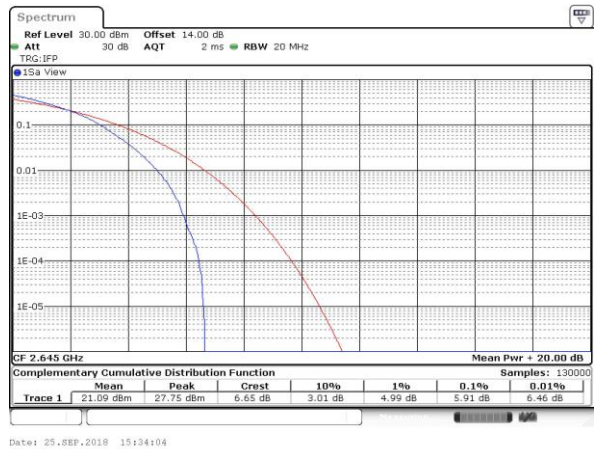



26dB Bandwidth

Mode BW	LTE Band 41 : 26dB BW(MHz)											
	1.4MHz		3MHz		5MHz		10MHz		15MHz		20MHz	
Mod.	QPSK	16QAM	QPSK	16QAM	QPSK	16QAM	QPSK	16QAM	QPSK	16QAM	QPSK	16QAM
Lowest CH	-	-	-	-	4.92	4.94	9.69	9.67	14.18	14.24	20.10	20.26
Middle CH	-	-	-	-	4.85	4.92	9.83	9.63	14.24	14.54	20.22	20.10
Highest CH	-	-	-	-	4.82	4.86	9.79	9.91	14.15	14.12	20.10	20.10



LTE Band 41

Lowest Channel / 5MHz / QPSK

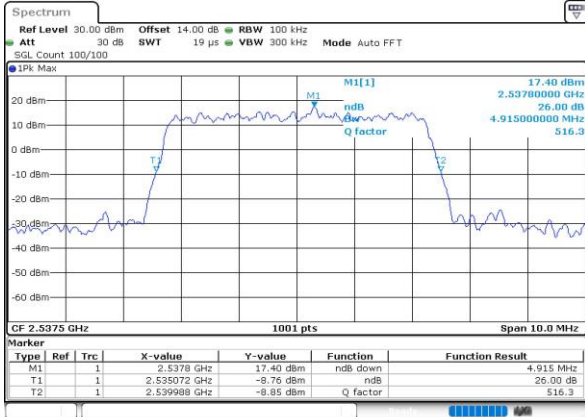

Date: 25_SEP.2018 14:54:28

Lowest Channel / 5MHz / 16QAM

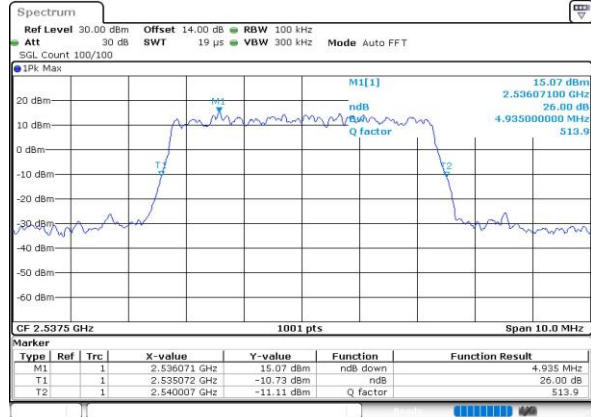

Date: 25_SEP.2018 14:54:40

Middle Channel / 5MHz / QPSK

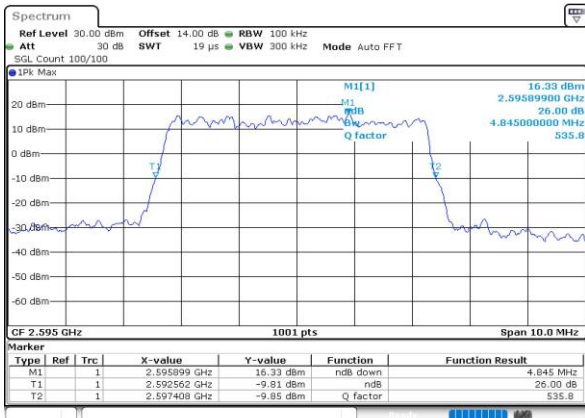

Date: 25_SEP.2018 14:55:14

Middle Channel / 5MHz / 16QAM

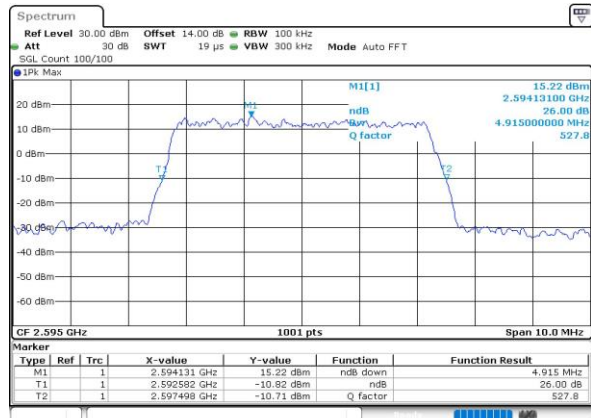

Date: 25_SEP.2018 14:55:26

Highest Channel / 5MHz / QPSK

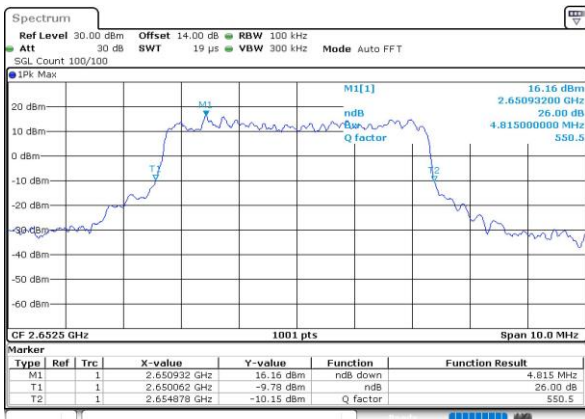

Date: 25_SEP.2018 14:56:00

Highest Channel / 5MHz / 16QAM

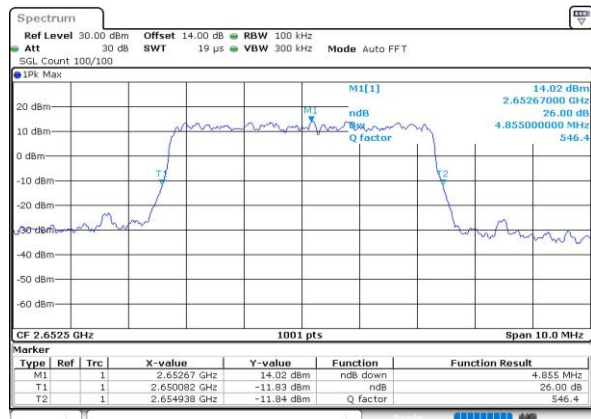

Date: 25_SEP.2018 14:56:12



LTE Band 41

Lowest Channel / 10MHz / QPSK

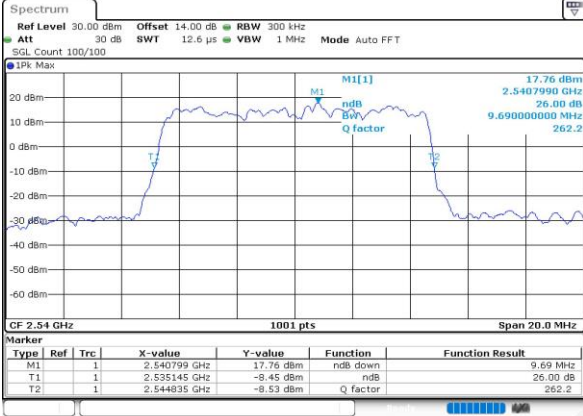

Date: 25_SEP.2018 14:56:46

Lowest Channel / 10MHz / 16QAM

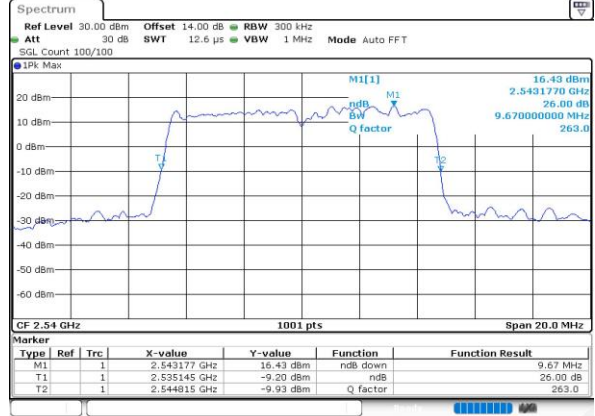

Date: 25_SEP.2018 14:56:58

Middle Channel / 10MHz / QPSK

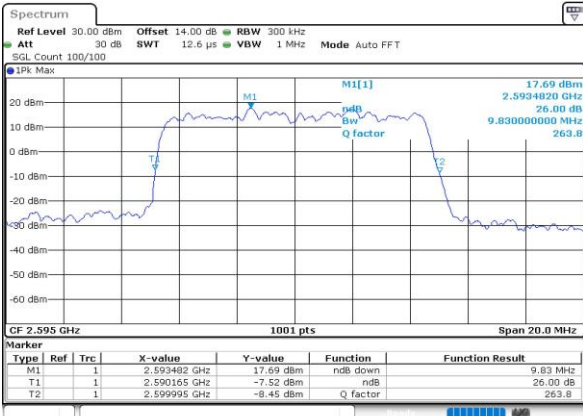

Date: 25_SEP.2018 14:57:32

Middle Channel / 10MHz / 16QAM

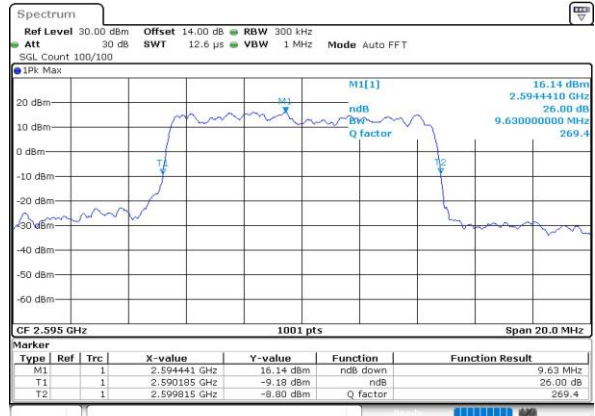

Date: 25_SEP.2018 14:57:44

Highest Channel / 10MHz / QPSK

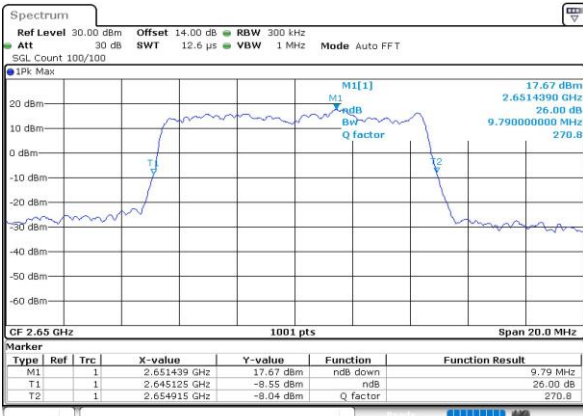

Date: 25_SEP.2018 14:58:18

Highest Channel / 10MHz / 16QAM

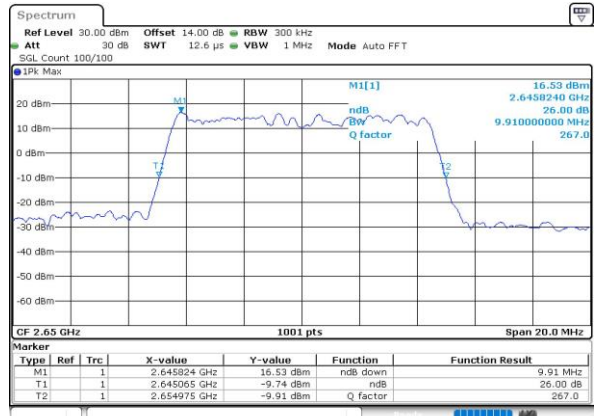

Date: 25_SEP.2018 14:58:29



LTE Band 41

Lowest Channel / 15MHz / QPSK

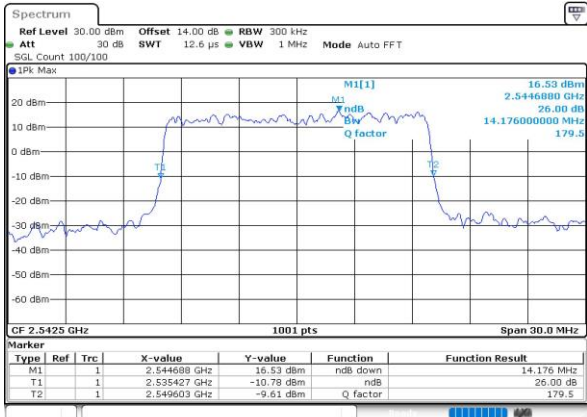

Date: 25.SEP.2018 14:59:04

Lowest Channel / 15MHz / 16QAM

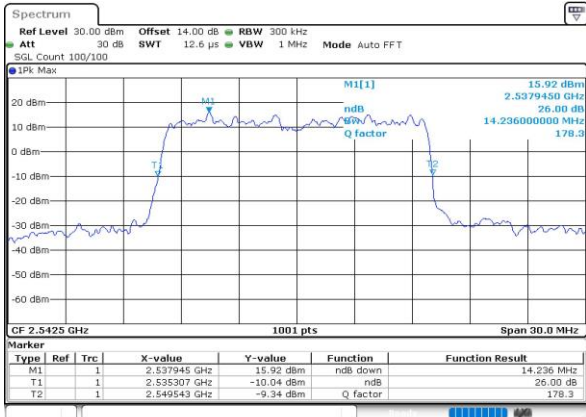

Date: 25.SEP.2018 14:59:15

Middle Channel / 15MHz / QPSK

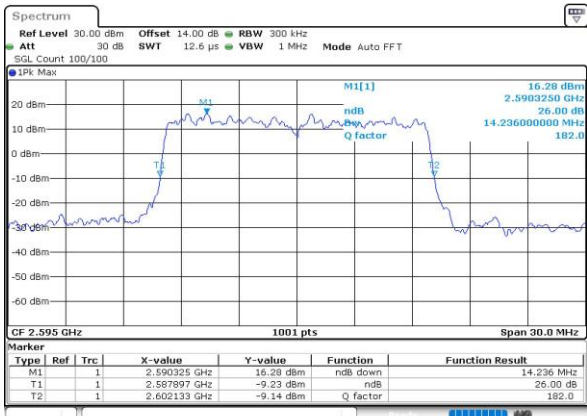

Date: 25.SEP.2018 14:59:50

Middle Channel / 15MHz / 16QAM

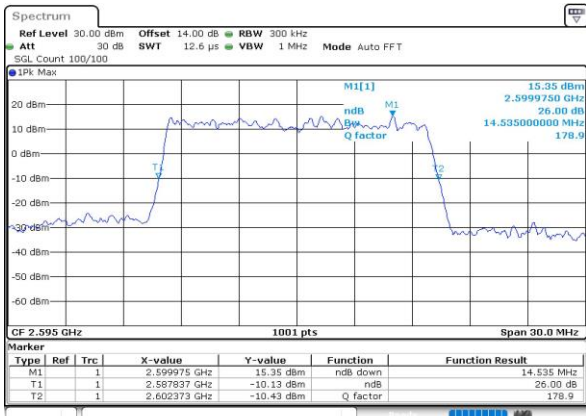

Date: 25.SEP.2018 15:00:01

Highest Channel / 15MHz / QPSK

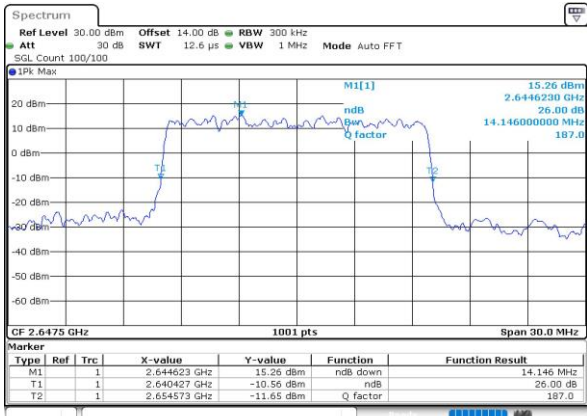

Date: 25.SEP.2018 15:00:36

Highest Channel / 15MHz / 16QAM

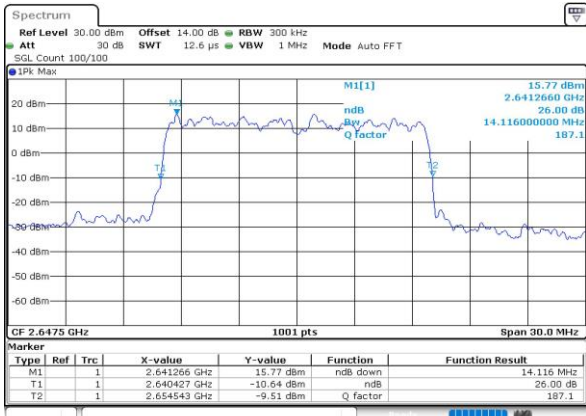

Date: 25.SEP.2018 15:00:47



LTE Band 41

Lowest Channel / 20MHz / QPSK

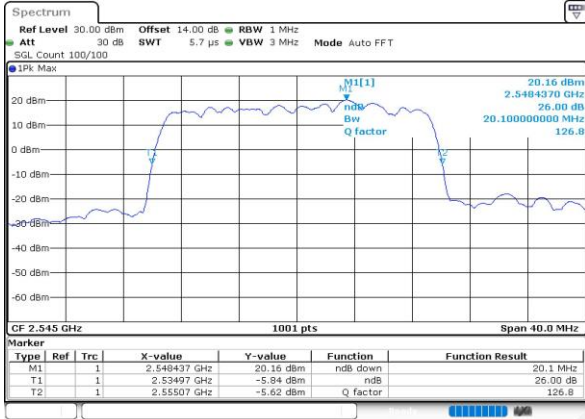

Date: 25_SEP.2018 15:01:21

Lowest Channel / 20MHz / 16QAM

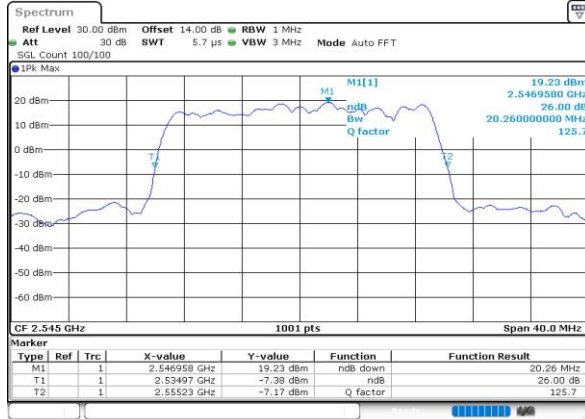

Date: 25_SEP.2018 15:01:33

Middle Channel / 20MHz / QPSK

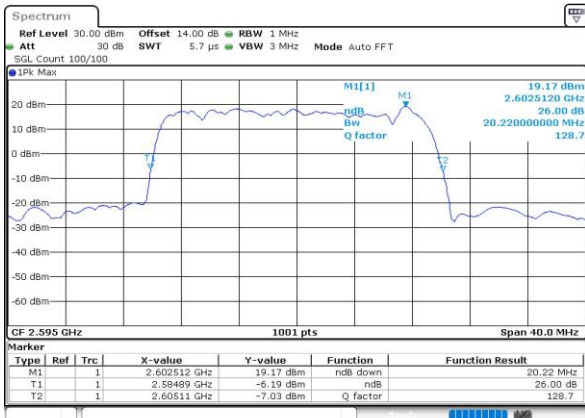

Date: 25_SEP.2018 15:02:07

Middle Channel / 20MHz / 16QAM

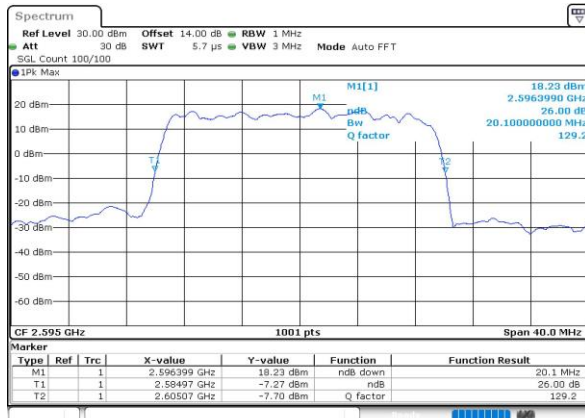

Date: 25_SEP.2018 15:02:19

Highest Channel / 20MHz / QPSK

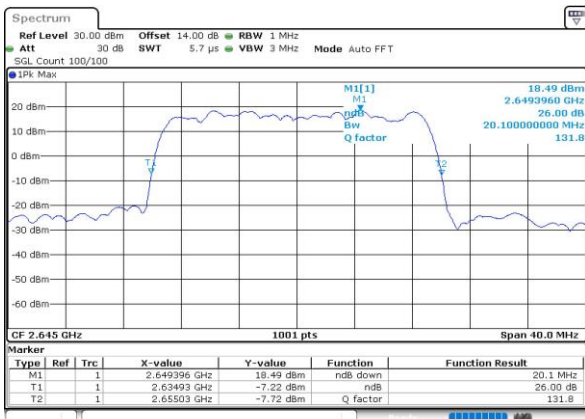

Date: 25_SEP.2018 15:02:53

Highest Channel / 20MHz / 16QAM

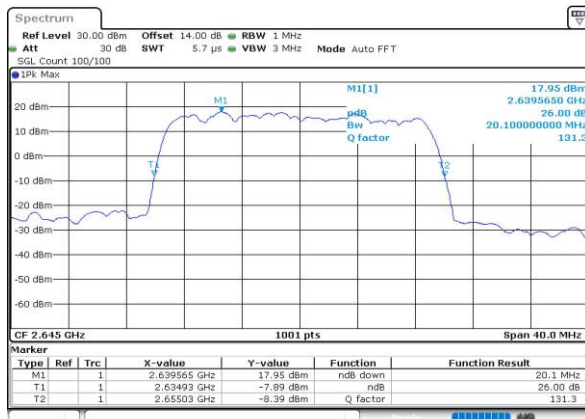

Date: 25_SEP.2018 15:03:05



Occupied Bandwidth

Mode BW	LTE Band 41 : 99%OBW(MHz)											
	1.4MHz		3MHz		5MHz		10MHz		15MHz		20MHz	
Mod.	QPSK	16QAM	QPSK	16QAM	QPSK	16QAM	QPSK	16QAM	QPSK	16QAM	QPSK	16QAM
Lowest CH	-	-	-	-	4.5	4.49	9.03	9.01	13.49	13.46	18.26	18.26
Middle CH	-	-	-	-	4.48	4.5	9.07	9.07	13.49	13.46	18.42	18.26
Highest CH	-	-	-	-	4.49	4.49	8.93	9.09	13.46	13.52	18.26	18.3



LTE Band 41

Lowest Channel / 5MHz / QPSK

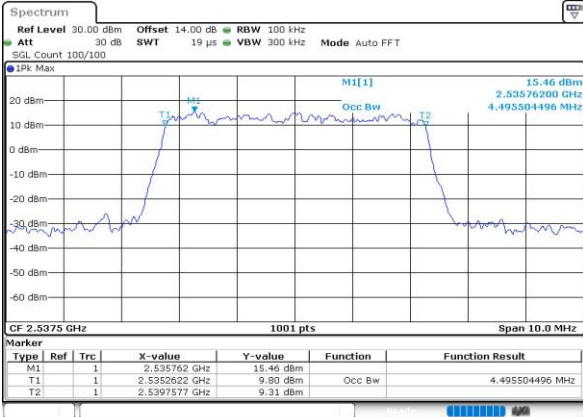

Date: 25.SEP.2018 14:54:05

Lowest Channel / 5MHz / 16QAM

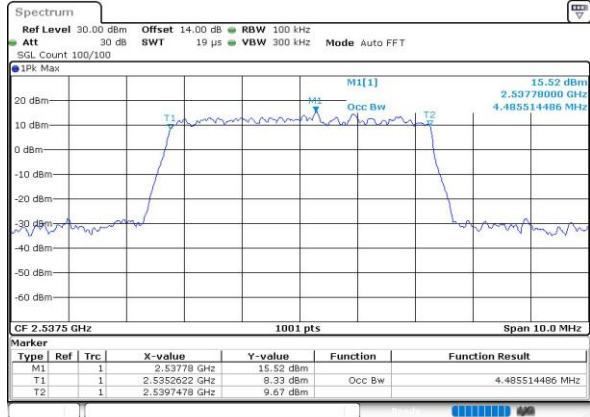

Date: 25.SEP.2018 14:54:17

Middle Channel / 5MHz / QPSK

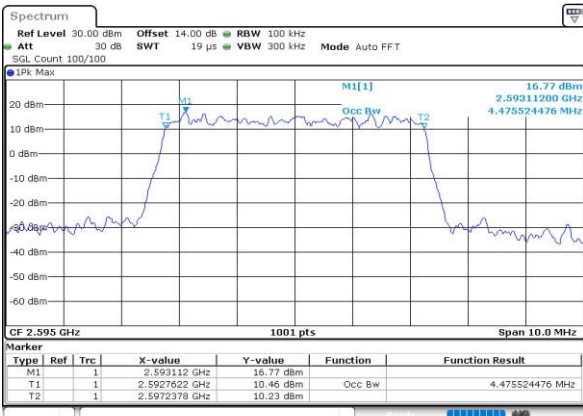

Date: 25.SEP.2018 14:54:51

Middle Channel / 5MHz / 16QAM

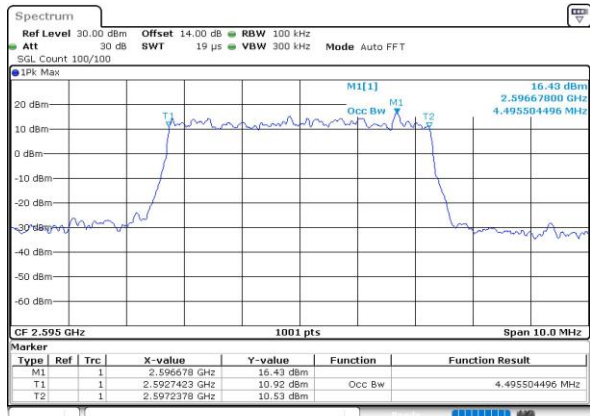

Date: 25.SEP.2018 14:55:03

Highest Channel / 5MHz / QPSK

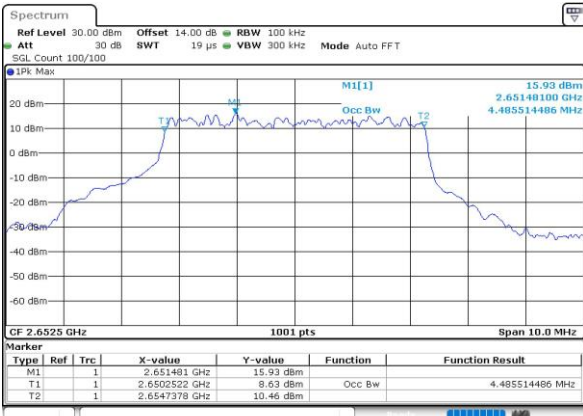

Date: 25.SEP.2018 14:55:37

Highest Channel / 5MHz / 16QAM

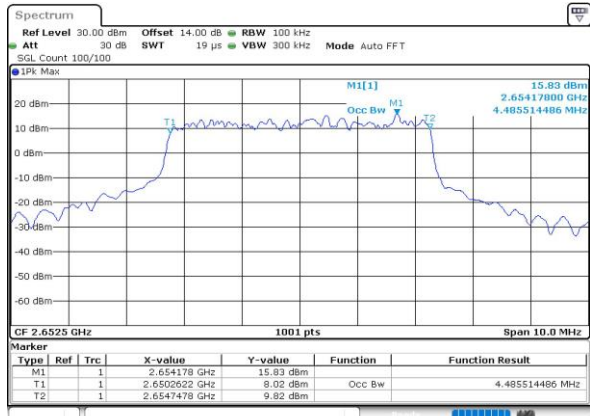

Date: 25.SEP.2018 14:55:49



LTE Band 41

Lowest Channel / 10MHz / QPSK

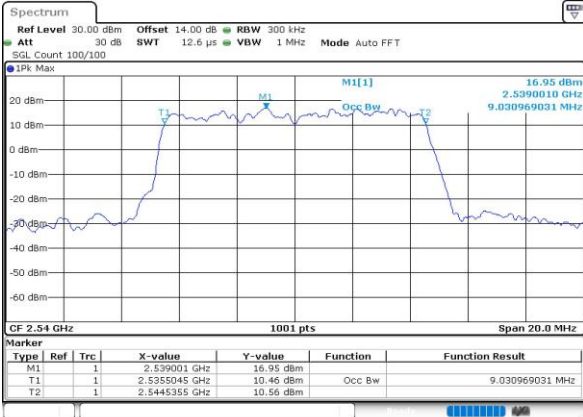

Date: 25_SEP.2018 14:56:23

Lowest Channel / 10MHz / 16QAM

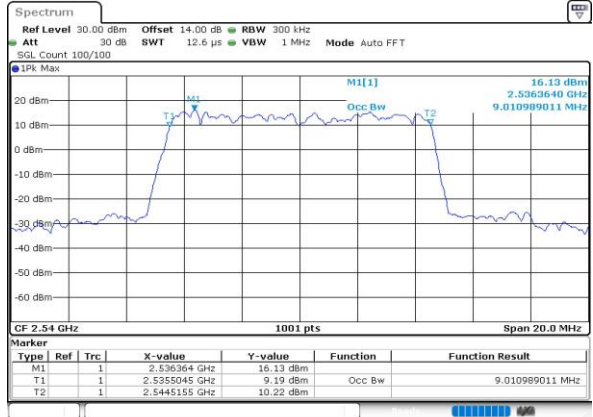

Date: 25_SEP.2018 14:56:35

Middle Channel / 10MHz / QPSK

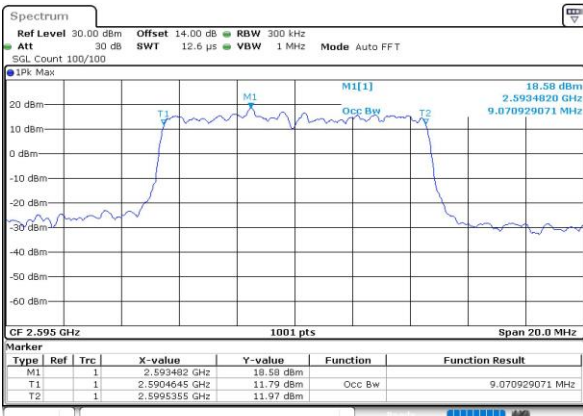

Date: 25_SEP.2018 14:57:09

Middle Channel / 10MHz / 16QAM

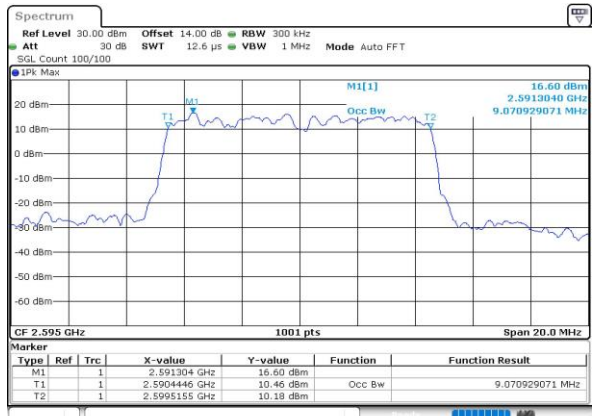

Date: 25_SEP.2018 14:57:121

Highest Channel / 10MHz / QPSK

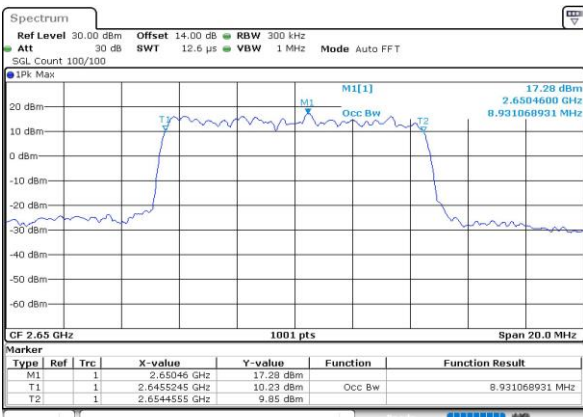

Date: 25_SEP.2018 14:57:55

Highest Channel / 10MHz / 16QAM

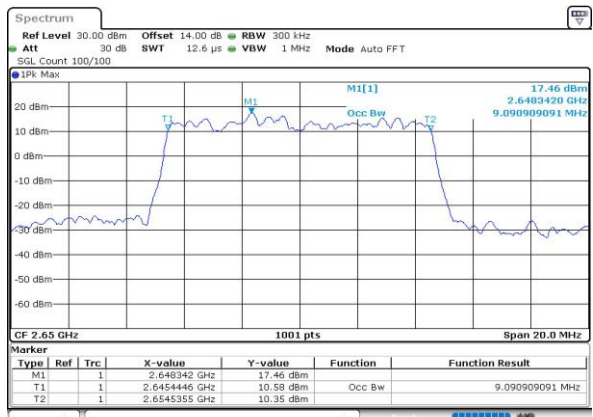

Date: 25_SEP.2018 14:58:106



LTE Band 41

Lowest Channel / 15MHz / QPSK

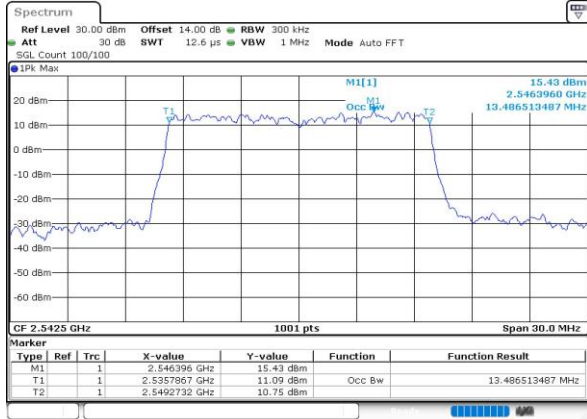

Date: 25_SEP.2018 14:58:41

Lowest Channel / 15MHz / 16QAM

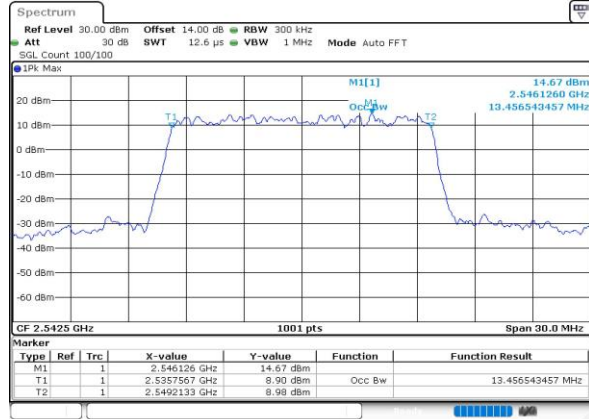

Date: 25_SEP.2018 14:58:52

Middle Channel / 15MHz / QPSK

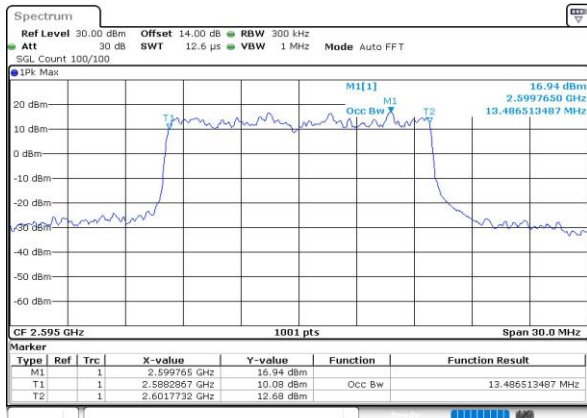

Date: 25_SEP.2018 14:59:27

Middle Channel / 15MHz / 16QAM

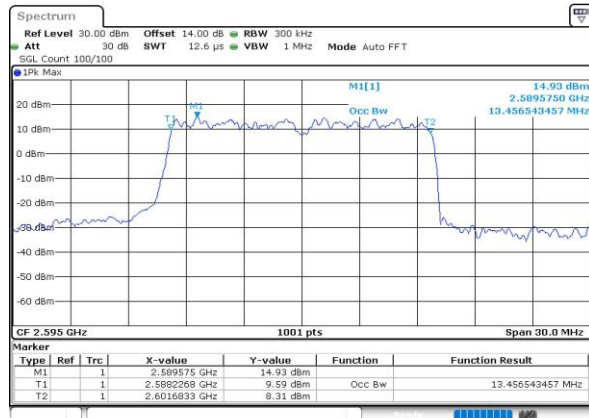

Date: 25_SEP.2018 14:59:38

Highest Channel / 15MHz / QPSK

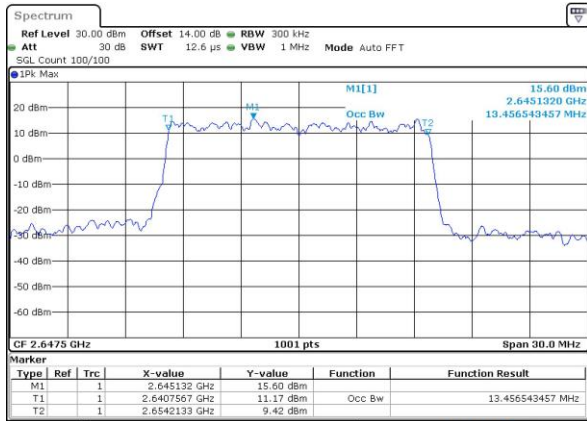

Date: 25_SEP.2018 15:00:13

Highest Channel / 15MHz / 16QAM

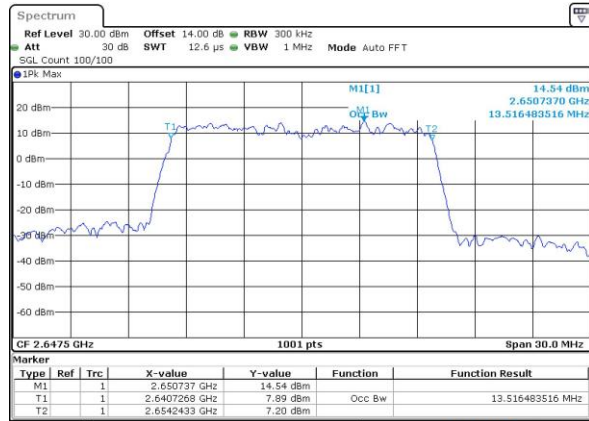

Date: 25_SEP.2018 15:00:24



LTE Band 41

Lowest Channel / 20MHz / QPSK

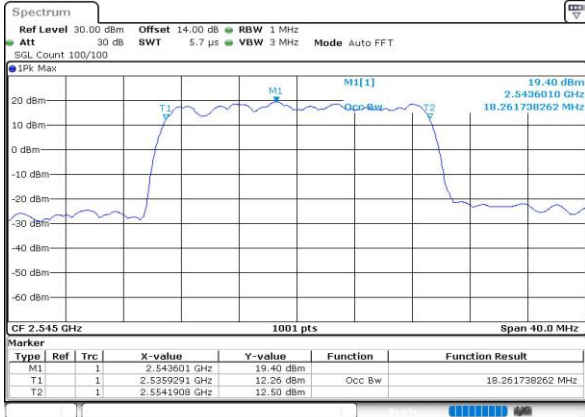

Date: 25.SEP.2018 15:00:58

Lowest Channel / 20MHz / 16QAM

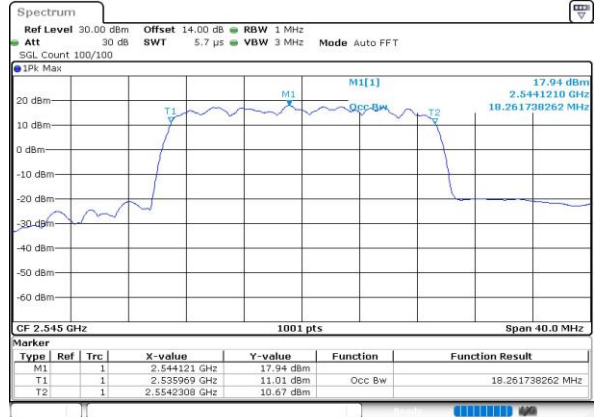

Date: 25.SEP.2018 15:01:10

Middle Channel / 20MHz / QPSK

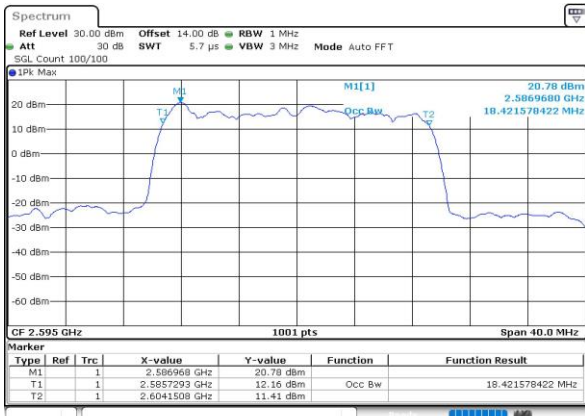

Date: 25.SEP.2018 15:01:44

Middle Channel / 20MHz / 16QAM

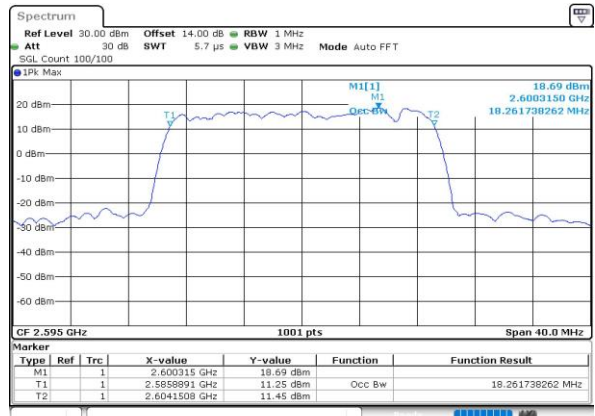

Date: 25.SEP.2018 15:01:56

Highest Channel / 20MHz / QPSK

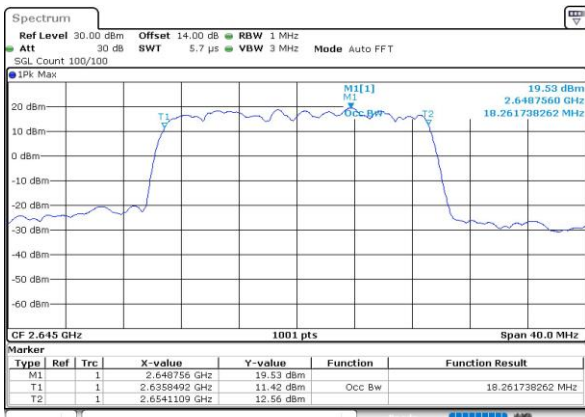

Date: 25.SEP.2018 15:02:30

Highest Channel / 20MHz / 16QAM

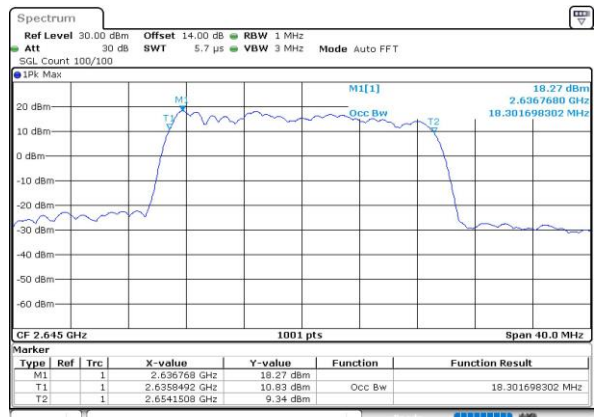

Date: 25.SEP.2018 15:02:42



Conducted Band Edge

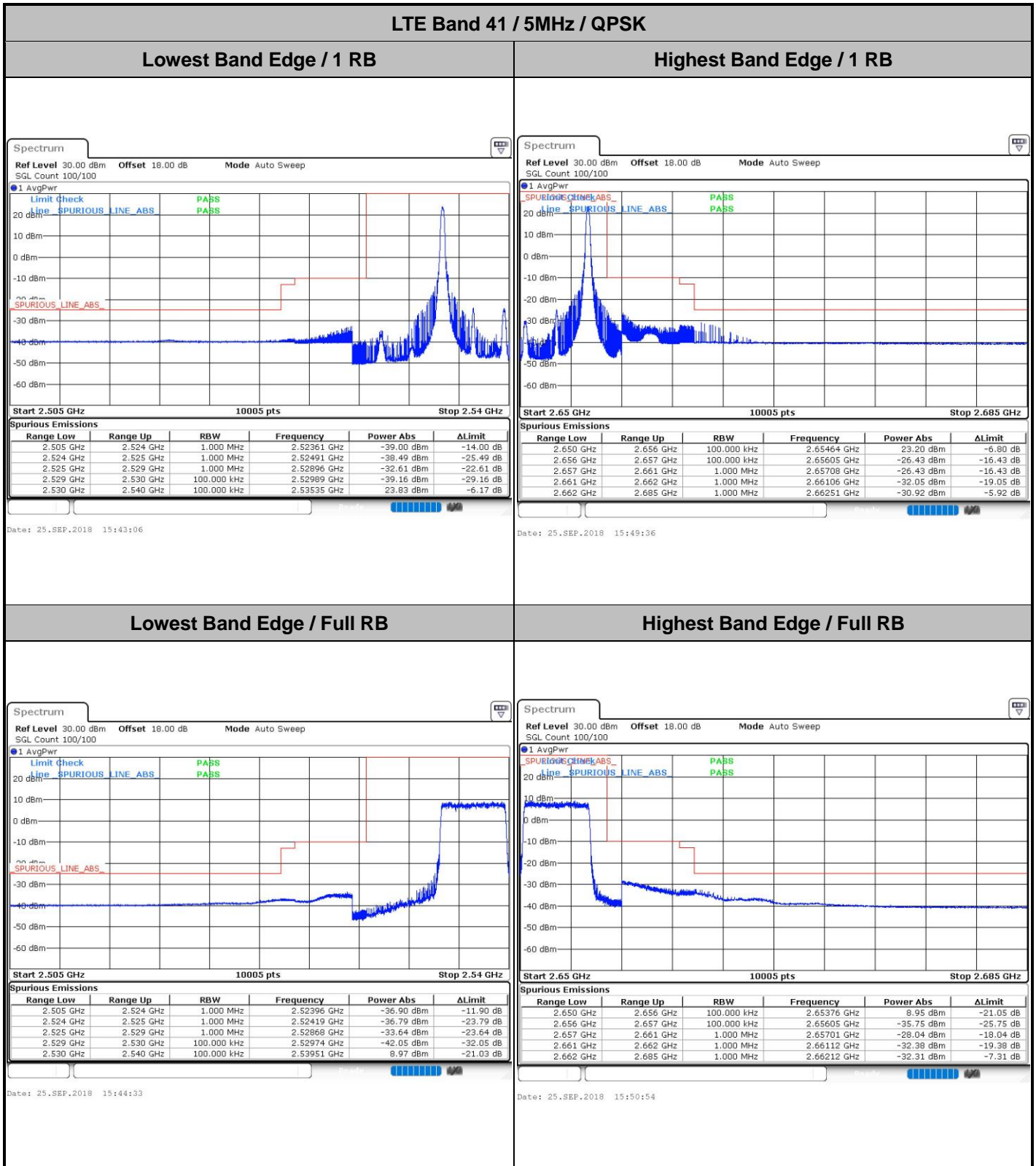



LTE Band 41 / 5MHz / 16QAM

Lowest Band Edge / 1RB

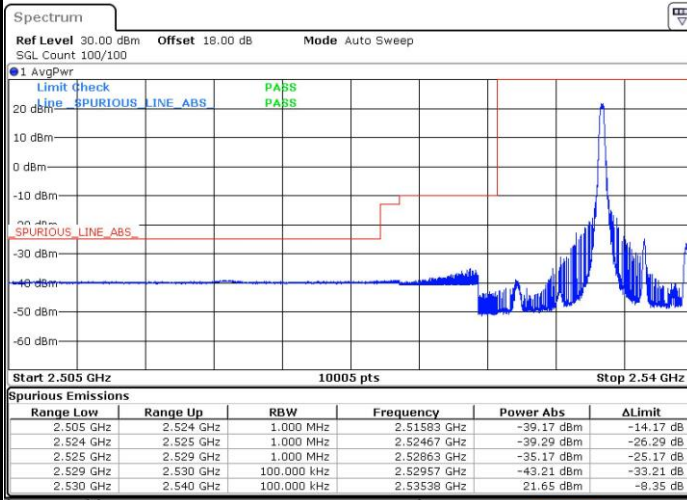

Date: 25_SEP.2018 15:43:50

Highest Band Edge / 1 RB

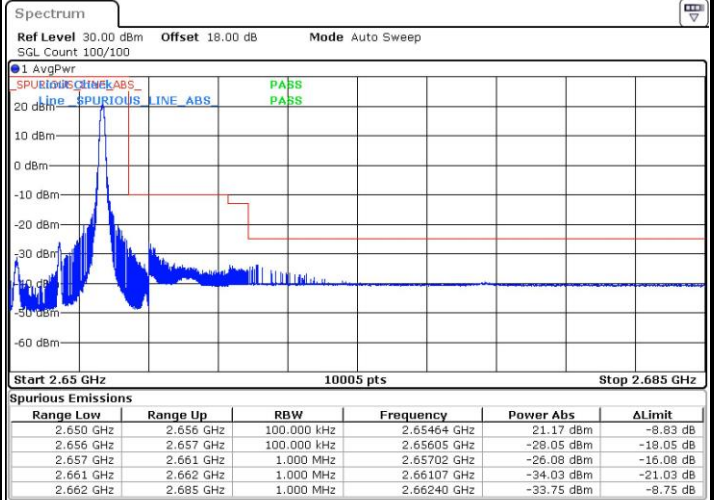

Date: 25_SEP.2018 15:50:15

Lowest Band Edge / Full RB

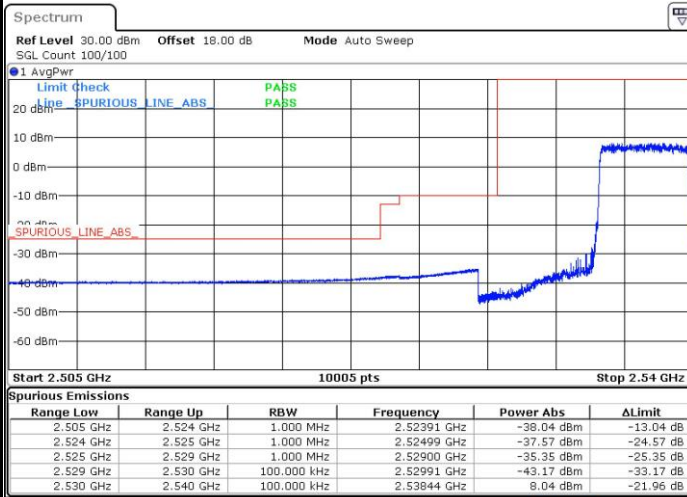

Date: 25_SEP.2018 15:45:17

Highest Band Edge / Full RB

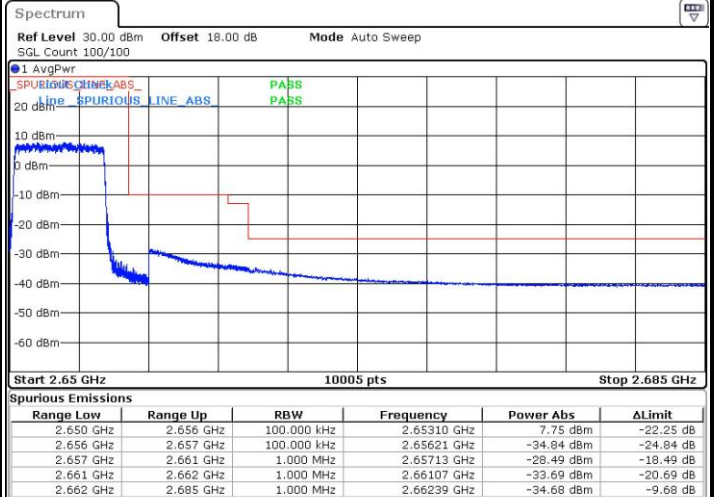

Date: 25_SEP.2018 15:51:33



LTE Band 41 / 10MHz / QPSK

Lowest Band Edge / 1 RB

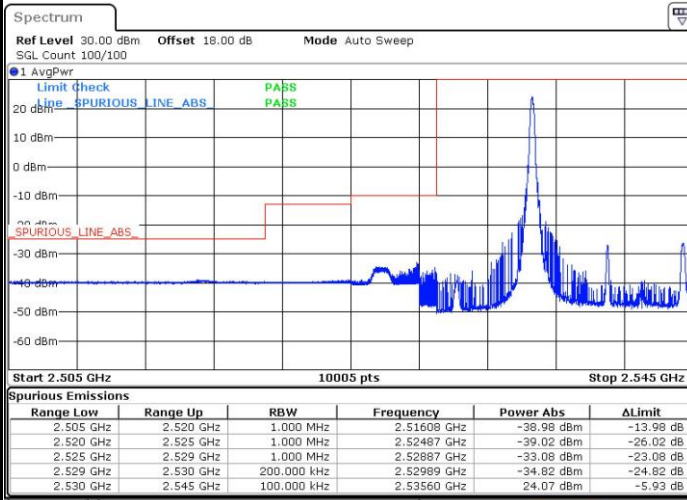

Date: 25_SEP.2018 15:54:07

Highest Band Edge / 1 RB

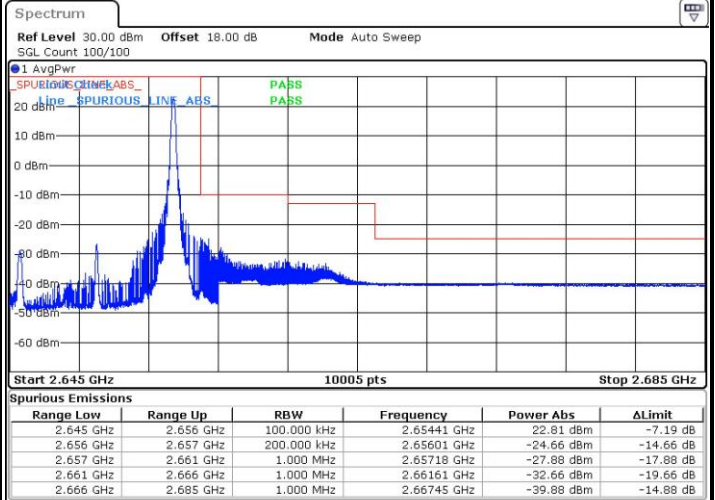

Date: 25_SEP.2018 16:00:41

Lowest Band Edge / Full RB

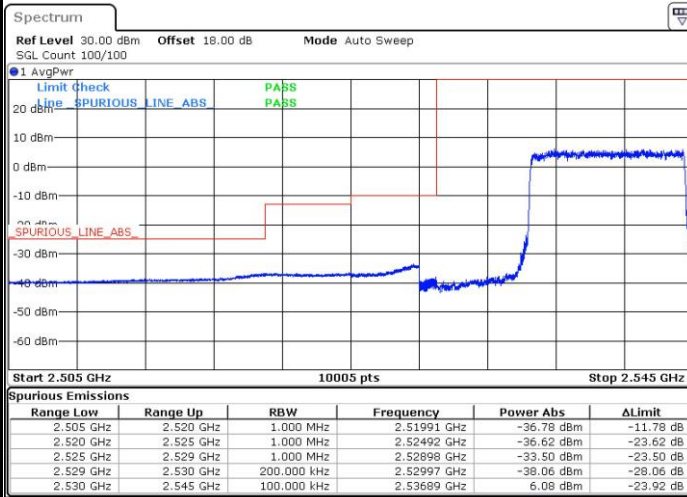

Date: 25_SEP.2018 15:55:37

Highest Band Edge / Full RB



Date: 25_SEP.2018 16:01:59



LTE Band 41 / 10MHz / 16QAM

Lowest Band Edge / 1 RB

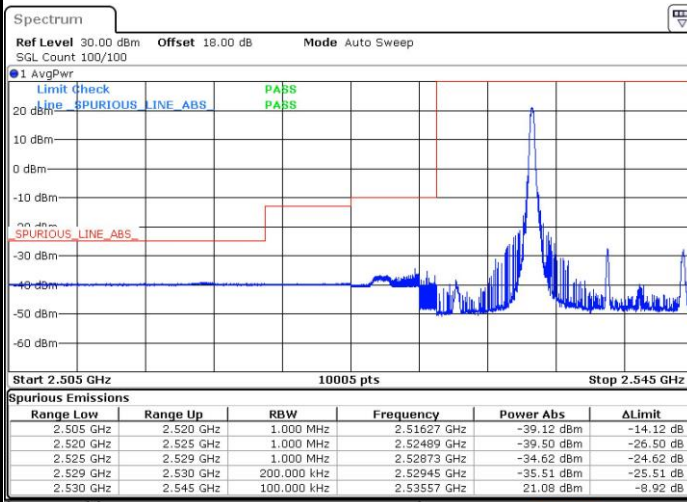

Date: 25_SEP.2018 15:54:52

Highest Band Edge / 1 RB

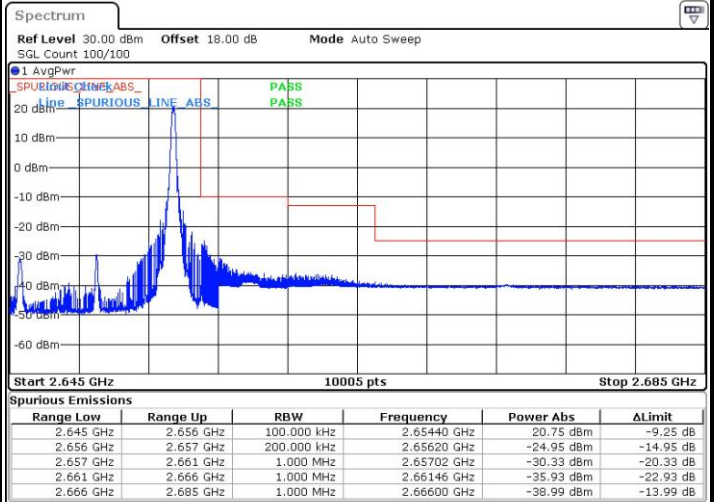

Date: 25_SEP.2018 16:01:20

Lowest Band Edge / Full RB

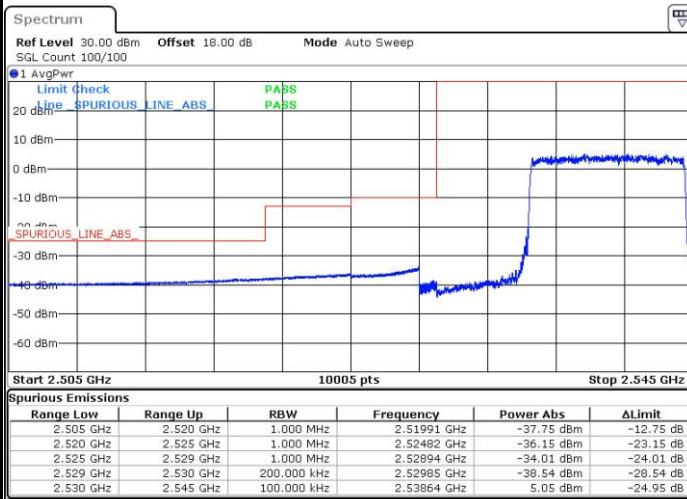

Date: 25_SEP.2018 15:56:21

Highest Band Edge / Full RB

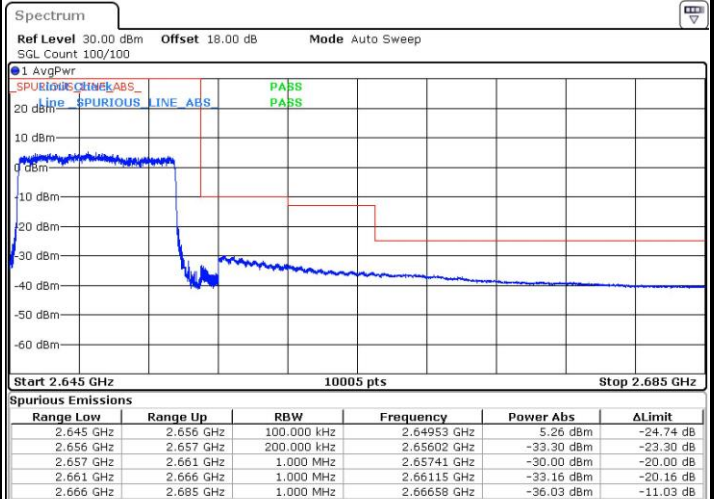

Date: 25_SEP.2018 16:02:39



LTE Band 41 / 15MHz / QPSK

Lowest Band Edge / 1 RB

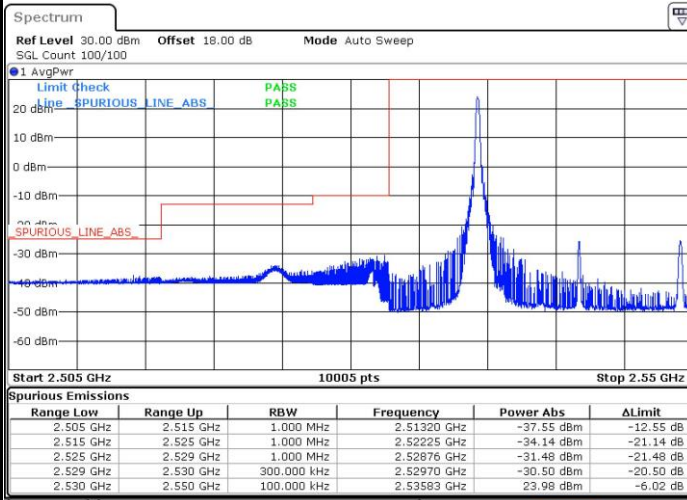

Date: 25_SEP.2018 16:05:13

Highest Band Edge / 1 RB

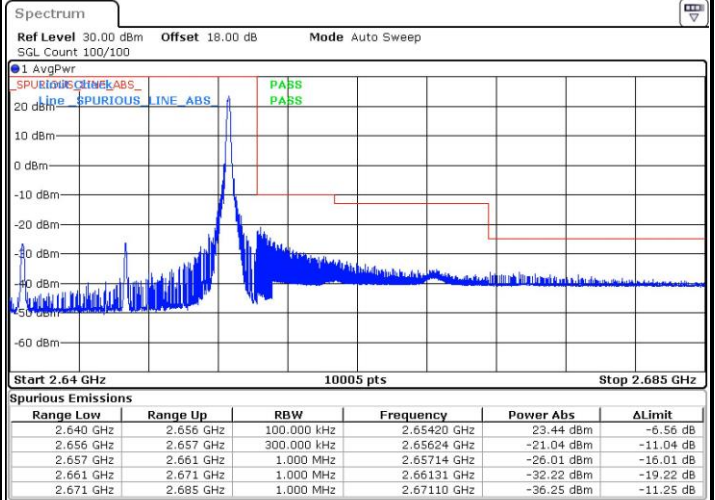

Date: 25_SEP.2018 16:11:46

Lowest Band Edge / Full RB

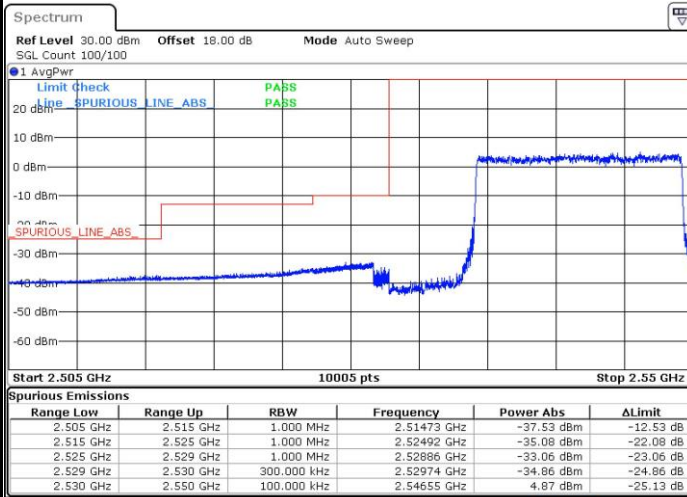

Date: 25_SEP.2018 16:06:42

Highest Band Edge / Full RB

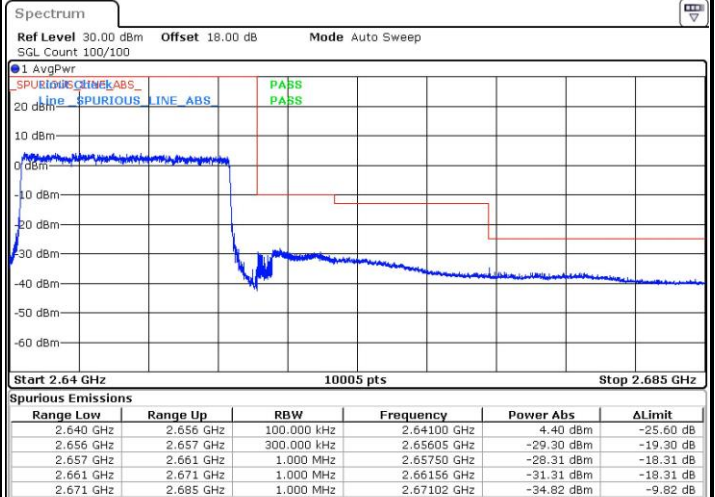

Date: 25_SEP.2018 16:13:04