



FCC RADIO TEST REPORT

FCC ID : IHDT56XP1
Equipment : Mobile Cellular Phone
Brand Name : Motorola
Model Name : XT1962-1
Applicant : Motorola Mobility LLC
222 W,Merchandise Mart Plaza, Chicago IL
60654 USA
Manufacturer : Motorola Mobility LLC
222 W,Merchandise Mart Plaza, Chicago IL
60654 USA
Standard : 47 CFR Part 2, 22(H), 24(E), 27

The product was received on Sep. 08, 2018 and testing was started from Sep. 21, 2018 and completed on Oct. 06, 2018. We, SPORTON INTERNATIONAL INC., would like to declare that the tested sample has been evaluated in accordance with the test procedures given in ANSI / TIA-603-E and has been in compliance with the applicable technical standards.

The report must not be used by the client to claim product certification, approval, or endorsement by TAF or any agency of government.

The test results in this report apply exclusively to the tested model / sample. Without written approval of SPORTON INTERNATIONAL INC. EMC & Wireless Communications Laboratory, the test report shall not be reproduced except in full.

Approved by: Joseph Lin

SPORTON INTERNATIONAL INC. EMC & Wireless Communications Laboratory

No. 52, Huaya 1st Rd., Guishan Dist., Taoyuan City, Taiwan (R.O.C.)



Table of Contents

History of this test report.....	3
Summary of Test Result.....	4
1 General Description	6
1.1 Product Feature of Equipment Under Test.....	6
1.2 Product Specification of Equipment Under Test.....	7
1.3 Modification of EUT	8
1.4 Emission Designator.....	9
1.5 Testing Location	12
1.6 Applicable Standards.....	12
2 Test Configuration of Equipment Under Test	13
2.1 Test Mode.....	13
2.2 Connection Diagram of Test System.....	17
2.3 Support Unit used in test configuration and system.....	18
2.4 Measurement Results Explanation Example.....	18
2.5 Frequency List of Low/Middle/High Channels.....	19
3 Conducted Test Items.....	24
3.1 Measuring Instruments	24
3.2 Conducted Output Power and ERP/EIRP	25
3.3 Peak-to-Average Ratio	26
3.4 Occupied Bandwidth.....	27
3.5 Conducted Band Edge	28
3.6 Conducted Spurious Emission	30
3.7 Frequency Stability	31
4 Radiated Test Items	32
4.1 Measuring Instruments	32
4.2 Radiated Spurious Emission	33
5 List of Measuring Equipment.....	34
6 Uncertainty of Evaluation.....	36
Appendix A. Test Results of Conducted Test	
Appendix B. Test Results of ERP/EIRP and Radiated Test	



Summary of Test Result

Report Clause	Ref Std. Clause	Test Items	Result (PASS/FAIL)	Remark
3.2	§2.1046	Conducted Output Power	Reporting only	-
	§22.913 (a)(2)	Effective Radiated Power (Band 5) (Band 26)	Pass	
	§27.50 (b)(10) §27.50 (c)(10)	Effective Radiated Power (Band 12) (Band 13) (Band 17)		
	§24.232 (c) §27.50 (h)(2)	Equivalent Isotropic Radiated Power (Band 2) (Band 25) (Band 7) (Band 38) (Band 41)		
	§27.50 (d)(4)	Equivalent Isotropic Radiated Power (Band 4) (Band 66)		
3.3	§24.232 (d) §27.50 (d)(5)	Peak-to-Average Ratio	Pass	-
3.4	§2.1049	Occupied Bandwidth	Reporting only	-
3.5	§2.1051 §22.917 (a) §24.238 (a) §27.53 (c)(2)(4) §27.53 (g) §27.53 (h)	Conducted Band Edge Measurement (Band 2) (Band 4) (Band 5) (Band 12) (Band 13) (Band 17) (Band 25) (Band 26) (Band 66)	Pass	-
	§2.1051 §27.53 (m)(4)	Conducted Band Edge Measurement (Band 7) (Band 38) (Band 41)		
3.6	§2.1051 §22.917 (a) §24.238 (a) §27.53 (c)(2) §27.53 (g) §27.53 (h)	Conducted Spurious Emission (Band 2) (Band 4) (Band 5) (Band 12) (Band 13) (Band 17) (Band 25) (Band 26) (Band 66)	Pass	-
	§2.1051 §27.53 (m)(4)	Conducted Spurious Emission (Band 7) (Band 38) (Band 41)		



Report Clause	Ref Std. Clause	Test Items	Result (PASS/FAIL)	Remark
3.7	§2.1055 §22.355 §24.235 §27.54	Frequency Stability Temperature & Voltage	Pass	-
4.2	§2.1053 §22.917 (a) §24.238 (a) §27.53 (c)(2) §27.53 (f) §27.53 (g) §27.53 (h)	Radiated Spurious Emission (Band 2) (Band 4) (Band 5) (Band 12) (Band 13) (Band 17) (Band 25) (Band 26) (Band 66)	Pass	Under limit 17.14 dB at 10740.000 MHz
	§2.1053 §27.53 (m)(4)	Radiated Spurious Emission (Band 7) (Band 38) (Band 41)		

Reviewed by: Wii Chang

Report Producer: Natasha Hsieh



1 General Description

1.1 Product Feature of Equipment Under Test

Product Feature	
Equipment	Mobile Cellular Phone
Brand Name	Motorola
Model Name	XT1962-1
FCC ID	IHDT56XP1
IMEI Code	Conducted : IMEI : 355569090014213 Radiation : IMEI : 355569090016853
EUT supports Radios application	CDMA/EV-DO/GSM/EGPRS/WCDMA/HSPA/LTE/GNSS/ FM WLAN 11b/g/n HT20 WLAN 11a/n HT20/HT40 Bluetooth BR/EDR/LE
HW Version	DVT1-B
EUT Stage	Identical Prototype

Remark: The above EUT's information was declared by manufacturer.

Accessory List	
AC Adapter 1	Brand Name : Motorola
	Model Name : SC-51
	Manufacturer : Salom
AC Adapter 2	Brand Name : Motorola
	Model Name : SC-51
	Manufacturer : Chenyang
Battery	Brand Name : Motorola
	Model Name : JG30
	Manufacturer : Amperex
Earphone	Brand Name : Motorola
	Model Name : SH38C37773
	Manufacturer : Lyand
USB Cable 1	Brand Name : Cabletech
	Model Name : SKN6473A
USB Cable 2	Brand Name : Saibao
	Model Name : SKN6473A
USB Cable 3	Brand Name : Luxshare
	Model Name : SKN6473A



1.2 Product Specification of Equipment Under Test

Standards-related Product Specification	
Tx Frequency	LTE Band 2: 1850.7 MHz ~ 1909.3 MHz LTE Band 4: 1710.7 MHz ~ 1754.3 MHz LTE Band 5: 824.7 MHz ~ 848.3 MHz LTE Band 7: 2502.5 MHz ~ 2567.5 MHz LTE Band 12: 699.7 MHz ~ 715.3 MHz LTE Band 13: 779.5 MHz ~ 784.5 MHz LTE Band 17: 706.5 MHz ~ 713.5 MHz LTE Band 25: 1850.7 MHz ~ 1914.3 MHz LTE Band 26: 814.7 MHz ~ 848.3 MHz LTE Band 38: 2572.5 MHz ~ 2617.5 MHz LTE Band 41: 2498.5 MHz ~ 2687.5 MHz LTE Band 66: 1710.7 MHz ~ 1779.3 MHz
Rx Frequency	LTE Band 2: 1930.7 MHz ~ 1989.3 MHz LTE Band 4: 2110.7 MHz ~ 2154.3 MHz LTE Band 5: 869.7 MHz ~ 893.3 MHz LTE Band 7: 2622.5 MHz ~ 2687.5 MHz LTE Band 12: 729.7 MHz ~ 745.3 MHz LTE Band 13: 748.5 MHz ~ 753.5 MHz LTE Band 17: 736.5 MHz ~ 743.5 MHz LTE Band 25: 1930.7 MHz ~ 1994.3 MHz LTE Band 26: 869.7 MHz ~ 893.3 MHz LTE Band 38: 2572.5 MHz ~ 2617.5 MHz LTE Band 41: 2498.5 MHz ~ 2687.5 MHz LTE Band 66: 2110.7 MHz ~ 2199.3 MHz
Bandwidth	LTE Band 2: 1.4MHz / 3MHz / 5MHz / 10MHz / 15MHz / 20MHz LTE Band 4: 1.4MHz / 3MHz / 5MHz / 10MHz / 15MHz / 20MHz LTE Band 5: 1.4MHz / 3MHz / 5MHz / 10MHz LTE Band 7: 5MHz / 10MHz / 15MHz / 20MHz LTE Band 12: 1.4MHz / 3MHz / 5MHz / 10MHz LTE Band 13: 5MHz / 10MHz LTE Band 17: 5MHz / 10MHz LTE Band 25: 1.4MHz / 3MHz / 5MHz / 10MHz / 15MHz / 20MHz LTE Band 26: 1.4MHz / 3MHz / 5MHz / 10MHz / 15MHz LTE Band 38: 5MHz / 10MHz / 15MHz / 20MHz LTE Band 41: 5MHz / 10MHz / 15MHz / 20MHz LTE Band 66: 1.4MHz / 3MHz / 5MHz / 10MHz / 15MHz / 20MHz



Standards-related Product Specification	
Maximum Output Power to Antenna	LTE Band 2: 22.46 dBm LTE Band 4: 22.95 dBm LTE Band 5: 23.19 dBm LTE Band 7: 23.14 dBm LTE Band 12: 23.32 dBm LTE Band 13: 23.19 dBm LTE Band 17: 23.20 dBm LTE Band 25: 22.74 dBm LTE Band 26: 23.32 dBm LTE Band 38: 23.81 dBm LTE Band 41: 26.43 dBm LTE Band 66: 22.92 dBm
Antenna Type	Fixed Internal Antenna and Dipole Antenna
Antenna Gain	<Main Antenna> LTE Band 2: 2.0 dBi LTE Band 4: 2.0 dBi LTE Band 5: 0.0 dBi LTE Band 12: 0.0 dBi LTE Band 13: 0.0 dBi LTE Band 17: 0.0 dBi LTE Band 25: 2.0 dBi LTE Band 26: 0.0 dBi LTE Band 66: 2.0 dBi <Aux. Antenna> LTE Band 7: 3.0 dBi LTE Band 38: 3.0 dBi LTE Band 41: 3.0 dBi
Type of Modulation	QPSK / 16QAM

1.3 Modification of EUT

No modifications are made to the EUT during all test items.



1.4 Emission Designator

LTE Band 2		QPSK			16QAM		
BW (MHz)	Frequency Range (MHz)	Emission Designator (99%OBW)	Frequency Tolerance (ppm)	Maximum EIRP(W)	Emission Designator (99%OBW)	Frequency Tolerance (ppm)	Maximum EIRP(W)
1.4	1850.7 ~ 1909.3	1M10G7D	-	0.2673	1M10W7D	-	0.2547
3	1851.5 ~ 1908.5	2M75G7D	-	0.2649	2M73W7D	-	0.2582
5	1852.5 ~ 1907.5	4M51G7D	-	0.2636	4M51W7D	-	0.2553
10	1855.0 ~ 1905.0	9M05G7D	0.0030	0.2704	9M01W7D	-	0.2489
15	1857.5 ~ 1902.5	13M5G7D	-	0.2793	13M5W7D	-	0.2667
20	1860.0 ~ 1900.0	18M5G7D	-	0.2661	18M5W7D	-	0.2594
LTE Band 25		QPSK			16QAM		
BW (MHz)	Frequency Range (MHz)	Emission Designator (99%OBW)	Frequency Tolerance (ppm)	Maximum EIRP(W)	Emission Designator (99%OBW)	Frequency Tolerance (ppm)	Maximum EIRP(W)
1.4	1850.7 ~ 1914.3	1M11G7D	-	0.2692	1M10W7D	-	0.2600
3	1851.5 ~ 1913.5	2M72G7D	-	0.2655	2M75W7D	-	0.2649
5	1852.5 ~ 1912.5	4M50G7D	-	0.2716	4M49W7D	-	0.2612
10	1855.0 ~ 1910.0	9M07G7D	0.0041	0.2729	9M03W7D	-	0.2495
15	1857.5 ~ 1907.5	13M5G7D	-	0.2979	13M5W7D	-	0.2780
20	1860.0 ~ 1905.0	18M4G7D	-	0.2729	18M4W7D	-	0.2588
LTE Band 4		QPSK			16QAM		
BW (MHz)	Frequency Range (MHz)	Emission Designator (99%OBW)	Frequency Tolerance (ppm)	Maximum EIRP(W)	Emission Designator (99%OBW)	Frequency Tolerance (ppm)	Maximum EIRP(W)
1.4	1710.7 ~ 1754.3	1M09G7D	-	0.3097	1M09W7D	-	0.2972
3	1711.5 ~ 1753.5	2M73G7D	-	0.3105	2M72W7D	-	0.2944
5	1712.5 ~ 1752.5	4M51G7D	-	0.3112	4M50W7D	-	0.3041
10	1715.0 ~ 1750.0	9M03G7D	0.0020	0.3013	9M01W7D	-	0.2851
15	1717.5 ~ 1747.5	13M5G7D	-	0.2992	13M5W7D	-	0.3083
20	1720.0 ~ 1745.0	18M5G7D	-	0.3126	18M4W7D	-	0.2958
LTE Band 5		QPSK			16QAM		
BW (MHz)	Frequency Range (MHz)	Emission Designator (99%OBW)	Frequency Tolerance (ppm)	Maximum ERP(W)	Emission Designator (99%OBW)	Frequency Tolerance (ppm)	Maximum ERP(W)
1.4	824.7 ~ 848.3	1M09G7D	-	0.1256	1M09W7D	-	0.1062
3	825.5 ~ 847.5	2M72G7D	-	0.1259	2M73W7D	-	0.1057
5	826.5 ~ 846.5	4M50G7D	-	0.1250	4M51W7D	-	0.1067
10	829.0 ~ 844.0	9M05G7D	0.0085	0.1271	9M03W7D	-	0.1030



LTE Band 7		QPSK			16QAM		
BW (MHz)	Frequency Range (MHz)	Emission Designator (99%OBW)	Frequency Tolerance (ppm)	Maximum EIRP(W)	Emission Designator (99%OBW)	Frequency Tolerance (ppm)	Maximum EIRP(W)
5	2502.5 ~ 2567.5	4M49G7D	-	0.4055	4M51W7D	-	0.3428
10	2505.0 ~ 2565.0	9M07G7D	0.0041	0.4093	9M03W7D	-	0.3388
15	2507.5 ~ 2562.5	13M5G7D	-	0.4046	13M5W7D	-	0.3750
20	2510.0 ~ 2560.0	18M4G7D	-	0.4111	18M4W7D	-	0.3459
LTE Band 12		QPSK			16QAM		
BW (MHz)	Frequency Range (MHz)	Emission Designator (99%OBW)	Frequency Tolerance (ppm)	Maximum ERP(W)	Emission Designator (99%OBW)	Frequency Tolerance (ppm)	Maximum ERP(W)
1.4	699.7 ~ 715.3	1M10G7D	-	0.1300	1M09W7D	-	0.1112
3	700.5 ~ 714.5	2M72G7D	-	0.1271	2M73W7D	-	0.1114
5	701.5 ~ 713.5	4M50G7D	-	0.1282	4M50W7D	-	0.1081
10	704.0 ~ 711.0	9M07G7D	0.0141	0.1309	9M03W7D	-	0.1057
LTE Band 13		QPSK			16QAM		
BW (MHz)	Frequency Range (MHz)	Emission Designator (99%OBW)	Frequency Tolerance (ppm)	Maximum ERP(W)	Emission Designator (99%OBW)	Frequency Tolerance (ppm)	Maximum ERP(W)
5	779.5 ~ 784.5	4M50G7D	-	0.1271	4M51W7D	-	0.1081
10	782.0	9M03G7D	0.0128	0.1194	9M03W7D	-	0.1081
LTE Band 17		QPSK			16QAM		
BW (MHz)	Frequency Range (MHz)	Emission Designator (99%OBW)	Frequency Tolerance (ppm)	Maximum ERP(W)	Emission Designator (99%OBW)	Frequency Tolerance (ppm)	Maximum ERP(W)
5	706.5 ~ 713.5	4M51G7D	-	0.1268	4M50W7D	-	0.1091
10	709.0 ~ 711.0	9M05G7D	0.0079	0.1274	9M03W7D	-	0.1074
LTE Band 26		QPSK			16QAM		
BW (MHz)	Frequency Range (MHz)	Emission Designator (99%OBW)	Frequency Tolerance (ppm)	Maximum ERP(W)	Emission Designator (99%OBW)	Frequency Tolerance (ppm)	Maximum ERP(W)
1.4	824.7~848.3	1M09G7D	-	0.1199	1M10W7D	-	0.1156
3	825.5~847.5	2M74G7D	-	0.1259	2M74W7D	-	0.1057
5	826.5~846.5	4M50G7D	-	0.1262	4M50W7D	-	0.1052
10	829.0~844.0	9M01G7D	0.0077	0.1259	9M05W7D	-	0.1062
15	831.5~841.5	13M5G7D	-	0.1309	13M5W7D	-	0.1086



LTE Band 38		QPSK			16QAM		
BW (MHz)	Frequency Range (MHz)	Emission Designator (99%OBW)	Frequency Tolerance (ppm)	Maximum EIRP(W)	Emission Designator (99%OBW)	Frequency Tolerance (ppm)	Maximum EIRP(W)
5	2572.5~2617.5	4M49G7D	-	0.4581	4M50W7D	-	0.3589
10	2575.0~2615.0	9M09G7D	0.0042	0.4797	9M01W7D	-	0.3540
15	2577.5~2612.5	13M5G7D	-	0.4786	13M6W7D	-	0.3864
20	2580.0~2610.0	18M4G7D	-	0.4667	18M5W7D	-	0.3828
LTE Band 41		QPSK			16QAM		
BW (MHz)	Frequency Range (MHz)	Emission Designator (99%OBW)	Frequency Tolerance (ppm)	Maximum EIRP(W)	Emission Designator (99%OBW)	Frequency Tolerance (ppm)	Maximum EIRP(W)
5	2498.5~2687.5	4M51G7D	-	0.8492	4M50W7D	-	0.7244
10	2501.0~2685.0	9M07G7D	0.0030	0.8770	9M07W7D	-	0.7063
15	2503.5~2682.5	13M6G7D	-	0.8670	13M5W7D	-	0.7870
20	2506.0~2680.0	18M4G7D	-	0.8670	18M4W7D	-	0.7311
LTE Band 66		QPSK			16QAM		
BW (MHz)	Frequency Range (MHz)	Emission Designator (99%OBW)	Frequency Tolerance (ppm)	Maximum EIRP(W)	Emission Designator (99%OBW)	Frequency Tolerance (ppm)	Maximum EIRP(W)
1.4	1710.7 ~ 1779.3	1M09G7D	-	0.3006	1M10W7D	-	0.2812
3	1711.5 ~ 1778.5	2M72G7D	-	0.3055	2M73W7D	-	0.2799
5	1712.5 ~ 1777.5	4M52G7D	-	0.2904	4M50W7D	-	0.2818
10	1715.0 ~ 1775.0	9M07G7D	0.0052	0.2924	9M07W7D	-	0.2884
15	1717.5 ~ 1772.5	13M5G7D	-	0.3090	13M5W7D	-	0.3055
20	1720.0 ~ 1770.0	18M4G7D	-	0.3105	18M5W7D	-	0.3090



1.5 Testing Location

Sporton Lab is accredited to ISO 17025 by Taiwan Accreditation Foundation (TAF code : 1190) and the FCC designation No. TW1190 and TW0007 under the FCC 2.948(e) by Mutual Recognition Agreement (MRA) in FCC Test.

Test Site	SPORTON INTERNATIONAL INC.
Test Site Location	No.52, Huaya 1st Rd., Guishan Dist., Taoyuan City, Taiwan (R.O.C.) TEL: +886-3-327-3456 FAX: +886-3-328-4978
Test Site No.	Sporton Site No.
	TH05-HY

Note: The test site complies with ANSI C63.4 2014 requirement.

Test Site	SPORTON INTERNATIONAL INC.
Test Site Location	No.58, Aly. 75, Ln. 564, Wenhua 3rd, Rd., Guishan Dist., Taoyuan City, Taiwan (R.O.C.) TEL: +886-3-327-0868 FAX: +886-3-327-0855
Test Site No.	Sporton Site No.
	03CH15-HY

Note: The test site complies with ANSI C63.4 2014 requirement.

1.6 Applicable Standards

According to the specifications of the manufacturer, the EUT must comply with the requirements of the following standards:

- ♦ ANSI C63.26-2015
- ♦ ANSI / TIA-603-E
- ♦ 47 CFR Part 2, 22(H), 24(E), 27
- ♦ FCC KDB 971168 D01 Power Meas. License Digital Systems v03r01
- ♦ FCC KDB 412172 D01 Determining ERP and EIRP v01r01

Remark:

1. All test items were verified and recorded according to the standards and without any deviation during the test.
2. This EUT has also been tested and complied with the requirements of FCC Part 15, Subpart B, recorded in a separate test report.



2 Test Configuration of Equipment Under Test

2.1 Test Mode

Antenna port conducted and radiated test items listed below are performed according to KDB 971168 D01 Power Meas. License Digital Systems v03r01 with maximum output power.

For radiated measurement, pre-scanned in three orthogonal panels, X, Y, Z. The worst cases (X plane for Band 12 and 38, Y plan for Band 7, 13, and 17, Z plan for Band 2, 4, 5, 25, 26, 41, and 66) were recorded in this report.

Test Items	Band	Bandwidth (MHz)						Modulation			RB #			Test Channel		
		1.4	3	5	10	15	20	QPSK	16QAM	64QAM	1	Half	Full	L	M	H
Max. Output Power	2	v	v	v	v	v	v	v	v		v	v	v	v	v	v
	4	v	v	v	v	v	v	v	v		v	v	v	v	v	v
	5	v	v	v	v	-	-	v	v		v	v	v	v	v	v
	7	-	-	v	v	v	v	v	v		v	v	v	v	v	v
	12	v	v	v	v	-	-	v	v		v	v	v	v	v	v
	13	-	-	v	v	-	-	v	v		v	v	v	v	v	v
	17	-	-	v	v	-	-	v	v		v	v	v	v	v	v
	25	v	v	v	v	v	v	v	v		v	v	v	v	v	v
	26	v	v	v	v	v	-	v	v		v	v	v	v	v	v
	38	-	-	v	v	v	v	v	v		v	v	v	v	v	v
	41	-	-	v	v	v	v	v	v		v	v	v	v	v	v
	66	v	v	v	v	v	v	v	v		v	v	v	v	v	v
Peak-to-Average Ratio	2						v	v	v		v		v	v	v	v
	4						v	v	v		v		v	v	v	v
	5				v	-	-	v	v		v		v	v	v	v
	7	-	-				v	v	v		v		v	v	v	v
	12				v	-	-	v	v		v		v	v	v	v
	13	-	-		v	-	-	v	v		v		v	v	v	v
	17	-	-		v	-	-	v	v		v		v	v	v	v
	25						v	v	v		v		v	v	v	v
	26					v	-	v	v		v		v	v	v	v
	38	-	-				v	v	v		v		v	v	v	v
	41	-	-				v	v	v		v		v	v	v	v
	66						v	v	v		v		v	v	v	v



Test Items	Band	Bandwidth (MHz)						Modulation			RB #			Test Channel		
		1.4	3	5	10	15	20	QPSK	16QAM	64QAM	1	Half	Full	L	M	H
26dB and 99% Bandwidth	2	v	v	v	v	v	v	v	v				v	v	v	v
	4	v	v	v	v	v	v	v	v				v	v	v	v
	5	v	v	v	v	-	-	v	v				v	v	v	v
	7	-	-	v	v	v	v	v	v				v	v	v	v
	12	v	v	v	v	-	-	v	v				v	v	v	v
	13	-	-	v	v	-	-	v	v				v	v	v	v
	17	-	-	v	v	-	-	v	v				v	v	v	v
	25	v	v	v	v	v	v	v	v				v	v	v	v
	26	v	v	v	v	v	-	v	v				v	v	v	v
	38	-	-	v	v	v	v	v	v				v	v	v	v
	41	-	-	v	v	v	v	v	v				v	v	v	v
66	v	v	v	v	v	v	v	v				v	v	v	v	
Conducted Band Edge	2	v	v	v	v	v	v	v	v		v		v	v		v
	4	v	v	v	v	v	v	v	v		v		v	v		v
	5	v	v	v	v	-	-	v	v		v		v	v		v
	7	-	-	v	v	v	v	v	v		v		v	v		v
	12	v	v	v	v	-	-	v	v		v		v	v		v
	13	-	-	v	v	-	-	v	v		v		v	v		v
	17	-	-	v	v	-	-	v	v		v		v	v		v
	25	v	v	v	v	v	v	v	v		v		v	v		v
	26	v	v	v	v	v	-	v	v		v		v	v		v
	38	-	-	v	v	v	v	v	v		v		v	v		v
	41	-	-	v	v	v	v	v	v		v		v	v		v
66	v	v	v	v	v	v	v	v		v		v	v		v	



Test Items	Band	Bandwidth (MHz)						Modulation			RB #			Test Channel		
		1.4	3	5	10	15	20	QPSK	16QAM	64QAM	1	Half	Full	L	M	H
Conducted Spurious Emission	2	v	v	v	v	v	v	v	v		v			v	v	v
	4	v	v	v	v	v	v	v	v		v			v	v	v
	5	v	v	v	v	-	-	v	v		v			v	v	v
	7	-	-	v	v	v	v	v	v		v			v	v	v
	12	v	v	v	v	-	-	v	v		v			v	v	v
	13	-	-	v	v	-	-	v	v		v			v	v	v
	17	-	-	v	v	-	-	v	v		v			v	v	v
	25	v	v	v	v	v	v	v	v		v			v	v	v
	26	v	v	v	v	v	-	v	v		v			v	v	v
	38	-	-	v	v	v	v	v	v		v			v	v	v
	41	-	-	v	v	v	v	v	v		v			v	v	v
	66	v	v	v	v	v	v	v	v		v			v	v	v
Frequency Stability	2				v			v					v		v	
	4				v			v					v		v	
	5				v	-	-	v					v		v	
	7	-	-		v			v					v		v	
	12				v	-	-	v					v		v	
	13	-	-		v	-	-	v					v		v	
	17	-	-		v	-	-	v					v		v	
	25				v			v					v		v	
	26				v		-	v					v		v	
	38	-	-		v			v					v		v	
	41	-	-		v			v					v		v	
	66				v			v					v		v	



Test Items	Band	Bandwidth (MHz)						Modulation			RB #			Test Channel		
		1.4	3	5	10	15	20	QPSK	16QAM	64QAM	1	Half	Full	L	M	H
E.R.P / E.I.R.P	2	v	v	v	v	v	v	v	v		v			v	v	v
	4	v	v	v	v	v	v	v	v		v			v	v	v
	5	v	v	v	v	-	-	v	v		v			v	v	v
	7	-	-	v	v	v	v	v	v		v			v	v	v
	12	v	v	v	v	-	-	v	v		v			v	v	v
	13	-	-	v	v	-	-	v	v		v			v	v	v
	17	-	-	v	v	-	-	v	v		v			v	v	v
	25	v	v	v	v	v	v	v	v		v			v	v	v
	26	v	v	v	v	v	-	v	v		v			v	v	v
	38	-	-	v	v	v	v	v	v		v			v	v	v
	41	-	-	v	v	v	v	v	v		v			v	v	v
66	v	v	v	v	v	v	v	v		v			v	v	v	
Radiated Spurious Emission	2	Worst Case											v	v	v	
	4	Worst Case											v	v	v	
	5	Worst Case											v	v	v	
	7	Worst Case											v	v	v	
	12	Worst Case											v	v	v	
	13	Worst Case											v	v	v	
	17	Worst Case											v	v	v	
	25	Worst Case											v	v	v	
	26	Worst Case											v	v	v	
	38	Worst Case											v	v	v	
	41	Worst Case											v	v	v	
66	Worst Case											v	v	v		
Remark	<ol style="list-style-type: none"> The mark "v" means that this configuration is chosen for testing The mark "-" means that this bandwidth is not supported. The device is investigated from 30MHz to 10 times of fundamental signal for radiated spurious emission test under different RB size/offset and modulations in exploratory test. Subsequently, only the worst case emissions are reported. All the radiated test cases were performed with Adapter 1 and USB Cable 1. 															

2.2 Connection Diagram of Test System

<EUT without Accessory Mode>

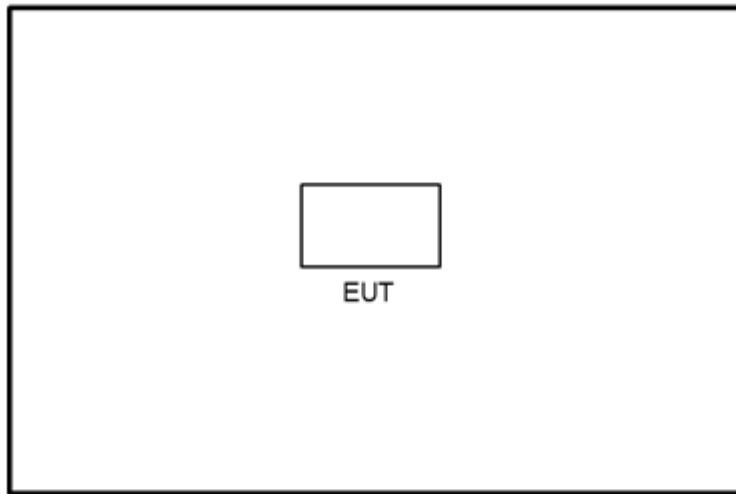

<EUT with Accessory Mode>

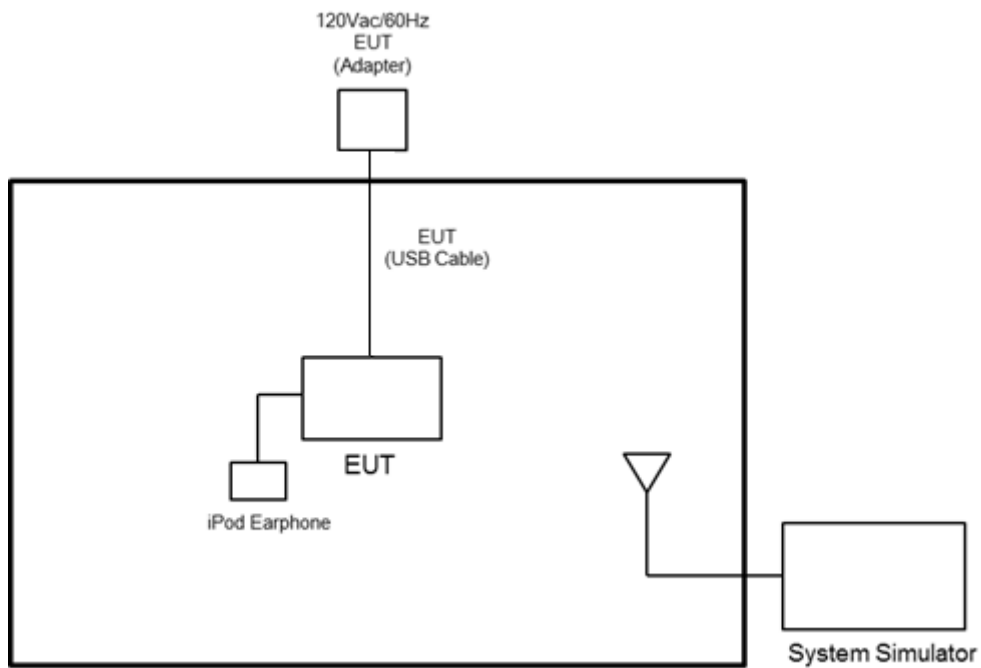



2.3 Support Unit used in test configuration and system

Item	Equipment	Trade Name	Model No.	FCC ID	Data Cable	Power Cord
1.	LTE Base Station	Anritsu	MT8820C	N/A	N/A	Unshielded, 1.8 m

2.4 Measurement Results Explanation Example

For all conducted test items:

The offset level is set in the spectrum analyzer to compensate the RF cable loss and attenuator factor between EUT conducted output port and spectrum analyzer. With the offset compensation, the spectrum analyzer reading level is exactly the EUT RF output level.

The spectrum analyzer offset is derived from RF cable loss and attenuator factor.

$$\text{Offset} = \text{RF cable loss} + \text{attenuator factor}.$$

Following shows an offset computation example with cable loss 4.2 dB and 10dB attenuator.

Example :

$$\begin{aligned} \text{Offset(dB)} &= \text{RF cable loss(dB)} + \text{attenuator factor(dB)}. \\ &= 4.2 + 10 = 14.2 \text{ (dB)} \end{aligned}$$



2.5 Frequency List of Low/Middle/High Channels

LTE Band 2 Channel and Frequency List				
BW [MHz]	Channel/Frequency(MHz)	Lowest	Middle	Highest
20	Channel	18700	18900	19100
	Frequency	1860.0	1880.0	1900.0
15	Channel	18675	18900	19125
	Frequency	1857.5	1880.0	1902.5
10	Channel	18650	18900	19150
	Frequency	1855.0	1880.0	1905.0
5	Channel	18625	18900	19175
	Frequency	1852.5	1880.0	1907.5
3	Channel	18615	18900	19185
	Frequency	1851.5	1880.0	1908.5
1.4	Channel	18607	18900	19193
	Frequency	1850.7	1880.0	1909.3

LTE Band 4 Channel and Frequency List				
BW [MHz]	Channel/Frequency(MHz)	Lowest	Middle	Highest
20	Channel	20050	20175	20300
	Frequency	1720.0	1732.5	1745.0
15	Channel	20025	20175	20325
	Frequency	1717.5	1732.5	1747.5
10	Channel	20000	20175	20350
	Frequency	1715.0	1732.5	1750.0
5	Channel	19975	20175	20375
	Frequency	1712.5	1732.5	1752.5
3	Channel	19965	20175	20385
	Frequency	1711.5	1732.5	1753.5
1.4	Channel	19957	20175	20393
	Frequency	1710.7	1732.5	1754.3



LTE Band 5 Channel and Frequency List				
BW [MHz]	Channel/Frequency(MHz)	Lowest	Middle	Highest
10	Channel	20450	20525	20600
	Frequency	829.0	836.5	844.0
5	Channel	20425	20525	20625
	Frequency	826.5	836.5	846.5
3	Channel	20415	20525	20635
	Frequency	825.5	836.5	847.5
1.4	Channel	20407	20525	20643
	Frequency	824.7	836.5	848.3

LTE Band 7 Channel and Frequency List				
BW [MHz]	Channel/Frequency(MHz)	Lowest	Middle	Highest
20	Channel	20850	21100	21350
	Frequency	2510.0	2535.0	2560.0
15	Channel	20825	21100	21375
	Frequency	2507.5	2535.0	2562.5
10	Channel	20800	21100	21400
	Frequency	2505.0	2535.0	2565.0
5	Channel	20775	21100	21425
	Frequency	2502.5	2535.0	2567.5

LTE Band 12 Channel and Frequency List				
BW [MHz]	Channel/Frequency(MHz)	Lowest	Middle	Highest
10	Channel	23060	23095	23130
	Frequency	704.0	707.5	711.0
5	Channel	23035	23095	23155
	Frequency	701.5	707.5	713.5
3	Channel	23025	23095	23165
	Frequency	700.5	707.5	714.5
1.4	Channel	23017	23095	23173
	Frequency	699.7	707.5	715.3



LTE Band 13 Channel and Frequency List				
BW [MHz]	Channel/Frequency(MHz)	Lowest	Middle	Highest
10	Channel	-	23230	-
	Frequency	-	782.0	-
5	Channel	23205	23230	23255
	Frequency	779.5	782.0	784.5

LTE Band 17 Channel and Frequency List				
BW [MHz]	Channel/Frequency(MHz)	Lowest	Middle	Highest
10	Channel	23780	23790	23800
	Frequency	709.0	710.0	711.0
5	Channel	23755	23790	23825
	Frequency	706.5	710.0	713.5

LTE Band 25 Channel and Frequency List				
BW [MHz]	Channel/Frequency(MHz)	Lowest	Middle	Highest
20	Channel	26140	26340	26590
	Frequency	1860.0	1880.0	1905.0
15	Channel	26115	26340	26615
	Frequency	1857.5	1880.0	1907.5
10	Channel	26090	26340	26640
	Frequency	1855.0	1880.0	1910.0
5	Channel	26065	26340	26665
	Frequency	1852.5	1880.0	1912.5
3	Channel	26055	26340	26675
	Frequency	1851.5	1880.0	1913.5
1.4	Channel	26047	26340	26683
	Frequency	1850.7	1880.0	1914.3



LTE Band 26 Channel and Frequency List				
BW [MHz]	Channel/Frequency(MHz)	Lowest	Middle	Highest
15	Channel	26865	26915	26965
	Frequency	831.5	836.5	841.5
10	Channel	26840	26915	26990
	Frequency	829.0	836.5	844.0
5	Channel	26815	26915	27015
	Frequency	826.5	836.5	846.5
3	Channel	26805	26915	27025
	Frequency	825.5	836.5	847.5
1.4	Channel	26797	26915	27033
	Frequency	824.7	836.5	848.3

LTE Band 38 Channel and Frequency List				
BW [MHz]	Channel/Frequency(MHz)	Lowest	Middle	Highest
20	Channel	37850	38000	38150
	Frequency	2580.0	2595.0	2610.0
15	Channel	37825	38000	38175
	Frequency	2577.5	2595.0	2612.5
10	Channel	37800	38000	38200
	Frequency	2575.0	2595.0	2615.0
5	Channel	37775	38000	38225
	Frequency	2572.5	2595.0	2617.5

LTE Band 41 Channel and Frequency List				
BW [MHz]	Channel/Frequency(MHz)	Lowest	Middle	Highest
20	Channel	39750	40620	41490
	Frequency	2506.0	2593.0	2680.0
15	Channel	39725	40620	41515
	Frequency	2503.5	2593.0	2682.5
10	Channel	39700	40620	41540
	Frequency	2501.0	2593.0	2685.0
5	Channel	39675	40620	41565
	Frequency	2498.5	2593.0	2687.5



LTE Band 66 Channel and Frequency List				
BW [MHz]	Channel/Frequency(MHz)	Lowest	Middle	Highest
20	Channel	132072	132322	132572
	Frequency	1720.0	1745.0	1770.0
15	Channel	132047	132322	132597
	Frequency	1717.5	1745.0	1772.5
10	Channel	132022	132322	132622
	Frequency	1715.0	1745.0	1775.0
5	Channel	131997	132322	132647
	Frequency	1712.5	1745.0	1777.5
3	Channel	131987	132322	132657
	Frequency	1711.5	1745.0	1778.5
1.4	Channel	131979	132322	132665
	Frequency	1710.7	1745.0	1779.3

3 Conducted Test Items

3.1 Measuring Instruments

See list of measuring instruments of this test report.

3.1.1 Test Setup

3.1.2 Conducted Output Power

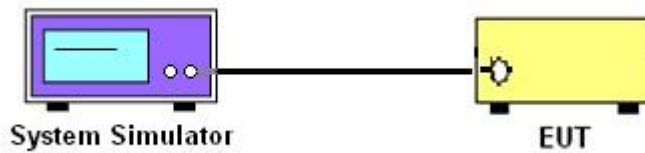

3.1.3 Peak-to-Average Ratio, Occupied Bandwidth ,Conducted Band-Edge and Conducted Spurious Emission

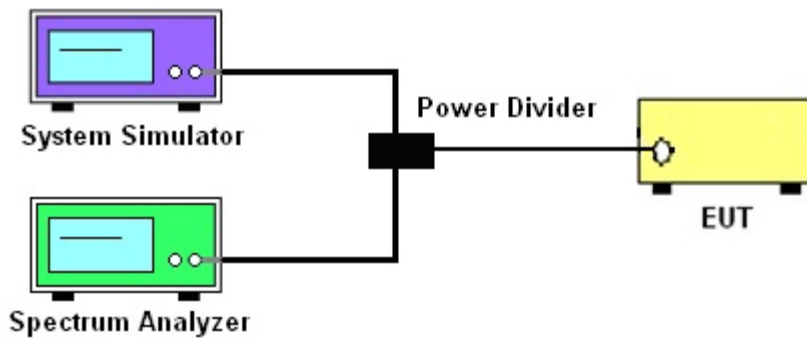

3.1.4 Frequency Stability

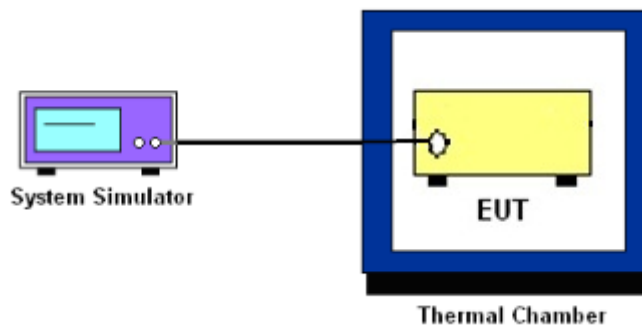

3.1.5 Test Result of Conducted Test

Please refer to Appendix A.



3.2 Conducted Output Power and ERP/EIRP

3.2.1 Description of the Conducted Output Power Measurement and ERP/EIRP Measurement

A system simulator was used to establish communication with the EUT. Its parameters were set to force the EUT transmitting at maximum output power. The measured power in the radio frequency on the transmitter output terminals shall be reported.

The ERP of mobile transmitters must not exceed 7 Watts for LTE Band 5 and Band 26.

The ERP of mobile transmitters must not exceed 3 Watts for LTE Band 12 and Band 13 and Band 17.

The EIRP of mobile transmitters must not exceed 2 Watts for LTE Band 2 and Band 25 and Band 7 and Band 38 and Band 41.

The EIRP of mobile transmitters must not exceed 1 Watts for LTE Band 4 and Band 66.

According to KDB 412172 D01 Power Approach,

$EIRP = P_T + G_T - L_C$, $ERP = EIRP - 2.15$, where

P_T = transmitter output power in dBm

G_T = gain of the transmitting antenna in dBi

L_C = signal attenuation in the connecting cable between the transmitter and antenna in dB

3.2.2 Test Procedures

1. The transmitter output port was connected to the system simulator.
2. Set EUT at maximum power through the system simulator.
3. Select lowest, middle, and highest channels for each band and different modulation.
4. Measure and record the power level from the system simulator.



3.3 Peak-to-Average Ratio

3.3.1 Description of the PAR Measurement

Power Complementary Cumulative Distribution Function (CCDF) curves provide a means for characterizing the power peaks of a digitally modulated signal on a statistical basis. A CCDF curve depicts the probability of the peak signal amplitude exceeding the average power level. Most contemporary measurement instrumentation include the capability to produce CCDF curves for an input signal provided that the instrument's resolution bandwidth can be set wide enough to accommodate the entire input signal bandwidth. In measuring transmissions in this band using an average power technique, the peak-to-average ratio (PAR) of the transmission may not exceed 13 dB.

3.3.2 Test Procedures

The testing follows FCC KDB 971168 D01 v03r01 Section 5.7.1

1. The EUT was connected to spectrum and system simulator via a power divider.
2. Set the CCDF (Complementary Cumulative Distribution Function) option in spectrum analyzer.
3. The highest RF powers were measured and recorded the maximum PAPR level associated with a probability of 0.1 %.
4. Record the deviation as Peak to Average Ratio.



3.4 Occupied Bandwidth

3.4.1 Description of Occupied Bandwidth Measurement

The occupied bandwidth is the width of a frequency band such that, below the lower and above the upper frequency limits, the mean powers emitted are each equal to a specified percentage 0.5% of the total mean transmitted power.

The 26 dB emission bandwidth is defined as the frequency range between two points, one above and one below the carrier frequency, at which the spectral density of the emission is attenuated 26 dB below the maximum in-band spectral density of the modulated signal. Spectral density (power per unit bandwidth) is to be measured with a detector of resolution bandwidth equal to approximately 1.0% of the emission bandwidth.

3.4.2 Test Procedures

The testing follows FCC KDB 971168 D01 v03r01 Section 4.2

1. The EUT was connected to spectrum analyzer and system simulator via a power divider.
2. The spectrum analyzer center frequency is set to the nominal EUT channel center frequency. The span range for the spectrum analyzer shall be between two and five times the anticipated OBW.
3. The nominal resolution bandwidth (RBW) shall be in the range of 1 to 5 % of the anticipated OBW, and the VBW shall be at least 3 times the RBW.
4. Set the detection mode to peak, and the trace mode to max hold.
5. Determine the reference value: Set the EUT to transmit a modulated signal. Allow the trace to stabilize. Set the spectrum analyzer marker to the highest level of the displayed trace.
(this is the reference value)
6. Determine the “-26 dB down amplitude” as equal to (Reference Value – X).
7. Place two markers, one at the lowest and the other at the highest frequency of the envelope of the spectral display such that each marker is at or slightly below the “-X dB down amplitude” determined in step 6. If a marker is below this “-X dB down amplitude” value it shall be placed as close as possible to this value. The OBW is the positive frequency difference between the two markers.
8. Use the 99 % power bandwidth function of the spectrum analyzer and report the measured bandwidth.



3.5 Conducted Band Edge

3.5.1 Description of Conducted Band Edge Measurement

22.917(a)

For operations in the 824 – 849 MHz band, the FCC limit is $43 + 10\log_{10}(P[\text{Watts}])$ dB below the transmitter power $P(\text{Watts})$ in a 100kHz bandwidth. However, in the 1MHz bands immediately outside and adjacent to the licensee's frequency block, a resolution bandwidth of at least one percent of the emission bandwidth of the fundamental emission of the transmitter may be employed.

24.238 (a)

For operations in the 1850-1910 and 1930-1990 MHz band, the FCC limit is $43 + 10\log_{10}(P[\text{Watts}])$ dB below the transmitter power $P(\text{Watts})$ in a 1MHz bandwidth. However, in the 1 MHz bands immediately outside and adjacent to the frequency block a resolution bandwidth of at least one percent of the emission bandwidth of the fundamental emission of the transmitter may be employed.

27.53 (c)

For operations in the 776-788 MHz band, the FCC limit is $43 + 10\log_{10}(P[\text{Watts}])$ dB below the transmitter power $P(\text{Watts})$ in a 100 kHz bandwidth. However, in the 100 kHz bands immediately outside and adjacent to the frequency block, a resolution bandwidth of at least 30 kHz may be employed. In addition, the power of any unwanted emissions in any 6.25 kHz bandwidth for all frequencies between 763-775 MHz and 793-806 MHz shall be attenuated below the transmitter power, P (dBW), by at least $65 + 10 \log_{10} p(\text{watts})$, dB, for mobile and portable equipment.

27.53 (g)

For operations in the 600MHz band and 698 -746 MHz band, the FCC limit is $43 + 10\log_{10}(P[\text{Watts}])$ dB below the transmitter power $P(\text{Watts})$ in a 100 kHz bandwidth. However, in the 100 kilohertz bands immediately outside and adjacent to a licensee's frequency block, a resolution bandwidth of at least 30 kHz may be employed.

27.53 (h)

For operations in the 1710 – 1755 MHz band, the FCC limit is $43 + 10\log_{10}(P[\text{Watts}])$ dB below the transmitter power $P(\text{Watts})$ in a 1 MHz bandwidth. However, in the 1MHz bands immediately outside and adjacent to the licensee's frequency block, a resolution bandwidth of at least one percent of the emission bandwidth of the fundamental emission of the transmitter may be employed.

**27.53(m)(4)**

For mobile digital stations, the attenuation factor shall be not less than $40 + 10 \log (P)$ dB on all frequencies between the channel edge and 5 megahertz from the channel edge, $43 + 10 \log (P)$ dB on all frequencies between 5 megahertz and X megahertz from the channel edge, and $55 + 10 \log (P)$ dB on all frequencies more than X megahertz from the channel edge, where X is the greater of 6 megahertz or the actual emission bandwidth as defined in paragraph (m)(6) of this section. In addition, the attenuation factor shall not be less that $43 + 10 \log (P)$ dB on all frequencies between 2490.5 MHz and 2496 MHz and $55 + 10 \log (P)$ dB at or below 2490.5 MHz. Mobile Satellite Service licensees operating on frequencies below 2495 MHz may also submit a documented interference complaint against BRS licensees operating on channel BRS Channel 1 on the same terms and conditions as adjacent channel BRS or EBS licensees.

3.5.2 Test Procedures

The testing follows FCC KDB 971168 D01 v03r01 Section 6.0.

1. The EUT was connected to spectrum analyzer and system simulator via a power divider.
2. The band edges of low and high channels for the highest RF powers were measured.
3. Set RBW \geq 1% EBW in the 1MHz band immediately outside and adjacent to the band edge.
4. Beyond the 1 MHz band from the band edge, RBW=1MHz was used.
5. Set spectrum analyzer with RMS detector.
6. The RF fundamental frequency should be excluded against the limit line in the operating frequency band.
7. Checked that all the results comply with the emission limit line.
The limit line is derived from $43 + 10\log(P)$ dB below the transmitter power P(Watts)
8. For LTE Band 7, 38, 41, the other 40 dB, and 55 dB have additionally applied same calculation above.



3.6 Conducted Spurious Emission

3.6.1 Description of Conducted Spurious Emission Measurement

The power of any emission outside of the authorized operating frequency ranges must be lower than the transmitter power (P) by a factor of at least $43 + 10 \log (P)$ dB.

For Band 7,38,41:

The power of any emission outside of the authorized operating frequency ranges must be lower than the transmitter power (P) by a factor of at least $55 + 10 \log (P)$ dB.

It is measured by means of a calibrated spectrum analyzer and scanned from 30 MHz up to a frequency including its 10th harmonic.

3.6.2 Test Procedures

The testing follows FCC KDB 971168 D01 v03r01 Section 6.0.

1. The EUT was connected to spectrum analyzer and system simulator via a power divider.
2. The RF output of EUT was connected to the spectrum analyzer by RF cable and attenuator.
The path loss was compensated to the results for each measurement.
3. The middle channel for the highest RF power within the transmitting frequency was measured.
4. The conducted spurious emission for the whole frequency range was taken.
5. Make the measurement with the spectrum analyzer's RBW = 1MHz, VBW = 3MHz.
6. Set spectrum analyzer with RMS detector.
7. Taking the record of maximum spurious emission.
8. The RF fundamental frequency should be excluded against the limit line in the operating frequency band.
9. The limit line is derived from $43 + 10\log(P)$ dB below the transmitter power P(Watts)
10. For Band 7, 38, 41
The limit line is derived from $55 + 10\log(P)$ dB below the transmitter power P(Watts)



3.7 Frequency Stability

3.7.1 Description of Frequency Stability Measurement

22.355

The frequency stability shall be measured by variation of ambient temperature and variation of primary supply voltage to ensure that the fundamental emission stays within the authorized frequency block. The frequency stability of the transmitter shall be maintained within $\pm 0.00025\%$ ($\pm 2.5\text{ppm}$) of the center frequency.

24.235 & 27.54

The frequency stability shall be sufficient to ensure that the fundamental emission stays within the authorized frequency block.

3.7.2 Test Procedures for Temperature Variation

The testing follows FCC KDB 971168 D01 v03r01 Section 9.0.

1. The EUT was set up in the thermal chamber and connected with the system simulator.
2. With power OFF, the temperature was decreased to -30°C and the EUT was stabilized before testing. Power was applied and the maximum change in frequency was recorded within one minute.
3. With power OFF, the temperature was raised in 10°C step up to 50°C . The EUT was stabilized at each step for at least half an hour. Power was applied and the maximum frequency change was recorded within one minute.

3.7.3 Test Procedures for Voltage Variation

The testing follows FCC KDB 971168 D01 v03r01 Section 9.0.

1. The EUT was placed in a temperature chamber at $20\pm 5^{\circ}\text{C}$ and connected with the system simulator.
2. The power supply voltage to the EUT was varied from 85% to 115% of the nominal value measured at the input to the EUT.
3. The variation in frequency was measured for the worst case.

4 Radiated Test Items

4.1 Measuring Instruments

See list of measuring instruments of this test report.

4.1.1 Test Setup

For radiated test from 30MHz to 1GHz

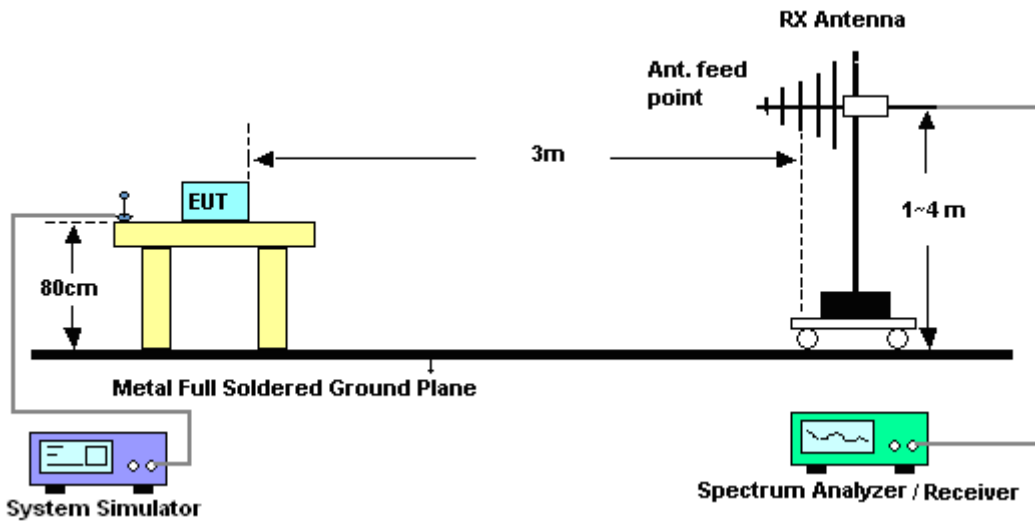

For radiated test above 1GHz

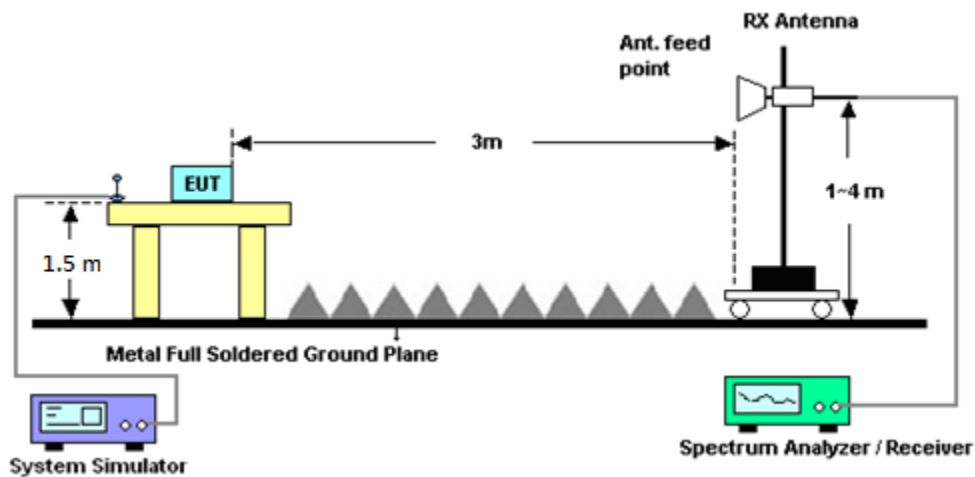

4.1.2 Test Result of Radiated Test

Please refer to Appendix B.



4.2 Radiated Spurious Emission

4.2.1 Description of Radiated Spurious Emission

The radiated spurious emission was measured by substitution method according to ANSI / TIA-603-E. The power of any emission outside of the authorized operating frequency ranges must be attenuated below the transmitter power (P) by a factor of at least $43 + 10 \log (P)$ dB.

For Band 7, 38, 41

The power of any emission outside of the authorized operating frequency ranges must be attenuated below the transmitter power (P) by a factor of at least $55 + 10 \log (P)$ dB.

For LTE Band 13

For operations in the 746-758 MHz, 775-788 MHz, and 805-806 MHz bands, emissions in the band 1559-1610 MHz shall be limited to -70 dBW/MHz equivalent isotropically radiated power (EIRP) for wideband signals, and -80 dBW EIRP for discrete emissions of less than 700 Hz bandwidth.

The spectrum is scanned from 30 MHz up to a frequency including its 10th harmonic.

4.2.2 Test Procedures

The testing follows FCC KDB 971168 D01 v03r01 Section 5.8 and ANSI / TIA-603-E Section 2.2.12.

1. The EUT was placed on a turntable with 0.8 meter for frequency below 1GHz and 1.5 meter for frequency above 1GHz respectively above ground.
2. The EUT was set 3 meters from the receiving antenna, which was mounted on the antenna tower.
3. The table was rotated 360 degrees to determine the position of the highest spurious emission.
4. The height of the receiving antenna is varied between one meter and four meters to search the maximum spurious emission for both horizontal and vertical polarizations.
5. Make the measurement with the spectrum analyzer's RBW = 1MHz, VBW = 3MHz, taking the record of maximum spurious emission.
6. A horn antenna was substituted in place of the EUT and was driven by a signal generator.
7. Tune the output power of signal generator to the same emission level with EUT maximum spurious emission.
8. Taking the record of output power at antenna port.
9. Repeat step 7 to step 8 for another polarization.
10. The RF fundamental frequency should be excluded against the limit line in the operating frequency band.

The limit line is derived from $43 + 10\log(P)$ dB below the transmitter power P(Watts)

11. For Band 7, 38, 41:

The limit line is derived from $55 + 10\log(P)$ dB below the transmitter power P(Watts)

EIRP (dBm) = S.G. Power – Tx Cable Loss + Tx Antenna Gain

ERP (dBm) = EIRP - 2.15



5 List of Measuring Equipment

Instrument	Manufacturer	Model No.	Serial No.	Characteristics	Calibration Date	Test Date	Due Date	Remark
LTE Base Station	Anritsu	MT8820C	620143282 1	GSM/GPRS /WCDMA/LTE	Oct. 13, 2017	Sep. 21, 2018~ Oct. 06, 2018	Oct. 12, 2018	Conducted (TH05-HY)
Spectrum Analyzer	Rohde & Schwarz	FSV40	101397	10Hz~40GHz	Nov. 07, 2017	Sep. 21, 2018~ Oct. 06, 2018	Nov. 06, 2018	Conducted (TH05-HY)
Temperature Chamber	ESPEC	SH-641	92013720	-40℃~90℃	Aug. 29, 2018	Sep. 21, 2018~ Oct. 06, 2018	Aug. 28, 2019	Conducted (TH05-HY)
Programmable Power Supply	GW Instek	PSS-2005	EL890089	1V~20V 0.5A~5A	Jan. 12, 2018	Sep. 21, 2018~ Oct. 06, 2018	Jan. 11, 2019	Conducted (TH05-HY)
Coupler	Warison	1-18GHz 20dB 25WSMA Directional Coupler	#B	1G~18GHz	Dec. 04, 2017	Sep. 21, 2018~ Oct. 06, 2018	Dec. 03, 2018	Conducted (TH05-HY)
Bilog Antenna	TESEQ	CBL6111D&0 0800N1D01N-06	41912&05	30MHz to 1GHz	Jan. 10, 2018	Sep. 24, 2018~ Sep. 28, 2018	Jan. 09, 2019	Radiation (03CH15-HY)
Horn Antenna	SCHWARZBECK	BBHA 9120D	9120D-1620	1G~18GHz	Oct. 03, 2017	Sep. 24, 2018~ Sep. 28, 2018	Oct. 02, 2018	Radiation (03CH15-HY)
Horn Antenna	SCHWARZBECK	BBHA 9120 D	9120D-1522	1G~18GHz	May. 10, 2018	Sep. 24, 2018~ Sep. 28, 2018	May. 09, 2019	Radiation (03CH15-HY)
Loop Antenna	Rohde & Schwarz	HFH2-Z2	100488	9 kHz~30 MHz	Nov. 23, 2017	Sep. 24, 2018~ Sep. 28, 2018	Nov. 22, 2018	Radiation (03CH15-HY)
Preamplifier	Keysight	83017A	MY53270195	1GHz~26.5GHz	Aug. 23, 2018	Sep. 24, 2018~ Sep. 28, 2018	Aug. 22, 2019	Radiation (03CH15-HY)
Preamplifier	EMEC	EM18G40G	060715	18GHz ~ 40GHz	Dec. 05, 2017	Sep. 24, 2018~ Sep. 28, 2018	Dec. 04, 2018	Radiation (03CH15-HY)
Amplifier	SONOMA	310N	363440	9kHz~1GHz	Dec. 26, 2017	Sep. 24, 2018~ Sep. 28, 2018	Dec. 25, 2018	Radiation (03CH15-HY)
Spectrum Analyzer	Agilent	E4446A	MY50180136	3Hz~44GHz	Apr. 25, 2018	Sep. 24, 2018~ Sep. 28, 2018	Apr. 24, 2019	Radiation (03CH15-HY)
RF Cable	HUBER + SUHNER	SUCOFLEX 104	MY2859/2	30MHz-40GHz	Mar. 04, 2018	Sep. 24, 2018~ Sep. 28, 2018	Mar. 03, 2019	Radiation (03CH15-HY)
RF Cable	HUBER + SUHNER	SUCOFLEX 102	MY4274/2	30MHz-40GHz	Mar. 14, 2018	Sep. 24, 2018~ Sep. 28, 2018	Mar. 13, 2019	Radiation (03CH15-HY)
Controller	ChainTek	3000-1	N/A	Control Turn table & Ant Mast	N/A	Sep. 24, 2018~ Sep. 28, 2018	N/A	Radiation (03CH15-HY)
Antenna Mast	ChainTek	MBS-520-1	N/A	1m~4m	N/A	Sep. 24, 2018~ Sep. 28, 2018	N/A	Radiation (03CH15-HY)
Turn Table	ChainTek	T-200-S-1	N/A	0~360 Degree	N/A	Sep. 24, 2018~ Sep. 28, 2018	N/A	Radiation (03CH15-HY)



Instrument	Manufacturer	Model No.	Serial No.	Characteristics	Calibration Date	Test Date	Due Date	Remark
SHF-EHF Horn Antenna	SCHWARZBECK	BBHA 9170	BBHA9170576	18GHz ~ 40GHz	May 08, 2018	Sep. 24, 2018~ Sep. 28, 2018	May 07, 2019	Radiation (03CH15-HY)
Signal Generator	Rohde & Schwarz	SMF100A	101107	100kHz~40GHz	May. 21, 2018	Sep. 24, 2018~ Sep. 28, 2018	May. 20, 2019	Radiation (03CH15-HY)
Software	Audix	E3 6.2009-8-24(K5)	ARD-SPR-000185	N/A	N/A	Sep. 24, 2018~ Sep. 28, 2018	N/A	Radiation (03CH15-HY)
Filter	Wainwright	WLK4-1000-1530-8000-40SS	SN11	1G Low Pass	Sep. 16, 2018	Sep. 24, 2018~ Sep. 28, 2018	Sep. 15, 2019	Radiation (03CH15-HY)
Filter	Wainwright	WHKX12-2700-3000-18000-60ST	SN2	3 GHz Highpass	Jul. 15, 2018	Sep. 24, 2018~ Sep. 28, 2018	Jul. 14, 2019	Radiation (03CH15-HY)
Notch Filter	Wainwright	WRCT800/960-0.2/40-8SSK	SN22	GSM850	Nov. 03, 2017	Sep. 24, 2018~ Sep. 28, 2018	Nov. 02, 2018	Radiation (03CH15-HY)
Notch Filter	Wainwright	WRCT1747.5-0.4/40-8SS	SN2	DCS 1800	Aug. 22, 2018	Sep. 24, 2018~ Sep. 28, 2018	Aug. 21, 2019	Radiation (03CH15-HY)
Notch Filter	Wainwright	WRCT2500/2570-10/40-10SSK	SN1 R	LTE Band7	Aug. 22, 2018	Sep. 24, 2018~ Sep. 28, 2018	Aug. 21, 2019	Radiation (03CH15-HY)
Notch Filter	Wainwright	WRCT698/798-10/40 8SSK	SN1	AWS Band	Nov. 08, 2017	Sep. 24, 2018~ Sep. 28, 2018	Nov. 07, 2018	Radiation (03CH15-HY)



6 Uncertainty of Evaluation

Uncertainty of Radiated Emission Measurement (30 MHz ~ 1000 MHz)

Measuring Uncertainty for a Level of Confidence of 95% ($U = 2Uc(y)$)	3.37
---	------

Uncertainty of Radiated Emission Measurement (1 GHz ~ 18 GHz)

Measuring Uncertainty for a Level of Confidence of 95% ($U = 2Uc(y)$)	3.67
---	------

Uncertainty of Radiated Emission Measurement (18 GHz ~ 40 GHz)

Measuring Uncertainty for a Level of Confidence of 95% ($U = 2Uc(y)$)	4.03
---	------



Appendix A. Test Results of Conducted Test

Conducted Output Power(Average power)

LTE Band 2 Maximum Average Power [dBm]						
BW [MHz]	RB Size	RB Offset	Mod	Lowest	Middle	Highest
20	1	0	QPSK	22.25	22.23	22.06
20	1	49		22.12	22.05	22.23
20	1	99		22.19	22.16	22.07
20	50	0		22.00	21.77	21.67
20	50	24		21.71	21.66	21.63
20	50	50		21.66	21.65	21.67
20	100	0		21.78	21.70	21.76
20	1	0	16-QAM	22.04	22.14	22.13
20	1	49		21.84	21.86	21.98
20	1	99		22.02	21.90	21.77
20	50	0		20.82	20.75	20.70
20	50	24		20.73	20.68	20.60
20	50	50		20.72	20.67	20.68
20	100	0		20.80	20.73	20.70
15	1	0	QPSK	22.46	22.37	22.42
15	1	37		22.12	22.04	22.05
15	1	74		22.33	22.30	22.24
15	36	0		22.16	22.03	22.04
15	36	20		21.83	21.77	21.74
15	36	39		21.77	21.75	21.67
15	75	0		21.96	21.89	21.90
15	1	0	16-QAM	22.20	22.26	22.15
15	1	37		21.90	22.00	21.90
15	1	74		22.15	22.06	22.09
15	36	0		21.17	21.07	21.02
15	36	20		20.82	20.77	20.77
15	36	39		20.73	20.73	20.65
15	75	0		20.96	20.89	20.92



LTE Band 2 Maximum Average Power [dBm]						
BW [MHz]	RB Size	RB Offset	Mod	Lowest	Middle	Highest
10	1	0	QPSK	22.15	22.16	22.02
10	1	25		22.32	22.16	22.03
10	1	49		22.05	22.20	22.07
10	25	0		21.84	21.80	21.74
10	25	12		21.87	21.75	21.75
10	25	25		21.65	21.57	21.58
10	50	0		21.73	21.65	21.63
10	1	0	16-QAM	21.88	21.92	21.93
10	1	25		21.96	21.91	21.90
10	1	49		21.56	21.46	21.46
10	25	0		20.83	20.75	20.73
10	25	12		20.87	20.75	20.71
10	25	25		20.71	20.58	20.54
10	50	0		20.79	20.69	20.62
5	1	0	QPSK	22.06	22.03	22.09
5	1	12		22.18	22.12	22.07
5	1	24		22.21	22.09	22.07
5	12	0		21.86	21.79	21.76
5	12	7		21.81	21.69	21.69
5	12	13		21.79	21.62	21.68
5	25	0		21.84	21.71	21.68
5	1	0	16-QAM	22.07	22.05	22.02
5	1	12		21.94	21.88	21.84
5	1	24		21.99	21.88	21.83
5	12	0		20.83	20.82	20.75
5	12	7		20.85	20.78	20.76
5	12	13		20.82	20.69	20.69
5	25	0		20.78	20.68	20.68



LTE Band 2 Maximum Average Power [dBm]						
BW [MHz]	RB Size	RB Offset	Mod	Lowest	Middle	Highest
3	1	0	QPSK	22.20	22.15	22.05
3	1	8		22.23	22.09	22.11
3	1	14		22.19	22.10	22.05
3	8	0		21.84	21.73	21.69
3	8	4		21.81	21.69	21.70
3	8	7		21.78	21.64	21.67
3	15	0		21.76	21.70	21.65
3	1	0	16-QAM	22.12	21.95	21.94
3	1	8		22.09	21.90	21.92
3	1	14		22.03	21.89	21.91
3	8	0		20.84	20.78	20.76
3	8	4		20.86	20.81	20.75
3	8	7		20.84	20.68	20.72
3	15	0		20.86	20.75	20.68
1.4	1	0	QPSK	22.27	22.23	22.12
1.4	1	3		22.24	22.13	22.12
1.4	1	5		22.17	22.15	22.00
1.4	3	0		22.17	22.09	22.07
1.4	3	1		22.20	22.12	22.05
1.4	3	3		22.18	22.09	22.01
1.4	6	0		21.75	21.69	21.63
1.4	1	0	16-QAM	22.06	21.86	21.89
1.4	1	3		22.06	21.89	21.88
1.4	1	5		22.00	21.83	21.81
1.4	3	0		21.72	21.64	21.58
1.4	3	1		21.75	21.68	21.61
1.4	3	3		21.69	21.63	21.60
1.4	6	0		20.93	20.75	20.68



LTE Band 25 Maximum Average Power [dBm]						
BW [MHz]	RB Size	RB Offset	Mod	Lowest	Middle	Highest
20	1	0	QPSK	22.36	22.30	22.21
20	1	49		22.18	22.06	22.17
20	1	99		22.20	22.24	22.20
20	50	0		21.75	21.72	21.70
20	50	24		21.67	21.61	21.62
20	50	50		21.64	21.69	21.65
20	100	0		21.83	21.73	21.81
20	1	0	16-QAM	21.95	22.05	22.13
20	1	49		21.91	21.86	22.07
20	1	99		22.08	21.75	22.07
20	50	0		20.73	20.71	20.70
20	50	24		20.67	20.66	20.68
20	50	50		20.67	20.73	20.72
20	100	0		20.73	20.63	20.79
15	1	0	QPSK	22.74	22.70	22.61
15	1	37		22.12	22.00	21.95
15	1	74		22.35	22.28	22.25
15	36	0		22.07	21.97	21.98
15	36	20		21.77	21.67	21.65
15	36	39		21.66	21.59	21.63
15	75	0		21.86	21.77	21.77
15	1	0	16-QAM	22.40	22.44	22.42
15	1	37		21.87	21.80	21.85
15	1	74		22.28	22.04	22.20
15	36	0		21.01	20.98	21.01
15	36	20		20.69	20.66	20.67
15	36	39		20.62	20.62	20.70
15	75	0		20.84	20.78	20.86



LTE Band 25 Maximum Average Power [dBm]						
BW [MHz]	RB Size	RB Offset	Mod	Lowest	Middle	Highest
10	1	0	QPSK	22.22	22.10	22.06
10	1	25		22.36	22.18	22.12
10	1	49		21.83	21.80	21.74
10	25	0		21.76	21.69	21.70
10	25	12		21.79	21.70	21.72
10	25	25		21.55	21.51	21.52
10	50	0		21.67	21.56	21.60
10	1	0	16-QAM	21.91	21.87	21.83
10	1	25		21.97	21.88	21.86
10	1	49		21.56	21.52	21.46
10	25	0		20.80	20.72	20.73
10	25	12		20.74	20.69	20.73
10	25	25		20.58	20.50	20.51
10	50	0		20.71	20.57	20.61
5	1	0	QPSK	22.34	22.26	22.18
5	1	12		22.26	22.13	22.05
5	1	24		22.24	22.13	22.13
5	12	0		21.82	21.74	21.72
5	12	7		21.78	21.66	21.65
5	12	13		21.71	21.69	21.63
5	25	0		21.80	21.67	21.66
5	1	0	16-QAM	22.17	22.13	22.16
5	1	12		22.01	21.93	21.88
5	1	24		22.01	21.89	21.90
5	12	0		20.82	20.77	20.79
5	12	7		20.78	20.68	20.79
5	12	13		20.72	20.71	20.77
5	25	0		20.78	20.66	20.66



LTE Band 25 Maximum Average Power [dBm]						
BW [MHz]	RB Size	RB Offset	Mod	Lowest	Middle	Highest
3	1	0	QPSK	22.23	22.15	22.13
3	1	8		22.24	22.13	22.17
3	1	14		22.21	22.11	22.08
3	8	0		21.81	21.71	21.67
3	8	4		21.77	21.63	21.68
3	8	7		21.76	21.58	21.63
3	15	0		21.79	21.69	21.68
3	1	0	16-QAM	22.23	22.08	22.03
3	1	8		22.18	22.04	22.02
3	1	14		22.16	21.99	22.09
3	8	0		20.78	20.74	20.86
3	8	4		20.81	20.76	20.82
3	8	7		20.74	20.62	20.85
3	15	0		20.83	20.70	20.68
1.4	1	0	QPSK	22.25	22.10	22.02
1.4	1	3		22.30	22.18	22.08
1.4	1	5		22.25	22.04	21.99
1.4	3	0		22.28	22.15	22.00
1.4	3	1		22.27	22.19	22.05
1.4	3	3		22.25	22.12	22.07
1.4	6	0		21.72	21.66	21.64
1.4	1	0	16-QAM	22.15	21.95	21.94
1.4	1	3		22.15	22.04	22.04
1.4	1	5		22.15	21.94	22.10
1.4	3	0		21.74	21.66	21.74
1.4	3	1		21.84	21.69	21.75
1.4	3	3		21.73	21.64	21.67
1.4	6	0		20.87	20.72	20.63



LTE Band 4 Maximum Average Power [dBm]						
BW [MHz]	RB Size	RB Offset	Mod	Lowest	Middle	Highest
20	1	0	QPSK	22.70	22.33	22.41
20	1	49		22.47	22.25	22.58
20	1	99		22.45	22.44	22.95
20	50	0		22.09	21.76	21.94
20	50	24		21.94	21.71	22.05
20	50	50		21.80	21.74	22.15
20	100	0		21.94	21.88	22.16
20	1	0	16-QAM	22.45	22.12	22.06
20	1	49		22.13	21.84	22.31
20	1	99		21.96	22.13	22.71
20	50	0		21.06	20.76	20.94
20	50	24		20.92	20.76	21.07
20	50	50		20.82	20.79	21.16
20	100	0		20.98	20.79	20.99
15	1	0	QPSK	22.74	22.31	22.42
15	1	37		22.61	22.33	22.71
15	1	74		22.52	22.58	22.76
15	36	0		22.53	22.13	22.36
15	36	20		22.14	21.85	22.23
15	36	39		21.96	21.82	22.26
15	75	0		22.22	21.97	22.26
15	1	0	16-QAM	22.22	22.80	22.79
15	1	37		22.13	22.12	22.24
15	1	74		22.29	22.33	22.89
15	36	0		21.46	21.17	21.37
15	36	20		21.13	20.84	21.19
15	36	39		20.92	20.80	21.29
15	75	0		21.20	20.97	21.33



LTE Band 4 Maximum Average Power [dBm]						
BW [MHz]	RB Size	RB Offset	Mod	Lowest	Middle	Highest
10	1	0	QPSK	22.35	22.50	22.56
10	1	25		22.51	22.30	22.79
10	1	49		22.03	22.12	22.58
10	25	0		22.10	21.76	22.20
10	25	12		22.01	21.81	22.29
10	25	25		21.80	21.72	22.28
10	50	0		21.90	21.68	22.24
10	1	0	16-QAM	22.32	21.93	22.37
10	1	25		22.29	21.96	22.55
10	1	49		21.79	21.67	22.34
10	25	0		21.10	20.74	21.20
10	25	12		21.06	20.79	21.27
10	25	25		20.77	20.71	21.22
10	50	0		20.96	20.74	21.23
5	1	0	QPSK	22.09	22.34	22.26
5	1	12		22.59	22.24	22.80
5	1	24		22.55	22.33	22.93
5	12	0		22.22	21.77	22.42
5	12	7		22.14	21.78	22.44
5	12	13		22.05	21.82	22.40
5	25	0		22.16	21.80	22.45
5	1	0	16-QAM	22.60	22.14	22.69
5	1	12		22.23	21.90	22.54
5	1	24		22.26	22.07	22.83
5	12	0		21.24	20.79	21.45
5	12	7		21.19	20.79	21.42
5	12	13		21.13	20.81	21.47
5	25	0		21.13	20.80	21.43



LTE Band 4 Maximum Average Power [dBm]						
BW [MHz]	RB Size	RB Offset	Mod	Lowest	Middle	Highest
3	1	0	QPSK	22.49	22.50	22.22
3	1	8		22.68	22.32	22.90
3	1	14		22.50	22.20	22.92
3	8	0		22.15	21.71	22.38
3	8	4		22.11	21.75	22.41
3	8	7		22.12	21.67	22.41
3	15	0		22.15	21.76	22.44
3	1	0	16-QAM	22.47	22.20	22.65
3	1	8		22.30	21.97	22.68
3	1	14		22.34	22.09	22.69
3	8	0		21.23	20.78	21.50
3	8	4		21.23	20.86	21.49
3	8	7		21.16	20.73	21.47
3	15	0		21.17	20.81	21.45
1.4	1	0	QPSK	22.65	22.18	22.16
1.4	1	3		22.64	22.29	22.85
1.4	1	5		22.55	22.20	22.87
1.4	3	0		22.62	22.23	22.91
1.4	3	1		22.63	22.27	22.70
1.4	3	3		22.64	22.27	22.71
1.4	6	0		22.13	21.74	22.42
1.4	1	0	16-QAM	22.43	22.04	22.70
1.4	1	3		22.45	22.13	22.73
1.4	1	5		22.36	22.05	22.70
1.4	3	0		22.16	21.76	22.46
1.4	3	1		22.17	21.78	22.49
1.4	3	3		22.18	21.77	22.49
1.4	6	0		21.16	20.80	21.48



LTE Band 5 Maximum Average Power [dBm]						
BW [MHz]	RB Size	RB Offset	Mod	Lowest	Middle	Highest
10	1	0	QPSK	22.98	22.86	23.10
10	1	25		23.19	23.10	22.93
10	1	49		22.67	22.60	22.65
10	25	0		22.05	22.02	21.87
10	25	12		22.16	22.16	21.99
10	25	25		22.01	21.97	21.87
10	50	0		22.07	21.96	21.90
10	1	0	16-QAM	22.00	21.87	21.92
10	1	25		22.28	22.26	22.14
10	1	49		21.92	21.71	21.63
10	25	0		21.06	21.00	20.84
10	25	12		21.13	21.12	20.96
10	25	25		21.01	20.95	20.86
10	50	0		21.03	20.99	20.85
5	1	0	QPSK	22.69	22.68	22.95
5	1	12		23.12	23.05	22.87
5	1	24		23.11	23.05	22.90
5	12	0		22.21	22.13	21.97
5	12	7		22.19	22.14	21.96
5	12	13		22.16	22.10	21.94
5	25	0		22.21	22.13	21.97
5	1	0	16-QAM	22.43	22.38	22.18
5	1	12		22.22	22.23	22.02
5	1	24		22.33	22.30	22.12
5	12	0		21.19	21.20	21.03
5	12	7		21.18	21.15	21.03
5	12	13		21.19	21.14	21.01
5	25	0		21.15	21.10	21.01



LTE Band 5 Maximum Average Power [dBm]						
BW [MHz]	RB Size	RB Offset	Mod	Lowest	Middle	Highest
3	1	0	QPSK	22.76	22.79	22.81
3	1	8		23.15	23.06	22.94
3	1	14		23.12	23.00	22.87
3	8	0		22.19	22.09	21.94
3	8	4		22.18	22.12	21.96
3	8	7		22.19	22.09	21.95
3	15	0		22.17	22.09	21.96
3	1	0	16-QAM	22.33	22.26	22.17
3	1	8		22.39	22.32	22.17
3	1	14		22.34	22.27	22.06
3	8	0		21.24	21.18	21.03
3	8	4		21.25	21.22	21.00
3	8	7		21.22	21.21	21.00
3	15	0		21.16	21.09	20.96
1.4	1	0	QPSK	23.10	23.03	23.08
1.4	1	3		23.05	23.08	22.93
1.4	1	5		23.01	23.04	22.87
1.4	3	0		23.10	23.06	22.86
1.4	3	1		23.02	23.06	22.89
1.4	3	3		23.14	23.06	22.87
1.4	6	0		22.13	22.10	21.96
1.4	1	0	16-QAM	22.38	22.23	22.12
1.4	1	3		22.41	22.36	22.19
1.4	1	5		22.31	22.30	22.08
1.4	3	0		22.13	22.07	21.94
1.4	3	1		22.19	22.17	22.02
1.4	3	3		22.06	22.11	21.91
1.4	6	0		21.00	21.15	20.98



LTE Band 7 Maximum Average Power [dBm]						
BW [MHz]	RB Size	RB Offset	Mod	Lowest	Middle	Highest
20	1	0	QPSK	23.14	22.93	23.07
20	1	49		23.04	22.85	22.97
20	1	99		23.09	23.07	23.11
20	50	0		22.18	22.00	22.04
20	50	24		22.17	21.98	22.07
20	50	50		22.13	22.00	22.09
20	100	0		22.20	22.03	22.15
20	1	0	16-QAM	22.31	22.20	22.38
20	1	49		22.32	22.18	22.31
20	1	99		22.33	22.28	22.39
20	50	0		21.18	20.99	21.07
20	50	24		21.14	21.01	21.09
20	50	50		21.17	21.05	21.15
20	100	0		21.19	21.00	21.09
15	1	0	QPSK	22.47	22.42	22.32
15	1	37		23.07	22.82	22.92
15	1	74		22.95	22.90	23.00
15	36	0		22.36	22.19	22.29
15	36	20		22.25	22.04	22.11
15	36	39		22.18	22.08	22.15
15	75	0		22.28	22.10	22.19
15	1	0	16-QAM	22.64	22.58	22.74
15	1	37		22.24	22.10	22.26
15	1	74		22.51	22.45	22.53
15	36	0		21.38	21.24	21.36
15	36	20		21.23	21.00	21.07
15	36	39		21.16	21.06	21.09
15	75	0		21.31	21.12	21.22



LTE Band 7 Maximum Average Power [dBm]						
BW [MHz]	RB Size	RB Offset	Mod	Lowest	Middle	Highest
10	1	0	QPSK	22.83	22.76	22.89
10	1	25		23.12	23.03	22.98
10	1	49		22.65	22.54	22.61
10	25	0		22.04	21.93	21.94
10	25	12		22.10	22.00	22.10
10	25	25		21.98	21.85	21.95
10	50	0		21.99	21.93	21.97
10	1	0	16-QAM	21.95	21.91	22.03
10	1	25		22.25	22.16	22.30
10	1	49		21.88	21.79	21.88
10	25	0		21.09	20.97	20.95
10	25	12		21.16	20.99	21.08
10	25	25		20.98	20.82	20.99
10	50	0		21.07	20.88	20.95
5	1	0	QPSK	22.92	22.86	22.91
5	1	12		23.07	22.95	23.02
5	1	24		23.08	22.99	23.04
5	12	0		22.15	22.05	22.09
5	12	7		22.10	22.03	22.12
5	12	13		22.12	21.98	22.08
5	25	0		22.12	22.02	22.09
5	1	0	16-QAM	22.28	22.22	22.35
5	1	12		22.24	22.17	22.25
5	1	24		22.24	22.22	22.22
5	12	0		21.13	21.06	21.12
5	12	7		21.17	21.05	21.14
5	12	13		21.12	21.00	21.11
5	25	0		21.11	21.02	21.10



LTE Band 12 Maximum Average Power [dBm]						
BW [MHz]	RB Size	RB Offset	Mod	Lowest	Middle	Highest
10	1	0	QPSK	23.31	22.84	23.03
10	1	25		23.10	23.32	23.27
10	1	49		22.88	22.85	22.95
10	25	0		21.96	22.00	22.14
10	25	12		22.04	22.22	22.21
10	25	25		21.97	22.06	22.04
10	50	0		22.00	22.10	22.07
10	1	0	16-QAM	21.96	21.91	21.97
10	1	25		22.36	22.33	22.39
10	1	49		22.12	22.03	21.88
10	25	0		20.96	20.95	21.13
10	25	12		21.06	21.17	21.19
10	25	25		20.93	21.05	21.03
10	50	0		21.04	21.08	21.08
5	1	0	QPSK	22.88	22.78	22.95
5	1	12		23.04	23.23	23.17
5	1	24		23.14	23.21	23.13
5	12	0		22.13	22.14	22.20
5	12	7		22.13	22.18	22.14
5	12	13		22.10	22.24	22.07
5	25	0		22.14	22.20	22.19
5	1	0	16-QAM	22.39	22.47	22.49
5	1	12		22.25	22.27	22.29
5	1	24		22.48	22.41	22.41
5	12	0		21.16	21.12	21.19
5	12	7		21.15	21.24	21.20
5	12	13		21.11	21.25	21.16
5	25	0		21.07	21.21	21.10



LTE Band 12 Maximum Average Power [dBm]						
BW [MHz]	RB Size	RB Offset	Mod	Lowest	Middle	Highest
3	1	0	QPSK	22.89	22.90	22.94
3	1	8		23.16	23.19	23.10
3	1	14		23.04	23.19	23.05
3	8	0		22.08	22.12	22.10
3	8	4		22.12	22.21	22.13
3	8	7		22.04	22.23	22.10
3	15	0		22.09	22.14	22.08
3	1	0	16-QAM	22.50	22.40	22.47
3	1	8		22.40	22.60	22.48
3	1	14		22.35	22.62	22.45
3	8	0		21.20	21.15	21.20
3	8	4		21.23	21.27	21.18
3	8	7		21.18	21.27	21.12
3	15	0		21.10	21.18	21.11
1.4	1	0	QPSK	23.23	23.29	23.21
1.4	1	3		23.29	23.23	23.17
1.4	1	5		23.16	23.21	23.11
1.4	3	0		23.15	23.11	23.04
1.4	3	1		23.16	23.16	23.06
1.4	3	3		23.16	23.19	23.04
1.4	6	0		22.08	22.16	22.10
1.4	1	0	16-QAM	22.37	22.48	22.56
1.4	1	3		22.38	22.58	22.61
1.4	1	5		22.32	22.59	22.52
1.4	3	0		22.09	22.17	22.12
1.4	3	1		22.13	22.21	22.14
1.4	3	3		22.06	22.17	22.07
1.4	6	0		21.13	21.18	21.10



LTE Band 13 Maximum Average Power [dBm]						
BW [MHz]	RB Size	RB Offset	Mod	Lowest	Middle	Highest
10	1	0	QPSK		22.72	
10	1	25			22.92	
10	1	49			22.60	
10	25	0			22.17	
10	25	12			22.21	
10	25	25			22.08	
10	50	0			22.16	
10	1	0	16-QAM		22.11	
10	1	25			22.49	
10	1	49			22.15	
10	25	0			21.12	
10	25	12			21.14	
10	25	25			21.05	
10	50	0			21.24	
5	1	0	QPSK	23.18	23.06	23.08
5	1	12		23.11	23.09	23.08
5	1	24		23.16	23.19	23.11
5	12	0		22.22	22.19	22.17
5	12	7		22.23	22.18	22.21
5	12	13		22.28	22.15	22.13
5	25	0		22.22	22.15	22.19
5	1	0	16-QAM	22.49	22.46	22.45
5	1	12		22.27	22.33	22.29
5	1	24		22.46	22.49	22.32
5	12	0		21.23	21.18	21.25
5	12	7		21.27	21.22	21.21
5	12	13		21.29	21.24	21.21
5	25	0		21.15	21.11	21.12



LTE Band 17 Maximum Average Power [dBm]						
BW [MHz]	RB Size	RB Offset	Mod	Lowest	Middle	Highest
10	1	0	QPSK	22.90	22.90	23.12
10	1	25		23.20	23.19	23.12
10	1	49		22.67	22.63	22.68
10	25	0		22.06	22.05	22.05
10	25	12		22.21	22.19	22.12
10	25	25		21.95	21.98	21.95
10	50	0		22.10	22.09	21.99
10	1	0	16-QAM	22.11	22.09	22.05
10	1	25		22.40	22.46	22.41
10	1	49		21.90	21.93	21.92
10	25	0		21.01	21.03	21.04
10	25	12		21.19	21.19	21.10
10	25	25		20.94	20.97	20.93
10	50	0		21.05	21.07	20.96
5	1	0	QPSK	22.95	22.86	22.90
5	1	12		23.15	23.12	22.99
5	1	24		23.18	23.12	23.07
5	12	0		22.23	22.19	22.11
5	12	7		22.20	22.19	22.06
5	12	13		22.19	22.12	22.00
5	25	0		22.18	22.19	22.12
5	1	0	16-QAM	22.53	22.48	22.47
5	1	12		22.34	22.32	22.19
5	1	24		22.50	22.43	22.34
5	12	0		21.26	21.23	21.16
5	12	7		21.25	21.26	21.13
5	12	13		21.23	21.17	21.11
5	25	0		21.16	21.17	21.03



LTE Band 26 Maximum Average Power [dBm]						
BW [MHz]	RB Size	RB Offset	Mod	Lowest	Middle	Highest
15	1	0	QPSK	22.99	22.86	22.95
15	1	37		23.32	22.89	23.00
15	1	74		23.02	22.88	22.82
15	36	0		22.22	22.06	21.99
15	36	20		22.20	22.03	21.90
15	36	39		22.05	21.95	21.86
15	75	0		22.20	22.03	21.98
15	1	0	16-QAM	22.51	22.46	22.28
15	1	37		22.35	22.19	22.02
15	1	74		22.30	22.24	22.12
15	36	0		21.18	21.11	21.00
15	36	20		21.17	21.01	20.92
15	36	39		21.04	20.93	20.85
15	75	0		21.16	21.02	20.99
10	1	0	QPSK	22.86	22.79	23.04
10	1	25		23.15	23.01	22.87
10	1	49		22.66	22.86	22.79
10	25	0		22.09	21.97	21.84
10	25	12		22.17	22.06	21.94
10	25	25		21.99	21.85	21.80
10	50	0		22.05	21.89	21.82
10	1	0	16-QAM	21.98	21.91	21.95
10	1	25		22.41	22.23	22.16
10	1	49		21.92	21.71	21.90
10	25	0		21.10	20.96	20.81
10	25	12		21.20	21.06	20.90
10	25	25		21.02	20.86	20.74
10	50	0		21.05	20.89	20.78



LTE Band 26 Maximum Average Power [dBm]						
BW [MHz]	RB Size	RB Offset	Mod	Lowest	Middle	Highest
5	1	0	QPSK	22.86	22.95	22.78
5	1	12		23.10	22.93	22.80
5	1	24		23.16	22.93	22.89
5	12	0		22.24	22.06	21.98
5	12	7		22.23	22.03	21.95
5	12	13		22.20	21.99	21.92
5	25	0		22.23	22.01	21.95
5	1	0	16-QAM	22.37	22.27	22.19
5	1	12		22.31	22.17	22.05
5	1	24		22.37	22.19	22.03
5	12	0		21.24	21.12	21.01
5	12	7		21.25	21.10	21.01
5	12	13		21.24	21.08	20.98
5	25	0		21.18	21.02	20.87
3	1	0	QPSK	22.95	23.00	22.86
3	1	8		23.15	22.98	22.87
3	1	14		23.05	22.90	22.82
3	8	0		22.17	22.00	21.92
3	8	4		22.19	22.00	21.94
3	8	7		22.16	21.97	21.90
3	15	0		22.17	21.98	21.92
3	1	0	16-QAM	22.39	22.23	22.07
3	1	8		22.38	22.18	22.12
3	1	14		22.32	22.14	22.04
3	8	0		21.29	21.13	21.03
3	8	4		21.28	21.14	21.06
3	8	7		21.31	21.09	21.03
3	15	0		21.21	21.00	20.90



LTE Band 26 Maximum Average Power [dBm]						
BW [MHz]	RB Size	RB Offset	Mod	Lowest	Middle	Highest
1.4	1	0	QPSK	22.86	22.65	22.63
1.4	1	3		22.94	22.73	22.68
1.4	1	5		22.91	22.64	22.61
1.4	3	0		22.88	22.71	22.69
1.4	3	1		22.90	22.73	22.66
1.4	3	3		22.84	22.66	22.57
1.4	6	0		22.30	22.21	22.20
1.4	1	0		22.78	22.53	22.51
1.4	1	3	16-QAM	22.78	22.58	22.57
1.4	1	5		22.70	22.50	22.51
1.4	3	0		22.29	22.22	22.27
1.4	3	1		22.36	22.33	22.34
1.4	3	3		22.32	22.18	22.18
1.4	6	0		21.48	21.26	21.14



LTE Band 38 Maximum Average Power [dBm]						
BW [MHz]	RB Size	RB Offset	Mod	Lowest	Middle	Highest
20	1	0	QPSK	23.59	23.56	23.63
20	1	49		23.58	23.47	23.54
20	1	99		23.69	23.68	23.66
20	50	0		22.65	22.57	22.67
20	50	24		22.62	22.54	22.57
20	50	50		22.72	22.63	22.59
20	100	0		22.78	22.60	22.60
20	1	0	16-QAM	22.70	22.83	22.70
20	1	49		22.73	22.63	22.63
20	1	99		22.78	22.75	22.72
20	50	0		21.65	21.60	21.68
20	50	24		21.70	21.57	21.60
20	50	50		21.79	21.67	21.63
20	100	0		21.84	21.63	21.62
15	1	0	QPSK	23.80	23.74	23.76
15	1	37		23.43	23.34	23.36
15	1	74		23.65	23.63	23.58
15	36	0		22.64	22.65	22.57
15	36	20		22.53	22.38	22.45
15	36	39		22.46	22.45	22.40
15	75	0		22.61	22.50	22.51
15	1	0	16-QAM	22.84	22.87	22.81
15	1	37		22.77	22.50	22.38
15	1	74		22.68	22.66	22.62
15	36	0		21.64	21.62	21.57
15	36	20		21.51	21.35	21.40
15	36	39		21.43	21.39	21.36
15	75	0		21.66	21.52	21.59



LTE Band 38 Maximum Average Power [dBm]						
BW [MHz]	RB Size	RB Offset	Mod	Lowest	Middle	Highest
10	1	0	QPSK	23.80	23.78	23.81
10	1	25		23.50	23.49	23.44
10	1	49		23.39	23.38	23.39
10	25	0		22.36	22.37	22.41
10	25	12		22.43	22.39	22.43
10	25	25		22.25	22.36	22.27
10	50	0		22.35	22.28	22.32
10	1	0	16-QAM	22.26	22.28	22.27
10	1	25		22.47	22.47	22.49
10	1	49		22.06	22.10	22.11
10	25	0		21.36	21.38	21.39
10	25	12		21.42	21.39	21.43
10	25	25		21.26	21.33	21.27
10	50	0		21.34	21.37	21.32
5	1	0	QPSK	23.50	23.57	23.61
5	1	12		23.32	23.32	23.33
5	1	24		23.37	23.44	23.42
5	12	0		22.45	22.49	22.39
5	12	7		22.43	22.44	22.41
5	12	13		22.44	22.37	22.39
5	25	0		22.47	22.44	22.43
5	1	0	16-QAM	22.49	22.55	22.48
5	1	12		22.45	22.45	22.51
5	1	24		22.44	22.53	22.46
5	12	0		21.39	21.45	21.44
5	12	7		21.40	21.41	21.41
5	12	13		21.34	21.33	21.41
5	25	0		21.41	21.41	21.43



LTE Band 41 HPUE Maximum Average Power [dBm]						
BW [MHz]	RB Size	RB Offset	Mod	Lowest	Middle	Highest
20	1	0	QPSK	26.10	26.00	25.75
20	1	49		26.18	26.08	25.66
20	1	99		26.38	26.13	25.80
20	50	0		25.44	25.15	24.79
20	50	24		25.45	25.20	24.86
20	50	50		25.35	25.19	24.84
20	100	0		25.42	25.15	24.78
20	1	0	16-QAM	25.64	25.29	24.93
20	1	49		25.52	25.37	25.02
20	1	99		25.50	25.36	25.08
20	50	0		24.39	24.22	23.87
20	50	24		24.38	24.21	23.86
20	50	50		24.39	24.28	23.89
20	100	0		24.48	24.20	23.81
15	1	0	QPSK	25.65	25.89	25.53
15	1	37		26.14	26.09	25.67
15	1	74		26.38	26.35	25.99
15	36	0		25.51	25.41	25.08
15	36	20		25.38	25.30	24.83
15	36	39		25.33	25.23	24.86
15	75	0		25.48	25.34	24.86
15	1	0	16-QAM	25.96	25.78	25.54
15	1	37		25.81	25.55	25.03
15	1	74		25.73	25.63	25.15
15	36	0		24.55	24.42	23.98
15	36	20		24.39	24.29	23.78
15	36	39		24.33	24.23	23.82
15	75	0		24.52	24.42	23.96



LTE Band 41 HPUE Maximum Average Power [dBm]						
BW [MHz]	RB Size	RB Offset	Mod	Lowest	Middle	Highest
10	1	0	QPSK	26.22	26.03	25.68
10	1	25		26.43	26.22	25.85
10	1	49		25.97	25.84	25.80
10	25	0		25.48	25.28	24.86
10	25	12		25.42	25.31	24.92
10	25	25		25.32	25.12	24.70
10	50	0		25.33	25.18	24.80
10	1	0	16-QAM	25.29	25.24	24.82
10	1	25		25.49	25.45	25.02
10	1	49		25.14	25.04	24.69
10	25	0		24.47	24.38	23.88
10	25	12		24.41	24.33	23.93
10	25	25		24.31	24.20	23.78
10	50	0		24.38	24.27	23.84
5	1	0	QPSK	25.86	25.90	25.85
5	1	12		26.29	26.13	25.78
5	1	24		26.29	26.05	25.79
5	12	0		25.49	25.36	24.94
5	12	7		25.47	25.34	24.90
5	12	13		25.46	25.28	24.94
5	25	0		25.44	25.32	24.92
5	1	0	16-QAM	25.60	25.52	25.16
5	1	12		25.55	25.52	25.12
5	1	24		25.53	25.43	25.00
5	12	0		24.44	24.40	23.92
5	12	7		24.43	24.30	23.94
5	12	13		24.44	24.30	23.91
5	25	0		24.51	24.37	23.94



LTE Band 66 Maximum Average Power [dBm]						
BW [MHz]	RB Size	RB Offset	Mod	Lowest	Middle	Highest
20	1	0	QPSK	22.20	22.23	22.37
20	1	49		22.37	22.51	22.92
20	1	99		22.23	22.90	22.63
20	50	0		22.04	21.89	22.42
20	50	24		21.83	21.99	22.24
20	50	50		21.70	22.20	22.12
20	100	0		21.82	22.08	22.13
20	1	0		16-QAM	22.51	22.15
20	1	49	22.40		22.36	22.69
20	1	99	22.50		22.80	22.37
20	50	0	20.96		20.89	21.39
20	50	24	20.80		21.02	21.21
20	50	50	20.70		21.20	21.07
20	100	0	20.83		21.02	21.20
15	1	0	QPSK		22.68	22.24
15	1	37		22.40	22.61	22.82
15	1	74		22.42	22.90	22.75
15	36	0		22.43	22.28	22.72
15	36	20		22.04	22.07	22.32
15	36	39		21.89	22.15	22.14
15	75	0		22.07	22.19	22.43
15	1	0		16-QAM	22.85	22.76
15	1	37	22.05		22.24	22.44
15	1	74	22.21		22.85	22.59
15	36	0	21.40		21.25	21.71
15	36	20	21.05		21.11	21.31
15	36	39	20.89		21.16	21.16
15	75	0	21.06		21.20	21.40



LTE Band 66 Maximum Average Power [dBm]						
BW [MHz]	RB Size	RB Offset	Mod	Lowest	Middle	Highest
10	1	0	QPSK	22.37	22.28	22.06
10	1	25		22.59	22.52	22.66
10	1	49		22.00	22.39	22.26
10	25	0		22.23	22.08	22.37
10	25	12		22.15	22.16	22.25
10	25	25		21.88	22.08	22.09
10	50	0		22.04	22.09	22.13
10	1	0	16-QAM	22.46	22.25	22.60
10	1	25		22.44	22.49	22.56
10	1	49		21.80	22.21	22.06
10	25	0		21.18	21.05	21.36
10	25	12		21.14	21.13	21.23
10	25	25		20.87	21.01	21.06
10	50	0		21.06	21.08	21.14
5	1	0	QPSK	22.19	22.10	22.16
5	1	12		22.59	22.55	22.59
5	1	24		22.62	22.63	22.63
5	12	0		22.32	22.20	22.30
5	12	7		22.25	22.18	22.25
5	12	13		22.18	22.20	22.18
5	25	0		22.22	22.16	22.20
5	1	0	16-QAM	22.42	22.47	22.50
5	1	12		22.36	22.38	22.28
5	1	24		22.37	22.47	22.41
5	12	0		21.35	21.22	21.36
5	12	7		21.27	21.22	21.28
5	12	13		21.19	21.20	21.25
5	25	0		21.17	21.12	21.18



LTE Band 66 Maximum Average Power [dBm]						
BW [MHz]	RB Size	RB Offset	Mod	Lowest	Middle	Highest
3	1	0	QPSK	22.11	22.12	22.07
3	1	8		22.85	22.71	22.81
3	1	14		22.68	22.66	22.63
3	8	0		22.31	22.18	22.27
3	8	4		22.31	22.21	22.25
3	8	7		22.21	22.17	22.22
3	15	0		22.28	22.16	22.21
3	1	0		22.45	22.44	22.45
3	1	8	16-QAM	22.47	22.36	22.30
3	1	14		22.43	22.44	22.32
3	8	0		21.43	21.28	21.39
3	8	4		21.35	21.24	21.38
3	8	7		21.34	21.29	21.31
3	15	0		21.27	21.16	21.26
1.4	1	0		QPSK	22.25	22.20
1.4	1	3	22.78		22.58	22.62
1.4	1	5	22.65		22.56	22.60
1.4	3	0	22.77		22.65	22.70
1.4	3	1	22.78		22.68	22.74
1.4	3	3	22.77		22.66	22.75
1.4	6	0	22.23		22.16	22.21
1.4	1	0	16-QAM		22.45	22.30
1.4	1	3		22.43	22.38	22.41
1.4	1	5		22.49	22.39	22.32
1.4	3	0		22.33	22.21	22.31
1.4	3	1		22.39	22.26	22.36
1.4	3	3		22.38	22.24	22.30
1.4	6	0		21.32	21.18	21.22



LTE Band 2

Peak-to-Average Ratio

Mode	LTE Band 2 / 20MHz				
Mod.	QPSK		16QAM		Limit: 13dB
RB Size	1RB	Full RB	1RB	Full RB	Result
Lowest CH	3.19	4.67	4	5.65	PASS
Middle CH	3.42	4.72	4	5.62	
Highest CH	3.25	4.99	4.03	5.94	



LTE Band 2 / 20MHz / QPSK

Lowest Channel / 1RB

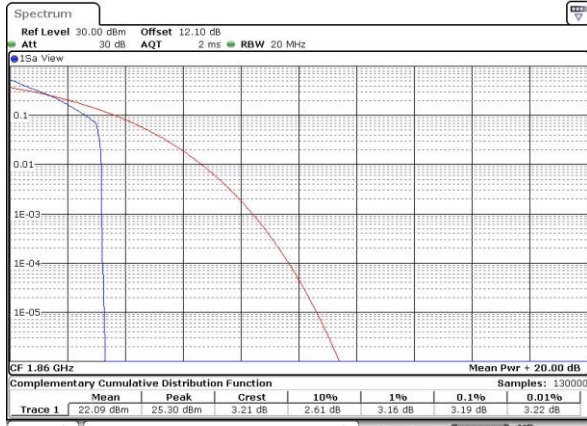

Date: 21_SEP.2018 05:50:44

Lowest Channel / Full RB

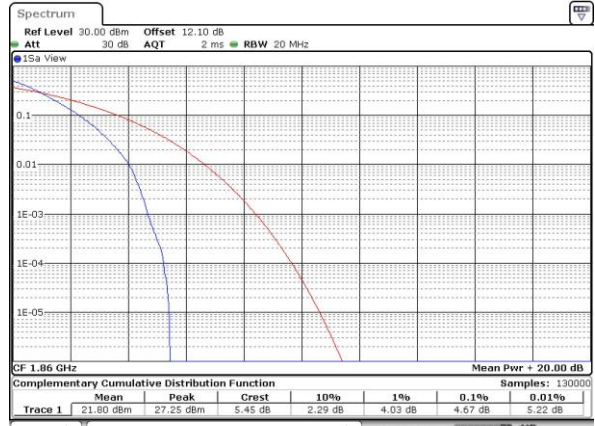

Date: 21_SEP.2018 05:50:56

Middle Channel / 1RB

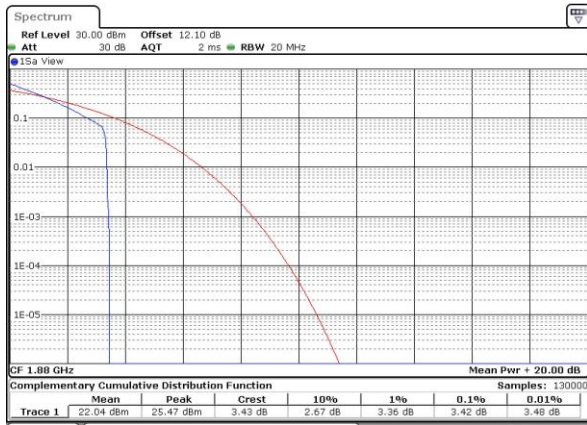

Date: 21_SEP.2018 05:51:08

Middle Channel / Full RB

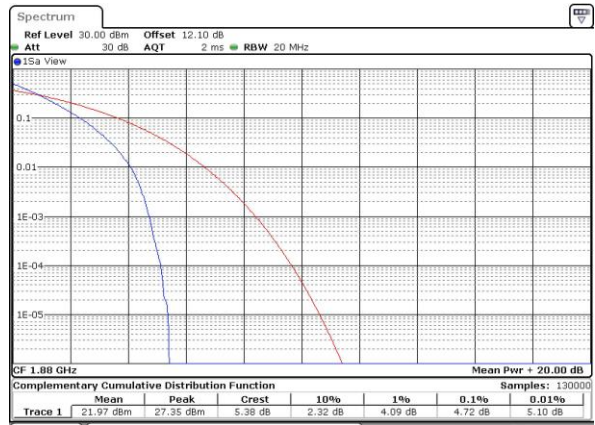

Date: 21_SEP.2018 05:51:20

Highest Channel / 1RB

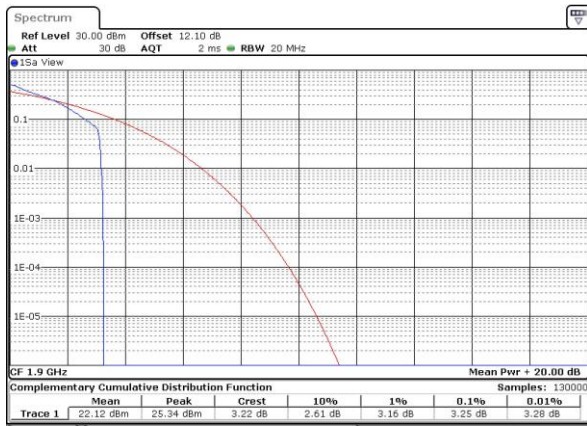

Date: 21_SEP.2018 05:51:32

Highest Channel / Full RB

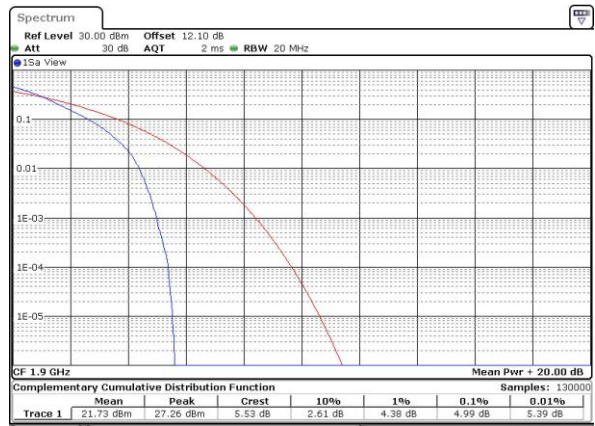

Date: 21_SEP.2018 05:51:44



LTE Band 2 / 20MHz / 16QAM

Lowest Channel / 1RB

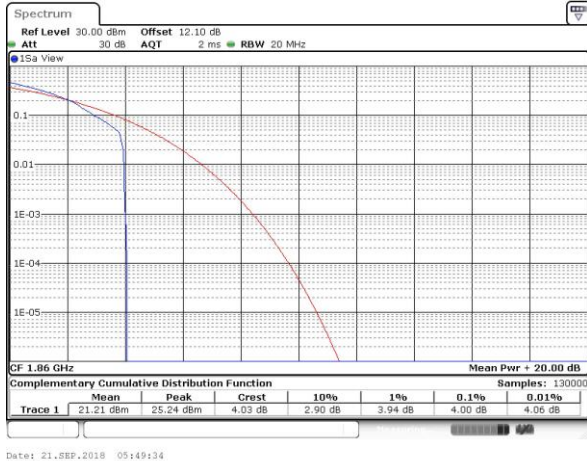

Date: 21_SEP.2018 05:49:14

Lowest Channel / Full RB

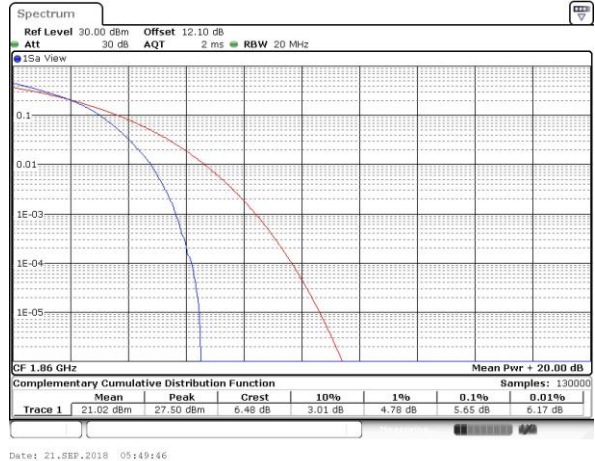

Date: 21_SEP.2018 05:49:16

Middle Channel / 1RB

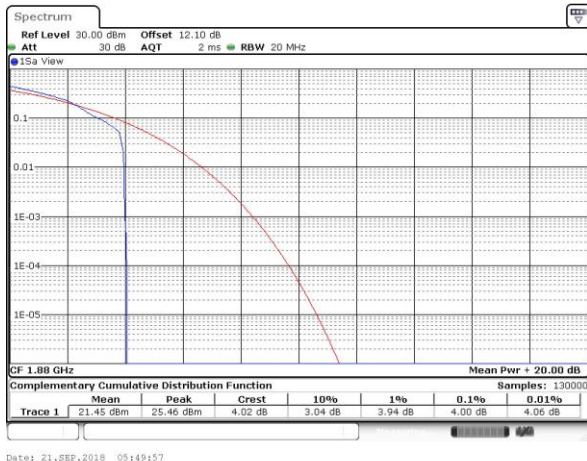

Date: 21_SEP.2018 05:49:57

Middle Channel / Full RB

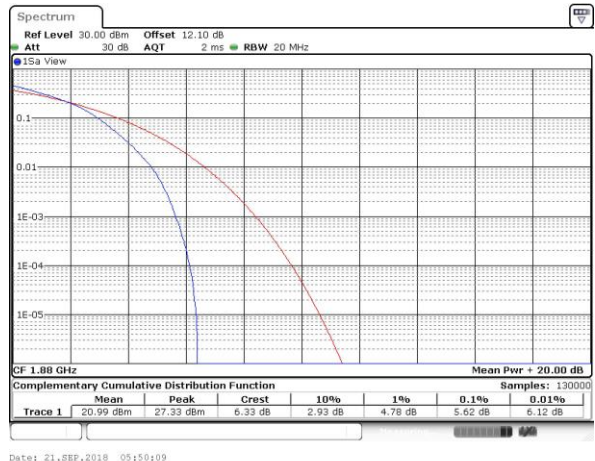

Date: 21_SEP.2018 05:50:09

Highest Channel / 1RB

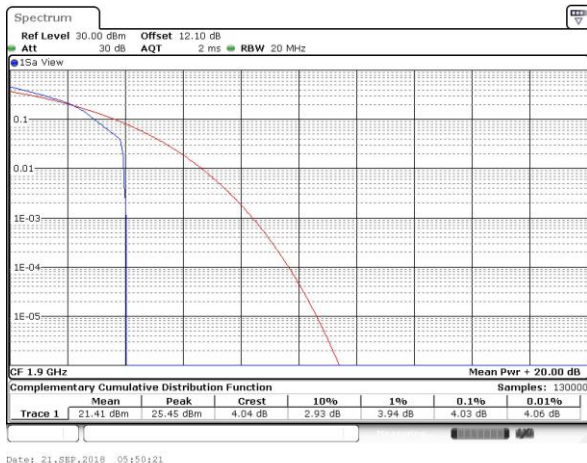

Date: 21_SEP.2018 05:50:21

Highest Channel / Full RB

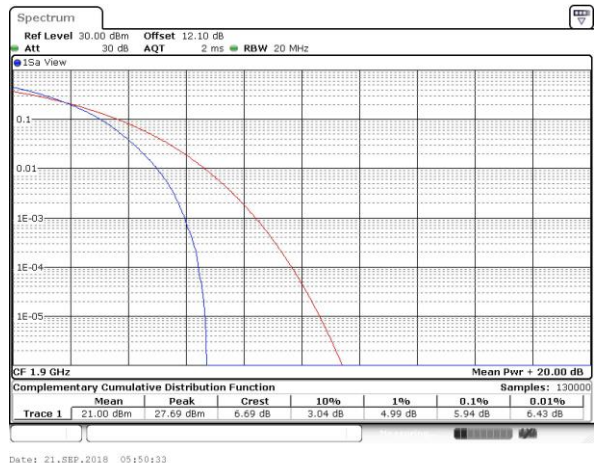

Date: 21_SEP.2018 05:50:33



26dB Bandwidth

Mode	LTE Band 2 : 26dB BW(MHz)											
	1.4MHz		3MHz		5MHz		10MHz		15MHz		20MHz	
BW	QPSK	16QAM	QPSK	16QAM	QPSK	16QAM	QPSK	16QAM	QPSK	16QAM	QPSK	16QAM
Mod.	QPSK	16QAM	QPSK	16QAM	QPSK	16QAM	QPSK	16QAM	QPSK	16QAM	QPSK	16QAM
Lowest CH	1.27	1.25	3.02	3.03	4.88	4.80	9.79	9.89	14.48	14.18	20.1	20.22
Middle CH	1.26	1.26	3.00	2.99	4.96	4.89	9.95	9.81	14.45	14.33	20.14	20.46
Highest CH	1.32	1.30	2.97	3.00	4.85	4.92	9.73	9.69	14.30	14.66	20.14	20.26



LTE Band 2

Lowest Channel / 1.4MHz / QPSK

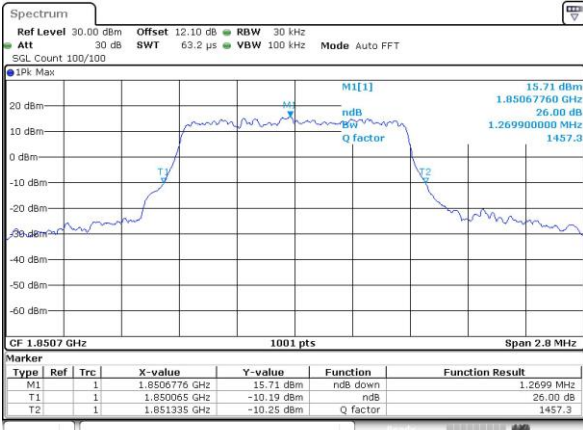

Date: 21_SEP.2018 05:31:25

Lowest Channel / 1.4MHz / 16QAM

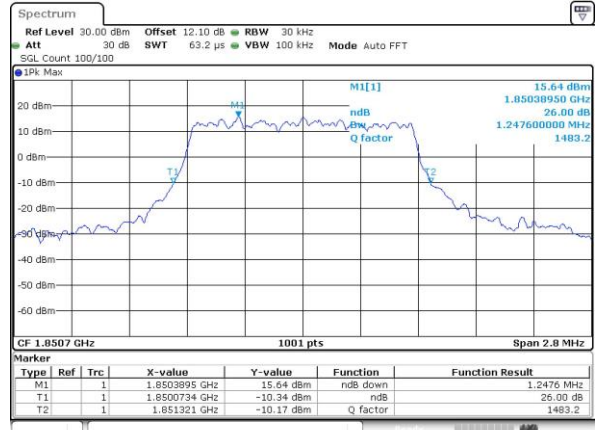

Date: 21_SEP.2018 05:31:38

Middle Channel / 1.4MHz / QPSK

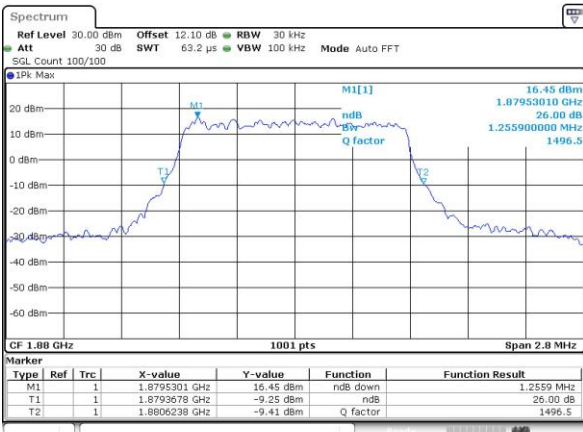

Date: 21_SEP.2018 05:38:46

Middle Channel / 1.4MHz / 16QAM

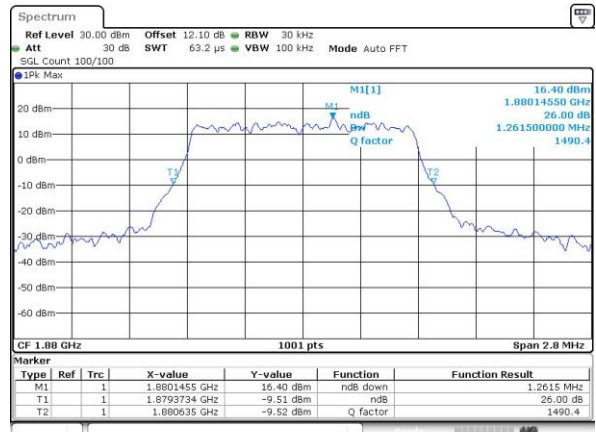

Date: 21_SEP.2018 05:38:59

Highest Channel / 1.4MHz / QPSK

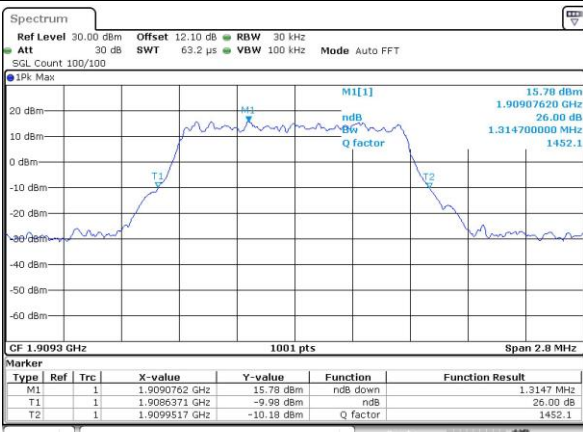

Date: 21_SEP.2018 05:41:26

Highest Channel / 1.4MHz / 16QAM

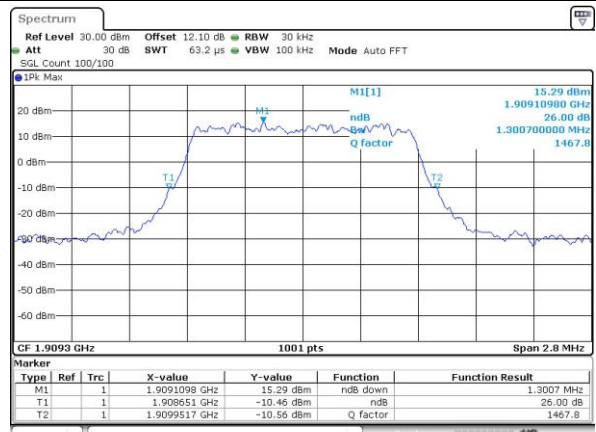

Date: 21_SEP.2018 05:41:39



LTE Band 2

Lowest Channel / 3MHz / QPSK

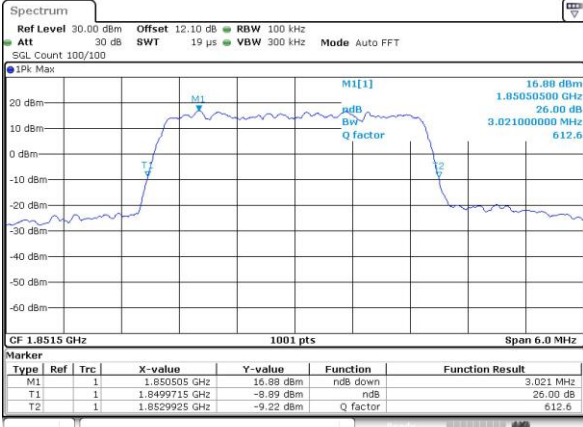

Date: 21_SEP.2018 04:03:46

Lowest Channel / 3MHz / 16QAM

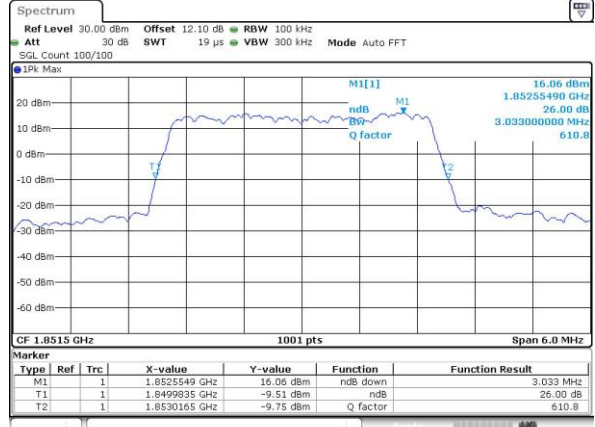

Date: 21_SEP.2018 04:03:59

Middle Channel / 3MHz / QPSK

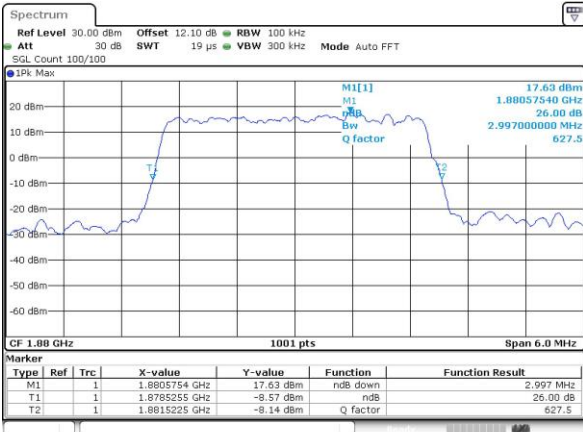

Date: 21_SEP.2018 04:11:08

Middle Channel / 3MHz / 16QAM

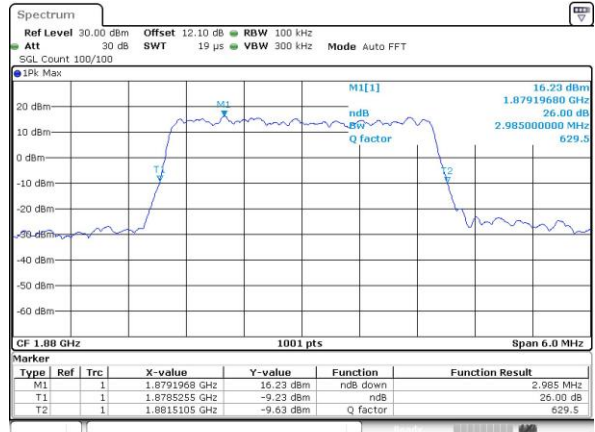

Date: 21_SEP.2018 04:11:20

Highest Channel / 3MHz / QPSK

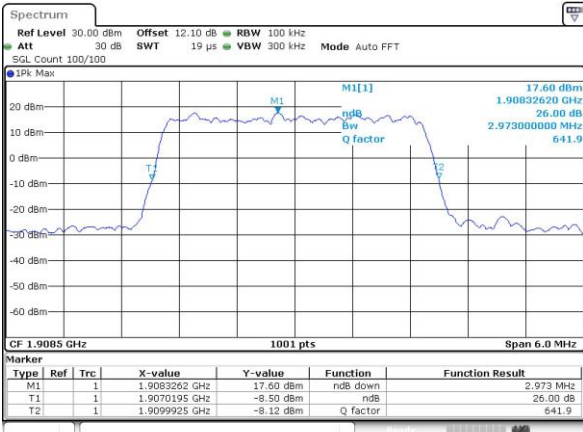

Date: 21_SEP.2018 04:13:48

Highest Channel / 3MHz / 16QAM

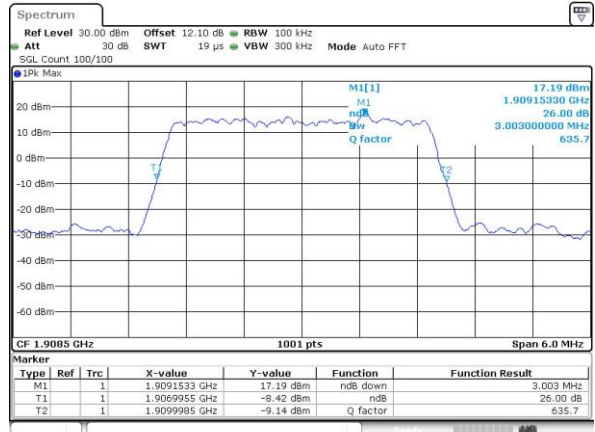

Date: 21_SEP.2018 04:14:00



LTE Band 2

Lowest Channel / 5MHz / QPSK

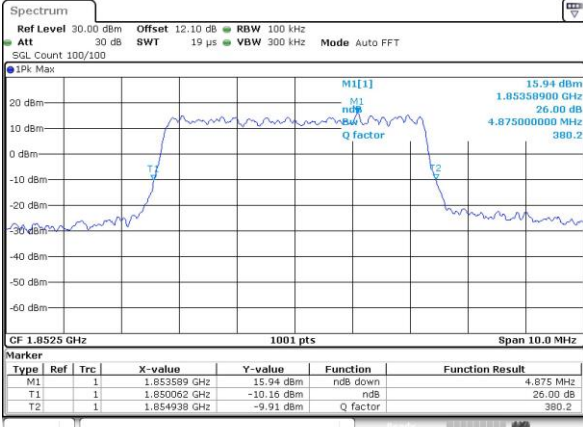

Date: 21_SEP.2018 04:21:08

Lowest Channel / 5MHz / 16QAM

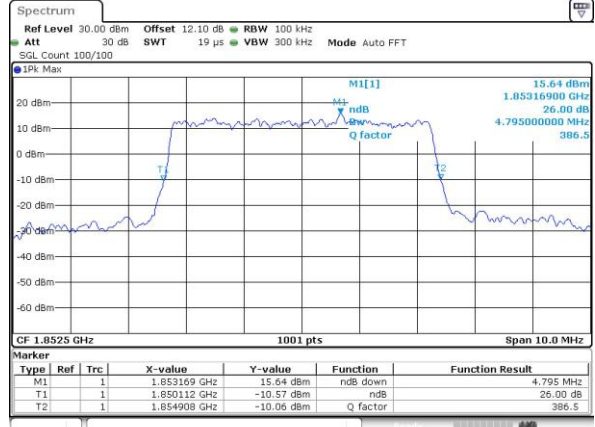

Date: 21_SEP.2018 04:21:21

Middle Channel / 5MHz / QPSK

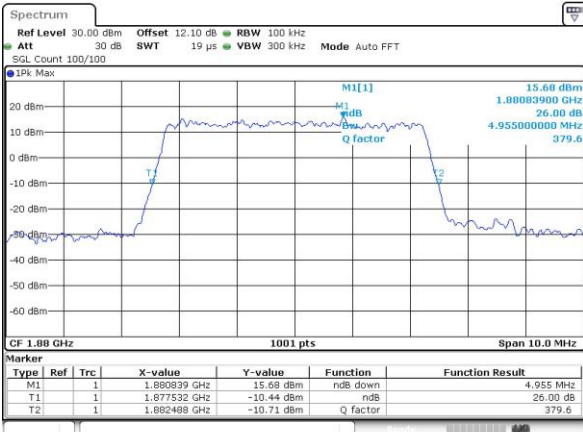

Date: 21_SEP.2018 04:28:29

Middle Channel / 5MHz / 16QAM

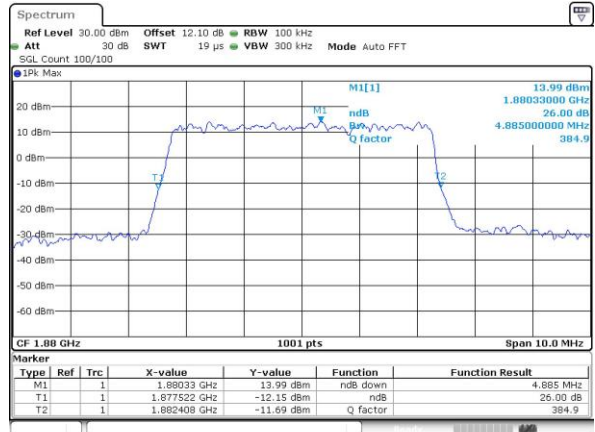

Date: 21_SEP.2018 04:28:42

Highest Channel / 5MHz / QPSK

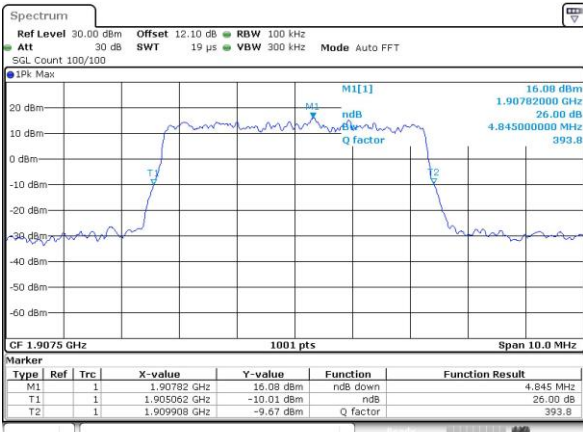

Date: 21_SEP.2018 04:31:09

Highest Channel / 5MHz / 16QAM

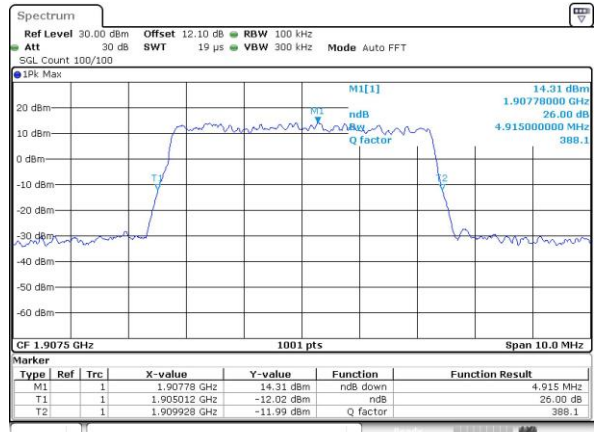

Date: 21_SEP.2018 04:31:22



LTE Band 2

Lowest Channel / 10MHz / QPSK

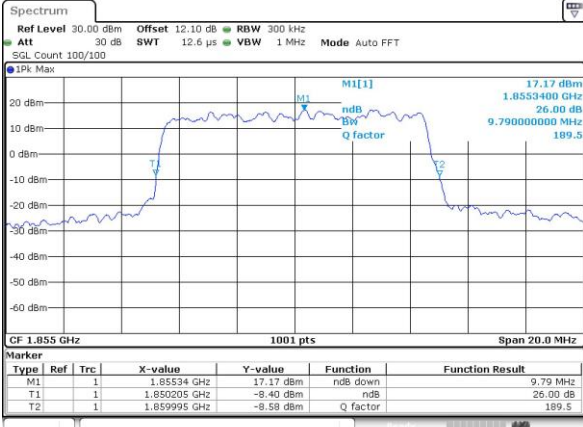

Date: 21_SEP.2018 04:38:30

Lowest Channel / 10MHz / 16QAM

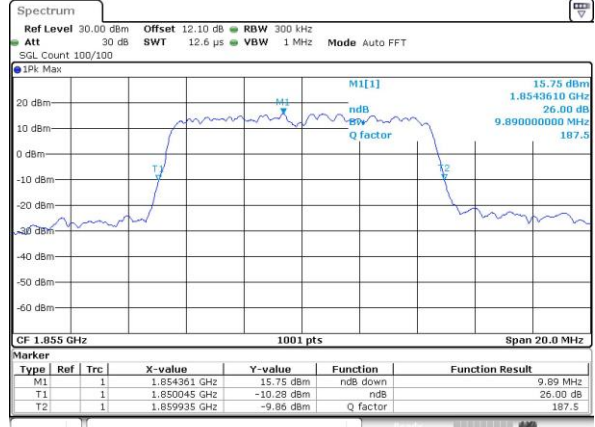

Date: 21_SEP.2018 04:38:43

Middle Channel / 10MHz / QPSK

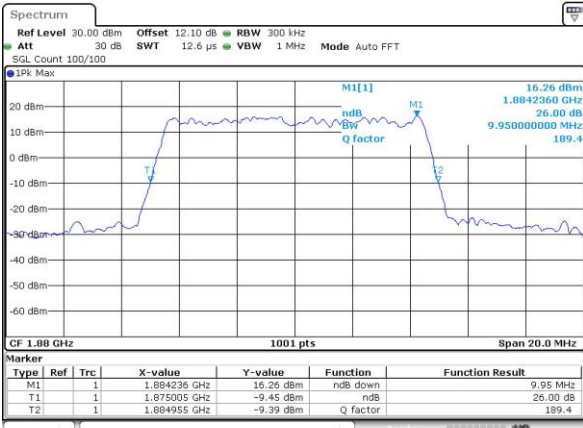

Date: 21_SEP.2018 04:45:51

Middle Channel / 10MHz / 16QAM

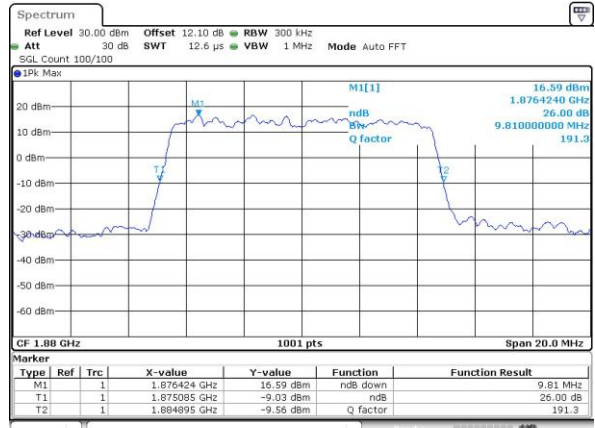

Date: 21_SEP.2018 04:46:04

Highest Channel / 10MHz / QPSK

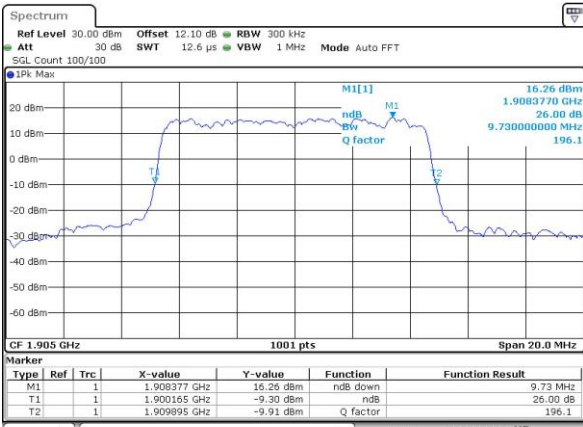

Date: 21_SEP.2018 04:48:31

Highest Channel / 10MHz / 16QAM

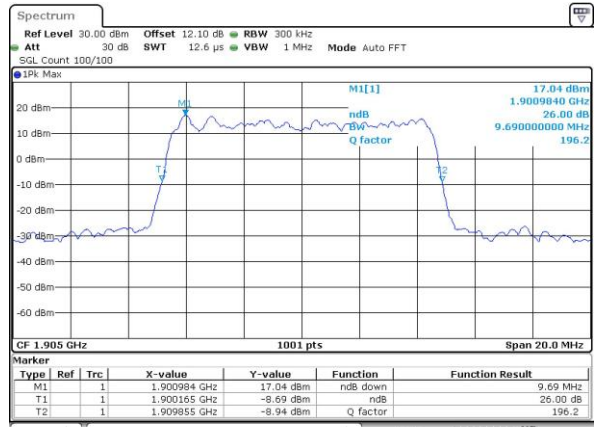

Date: 21_SEP.2018 04:48:44



LTE Band 2

Lowest Channel / 15MHz / QPSK

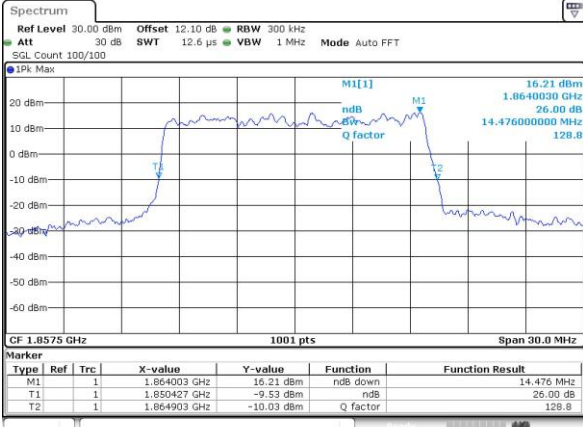

Date: 21_SEP.2018 04:55:13

Lowest Channel / 15MHz / 16QAM

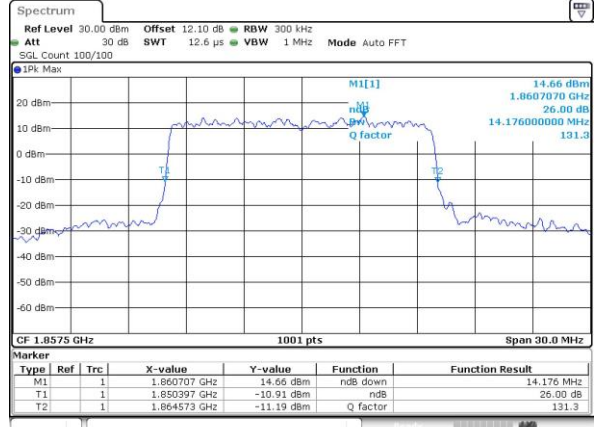

Date: 21_SEP.2018 04:56:05

Middle Channel / 15MHz / QPSK

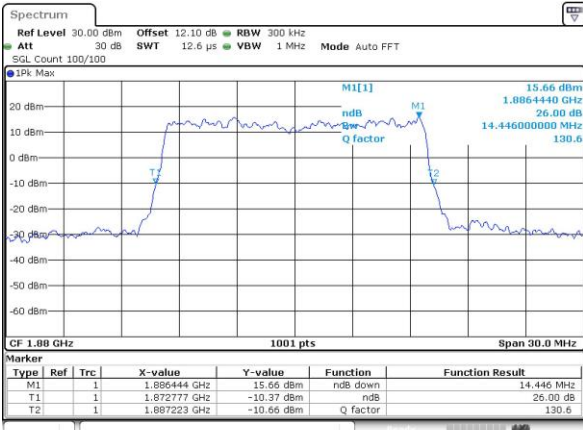

Date: 21_SEP.2018 05:03:13

Middle Channel / 15MHz / 16QAM

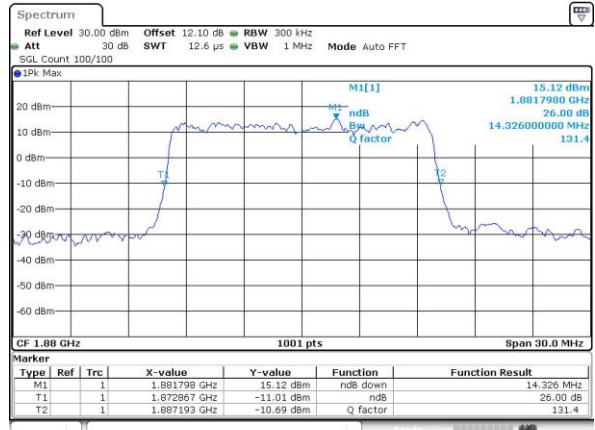

Date: 21_SEP.2018 05:03:26

Highest Channel / 15MHz / QPSK

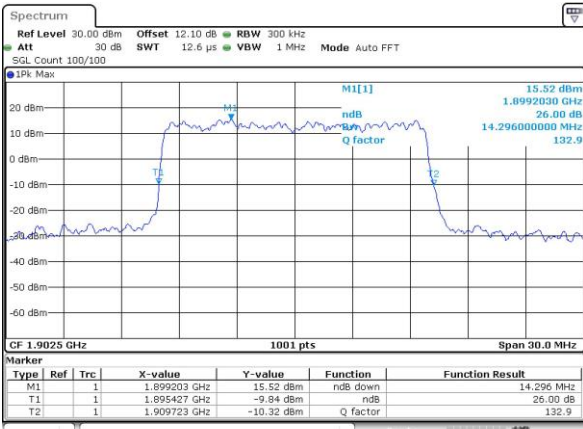

Date: 21_SEP.2018 05:05:13

Highest Channel / 15MHz / 16QAM

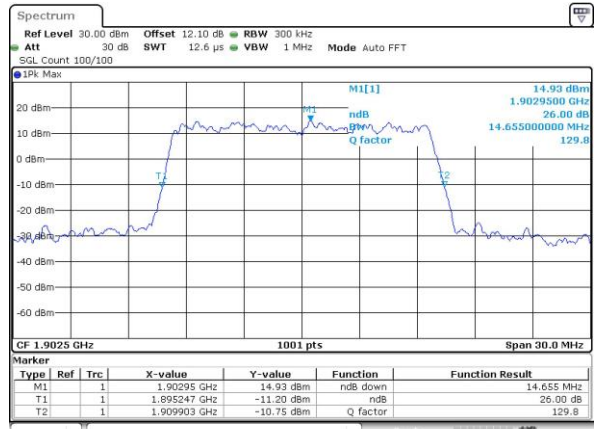

Date: 21_SEP.2018 05:06:06



LTE Band 2

Lowest Channel / 20MHz / QPSK

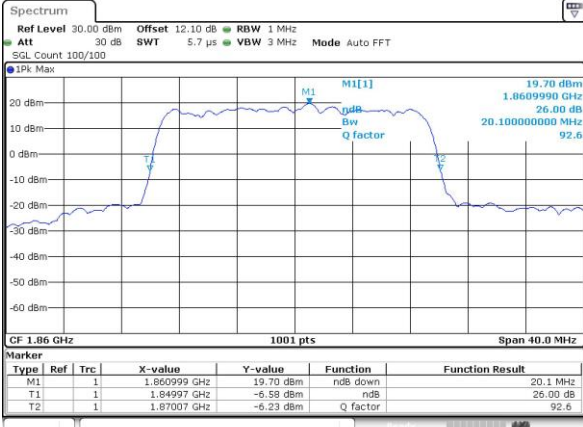

Date: 21_SEP.2018 05:13:14

Lowest Channel / 20MHz / 16QAM

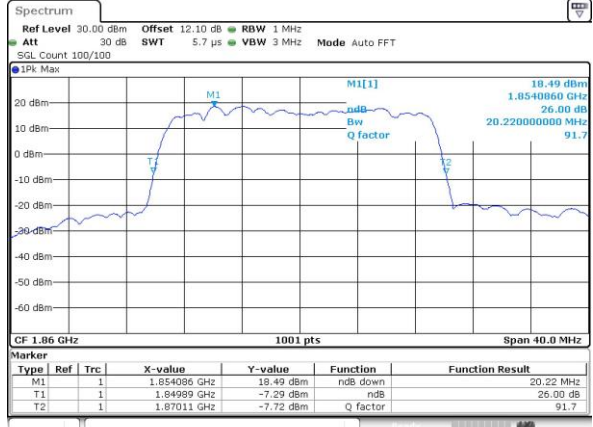

Date: 21_SEP.2018 05:13:27

Middle Channel / 20MHz / QPSK

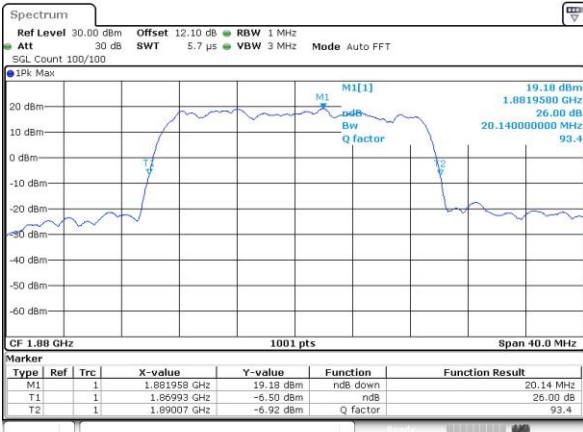

Date: 21_SEP.2018 05:20:36

Middle Channel / 20MHz / 16QAM

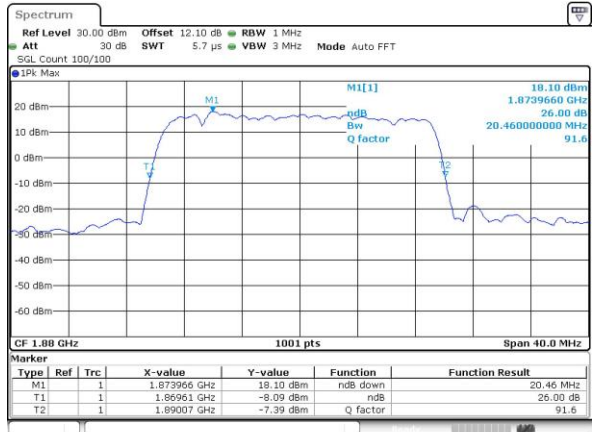

Date: 21_SEP.2018 05:20:49

Highest Channel / 20MHz / QPSK

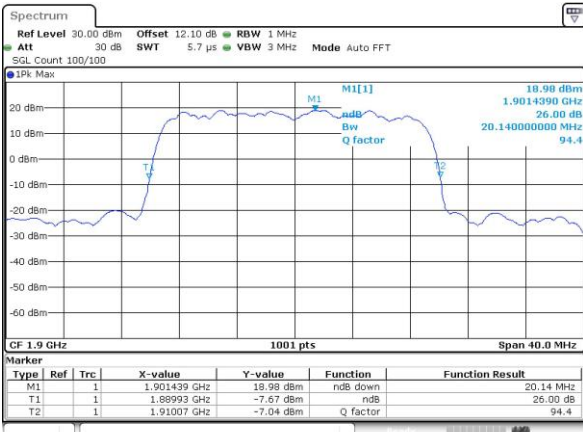

Date: 21_SEP.2018 05:23:15

Highest Channel / 20MHz / 16QAM

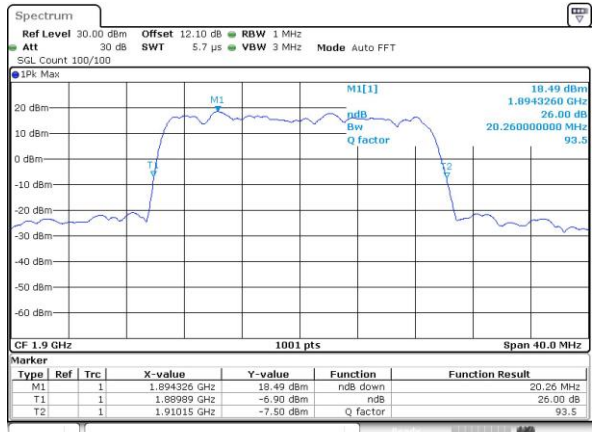

Date: 21_SEP.2018 05:23:28



Occupied Bandwidth

Mode	LTE Band 2 : 99%OBW(MHz)											
	1.4MHz		3MHz		5MHz		10MHz		15MHz		20MHz	
BW												
Mod.	QPSK	16QAM	QPSK	16QAM	QPSK	16QAM	QPSK	16QAM	QPSK	16QAM	QPSK	16QAM
Lowest CH	1.1	1.09	2.7	2.71	4.46	4.49	9.05	8.97	13.4	13.49	18.42	18.34
Middle CH	1.09	1.09	2.75	2.73	4.49	4.48	9.01	9.01	13.43	13.52	18.5	18.34
Highest CH	1.09	1.1	2.72	2.73	4.51	4.51	9.01	8.99	13.52	13.43	18.34	18.46



LTE Band 2

Lowest Channel / 1.4MHz / QPSK

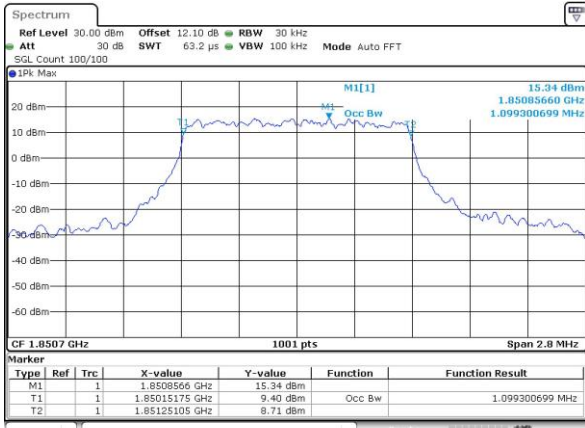

Date: 21_SEP.2018 05:30:58

Lowest Channel / 1.4MHz / 16QAM

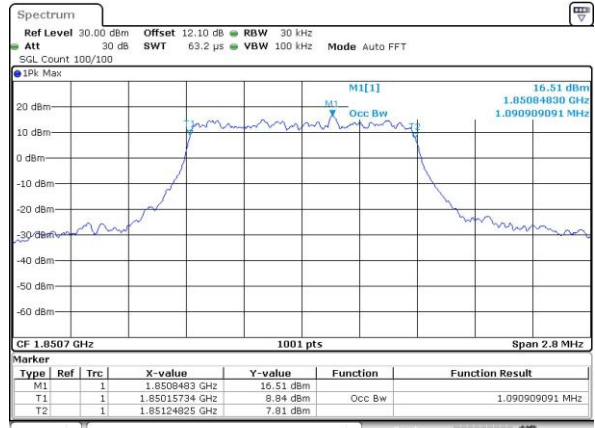

Date: 21_SEP.2018 05:31:12

Middle Channel / 1.4MHz / QPSK

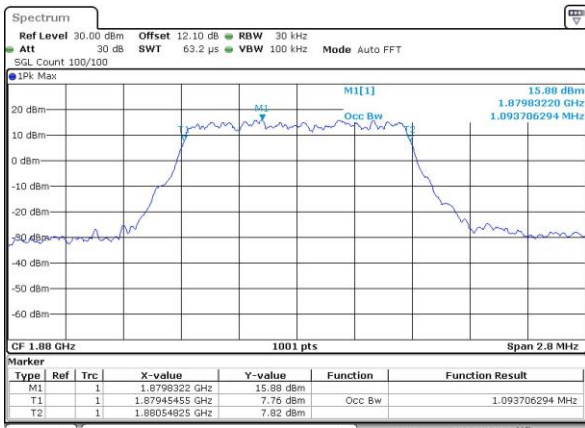

Date: 21_SEP.2018 05:38:20

Middle Channel / 1.4MHz / 16QAM

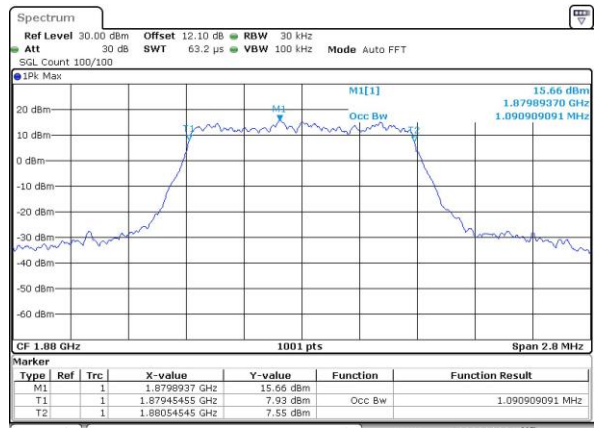

Date: 21_SEP.2018 05:38:33

Highest Channel / 1.4MHz / QPSK

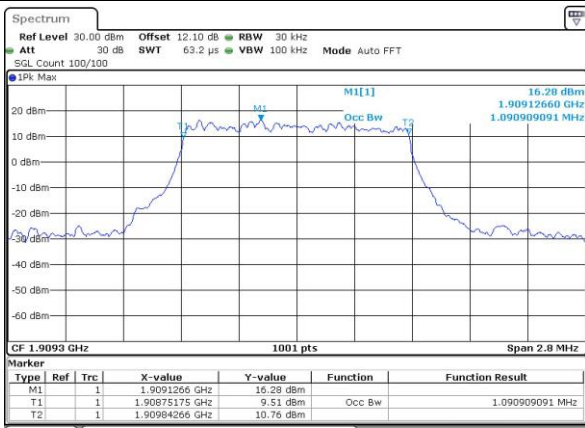

Date: 21_SEP.2018 05:41:00

Highest Channel / 1.4MHz / 16QAM

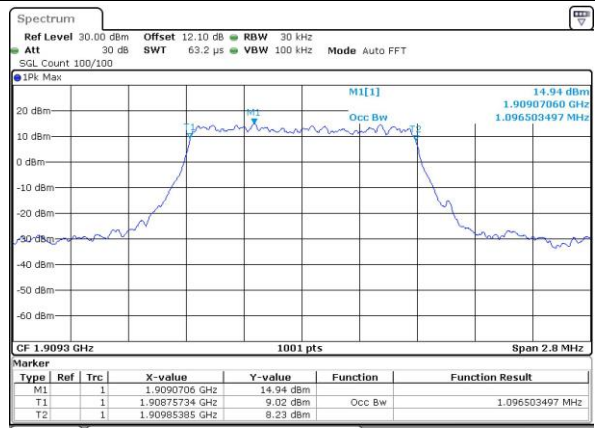

Date: 21_SEP.2018 05:41:13



LTE Band 2

Lowest Channel / 3MHz / QPSK

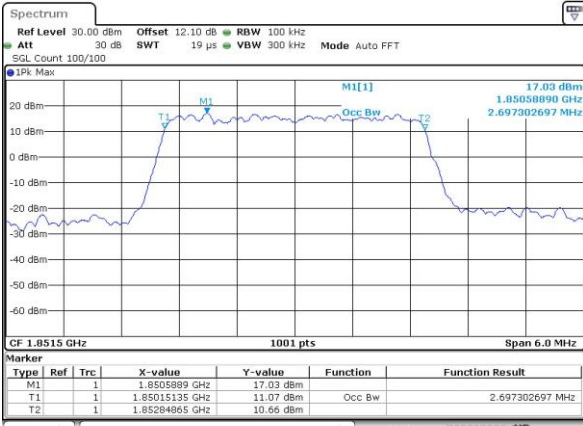

Date: 21_SEP.2018 04:03:21

Lowest Channel / 3MHz / 16QAM

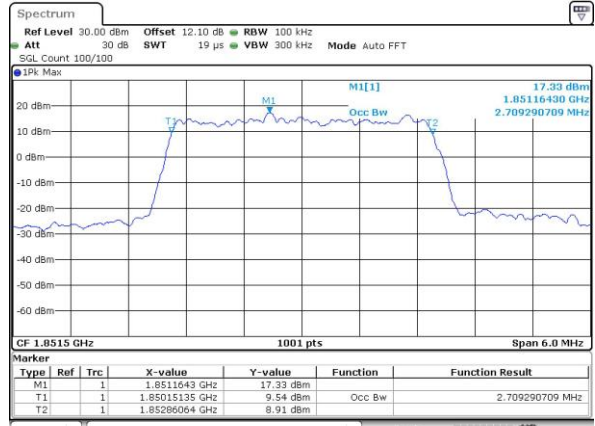

Date: 21_SEP.2018 04:03:33

Middle Channel / 3MHz / QPSK

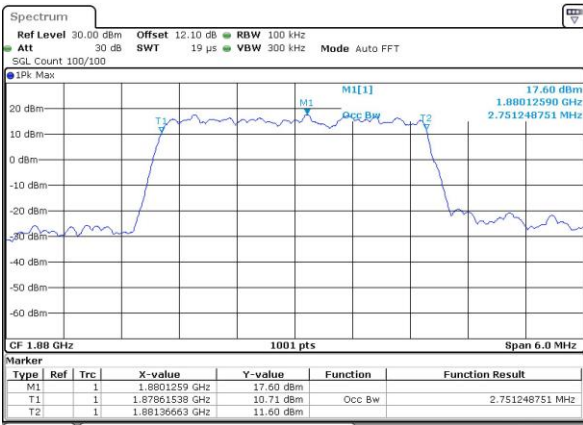

Date: 21_SEP.2018 04:10:42

Middle Channel / 3MHz / 16QAM

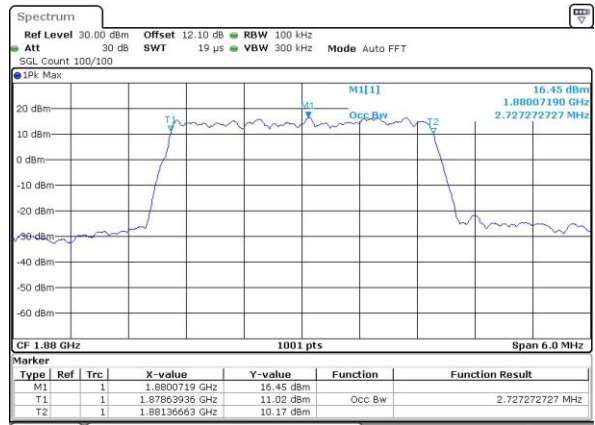

Date: 21_SEP.2018 04:10:55

Highest Channel / 3MHz / QPSK

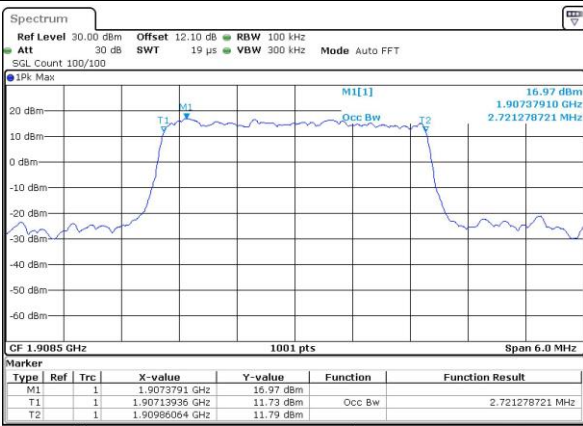

Date: 21_SEP.2018 04:13:22

Highest Channel / 3MHz / 16QAM

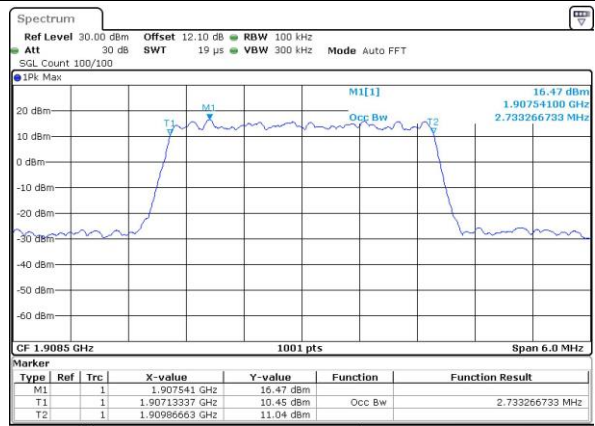

Date: 21_SEP.2018 04:13:35



LTE Band 2

Lowest Channel / 5MHz / QPSK

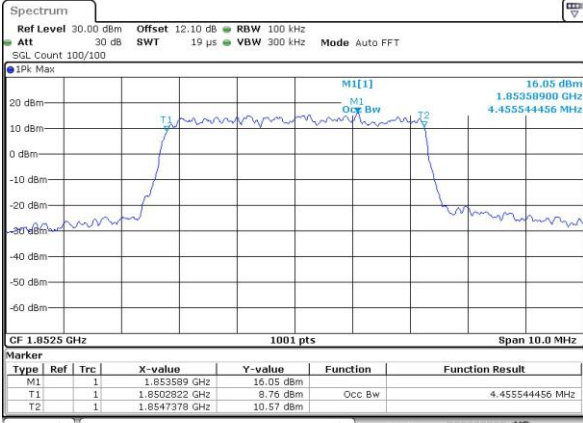

Date: 21_SEP.2018 04:20:42

Lowest Channel / 5MHz / 16QAM

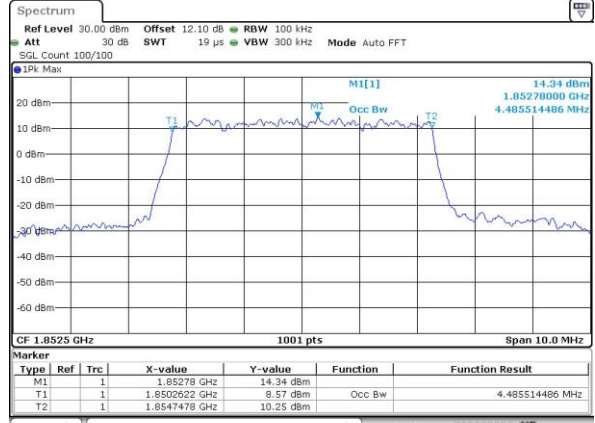

Date: 21_SEP.2018 04:20:55

Middle Channel / 5MHz / QPSK

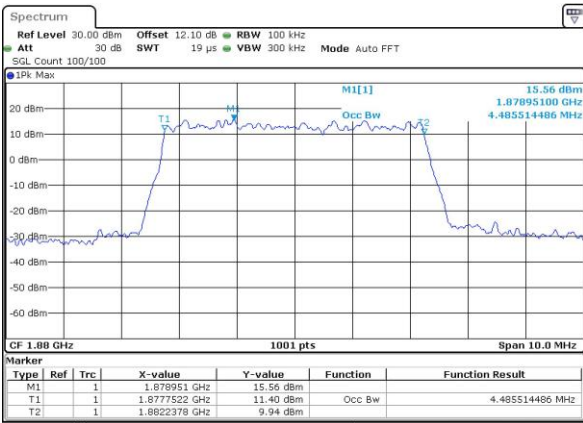

Date: 21_SEP.2018 04:28:03

Middle Channel / 5MHz / 16QAM

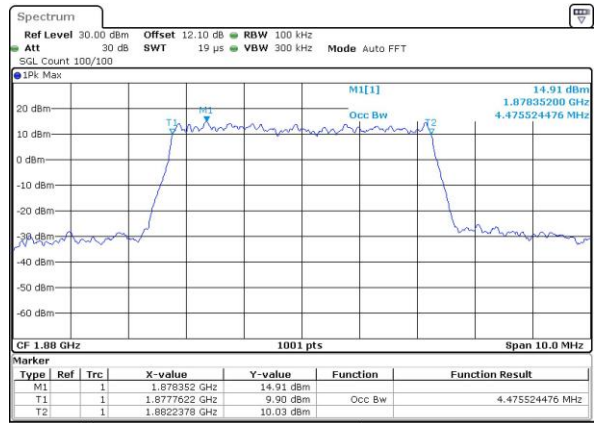

Date: 21_SEP.2018 04:28:16

Highest Channel / 5MHz / QPSK

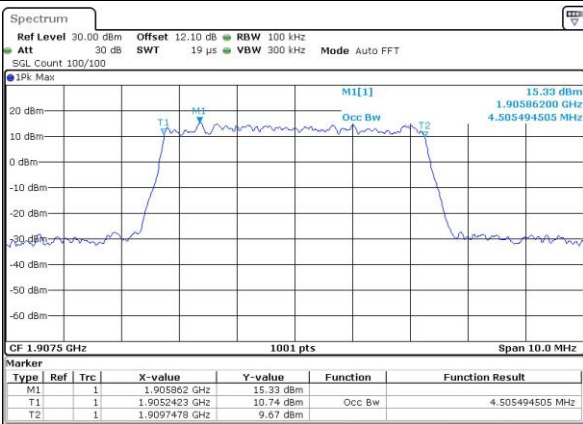

Date: 21_SEP.2018 04:30:43

Highest Channel / 5MHz / 16QAM

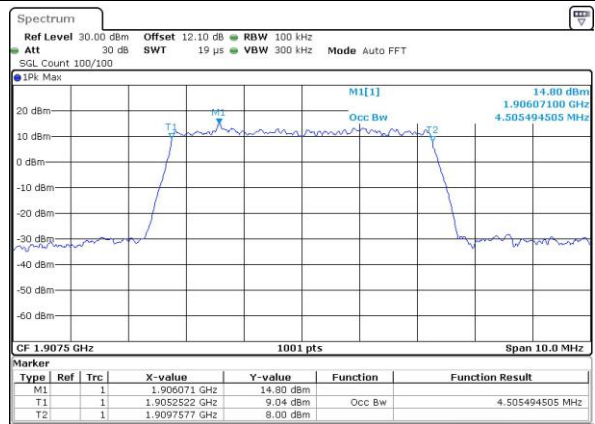

Date: 21_SEP.2018 04:30:56



LTE Band 2

Lowest Channel / 10MHz / QPSK

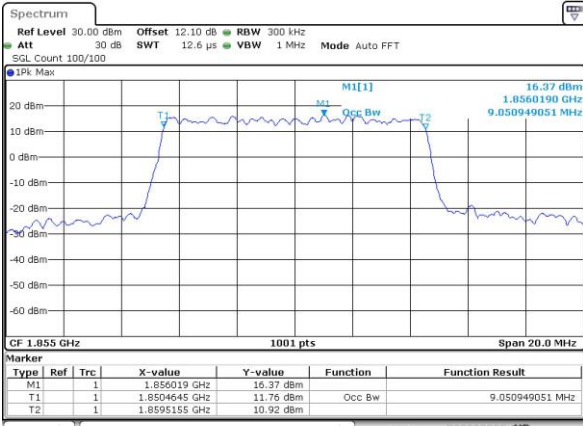

Date: 21_SEP.2018 04:38:04

Lowest Channel / 10MHz / 16QAM

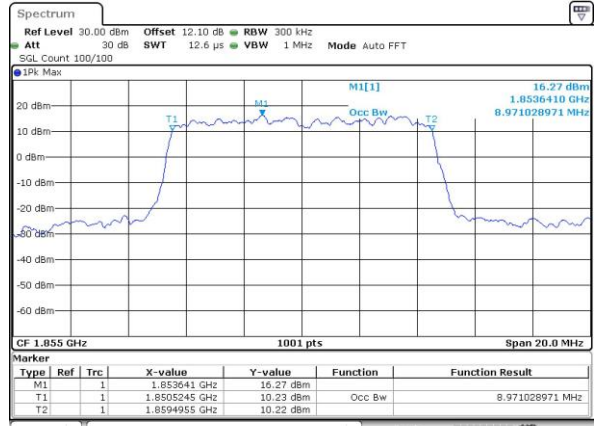

Date: 21_SEP.2018 04:38:17

Middle Channel / 10MHz / QPSK

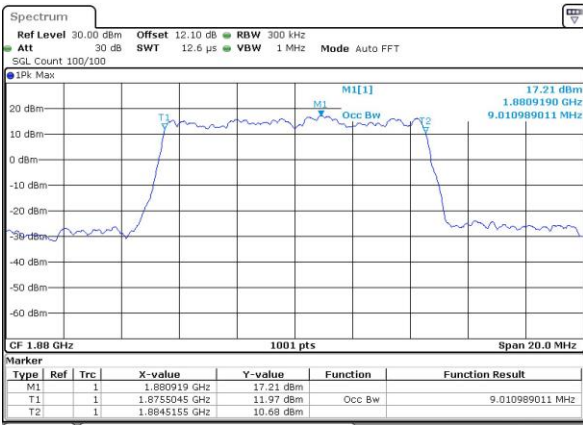

Date: 21_SEP.2018 04:45:25

Middle Channel / 10MHz / 16QAM

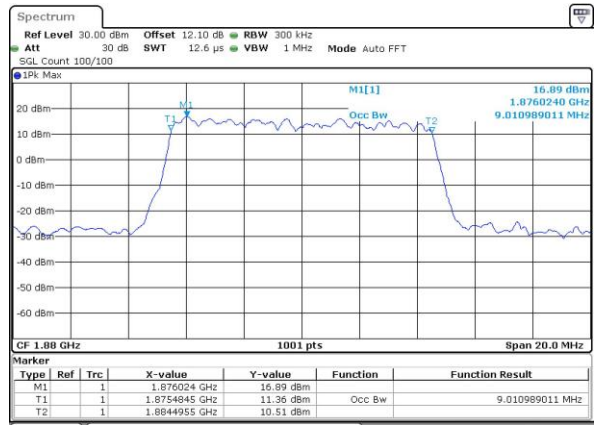

Date: 21_SEP.2018 04:45:38

Highest Channel / 10MHz / QPSK

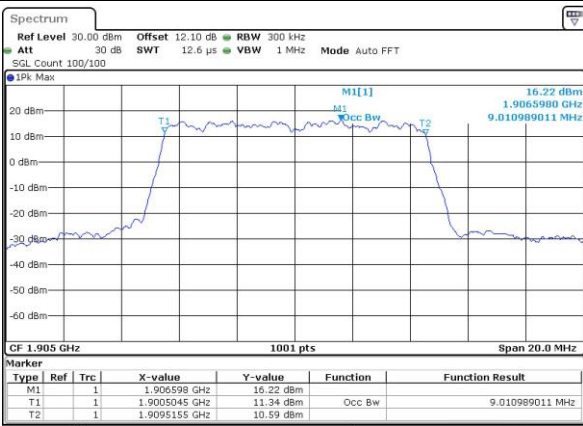

Date: 21_SEP.2018 04:48:06

Highest Channel / 10MHz / 16QAM

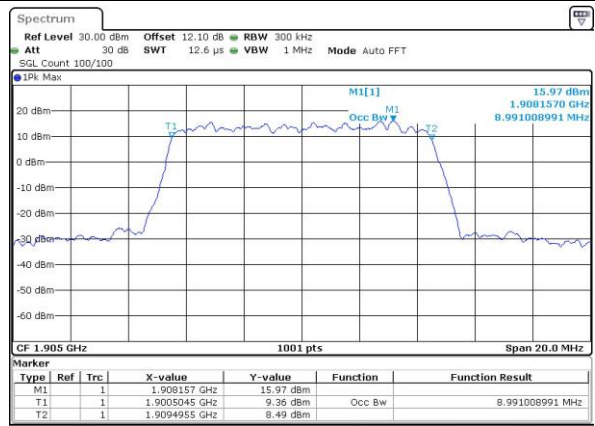

Date: 21_SEP.2018 04:48:19



LTE Band 2

Lowest Channel / 15MHz / QPSK

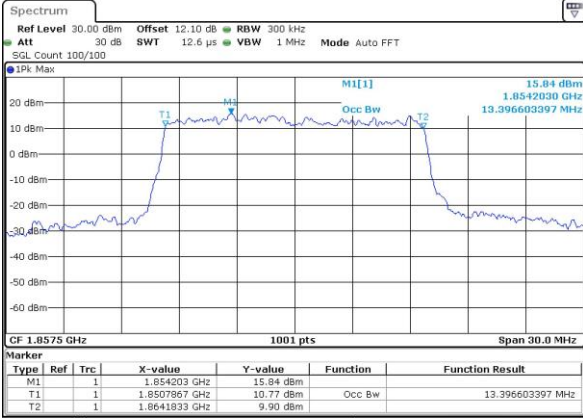

Date: 21_SEP.2018 04:55:27

Lowest Channel / 15MHz / 16QAM

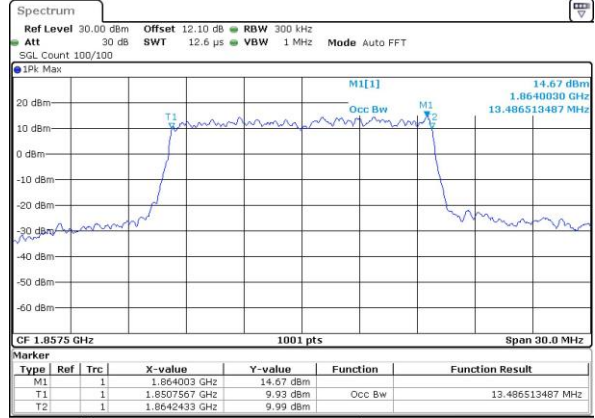

Date: 21_SEP.2018 04:55:40

Middle Channel / 15MHz / QPSK

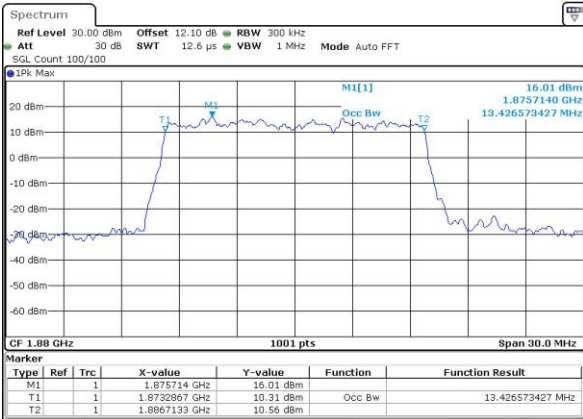

Date: 21_SEP.2018 05:02:47

Middle Channel / 15MHz / 16QAM

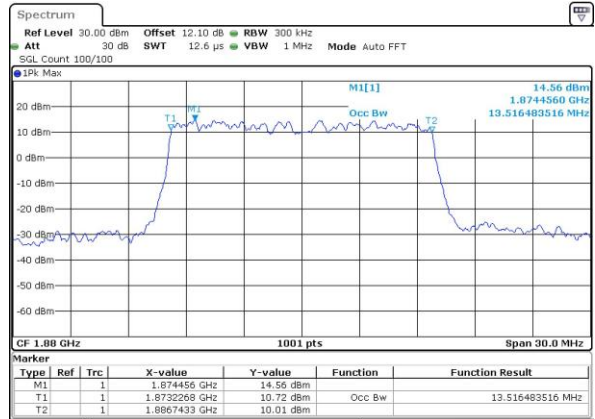

Date: 21_SEP.2018 05:03:00

Highest Channel / 15MHz / QPSK

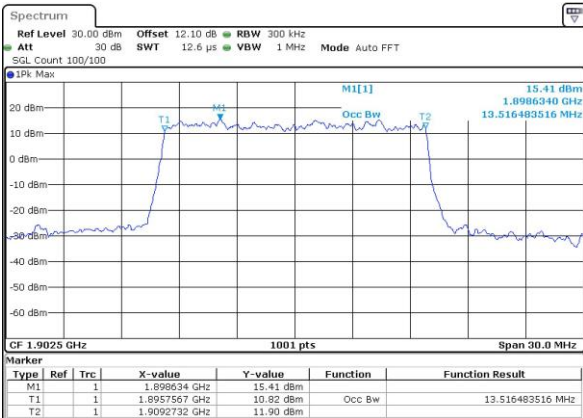

Date: 21_SEP.2018 05:05:27

Highest Channel / 15MHz / 16QAM

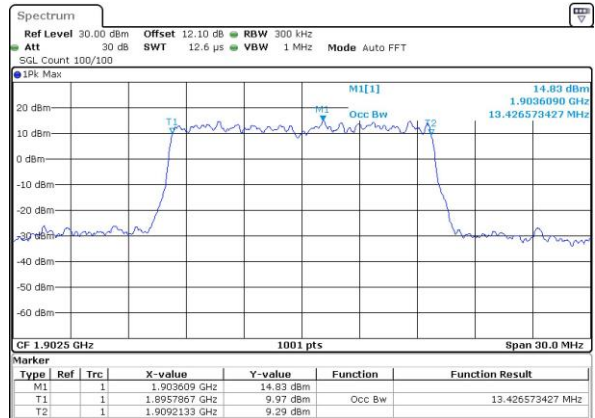

Date: 21_SEP.2018 05:05:40



LTE Band 2

Lowest Channel / 20MHz / QPSK

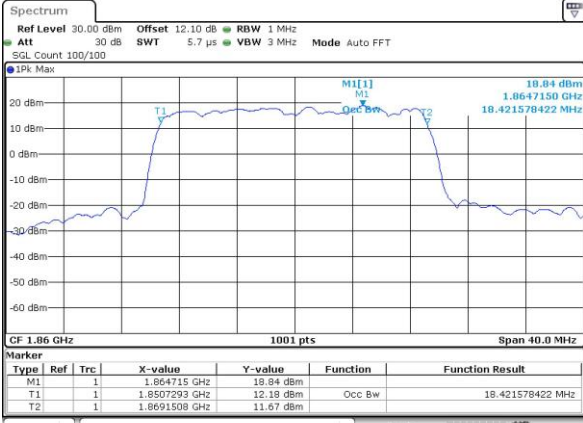

Date: 21_SEP.2018 05:12:49

Lowest Channel / 20MHz / 16QAM

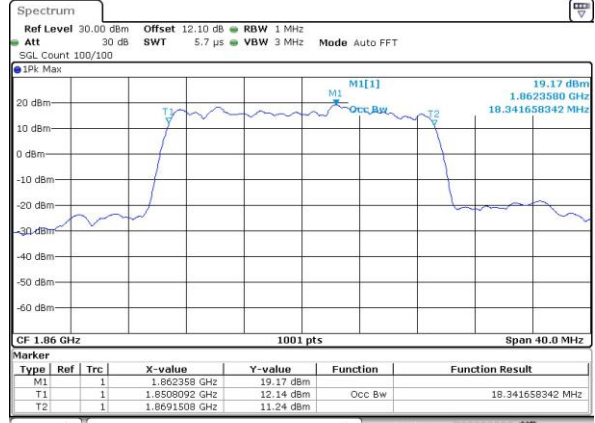

Date: 21_SEP.2018 05:13:02

Middle Channel / 20MHz / QPSK

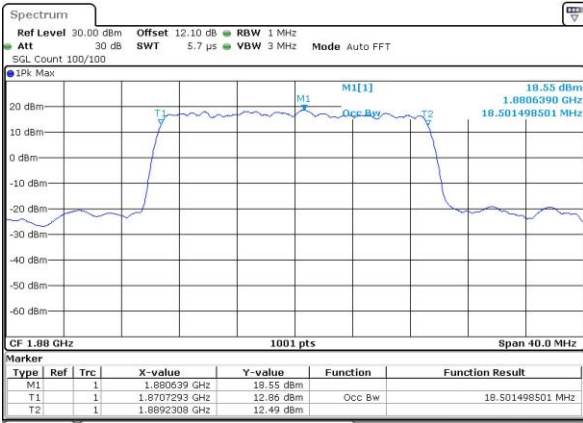

Date: 21_SEP.2018 05:20:10

Middle Channel / 20MHz / 16QAM

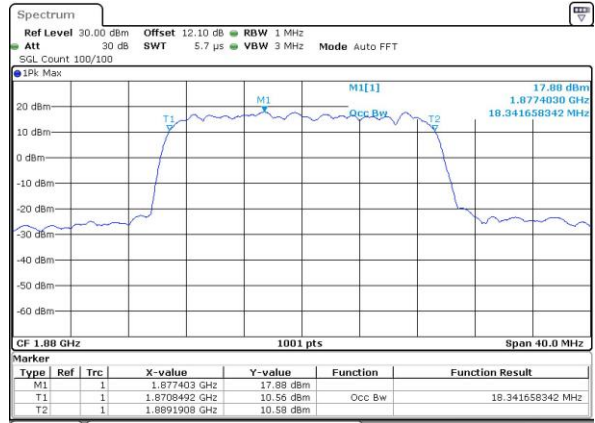

Date: 21_SEP.2018 05:20:23

Highest Channel / 20MHz / QPSK

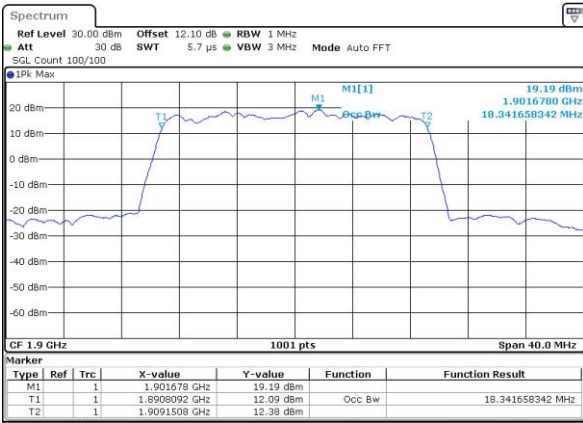

Date: 21_SEP.2018 05:22:50

Highest Channel / 20MHz / 16QAM

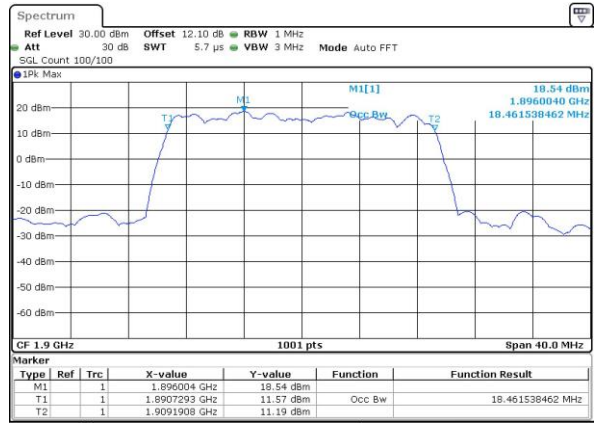

Date: 21_SEP.2018 05:23:02