



FCC CO-LOCATION RADIO TEST REPORT

FCC ID : IHDT56XN2
Equipment : Mobile Cellular Phone
Brand Name : Motorola
Model Name : XT1965-2
Applicant : Motorola Mobility LLC
222 W,Merchandise Mart Plaza, Chicago IL
60654 USA
Manufacturer : Motorola Mobility LLC
222 W,Merchandise Mart Plaza, Chicago IL
60654 USA
Standard : FCC Part 15 Subpart E §15.407

The product was received on Sep. 04, 2018 and testing was started from Sep. 16, 2018 and completed on Sep. 30, 2018. We, SPORTON INTERNATIONAL INC., would like to declare that the tested sample has been evaluated in accordance with the test procedures and has been in compliance with the applicable technical standards.

The report must not be used by the client to claim product certification, approval, or endorsement by TAF or any agency of government.

The test results in this report apply exclusively to the tested model / sample. Without written approval of SPORTON INTERNATIONAL INC. EMC & Wireless Communications Laboratory, the test report shall not be reproduced except in full.

Approved by: Joseph Lin

SPORTON INTERNATIONAL INC. EMC & Wireless Communications Laboratory
No. 52, Huaya 1st Rd., Guishan Dist., Taoyuan City, Taiwan (R.O.C.)



Table of Contents

History of this test report	3
Summary of Test Result	4
1 General Description	5
1.1 Product Feature of Equipment Under Test.....	5
1.2 Product Specification of Equipment Under Test.....	7
1.3 Modification of EUT.....	7
1.4 Testing Location.....	8
1.5 Applicable Standards	8
2 Test Configuration of Equipment Under Test	9
2.1 Carrier Frequency and Channel	9
2.2 Test Mode	9
2.3 Connection Diagram of Test System.....	10
2.4 EUT Operation Test Setup	10
3 Test Result.....	11
3.1 Unwanted Emissions Measurement	11
3.2 Antenna Requirements	15
4 List of Measuring Equipment	16
5 Uncertainty of Evaluation	17
Appendix A. Radiated Spurious Emission	
Appendix B. Radiated Spurious Emission Plots	
Appendix C. Duty Cycle Plots	



Summary of Test Result

Report Clause	Ref Std. Clause	Test Items	Result (PASS/FAIL)	Remark
3.1	15.407(b)	Unwanted Emissions	Pass	Under limit 3.73 dB at 31.080 MHz
3.2	15.203 15.407(a)	Antenna Requirement	Pass	-

Reviewed by: Wii Chang

Report Producer: Natasha Hsieh



1 General Description

1.1 Product Feature of Equipment Under Test

Product Feature	
Equipment	Mobile Cellular Phone
Brand Name	Motorola
Model Name	XT1965-2
Sample 1	Dual SIM
Sample 2	Single SIM
FCC ID	IHDT56XN2
IMEI Code	Radiation : IMEI 1: 355577090033414 IMEI 2: 355577090033422 IMEI 1: 355577090033455 IMEI 2: 355577090033463
EUT supports Radios application	GSM/EGPRS/WCDMA/HSPA/LTE/GNSS/NFC/FM WLAN 11b/g/n/ac HT20/VHT20 WLAN 11a/n HT20/HT40 WLAN 11ac VHT20/VHT40/VHT80 Bluetooth BR/EDR/LE
HW Version	DVT1-B
EUT Stage	Identical Prototype

Remark: The above EUT's information was declared by manufacturer.



Accessory List	
AC Adapter 1	Brand Name : Motorola
	Model Name : SC-31
	Manufacturer : Salom
AC Adapter 1	Brand Name : Motorola
	Model Name : SC-32
	Manufacturer : Salom
AC Adapter 1	Brand Name : Motorola
	Model Name : SC-37
	Manufacturer : Salom
AC Adapter 1	Brand Name : Motorola
	Model Name : SC-36
	Manufacturer : Salom
AC Adapter 1	Brand Name : Motorola
	Model Name : SC-32
	Manufacturer : Salom
AC Adapter 2	Brand Name : Motorola
	Model Name : SC-31
	Manufacturer : Acbel
AC Adapter 2	Brand Name : Motorola
	Model Name : SC-32
	Manufacturer : Acbel
AC Adapter 2	Brand Name : Motorola
	Model Name : SC-36
	Manufacturer : Acbel
AC Adapter 2	Brand Name : Motorola
	Model Name : SC-37
	Manufacturer : Acbel
Battery	Brand Name : Motorola
	Model Name : JG40
	Manufacturer : Amperex
Earphone	Brand Name : Motorola
	Model Name : SH38C37773
	Manufacturer : Lyand
USB Cable 1	Brand Name : Cabletech
	Model Name : SC18C37155
USB Cable 2	Brand Name : Luxshare
	Model Name : SC18C37156
USB Cable 3	Brand Name : Saibao
	Model Name : SC18C37157



1.2 Product Specification of Equipment Under Test

Standards-related Product Specification	
Tx/Rx Frequency Range	2402 MHz ~ 2480 MHz 5180 MHz ~ 5240 MHz 5260 MHz ~ 5320 MHz 5500 MHz ~ 5720 MHz
Antenna Type / Gain	<2400 MHz ~ 2483.5 MHz> Internal Loop Antenna with gain -2.04 dBi <5150 MHz ~ 5250 MHz> Internal Antenna with gain -1.80 dBi <5250 MHz ~ 5350 MHz> Internal Antenna with gain -1.82 dBi <5470 MHz ~ 5725 MHz> Internal Antenna with gain -1.57 dBi
Type of Modulation	Bluetooth LE : GFSK 802.11a/n : OFDM (BPSK / QPSK / 16QAM / 64QAM) 802.11ac : OFDM (BPSK / QPSK / 16QAM / 64QAM / 256QAM)

Remark: The WLAN operation in 5600 MHz ~ 5650 MHz is notched.

1.3 Modification of EUT

No modifications are made to the EUT during all test items.



1.4 Testing Location

Sporton Lab is accredited to ISO 17025 by Taiwan Accreditation Foundation (TAF code : 1190) and the FCC designation No. TW0007 under the FCC 2.948(e) by Mutual Recognition Agreement (MRA) in FCC Test.

Test Site	SPORTON INTERNATIONAL INC.
Test Site Location	No.58, Aly. 75, Ln. 564, Wenhua 3rd, Rd., Guishan Dist., Taoyuan City, Taiwan (R.O.C.) TEL: +886-3-327-0868 FAX: +886-3-327-0855
Test Site No.	Sporton Site No. 03CH15-HY

Note: The test site complies with ANSI C63.4 2014 requirement.

1.5 Applicable Standards

According to the specifications of the manufacturer, the EUT must comply with the requirements of the following standards:

- ♦ FCC Part 15 Subpart E
- ♦ FCC KDB 789033 D02 General UNII Test Procedures New Rules v02r01.
- ♦ FCC KDB Publication No. 558074 D01 DTS Meas. Guidance v04
- ♦ FCC KDB 414788 D01 Radiated Test Site v01r01.
- ♦ ANSI C63.10-2013

Remark:

1. All test items were verified and recorded according to the standards and without any deviation during the test.
2. This EUT has also been tested and complied with the requirements of FCC Part 15, Subpart B, recorded in a separate test report.



2 Test Configuration of Equipment Under Test

- a. The EUT has been associated with peripherals and configuration operated in a manner tended to maximize its emission characteristics in a typical application. Frequency range investigated: radiation emission (9 kHz to the 10th harmonic of the highest fundamental frequency or to 40 GHz, whichever is lower). For radiated measurement, pre-scanned in three orthogonal panels, X, Y, Z. The worst cases (X plane) were recorded in this report.

2.1 Carrier Frequency and Channel

5470-5725 MHz 802.11n HT20	
Channel	Freq. (MHz)
100	5500

2400-2483.5 MHz Bluetooth - LE	
Channel	Freq. (MHz)
39	2480

2.2 Test Mode

Final test modes are considering the modulation and worse data rates as below table.

<Co-Location>

Modulation	Data Rate
802.11n HT20 + Bluetooth LE	MCS0 + 2 Mbps

2.3 Connection Diagram of Test System

<WLAN Tx Mode>

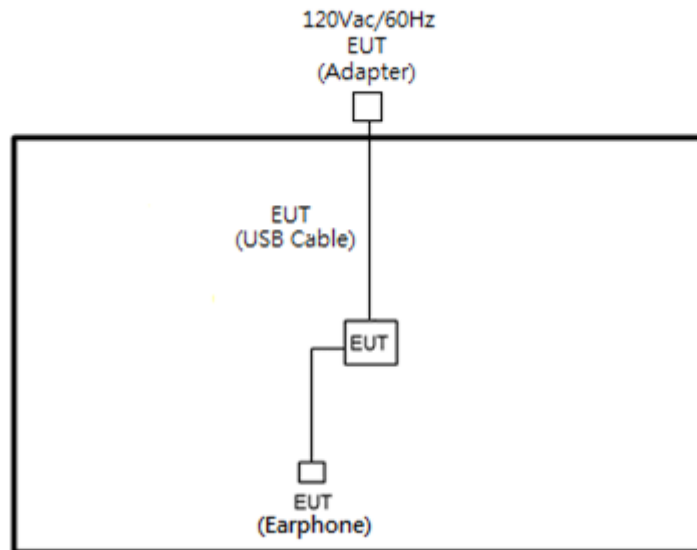

2.4 EUT Operation Test Setup

The RF test items, utility “CMD” was installed in Notebook which was programmed in order to make the EUT get into the engineering modes to provide channel selection, power level, data rate and the application type and for continuous transmitting signals.



3 Test Result

3.1 Unwanted Emissions Measurement

3.1.1 Limit of Unwanted Emissions

(1) Unwanted spurious emissions fallen in restricted bands shall comply with the general field strength limits as below table,

Frequency (MHz)	Field Strength (microvolts/meter)	Measurement Distance (meters)
0.009 – 0.490	2400/F(kHz)	300
0.490 – 1.705	24000/F(kHz)	30
1.705 – 30.0	30	30
30 – 88	100	3
88 – 216	150	3
216 - 960	200	3
Above 960	500	3

Note: The following formula is used to convert the EIRP to field strength.

$$E = \frac{1000000\sqrt{30P}}{3} \text{ } \mu\text{V/m, where P is the eirp (Watts)}$$

EIRP (dBm)	Field Strength at 3m (dBμV/m)
- 27	68.3

(2) KDB789033 D02 v02r01 G)2)c)

- (i) Section 15.407(b)(1) to (b)(3) specify the unwanted emission limits for the U-NII-1 and U-NII-2 bands. As specified, emissions above 1000 MHz that are outside of the restricted bands are subject to a peak emission limit of -27 dBm/MHz.³
- (ii) Section 15.407(b)(4) specifies the unwanted emission limit for the U-NII-3 band. A band emissions mask is specified in Section 15.407(b)(4)(i). The emission limits are in terms of a Peak detector. An alternative to the band emissions mask is specified in Section 15.407(b)(4)(ii). The alternative limits are based on the highest antenna gain specified in the filing. There are also marketing and importation restrictions for the devices using the alternative limit.⁴

Note 3: An out-of-band emission that complies with both the average and peak limits of Section 15.209 is not required to satisfy the -27 dBm/MHz peak emission limit.

Note 4: Only devices with antenna gains of 10 dBi or less may be approved using the emission limits specified in Section 15.247(d) till March 2, 2018; all other devices operating in this band must use the mask specified in Section 15.407(b)(4)(i).



3.1.2 Measuring Instruments

See list of measuring equipment of this test report.

3.1.3 Test Procedures

1. The testing follows FCC KDB 789033 D02 General UNII Test Procedures New Rules v02r01. Section G) Unwanted emissions measurement.
 - (1) Procedure for Unwanted Emissions Measurements Below 1000MHz
 - RBW = 120 kHz
 - VBW = 300 kHz
 - Detector = Peak
 - Trace mode = max hold
 - (2) Procedure for Peak Unwanted Emissions Measurements Above 1000 MHz
 - RBW = 1 MHz
 - VBW \geq 3 MHz
 - Detector = Peak
 - Sweep time = auto
 - Trace mode = max hold
 - (3) Procedures for Average Unwanted Emissions Measurements Above 1000MHz
 - RBW = 1 MHz
 - VBW = 10 Hz, when duty cycle is no less than 98 percent.
 - VBW \geq 1/T, when duty cycle is less than 98 percent where T is the minimum transmission duration over which the transmitter is on and is transmitting at its maximum power control level for the tested mode of operation.
2. The EUT was placed on a turntable with 0.8 meter for frequency below 1GHz and 1.5 meter for frequency above 1GHz respectively above ground.
3. The EUT was set 3 meters from the interference receiving antenna which was mounted on the top of a variable height antenna tower.
4. The antenna is a broadband antenna and its height is adjusted between one meter and four meters above ground to find the maximum value of the field strength for both horizontal polarization and vertical polarization of the antenna.
5. For each suspected emission, the EUT was arranged to its worst case and then adjust the antenna tower (from 1 m to 4 m) and turntable (from 0 degree to 360 degrees) to find the maximum reading.

6. For testing below 1GHz, if the emission level of the EUT in peak mode was 3 dB lower than the limit specified, then peak values of EUT will be reported, otherwise, the emissions will be repeated one by one using the CISPR quasi-peak method and reported.
7. For testing above 1GHz, the emission level of the EUT in peak mode was 20dB lower than average limit (that means the emission level in average mode also complies with the limit in average mode), then peak values of EUT will be reported, otherwise, the emissions will be measured in average mode again and reported.

3.1.4 Test Setup

For radiated emissions below 30MHz

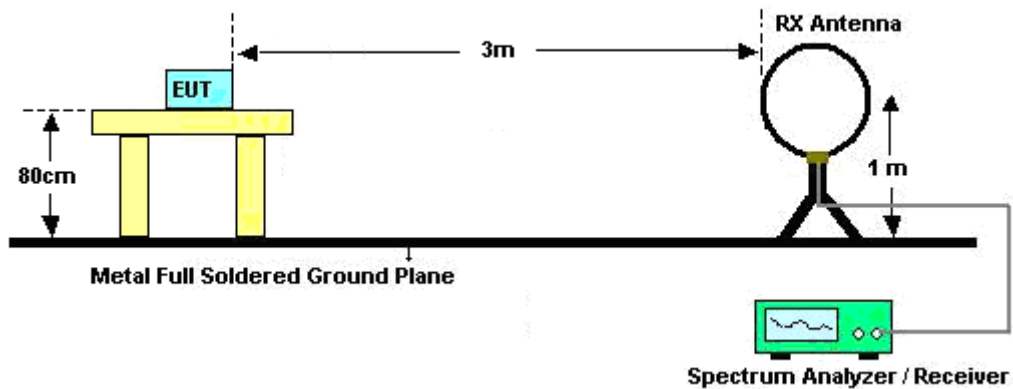

For radiated emissions from 30MHz to 1GHz

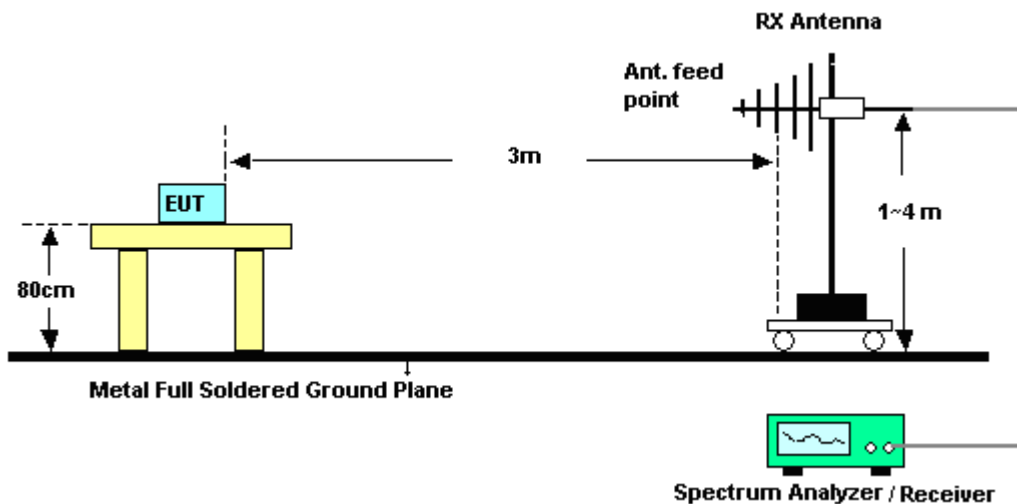

For radiated emissions above 1GHz

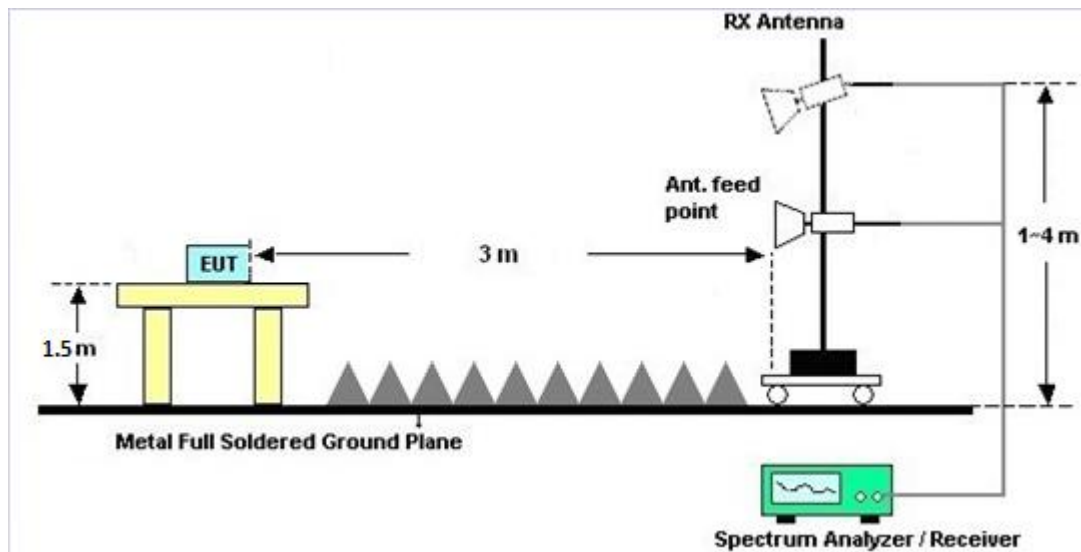

3.1.5 Test Results of Radiated Spurious Emissions (9 kHz ~ 30 MHz)

The low frequency, which started from 9 kHz to 30MHz, was pre-scanned and the result which was 20dB lower than the limit line was not reported.

There is a comparison data of both open-field test site and alternative test site - semi-Anechoic chamber according to 414788 D01 Radiated Test Site v01r01, and the result came out very similar.

3.1.6 Test Result of Radiated Spurious at Band Edges

Please refer to Appendix A and B.

3.1.7 Duty Cycle

Please refer to Appendix C.

3.1.8 Test Result of Radiated Spurious Emissions (30MHz ~ 10th Harmonic)

Please refer to Appendix A and B.



3.2 Antenna Requirements

3.2.1 Standard Applicable

If transmitting antenna directional gain is greater than 6 dBi, both the peak transmit power and the peak power spectral density shall be reduced by the amount in dB that the directional gain of the antenna exceeds 6 dBi.

3.2.2 Antenna Anti-Replacement Construction

An embedded-in antenna design is used.

3.2.3 Antenna Gain

The antenna peak gain of EUT is less than 6 dBi. Therefore, it is not necessary to reduce maximum peak output power limit.



4 List of Measuring Equipment

Instrument	Manufacturer	Model No.	Serial No.	Characteristics	Calibration Date	Test Date	Due Date	Remark
Loop Antenna	Rohde & Schwarz	HFH2-Z2	100488	9 kHz~30 MHz	Nov. 23, 2017	Sep. 16, 2018~ Sep. 30, 2018	Nov. 22, 2018	Radiation (03CH15-HY)
Bilog Antenna	TESEQ	CBL6111D&0 0800N1D01N- 06	41912&05	30MHz to 1GHz	Jan. 10, 2018	Sep. 16, 2018~ Sep. 30, 2018	Jan. 09, 2019	Radiation (03CH15-HY)
Preamplifier	Jet-Power	JPA0118-55-3 03	171000180 00550006	1GHz~18GHz	Jul. 10, 2018	Sep. 16, 2018~ Sep. 30, 2018	Jul. 09, 2019	Radiation (03CH15-HY)
EMI Test Receiver	Keysight	N9038A (MXE)	MY541300 85	20Hz ~ 8.4GHz	Oct. 31, 2017	Sep. 16, 2018~ Sep. 30, 2018	Oct. 30, 2018	Radiation (03CH15-HY)
Horn Antenna	SCHWARZBE CK	BBHA 9120D	9120D-162 0	1G~18GHz	Oct. 03, 2017	Sep. 16, 2018~ Sep. 30, 2018	Oct. 02, 2018	Radiation (03CH15-HY)
Hygrometer	TECPEL	DTM-303B	TP162976	N/A	Oct. 12, 2017	Sep. 16, 2018~ Sep. 30, 2018	Oct. 11, 2018	Radiation (03CH15-HY)
Preamplifier	Keysight	83017A	MY532701 95	1GHz~26.5GHz	Aug. 23, 2018	Sep. 16, 2018~ Sep. 30, 2018	Aug. 22, 2019	Radiation (03CH15-HY)
Spectrum Analyzer	Agilent	E4446A	MY501801 36	3Hz~44GHz	Apr. 25, 2018	Sep. 16, 2018~ Sep. 30, 2018	Apr. 24, 2019	Radiation (03CH15-HY)
Controller	ChainTek	3000-1	N/A	Control Turn table & Ant Mast	N/A	Sep. 16, 2018~ Sep. 30, 2018	N/A	Radiation (03CH15-HY)
Antenna Mast	ChainTek	MBS-520-1	N/A	1m~4m	N/A	Sep. 16, 2018~ Sep. 30, 2018	N/A	Radiation (03CH15-HY)
Turn Table	ChainTek	T-200-S-1	N/A	0~360 Degree	N/A	Sep. 16, 2018~ Sep. 30, 2018	N/A	Radiation (03CH15-HY)
Amplifier	MITEQ	TTA1840-35- HG	1871923	18GHz~40GHz, VSWR : 2.5:1 max	Jul. 16, 2018	Sep. 16, 2018~ Sep. 30, 2018	Jul. 15, 2019	Radiation (03CH15-HY)
SHF-EHF Horn Antenna	SCHWARZBE CK	BBHA 9170	BBHA9170 584	18GHz- 40GHz	Nov. 27, 2017	Sep. 16, 2018~ Sep. 30, 2018	Nov. 26, 2018	Radiation (03CH15-HY)
Software	Audix	E3 6.2009-8-24(K 5)	ARD-SPR- 000185	N/A	N/A	Sep. 16, 2018~ Sep. 30, 2018	N/A	Radiation (03CH15-HY)
RF Cable	HUBER + SUHNER	SUCOFLEX 104	MY36980/ 4	30M-18G	Apr. 16, 2018	Sep. 16, 2018~ Sep. 30, 2018	Apr. 15, 2019	Radiation (03CH15-HY)
RF Cable	HUBER + SUHNER	SUCOFLEX 104	MY9838/4	30M-18GHz	Apr. 16, 2018	Sep. 16, 2018~ Sep. 30, 2018	Apr. 15, 2019	Radiation (03CH15-HY)
RF Cable	HUBER + SUHNER	MTJ	000000-M T18A-100 D3210	30M-18G	Apr. 16, 2018	Sep. 16, 2018~ Sep. 30, 2018	Apr. 15, 2019	Radiation (03CH15-HY)
Cable	HUBER + SUHNER	SUCOFLEX 102	505134/2	30M~40GHz	Oct. 17, 2017	Sep. 16, 2018~ Sep. 30, 2018	Oct. 16, 2018	Radiation (03CH15-HY)
Cable	HUBER + SUHNER	SUCOFLEX 102	800740/2	30M~40GHz	Oct. 17, 2017	Sep. 16, 2018~ Sep. 30, 2018	Oct. 16, 2018	Radiation (03CH15-HY)
Filter	Wainwright	WLKS1200-8 SS	SN3	1.2G Low Pass	Nov. 21, 2017	Sep. 16, 2018~ Sep. 30, 2018	Nov. 20, 2018	Radiation (03CH15-HY)
Filter	Wainwright	WLKS4500-8 SS	SN19	4.5G Low Pass	Mar. 22, 2018	Sep. 16, 2018~ Sep. 30, 2018	Mar. 21, 2019	Radiation (03CH15-HY)
Filter	Woken	WHKX8-5272. 5-6750-18000 -40ST	SN2	6.75G Highpass	Jul. 15, 2018	Sep. 16, 2018~ Sep. 30, 2018	Jul. 14, 2019	Radiation (03CH15-HY)



5 Uncertainty of Evaluation

Uncertainty of Radiated Emission Measurement (30 MHz ~ 1000 MHz)

Measuring Uncertainty for a Level of Confidence of 95% ($U = 2Uc(y)$)	5.20
---	------

Uncertainty of Radiated Emission Measurement (1000 MHz ~ 18000 MHz)

Measuring Uncertainty for a Level of Confidence of 95% ($U = 2Uc(y)$)	5.50
---	------

Uncertainty of Radiated Emission Measurement (18000 MHz ~ 40000 MHz)

Measuring Uncertainty for a Level of Confidence of 95% ($U = 2Uc(y)$)	5.20
---	------



Appendix A. Radiated Spurious Emission

Test Engineer :	Watt Tseng, Karl Hou, and Bill Chang	Temperature :	22~25°C
		Relative Humidity :	52~57%

Co-location Mode

Bluetooth LE (2Mbps) and WIFI 802.11n HT20 (Harmonic @ 3m)

WIFI Ant. Simultaneously	Note	Frequency (MHz)	Level (dBμV/m)	Over Limit (dB)	Limit Line (dBμV/m)	Read Level (dBμV)	Antenna Factor (dB/m)	Path Loss (dB)	Preamp Factor (dB)	Ant Pos (cm)	Table Pos (deg)	Peak Avg. (P/A)	Pol. (H/V)	
BLE(2M) CH39 2480 MHz + 802.11n HT20 CH100 5500 MHz		4960	45.9	-28.1	74	63.54	31.63	8.44	58.17	100	0	P	H	
		7440	42.55	-31.45	74	53.14	36.39	10.88	58.31	100	0	P	H	
	*	11000	46.25	-27.75	74	54.29	40.6	12.98	62	100	0	P	H	
	*	16500	46.25	-21.95	68.2	49.91	38.6	16.84	59.6	100	0	P	H	
													H	
														H
			4960	46.75	-27.25	74	64.39	31.63	8.44	58.17	100	0	P	V
			7440	42.25	-31.75	74	52.84	36.39	10.88	58.31	100	0	P	V
	*		11000	46.43	-27.57	74	54.47	40.6	12.98	62	100	0	P	V
	*		16500	45.87	-22.33	68.2	49.53	38.6	16.84	59.6	100	0	P	V
														V
														V
Remark	1. No other spurious found. 2. All results are PASS against Peak and Average limit line.													



Emission below 1GHz

Bluetooth LE (2Mbps) and WIFI 802.11n HT20 (LF)

WIFI Ant.	Note	Frequency	Level	Over Limit	Limit Line	Read Level	Antenna Factor	Path Loss	Preamp Factor	Ant Pos	Table Pos	Peak Avg.	Pol.	
1		(MHz)	(dBμV/m)	(dB)	(dBμV/m)	(dBμV)	(dB/m)	(dB)	(dB)	(cm)	(deg)	(P/A)	(H/V)	
BLE(2M) CH39 2480 MHz + 802.11n HT20 CH100 5500 MHz LF		59.43	25.31	-14.69	40	44.92	12.02	0.93	32.61			P	H	
		171.75	38.03	-5.47	43.5	53.18	15.63	1.57	32.55	100	0	P	H	
		205.77	35.67	-7.83	43.5	50.95	15.38	1.72	32.54			P	H	
		408.5	23.91	-22.09	46	31.35	22.58	2.43	32.53			P	H	
		482	28.52	-17.48	46	34.47	23.91	2.59	32.55			P	H	
		671	28.61	-17.39	46	31.44	26.51	3.04	32.51			P	H	
													H	
													H	
													H	
													H	
													H	
			31.08	36.27	-3.73	40	44.38	23.86	0.68	32.65	100	0	P	V
			76.71	32.26	-7.74	40	50.55	13.15	1.06	32.59			P	V
			197.4	31.27	-12.23	43.5	46.97	14.97	1.69	32.54			P	V
			434.4	24.39	-21.61	46	31.44	22.93	2.48	32.54			P	V
			444.2	24.84	-21.16	46	31.67	23.13	2.49	32.54			P	V
			482	29.33	-16.67	46	35.28	23.91	2.59	32.55			P	V
														V
													V	
													V	
													V	
													V	
													V	
Remark	1. No other spurious found. 2. All results are PASS against limit line.													



Note symbol

*	Fundamental Frequency which can be ignored. However, the level of any unwanted emissions shall not exceed the level of the fundamental frequency.
!	Test result is over limit line.
P/A	Peak or Average
H/V	Horizontal or Vertical



A calculation example for radiated spurious emission is shown as below:

WIFI	Note	Frequency	Level	Over	Limit	Read	Antenna	Path	Preamp	Ant	Table	Peak	Pol.
Ant.				Limit	Line	Level	Factor	Loss	Factor	Pos	Pos	Avg.	
1		(MHz)	(dBμV/m)	(dB)	(dBμV/m)	(dBμV)	(dB/m)	(dB)	(dB)	(cm)	(deg)	(P/A)	(H/V)
802.11b		2390	55.45	-18.55	74	54.51	32.22	4.58	35.86	103	308	P	H
CH 01													
2412MHz		2390	43.54	-10.46	54	42.6	32.22	4.58	35.86	103	308	A	H

1. Path Loss(dB) = Cable loss(dB) + Filter loss(dB) + Attenuator loss(dB)
2. Level(dBμV/m) = Antenna Factor(dB/m) + Path Loss(dB) + Read Level(dBμV) - Preamp Factor(dB)
3. Over Limit(dB) = Level(dBμV/m) – Limit Line(dBμV/m)

For Peak Limit @ 2390MHz:

1. Level(dBμV/m)
= Antenna Factor(dB/m) + Path Loss(dB) + Read Level(dBμV) - Preamp Factor(dB)
= 32.22(dB/m) + 4.58(dB) + 54.51(dBμV) – 35.86 (dB)
= 55.45 (dBμV/m)
2. Over Limit(dB)
= Level(dBμV/m) – Limit Line(dBμV/m)
= 55.45(dBμV/m) – 74(dBμV/m)
= -18.55(dB)

For Average Limit @ 2390MHz:

1. Level(dBμV/m)
= Antenna Factor(dB/m) + Path Loss(dB) + Read Level(dBμV) - Preamp Factor(dB)
= 32.22(dB/m) + 4.58(dB) + 42.6(dBμV) – 35.86 (dB)
= 43.54 (dBμV/m)
2. Over Limit(dB) = Level(dBμV/m) – Limit Line(dBμV/m)
= 43.54(dBμV/m) – 54(dBμV/m)
= -10.46(dB)

Both peak and average measured complies with the limit line, so test result is “PASS”.



Appendix B. Radiated Spurious Emission

Test Engineer :	Watt Tseng, Karl Hou, and Bill Chang	Temperature :	22~25°C
		Relative Humidity :	52~57%

Co-location Mode

Bluetooth LE (2Mbps) and WIFI 802.11n HT20 (Harmonic @ 3m)

ANT	BLE(2M) CH39 2480 MHz + 802.11n HT20 CH100 5500 MHz	
Simultaneously	Horizontal	Vertical
<p>Peak</p> <p>Avg.</p>	<p>Site : 03CH15-HY Condition : PEAK(UNIT) 3m 9120D_15_1620 HORIZONTAL Detector : Peak Project : 890437 Mode : 40</p>	<p>Site : 03CH15-HY Condition : PEAK(UNIT) 3m 9120D_15_1620 VERTICAL Detector : Peak Project : 890437 Mode : 40</p>

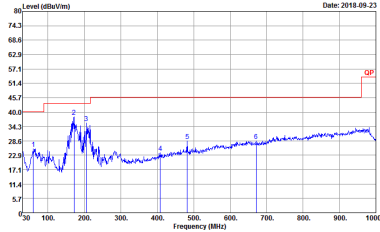
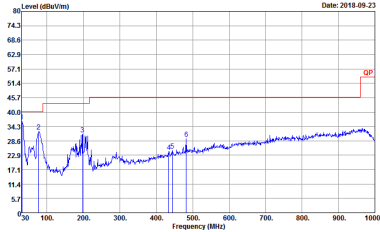

Emission below 1GHz
Bluetooth LE (2Mbps) and WIFI 802.11n HT20 (LF)

ANT	BLE(2M) CH39 2480 MHz + 802.11n HT20 CH100 5500 MHz	
Simultaneously	Horizontal	Vertical
QP / Peak	 <p>Site : 03CH15-HY Condition : QP 3m BTLOG_15_41912 HORIZONTAL Detector : Peak Project : 890437 Mode : 40</p>	 <p>Site : 03CH15-HY Condition : QP 3m BTLOG_15_41912 VERTICAL Detector : Peak Project : 890437 Mode : 40</p>



Appendix C. Duty Cycle Plots

Band	Duty Cycle (%)	T(us)	1/T(kHz)	VBW Setting	Duty Factor(dB)
Bluetooth –LE 2Mbps	31.73	198	5.05	10kHz	4.99
5GHz 802.11n HT20	95.07	1930	0.518	1kHz	0.22



Bluetooth – LE 2Mbps

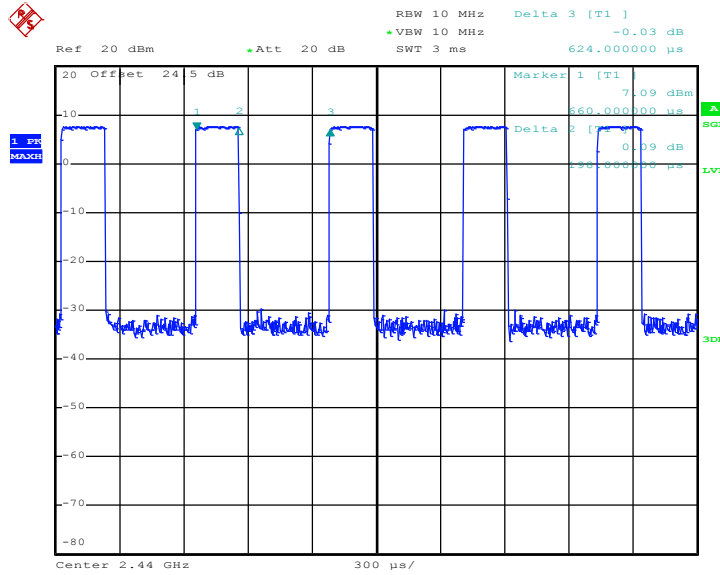

Date: 11.SEP.2018 07:35:35

802.11n HT20

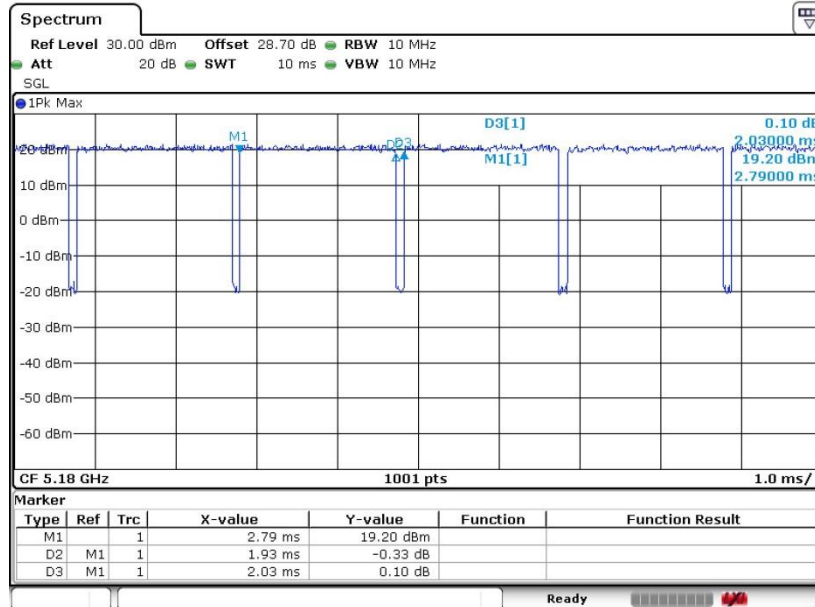

Date: 12.SEP.2018 07:44:09

—THE END—