



FCC RADIO TEST REPORT

FCC ID : IHDT56XN2
Equipment : Mobile Cellular Phone
Brand Name : Motorola
Model name : XT1965-2
Applicant : Motorola Mobility LLC
222 W,Merchandise Mart Plaza, Chicago IL
60654 USA
Manufacturer : Motorola Mobility LLC
222 W,Merchandise Mart Plaza, Chicago IL
60654 USA
Standard : FCC Part 15 Subpart E §15.407

The product was received on Sep. 04, 2018 and testing was started from Sep. 11, 2018 and completed on Oct. 02, 2018. We, SPORTON INTERNATIONAL INC., would like to declare that the tested sample has been evaluated in accordance with the test procedures and has been in compliance with the applicable technical standards.

The report must not be used by the client to claim product certification, approval, or endorsement by TAF or any agency of government.

The test results in this report apply exclusively to the tested model / sample. Without written approval of SPORTON INTERNATIONAL INC. EMC & Wireless Communications Laboratory, the test report shall not be reproduced except in full.

Approved by: Joseph Lin

SPORTON INTERNATIONAL INC. EMC & Wireless Communications Laboratory

No. 52, Huaya 1st Rd., Guishan Dist., Taoyuan City, Taiwan (R.O.C.)



Table of Contents

History of this test report3

Summary of Test Result4

1 General Description5

 1.1 Product Feature of Equipment Under Test.....5

 1.2 Product Specification of Equipment Under Test7

 1.3 Modification of EUT7

 1.4 Testing Location8

 1.5 Applicable Standards8

2 Test Configuration of Equipment Under Test9

 2.1 Carrier Frequency and Channel9

 2.2 Test Mode 10

 2.3 Connection Diagram of Test System11

 2.4 Support Unit used in test configuration and system..... 12

 2.5 EUT Operation Test Setup12

 2.6 Measurement Results Explanation Example..... 12

3 Test Result13

 3.1 6dB and 26dB and 99% Occupied Bandwidth Measurement..... 13

 3.2 Maximum Conducted Output Power Measurement16

 3.3 Power Spectral Density Measurement 17

 3.4 Unwanted Emissions Measurement19

 3.5 AC Conducted Emission Measurement.....25

 3.6 Automatically Discontinue Transmission27

 3.7 Antenna Requirements28

4 List of Measuring Equipment29

5 Uncertainty of Evaluation31

Appendix A. Conducted Test Results

Appendix B. AC Conducted Emission Test Result

Appendix C. Radiated Spurious Emission

Appendix D. Radiated Spurious Emission Plots

Appendix E. Duty Cycle Plots



Summary of Test Result

Report Clause	Ref Std. Clause	Test Items	Result (PASS/FAIL)	Remark
3.1	15.403 (i)	6dB & 26dB Bandwidth	Pass	-
3.1	2.1049	99% Occupied Bandwidth	Reporting only	-
3.2	15.407 (a)	Maximum Conducted Output Power	Pass	-
3.3	15.407 (a)	Power Spectral Density	Pass	-
3.4	15.407(b)	Unwanted Emissions	Pass	Under limit 3.09 dB at 11490.000 MHz
3.5	15.207	AC Conducted Emission	Pass	Under limit 9.11 dB at 0.562 MHz
3.6	15.407 (c)	Automatically Discontinue Transmission	Pass	-
3.7	15.203 & 15.407 (a)	Antenna Requirement	Pass	-

Reviewed by: Wii Chang

Report Producer: Natasha Hsieh



1 General Description

1.1 Product Feature of Equipment Under Test

Product Feature	
Equipment	Mobile Cellular Phone
Brand Name	Motorola
Model Name	XT1965-2
Sample 1	Dual SIM
Sample 2	Single SIM
FCC ID	IHDT56XN2
IMEI Code	Conducted : IMEI 1: 355577090032556 IMEI 2: 355577090032564 Conduction : IMEI 1: 355577090033497 IMEI 2: 355577090033505 IMEI 1: 355577090033414 Radiation : IMEI 2: 355577090033422 IMEI 1: 355577090033455 IMEI 2: 355577090033463
EUT supports Radios application	GSM/EGPRS/WCDMA/HSPA/LTE/GNSS/NFC/FM WLAN 11b/g/n/ac HT20/VHT20 WLAN 11a/n HT20/HT40 WLAN 11ac VHT20/VHT40/VHT80 Bluetooth BR/EDR/LE
HW Version	DVT1-B
EUT Stage	Identical Prototype

Remark: The above EUT's information was declared by manufacturer.



Accessory List	
AC Adapter 1	Brand Name : Motorola
	Model Name : SC-31
	Manufacturer : Salom
AC Adapter 1	Brand Name : Motorola
	Model Name : SC-32
	Manufacturer : Salom
AC Adapter 1	Brand Name : Motorola
	Model Name : SC-37
	Manufacturer : Salom
AC Adapter 1	Brand Name : Motorola
	Model Name : SC-36
	Manufacturer : Salom
AC Adapter 1	Brand Name : Motorola
	Model Name : SC-32
	Manufacturer : Salom
AC Adapter 2	Brand Name : Motorola
	Model Name : SC-31
	Manufacturer : Acbel
AC Adapter 2	Brand Name : Motorola
	Model Name : SC-32
	Manufacturer : Acbel
AC Adapter 2	Brand Name : Motorola
	Model Name : SC-36
	Manufacturer : Acbel
AC Adapter 2	Brand Name : Motorola
	Model Name : SC-37
	Manufacturer : Acbel
Battery	Brand Name : Motorola
	Model Name : JG40
	Manufacturer : Amperex
Earphone	Brand Name : Motorola
	Model Name : SH38C37773
	Manufacturer : Lyand
USB Cable 1	Brand Name : Cabletech
	Model Name : SC18C37155
USB Cable 2	Brand Name : Luxshare
	Model Name : SC18C37156
USB Cable 3	Brand Name : Saibao
	Model Name : SC18C37157



1.2 Product Specification of Equipment Under Test

Standards-related Product Specification	
Tx/Rx Channel Frequency Range	5745 MHz ~ 5825 MHz
Maximum Output Power	802.11a : 14.64 dBm / 0.0291 W 802.11n HT20 : 15.57 dBm / 0.0361 W 802.11n HT40 : 15.13 dBm / 0.0326 W 802.11ac VHT20 : 15.53 dBm / 0.0357 W 802.11ac VHT40 : 15.10 dBm / 0.0324 W 802.11ac VHT80 : 16.72 dBm / 0.0470 W
99% Occupied Bandwidth	802.11a : 16.75 MHz 802.11n HT20 : 18.00 MHz 802.11n HT40 : 36.70 MHz 802.11ac VHT80 : 77.16 MHz
Antenna Type / Gain	Internal Antenna with gain -0.69 dBi
Type of Modulation	802.11a/n : OFDM (BPSK / QPSK / 16QAM / 64QAM) 802.11ac : OFDM (BPSK / QPSK / 16QAM / 64QAM / 256QAM)

1.3 Modification of EUT

No modifications are made to the EUT during all test items.



1.4 Testing Location

Sporton Lab is accredited to ISO 17025 by Taiwan Accreditation Foundation (TAF code : 1190) and the FCC designation No. TW1190 and TW0007 under the FCC 2.948(e) by Mutual Recognition Agreement (MRA) in FCC Test.

Test Site	SPORTON INTERNATIONAL INC.	
Test Site Location	No.52, Huaya 1st Rd., Guishan Dist., Taoyuan City, Taiwan (R.O.C.) TEL: +886-3-327-3456 FAX: +886-3-328-4978	
Test Site No.	Sporton Site No.	
	TH05-HY	CO05-HY

Note: The test site complies with ANSI C63.4 2014 requirement.

Test Site	SPORTON INTERNATIONAL INC.	
Test Site Location	No.58, Aly. 75, Ln. 564, Wenhua 3rd, Rd., Guishan Dist., Taoyuan City, Taiwan (R.O.C.) TEL: +886-3-327-0868 FAX: +886-3-327-0855	
Test Site No.	Sporton Site No.	
	03CH15-HY	

Note: The test site complies with ANSI C63.4 2014 requirement.

1.5 Applicable Standards

According to the specifications of the manufacturer, the EUT must comply with the requirements of the following standards:

- ♦ FCC Part 15 Subpart E
- ♦ FCC KDB 789033 D02 General UNII Test Procedures New Rules v02r01.
- ♦ FCC KDB 414788 D01 Radiated Test Site v01r01.
- ♦ ANSI C63.10-2013

Remark:

1. All test items were verified and recorded according to the standards and without any deviation during the test.
2. This EUT has also been tested and complied with the requirements of FCC Part 15, Subpart B, recorded in a separate test report.



2 Test Configuration of Equipment Under Test

- a. The EUT has been associated with peripherals and configuration operated in a manner tended to maximize its emission characteristics in a typical application. Frequency range investigated: conduction emission (150 kHz to 30 MHz), radiation emission (9 kHz to the 10th harmonic of the highest fundamental frequency or to 40 GHz, whichever is lower). For radiated measurement, pre-scanned in three orthogonal panels, X, Y, Z. The worst cases (X plane) were recorded in this report.

- b. AC power line Conducted Emission was tested under maximum output power.

2.1 Carrier Frequency and Channel

Frequency Band	Channel	Freq. (MHz)	Channel	Freq. (MHz)
5725-5850 MHz Band 4 (U-NII-3)	149	5745	157	5785
	151*	5755	159*	5795
	153	5765	161	5805
	155 [#]	5775	165	5825

Note:

- 1. The above Frequency and Channel in "*" were 802.11n HT40 and 802.11ac VHT40.
- 2. The above Frequency and Channel in "[#]" were 802.11ac VHT80.



2.2 Test Mode

Final test modes are considering the modulation and worse data rates as below table.

Modulation	Data Rate
802.11a	6 Mbps
802.11n HT20	MCS0
802.11n HT40	MCS0
802.11ac VHT20 (Covered by HT20)	MCS0
802.11ac VHT40 (Covered by HT40)	MCS0
802.11ac VHT80	MCS0

Test Cases	
AC Conducted Emission	Mode 1 : GSM850 Idle + Bluetooth Link + WLAN (5GHz) Link + MP3 + Earphone + Battery + USB Cable 1 Type C (Charging from Adapter 1) for Sample 1
Remark: For Radiated Test Cases, the tests were performed with Adapter 1, USB Cable 1 Type C and Sample 1	

Ch. #	Band IV : 5725-5850 MHz			
	802.11a	802.11n HT20	802.11n HT40	802.11ac VHT80
L Low	149	149	151	-
M Middle	157	157	-	155
H High	165	165	159	-

2.3 Connection Diagram of Test System

<WLAN Tx Mode>

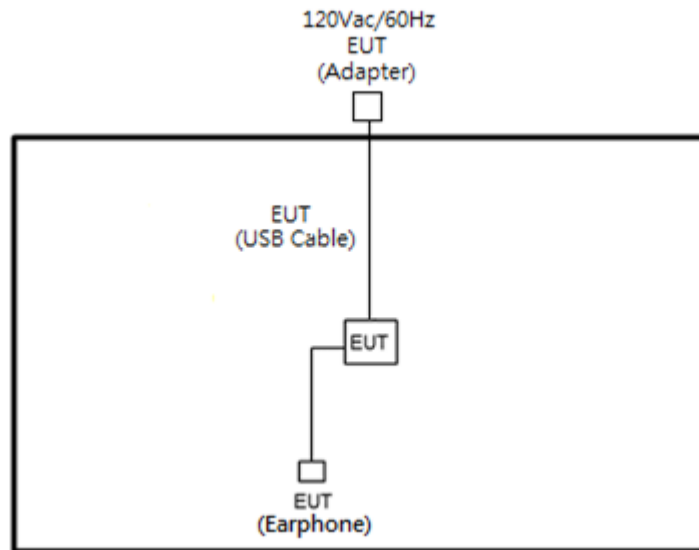

<AC Conducted Emission Mode>

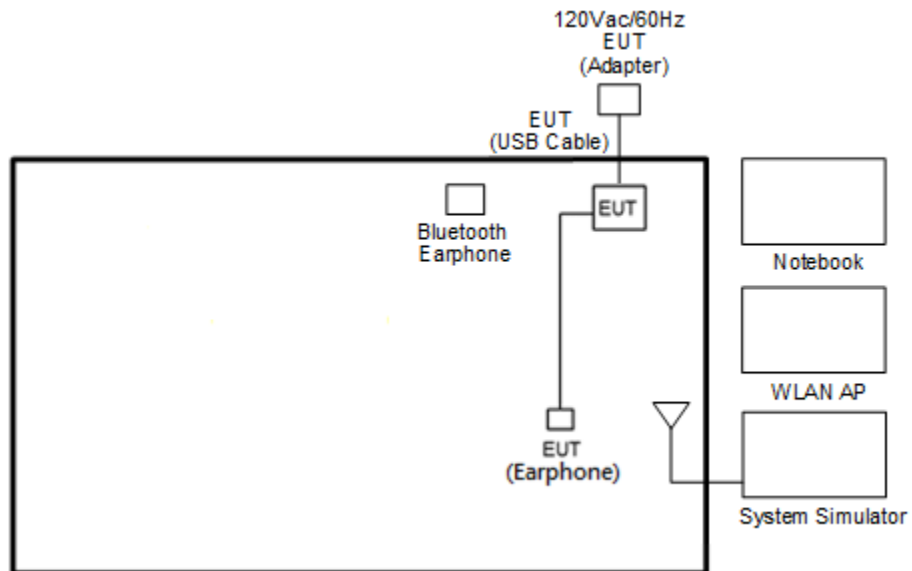

2.4 Support Unit used in test configuration and system

Item	Equipment	Trade Name	Model Name	FCC ID	Data Cable	Power Cord
1.	System Simulator	Anritsu	MT8820C	N/A	N/A	Unshielded, 1.8 m
2.	Bluetooth Earphone	Sony Ericsson	MW600	PY700A2029	N/A	N/A
3.	WLAN AP	ASUS	RT-AC66U	MSQ-RTAC66U	N/A	Unshielded, 1.8 m
4.	Notebook	DELL	P20G	FCC DoC	N/A	AC I/P: Unshielded, 1.2 m DC O/P: Shielded, 1.8 m
5.	SD Card	SanDisk	MicroSD HC	FCC DoC	N/A	N/A

2.5 EUT Operation Test Setup

The RF test items, utility “CMD” was installed in Notebook which was programmed in order to make the EUT get into the engineering modes to provide channel selection, power level, data rate and the application type and for continuous transmitting signals.

2.6 Measurement Results Explanation Example

For all conducted test items:

The offset level is set in the spectrum analyzer to compensate the RF cable loss and attenuator factor between EUT conducted output port and spectrum analyzer. With the offset compensation, the spectrum analyzer reading level is exactly the EUT RF output level.

Example :

The spectrum analyzer offset is derived from RF cable loss and attenuator factor.

Offset = RF cable loss + attenuator factor.

Following shows an offset computation example with cable loss 4.2 dB and 10dB attenuator.

$$\begin{aligned}
 \text{Offset(dB)} &= \text{RF cable loss(dB)} + \text{attenuator factor(dB)}. \\
 &= 4.2 + 10 = 14.2 \text{ (dB)}
 \end{aligned}$$

3 Test Result

3.1 6dB and 26dB and 99% Occupied Bandwidth Measurement

3.1.1 Description of 6dB and 26dB and 99% Occupied Bandwidth

The minimum 6 dB bandwidth shall be at least 500 kHz.

26dB and 99% Occupied bandwidth are reporting only.

3.1.2 Measuring Instruments

See list of measuring equipment of this test report.

3.1.3 Test Procedures

1. The testing follows FCC KDB 789033 D02 General UNII Test Procedures New Rules v02r01. Section C) Emission bandwidth for the band 5.725-5.85GHz
2. Set RBW = 100kHz.
3. Set the VBW $\geq 3 \times$ RBW.
4. Detector = Peak.
5. Trace mode = max hold
6. Measure the maximum width of the emission that is 6 dB down from the peak of the emission.
7. Measure and record the results in the test report.

3.1.4 Test Setup

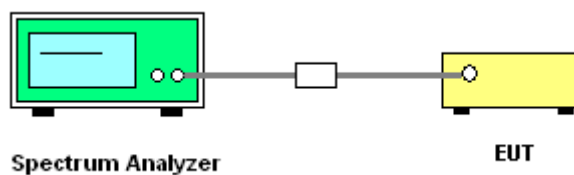

3.1.5 Test Result of 6dB Bandwidth

Please refer to Appendix A.

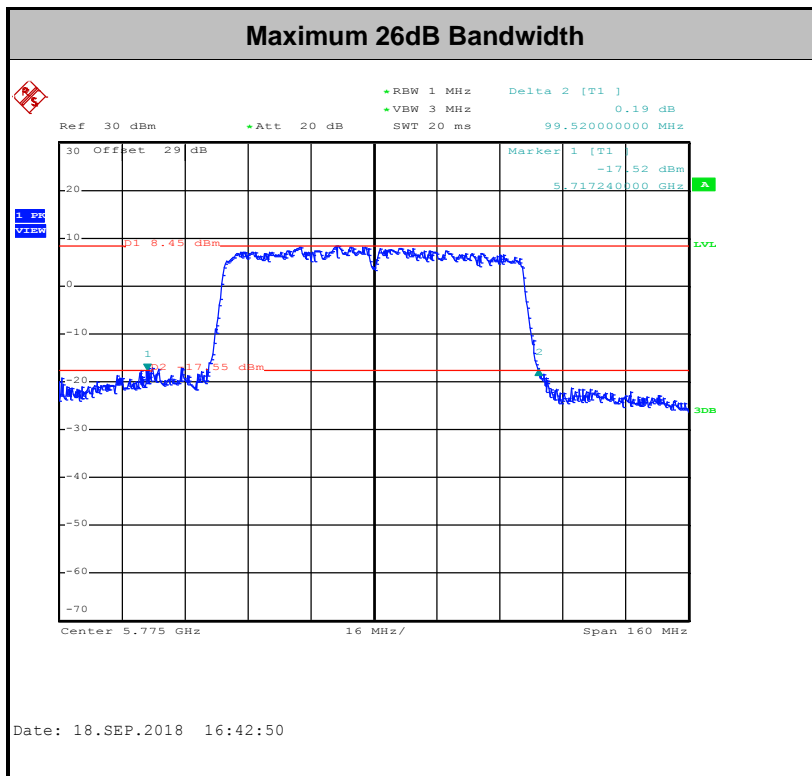
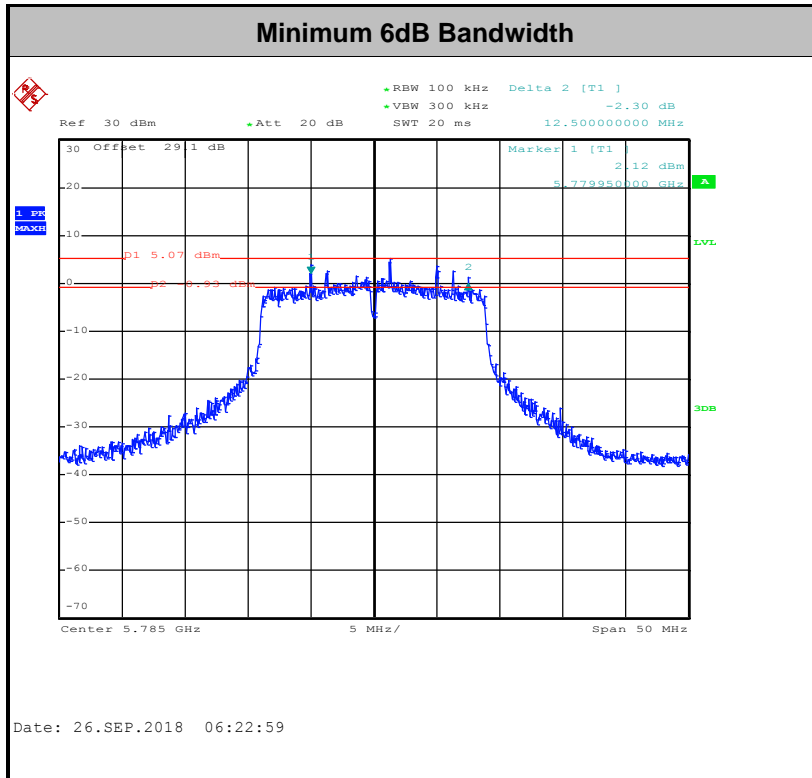

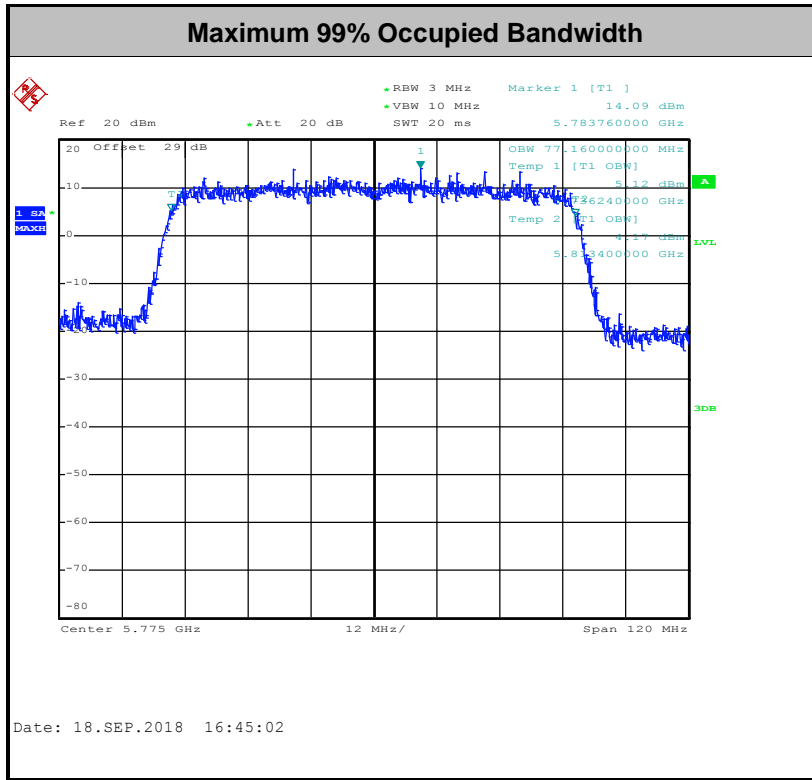

Note: The occupied channel bandwidth is maintained within the band of operation for all of the modulations.

3.2 Maximum Conducted Output Power Measurement

3.2.1 Limit of Maximum Conducted Output Power

For the band 5.725–5.85 GHz, the maximum conducted output power over the frequency band of operation shall not exceed 1 W.

If transmitting antennas of directional gain greater than 6 dBi are used, the peak output power shall be reduced by the amount in dB that the directional gain of the antenna exceeds 6 dBi.

3.2.2 Measuring Instruments

See list of measuring equipment of this test report.

3.2.3 Test Procedures

The testing follows Method PM of FCC KDB 789033 D02 General UNII Test Procedures New Rules v02r01.

Method PM (Measurement using an RF average power meter):

1. Measurement is performed using a wideband RF power meter.
2. The EUT is configured to transmit continuously with a consistent duty cycle at its maximum power control level.
3. Measure the average power of the transmitter, and the average power is corrected with duty factor, $10 \log(1/x)$, where x is the duty cycle.

3.2.4 Test Setup

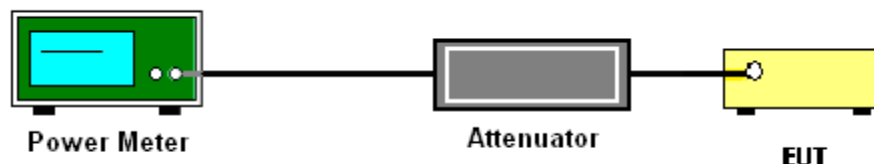

3.2.5 Test Result of Maximum Conducted Output Power

Please refer to Appendix A.



3.3 Power Spectral Density Measurement

3.3.1 Limit of Power Spectral Density

For the band 5.725–5.85 GHz, the maximum power spectral density shall not exceed 30 dBm in any 500-kHz band.

If transmitting antennas of directional gain greater than 6 dBi are used, the peak output power shall be reduced by the amount in dB that the directional gain of the antenna exceeds 6 dBi.

3.3.2 Measuring Instruments

See list of measuring equipment of this test report.

3.3.3 Test Procedures

The testing follows FCC KDB 789033 D02 General UNII Test Procedures New Rules v02r01. Section F) Maximum power spectral density.

Method SA-2

(trace averaging across on and off times of the EUT transmissions, followed by duty cycle correction).

- Measure the duty cycle.
 - Set span to encompass the entire emission bandwidth (EBW) of the signal.
 - Set RBW = 300 kHz.
 - Set VBW \geq 1 MHz.
 - Number of points in sweep \geq 2 Span / RBW.
 - Sweep time = auto.
 - Detector = RMS
 - Trace average at least 100 traces in power averaging mode.
 - Add $10 \log(500\text{kHz}/\text{RBW})$ to the test result.
 - Add $10 \log(1/x)$, where x is the duty cycle, to the measured power in order to compute the average power during the actual transmission times. For example, add $10 \log(1/0.25) = 6$ dB if the duty cycle is 25 percent.
1. The RF output of EUT was connected to the spectrum analyzer by a low loss cable.
 2. Each plot has already offset with cable loss, and attenuator loss. Measure the PPSD and record it.

3.3.4 Test Setup

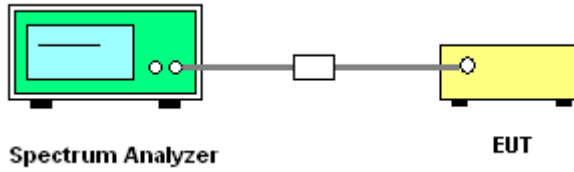

3.3.5 Test Result of Power Spectral Density

Please refer to Appendix A.

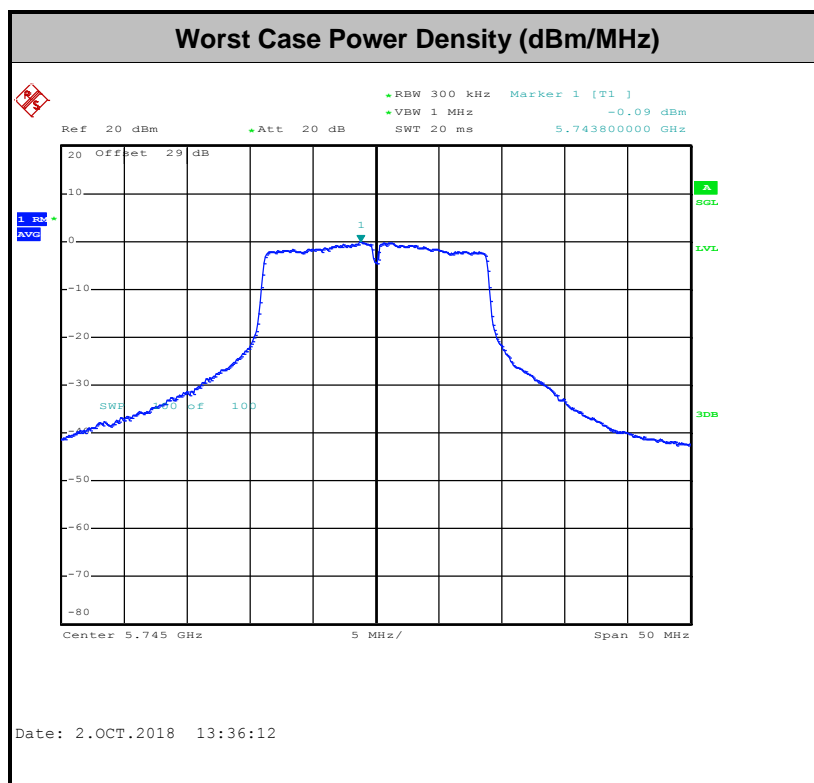



3.4 Unwanted Emissions Measurement

This section is to measure unwanted emissions through radiated measurement for band edge spurious emissions and out of band emissions measurement.

3.4.1 Limit of Unwanted Emissions

- (1) For transmitters operating in the 5.725-5.85 GHz band:
 15.407(b)(4)(i) All emissions shall be limited to a level of -27 dBm/MHz at 75 MHz or more above or below the band edge increasing linearly to 10 dBm/MHz at 25 MHz above or below the band edge, and from 25 MHz above or below the band edge increasing linearly to a level of 15.6 dBm/MHz at 5 MHz above or below the band edge, and from 5 MHz above or below the band edge increasing linearly to a level of 27 dBm/MHz at the band edge.
- (2) Unwanted spurious emissions fallen in restricted bands shall comply with the general field strength limits as below table,

Frequency (MHz)	Field Strength (microvolts/meter)	Measurement Distance (meters)
0.009 – 0.490	2400/F(kHz)	300
0.490 – 1.705	24000/F(kHz)	30
1.705 – 30.0	30	30
30 – 88	100	3
88 – 216	150	3
216 - 960	200	3
Above 960	500	3

Note: The following formula is used to convert the EIRP to field strength.

$$E = \frac{1000000\sqrt{30P}}{3} \text{ } \mu\text{V/m, where P is the eirp (Watts)}$$



EIRP (dBm)	Field Strength at 3m (dBμV/m)
- 27	68.3

(3) KDB789033 D02 v02r01 G)2)c)

- (i) Section 15.407(b)(1) to (b)(3) specify the unwanted emission limits for the U-NII-1 and U-NII-2 bands. As specified, emissions above 1000 MHz that are outside of the restricted bands are subject to a peak emission limit of -27 dBm/MHz.³
- (ii) Section 15.407(b)(4) specifies the unwanted emission limit for the U-NII-3 band. A band emissions mask is specified in Section 15.407(b)(4)(i). The emission limits are in terms of a Peak detector. An alternative to the band emissions mask is specified in Section 15.407(b)(4)(ii). The alternative limits are based on the highest antenna gain specified in the filing. There are also marketing and importation restrictions for the devices using the alternative limit.⁴

Note 3: An out-of-band emission that complies with both the average and peak limits of Section 15.209 is not required to satisfy the -27 dBm/MHz peak emission limit.

Note 4: Only devices with antenna gains of 10 dBi or less may be approved using the emission limits specified in Section 15.247(d) till March 2, 2018; all other devices operating in this band must use the mask specified in Section 15.407(b)(4)(i).

3.4.2 Measuring Instruments

See list of measuring equipment of this test report.



3.4.3 Test Procedures

1. The testing follows FCC KDB 789033 D02 General UNII Test Procedures New Rules v02r01. Section G) Unwanted emissions measurement.

(1) Procedure for Unwanted Emissions Measurements Below 1000MHz

- RBW = 120 kHz
- VBW = 300 kHz
- Detector = Peak
- Trace mode = max hold

(2) Procedure for Peak Unwanted Emissions Measurements Above 1000 MHz

- RBW = 1 MHz
- VBW \geq 3 MHz
- Detector = Peak
- Sweep time = auto
- Trace mode = max hold

(3) Procedures for Average Unwanted Emissions Measurements Above 1000MHz

- RBW = 1 MHz
- VBW = 10 Hz, when duty cycle is no less than 98 percent.
- VBW \geq 1/T, when duty cycle is less than 98 percent where T is the minimum transmission duration over which the transmitter is on and is transmitting at its maximum power control level for the tested mode of operation.



2. The EUT was placed on a turntable with 0.8 meter for frequency below 1GHz and 1.5 meter for frequency above 1GHz respectively above ground.
3. The EUT was set 3 meters from the interference receiving antenna which was mounted on the top of a variable height antenna tower.
4. The antenna is a broadband antenna and its height is adjusted between one meter and four meters above ground to find the maximum value of the field strength for both horizontal polarization and vertical polarization of the antenna.
5. For each suspected emission, the EUT was arranged to its worst case and then adjust the antenna tower (from 1 m to 4 m) and turntable (from 0 degree to 360 degrees) to find the maximum reading.
6. For testing below 1GHz, if the emission level of the EUT in peak mode was 3 dB lower than the limit specified, then peak values of EUT will be reported, otherwise, the emissions will be repeated one by one using the CISPR quasi-peak method and reported.
7. For testing above 1GHz, the emission level of the EUT in peak mode was 20dB lower than average limit (that means the emission level in average mode also complies with the limit in average mode), then peak values of EUT will be reported, otherwise, the emissions will be measured in average mode again and reported.

3.4.4 Test Setup

For radiated emissions below 30MHz

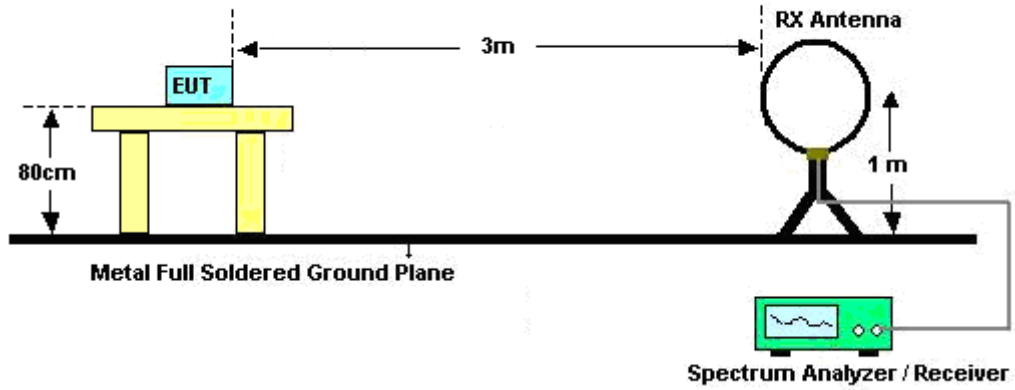

For radiated emissions from 30MHz to 1GHz

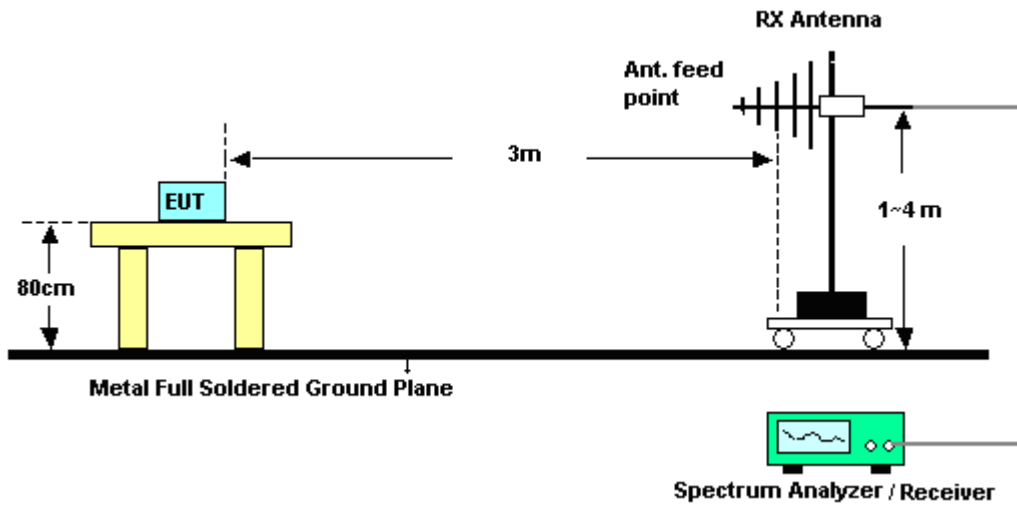

For radiated emissions above 1GHz

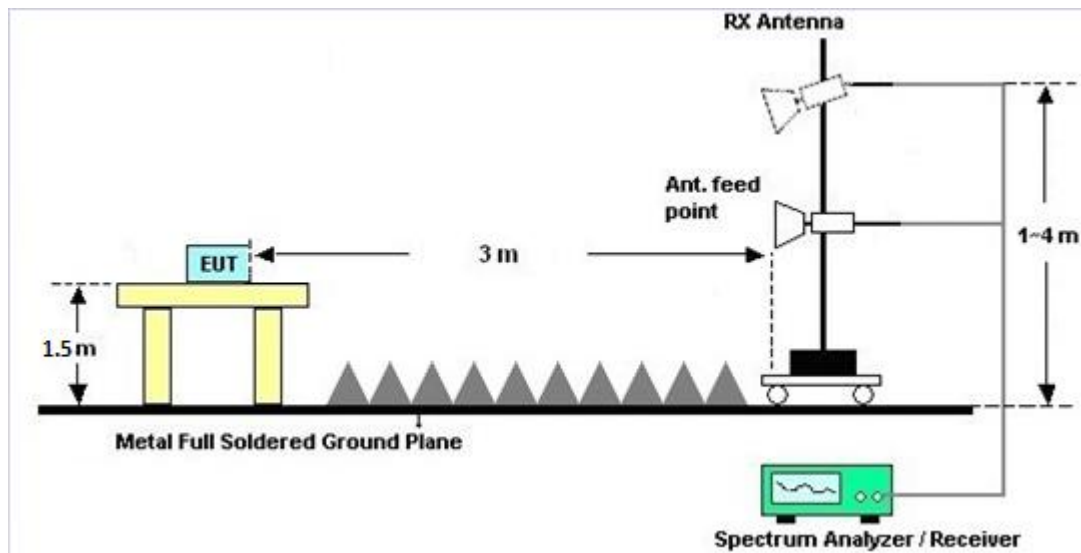

3.4.5 Test Results of Radiated Emissions (9 kHz ~ 30 MHz)

The low frequency, which started from 9 kHz to 30MHz, was pre-scanned and the result which was 20dB lower than the limit line was not reported.

There is a comparison data of both open-field test site and alternative test site - semi-Anechoic chamber according to 414788 D01 Radiated Test Site v01r01, and the result came out very similar.

3.4.6 Test Result of Radiated Band Edges

Please refer to Appendix C and D.

3.4.7 Duty Cycle

Please refer to Appendix E.

3.4.8 Test Result of Unwanted Radiated Emission (30MHz ~ 10th Harmonic)

Please refer to Appendix C and D.



3.5 AC Conducted Emission Measurement

3.5.1 Limit of AC Conducted Emission

For equipment that is designed to be connected to the public utility (AC) power line, the radio frequency voltage that is conducted back onto the AC power line on any frequency or frequencies within the band 150 kHz to 30 MHz shall not exceed the limits in the following table.

Frequency of emission (MHz)	Conducted limit (dB μ V)	
	Quasi-peak	Average
0.15-0.5	66 to 56*	56 to 46*
0.5-5	56	46
5-30	60	50

*Decreases with the logarithm of the frequency.

3.5.2 Measuring Instruments

See list of measuring equipment of this test report.

3.5.3 Test Procedures

1. The EUT was placed 0.4 meter from the conducting wall of the shielding room was kept at least 80 centimeters from any other grounded conducting surface.
2. Connect EUT to the power mains through a line impedance stabilization network (LISN).
3. All the support units are connecting to the other LISN.
4. The LISN provides 50 ohm coupling impedance for the measuring instrument.
5. The FCC states that a 50 ohm, 50 microhenry LISN should be used.
6. Both sides of AC line were checked for maximum conducted interference.
7. The frequency range from 150 kHz to 30 MHz was searched.
8. Set the test-receiver system to Peak Detect Function and specified bandwidth with Maximum Hold Mode.

3.5.4 Test Setup

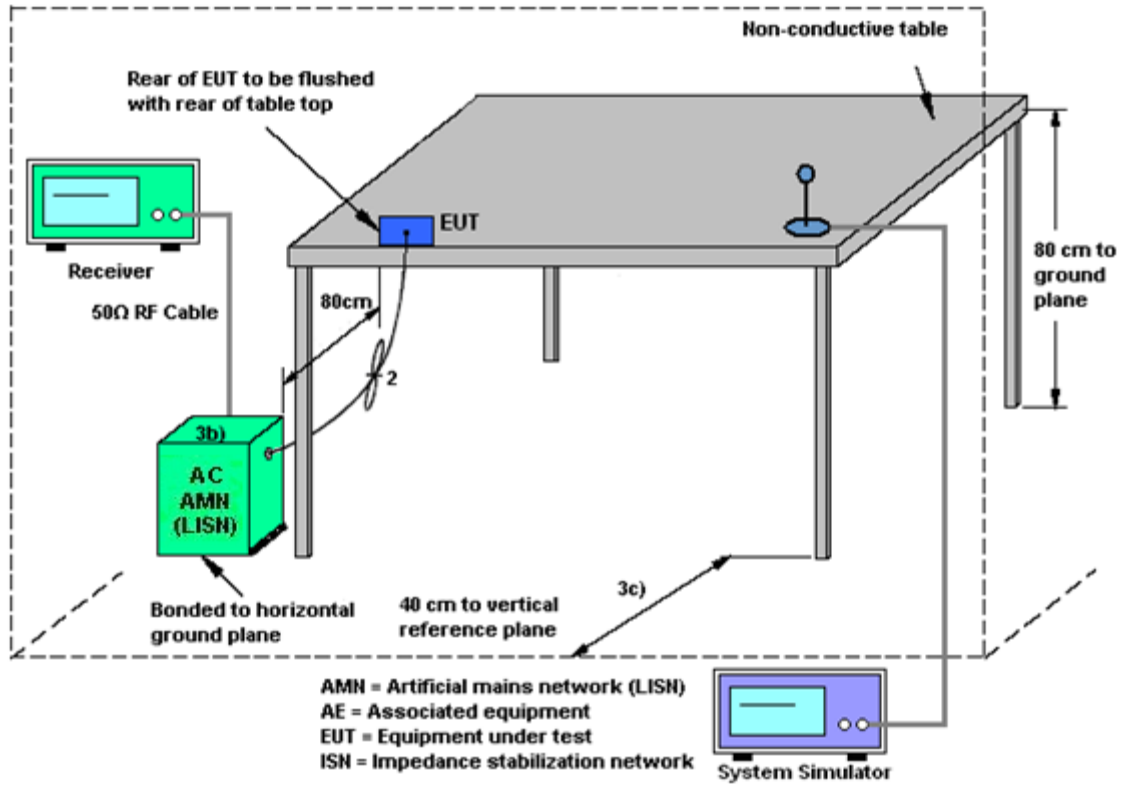

3.5.5 Test Result of AC Conducted Emission

Please refer to Appendix B.



3.6 Automatically Discontinue Transmission

3.6.1 Limit of Automatically Discontinue Transmission

The device shall automatically discontinue transmission in case of either absence of information to transmit or operational failure. These provisions are not intended to preclude the transmission of control or signaling information or the use of repetitive codes used by certain digital technologies to complete frame or burst intervals. Applicants shall include in their application for equipment authorization to describe how this requirement is met.

3.6.2 Measuring Instruments

See list of measuring equipment of this test report.

3.6.3 Test Result of Automatically Discontinue Transmission

While the EUT is not transmitting any information, the EUT can automatically discontinue transmission and become standby mode for power saving. The EUT can detect the controlling signal of ACK message transmitting from remote device and verify whether it shall resend or discontinue transmission.



3.7 Antenna Requirements

3.7.1 Standard Applicable

If transmitting antenna directional gain is greater than 6 dBi, both the peak transmit power and the peak power spectral density shall be reduced by the amount in dB that the directional gain of the antenna exceeds 6 dBi.

3.7.2 Antenna Anti-Replacement Construction

An embedded-in antenna design is used.

3.7.3 Antenna Gain

The antenna peak gain of EUT is less than 6 dBi. Therefore, it is not necessary to reduce maximum peak output power limit.



4 List of Measuring Equipment

Instrument	Manufacturer	Model No.	Serial No.	Characteristics	Calibration Date	Test Date	Due Date	Remark
Hygrometer	Testo	DTM-303A	TP157075	N/A	Mar. 06, 2018	Sep. 11, 2018~ Oct. 02, 2018	Mar. 05, 2019	Conducted (TH05-HY)
Power Meter	Anritsu	ML2495A	1132003	N/A	Aug. 16, 2018	Sep. 11, 2018~ Oct. 02, 2018	Aug. 15, 2019	Conducted (TH05-HY)
Power Sensor	Anritsu	MA2411B	1126017	300MHz~40GHz	Aug. 16, 2018	Sep. 11, 2018~ Oct. 02, 2018	Aug. 15, 2019	Conducted (TH05-HY)
Spectrum Analyzer	Rohde & Schwarz	FSP40	100057	9kHz~40GHz	Nov. 21, 2017	Sep. 11, 2018~ Oct. 02, 2018	Nov. 20, 2018	Conducted (TH05-HY)
Signal Analyzer	Rohde & Schwarz	FSV40	101397	10Hz~40GHz	Nov. 07, 2017	Sep. 11, 2018~ Oct. 02, 2018	Nov. 06, 2018	Conducted (TH05-HY)
Switch Box & RF Cable	Burgeon	ETF-058	EC130048 4	N/A	Mar. 01, 2018	Sep. 11, 2018~ Oct. 02, 2018	Feb. 28, 2019	Conducted (TH05-HY)
AC Power Source	ChainTek	APC-1000W	N/A	N/A	N/A	Sep. 17, 2018	N/A	Conduction (CO05-HY)
EMI Test Receiver	Rohde & Schwarz	ESR3	102388	9KHz~3.6GHz	Dec. 08, 2017	Sep. 17, 2018	Dec. 07, 2018	Conduction (CO05-HY)
Hygrometer	Testo	608-H1	34913912	N/A	Mar. 06, 2018	Sep. 17, 2018	Mar. 05, 2019	Conduction (CO05-HY)
LISN	Rohde & Schwarz	ENV216	100080	9kHz~30MHz	Nov. 30, 2017	Sep. 17, 2018	Nov. 29, 2018	Conduction (CO05-HY)
Software	Rohde & Schwarz	EMC32 V10.30	N/A	N/A	N/A	Sep. 17, 2018	N/A	Conduction (CO05-HY)
LF Cable	HUBER + SUHNER	RG-214/U	LF01	N/A	Jan. 03, 2018	Sep. 17, 2018	Jan. 02, 2019	Conduction (CO05-HY)
Pulse Limiter	Rohde & Schwarz	ESH3-Z2	100851	N/A	Jan. 03, 2018	Sep. 17, 2018	Jan. 02, 2019	Conduction (CO05-HY)
Loop Antenna	Rohde & Schwarz	HFH2-Z2	100488	9 kHz~30 MHz	Nov. 23, 2017	Sep. 16, 2018~ Sep. 30, 2018	Nov. 22, 2018	Radiation (03CH15-HY)
Bilog Antenna	TESEQ	CBL6111D&0 0800N1D01N- 06	41912&05	30MHz to 1GHz	Jan. 10, 2018	Sep. 16, 2018~ Sep. 30, 2018	Jan. 09, 2019	Radiation (03CH15-HY)
Preamplifier	Jet-Power	JPA0118-55-3 03	171000180 00550006	1GHz~18GHz	Jul. 10, 2018	Sep. 16, 2018~ Sep. 30, 2018	Jul. 09, 2019	Radiation (03CH15-HY)
EMI Test Receiver	Keysight	N9038A (MXE)	MY541300 85	20Hz ~ 8.4GHz	Oct. 31, 2017	Sep. 16, 2018~ Sep. 30, 2018	Oct. 30, 2018	Radiation (03CH15-HY)
Horn Antenna	SCHWARZBE CK	BBHA 9120D	9120D-162 0	1G~18GHz	Oct. 03, 2017	Sep. 16, 2018~ Sep. 30, 2018	Oct. 02, 2018	Radiation (03CH15-HY)
Hygrometer	TECPEL	DTM-303B	TP162976	N/A	Oct. 12, 2017	Sep. 16, 2018~ Sep. 30, 2018	Oct. 11, 2018	Radiation (03CH15-HY)
Preamplifier	Keysight	83017A	MY532701 95	1GHz~26.5GHz	Aug. 23, 2018	Sep. 16, 2018~ Sep. 30, 2018	Aug. 22, 2019	Radiation (03CH15-HY)
Spectrum Analyzer	Agilent	E4446A	MY501801 36	3Hz~44GHz	Apr. 25, 2018	Sep. 16, 2018~ Sep. 30, 2018	Apr. 24, 2019	Radiation (03CH15-HY)



Instrument	Manufacturer	Model No.	Serial No.	Characteristics	Calibration Date	Test Date	Due Date	Remark
Controller	ChainTek	3000-1	N/A	Control Turn table & Ant Mast	N/A	Sep. 16, 2018~ Sep. 30, 2018	N/A	Radiation (03CH15-HY)
Antenna Mast	ChainTek	MBS-520-1	N/A	1m~4m	N/A	Sep. 16, 2018~ Sep. 30, 2018	N/A	Radiation (03CH15-HY)
Turn Table	ChainTek	T-200-S-1	N/A	0~360 Degree	N/A	Sep. 16, 2018~ Sep. 30, 2018	N/A	Radiation (03CH15-HY)
Amplifier	MITEQ	TTA1840-35-HG	1871923	18GHz~40GHz, VSWR : 2.5:1 max	Jul. 16, 2018	Sep. 16, 2018~ Sep. 30, 2018	Jul. 15, 2019	Radiation (03CH15-HY)
SHF-EHF Horn Antenna	SCHWARZBECK	BBHA 9170	BBHA9170 584	18GHz- 40GHz	Nov. 27, 2017	Sep. 16, 2018~ Sep. 30, 2018	Nov. 26, 2018	Radiation (03CH15-HY)
Software	Audix	E3 6.2009-8-24(K 5)	ARD-SPR- 000185	N/A	N/A	Sep. 16, 2018~ Sep. 30, 2018	N/A	Radiation (03CH15-HY)
RF Cable	HUBER + SUHNER	SUCOFLEX 104	MY36980/ 4	30M-18G	Apr. 16, 2018	Sep. 16, 2018~ Sep. 30, 2018	Apr. 15, 2019	Radiation (03CH15-HY)
RF Cable	HUBER + SUHNER	SUCOFLEX 104	MY9838/4	30M-18GHz	Apr. 16, 2018	Sep. 16, 2018~ Sep. 30, 2018	Apr. 15, 2019	Radiation (03CH15-HY)
RF Cable	HUBER + SUHNER	MTJ	000000-M T18A-100 D3210	30M-18G	Apr. 16, 2018	Sep. 16, 2018~ Sep. 30, 2018	Apr. 15, 2019	Radiation (03CH15-HY)
Cable	HUBER + SUHNER	SUCOFLEX 102	505134/2	30M~40GHz	Oct. 17, 2017	Sep. 16, 2018~ Sep. 30, 2018	Oct. 16, 2018	Radiation (03CH15-HY)
Cable	HUBER + SUHNER	SUCOFLEX 102	800740/2	30M~40GHz	Oct. 17, 2017	Sep. 16, 2018~ Sep. 30, 2018	Oct. 16, 2018	Radiation (03CH15-HY)
Filter	Wainwright	WLKS1200-8 SS	SN3	1.2G Low Pass	Nov. 21, 2017	Sep. 16, 2018~ Sep. 30, 2018	Nov. 20, 2018	Radiation (03CH15-HY)
Filter	Wainwright	WLKS4500-8 SS	SN19	4.5G Low Pass	Mar. 22, 2018	Sep. 16, 2018~ Sep. 30, 2018	Mar. 21, 2019	Radiation (03CH15-HY)
Filter	Woken	WHKX8-5272. 5-6750-18000 -40ST	SN2	6.75G Highpass	Jul. 15, 2018	Sep. 16, 2018~ Sep. 30, 2018	Jul. 14, 2019	Radiation (03CH15-HY)



5 Uncertainty of Evaluation

Uncertainty of Conducted Emission Measurement (150kHz ~ 30MHz)

Measuring Uncertainty for a Level of Confidence of 95% ($U = 2Uc(y)$)	2.20
---	------

Uncertainty of Radiated Emission Measurement (30 MHz ~ 1000 MHz)

Measuring Uncertainty for a Level of Confidence of 95% ($U = 2Uc(y)$)	5.20
---	------

Uncertainty of Radiated Emission Measurement (1000 MHz ~ 18000 MHz)

Measuring Uncertainty for a Level of Confidence of 95% ($U = 2Uc(y)$)	5.50
---	------

Uncertainty of Radiated Emission Measurement (18000 MHz ~ 40000 MHz)

Measuring Uncertainty for a Level of Confidence of 95% ($U = 2Uc(y)$)	5.20
---	------

Appendix A. Test Result of Conducted Test Items

Test Engineer:	Aking Chang/Shiang Wang	Temperature:	21~25	°C
Test Date:	2018/09/11~2018/10/02	Relative Humidity:	51~54	%

TEST RESULTS DATA
6dB and 26dB EBW and 99% OBW

Band IV												
Mod.	Data Rate	NTX	CH.	Freq. (MHz)	99% Bandwidth (MHz)		26dB Bandwidth (MHz)		6 dB Bandwidth (MHz)		6 dB Bandwidth Min. Limit (MHz)	Pass/Fail
					Ant 1	Ant 2	Ant 1	Ant 2	Ant 1	Ant 2		
11a	6Mbps	1	149	5745	16.75	-	25.65	-	14.35	-	0.5	Pass
11a	6Mbps	1	157	5785	16.75	-	24.90	-	14.80	-	0.5	Pass
11a	6Mbps	1	165	5825	16.75	-	24.90	-	14.30	-	0.5	Pass
HT20	MCS0	1	149	5745	18.00	-	27.20	-	14.20	-	0.5	Pass
HT20	MCS0	1	157	5785	17.95	-	26.05	-	12.50	-	0.5	Pass
HT20	MCS0	1	165	5825	17.90	-	25.80	-	15.10	-	0.5	Pass
HT40	MCS0	1	151	5755	36.70	-	41.76	-	35.77	-	0.5	Pass
HT40	MCS0	1	159	5795	36.70	-	42.12	-	35.03	-	0.5	Pass
VHT80	MCS0	1	155	5775	77.16	-	99.52	-	75.20	-	0.5	Pass

TEST RESULTS DATA
Average Power Table

Band IV														
Mod.	Data Rate	NTX	CH.	Freq. (MHz)	Duty Factor (dB)		Average Conducted Power (dBm)			FCC Conducted Power Limit (dBm)		DG (dBi)		Pass/Fail
					Ant 1	Ant 2	Ant 1	Ant 2	SUM	Ant 1	Ant 2	Ant 1	Ant 2	
11a	6Mbps	1	149	5745	0.21	-	14.64	-		30.00	-	-0.69	-	Pass
11a	6Mbps	1	157	5785	0.21	-	14.52	-		30.00	-	-0.69	-	Pass
11a	6Mbps	1	165	5825	0.21	-	13.72	-		30.00	-	-0.69	-	Pass
HT20	MCS0	1	149	5745	0.22	-	15.57	-		30.00	-	-0.69	-	Pass
HT20	MCS0	1	157	5785	0.22	-	13.83	-		30.00	-	-0.69	-	Pass
HT20	MCS0	1	165	5825	0.22	-	13.00	-		30.00	-	-0.69	-	Pass
HT40	MCS0	1	151	5755	0.41	-	15.13	-		30.00	-	-0.69	-	Pass
HT40	MCS0	1	159	5795	0.41	-	14.73	-		30.00	-	-0.69	-	Pass
VHT20	MCS0	1	149	5745	0.22	-	15.53	-		30.00	-	-0.69	-	Pass
VHT20	MCS0	1	157	5785	0.22	-	13.79	-		30.00	-	-0.69	-	Pass
VHT20	MCS0	1	165	5825	0.22	-	12.94	-		30.00	-	-0.69	-	Pass
VHT40	MCS0	1	151	5755	0.41	-	15.10	-		30.00	-	-0.69	-	Pass
VHT40	MCS0	1	159	5795	0.41	-	14.71	-		30.00	-	-0.69	-	Pass
VHT80	MCS0	1	155	5775	0.57	-	16.72	-		30.00	-	-0.69	-	Pass

TEST RESULTS DATA
Power Spectral Density

Band IV																
Mod.	Data Rate	NTX	CH.	Freq. (MHz)	Duty Factor (dB)		10log (500kHz /RBW) Factor (dB)		Average Power Density (dBm/500kHz)			Average PSD Limit (dBm/500kHz)		DG (dBi)		Pass /Fail
					Ant 1	Ant 2	Ant 1	Ant 2	Ant 1	Ant 2	SUM	Ant 1	Ant 2	Ant 1	Ant 2	
11a	6Mbps	1	149	5745	0.21	-	2.22	-	1.84	-		30.00	-	-0.69	-	Pass
11a	6Mbps	1	157	5785	0.21	-	2.22	-	1.18	-		30.00	-	-0.69	-	Pass
11a	6Mbps	1	165	5825	0.21	-	2.22	-	0.63	-		30.00	-	-0.69	-	Pass
HT20	MCS0	1	149	5745	0.22	-	2.22	-	2.35	-		30.00	-	-0.69	-	Pass
HT20	MCS0	1	157	5785	0.22	-	2.22	-	0.16	-		30.00	-	-0.69	-	Pass
HT20	MCS0	1	165	5825	0.22	-	2.22	-	-0.41	-		30.00	-	-0.69	-	Pass
HT40	MCS0	1	151	5755	0.41	-	2.22	-	-1.04	-		30.00	-	-0.69	-	Pass
HT40	MCS0	1	159	5795	0.41	-	2.22	-	-2.03	-		30.00	-	-0.69	-	Pass
VHT80	MCS0	1	155	5775	0.57	-	2.22	-	-3.20	-		30.00	-	-0.69	-	Pass



Appendix B. AC Conducted Emission Test Results

Test Engineer :	Rick Lin	Temperature :	22~23°C
		Relative Humidity :	48~49%

EUT Information

Report NO : 890437
 Test Mode : Mode 1
 Test Voltage : 120Vac/60Hz
 Phase : Line

Full Spectrum

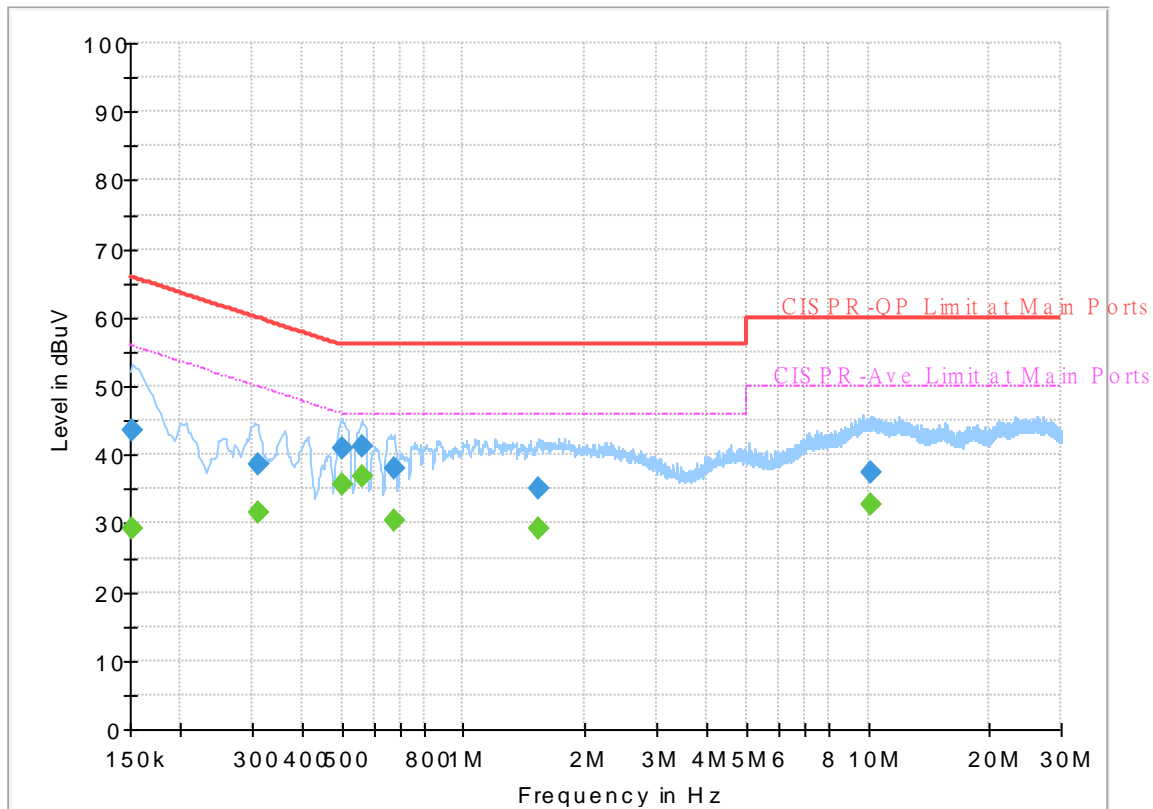

Final Result

Frequency (MHz)	QuasiPeak (dBuV)	CAverage (dBuV)	Limit (dBuV)	Margin (dB)	Line	Filter	Corr. (dB)
0.152250	---	29.23	55.88	26.65	L1	OFF	19.5
0.152250	43.71	---	65.88	22.17	L1	OFF	19.5
0.309750	---	31.52	49.98	18.46	L1	OFF	19.5
0.309750	38.73	---	59.98	21.25	L1	OFF	19.5
0.501000	---	35.58	46.00	10.42	L1	OFF	19.5
0.501000	41.06	---	56.00	14.94	L1	OFF	19.5
0.561750	---	36.89	46.00	9.11	L1	OFF	19.5
0.561750	41.22	---	56.00	14.78	L1	OFF	19.5
0.676500	---	30.49	46.00	15.51	L1	OFF	19.6
0.676500	38.03	---	56.00	17.97	L1	OFF	19.6
1.540500	---	29.36	46.00	16.64	L1	OFF	19.6
1.540500	34.95	---	56.00	21.05	L1	OFF	19.6
10.133250	---	32.85	50.00	17.15	L1	OFF	19.9
10.133250	37.49	---	60.00	22.51	L1	OFF	19.9

EUT Information

Report NO : 890437
 Test Mode : Mode 1
 Test Voltage : 120Vac/60Hz
 Phase : Neutral

Full Spectrum

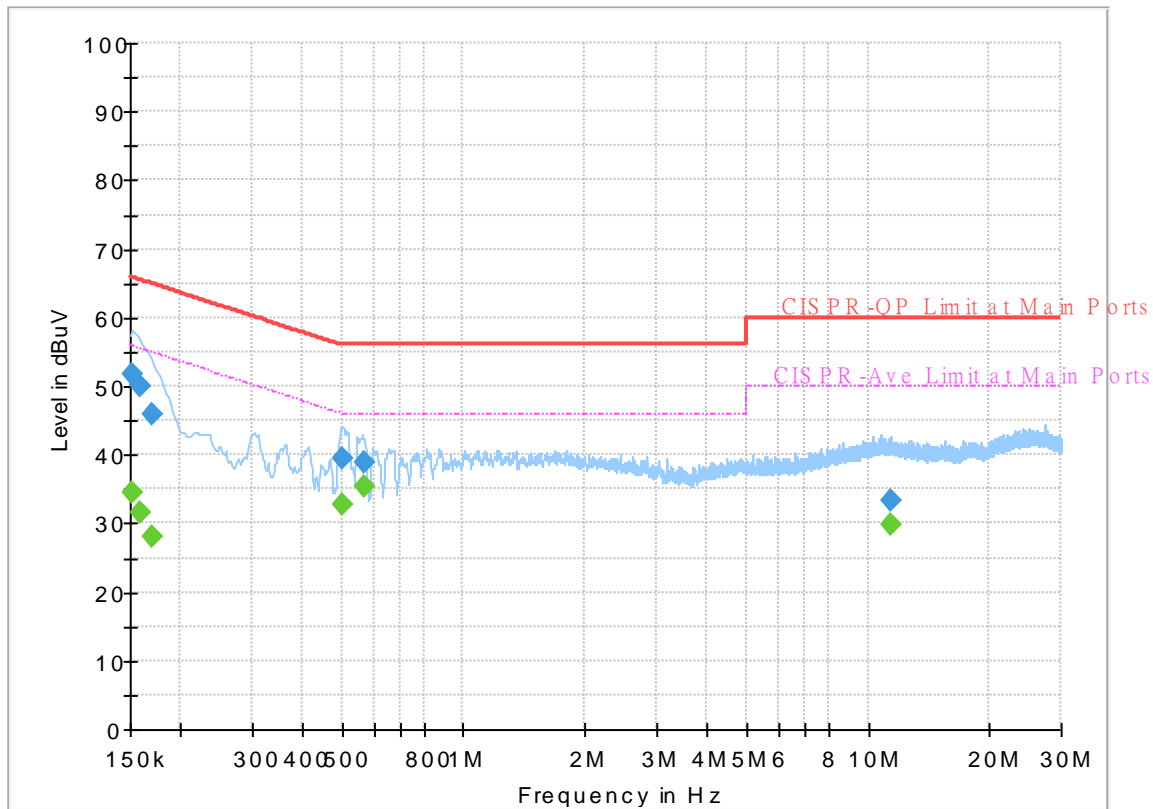

Final_Result

Frequency (MHz)	QuasiPeak (dBuV)	CAverage (dBuV)	Limit (dBuV)	Margin (dB)	Line	Filter	Corr. (dB)
0.152250	---	34.60	55.88	21.28	N	OFF	19.5
0.152250	51.85	---	65.88	14.03	N	OFF	19.5
0.159000	---	31.52	55.52	24.00	N	OFF	19.5
0.159000	50.07	---	65.52	15.45	N	OFF	19.5
0.170250	---	27.93	54.95	27.02	N	OFF	19.5
0.170250	45.99	---	64.95	18.96	N	OFF	19.5
0.501000	---	32.62	46.00	13.38	N	OFF	19.5
0.501000	39.39	---	56.00	16.61	N	OFF	19.5
0.568500	---	35.36	46.00	10.64	N	OFF	19.5
0.568500	38.87	---	56.00	17.13	N	OFF	19.5
11.406750	---	29.92	50.00	20.08	N	OFF	20.0
11.406750	33.36	---	60.00	26.64	N	OFF	20.0



Appendix C. Radiated Spurious Emission

Test Engineer :	Watt Tseng, Karl Hou, and Bill Chang	Temperature :	22~25°C
		Relative Humidity :	52~57%

Band 4 - 5725~5850MHz

WIFI 802.11a (Band Edge @ 3m)

WIFI	Note	Frequency	Level	Over	Limit	Read	Antenna	Path	Preamp	Ant	Table	Peak	Pol.	
Ant.				Limit	Line	Level	Factor	Loss	Factor	Pos	Pos	Avg.		
1		(MHz)	(dBµV/m)	(dB)	(dBµV/m)	(dBµV)	(dB/m)	(dB)	(dB)	(cm)	(deg)	(P/A)	(H/V)	
802.11a CH 149 5745MHz		5609.6	50.73	-17.47	68.2	39.65	32.12	9.17	30.21	100	61	P	H	
		5689	53.98	-43.11	97.09	42.69	32.23	9.31	30.25	100	61	P	H	
		5719.6	58.95	-51.74	110.69	47.57	32.27	9.37	30.26	100	61	P	H	
		5724	61.52	-58.4	119.92	50.13	32.27	9.38	30.26	100	61	P	H	
	*	5745	104.31	-	-	92.87	32.29	9.42	30.27	100	61	P	H	
	*	5745	96.88	-	-	85.44	32.29	9.42	30.27	100	61	A	H	
														H
														H
			5636.2	50.91	-17.29	68.2	39.74	32.17	9.22	30.22	100	221	P	V
			5694.8	55.38	-45.99	101.37	44.07	32.23	9.33	30.25	100	221	P	V
			5711.4	58.08	-50.31	108.39	46.73	32.25	9.36	30.26	100	221	P	V
			5722.2	55.87	-59.95	115.82	44.48	32.27	9.38	30.26	100	221	P	V
	*		5745	105.53	-	-	94.09	32.29	9.42	30.27	100	221	P	V
	*		5745	98.03	-	-	86.59	32.29	9.42	30.27	100	221	A	V
													V	
													V	



WIFI	Note	Frequency	Level	Over	Limit	Read	Antenna	Path	Preamp	Ant	Table	Peak	Pol.	
Ant. 1		(MHz)	(dBμV/m)	(dB)	(dBμV/m)	(dBμV)	(dB/m)	(dB)	(dB)	(cm)	(deg)	(P/A)	(H/V)	
802.11a CH 157 5785MHz		5604.6	50.28	-17.92	68.2	39.21	32.12	9.16	30.21	100	63	P	H	
		5680.6	50.94	-39.94	90.88	39.68	32.21	9.3	30.25	100	63	P	H	
		5706.6	51.23	-55.82	107.05	39.89	32.25	9.35	30.26	100	63	P	H	
		5720.2	50.87	-60.39	111.26	39.49	32.27	9.37	30.26	100	63	P	H	
	*	5785	103.71	-	-	92.19	32.33	9.49	30.3	100	63	P	H	
	*	5785	96.24	-	-	84.72	32.33	9.49	30.3	100	63	A	H	
		5851.8	50.76	-67.34	118.1	39.1	32.41	9.58	30.33	100	63	P	H	
		5857.8	50.44	-59.57	110.01	38.76	32.43	9.59	30.34	100	63	P	H	
		5892.4	51.24	-41.05	92.29	39.49	32.48	9.63	30.36	100	63	P	H	
		5932.8	50.48	-17.72	68.2	38.66	32.52	9.67	30.37	100	63	P	H	
														H
														H
			5622	50.19	-18.01	68.2	39.07	32.14	9.19	30.21	100	222	P	V
			5699.2	50.54	-54.07	104.61	39.23	32.23	9.33	30.25	100	222	P	V
			5706.2	50.75	-56.19	106.94	39.41	32.25	9.35	30.26	100	222	P	V
			5723.2	50.46	-67.64	118.1	39.07	32.27	9.38	30.26	100	222	P	V
	*		5785	105	-	-	93.48	32.33	9.49	30.3	100	222	P	V
	*		5785	97.51	-	-	85.99	32.33	9.49	30.3	100	222	A	V
			5852.6	51.59	-64.68	116.27	39.93	32.41	9.58	30.33	100	222	P	V
			5873.4	50.74	-54.91	105.65	39.02	32.46	9.6	30.34	100	222	P	V
		5910.4	51.24	-27.73	78.97	39.46	32.5	9.65	30.37	100	222	P	V	
		5937.4	51.05	-17.15	68.2	39.23	32.52	9.68	30.38	100	222	P	V	
													V	
													V	



WIFI	Note	Frequency	Level	Over	Limit	Read	Antenna	Path	Preamp	Ant	Table	Peak	Pol.	
Ant. 1		(MHz)	(dBμV/m)	(dB)	Line (dBμV/m)	Level (dBμV)	Factor (dB/m)	Loss (dB)	Factor (dB)	Pos (cm)	Pos (deg)	Avg. (P/A)	(H/V)	
802.11a CH 165 5825MHz	*	5825	103.05	-	-	91.43	32.39	9.55	30.32	100	63	P	H	
	*	5825	95.56	-	-	83.94	32.39	9.55	30.32	100	63	A	H	
		5851	52.82	-67.1	119.92	41.16	32.41	9.58	30.33	100	63	P	H	
		5865.8	53.57	-54.2	107.77	41.88	32.43	9.6	30.34	100	63	P	H	
		5881.2	52.1	-48.49	100.59	40.37	32.46	9.61	30.34	100	63	P	H	
		5926.6	50.56	-17.64	68.2	38.74	32.52	9.67	30.37	100	63	P	H	
														H
														H
	*	5825	104.86	-	-	93.24	32.39	9.55	30.32	100	226	P	V	
	*	5825	96.84	-	-	85.22	32.39	9.55	30.32	100	226	A	V	
		5852.2	53.73	-63.45	117.18	42.07	32.41	9.58	30.33	100	226	P	V	
		5859.8	54.12	-55.33	109.45	42.44	32.43	9.59	30.34	100	226	P	V	
		5879.6	51.92	-49.86	101.78	40.19	32.46	9.61	30.34	100	226	P	V	
		5935.2	51.45	-16.75	68.2	39.63	32.52	9.68	30.38	100	226	P	V	
														V
														V
													V	
Remark	1. No other spurious found. 2. All results are PASS against Peak and Average limit line.													



Band 4 5725~5850MHz
WIFI 802.11a (Harmonic @ 3m)

WIFI Ant.	Note	Frequency	Level	Over Limit	Limit Line	Read Level	Antenna Factor	Path Loss	Preamp Factor	Ant Pos	Table Pos	Peak Avg.	Pol.
1		(MHz)	(dBμV/m)	(dB)	(dBμV/m)	(dBμV)	(dB/m)	(dB)	(dB)	(cm)	(deg)	(P/A)	(H/V)
802.11a CH 149 5745MHz		11490	54.86	-19.14	74	61.55	40.41	13.92	61.02	100	197	P	H
		11490	45.1	-8.9	54	51.79	40.41	13.92	61.02	100	197	A	H
		17235	49.7	-18.5	68.2	49.63	41.71	17.88	59.52	100	0	P	H
													H
		11490	60.69	-13.31	74	67.38	40.41	13.92	61.02	100	288	P	V
		11490	49.89	-4.11	54	56.58	40.41	13.92	61.02	100	288	A	V
		17235	50.14	-18.06	68.2	50.07	41.71	17.88	59.52	100	0	P	V
802.11a CH 157 5785MHz		11570	55.04	-18.96	74	61.81	40.22	13.95	60.94	100	254	P	H
		11570	43.25	-10.75	54	50.02	40.22	13.95	60.94	100	254	A	H
		17355	50.64	-17.56	68.2	49.63	42.32	18.06	59.37	100	0	P	H
													H
		11570	61.66	-12.34	74	68.43	40.22	13.95	60.94	100	292	P	V
		11570	50.69	-3.31	54	57.46	40.22	13.95	60.94	100	292	A	V
		17355	50.56	-17.64	68.2	49.55	42.32	18.06	59.37	100	0	P	V
802.11a CH 165 5825MHz		11650	54.27	-19.73	74	61.13	40.04	13.98	60.88	100	198	P	H
		11650	44.25	-9.75	54	51.11	40.04	13.98	60.88	100	198	A	H
		17475	50.82	-17.38	68.2	48.93	42.93	18.19	59.23	100	0	P	H
													H
		11650	62.55	-11.45	74	69.41	40.04	13.98	60.88	100	278	P	V
		11650	50.86	-3.14	54	57.72	40.04	13.98	60.88	100	278	A	V
		17475	49.76	-18.44	68.2	47.87	42.93	18.19	59.23	100	0	P	V
Remark	1. No other spurious found. 2. All results are PASS against Peak and Average limit line.												



Band 4 5725~5850MHz
WIFI 802.11n HT20 (Band Edge @ 3m)

WIFI Ant. 1	Note	Frequency (MHz)	Level (dBμV/m)	Over Limit (dB)	Limit Line (dBμV/m)	Read Level (dBμV)	Antenna Factor (dB/m)	Path Loss (dB)	Preamp Factor (dB)	Ant Pos (cm)	Table Pos (deg)	Peak Avg. (P/A)	Pol. (H/V)	
802.11n HT20 CH 149 5745MHz		5644.4	51.05	-17.15	68.2	39.87	32.17	9.23	30.22	100	61	P	H	
		5686.2	59.4	-35.62	95.02	48.11	32.23	9.31	30.25	100	61	P	H	
		5717.2	63.39	-46.63	110.02	52.03	32.25	9.37	30.26	100	61	P	H	
		5721.4	59.92	-54.07	113.99	48.54	32.27	9.37	30.26	100	61	P	H	
	*	5745	105.51	-	-	94.07	32.29	9.42	30.27	100	61	P	H	
	*	5745	97.84	-	-	86.4	32.29	9.42	30.27	100	61	A	H	
														H
														H
			5600.8	50.53	-17.67	68.2	39.45	32.12	9.15	30.19	100	225	P	V
			5694.4	58.23	-42.84	101.07	46.93	32.23	9.32	30.25	100	225	P	V
			5715.2	61.32	-48.14	109.46	49.97	32.25	9.36	30.26	100	225	P	V
			5724.8	59.88	-61.86	121.74	48.49	32.27	9.38	30.26	100	225	P	V
	*		5745	106.29	-	-	94.85	32.29	9.42	30.27	100	225	P	V
	*		5745	98.6	-	-	87.16	32.29	9.42	30.27	100	225	A	V
														V
													V	



WIFI	Note	Frequency	Level	Over	Limit	Read	Antenna	Path	Preamp	Ant	Table	Peak	Pol.
Ant. 1		(MHz)	(dBµV/m)	(dB)	(dBµV/m)	(dBµV)	(dB/m)	(dB)	(dB)	(cm)	(deg)	(P/A)	(H/V)
		5636	50.41	-17.79	68.2	39.24	32.17	9.22	30.22	100	62	P	H
		5681	50.98	-40.2	91.18	39.72	32.21	9.3	30.25	100	62	P	H
		5709.8	51.69	-56.26	107.95	40.35	32.25	9.35	30.26	100	62	P	H
		5724.2	51.8	-68.58	120.38	40.41	32.27	9.38	30.26	100	62	P	H
	*	5785	103.31	-	-	91.79	32.33	9.49	30.3	100	62	P	H
	*	5785	95.57	-	-	84.05	32.33	9.49	30.3	100	62	A	H
		5854	51.41	-61.67	113.08	39.73	32.43	9.58	30.33	100	62	P	H
		5855.2	51.72	-59.02	110.74	40.04	32.43	9.58	30.33	100	62	P	H
		5907	50.67	-30.81	81.48	38.89	32.5	9.64	30.36	100	62	P	H
		5933.8	50.78	-17.42	68.2	38.96	32.52	9.67	30.37	100	62	P	H
802.11n													H
HT20													H
CH 157		5622.8	50.62	-17.58	68.2	39.5	32.14	9.19	30.21	100	224	P	V
5785MHz		5695.8	51.95	-50.15	102.1	40.64	32.23	9.33	30.25	100	224	P	V
		5720	54.45	-56.35	110.8	43.07	32.27	9.37	30.26	100	224	P	V
		5720	54.45	-56.35	110.8	43.07	32.27	9.37	30.26	100	224	P	V
	*	5785	104.23	-	-	92.71	32.33	9.49	30.3	100	224	P	V
	*	5785	96.69	-	-	85.17	32.33	9.49	30.3	100	224	A	V
		5854.2	51.02	-61.6	112.62	39.34	32.43	9.58	30.33	100	224	P	V
		5855.2	52.52	-58.22	110.74	40.84	32.43	9.58	30.33	100	224	P	V
		5906.4	51.51	-30.42	81.93	39.73	32.5	9.64	30.36	100	224	P	V
		5947.4	51.17	-17.03	68.2	39.32	32.54	9.69	30.38	100	224	P	V
													V
													V



WIFI	Note	Frequency	Level	Over	Limit	Read	Antenna	Path	Preamp	Ant	Table	Peak	Pol.	
Ant. 1		(MHz)	(dBµV/m)	(dB)	Line (dBµV/m)	Level (dBµV)	Factor (dB/m)	Loss (dB)	Factor (dB)	Pos (cm)	Pos (deg)	Avg. (P/A)	(H/V)	
802.11n HT20 CH 165 5825MHz	*	5825	102.61	-	-	90.99	32.39	9.55	30.32	100	61	P	H	
	*	5825	94.82	-	-	83.2	32.39	9.55	30.32	100	61	A	H	
		5850.4	54.05	-67.24	121.29	42.39	32.41	9.58	30.33	100	61	P	H	
		5869	52.81	-54.07	106.88	41.12	32.43	9.6	30.34	100	61	P	H	
		5888.8	51.52	-43.44	94.96	39.78	32.48	9.62	30.36	100	61	P	H	
		5936.8	51.65	-16.55	68.2	39.83	32.52	9.68	30.38	100	61	P	H	
														H
														H
	*	5825	103.55	-	-	91.93	32.39	9.55	30.32	100	225	P	V	
	*	5825	95.87	-	-	84.25	32.39	9.55	30.32	100	225	A	V	
		5852.8	55.08	-60.74	115.82	43.42	32.41	9.58	30.33	100	225	P	V	
		5859.8	54.65	-54.8	109.45	42.97	32.43	9.59	30.34	100	225	P	V	
		5922.8	51	-18.82	69.82	39.19	32.52	9.66	30.37	100	225	P	V	
		5935	51.42	-16.78	68.2	39.6	32.52	9.68	30.38	100	225	P	V	
														V
													V	
Remark	1. No other spurious found. 2. All results are PASS against Peak and Average limit line.													



Band 4 5725~5850MHz
WIFI 802.11n HT20 (Harmonic @ 3m)

WIFI Ant.	Note	Frequency	Level	Over Limit	Limit Line	Read Level	Antenna Factor	Path Loss	Preamp Factor	Ant Pos	Table Pos	Peak Avg.	Pol.
1		(MHz)	(dBμV/m)	(dB)	(dBμV/m)	(dBμV)	(dB/m)	(dB)	(dB)	(cm)	(deg)	(P/A)	(H/V)
802.11n HT20 CH 149 5745MHz		11490	56.71	-17.29	74	63.4	40.41	13.92	61.02	103	199	P	H
		11490	43.83	-10.17	54	50.52	40.41	13.92	61.02	103	199	A	H
		17235	49.69	-18.51	68.2	49.62	41.71	17.88	59.52	100	0	P	H
													H
		11490	64.45	-9.55	74	71.14	40.41	13.92	61.02	100	283	P	V
		11490	50.91	-3.09	54	57.6	40.41	13.92	61.02	100	283	A	V
		17235	49.69	-18.51	68.2	49.62	41.71	17.88	59.52	100	0	P	V
													V
802.11n HT20 CH 157 5785MHz		11570	54.93	-19.07	74	61.7	40.22	13.95	60.94	102	223	P	H
		11570	43.43	-10.57	54	50.2	40.22	13.95	60.94	102	223	A	H
		17355	51.18	-17.02	68.2	50.17	42.32	18.06	59.37	100	0	P	H
													H
		11570	61.89	-12.11	74	68.66	40.22	13.95	60.94	103	284	P	V
		11570	50.23	-3.77	54	57	40.22	13.95	60.94	103	284	A	V
		17355	50.72	-17.48	68.2	49.71	42.32	18.06	59.37	100	0	P	V
													V
802.11n HT20 CH 165 5825MHz		11650	55.25	-18.75	74	62.11	40.04	13.98	60.88	100	233	P	H
		11650	43.62	-10.38	54	50.48	40.04	13.98	60.88	100	233	A	H
		17475	50.39	-17.81	68.2	48.5	42.93	18.19	59.23	100	0	P	H
													H
		11650	61.37	-12.63	74	68.23	40.04	13.98	60.88	100	282	P	V
		11650	50.35	-3.65	54	57.21	40.04	13.98	60.88	100	282	A	V
		17475	51.14	-17.06	68.2	49.25	42.93	18.19	59.23	100	0	P	V
													V
Remark	1. No other spurious found. 2. All results are PASS against Peak and Average limit line.												



Band 4 5725~5850MHz
WIFI 802.11n HT40 (Band Edge @ 3m)

WIFI Ant. 1	Note	Frequency (MHz)	Level (dBμV/m)	Over Limit (dB)	Limit Line (dBμV/m)	Read Level (dBμV)	Antenna Factor (dB/m)	Path Loss (dB)	Preamp Factor (dB)	Ant Pos (cm)	Table Pos (deg)	Peak Avg. (P/A)	Pol. (H/V)
		5622.2	52.08	-16.12	68.2	40.96	32.14	9.19	30.21	100	62	P	H
		5693	58.53	-41.51	100.04	47.23	32.23	9.32	30.25	100	62	P	H
		5709	61.3	-46.42	107.72	49.96	32.25	9.35	30.26	100	62	P	H
		5724.2	61.4	-58.98	120.38	50.01	32.27	9.38	30.26	100	62	P	H
	*	5755	101.49	-	-	90.01	32.31	9.44	30.27	100	62	P	H
	*	5755	93.82	-	-	82.34	32.31	9.44	30.27	100	62	A	H
		5851	50.28	-69.64	119.92	38.62	32.41	9.58	30.33	100	62	P	H
		5867.2	50.19	-57.19	107.38	38.5	32.43	9.6	30.34	100	62	P	H
		5911.8	51.35	-26.59	77.94	39.57	32.5	9.65	30.37	100	62	P	H
		5939.8	50.8	-17.4	68.2	38.96	32.54	9.68	30.38	100	62	P	H
802.11n													H
HT40													H
CH 151		5627.4	50.77	-17.43	68.2	39.64	32.14	9.2	30.21	100	224	P	V
5755MHz		5696.4	58.65	-43.9	102.55	47.34	32.23	9.33	30.25	100	224	P	V
		5718.4	63.37	-46.98	110.35	51.99	32.27	9.37	30.26	100	224	P	V
		5723	62.14	-55.5	117.64	50.75	32.27	9.38	30.26	100	224	P	V
	*	5755	103.31	-	-	91.83	32.31	9.44	30.27	100	224	P	V
	*	5755	95.48	-	-	84	32.31	9.44	30.27	100	224	A	V
		5850.8	50.34	-70.04	120.38	38.68	32.41	9.58	30.33	100	224	P	V
		5862	50.91	-57.93	108.84	39.23	32.43	9.59	30.34	100	224	P	V
		5885.2	51.53	-46.1	97.63	39.81	32.46	9.62	30.36	100	224	P	V
		5948.4	50.83	-17.37	68.2	38.98	32.54	9.69	30.38	100	224	P	V
													V
													V



WIFI	Note	Frequency	Level	Over	Limit	Read	Antenna	Path	Preamp	Ant	Table	Peak	Pol.
Ant. 1		(MHz)	(dBµV/m)	(dB)	Line (dBµV/m)	Level (dBµV)	Factor (dB/m)	Loss (dB)	Factor (dB)	Pos (cm)	Pos (deg)	Avg. (P/A)	(H/V)
		5647.6	51.21	-16.99	68.2	40.02	32.17	9.24	30.22	100	55	P	H
		5691.8	51.36	-47.79	99.15	40.06	32.23	9.32	30.25	100	55	P	H
		5710.4	53.84	-54.27	108.11	42.5	32.25	9.35	30.26	100	55	P	H
		5723.6	51.74	-67.27	119.01	40.35	32.27	9.38	30.26	100	55	P	H
	*	5795	100.48	-	-	88.92	32.35	9.51	30.3	100	55	P	H
	*	5795	92.63	-	-	81.07	32.35	9.51	30.3	100	55	A	H
		5854.4	54.42	-57.75	112.17	42.74	32.43	9.58	30.33	100	55	P	H
		5855.8	51.92	-58.66	110.58	40.24	32.43	9.58	30.33	100	55	P	H
		5877	51.94	-51.77	103.71	40.21	32.46	9.61	30.34	100	55	P	H
		5934.8	50.55	-17.65	68.2	38.73	32.52	9.68	30.38	100	55	P	H
802.11n													H
HT40													H
CH 159		5642.4	50.2	-18	68.2	39.02	32.17	9.23	30.22	100	224	P	V
5795MHz		5695	51.01	-50.5	101.51	39.7	32.23	9.33	30.25	100	224	P	V
		5710.2	53.97	-54.09	108.06	42.63	32.25	9.35	30.26	100	224	P	V
		5720.2	54.45	-56.81	111.26	43.07	32.27	9.37	30.26	100	224	P	V
	*	5795	102.48	-	-	90.92	32.35	9.51	30.3	100	224	P	V
	*	5795	94.7	-	-	83.14	32.35	9.51	30.3	100	224	A	V
		5854.2	55.61	-57.01	112.62	43.93	32.43	9.58	30.33	100	224	P	V
		5863.4	55.84	-52.61	108.45	44.16	32.43	9.59	30.34	100	224	P	V
		5877.6	52.28	-50.99	103.27	40.55	32.46	9.61	30.34	100	224	P	V
		5944.8	51.56	-16.64	68.2	39.71	32.54	9.69	30.38	100	224	P	V
													V
													V
Remark	1. No other spurious found. 2. All results are PASS against Peak and Average limit line.												



Band 4 5725~5850MHz
WIFI 802.11n HT40 (Harmonic @ 3m)

WIFI Ant.	Note	Frequency	Level	Over Limit	Limit Line	Read Level	Antenna Factor	Path Loss	Preamp Factor	Ant Pos	Table Pos	Peak Avg.	Pol.
1		(MHz)	(dBμV/m)	(dB)	(dBμV/m)	(dBμV)	(dB/m)	(dB)	(dB)	(cm)	(deg)	(P/A)	(H/V)
802.11n HT40 CH 151 5755MHz		11510	51.74	-22.26	74	58.4	40.4	13.93	60.99	100	221	P	H
		11510	43.72	-10.28	54	50.38	40.4	13.93	60.99	100	221	A	H
		17265	49.93	-18.27	68.2	49.59	41.89	17.93	59.48	100	0	P	H
													H
		11510	57.96	-16.04	74	64.62	40.4	13.93	60.99	100	284	P	V
		11510	50.76	-3.24	54	57.42	40.4	13.93	60.99	100	284	A	V
		17265	48.81	-19.39	68.2	48.47	41.89	17.93	59.48	100	0	P	V
													V
802.11n HT40 CH 159 5795MHz		11590	51.99	-22.01	74	58.78	40.18	13.96	60.93	100	222	P	H
		11590	43.73	-10.27	54	50.52	40.18	13.96	60.93	100	222	A	H
		17385	50.01	-18.19	68.2	48.78	42.49	18.08	59.34	100	0	P	H
													H
		11590	58.38	-15.62	74	65.17	40.18	13.96	60.93	100	281	P	V
		11590	50.5	-3.5	54	57.29	40.18	13.96	60.93	100	281	A	V
		17385	49.75	-18.45	68.2	48.52	42.49	18.08	59.34	100	0	P	V
													V
Remark	1. No other spurious found. 2. All results are PASS against Peak and Average limit line.												



Band 4 5725~5850MHz
WIFI 802.11ac VHT80 (Band Edge @ 3m)

WIFI Ant. 1	Note	Frequency (MHz)	Level (dBμV/m)	Over Limit (dB)	Limit Line (dBμV/m)	Read Level (dBμV)	Antenna Factor (dB/m)	Path Loss (dB)	Preamp Factor (dB)	Ant Pos (cm)	Table Pos (deg)	Peak Avg. (P/A)	Pol. (H/V)
		5643.2	51.79	-16.41	68.2	40.61	32.17	9.23	30.22	100	62	P	H
		5698.2	65.76	-38.11	103.87	54.45	32.23	9.33	30.25	100	62	P	H
		5717.4	65.13	-44.94	110.07	53.77	32.25	9.37	30.26	100	62	P	H
		5721.2	64.28	-49.26	113.54	52.9	32.27	9.37	30.26	100	62	P	H
	*	5775	98.35	-	-	86.84	32.33	9.47	30.29	100	62	P	H
	*	5775	90.55	-	-	79.04	32.33	9.47	30.29	100	62	A	H
		5853.6	63.94	-50.05	113.99	52.26	32.43	9.58	30.33	100	62	P	H
		5855.8	60.96	-49.62	110.58	49.28	32.43	9.58	30.33	100	62	P	H
		5875.6	56.46	-48.29	104.75	44.73	32.46	9.61	30.34	100	62	P	H
		5929	50.9	-17.3	68.2	39.08	32.52	9.67	30.37	100	62	P	H
													H
													H
802.11ac VHT80 CH 155 5775MHz		5644	53.59	-14.61	68.2	42.41	32.17	9.23	30.22	100	113	P	V
		5698.2	68.91	-34.96	103.87	57.6	32.23	9.33	30.25	100	113	P	V
		5720	70.43	-40.37	110.8	59.05	32.27	9.37	30.26	100	113	P	V
		5720	70.43	-40.37	110.8	59.05	32.27	9.37	30.26	100	113	P	V
	*	5775	101.85	-	-	90.34	32.33	9.47	30.29	100	113	P	V
	*	5775	94.18	-	-	82.67	32.33	9.47	30.29	100	113	A	V
		5853.4	65.23	-49.22	114.45	53.57	32.41	9.58	30.33	100	113	P	V
		5858.4	64.21	-45.64	109.85	52.53	32.43	9.59	30.34	100	113	P	V
		5875	60.27	-44.93	105.2	48.54	32.46	9.61	30.34	100	113	P	V
		5929	52.29	-15.91	68.2	40.47	32.52	9.67	30.37	100	113	P	V
													V
													V
Remark	1. No other spurious found. 2. All results are PASS against Peak and Average limit line.												



Band 4 5725~5850MHz
WIFI 802.11ac VHT80 (Harmonic @ 3m)

WIFI	Note	Frequency	Level	Over	Limit	Read	Antenna	Path	Preamp	Ant	Table	Peak	Pol.
Ant. 1		(MHz)	(dBμV/m)	(dB)	(dBμV/m)	(dBμV)	(dB/m)	(dB)	(dB)	(cm)	(deg)	(P/A)	(H/V)
802.11ac VHT80 CH 155 5775MHz		11550	52.93	-21.07	74	59.67	40.27	13.95	60.96	100	221	P	H
		11550	43.65	-10.35	54	50.39	40.27	13.95	60.96	100	221	A	H
		17325	49.15	-19.05	68.2	48.39	42.15	18.02	59.41	100	0	P	H
													H
		11550	59.61	-14.39	74	66.35	40.27	13.95	60.96	103	285	P	V
		11550	50.34	-3.66	54	57.08	40.27	13.95	60.96	103	285	A	V
		17325	48.47	-19.73	68.2	47.71	42.15	18.02	59.41	100	0	P	V
													V
Remark	1. No other spurious found. 2. All results are PASS against Peak and Average limit line.												



Note symbol

*	Fundamental Frequency which can be ignored. However, the level of any unwanted emissions shall not exceed the level of the fundamental frequency.
!	Test result is over limit line.
P/A	Peak or Average
H/V	Horizontal or Vertical



A calculation example for radiated spurious emission is shown as below:

WIFI	Note	Frequency	Level	Over	Limit	Read	Antenna	Path	Preamp	Ant	Table	Peak	Pol.
Ant.				Limit	Line	Level	Factor	Loss	Factor	Pos	Pos	Avg.	
1		(MHz)	(dBμV/m)	(dB)	(dBμV/m)	(dBμV)	(dB/m)	(dB)	(dB)	(cm)	(deg)	(P/A)	(H/V)
802.11b		2390	55.45	-18.55	74	54.51	32.22	4.58	35.86	103	308	P	H
CH 01													
2412MHz		2390	43.54	-10.46	54	42.6	32.22	4.58	35.86	103	308	A	H

1. Path Loss(dB) = Cable loss(dB) + Filter loss(dB) + Attenuator loss(dB)
2. Level(dBμV/m) = Antenna Factor(dB/m) + Path Loss(dB) + Read Level(dBμV) - Preamp Factor(dB)
3. Over Limit(dB) = Level(dBμV/m) – Limit Line(dBμV/m)

For Peak Limit @ 2390MHz:

1. Level(dBμV/m)
= Antenna Factor(dB/m) + Path Loss(dB) + Read Level(dBμV) - Preamp Factor(dB)
= 32.22(dB/m) + 4.58(dB) + 54.51(dBμV) – 35.86 (dB)
= 55.45 (dBμV/m)
2. Over Limit(dB)
= Level(dBμV/m) – Limit Line(dBμV/m)
= 55.45(dBμV/m) – 74(dBμV/m)
= -18.55(dB)

For Average Limit @ 2390MHz:

1. Level(dBμV/m)
= Antenna Factor(dB/m) + Path Loss(dB) + Read Level(dBμV) - Preamp Factor(dB)
= 32.22(dB/m) + 4.58(dB) + 42.6(dBμV) – 35.86 (dB)
= 43.54 (dBμV/m)
2. Over Limit(dB) = Level(dBμV/m) – Limit Line(dBμV/m)
= 43.54(dBμV/m) – 54(dBμV/m)
= -10.46(dB)

Both peak and average measured complies with the limit line, so test result is “PASS”.



Appendix D. Radiated Spurious Emission Plots

Test Engineer :	Watt Tseng, Karl Hou, and Bill Chang	Temperature :	22~25°C
		Relative Humidity :	52~57%

Note symbol

-L	Low channel location
-R	High channel location

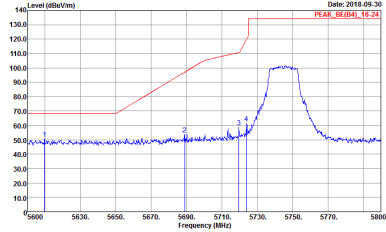
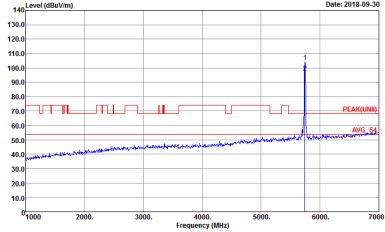

Band 4 - 5725~5850MHz
WIFI 802.11a (Band Edge @ 3m)

WIFI	Band 4 5725~5850MHz Band Edge @ 3m	
ANT	802.11a CH149 5745MHz	
1	Horizontal	Fundamental
<p>Peak</p>	 <p>Site : 03CH15-1FY Condition : PEAK_BE(04)_16-24 3m 91200_15_1620 HORIZONTAL RBW:1000.000KHz VBW:3000.000KHz SWT:Auto Detector : Peak Project : 890437 Mode : 30</p>	 <p>Site : 03CH15-1FY Condition : PEAK(LINII) 3m 91200_15_1620 HORIZONTAL RBW:1000.000KHz VBW:3000.000KHz SWT:Auto Detector : Peak Project : 890437 Mode : 30</p>

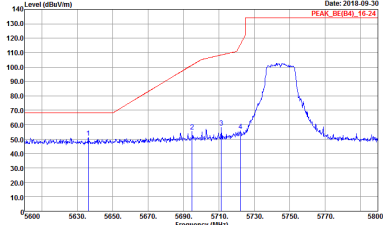
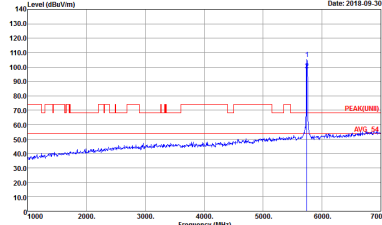

WIFI	Band 4 5725~5850MHz Band Edge @ 3m	
ANT	802.11a CH149 5745MHz	
1	Vertical	Fundamental
<p>Peak</p>	 <p>Date: 2018-09-30 PEAK_8E(84)_16-24</p> <p>Site : 03CH15-HY Condition : PEAK_8E(84)_16-24 3m 91200_15_1620 VERTICAL RBW:1000.000KHz VBW:3000.000KHz SWT:Auto Detector : Peak Project : 890437 Mode : 30</p>	 <p>Date: 2018-09-30 PEAK(U)RB</p> <p>Site : 03CH15-HY Condition : PEAK(U)RB 3m 91200_15_1620 VERTICAL RBW:1000.000KHz VBW:3000.000KHz SWT:Auto Detector : Peak Project : 890437 Mode : 30</p>



WIFI	Band 4 5725~5850MHz Band Edge @ 3m	
ANT	802.11a CH157 5785MHz	
1	Horizontal	Fundamental
<p>Peak</p>	<p>Date: 2018-09-30 PEAK_BE(04)_15-20</p> <p>Site : 03CH15-HY Condition : PEAK_BE(04)_16-24 3m 91200_15_1620 HORIZONTAL Detector : Peak Project : 890437 Mode : 31</p>	<p>Date: 2018-09-30 PEAK(04)_15-20</p> <p>Site : 03CH15-HY Condition : PEAK(UNII) 3m 91200_15_1620 HORIZONTAL Detector : Peak Project : 890437 Mode : 31</p>
<p>Peak</p>	<p>Date: 2018-09-30 PEAK_BE(04)_16-24</p> <p>Site : 03CH15-HY Condition : PEAK_BE(04)_16-24 3m 91200_15_1620 HORIZONTAL Detector : Peak Project : 890437 Mode : 31</p>	<p>Left blank</p>



WIFI	Band 4 5725~5850MHz Band Edge @ 3m	
ANT	802.11a CH157 5785MHz	
1	Vertical	Fundamental
Peak	<p>Site : 03CH15-HY Condition : PEAK_BE(B4)_16-24 3m 91200_15_1620 VERTICAL Detector : Peak Project : 890437 Mode : 31</p>	<p>Site : 03CH15-HY Condition : PEAK(UNII) 3m 91200_15_1620 VERTICAL Detector : Peak Project : 890437 Mode : 31</p>
Peak	<p>Site : 03CH15-HY Condition : PEAK_BE(B4)_16-24 3m 91200_15_1620 VERTICAL Detector : Peak Project : 890437 Mode : 31</p>	Left blank

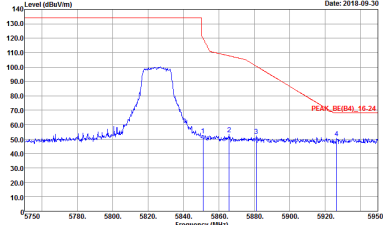
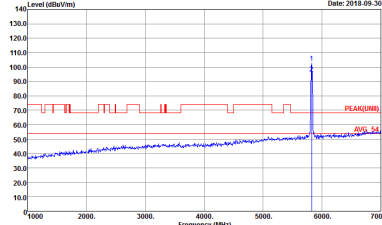

WIFI	Band 4 5725~5850MHz Band Edge @ 3m	
ANT	802.11a CH165 5825MHz	
1	Horizontal	Fundamental
<p>Peak</p>	 <p>Date: 2018-09-30</p> <p>PEAK_BE(B4)_16-24</p> <p>Site : 03CH15-HY Condition : PEAK_BE(B4)_16-24 3m 91200_15_1620 HORIZONTAL RBW:1000.000KHz VBW:3000.000KHz SWT:Auto Detector : Peak Project : 890437 Mode : 32</p>	 <p>Date: 2018-09-30</p> <p>PEAK(FUNB)</p> <p>Site : 03CH15-HY Condition : PEAK(FUNB)_3m 91200_15_1620 HORIZONTAL RBW:1000.000KHz VBW:3000.000KHz SWT:Auto Detector : Peak Project : 890437 Mode : 32</p>

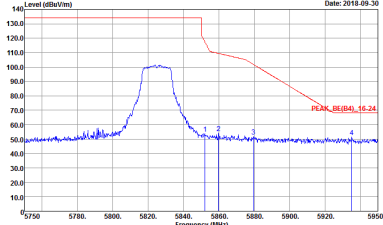
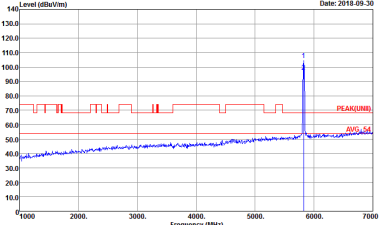

WIFI	Band 4 5725~5850MHz Band Edge @ 3m	
ANT	802.11a CH165 5825MHz	
1	Vertical	Fundamental
<p>Peak</p>	 <p>Date: 2018-09-30</p> <p>PEAK_BE(B4)_16-24</p> <pre> Site : 03CH15-HY Condition : PEAK_BE(B4)_16-24 3m 91200_15_1620 VERTICAL RBW : RBW:1000.000KHz VBW:3000.000KHz SWT:Auto Detector : Peak Project : 890437 Mode : 32 </pre>	 <p>Date: 2018-09-30</p> <p>PEAK(FUNB)</p> <pre> Site : 03CH15-HY Condition : PEAK(FUNB)_3m 91200_15_1620 VERTICAL RBW : RBW:1000.000KHz VBW:3000.000KHz SWT:Auto Detector : Peak Project : 890437 Mode : 32 </pre>



Band 4 5725~5850MHz
WIFI 802.11n HT20 (Band Edge @ 3m)

WIFI	Band 4 5725~5850MHz Band Edge @ 3m	
ANT	802.11n HT20 CH149 5745MHz	
1	Horizontal	Fundamental
Peak	<p>Site : 03CH15-HY Condition : PEAK_8E(84)_16-24 3m 91200_15_1620 HORIZONTAL Detector : RBW:3000.000KHz VBW:3000.000KHz SWT:Auto Project : 890437 Mode : 33</p>	<p>Site : 03CH15-HY Condition : PEAK(UNIT) 3m 91200_15_1620 HORIZONTAL Detector : RBW:3000.000KHz VBW:3000.000KHz SWT:Auto Project : 890437 Mode : 33</p>



WIFI	Band 4 5725~5850MHz Band Edge @ 3m	
ANT	802.11n HT20 CH149 5745MHz	
1	Vertical	Fundamental
<p>Peak</p>	<p>Site : 03CH15-HY Condition : PEAK_BE(84)_16-24 3m 91200_15_1620 VERTICAL Detector : Peak Project : 890437 Mode : 33</p>	<p>Site : 03CH15-HY Condition : PEAK(UNII) 3m 91200_15_1620 VERTICAL Detector : Peak Project : 890437 Mode : 33</p>



WIFI	Band 4 5725~5850MHz Band Edge @ 3m	
ANT	802.11n HT20 CH157 5785MHz	
1	Horizontal	Fundamental
Peak	<p>Site : 03CH15-HY Condition : PEAK_BE(B4)_16-24 3m 91200_15_1620 HORIZONTAL Detector : Peak Project : 890437 Mode : 34</p>	<p>Site : 03CH15-HY Condition : PEAK(UNII) 3m 91200_15_1620 HORIZONTAL Detector : Peak Project : 890437 Mode : 34</p>
Peak	<p>Site : 03CH15-HY Condition : PEAK_BE(B4)_16-24 3m 91200_15_1620 HORIZONTAL Detector : Peak Project : 890437 Mode : 34</p>	Left blank



WIFI	Band 4 5725~5850MHz Band Edge @ 3m	
ANT	802.11n HT20 CH157 5785MHz	
1	Vertical	Fundamental
<p>Peak</p>	<p>Site : 03CH15-HY Condition : PEAK_BE(B4)_16-24 3m 91200_15_1620 VERTICAL Detector : Peak Project : 890437 Mode : 34</p>	<p>Site : 03CH15-HY Condition : PEAK(UNII) 3m 91200_15_1620 VERTICAL Detector : Peak Project : 890437 Mode : 34</p>
<p>Peak</p>	<p>Site : 03CH15-HY Condition : PEAK_BE(B4)_16-24 3m 91200_15_1620 VERTICAL Detector : Peak Project : 890437 Mode : 34</p>	<p>Left blank</p>

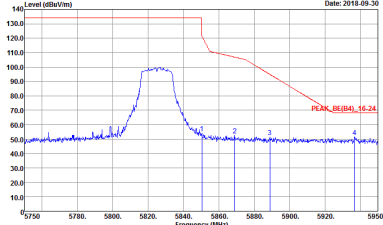
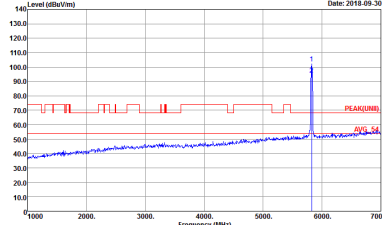

WIFI	Band 4 5725~5850MHz Band Edge @ 3m	
ANT	802.11n HT20 CH165 5825MHz	
1	Horizontal	Fundamental
<p>Peak</p>	 <p>Date: 2018-09-30</p> <p>PEAK_BE(B4)_16-24</p> <p>Site : 03CH15-HY Condition : PEAK_BE(B4)_16-24 3m 91200_15_1620 HORIZONTAL RBW:1000.000KHz VBW:3000.000KHz SWT:Auto Detector : Peak Project : 890437 Mode : 35</p>	 <p>Date: 2018-09-30</p> <p>PEAK(FUNB)</p> <p>Site : 03CH15-HY Condition : PEAK(FUNII) 3m 91200_15_1620 HORIZONTAL RBW:1000.000KHz VBW:3000.000KHz SWT:Auto Detector : Peak Project : 890437 Mode : 35</p>



WIFI	Band 4 5725~5850MHz Band Edge @ 3m	
ANT	802.11n HT20 CH165 5825MHz	
1	Vertical	Fundamental
Peak	<p>Site : 03CH15-HY Condition : PEAK_BE(B4)_16-24 3m 91200_15_1620 VERTICAL RBW:1000.000KHz VBW:3000.000KHz SWT:Auto Detector : Peak Project : 890437 Mode : 35</p>	<p>Site : 03CH15-HY Condition : PEAK(UNII) 3m 91200_15_1620 VERTICAL RBW:1000.000KHz VBW:3000.000KHz SWT:Auto Detector : Peak Project : 890437 Mode : 35</p>

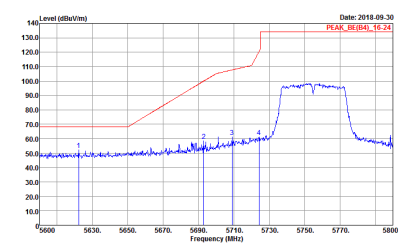
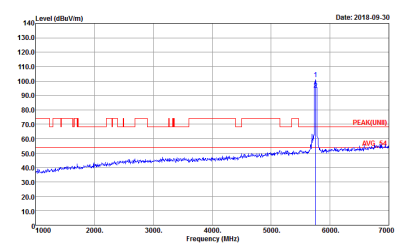
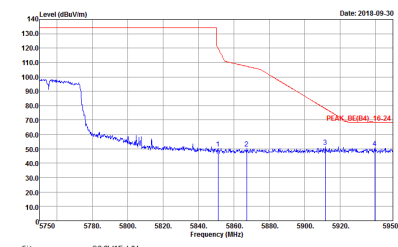

Band 4 5725~5850MHz
WIFI 802.11n HT40 (Band Edge @ 3m)

WIFI	Band 4 5725~5850MHz Band Edge @ 3m	
ANT	802.11n HT40 CH151 5755MHz	
1	Horizontal	Fundamental
Peak	 <p>Site : 03CH15-HY Condition : PEAK_BE(B4)_16-24 3m 91200_15_1620 HORIZONTAL Detector : RBW:1000.000KHz VBW:3000.000KHz SWT:Auto Project : 890437 Mode : 36</p>	 <p>Site : 03CH15-HY Condition : PEAK(UNIT) 3m 91200_15_1620 HORIZONTAL Detector : RBW:1000.000KHz VBW:3000.000KHz SWT:Auto Project : 890437 Mode : 36</p>
Peak	 <p>Site : 03CH15-HY Condition : PEAK_BE(B4)_16-24 3m 91200_15_1620 HORIZONTAL Detector : RBW:1000.000KHz VBW:3000.000KHz SWT:Auto Project : 890437 Mode : 36</p>	Left blank



WIFI	Band 4 5725~5850MHz Band Edge @ 3m	
ANT	802.11n HT40 CH151 5755MHz	
1	Vertical	Fundamental
Peak	<p>Site : 03CH15-HY Condition : PEAK_BE(B4)_16-24 3m 91200_15_1620 VERTICAL Detector : Peak Project : 890437 Mode : 36</p>	<p>Site : 03CH15-HY Condition : PEAK(UNII) 3m 91200_15_1620 VERTICAL Detector : Peak Project : 890437 Mode : 36</p>
Peak	<p>Site : 03CH15-HY Condition : PEAK_BE(B4)_16-24 3m 91200_15_1620 VERTICAL Detector : Peak Project : 890437 Mode : 36</p>	Left blank

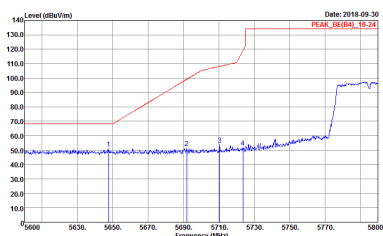
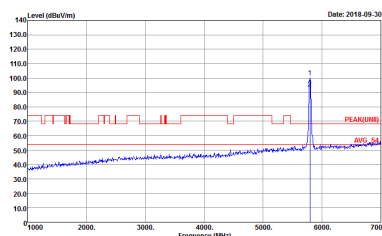
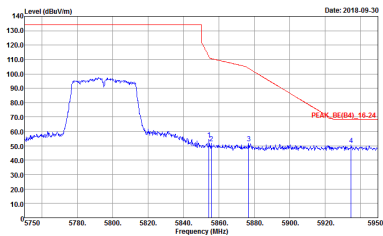

WIFI	Band 4 5725~5850MHz Band Edge @ 3m	
ANT	802.11n HT40 CH159 5795MHz	
1	Horizontal	Fundamental
<p>Peak</p>	 <p>Site : 03CH15-HY Condition : PEAK_BE(04)_16-24 3m 91200_15_1620 HORIZONTAL Detector : Peak Project : 890437 Mode : 37</p>	 <p>Site : 03CH15-HY Condition : PEAK(UNII) 3m 91200_15_1620 HORIZONTAL Detector : Peak Project : 890437 Mode : 37</p>
<p>Peak</p>	 <p>Site : 03CH15-HY Condition : PEAK_BE(04)_16-24 3m 91200_15_1620 HORIZONTAL Detector : Peak Project : 890437 Mode : 37</p>	<p>Left blank</p>



WIFI	Band 4 5725~5850MHz Band Edge @ 3m	
ANT	802.11n HT40 CH159 5795MHz	
1	Vertical	Fundamental
Peak	<p>Site : 03CH15-HY Condition : PEAK_BE(B4)_16-24 3m 91200_15_1620 VERTICAL Detector : Peak Project : 890437 Mode : 37</p>	<p>Site : 03CH15-HY Condition : PEAK(UNII) 3m 91200_15_1620 VERTICAL Detector : Peak Project : 890437 Mode : 37</p>
Peak	<p>Site : 03CH15-HY Condition : PEAK_BE(B4)_16-24 3m 91200_15_1620 VERTICAL Detector : Peak Project : 890437 Mode : 37</p>	Left blank



Band 4 5725~5850MHz
WIFI 802.11ac VHT80 (Band Edge @ 3m)

WIFI	Band 4 5725~5850MHz Band Edge @ 3m	
ANT	802.11ac VHT80 CH155 5775MHz	
1	Horizontal	Fundamental
Peak	<p>Site : 03CH15-HY Condition : PEAK_BE(B4)_16-24 3m 91200_15_1620 HORIZONTAL Detector : Peak Project : 890437 Mode : 38</p>	<p>Site : 03CH15-HY Condition : PEAK(UNIT) 3m 91200_15_1620 HORIZONTAL Detector : Peak Project : 890437 Mode : 38</p>
Peak	<p>Site : 03CH15-HY Condition : PEAK_BE(B4)_16-24 3m 91200_15_1620 HORIZONTAL Detector : Peak Project : 890437 Mode : 38</p>	Left blank



WIFI	Band 4 5725~5850MHz Band Edge @ 3m	
ANT	802.11ac VHT80 CH155 5775MHz	
1	Vertical	Fundamental
Peak	<p> Site : 03CH15-HY Condition : PEAK_BE(B4)_16-24 3m 91200_15_1620 VERTICAL Detector : Peak Project : 890437 Mode : 38 </p>	<p> Site : 03CH15-HY Condition : PEAK(UNII) 3m 91200_15_1620 VERTICAL Detector : Peak Project : 890437 Mode : 38 </p>
Peak	<p> Site : 03CH15-HY Condition : PEAK_BE(B4)_16-24 3m 91200_15_1620 VERTICAL Detector : Peak Project : 890437 Mode : 38 </p>	Left blank



Band 4 - 5725~5850MHz
WIFI 802.11a (Harmonic @ 3m)

WIFI	Band 4 5725~5850MHz Harmonic @ 3m	
ANT	802.11a CH149 5745MHz	
1	Horizontal	Vertical
Peak Avg.	<p>Site : 03CH15-1#Y Condition : PEAK(UWB) 3m 9120D_15_1620 HORIZONTAL Detector : Peak Project : 890437 Mode : 30 Setting : 13.5</p>	<p>Site : 03CH15-1#Y Condition : PEAK(UWB) 3m 9120D_15_1620 VERTICAL Detector : Peak Project : 890437 Mode : 30 Setting : 13.5</p>

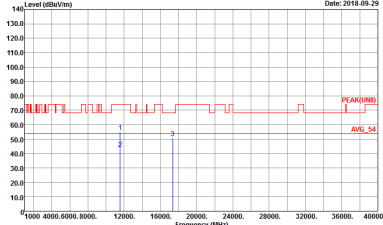
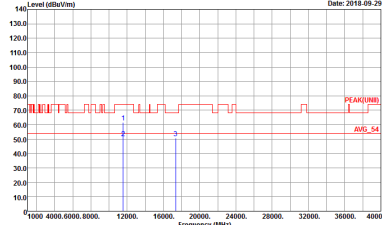

WIFI	Band 4 5725~5850MHz Harmonic @ 3m	
ANT	802.11a CH157 5785MHz	
1	Horizontal	Vertical
<p>Peak</p> <p>Avg.</p>	 <p>Date: 2018-09-29</p> <p>Site : 03CH15-HY Condition : PEAK(UNII) 3m 91200_15_1620 HORIZONTAL Detector : Peak Project : 890437 Mode : 31 Setting : 13.5</p>	 <p>Date: 2018-09-29</p> <p>Site : 03CH15-HY Condition : PEAK(UNII) 3m 91200_15_1620 VERTICAL Detector : Peak Project : 890437 Mode : 31 Setting : 13.5</p>

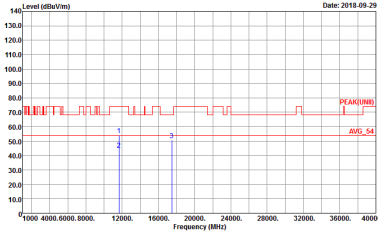
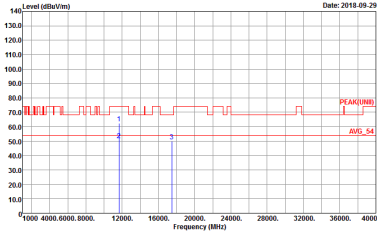

WIFI	Band 4 5725~5850MHz Harmonic @ 3m	
ANT	802.11a CH165 5825MHz	
1	Horizontal	Vertical
<p>Peak</p> <p>Avg.</p>	 <p>Site : 03CH15-HY Condition : PEAK(UNII) 3m 91200_15_1620 HORIZONTAL Detector : Peak Project : 890437 Mode : 32 Setting : 13.5</p>	 <p>Site : 03CH15-HY Condition : PEAK(UNII) 3m 91200_15_1620 VERTICAL Detector : Peak Project : 890437 Mode : 32 Setting : 13.5</p>



Band 4 5725~5850MHz
WIFI 802.11n HT20 (Harmonic @ 3m)

Table with 2 columns: WIFI (Band 4 5725~5850MHz Harmonic @ 3m), ANT (802.11n HT20 CH149 5745MHz). Row 1: 1, Horizontal, Vertical. Includes spectral plots and technical details like Site, Condition, Detector, Project, Mode, Setting.

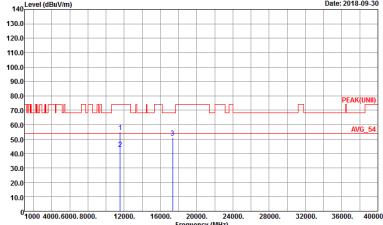
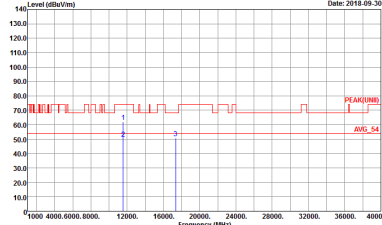

WIFI	Band 4 5725~5850MHz Harmonic @ 3m	
ANT	802.11n HT20 CH157 5785MHz	
1	Horizontal	Vertical
<p>Peak Avg.</p>	 <p>Site : 03CH15-HY Condition : PEAK(UNII) 3m 91200_15_1620 HORIZONTAL Detector : Peak Project : 890437 Mode : 34 Setting : 13</p>	 <p>Site : 03CH15-HY Condition : PEAK(UNII) 3m 91200_15_1620 VERTICAL Detector : Peak Project : 890437 Mode : 34 Setting : 13</p>



WIFI	Band 4 5725~5850MHz Harmonic @ 3m	
ANT	802.11n HT20 CH165 5825MHz	
1	Horizontal	Vertical
Peak Avg.	<p>Site : 03CH15-HY Condition : PEAK(UNII) 3m 91200_15_1620 HORIZONTAL Detector : Peak Project : 890437 Mode : 35 Setting : 13</p>	<p>Site : 03CH15-HY Condition : PEAK(UNII) 3m 91200_15_1620 VERTICAL Detector : Peak Project : 890437 Mode : 35 Setting : 13</p>



**Band 4 5725~5850MHz
WIFI 802.11n HT40 (Harmonic @ 3m)**

WIFI	Band 4 5725~5850MHz Harmonic @ 3m	
ANT	802.11n HT40 CH151 5755MHz	
1	Horizontal	Vertical
Peak Avg.	<p>Site : 03CH15-HY Condition : PEAK(UNII) 3m 91200_15_1620 HORIZONTAL Detector : Peak Project : 890437 Mode : 36 Setting : 13.5</p>	<p>Site : 03CH15-HY Condition : PEAK(UNII) 3m 91200_15_1620 VERTICAL Detector : Peak Project : 890437 Mode : 36 Setting : 13.5</p>

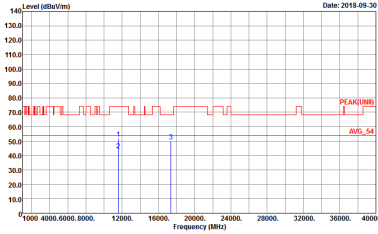
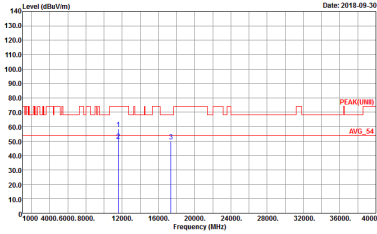

WIFI	Band 4 5725~5850MHz Harmonic @ 3m	
ANT	802.11n HT40 CH159 5795MHz	
1	Horizontal	Vertical
<p>Peak</p> <p>Avg.</p>	 <p>Site : 03CH15-HY Condition : PEAK(UNII) 3m 91200_15_1620 HORIZONTAL Detector : Peak Project : 890437 Mode : 37 Setting : 13.5</p>	 <p>Site : 03CH15-HY Condition : PEAK(UNII) 3m 91200_15_1620 VERTICAL Detector : Peak Project : 890437 Mode : 37 Setting : 13.5</p>



Band 4 5725~5850MHz
WIFI 802.11ac VHT80 (Harmonic @ 3m)

WIFI	Band 4 5725~5850MHz Harmonic @ 3m	
ANT	802.11ac VHT80 CH155 5775MHz	
1	Horizontal	Vertical
Peak Avg.	<p>Site : 03CH15-HY Condition : PEAK(UNII) 3m 91200_15_1620 HORIZONTAL Detector : Peak Project : 890437 Mode : 38 Setting : 15.5</p>	<p>Site : 03CH15-HY Condition : PEAK(UNII) 3m 91200_15_1620 VERTICAL Detector : Peak Project : 890437 Mode : 38 Setting : 15.5</p>

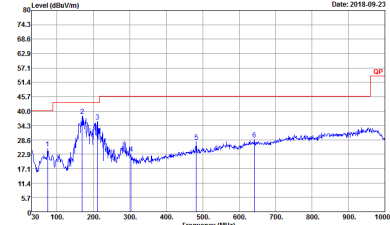
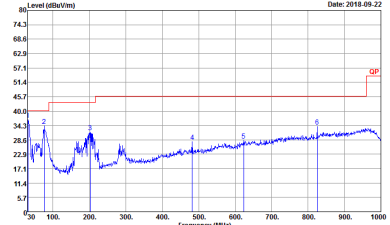

Emission below 1GHz
5GHz WIFI 802.11n HT20 (LF)

WIFI	5GHz 5725~5850MHz	
ANT	802.11n HT20 LF	
1	Horizontal	Vertical
<p>QP / Peak</p>	 <p>Site : 03CH15-11Y Condition : QP 3m BTL0G_15_41912 HORIZONTAL Detector : Peak Project : 890437 Mode : 39</p>	 <p>Site : 03CH15-11Y Condition : QP 3m BTL0G_15_41912 VERTICAL Detector : Peak Project : 890437 Mode : 39</p>



Appendix E. Duty Cycle Plots

Band	Duty Cycle (%)	T(us)	1/T(kHz)	VBW Setting	Duty Factor(dB)
802.11a	95.31	2030	0.493	1kHz	0.21
5GHz 802.11n HT20	95.07	1930	0.518	1kHz	0.22
5GHz 802.11n HT40	90.91	950	1.053	3kHz	0.41
5GHz 802.11ac VHT20	95.10	1940	0.515	1kHz	0.22
5GHz 802.11ac VHT40	90.91	950	1.053	3kHz	0.41
5GHz 802.11ac VHT80	87.77	603	1.658	3kHz	0.57



802.11a

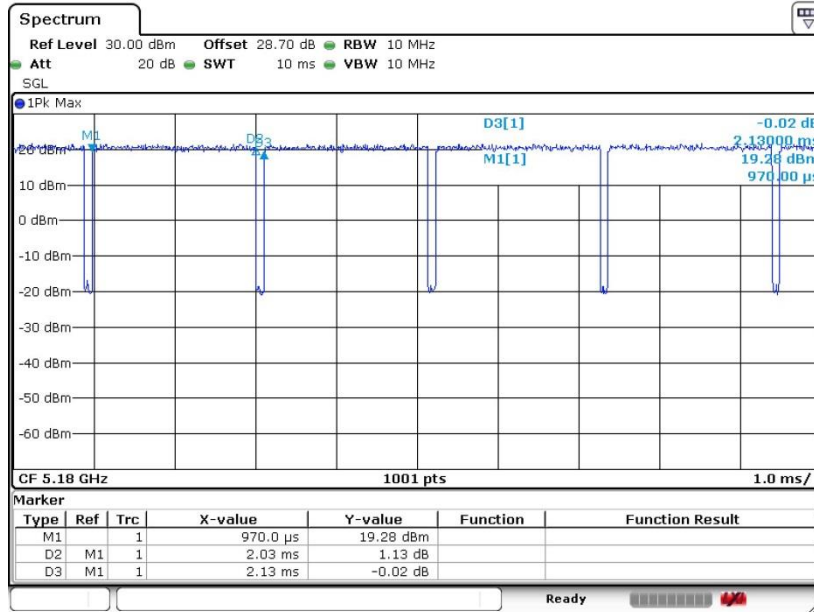

Date: 12.SEP.2018 06:46:05

802.11n HT20

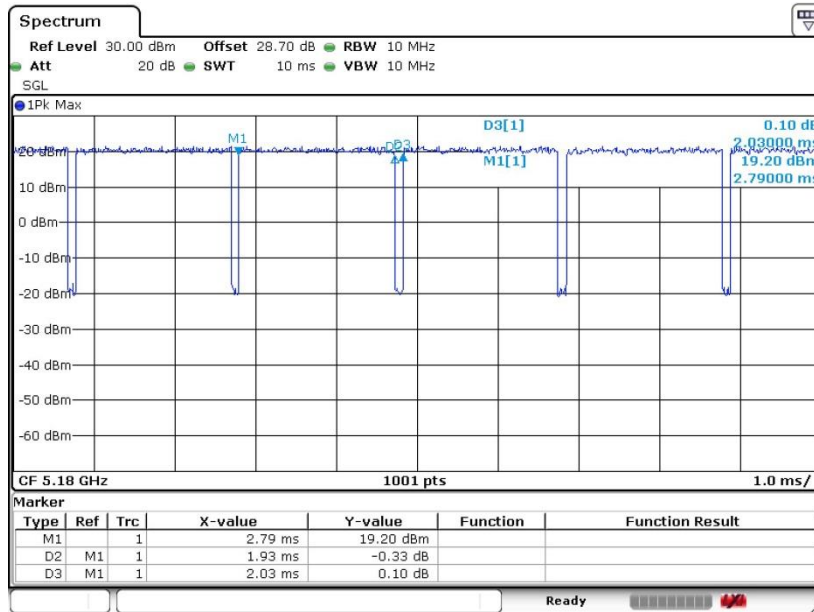

Date: 12.SEP.2018 07:44:09



802.11n HT40

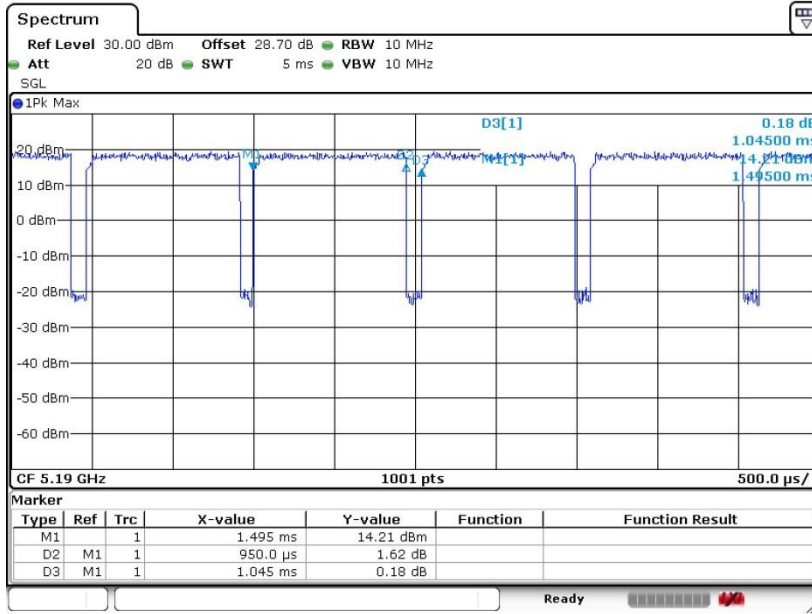

Date: 12.SEP.2018 06:57:14

802.11ac VHT20

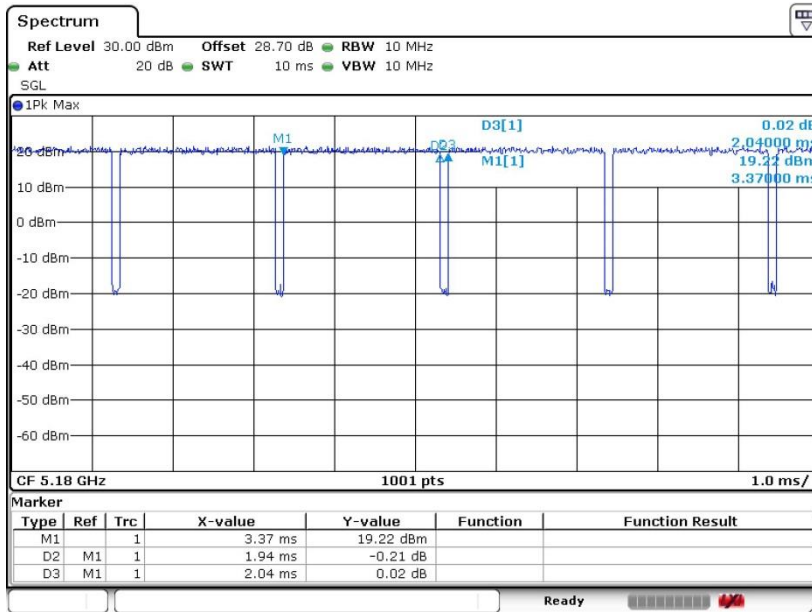

Date: 12.SEP.2018 07:05:00



802.11ac VHT40

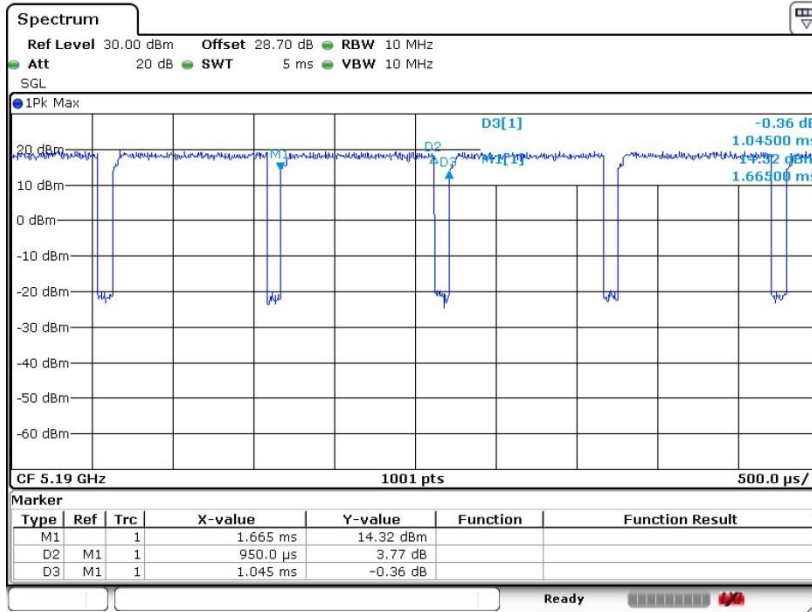

Date: 12.SEP.2018 07:08:52

802.11ac VHT80

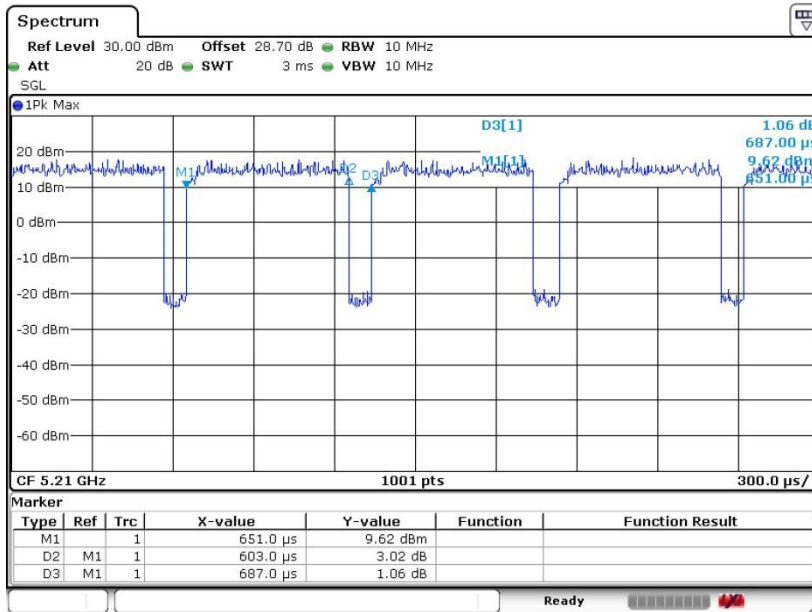

Date: 12.SEP.2018 07:15:11

—THE END—