



# FCC RF Test Report

**APPLICANT** : Motorola Mobility LLC  
**EQUIPMENT** : Mobile Cellular Phone  
**BRAND NAME** : Motorola  
**MODEL NAME** : XT1920-18, XT1920-19  
**FCC ID** : IHDT56XH2  
**STANDARD** : 47 CFR Part 2, 22(H), 24(E), 27(L), 27(M)  
**CLASSIFICATION** : PCS Licensed Transmitter Held to Ear (PCE)

The product was received on Apr. 12, 2018 and completely tested on May 04, 2018. We, Sporton International (Kunshan) Inc., would like to declare that the tested sample has been evaluated in accordance with the procedures given in ANSI C63.26-2015 and shown compliance with the applicable technical standards.

The test results in this report apply exclusively to the tested model / sample. Without written approval of Sporton International (Kunshan) Inc., the test report shall not be reproduced except in full.



Approved by: James Huang / Manager

**Sporton International (Kunshan) Inc.**

**No.3-2 Ping-Xiang Rd, Kunshan Development Zone Kunshan City Jiangsu Province 215335  
China**



TABLE OF CONTENTS

REVISION HISTORY..... 3
SUMMARY OF TEST RESULT ..... 4
1 GENERAL DESCRIPTION ..... 5
1.1. Applicant ..... 5
1.2. Manufacturer ..... 5
1.3. Product Feature of Equipment Under Test..... 5
1.4. Product Specification of Equipment Under Test..... 6
1.5. Modification of EUT ..... 6
1.6. Specification of Accessory ..... 7
1.7. Maximum ERP/EIRP Power, Frequency Tolerance, and Emission Designator ..... 8
1.8. Testing Location ..... 10
1.9. Applicable Standards..... 10
2 TEST CONFIGURATION OF EQUIPMENT UNDER TEST ..... 11
2.1. Test Mode ..... 11
2.2. Connection Diagram of Test System ..... 13
2.3. Support Unit used in test configuration and system ..... 13
2.4. Measurement Results Explanation Example ..... 13
2.5. Frequency List of Low/Middle/High Channels ..... 14
3 CONDUCTED TEST ITEMS ..... 16
3.1. Measuring Instruments ..... 16
3.2. Test Setup ..... 16
3.3. Test Result of Conducted Test ..... 16
3.4. Conducted Output Power and ERP/EIRP ..... 17
3.5. Peak-to-Average Ratio ..... 18
3.6. Occupied Bandwidth ..... 19
3.7. Conducted Band Edge ..... 20
3.8. Conducted Spurious Emission ..... 22
3.9. Frequency Stability ..... 23
4 RADIATED TEST ITEMS ..... 24
4.1. Measuring Instruments ..... 24
4.2. Test Setup ..... 24
4.3. Test Result of Radiated Test ..... 24
4.4. Radiated Spurious Emission ..... 25
5 LIST OF MEASURING EQUIPMENT ..... 26
6 UNCERTAINTY OF EVALUATION ..... 27
APPENDIX A. TEST RESULTS OF CONDUCTED TEST
APPENDIX B. TEST RESULTS OF RADIATED TEST
APPENDIX C. TEST SETUP PHOTOGRAPHS



### REVISION HISTORY

REPORT NO.	VERSION	DESCRIPTION	ISSUED DATE
FG841203B	Rev. 01	Initial issue of report	May 24, 2018



## SUMMARY OF TEST RESULT

Report Section	FCC Rule	Description	Limit	Result	Remark
3.4	§2.1046	Conducted Output Power	Reporting Only	PASS	-
	§22.913(a)(5)	Effective Radiated Power (Band 5)	ERP < 7 Watt		
	§24.232(c) §27.50(h)(2)	Equivalent Isotropic Radiated Power (Band 2) (Band 7)	EIRP < 2Watt		
	§27.50(d)(4)	Equivalent Isotropic Radiated Power (Band 4)	EIRP < 1Watt		
3.5	§24.232(d)	Peak-to-Average Ratio	<13 dB	PASS	-
3.6	§2.1049	Occupied Bandwidth	Reporting Only	PASS	-
3.7	§2.1051 §22.917(a) §24.238(a) §27.53(h)	Conducted Band Edge Measurement (Band 2) (Band 4) (Band 5)	< 43+10log <sub>10</sub> (P[Watts])	PASS	-
	§27.53(m)(4)	Conducted Band Edge Measurement (Band 7)	§27.53(m)(4)		
3.8	§2.1051 §22.917(a) §24.238(a) §27.53(h)	Conducted Spurious Emission (Band 2) (Band 4) (Band 5)	< 43+10log <sub>10</sub> (P[Watts])	PASS	-
	§2.1051 §27.53(m)(4)	Conducted Spurious Emission (Band 7)	< 55+10log <sub>10</sub> (P[Watts])		
3.9	§2.1055 §22.355	Frequency Stability Temperature & Voltage	< 2.5 ppm for Part 22	PASS	-
	§2.1055 §24.235 §27.54		Within Authorized Band		
4.4	§2.1053 §22.917(a) §24.238(a) §27.53(h)	Radiated Spurious Emission (Band 2) (Band 4) (Band 5)	< 43+10log <sub>10</sub> (P[Watts])	PASS	Under limit 34.06 dB at 10107.00 MHz
	§2.1053 §27.53(m)(4)	Radiated Spurious Emission (Band 7)	< 55+10log <sub>10</sub> (P[Watts])		



# 1 General Description

## 1.1. Applicant

Motorola Mobility LLC  
222 W,Merchandise Mart Plaza, Chicago IL 60654 USA

## 1.2. Manufacturer

Motorola Mobility LLC  
222 W,Merchandise Mart Plaza, Chicago IL 60654 USA

## 1.3. Product Feature of Equipment Under Test

Product Feature	
Equipment	Mobile Cellular Phone
Brand Name	Motorola
Model Name	XT1920-18, XT1920-19
FCC ID	IHDT56XH2
EUT supports Radios application	GSM/GPRS/EGPRS/WCDMA/HSPA/DC-HSDPA/ HSPA+(16QAM uplink is not supported)/LTE/ WLAN 2.4GHz 802.11b/g/n HT20/ Bluetooth v3.0 + EDR/Bluetooth v4.0 LE/ Bluetooth v4.1 LE/Bluetooth v4.2 LE
IMEI Code	Conducted:355534090027292/355534090027300 Radiation: 355534090027714/355534090027722
HW Version	DVT2
SW Version	OPG28.25
EUT Stage	Identical Prototype

**Remark:**

1. The above EUT's information was declared by manufacturer. Please refer to the specifications or user's manual for more detailed description.
2. There are two types of EUT: XT1920-18 is single SIM card, XT1920-19 is dual SIM card.



### 1.4. Product Specification of Equipment Under Test

Standards-related Product Specification	
<b>Tx Frequency</b>	LTE Band 2 : 1850.7 MHz ~ 1909.3 MHz LTE Band 4 : 1710.7 MHz ~ 1754.3 MHz LTE Band 5 : 824.7 MHz ~ 848.3 MHz LTE Band 7 : 2502.5 MHz ~ 2567.5 MHz
<b>Rx Frequency</b>	LTE Band 2 : 1930.7 MHz ~ 1989.3 MHz LTE Band 4 : 2110.7 MHz ~ 2154.3 MHz LTE Band 5 : 869.7 MHz ~ 893.3 MHz LTE Band 7 : 2622.5MHz ~ 2687.5 MHz
<b>Bandwidth</b>	LTE Band 2 : 1.4MHz / 3MHz / 5MHz / 10MHz / 15MHz / 20MHz LTE Band 4 : 1.4MHz / 3MHz / 5MHz / 10MHz / 15MHz / 20MHz LTE Band 5 : 1.4MHz / 3MHz / 5MHz / 10MHz LTE Band 7 : 5MHz/ 10MHz / 15MHz / 20MHz
<b>Maximum Output Power to Antenna</b>	LTE Band 2 : 23.23 dBm LTE Band 4 : 23.14 dBm LTE Band 5 : 23.26 dBm LTE Band 7 : 23.43 dBm
<b>Antenna Gain</b>	LTE Band 2 : -3.60 dBi LTE Band 4 : -2.50 dBi LTE Band 5 : -5.14 dBi LTE Band 7 : -1.60 dBi
<b>Type of Modulation</b>	QPSK / 16QAM

### 1.5. Modification of EUT

No modifications are made to the EUT during all test items.



### 1.6. Specification of Accessory

Specification of Accessory				
AC Adapter 1(US)	Brand Name	Motorola (Acbel)	Model Name	C-P56 SPN5947A
	Power Rating	I/P: 100-240 Vac, 130mA, O/P: 5Vdc,1000mA		
AC Adapter 1(EU)	Brand Name	Motorola (Acbel)	Model Name	C-P57 SPN5948A
	Power Rating	I/P: 100-240 Vac, 130mA, O/P: 5Vdc,1000mA		
AC Adapter 1(AR)	Brand Name	Motorola (Acbel)	Model Name	C-P60 SPN5951A
	Power Rating	I/P: 100-240 Vac, 130mA, O/P: 5Vdc,1000mA		
AC Adapter 2(US)	Brand Name	Motorola(Chenyang)	Model Name	C-P56 SPN5987A
	Power Rating	I/P: 100-240 Vac, 130mA, O/P: 5Vdc,1000mA		
AC Adapter 2(EU)	Brand Name	Motorola(Chenyang)	Model Name	C-P57 SPN5985A
	Power Rating	I/P: 100-240 Vac, 130mA, O/P: 5Vdc,1000mA		
AC Adapter 2(AR)	Brand Name	Motorola(Chenyang)	Model Name	C-P60 SPN5984A
	Power Rating	I/P: 100-240 Vac, 130mA, O/P: 5Vdc,1000mA		
AC Adapter 3(BR)	Brand Name	Motorola(Salcomp)	Model Name	S11D38LNA
	Power Rating	I/P: 100-240 Vac, 450mA, O/P: 5Vdc,2000mA		
AC Adapter 4(BR)	Brand Name	Motorola(Salom)	Model Name	SSW-2865BR
	Power Rating	I/P: 100-240 Vac, 500mA, O/P: 5Vdc,2000mA		
AC Adapter 5(BR)	Brand Name	Motorola(Cliptech)	Model Name	S010BFD0500200
	Power Rating	I/P: 100-240 Vac, 500mA, O/P: 5Vdc,2000mA		
Battery	Brand Name	Amperex (Motorola)	Model Name	JE30
	Power Rating	3.8Vdc,2000/2120mAh	Type	Li-ion, ATL355763
Earphone 1	Brand Name	Motorola(JuWei)	Model Name	711411000731
	Signal Line Type	1.2 meter, non-shielded cable, without ferrite core		
Earphone 2	Brand Name	Motorola(New leader)	Model Name	711411000711
	Signal Line Type	1.2 meter, non-shielded cable, without ferrite core		
Earphone 3	Brand Name	Motorola(Lianyun)	Model Name	TS910A-38AMS01WHR-M
	Signal Line Type	1.2 meter, non-shielded cable, without ferrite core		
Earphone 4	Brand Name	Motorola	Model Name	LS118
	Signal Line Type	1.2 meter, non-shielded cable, without ferrite core		
USB Cable 1	Brand Name	Motorola (SAIBAO)	Model Name	711310002261
	Signal Line Type	1.0 meter, shielded cable, without ferrite core		
USB Cable 2	Brand Name	Motorola (I-SHENG)	Model Name	SKN6471A
	Signal Line Type	1.0 meter, shielded cable, without ferrite core		



### 1.7. Maximum ERP/EIRP Power, Frequency Tolerance, and Emission Designator

LTE Band 2		QPSK			16QAM		
BW (MHz)	Frequency Range (MHz)	Emission Designator (99%OBW)	Frequency Tolerance (ppm)	Maximum EIRP(W)	Emission Designator (99%OBW)	Frequency Tolerance (ppm)	Maximum EIRP(W)
1.4	1850.7 ~ 1909.3	1M10G7D	-	0.0910	1M10W7D	-	0.0733
3	1851.5 ~ 1908.5	2M72G7D	-	0.0885	2M72W7D	-	0.0659
5	1852.5 ~ 1907.5	4M50G7D	-	0.0899	4M49W7D	-	0.0655
10	1855.0 ~ 1905.0	9M05G7D	0.0027	0.0912	8M99W7D	-	0.0667
15	1857.5 ~ 1902.5	13M4G7D	-	0.0916	13M5W7D	-	0.0664
20	1860.0 ~ 1900.0	18M4G7D	-	0.0918	18M3W7D	-	0.0671
LTE Band 4		QPSK			16QAM		
BW (MHz)	Frequency Range (MHz)	Emission Designator (99%OBW)	Frequency Tolerance (ppm)	Maximum EIRP(W)	Emission Designator (99%OBW)	Frequency Tolerance (ppm)	Maximum EIRP(W)
1.4	1710.7 ~ 1754.3	1M10G7D	-	0.1153	1M10W7D	-	0.0889
3	1711.5 ~ 1753.5	2M73G7D	-	0.1084	2M73W7D	-	0.0800
5	1712.5 ~ 1752.5	4M49G7D	-	0.1125	4M50W7D	-	0.0824
10	1715.0 ~ 1750.0	9M03G7D	0.0031	0.1143	9M01W7D	-	0.0841
15	1717.5 ~ 1747.5	13M6G7D	-	0.1146	13M5W7D	-	0.0826
20	1720.0 ~ 1745.0	18M3G7D	-	0.1159	18M4W7D	-	0.0804
LTE Band 5		QPSK			16QAM		
BW (MHz)	Frequency Range (MHz)	Emission Designator (99%OBW)	Frequency Tolerance (ppm)	Maximum ERP(W)	Emission Designator (99%OBW)	Frequency Tolerance (ppm)	Maximum ERP(W)
1.4	824.7 ~ 848.3	1M10G7D	-	0.0387	1M10W7D	-	0.0303
3	825.5 ~ 847.5	2M73G7D	-	0.0364	2M73W7D	-	0.0272
5	826.5 ~ 846.5	4M52G7D	-	0.0375	4M50W7D	-	0.0274
10	829.0 ~ 844.0	9M01G7D	0.0060	0.0395	9M01W7D	-	0.0279





LTE Band 7		QPSK			16QAM		
BW (MHz)	Frequency Range (MHz)	Emission Designator (99%OBW)	Frequency Tolerance (ppm)	Maximum EIRP(W)	Emission Designator (99%OBW)	Frequency Tolerance (ppm)	Maximum EIRP(W)
5	2502.5 ~ 2567.5	4M51G7D	-	0.1514	4M49W7D	-	0.1059
10	2505.0 ~ 2565.0	9M05G7D	0.0027	0.1503	9M03W7D	-	0.1079
15	2507.5 ~ 2562.5	13M5G7D	-	0.1510	13M5W7D	-	0.1059
20	2510.0 ~ 2560.0	18M4G7D	-	0.1524	18M4W7D	-	0.1062



### 1.8. Testing Location

Sporton International (Kunshan) Inc. is accredited to ISO 17025 by National Voluntary Laboratory Accreditation Program (NVLAP code: 600155-0) and the FCC designation No. is CN5013.

<b>Test Site</b>	Sporton International (Kunshan) Inc.		
<b>Test Site Location</b>	No.3-2 Ping-Xiang Rd, Kunshan Development Zone Kunshan City Jiangsu Province 215335 China TEL : +86-512-57900158 FAX : +86-512-57900958		
<b>Test Site No.</b>	<b>Sporton Site No.</b>		<b>FCC Test Firm Registration No.</b>
	TH01-KS	03CH03-KS	630927

**Note:** The test site complies with ANSI C63.4 2014 requirement.

### 1.9. Applicable Standards

According to the specifications of the manufacturer, the EUT must comply with the requirements of the following standards:

- ♦ 47 CFR Part 2, 22(H), 24(E), 27(L), 27(M)
- ♦ ANSI C63.26-2015
- ♦ FCC KDB 971168 D01 Power Meas License Digital Systems v03r01
- ♦ FCC KDB 412172 D01 Determining ERP and EIRP v01r01

**Remark:**

1. All test items were verified and recorded according to the standards and without any deviation during the test.
2. This EUT has also been tested and complied with the requirements of FCC Part 15, Subpart B, recorded in a separate test report.



## 2 Test Configuration of Equipment Under Test

### 2.1. Test Mode

Antenna port conducted and radiated test items listed below are performed according to KDB 971168 D01 Power Meas License Digital Systems v03r01 with maximum output power.

Radiated measurements are performed by rotating the EUT in three different orthogonal test planes to find the maximum emission.

Test Items	Band	Bandwidth (MHz)						Modulation			RB #			Test Channel		
		1.4	3	5	10	15	20	QPSK	16QAM	64QAM	1	Half	Full	L	M	H
Max. Output Power	2	v	v	v	v	v	v	v	v	-	v	v	v	v	v	v
	4	v	v	v	v	v	v	v	v	-	v	v	v	v	v	v
	5	v	v	v	v	-	-	v	v	-	v	v	v	v	v	v
	7	-	-	v	v	v	v	v	v	-	v	v	v	v	v	v
Peak-to-Average Ratio	2						v	v	v	-	v		v	v	v	v
	4						v	v	v	-	v		v	v	v	v
	5				v	-	-	v	v	-	v		v	v	v	v
	7	-	-				v	v	v	-	v		v	v	v	v
26dB and 99% Bandwidth	2	v	v	v	v	v	v	v	v	-			v	v	v	v
	4	v	v	v	v	v	v	v	v	-			v	v	v	v
	5	v	v	v	v	-	-	v	v	-			v	v	v	v
	7	-	-	v	v	v	v	v	v	-			v	v	v	v
Conducted Band Edge	2	v	v	v	v	v	v	v	v	-	v		v	v		v
	4	v	v	v	v	v	v	v	v	-	v		v	v		v
	5	v	v	v	v	-	-	v	v	-	v		v	v		v
	7	-	-	v	v	v	v	v	v	-	v		v	v		v



Test Items	Band	Bandwidth (MHz)						Modulation			RB #			Test Channel		
		1.4	3	5	10	15	20	QPSK	16QAM	64QAM	1	Half	Full	L	M	H
Conducted Spurious Emission	2	v	v	v	v	v	v	v	v	-	v			v	v	v
	4	v	v	v	v	v	v	v	v	-	v			v	v	v
	5	v	v	v	v	-	-	v	v	-	v			v	v	v
	7	-	-	v	v	v	v	v	v	-	v			v	v	v
Frequency Stability	2				v			v		-			v		v	
	4				v			v		-			v		v	
	5				v	-	-	v		-			v		v	
	7	-	-		v			v		-			v		v	
E.R.P / E.I.R.P	2	v	v	v	v	v	v	v	v	-	v			v	v	v
	4	v	v	v	v	v	v	v	v	-	v			v	v	v
	5	v	v	v	v	-	-	v	v	-	v			v	v	v
	7	-	-	v	v	v	v	v	v	-	v			v	v	v
Radiated Spurious Emission	2	Worst Case												v		
	4	Worst Case												v		
	5	Worst Case												v		
	7	Worst Case												v		
Note	1. The mark "v" means that this configuration is chosen for testing 2. The mark "-" means that this bandwidth is not supported. 3. The device is investigated from 30MHz to 10 times of fundamental signal for radiated spurious emission test under different RB size/offset and modulations in exploratory test. Subsequently, only the worst case emissions are reported.															

## 2.2. Connection Diagram of Test System

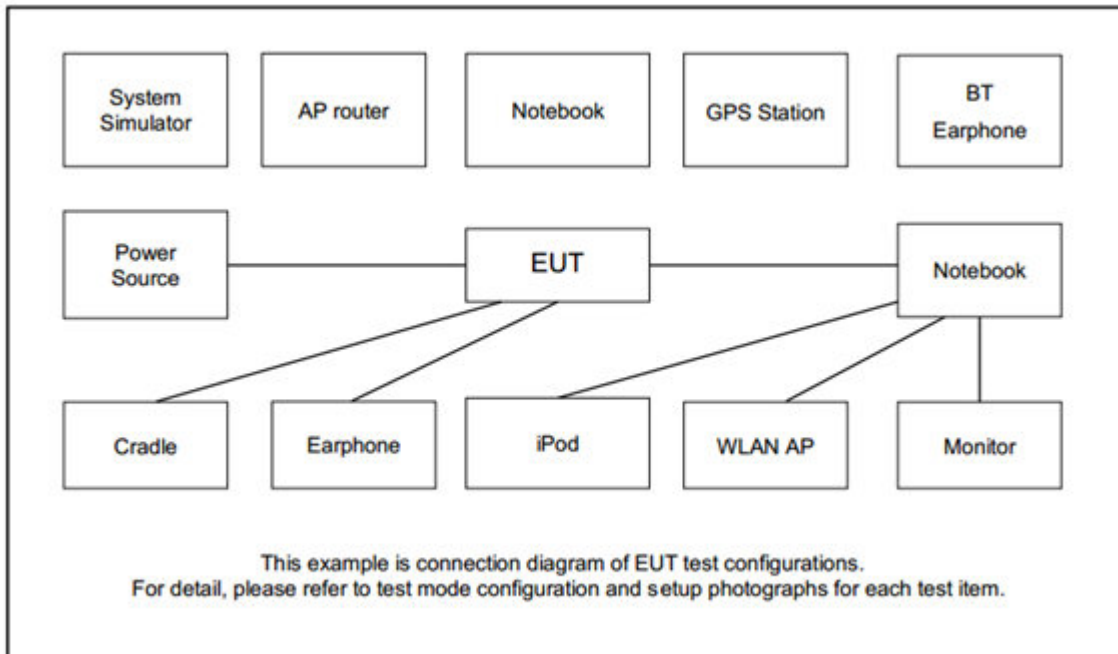

## 2.3. Support Unit used in test configuration and system

Item	Equipment	Trade Name	Model No.	FCC ID	Data Cable	Power Cord
1.	LTE Base Station	Anritsu	MT8820C	N/A	N/A	Unshielded, 1.8 m
2.	DC Power Supply	GW	GPS-3030D	N/A	N/A	Unshielded, 1.8 m

## 2.4. Measurement Results Explanation Example

### For all conducted test items:

The offset level is set in the spectrum analyzer to compensate the RF cable loss between EUT conducted output port and spectrum analyzer. With the offset compensation, the spectrum analyzer reading level is exactly the EUT RF output level.

The spectrum analyzer offset is derived from RF cable loss.

*Offset = RF cable loss.*

Following shows an offset computation example with cable loss 4.8 dB.

Example :

*Offset(dB) = RF cable loss(dB).*

= 4.8 (dB)



### 2.5. Frequency List of Low/Middle/High Channels

LTE Band 2 Channel and Frequency List				
BW [MHz]	Channel/Frequency(MHz)	Lowest	Middle	Highest
20	Channel	18700	18900	19100
	Frequency	1860	1880	1900
15	Channel	18675	18900	19125
	Frequency	1857.5	1880	1902.5
10	Channel	18650	18900	19150
	Frequency	1855	1880	1905
5	Channel	18625	18900	19175
	Frequency	1852.5	1880	1907.5
3	Channel	18615	18900	19185
	Frequency	1851.5	1880	1908.5
1.4	Channel	18607	18900	19193
	Frequency	1850.7	1880	1909.3

LTE Band 4 Channel and Frequency List				
BW [MHz]	Channel/Frequency(MHz)	Lowest	Middle	Highest
20	Channel	20050	20175	20300
	Frequency	1720	1732.5	1745
15	Channel	20025	20175	20325
	Frequency	1717.5	1732.5	1747.5
10	Channel	20000	20175	20350
	Frequency	1715	1732.5	1750
5	Channel	19975	20175	20375
	Frequency	1712.5	1732.5	1752.5
3	Channel	19965	20175	20385
	Frequency	1711.5	1732.5	1753.5
1.4	Channel	19957	20175	20393
	Frequency	1710.7	1732.5	1754.3



LTE Band 5 Channel and Frequency List				
BW [MHz]	Channel/Frequency(MHz)	Lowest	Middle	Highest
10	Channel	20450	20525	20600
	Frequency	829	836.5	844
5	Channel	20425	20525	20625
	Frequency	826.5	836.5	846.5
3	Channel	20415	20525	20635
	Frequency	825.5	836.5	847.5
1.4	Channel	20407	20525	20643
	Frequency	824.7	836.5	848.3

LTE Band 7 Channel and Frequency List				
BW [MHz]	Channel/Frequency(MHz)	Lowest	Middle	Highest
20	Channel	20850	21100	21350
	Frequency	2510	2535	2560
15	Channel	20825	21100	21375
	Frequency	2507.5	2535	2562.5
10	Channel	20800	21100	21400
	Frequency	2505	2535	2565
5	Channel	20775	21100	21425
	Frequency	2502.5	2535	2567.5

### 3 Conducted Test Items

#### 3.1. Measuring Instruments

See list of measuring instruments of this test report.

#### 3.2. Test Setup

##### 3.1.1 Conducted Output Power



##### 3.1.2 Peak-to-Average Ratio, Occupied Bandwidth ,Conducted Band-Edge and Conducted Spurious Emission

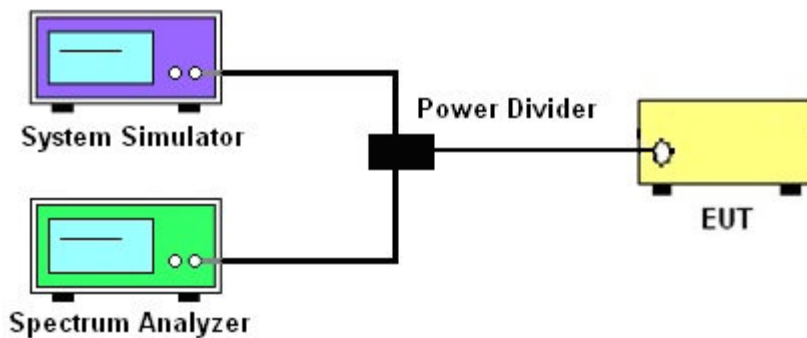

##### 3.1.3 Frequency Stability



### 3.3. Test Result of Conducted Test

Please refer to Appendix A.





### 3.4. Conducted Output Power and ERP/EIRP

#### 3.1.4 Description of the Conducted Output Power Measurement and ERP/EIRP Measurement

A system simulator was used to establish communication with the EUT. Its parameters were set to force the EUT transmitting at maximum output power. The measured power in the radio frequency on the transmitter output terminals shall be reported.

The ERP of mobile transmitters must not exceed 7 Watts for LTE Band 5.

The EIRP of mobile transmitters must not exceed 2 Watts for LTE Band 2 and Band 7.

The EIRP of mobile transmitters must not exceed 1 Watts for LTE Band 4.

According to KDB 412172 D01 Power Approach,

$EIRP = P_T + G_T - L_C$ ,  $ERP = EIRP - 2.15$ , where

$P_T$  = transmitter output power in dBm

$G_T$  = gain of the transmitting antenna in dBi

$L_C$  = signal attenuation in the connecting cable between the transmitter and antenna in dB

#### 3.1.5 Test Procedures

1. The testing follows ANSI C63.26 Section 5.2
2. The transmitter output port was connected to the system simulator.
3. Set EUT at maximum power through the system simulator.
4. Select lowest, middle, and highest channels for each band and different modulation.
5. Measure and record the power level from the system simulator.



## **3.5. Peak-to-Average Ratio**

### **3.1.6 Description of the PAR Measurement**

Power Complementary Cumulative Distribution Function (CCDF) curves provide a means for characterizing the power peaks of a digitally modulated signal on a statistical basis. A CCDF curve depicts the probability of the peak signal amplitude exceeding the average power level. Most contemporary measurement instrumentation include the capability to produce CCDF curves for an input signal provided that the instrument's resolution bandwidth can be set wide enough to accommodate the entire input signal bandwidth. In measuring transmissions in this band using an average power technique, the peak-to-average ratio (PAR) of the transmission may not exceed 13 dB.

### **3.1.7 Test Procedures**

1. The testing follows ANSI C63.26 Section 5.2.3.4 (CCDF).
2. The EUT was connected to spectrum and system simulator via a power divider.
3. Set the CCDF (Complementary Cumulative Distribution Function) option in spectrum analyzer.
4. The highest RF powers were measured and recorded the maximum PAPR level associated with a probability of 0.1 %.
5. Record the deviation as Peak to Average Ratio.



### 3.6. Occupied Bandwidth

#### 3.1.8 Description of Occupied Bandwidth Measurement

The occupied bandwidth is the width of a frequency band such that, below the lower and above the upper frequency limits, the mean powers emitted are each equal to a specified percentage 0.5% of the total mean transmitted power.

The 26 dB emission bandwidth is defined as the frequency range between two points, one above and one below the carrier frequency, at which the spectral density of the emission is attenuated 26 dB below the maximum in-band spectral density of the modulated signal. Spectral density (power per unit bandwidth) is to be measured with a detector of resolution bandwidth equal to approximately 1.0% of the emission bandwidth.

#### 3.1.9 Test Procedures

1. The testing follows ANSI C63.26 Section 5.4
2. The EUT was connected to spectrum analyzer and system simulator via a power divider.
3. The spectrum analyzer center frequency is set to the nominal EUT channel center frequency. The span range for the spectrum analyzer shall be between two and five times the anticipated OBW.
4. The nominal resolution bandwidth (RBW) shall be in the range of 1 to 5 % of the anticipated OBW, and the VBW shall be at least 3 times the RBW.
5. Set the detection mode to peak, and the trace mode to max hold.
6. Determine the reference value: Set the EUT to transmit a modulated signal. Allow the trace to stabilize. Set the spectrum analyzer marker to the highest level of the displayed trace.  
(this is the reference value)
7. Determine the “-26 dB down amplitude” as equal to (Reference Value – X).
8. Place two markers, one at the lowest and the other at the highest frequency of the envelope of the spectral display such that each marker is at or slightly below the “-X dB down amplitude” determined in step 6. If a marker is below this “-X dB down amplitude” value it shall be placed as close as possible to this value. The OBW is the positive frequency difference between the two markers.
9. Use the 99 % power bandwidth function of the spectrum analyzer and report the measured bandwidth.



### 3.7. Conducted Band Edge

#### 3.1.10 Description of Conducted Band Edge Measurement

22.917(a)

For operations in the 824 – 849 MHz band, the FCC limit is  $43 + 10\log_{10}(P[\text{Watts}])$  dB below the transmitter power P(Watts) in a 100kHz bandwidth. However, in the 1MHz bands immediately outside and adjacent to the licensee's frequency block, a resolution bandwidth of at least one percent of the emission bandwidth of the fundamental emission of the transmitter may be employed.

24.238 (a)

For operations in the 1850-1910 and 1930-1990 MHz band, the FCC limit is  $43 + 10\log_{10}(P[\text{Watts}])$  dB below the transmitter power P(Watts) in a 1MHz bandwidth. However, in the 1 MHz bands immediately outside and adjacent to the frequency block a resolution bandwidth of at least one percent of the emission bandwidth of the fundamental emission of the transmitter may be employed.

27.53 (h)

For operations in the 1710 – 1755 MHz band, the FCC limit is  $43 + 10\log_{10}(P[\text{Watts}])$  dB below the transmitter power P(Watts) in a 1 MHz bandwidth. However, in the 1MHz bands immediately outside and adjacent to the licensee's frequency block, a resolution bandwidth of at least one percent of the emission bandwidth of the fundamental emission of the transmitter may be employed.

27.53(m)(4)

For mobile digital stations, the attenuation factor shall be not less than  $40 + 10 \log (P)$  dB on all frequencies between the channel edge and 5 megahertz from the channel edge,  $43 + 10 \log (P)$  dB on all frequencies between 5 megahertz and X megahertz from the channel edge, and  $55 + 10 \log (P)$  dB on all frequencies more than X megahertz from the channel edge, where X is the greater of 6 megahertz or the actual emission bandwidth as defined in paragraph (m)(6) of this section. In addition, the attenuation factor shall not be less that  $43 + 10 \log (P)$  dB on all frequencies between 2490.5 MHz and 2496 MHz and  $55 + 10 \log (P)$  dB at or below 2490.5 MHz. Mobile Satellite Service licensees operating on frequencies below 2495 MHz may also submit a documented interference complaint against BRS licensees operating on channel BRS Channel 1 on the same terms and conditions as adjacent channel BRS or EBS licensees.



### 3.1.11 Test Procedures

1. The testing follows ANSI C63.26 section 5.7
2. The EUT was connected to spectrum analyzer and system simulator via a power divider.
3. The band edges of low and high channels for the highest RF powers were measured.
4. Set RBW  $\geq$  1% EBW in the 1MHz band immediately outside and adjacent to the band edge.
5. Beyond the 1 MHz band from the band edge, RBW=1MHz was used
6. Set spectrum analyzer with RMS detector.
7. The RF fundamental frequency should be excluded against the limit line in the operating frequency band.
8. Offset has included the duty factor for LTE Band 38. Duty factor =  $10 \log (1/x)$ , where x is the measured duty cycle
9. Checked that all the results comply with the emission limit line.

Example:

The limit line is derived from  $43 + 10\log(P)$ dB below the transmitter power P(Watts)

$$= P(W) - [43 + 10\log(P)] \text{ (dB)}$$

$$= [30 + 10\log(P)] \text{ (dBm)} - [43 + 10\log(P)] \text{ (dB)} = -13\text{dBm.}$$

10. For LTE Band 7 the other 40 dB, and 55 dB have additionally applied same calculation above.



### 3.8. Conducted Spurious Emission

#### 3.1.12 Description of Conducted Spurious Emission Measurement

The power of any emission outside of the authorized operating frequency ranges must be lower than the transmitter power (P) by a factor of at least  $43 + 10 \log (P)$  dB.

For Band 7:

The power of any emission outside of the authorized operating frequency ranges must be lower than the transmitter power (P) by a factor of at least  $55 + 10 \log (P)$  dB.

It is measured by means of a calibrated spectrum analyzer and scanned from 30 MHz up to a frequency including its 10<sup>th</sup> harmonic.

#### 3.1.13 Test Procedures

1. The testing follows ANSI C63.26 section 5.7
2. The EUT was connected to spectrum analyzer and system simulator via a power divider.
3. The RF output of EUT was connected to the spectrum analyzer by RF cable and attenuator. The path loss was compensated to the results for each measurement.
4. The middle channel for the highest RF power within the transmitting frequency was measured.
5. The conducted spurious emission for the whole frequency range was taken.
6. Make the measurement with the spectrum analyzer's RBW = 1MHz, VBW = 3MHz.
7. Set spectrum analyzer with RMS detector.
8. Taking the record of maximum spurious emission.
9. The RF fundamental frequency should be excluded against the limit line in the operating frequency band.
10. The limit line is derived from  $43 + 10\log(P)$ dB below the transmitter power P(Watts)  
 $= P(W) - [43 + 10\log(P)]$  (dB)  
 $= [30 + 10\log(P)]$  (dBm) -  $[43 + 10\log(P)]$  (dB)  
 $= -13$ dBm.
11. For Band 7  
The limit line is derived from  $55 + 10\log(P)$ dB below the transmitter power P(Watts)  
 $= P(W) - [55 + 10\log(P)]$  (dB)  
 $= [30 + 10\log(P)]$  (dBm) -  $[55 + 10\log(P)]$  (dB)  
 $= -25$ dBm.



## 3.9. Frequency Stability

### 3.1.14 Description of Frequency Stability Measurement

The frequency stability shall be measured by variation of ambient temperature and variation of primary supply voltage to ensure that the fundamental emission stays within the authorized frequency block. The frequency stability of the transmitter shall be maintained within  $\pm 0.00025\%$  ( $\pm 2.5\text{ppm}$ ) of the center frequency.

### 3.1.15 Test Procedures for Temperature Variation

1. The testing follows ANSI C63.26 section 5.6.4
2. The EUT was set up in the thermal chamber and connected with the system simulator.
3. With power OFF, the temperature was decreased to  $-30^{\circ}\text{C}$  and the EUT was stabilized before testing. Power was applied and the maximum change in frequency was recorded within one minute.
4. With power OFF, the temperature was raised in  $10^{\circ}\text{C}$  step up to  $50^{\circ}\text{C}$ . The EUT was stabilized at each step for at least half an hour. Power was applied and the maximum frequency change was recorded within one minute.

### 3.1.16 Test Procedures for Voltage Variation

1. The testing follows ANSI C63.26 section 5.6.5
2. The EUT was placed in a temperature chamber at  $20\pm 5^{\circ}\text{C}$  and connected with the system simulator.
3. The power supply voltage to the EUT was varied from 85% to 115% of the nominal value for other than hand carried battery equipment.
4. For hand carried, battery powered equipment, reduce the primary ac or dc supply voltage to the battery operating end point, which shall be specified by the manufacturer.
5. The variation in frequency was measured for the worst case.

## 4 Radiated Test Items

### 4.1. Measuring Instruments

See list of measuring instruments of this test report.

### 4.2. Test Setup

#### 4.1.1 For radiated test from 30MHz to 1GHz

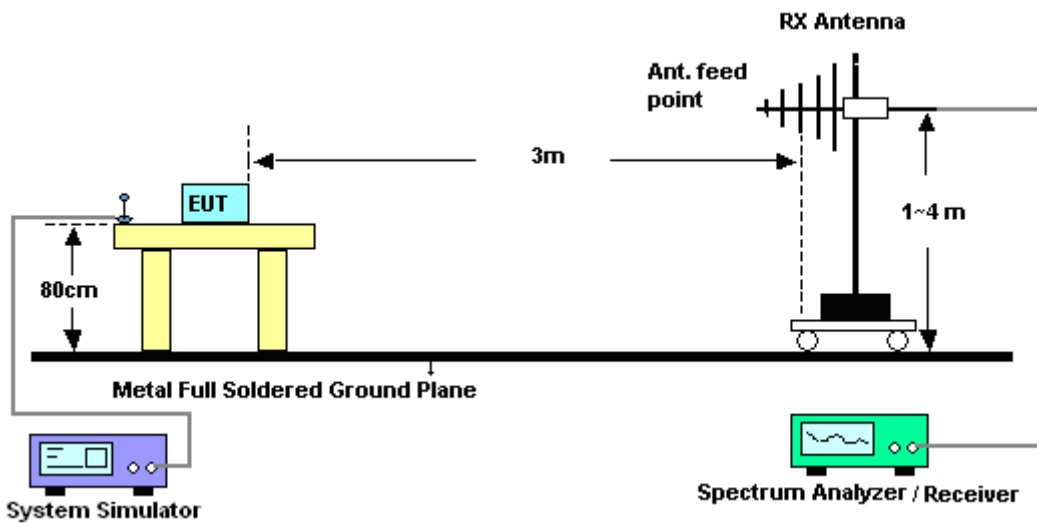

#### 4.1.2 For radiated test above 1GHz

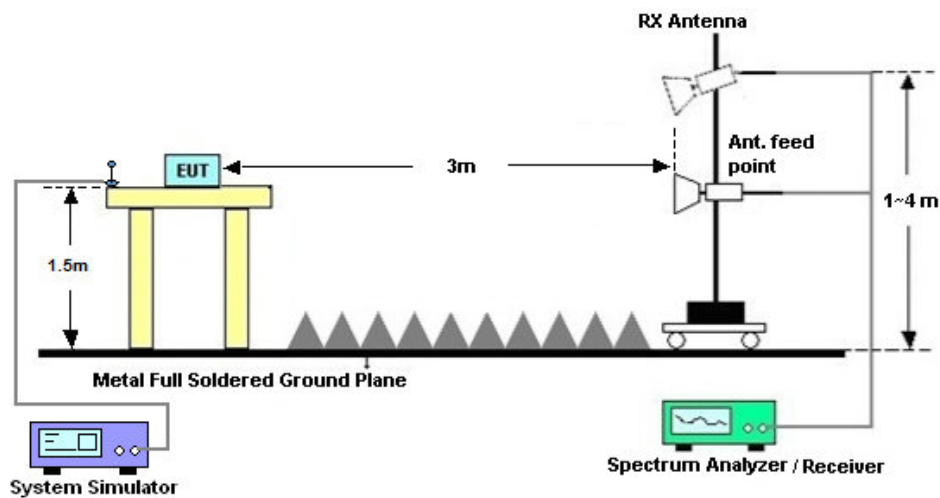

### 4.3. Test Result of Radiated Test

Please refer to Appendix B.





## 4.4. Radiated Spurious Emission

### 4.1.3 Description of Radiated Spurious Emission

The radiated spurious emission was measured by substitution method according to ANSI C63.26. The power of any emission outside of the authorized operating frequency ranges must be attenuated below the transmitter power (P) by a factor of at least  $43 + 10 \log (P)$  dB.

For Band 7

The power of any emission outside of the authorized operating frequency ranges must be attenuated below the transmitter power (P) by a factor of at least  $55 + 10 \log (P)$  dB.

The spectrum is scanned from 30 MHz up to a frequency including its 10th harmonic.

### 4.1.4 Test Procedures

1. The testing follows ANSI C63.26 Section 5.5
2. The EUT was placed on a turntable with 0.8 meter height for frequency below 1GHz and 1.5 meter height for frequency above 1GHz respectively above ground.
3. The EUT was set 3 meters from the receiving antenna mounted on the antenna tower.
4. The table was rotated 360 degrees to determine the position of the highest spurious emission.
5. The height of the receiving antenna is varied between 1m to 4m to search the maximum spurious emission for both horizontal and vertical polarizations.
6. During the measurement, the system simulator parameters were set to force the EUT transmitting at maximum output power.
7. Make the measurement with the spectrum analyzer's RBW = 1MHz, VBW = 3MHz, taking the record of maximum spurious emission.
8. A horn antenna was substituted in place of the EUT and was driven by a signal generator.
9. Tune the output power of signal generator to the same emission level with EUT maximum spurious emission.
10.  $EIRP (dBm) = S.G. Power - Tx Cable Loss + Tx Antenna Gain$
11.  $ERP (dBm) = EIRP - 2.15$
12. The RF fundamental frequency should be excluded against the limit line in the operating frequency band.

The limit line is derived from  $43 + 10\log(P)$ dB below the transmitter power P(Watts)  
 $= P(W) - [43 + 10\log(P)] (dB)$   
 $= [30 + 10\log(P)] (dBm) - [43 + 10\log(P)] (dB)$   
 $= -13dBm.$

13. For Band 7:

The limit line is derived from  $55 + 10\log(P)$ dB below the transmitter power P(Watts)



## 5 List of Measuring Equipment

Instrument	Manufacturer	Model No.	Serial No.	Characteristics	Calibration Date	Test Date	Due Date	Remark
Spectrum Analyzer	R&S	FSV40	101040	10Hz~40GHz	Aug. 08, 2017	Apr. 24, 2018~ Apr. 25, 2018	Aug. 07, 2018	Conducted (TH01-KS)
Radio communication	Anritsu	MT8820C	6201300652	2G/3G/LTE_ full band	Aug. 08, 2017	Apr. 24, 2018~ Apr. 25, 2018	Aug. 07, 2018	Conducted (TH01-KS)
Thermal Chamber	Hongzhan	LP-150U	HZ014011440	-40~+150°C 20%~95%RH	Apr. 17, 2018	Apr. 24, 2018~ Apr. 25, 2018	Apr. 16, 2019	Conducted (TH01-KS)
EXA Spectrum Analyzer	Keysight	N9010A	MY55150244	10Hz-44GHz	Apr. 17, 2018	May 04, 2018	Apr.16, 2019	Radiation (03CH03-KS)
Bilog Antenna	TeseQ	CBL6112D	47610	30MHz-1GHz	Sep. 12, 2017	May 04, 2018	Sep. 11, 2018	Radiation (03CH03-KS)
Double Ridge Horn Antenna	ETS-Lindgren	3117	75959	1GHz~18GHz	Jan. 21, 2018	May 04, 2018	Jan. 20, 2019	Radiation (03CH03-KS)
SHF-EHF Horn	Schwarzbeck	BBHA 9170	BBHA170249	15GHz~40GHz	Feb. 07, 2018	May 04, 2018	Feb. 06, 2019	Radiation (03CH03-KS)
Amplifier	com-power	PA-103A	161069	1MHz ~1000MHz / 32 dB	Apr 17, 2018	May 04, 2018	Apr 16, 2019	Radiation (03CH03-KS)
Amplifier	MITEQ	TTA1840-35 -HG	1887435	18~40GHz	Oct. 12, 2017	May 04, 2018	Oct. 11, 2018	Radiation (03CH03-KS)
high gain Amplifier	MITEQ	AMF-7D-00 101800-30-1	2025788	1Ghz-18Ghz	Apr.17, 2018	May 04, 2018	Apr.16, 2019	Radiation (03CH03-KS)
Amplifier	Agilent	8449B	3008A02370	1GHz~26.5GHz	Oct. 12, 2017	May 04, 2018	Oct. 11, 2018	Radiation (03CH03-KS)
AC Power Source	Chroma	61601	F104090004	N/A	NCR	May 04, 2018	NCR	Radiation (03CH03-KS)
Turn Table	ChamPro	EM 1000-T	060762-T	0~360 degree	NCR	May 04, 2018	NCR	Radiation (03CH03-KS)
Antenna Mast	ChamPro	EM 1000-A	060762-A	1 m~4 m	NCR	May 04, 2018	NCR	Radiation (03CH03-KS)

NCR: No Calibration Required



## 6 Uncertainty of Evaluation

### Uncertainty of Radiated Emission Measurement (30 MHz ~ 1000 MHz)

Measuring Uncertainty for a Level of Confidence of 95% ( $U = 2Uc(y)$ )	3.3 dB
---	--------

### Uncertainty of Radiated Emission Measurement (1000 MHz ~ 18000 MHz)

Measuring Uncertainty for a Level of Confidence of 95% ( $U = 2Uc(y)$ )	2.8 dB
---	--------

### Uncertainty of Radiated Emission Measurement (18000 MHz ~ 40000 MHz)

Measuring Uncertainty for a Level of Confidence of 95% ( $U = 2Uc(y)$ )	3.0 dB
---	--------



### Appendix A. Test Results of Conducted Test

#### Conducted Output Power(Average power)

LTE Band 2 Maximum Average Power [dBm]						
BW [MHz]	RB Size	RB Offset	Mod	Lowest	Middle	Highest
20	1	0	QPSK	23.01	22.96	23.09
20	1	49		23.10	23.19	23.23
20	1	99		23.00	22.87	22.95
20	50	0		22.14	22.11	22.11
20	50	24		22.04	21.97	22.15
20	50	50		22.02	22.01	21.95
20	100	0		22.13	21.96	22.15
20	1	0	16-QAM	21.68	21.54	21.74
20	1	49		21.87	21.67	21.82
20	1	99		21.71	21.49	21.52
20	50	0		20.95	20.88	20.98
20	50	24		21.11	20.86	21.06
20	50	50		21.09	20.96	21.03
20	100	0		21.01	20.92	20.99
15	1	0	QPSK	23.16	23.00	23.03
15	1	37		23.10	22.90	23.22
15	1	74		23.10	23.02	22.92
15	36	0		22.21	22.05	22.11
15	36	20		22.05	22.00	22.03
15	36	39		22.06	21.94	21.97
15	75	0		22.13	22.00	22.13
15	1	0	16-QAM	21.68	21.82	21.68
15	1	37		21.75	21.71	21.81
15	1	74		21.59	21.46	21.64
15	36	0		21.08	20.98	20.98
15	36	20		21.09	20.98	21.12
15	36	39		21.03	20.93	20.87
15	75	0		21.07	21.06	20.97



LTE Band 2 Maximum Average Power [dBm]						
BW [MHz]	RB Size	RB Offset	Mod	Lowest	Middle	Highest
10	1	0	QPSK	23.06	22.72	22.99
10	1	25		23.00	22.82	23.20
10	1	49		23.12	22.86	23.03
10	25	0		22.14	21.97	22.08
10	25	12		22.12	22.00	22.10
10	25	25		22.05	22.08	21.99
10	50	0		22.12	22.06	22.07
10	1	0	16-QAM	21.69	21.58	21.68
10	1	25		21.74	21.69	21.70
10	1	49		21.84	21.54	21.56
10	25	0		21.08	20.95	21.14
10	25	12		21.02	20.98	21.05
10	25	25		21.04	20.84	20.89
10	50	0		21.10	20.95	21.07
5	1	0	QPSK	22.95	22.86	22.65
5	1	12		23.07	23.11	23.14
5	1	24		22.99	22.93	22.91
5	12	0		22.09	21.99	22.05
5	12	7		22.22	21.98	21.99
5	12	13		22.08	21.90	21.94
5	25	0		22.12	21.94	21.94
5	1	0	16-QAM	21.53	21.40	21.50
5	1	12		21.75	21.62	21.76
5	1	24		21.51	21.68	21.45
5	12	0		20.91	20.79	20.87
5	12	7		21.12	20.78	20.92
5	12	13		21.08	20.79	20.80
5	25	0		21.07	20.83	20.89



LTE Band 2 Maximum Average Power [dBm]						
BW [MHz]	RB Size	RB Offset	Mod	Lowest	Middle	Highest
3	1	0	QPSK	23.07	22.86	22.87
3	1	8		22.95	22.87	22.85
3	1	14		22.91	22.95	22.94
3	8	0		22.15	21.97	22.11
3	8	4		22.15	21.98	21.98
3	8	7		22.10	21.94	21.99
3	15	0		22.11	21.95	21.94
3	1	0	16-QAM	21.60	21.54	21.54
3	1	8		21.57	21.49	21.79
3	1	14		21.71	21.56	21.71
3	8	0		21.12	21.01	21.05
3	8	4		21.10	21.02	20.97
3	8	7		21.09	20.97	21.01
3	15	0		21.09	21.05	21.05
1.4	1	0	QPSK	23.03	22.90	22.95
1.4	1	3		23.18	22.90	22.86
1.4	1	5		23.09	22.90	22.77
1.4	3	0		23.09	22.97	23.17
1.4	3	1		23.18	23.16	23.19
1.4	3	3		23.14	23.06	23.10
1.4	6	0		22.12	21.93	22.00
1.4	1	0	16-QAM	21.56	21.62	21.51
1.4	1	3		21.79	21.80	21.80
1.4	1	5		21.71	21.45	21.61
1.4	3	0		22.01	21.84	21.96
1.4	3	1		22.08	21.88	22.25
1.4	3	3		22.02	22.00	22.01
1.4	6	0		21.11	20.74	20.98



LTE Band 4 Maximum Average Power [dBm]						
BW [MHz]	RB Size	RB Offset	Mod	Lowest	Middle	Highest
20	1	0	QPSK	22.79	22.71	22.96
20	1	49		22.91	22.81	23.14
20	1	99		22.67	22.73	22.95
20	50	0		21.97	21.78	22.10
20	50	24		21.86	21.75	22.07
20	50	50		21.73	21.67	21.96
20	100	0		21.84	21.78	22.03
20	1	0	16-QAM	21.48	21.34	21.36
20	1	49		21.47	21.22	21.55
20	1	99		21.12	21.23	21.37
20	50	0		20.86	20.76	21.08
20	50	24		20.92	20.83	21.01
20	50	50		20.80	20.76	21.06
20	100	0		20.72	20.65	21.00
15	1	0	QPSK	22.97	22.79	23.03
15	1	37		22.84	22.70	23.09
15	1	74		22.83	22.81	22.77
15	36	0		21.99	21.79	22.05
15	36	20		21.91	21.77	21.98
15	36	39		21.87	21.61	22.00
15	75	0		21.85	21.79	22.08
15	1	0	16-QAM	21.52	21.35	21.43
15	1	37		21.64	21.36	21.67
15	1	74		21.59	21.35	21.36
15	36	0		20.85	20.74	21.03
15	36	20		20.89	20.59	20.89
15	36	39		20.86	20.60	21.00
15	75	0		20.92	20.75	21.08



LTE Band 4 Maximum Average Power [dBm]						
BW [MHz]	RB Size	RB Offset	Mod	Lowest	Middle	Highest
10	1	0	QPSK	22.80	22.77	22.90
10	1	25		23.04	22.82	23.08
10	1	49		22.70	22.64	22.96
10	25	0		22.00	21.79	22.04
10	25	12		21.97	21.75	22.08
10	25	25		21.87	21.69	21.97
10	50	0		21.99	21.74	21.99
10	1	0	16-QAM	21.63	21.47	21.75
10	1	25		21.65	21.67	21.60
10	1	49		21.37	21.27	21.43
10	25	0		21.07	20.68	20.99
10	25	12		20.86	20.92	21.06
10	25	25		21.04	20.69	20.84
10	50	0		20.96	20.71	21.03
5	1	0	QPSK	22.78	22.62	22.78
5	1	12		23.01	22.87	22.76
5	1	24		22.85	22.55	22.62
5	12	0		21.91	21.71	21.96
5	12	7		21.98	21.72	22.01
5	12	13		21.96	21.67	22.00
5	25	0		21.93	21.69	21.97
5	1	0	16-QAM	21.41	21.39	21.59
5	1	12		21.66	21.29	21.54
5	1	24		21.20	21.26	21.57
5	12	0		20.78	20.53	20.94
5	12	7		20.95	20.53	20.82
5	12	13		21.03	20.76	20.86
5	25	0		21.00	20.62	20.88





LTE Band 4 Maximum Average Power [dBm]						
BW [MHz]	RB Size	RB Offset	Mod	Lowest	Middle	Highest
3	1	0	QPSK	22.79	22.64	22.66
3	1	8		22.79	22.67	22.57
3	1	14		22.85	22.62	22.50
3	8	0		21.94	21.69	21.82
3	8	4		22.04	21.71	21.90
3	8	7		21.98	21.68	21.81
3	15	0		22.01	21.68	21.87
3	1	0	16-QAM	21.38	21.41	21.47
3	1	8		21.38	21.40	21.40
3	1	14		21.53	21.47	21.32
3	8	0		20.84	20.73	20.52
3	8	4		20.96	20.62	20.57
3	8	7		20.99	20.66	20.77
3	15	0		20.89	20.80	20.80
1.4	1	0	QPSK	22.90	22.65	22.77
1.4	1	3		22.99	22.76	22.82
1.4	1	5		22.83	22.60	22.74
1.4	3	0		22.91	22.62	22.84
1.4	3	1		23.12	22.66	22.88
1.4	3	3		22.98	22.62	22.85
1.4	6	0		21.90	21.66	21.91
1.4	1	0	16-QAM	21.38	21.33	21.35
1.4	1	3		21.59	21.40	21.58
1.4	1	5		21.30	21.46	21.68
1.4	3	0		21.84	21.63	21.74
1.4	3	1		21.92	21.65	21.99
1.4	3	3		21.79	21.60	21.84
1.4	6	0		20.86	20.37	20.75



LTE Band 5 Maximum Average Power [dBm]						
BW [MHz]	RB Size	RB Offset	Mod	Lowest	Middle	Highest
10	1	0	QPSK	22.96	22.94	22.89
10	1	25		23.26	23.14	23.15
10	1	49		22.92	22.81	22.86
10	25	0		22.12	22.07	21.95
10	25	12		22.18	22.08	21.99
10	25	25		22.13	21.98	21.96
10	50	0		22.08	22.03	21.92
10	1	0	16-QAM	21.74	21.41	21.66
10	1	25		21.70	21.53	21.61
10	1	49		21.40	21.36	21.36
10	25	0		21.09	21.04	20.93
10	25	12		21.05	21.01	21.15
10	25	25		20.88	20.95	20.94
10	50	0		21.08	20.99	20.99
5	1	0	QPSK	23.02	22.82	22.57
5	1	12		23.03	23.02	22.90
5	1	24		22.74	22.93	22.58
5	12	0		22.14	22.02	21.93
5	12	7		22.02	21.96	21.91
5	12	13		22.05	21.99	21.90
5	25	0		22.05	22.01	21.97
5	1	0	16-QAM	21.56	21.45	21.61
5	1	12		21.66	21.67	21.56
5	1	24		21.50	21.60	21.31
5	12	0		20.91	20.86	20.92
5	12	7		20.86	20.84	20.99
5	12	13		20.91	20.84	20.85
5	25	0		21.01	21.06	20.95



LTE Band 5 Maximum Average Power [dBm]						
BW [MHz]	RB Size	RB Offset	Mod	Lowest	Middle	Highest
3	1	0	QPSK	22.90	22.90	22.79
3	1	8		22.88	22.89	22.74
3	1	14		22.86	22.61	22.56
3	8	0		22.15	22.03	22.02
3	8	4		22.05	22.07	21.98
3	8	7		22.00	22.02	21.88
3	15	0		22.11	22.02	21.95
3	1	0	16-QAM	21.63	21.45	21.33
3	1	8		21.45	21.57	21.41
3	1	14		21.44	21.50	21.53
3	8	0		21.17	21.00	20.96
3	8	4		21.23	21.06	20.95
3	8	7		21.21	21.15	20.85
3	15	0		21.25	20.99	20.94
1.4	1	0	QPSK	23.13	22.90	22.90
1.4	1	3		23.12	23.00	22.88
1.4	1	5		22.98	22.95	22.79
1.4	3	0		23.12	22.99	22.87
1.4	3	1		23.17	23.10	22.99
1.4	3	3		23.13	23.06	22.93
1.4	6	0		22.18	22.13	21.92
1.4	1	0	16-QAM	21.64	21.43	21.34
1.4	1	3		21.73	21.64	21.46
1.4	1	5		21.71	21.41	21.51
1.4	3	0		22.10	21.89	21.82
1.4	3	1		22.08	21.82	21.74
1.4	3	3		22.05	21.86	21.92
1.4	6	0		20.87	20.74	20.89



LTE Band 7 Maximum Average Power [dBm]						
BW [MHz]	RB Size	RB Offset	Mod	Lowest	Middle	Highest
20	1	0	QPSK	23.35	23.01	23.04
20	1	49		23.43	23.13	23.27
20	1	99		23.31	23.01	23.01
20	50	0		22.33	22.11	22.03
20	50	24		22.32	22.03	22.06
20	50	50		22.26	22.01	22.03
20	100	0		22.36	22.06	22.13
20	1	0	16-QAM	21.77	21.53	21.54
20	1	49		21.86	21.69	21.62
20	1	99		21.85	21.50	21.43
20	50	0		21.24	21.09	20.87
20	50	24		21.23	21.06	20.96
20	50	50		21.18	20.99	20.91
20	100	0		21.25	20.91	20.91
15	1	0	QPSK	23.12	22.95	22.99
15	1	37		23.33	23.09	23.12
15	1	74		23.39	22.98	23.12
15	36	0		22.38	22.08	22.00
15	36	20		22.41	22.04	22.11
15	36	39		22.34	22.12	22.09
15	75	0		22.29	22.02	22.05
15	1	0	16-QAM	21.71	21.60	21.47
15	1	37		21.85	21.65	21.65
15	1	74		21.74	21.45	21.58
15	36	0		21.30	20.96	20.96
15	36	20		21.23	20.97	20.91
15	36	39		21.34	20.96	20.99
15	75	0		21.28	21.00	21.01



LTE Band 7 Maximum Average Power [dBm]						
BW [MHz]	RB Size	RB Offset	Mod	Lowest	Middle	Highest
10	1	0	QPSK	23.35	23.01	22.96
10	1	25		23.37	23.16	23.23
10	1	49		23.04	22.93	23.02
10	25	0		22.40	22.03	21.98
10	25	12		22.43	22.11	22.02
10	25	25		22.39	22.08	22.07
10	50	0		22.35	22.06	22.09
10	1	0	16-QAM	21.92	21.68	21.54
10	1	25		21.93	21.50	21.60
10	1	49		21.85	21.49	21.54
10	25	0		21.32	21.02	20.93
10	25	12		21.27	21.11	21.20
10	25	25		21.32	21.11	21.16
10	50	0		21.33	20.92	21.05
5	1	0	QPSK	23.25	23.07	22.95
5	1	12		23.40	23.29	23.09
5	1	24		23.01	22.95	22.98
5	12	0		22.35	22.05	21.98
5	12	7		22.40	21.96	22.00
5	12	13		22.32	22.04	21.90
5	25	0		22.33	21.98	21.90
5	1	0	16-QAM	21.73	21.58	21.49
5	1	12		21.85	21.64	21.65
5	1	24		21.82	21.45	21.51
5	12	0		21.13	20.80	20.69
5	12	7		21.07	20.80	20.78
5	12	13		21.17	20.76	20.80
5	25	0		21.25	20.83	20.77



**ERP/EIRP**

LTE Band 2 (GT - LC = -3.60 dB) QPSK									
Bandwidth	1.4M			3M			5M		
Channel	18607	18900	19193	18615	18900	19185	18625	18900	19175
	(Low)	(Mid)	(High)	(Low)	(Mid)	(High)	(Low)	(Mid)	(High)
Frequency	1850.7	1880	1909.3	1851.5	1880	1908.5	1852.5	1880	1907.5
(MHz)									
Conducted Power (dBm)	23.18	23.16	23.19	23.07	22.86	22.87	23.07	23.11	23.14
Conducted Power (Watts)	0.2080	0.2070	0.2084	0.2028	0.1932	0.1936	0.2028	0.2046	0.2061
EIRP(dBm)	19.58	19.56	19.59	19.47	19.26	19.27	19.47	19.51	19.54
EIRP(Watts)	0.0908	0.0904	0.0910	0.0885	0.0843	0.0845	0.0885	0.0893	0.0899

LTE Band 2 (GT - LC = -3.60 dB) QPSK									
Bandwidth	10M			15M			20M		
Channel	18650	18900	19150	18675	18900	19125	18650	18900	19100
	(Low)	(Mid)	(High)	(Low)	(Mid)	(High)	(Low)	(Mid)	(High)
Frequency	1855	1880	1905	1857.5	1880	1902.5	1860	1880	1900
(MHz)									
Conducted Power (dBm)	23.00	22.82	23.20	23.10	22.90	23.22	23.10	23.19	23.23
Conducted Power (Watts)	0.1995	0.1914	0.2089	0.2042	0.1950	0.2099	0.2042	0.2084	0.2104
EIRP(dBm)	19.40	19.22	19.60	19.50	19.30	19.62	19.50	19.59	19.63
EIRP(Watts)	0.0871	0.0836	0.0912	0.0891	0.0851	0.0916	0.0891	0.0910	0.0918



LTE Band 2 (GT - LC = -3.60 dB) 16QAM									
Bandwidth	1.4M			3M			5M		
Channel	18607	18900	19193	18615	18900	19185	18625	18900	19175
	(Low)	(Mid)	(High)	(Low)	(Mid)	(High)	(Low)	(Mid)	(High)
Frequency (MHz)	1850.7	1880	1909.3	1851.5	1880	1908.5	1852.5	1880	1907.5
Conducted Power (dBm)	22.08	21.88	22.25	21.57	21.49	21.79	21.75	21.62	21.76
Conducted Power (Watts)	0.1614	0.1542	0.1679	0.1435	0.1409	0.1510	0.1496	0.1452	0.1500
EIRP(dBm)	18.48	18.28	18.65	17.97	17.89	18.19	18.15	18.02	18.16
EIRP(Watts)	0.0705	0.0673	0.0733	0.0627	0.0615	0.0659	0.0653	0.0634	0.0655

LTE Band 2 (GT - LC = -3.60 dB) 16QAM									
Bandwidth	10M			15M			20M		
Channel	18650	18900	19150	18675	18900	19125	18650	18900	19100
	(Low)	(Mid)	(High)	(Low)	(Mid)	(High)	(Low)	(Mid)	(High)
Frequency (MHz)	1855	1880	1905	1857.5	1880	1902.5	1860	1880	1900
Conducted Power (dBm)	21.84	21.54	21.56	21.68	21.82	21.68	21.87	21.67	21.82
Conducted Power (Watts)	0.1528	0.1426	0.1432	0.1472	0.1521	0.1472	0.1538	0.1469	0.1521
EIRP(dBm)	18.24	17.94	17.96	18.08	18.22	18.08	18.27	18.07	18.22
EIRP(Watts)	0.0667	0.0622	0.0625	0.0643	0.0664	0.0643	0.0671	0.0641	0.0664



LTE Band 4 (GT - LC = -2.50 dB) QPSK									
Bandwidth	1.4M			3M			5M		
Channel	19957	20175	20393	19965	20175	20385	19975	20175	20375
	(Low)	(Mid)	(High)	(Low)	(Mid)	(High)	(Low)	(Mid)	(High)
Frequency (MHz)	1710.7	1732.5	1754.3	1711.5	1732.5	1753.5	1712.5	1732.5	1752.5
Conducted Power (dBm)	23.12	22.66	22.88	22.85	22.62	22.50	23.01	22.87	22.76
Conducted Power (Watts)	0.2051	0.1845	0.1941	0.1928	0.1828	0.1778	0.2000	0.1936	0.1888
EIRP(dBm)	20.62	20.16	20.38	20.35	20.12	20.00	20.51	20.37	20.26
EIRP(Watts)	0.1153	0.1038	0.1091	0.1084	0.1028	0.1000	0.1125	0.1089	0.1062

LTE Band 4 (GT - LC = -2.50 dB) QPSK									
Bandwidth	10M			15M			20M		
Channel	20000	20175	20350	20025	20175	20325	20050	20175	20300
	(Low)	(Mid)	(High)	(Low)	(Mid)	(High)	(Low)	(Mid)	(High)
Frequency (MHz)	1715	1732.5	1750	1717.5	1732.5	1747.5	1720	1732.5	1745
Conducted Power (dBm)	23.04	22.82	23.08	22.84	22.70	23.09	22.91	22.81	23.14
Conducted Power (Watts)	0.2014	0.1914	0.2032	0.1923	0.1862	0.2037	0.1954	0.1910	0.2061
EIRP(dBm)	20.54	20.32	20.58	20.34	20.20	20.59	20.41	20.31	20.64
EIRP(Watts)	0.1132	0.1076	0.1143	0.1081	0.1047	0.1146	0.1099	0.1074	0.1159





LTE Band 4 (GT - LC = -2.50 dB) 16QAM									
Bandwidth	1.4M			3M			5M		
Channel	19957	20175	20393	19965	20175	20385	19975	20175	20375
	(Low)	(Mid)	(High)	(Low)	(Mid)	(High)	(Low)	(Mid)	(High)
Frequency (MHz)	1710.7	1732.5	1754.3	1711.5	1732.5	1753.5	1712.5	1732.5	1752.5
Conducted Power (dBm)	21.92	21.65	21.99	21.53	21.47	21.32	21.66	21.29	21.54
Conducted Power (Watts)	0.1556	0.1462	0.1581	0.1422	0.1403	0.1355	0.1466	0.1346	0.1426
EIRP(dBm)	19.42	19.15	19.49	19.03	18.97	18.82	19.16	18.79	19.04
EIRP(Watts)	0.0875	0.0822	0.0889	0.0800	0.0789	0.0762	0.0824	0.0757	0.0802

LTE Band 4 (GT - LC = -2.50 dB) 16QAM									
Bandwidth	10M			15M			20M		
Channel	20000	20175	20350	20025	20175	20325	20050	20175	20300
	(Low)	(Mid)	(High)	(Low)	(Mid)	(High)	(Low)	(Mid)	(High)
Frequency (MHz)	1715	1732.5	1750	1717.5	1732.5	1747.5	1720	1732.5	1745
Conducted Power (dBm)	21.63	21.47	21.75	21.64	21.36	21.67	21.47	21.22	21.55
Conducted Power (Watts)	0.1455	0.1403	0.1496	0.1459	0.1368	0.1469	0.1403	0.1324	0.1429
EIRP(dBm)	19.13	18.97	19.25	19.14	18.86	19.17	18.97	18.72	19.05
EIRP(Watts)	0.0818	0.0789	0.0841	0.0820	0.0769	0.0826	0.0789	0.0745	0.0804



LTE Band 5 (GT - LC = -5.14 dB) QPSK									
Bandwidth	1.4M			3M			5M		
Channel	20407	20525	20643	20415	20525	20635	20425	20525	20625
	(Low)	(Mid)	(High)	(Low)	(Mid)	(High)	(Low)	(Mid)	(High)
Frequency (MHz)	824.7	836.5	848.3	825.5	836.5	847.5	826.5	836.5	846.5
Conducted Power (dBm)	23.17	23.10	22.99	22.90	22.90	22.79	23.03	23.02	22.90
Conducted Power (Watts)	0.2075	0.2042	0.1991	0.1950	0.1950	0.1901	0.2009	0.2004	0.1950
ERP(dBm)	15.88	15.81	15.70	15.61	15.61	15.50	15.74	15.73	15.61
ERP(Watts)	0.0387	0.0381	0.0372	0.0364	0.0364	0.0355	0.0375	0.0374	0.0364

LTE Band 5 (GT - LC = -5.14 dB) QPSK			
Bandwidth	10M		
Channel	20450	20525	20600
	(Low)	(Mid)	(High)
Frequency (MHz)	829	836.5	844
Conducted Power (dBm)	23.26	23.14	23.15
Conducted Power (Watts)	0.2118	0.2061	0.2065
ERP(dBm)	15.97	15.85	15.86
ERP(Watts)	0.0395	0.0385	0.0385



LTE Band 5 (GT - LC = -5.14 dB) 16QAM									
Bandwidth	1.4M			3M			5M		
Channel	20407	20525	20643	20415	20525	20635	20425	20525	20625
	(Low)	(Mid)	(High)	(Low)	(Mid)	(High)	(Low)	(Mid)	(High)
Frequency (MHz)	824.7	836.5	848.3	825.5	836.5	847.5	826.5	836.5	846.5
Conducted Power (dBm)	22.10	21.89	21.82	21.63	21.45	21.33	21.66	21.67	21.56
Conducted Power (Watts)	0.1622	0.1545	0.1521	0.1455	0.1396	0.1358	0.1466	0.1469	0.1432
ERP(dBm)	14.81	14.60	14.53	14.34	14.16	14.04	14.37	14.38	14.27
ERP(Watts)	0.0303	0.0288	0.0284	0.0272	0.0261	0.0254	0.0274	0.0274	0.0267

LTE Band 5 (GT - LC = -5.14 dB) 16QAM			
Bandwidth	10M		
Channel	20450	20525	20600
	(Low)	(Mid)	(High)
Frequency (MHz)	829	836.5	844
Conducted Power (dBm)	21.74	21.41	21.66
Conducted Power (Watts)	0.1493	0.1384	0.1466
ERP(dBm)	14.45	14.12	14.37
ERP(Watts)	0.0279	0.0258	0.0274



LTE Band 7 (GT - LC = -1.60 dB) QPSK			
Bandwidth	5M		
Channel	20775	21100	21425
	(Low)	(Mid)	(High)
Frequency	2502.5	2535	2567.5
(MHz)			
Conducted Power (dBm)	23.40	23.29	23.09
Conducted Power (Watts)	0.2188	0.2133	0.2037
EIRP(dBm)	21.80	21.69	21.49
EIRP(Watts)	0.1514	0.1476	0.1409

LTE Band 7 (GT - LC = -1.60 dB) QPSK									
Bandwidth	10M			15M			20M		
Channel	20800	21100	21400	20825	21100	21375	20850	21100	21350
	(Low)	(Mid)	(High)	(Low)	(Mid)	(High)	(Low)	(Mid)	(High)
Frequency	2505	2535	2565	2507.5	2535	2562.5	2510	2535	2560
(MHz)									
Conducted Power (dBm)	23.37	23.16	23.23	23.39	22.98	23.12	23.43	23.13	23.27
Conducted Power (Watts)	0.2173	0.2070	0.2104	0.2183	0.1986	0.2051	0.2203	0.2056	0.2123
EIRP(dBm)	21.77	21.56	21.63	21.79	21.38	21.52	21.83	21.53	21.67
EIRP(Watts)	0.1503	0.1432	0.1455	0.1510	0.1374	0.1419	0.1524	0.1422	0.1469



LTE Band 7 (GT - LC = xxx dB) 16QAM			
Bandwidth	5M		
Channel	20775	21100	21425
	(Low)	(Mid)	(High)
Frequency	2502.5	2535	2567.5
(MHz)			
Conducted Power (dBm)	21.85	21.64	21.65
Conducted Power (Watts)	0.1531	0.1459	0.1462
EIRP(dBm)	20.25	20.04	20.05
EIRP(Watts)	0.1059	0.1009	0.1012

LTE Band 7 (GT - LC = xxx dB) 16QAM									
Bandwidth	10M			15M			20M		
Channel	20800	21100	21400	20825	21100	21375	20850	21100	21350
	(Low)	(Mid)	(High)	(Low)	(Mid)	(High)	(Low)	(Mid)	(High)
Frequency	2505	2535	2565	2507.5	2535	2562.5	2510	2535	2560
(MHz)									
Conducted Power (dBm)	21.93	21.50	21.60	21.85	21.65	21.65	21.86	21.69	21.62
Conducted Power (Watts)	0.1560	0.1413	0.1445	0.1531	0.1462	0.1462	0.1535	0.1476	0.1452
EIRP(dBm)	20.33	19.90	20.00	20.25	20.05	20.05	20.26	20.09	20.02
EIRP(Watts)	0.1079	0.0977	0.1000	0.1059	0.1012	0.1012	0.1062	0.1021	0.1005



Peak-to-Average Ratio

Mode	LTE Band 2 / 20MHz				
Mod.	QPSK		16QAM		Limit: 13dB
RB Size	1RB	Full RB	1RB	Full RB	Result
Lowest CH	3.36	4.58	4.29	5.62	PASS
Middle CH	3.22	4.72	4.52	5.65	
Highest CH	3.25	4.7	4.43	5.65	

Mode	LTE Band 4 / 20MHz				
Mod.	QPSK		16QAM		Limit: 13dB
RB Size	1RB	Full RB	1RB	Full RB	Result
Lowest CH	3.94	4.78	5.57	5.8	PASS
Middle CH	3.77	4.99	5.54	5.94	
Highest CH	4.29	5.04	5.94	6	

Mode	LTE Band 5 / 10MHz				
Mod.	QPSK		16QAM		Limit: 13dB
RB Size	1RB	Full RB	1RB	Full RB	Result
Lowest CH	3.62	4.9	5.42	5.83	PASS
Middle CH	3.8	5.04	5.28	5.97	
Highest CH	4.17	5.01	5.33	5.94	

Mode	LTE Band 7 / 20MHz				
Mod.	QPSK		16QAM		Limit: 13dB
RB Size	1RB	Full RB	1RB	Full RB	Result
Lowest CH	3.36	4.87	5.10	5.94	PASS
Middle CH	3.86	4.84	5.33	5.83	
Highest CH	3.83	4.90	5.51	5.97	



LTE Band 2 / 20MHz / QPSK

Lowest Channel / 1RB

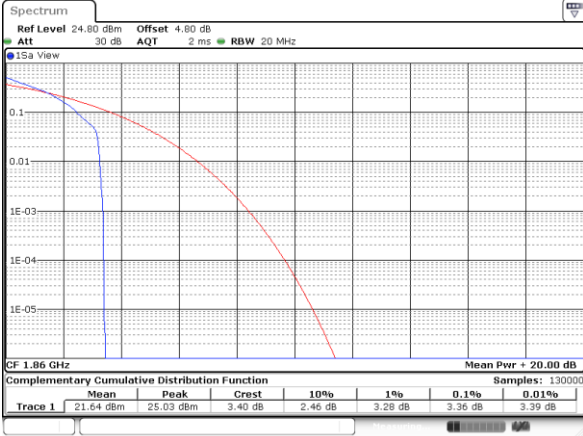

Date: 24 APR 2018 15:43:22

Lowest Channel / Full RB

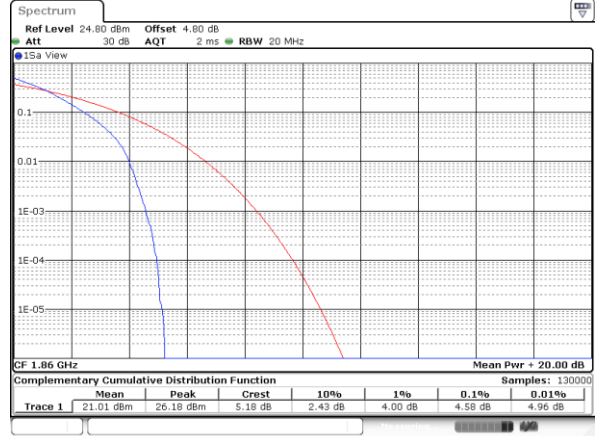

Date: 24 APR 2018 15:43:09

Middle Channel / 1RB

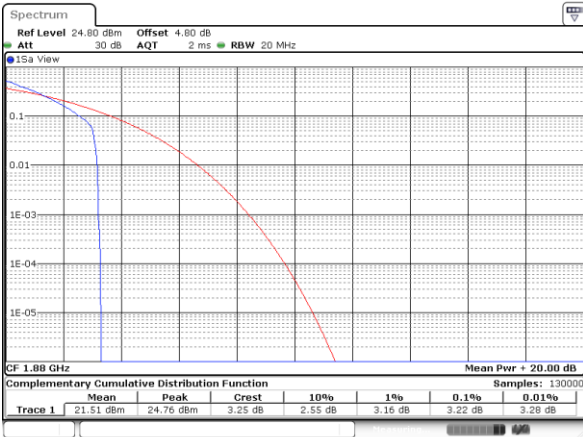

Date: 24 APR 2018 15:42:44

Middle Channel / Full RB

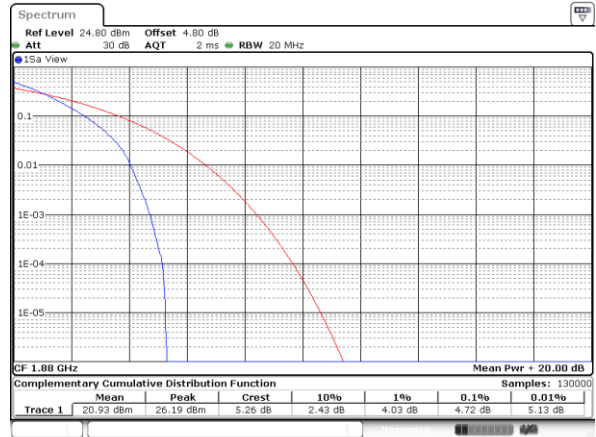

Date: 24 APR 2018 15:42:56

Highest Channel / 1RB

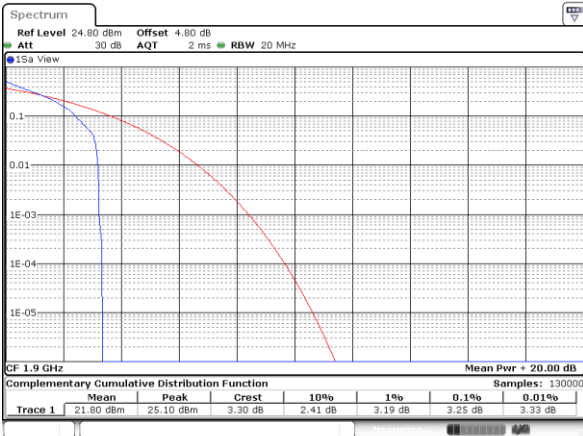

Date: 24 APR 2018 15:42:31

Highest Channel / Full RB

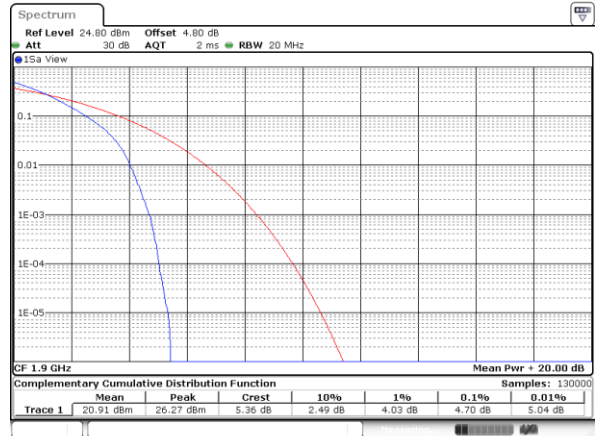

Date: 24 APR 2018 15:42:19



LTE Band 2 / 20MHz / 16QAM

Lowest Channel / 1RB

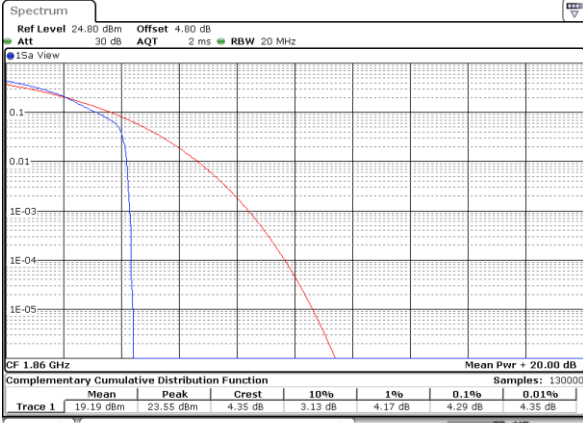

Date: 24 APR 2018 15:40:47

Lowest Channel / Full RB

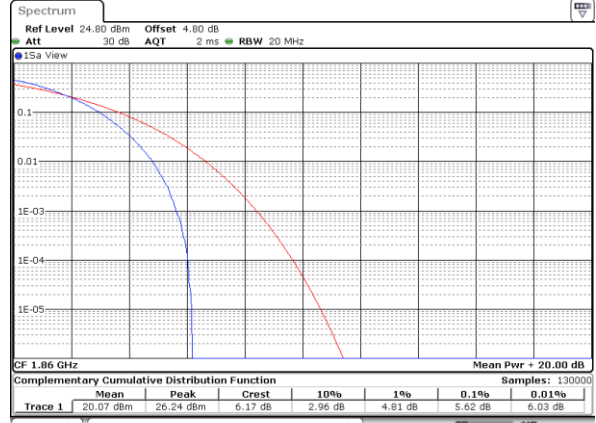

Date: 24 APR 2018 15:40:56

Middle Channel / 1RB

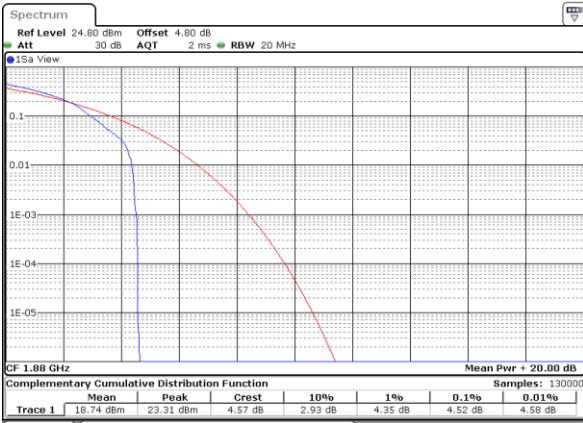

Date: 24 APR 2018 15:41:06

Middle Channel / Full RB

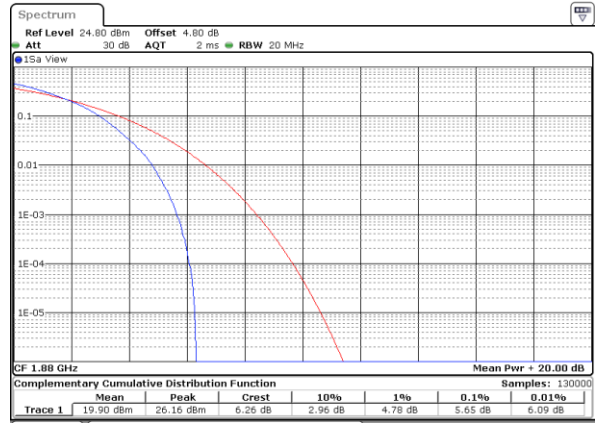

Date: 24 APR 2018 15:41:22

Highest Channel / 1RB

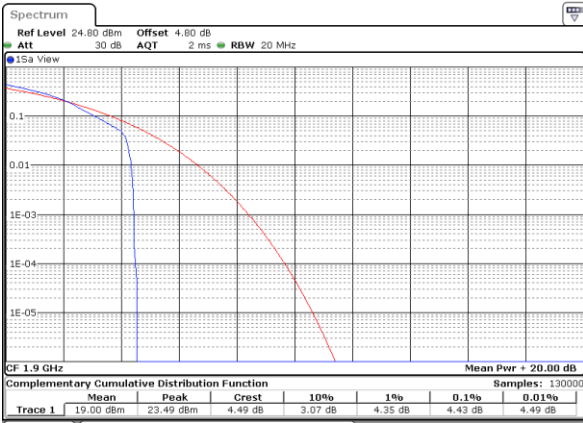

Date: 24 APR 2018 15:41:33

Highest Channel / Full RB

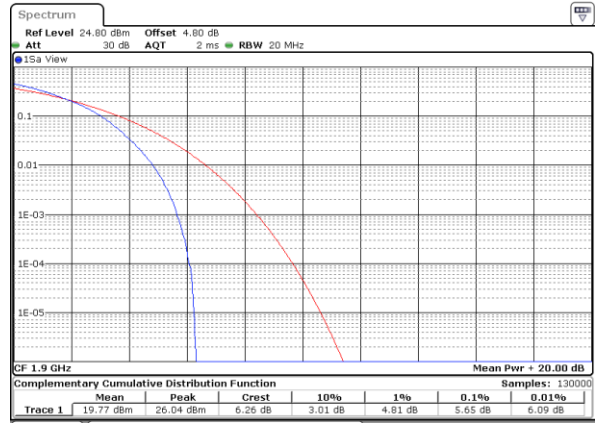

Date: 24 APR 2018 15:41:43





LTE Band 4 / 20MHz / QPSK

Lowest Channel / 1RB

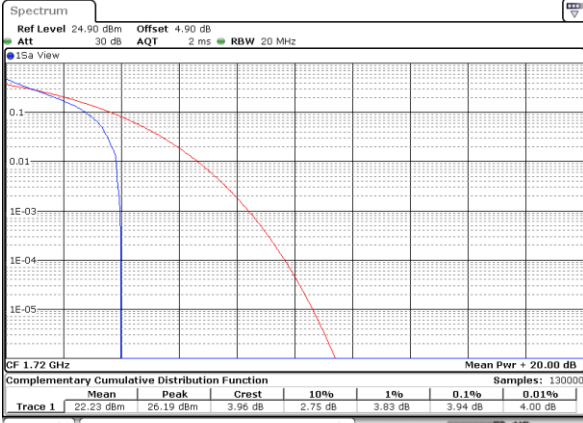

Date: 25 APR 2018 10:23:53

Lowest Channel / Full RB

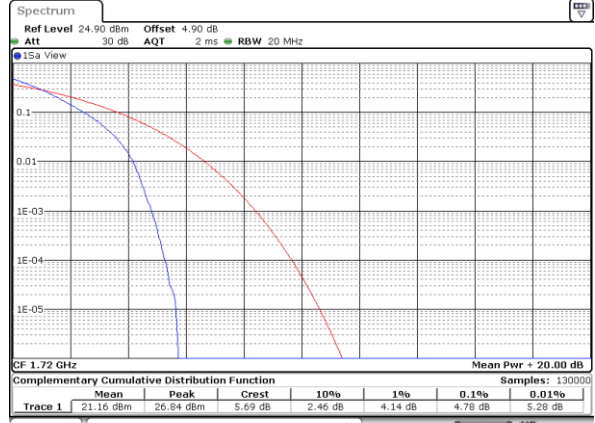

Date: 25 APR 2018 10:23:38

Middle Channel / 1RB

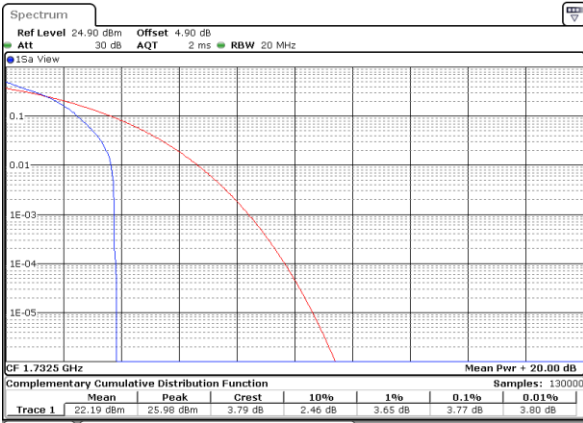

Date: 25 APR 2018 10:22:28

Middle Channel / Full RB

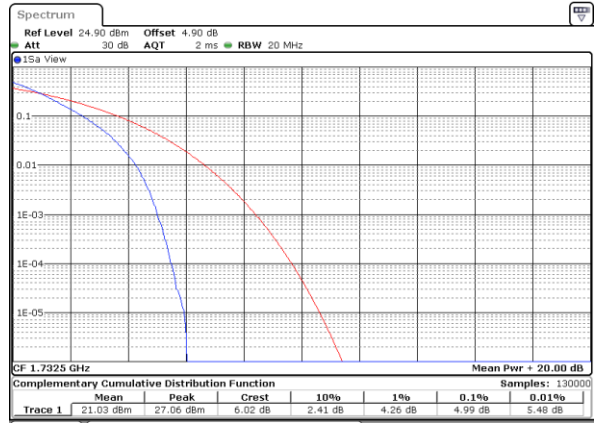

Date: 25 APR 2018 10:23:26

Highest Channel / 1RB

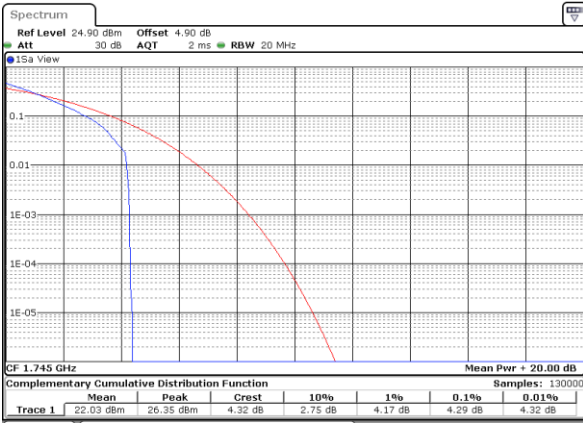

Date: 25 APR 2018 10:22:16

Highest Channel / Full RB

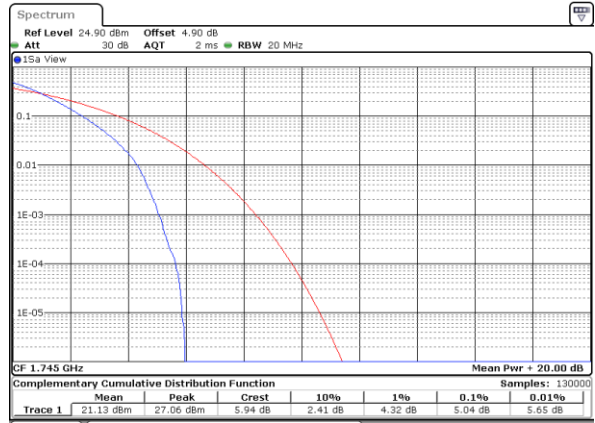

Date: 25 APR 2018 10:21:54



LTE Band 4 / 20MHz / 16QAM

Lowest Channel / 1RB

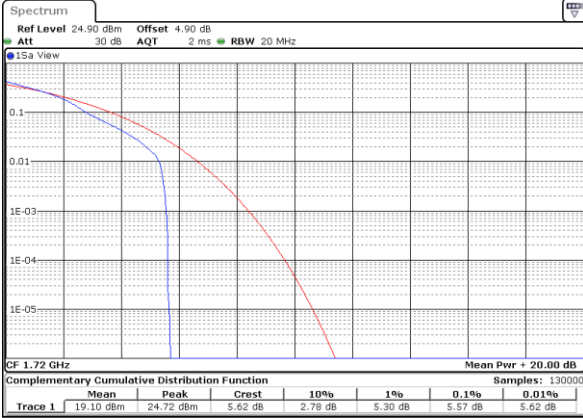

Date: 25 APR 2018 10:20:35

Lowest Channel / Full RB

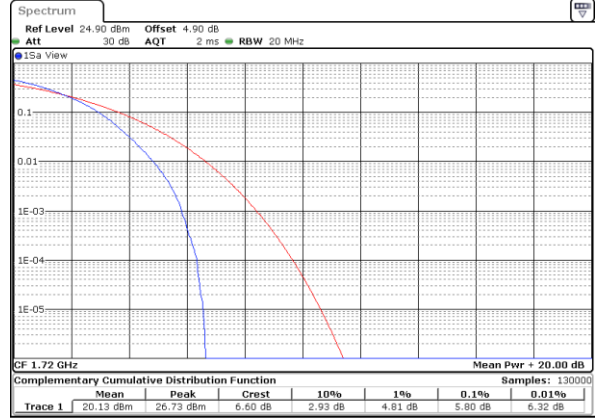

Date: 25 APR 2018 10:20:45

Middle Channel / 1RB

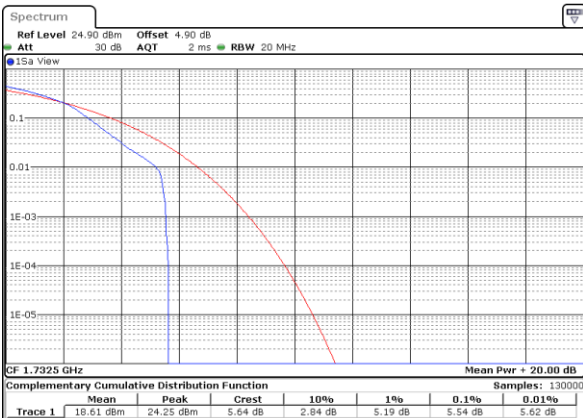

Date: 25 APR 2018 10:20:56

Middle Channel / Full RB

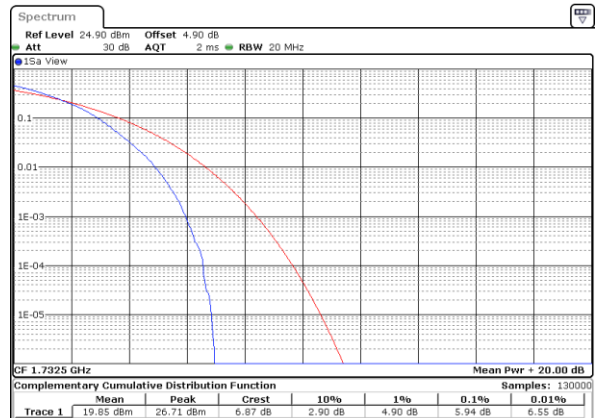

Date: 25 APR 2018 10:21:06

Highest Channel / 1RB



Date: 25 APR 2018 10:21:16

Highest Channel / Full RB



Date: 25 APR 2018 10:21:26



LTE Band 5 / 10MHz / QPSK

Lowest Channel / 1RB

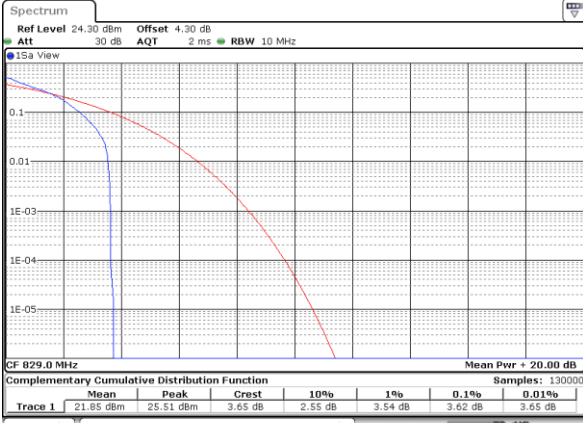

Date: 24 APR 2018 17:27:35

Lowest Channel / Full RB

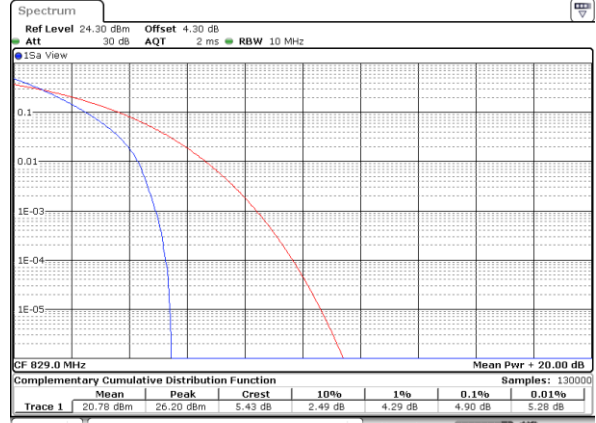

Date: 24 APR 2018 17:28:50

Middle Channel / 1RB

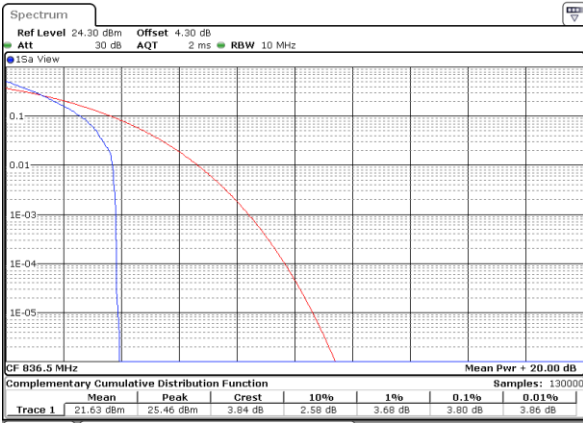

Date: 24 APR 2018 17:26:13

Middle Channel / Full RB

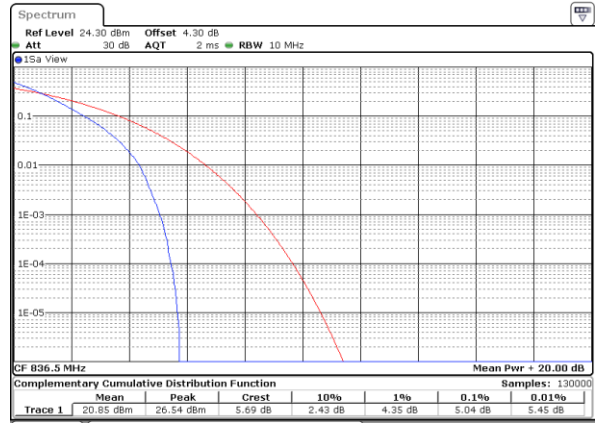

Date: 24 APR 2018 17:26:27

Highest Channel / 1RB

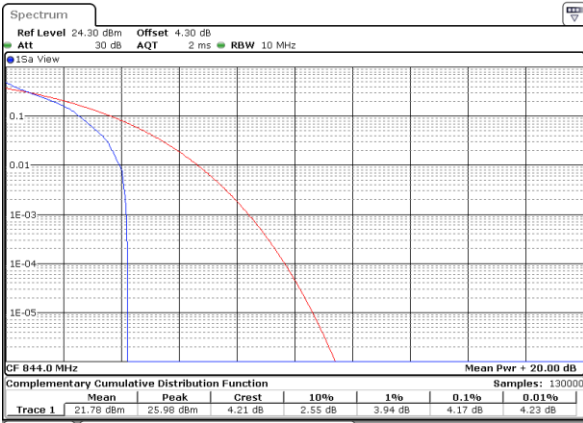

Date: 24 APR 2018 17:26:00

Highest Channel / Full RB

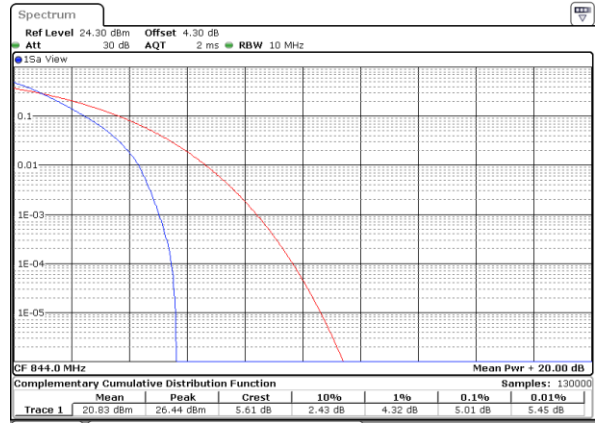

Date: 24 APR 2018 17:25:45



LTE Band 5 / 10MHz / 16QAM

Lowest Channel / 1RB

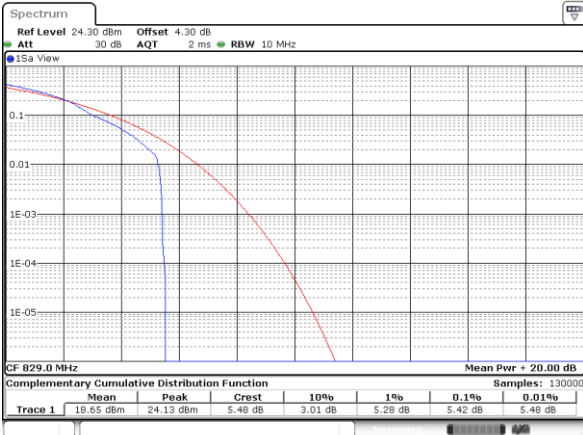

Date: 24 APR 2018 17:24:24

Lowest Channel / Full RB

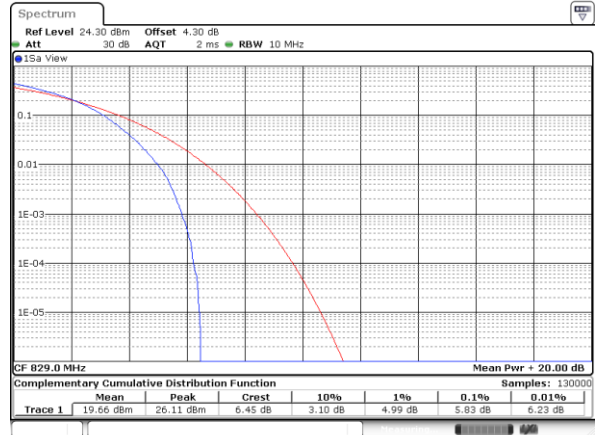

Date: 24 APR 2018 17:24:33

Middle Channel / 1RB

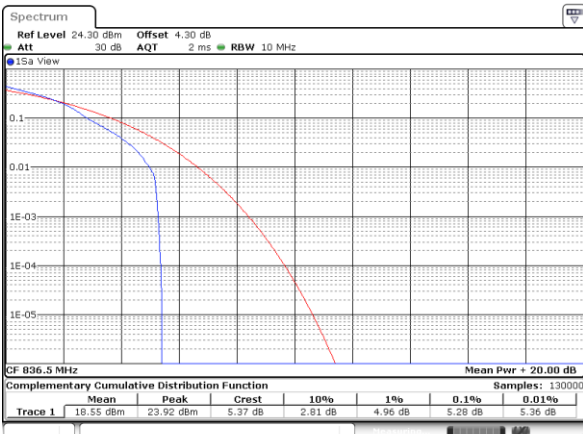

Date: 24 APR 2018 17:24:43

Middle Channel / Full RB

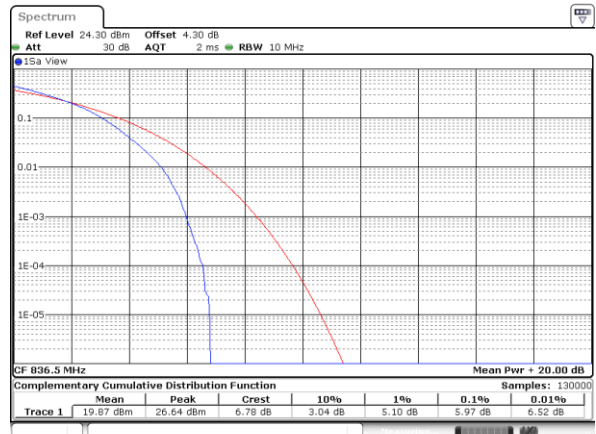

Date: 24 APR 2018 17:24:59

Highest Channel / 1RB

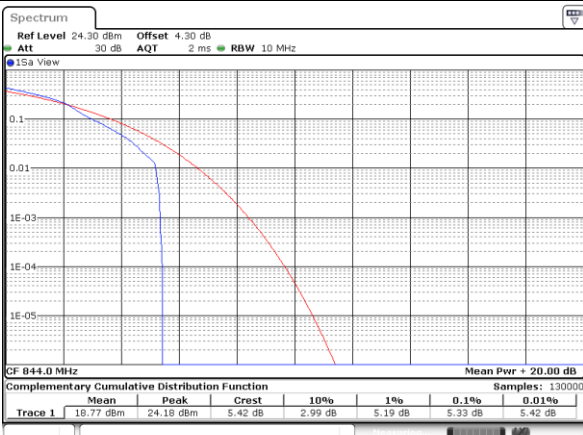

Date: 24 APR 2018 17:25:09

Highest Channel / Full RB

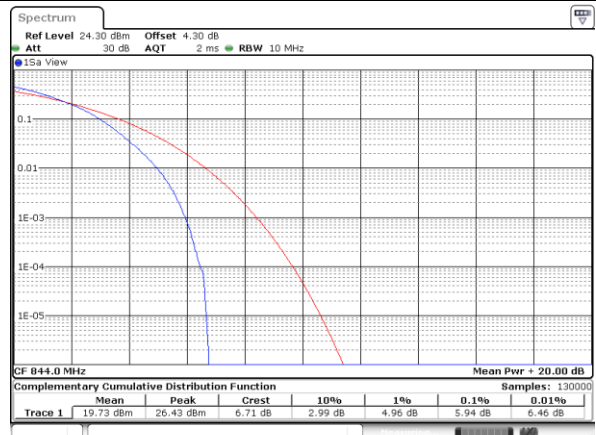

Date: 24 APR 2018 17:25:19



LTE Band 7 / 20MHz / QPSK

Lowest Channel / 1RB

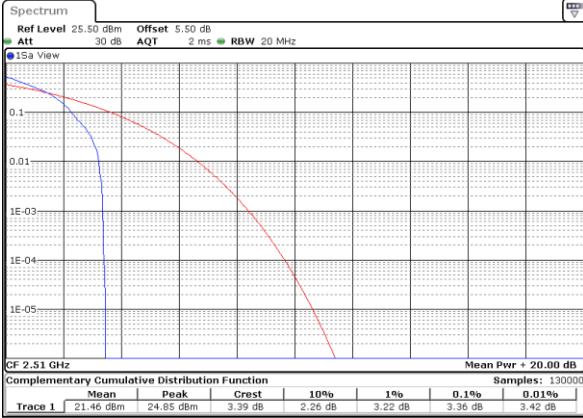

Date: 25 APR 2018 19:55:10

Lowest Channel / Full RB

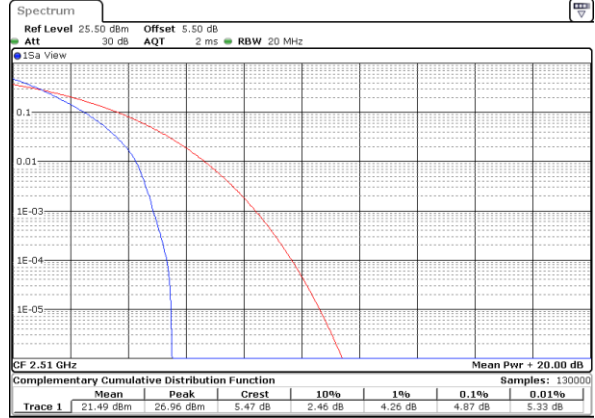

Date: 25 APR 2018 19:55:38

Middle Channel / 1RB

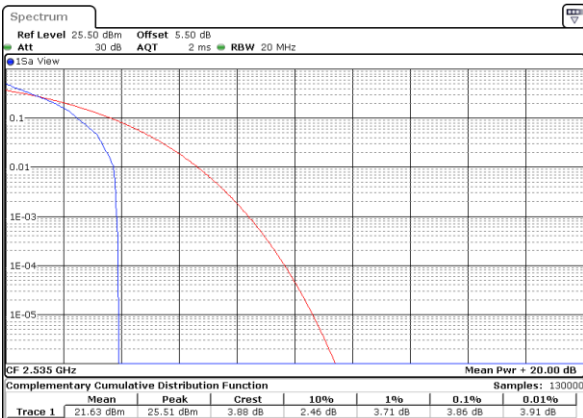

Date: 25 APR 2018 20:04:58

Middle Channel / Full RB

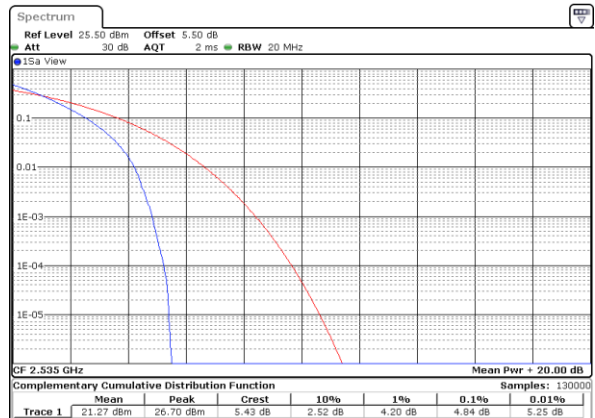

Date: 25 APR 2018 19:55:47

Highest Channel / 1RB



Date: 25 APR 2018 20:05:06

Highest Channel / Full RB



Date: 25 APR 2018 20:05:45



LTE Band 7 / 20MHz / 16QAM

Lowest Channel / 1RB

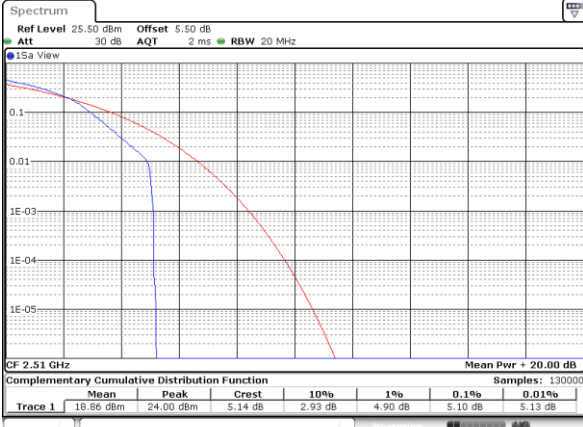

Date: 25 APR 2018 19:55:19

Lowest Channel / Full RB

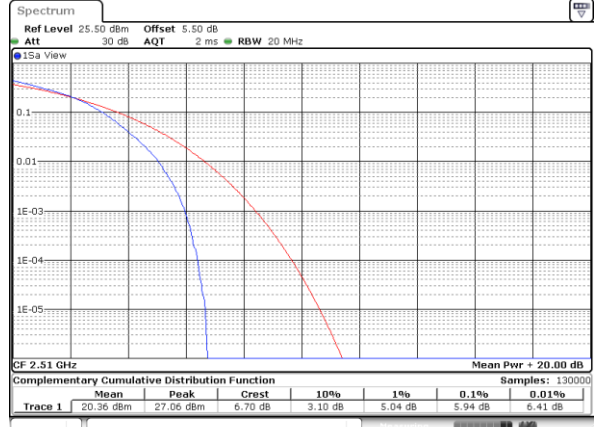

Date: 25 APR 2018 19:55:29

Middle Channel / 1RB

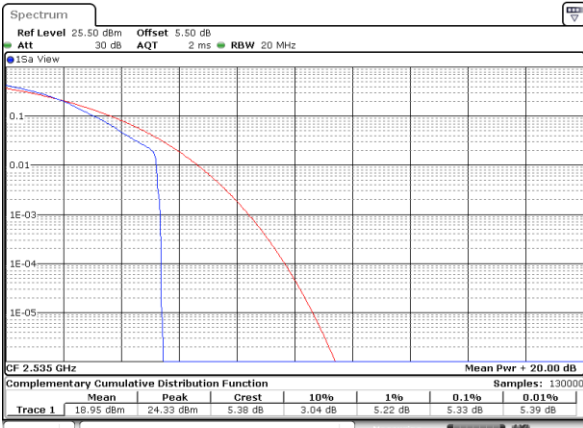

Date: 25 APR 2018 20:04:49

Middle Channel / Full RB

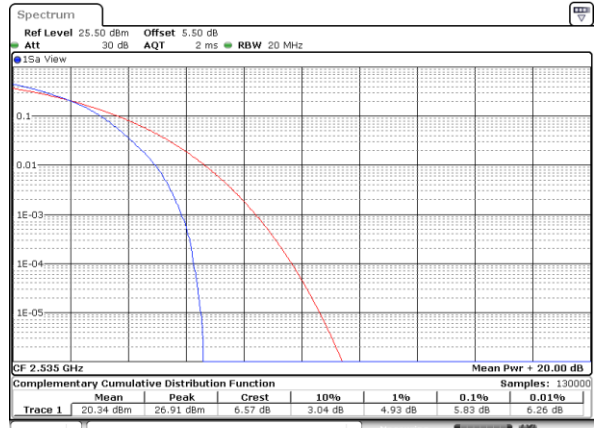

Date: 25 APR 2018 19:55:56

Highest Channel / 1RB

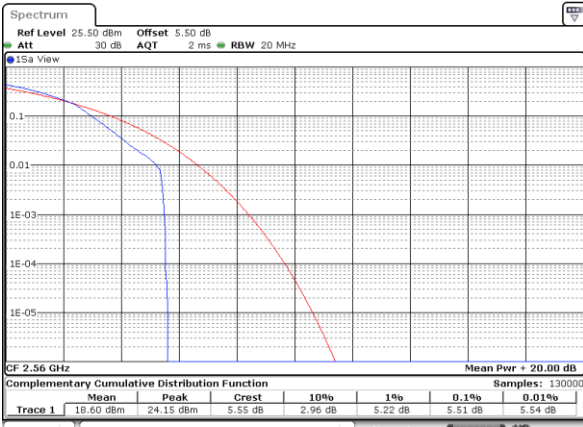

Date: 25 APR 2018 20:05:22

Highest Channel / Full RB

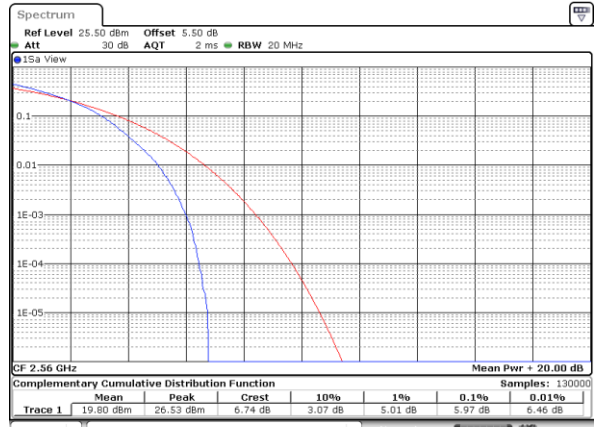

Date: 25 APR 2018 20:05:32



26dB Bandwidth

Mode	LTE Band 2 : 26dB BW(MHz)											
	1.4MHz		3MHz		5MHz		10MHz		15MHz		20MHz	
Mod.	QPSK	16QAM	QPSK	16QAM	QPSK	16QAM	QPSK	16QAM	QPSK	16QAM	QPSK	16QAM
Lowest CH	1.287	1.262	3.039	3.027	4.925	4.925	9.79	9.71	14.356	14.386	20.02	20.22
Middle CH	1.284	1.262	3.039	2.985	4.895	4.905	9.61	9.67	14.236	14.326	20.22	20.1
Highest CH	1.281	1.29	3.039	2.997	4.795	4.925	9.91	9.95	14.416	14.116	20.14	20.02

Mode	LTE Band 4 : 26dB BW(MHz)											
	1.4MHz		3MHz		5MHz		10MHz		15MHz		20MHz	
Mod.	QPSK	16QAM	QPSK	16QAM	QPSK	16QAM	QPSK	16QAM	QPSK	16QAM	QPSK	16QAM
Lowest CH	1.264	1.256	3.021	3.021	4.935	4.925	9.89	9.77	14.266	14.236	20.06	20.14
Middle CH	1.276	1.264	3.027	2.973	4.975	4.945	9.79	9.89	14.356	14.565	20.1	20.06
Highest CH	1.236	1.256	3.015	3.003	4.885	4.935	10.03	9.77	14.176	14.595	20.14	20.1

Mode	LTE Band 5 : 26dB BW(MHz)							
	1.4MHz		3MHz		5MHz		10MHz	
Mod.	QPSK	16QAM	QPSK	16QAM	QPSK	16QAM	QPSK	16QAM
Lowest CH	1.27	1.278	2.973	3.015	4.895	4.895	9.63	9.73
Middle CH	1.259	1.295	3.057	3.003	4.935	4.865	9.79	9.87
Highest CH	1.264	1.27	3.009	3.015	4.875	4.805	9.75	9.79

Mode	LTE Band 7 : 26dB BW(MHz)							
	5MHz		10MHz		15MHz		20MHz	
Mod.	QPSK	16QAM	QPSK	16QAM	QPSK	16QAM	QPSK	16QAM
Lowest CH	4.86	4.92	9.69	9.77	14.30	14.57	20.22	20.06
Middle CH	4.95	4.90	9.81	9.71	14.39	14.30	20.50	20.30
Highest CH	4.95	4.92	9.67	9.63	14.51	14.24	20.14	20.14



LTE Band 2

Lowest Channel / 1.4MHz / QPSK

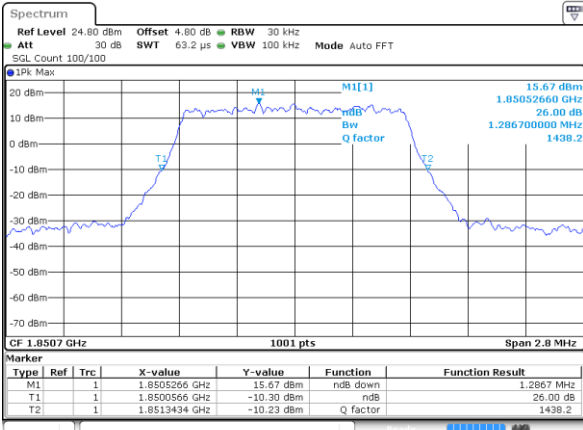

Date: 24 APR 2018 13:59:24

Lowest Channel / 1.4MHz / 16QAM

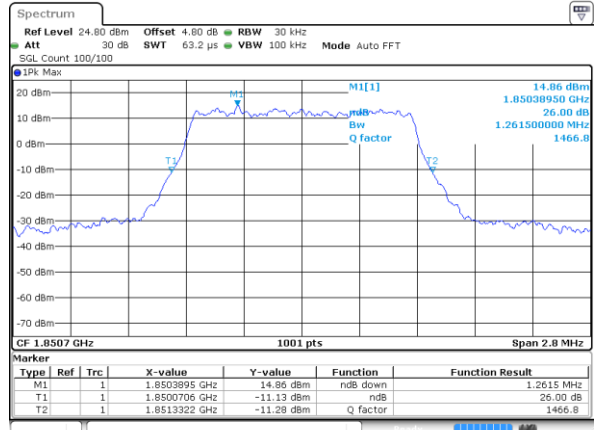

Date: 24 APR 2018 13:59:35

Middle Channel / 1.4MHz / QPSK

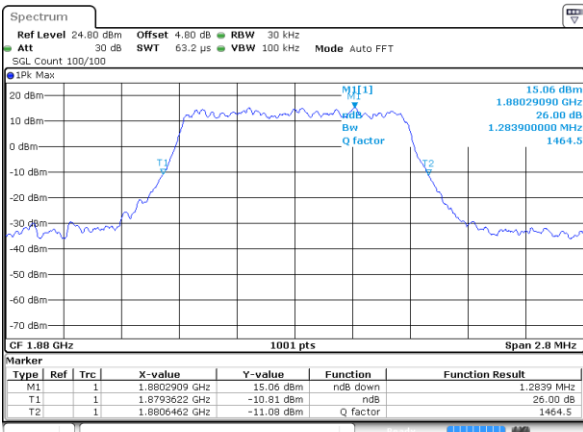

Date: 24 APR 2018 14:06:31

Middle Channel / 1.4MHz / 16QAM

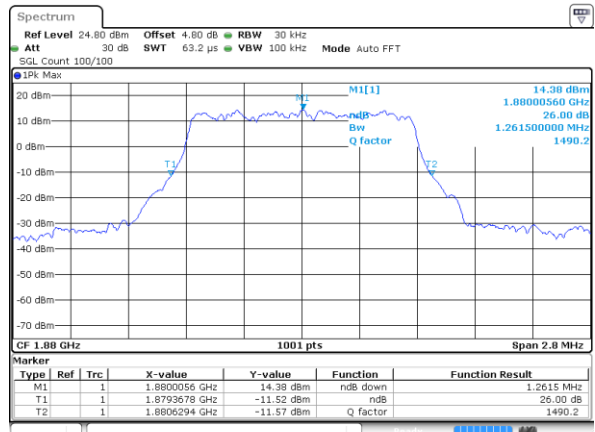

Date: 24 APR 2018 14:06:42

Highest Channel / 1.4MHz / QPSK

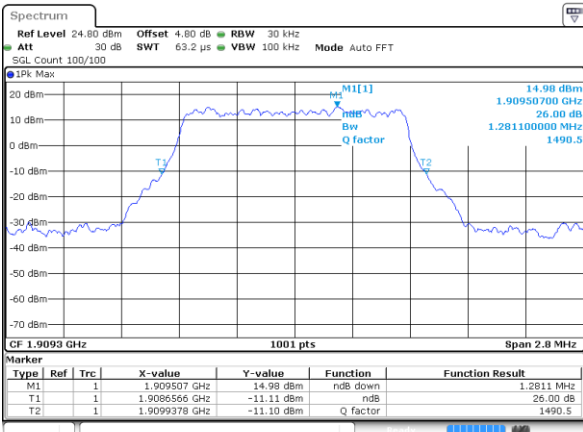

Date: 24 APR 2018 14:09:05

Highest Channel / 1.4MHz / 16QAM

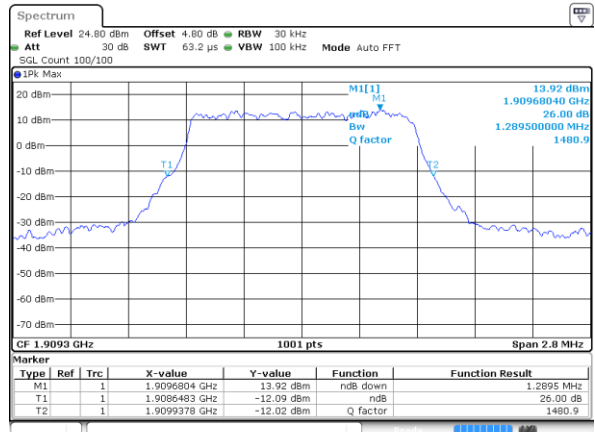

Date: 24 APR 2018 14:09:16





LTE Band 2

Lowest Channel / 3MHz / QPSK

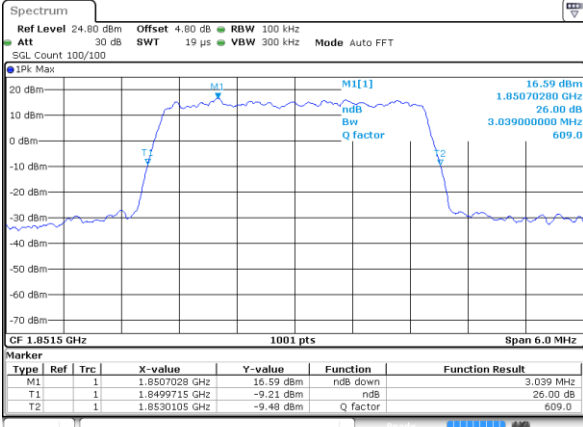

Date: 24 APR 2018 14:16:13

Lowest Channel / 3MHz / 16QAM

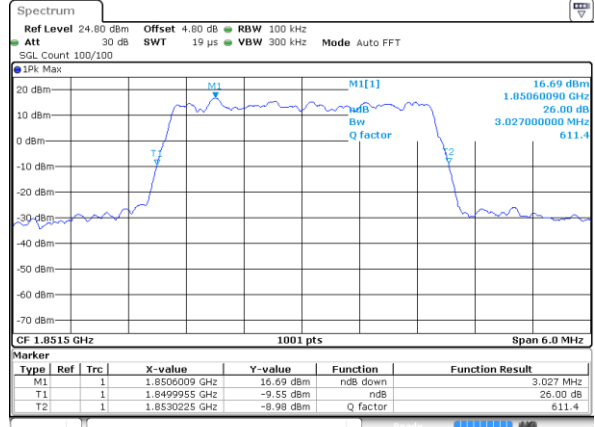

Date: 24 APR 2018 14:16:24

Middle Channel / 3MHz / QPSK

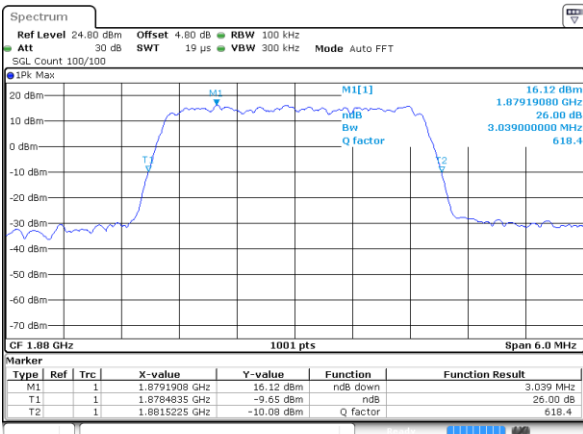

Date: 24 APR 2018 14:23:20

Middle Channel / 3MHz / 16QAM

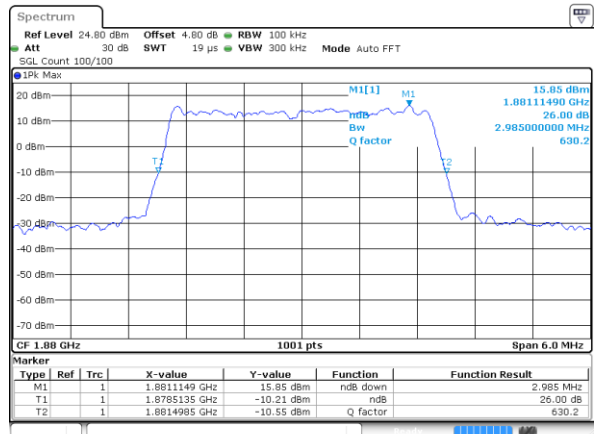

Date: 24 APR 2018 14:23:30

Highest Channel / 3MHz / QPSK

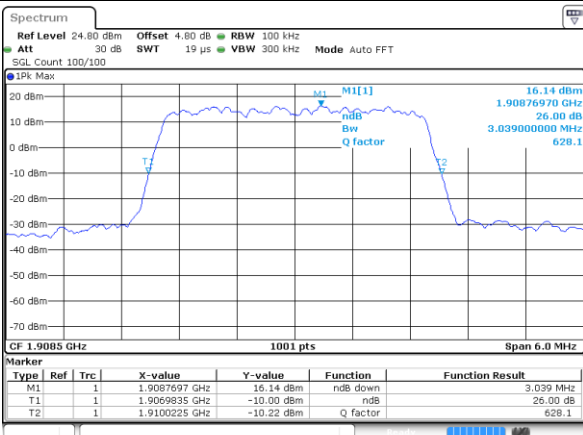

Date: 24 APR 2018 14:25:54

Highest Channel / 3MHz / 16QAM

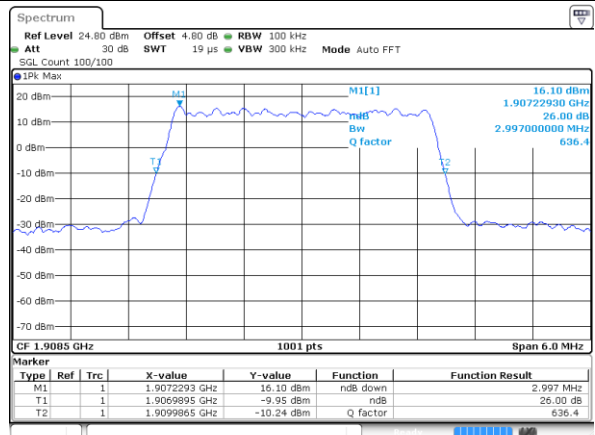

Date: 24 APR 2018 14:26:04



LTE Band 2

Lowest Channel / 5MHz / QPSK

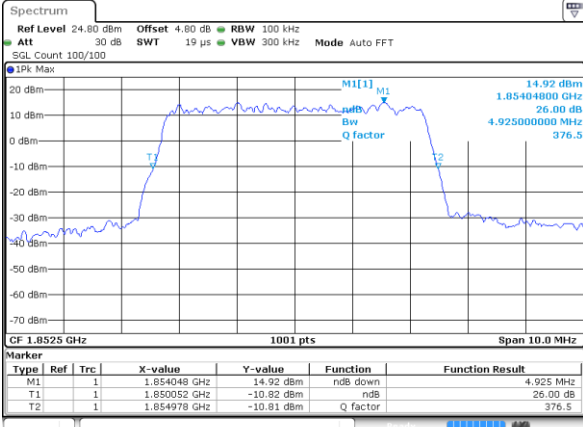

Date: 24 APR 2018 14:33:00

Lowest Channel / 5MHz / 16QAM

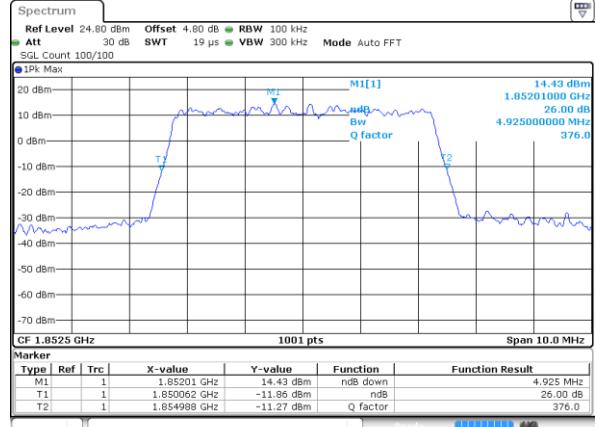

Date: 24 APR 2018 14:33:10

Middle Channel / 5MHz / QPSK

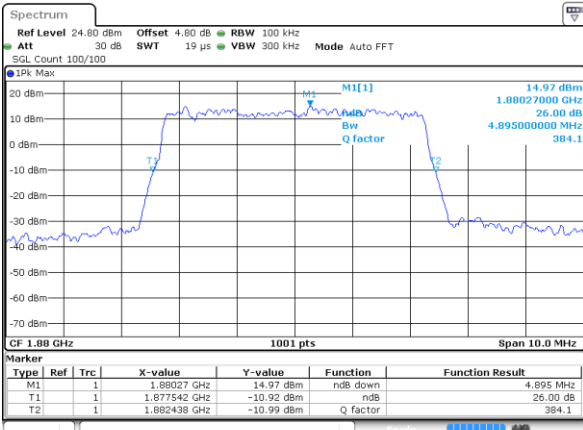

Date: 24 APR 2018 14:40:05

Middle Channel / 5MHz / 16QAM

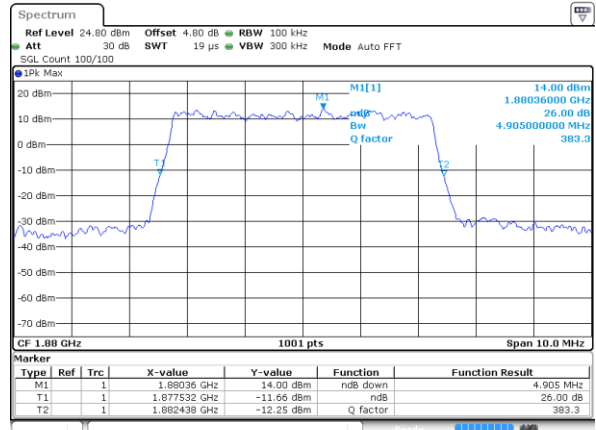

Date: 24 APR 2018 14:40:16

Highest Channel / 5MHz / QPSK

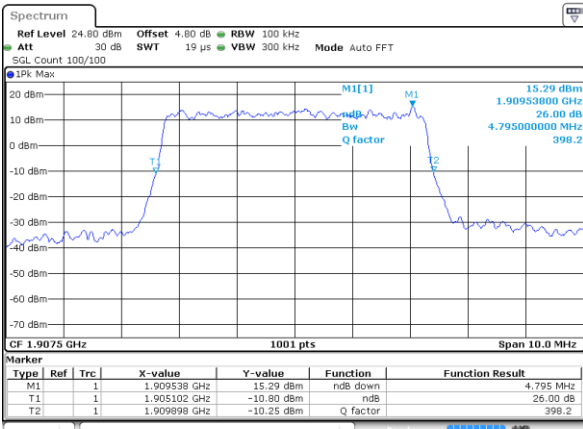

Date: 24 APR 2018 14:42:39

Highest Channel / 5MHz / 16QAM

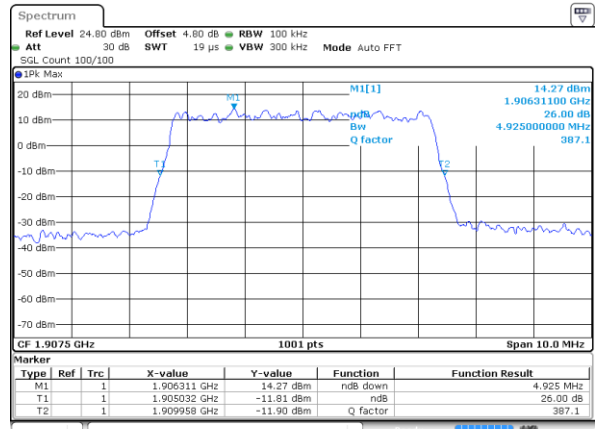

Date: 24 APR 2018 14:42:49



LTE Band 2

Lowest Channel / 10MHz / QPSK

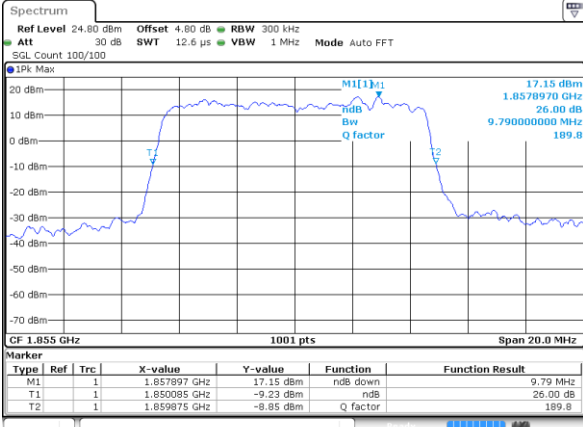

Date: 24 APR 2018 14:49:44

Lowest Channel / 10MHz / 16QAM

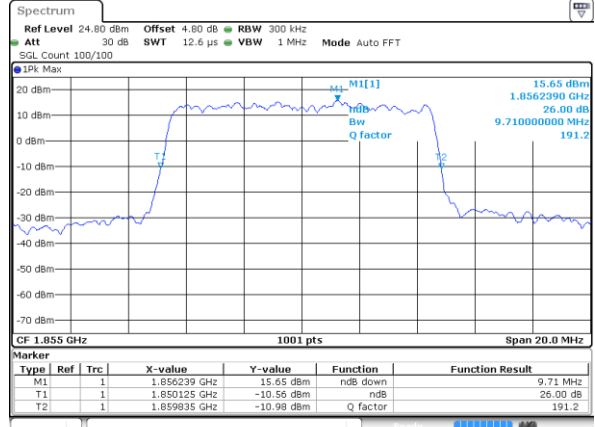

Date: 24 APR 2018 14:49:55

Middle Channel / 10MHz / QPSK

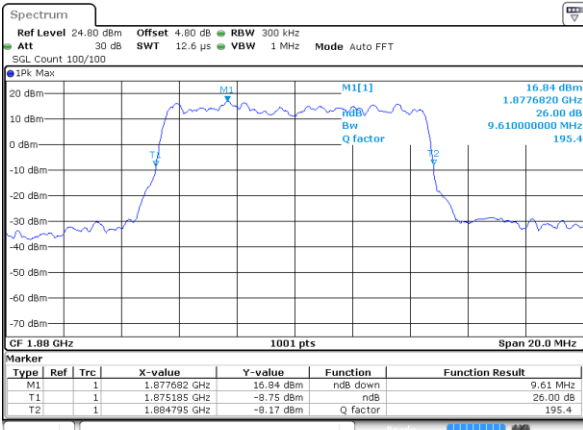

Date: 24 APR 2018 14:56:51

Middle Channel / 10MHz / 16QAM

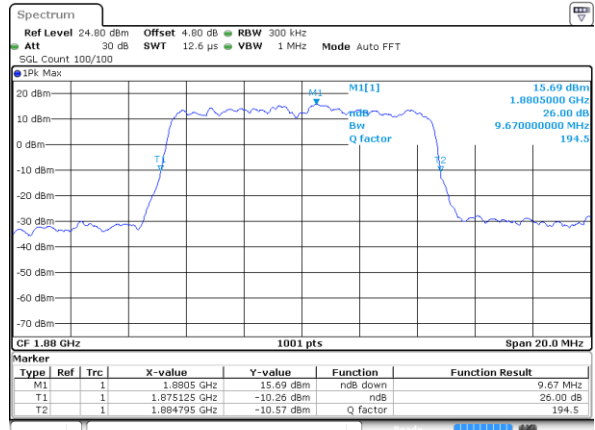

Date: 24 APR 2018 14:57:02

Highest Channel / 10MHz / QPSK

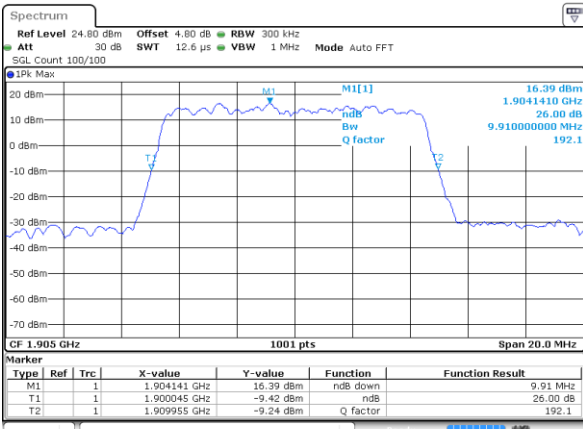

Date: 24 APR 2018 14:59:25

Highest Channel / 10MHz / 16QAM

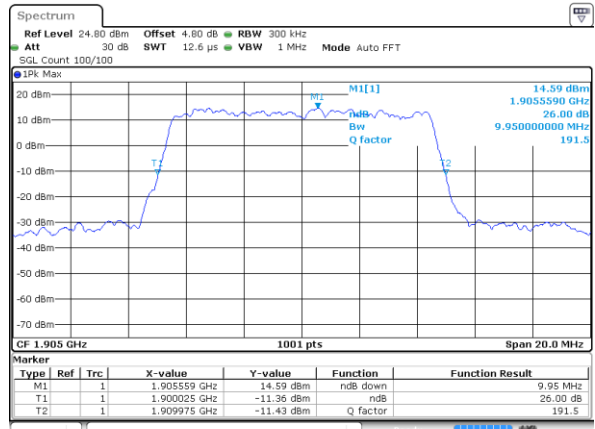

Date: 24 APR 2018 14:59:35



LTE Band 2

Lowest Channel / 15MHz / QPSK

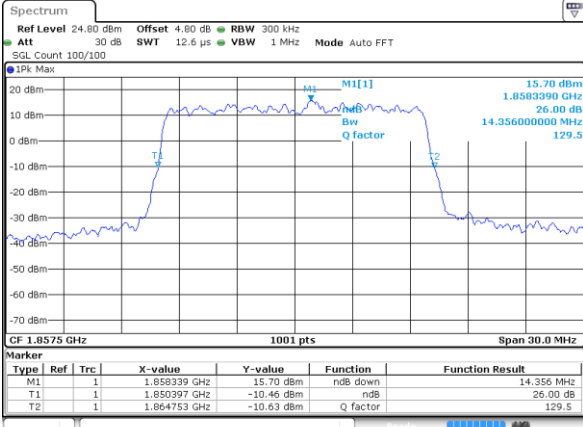

Date: 24 APR 2018 15:06:31

Lowest Channel / 15MHz / 16QAM

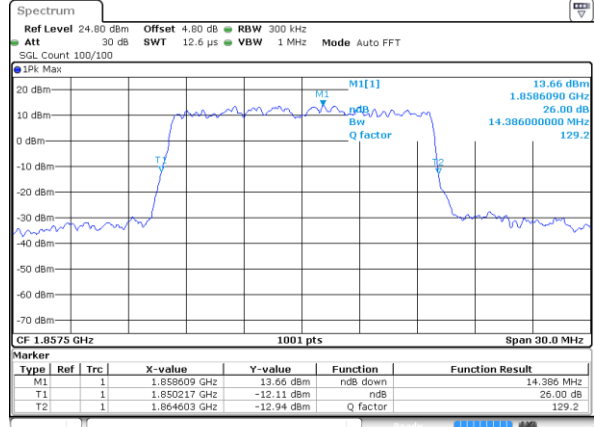

Date: 24 APR 2018 15:06:41

Middle Channel / 15MHz / QPSK

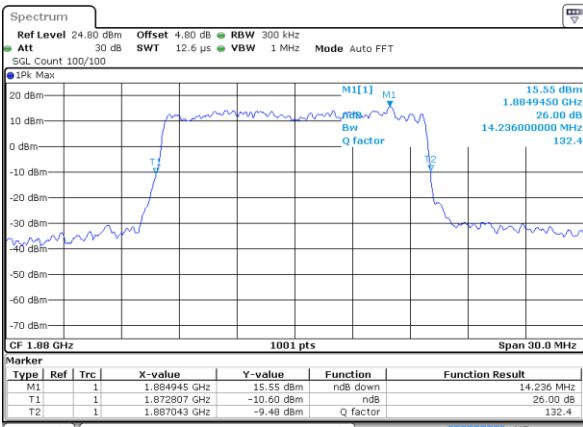

Date: 24 APR 2018 15:13:37

Middle Channel / 15MHz / 16QAM

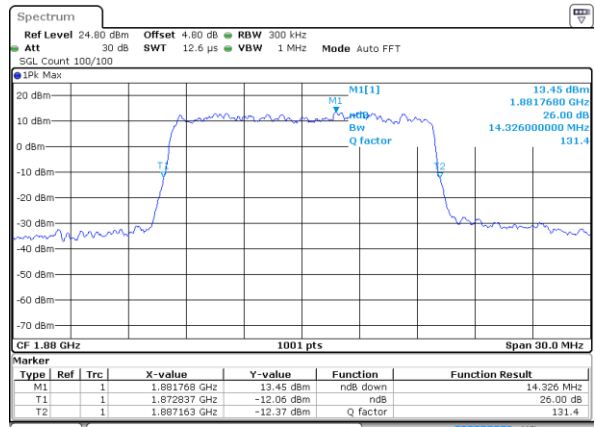

Date: 24 APR 2018 15:13:47

Highest Channel / 15MHz / QPSK

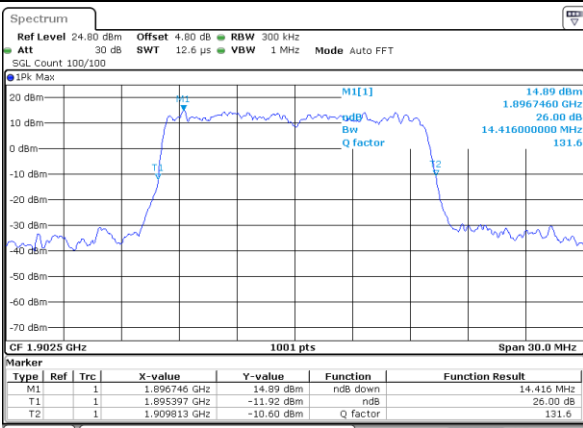

Date: 24 APR 2018 15:16:10

Highest Channel / 15MHz / 16QAM

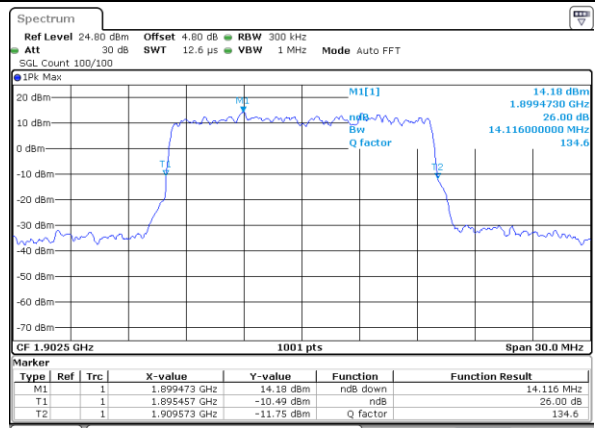

Date: 24 APR 2018 15:16:21



LTE Band 2

Lowest Channel / 20MHz / QPSK

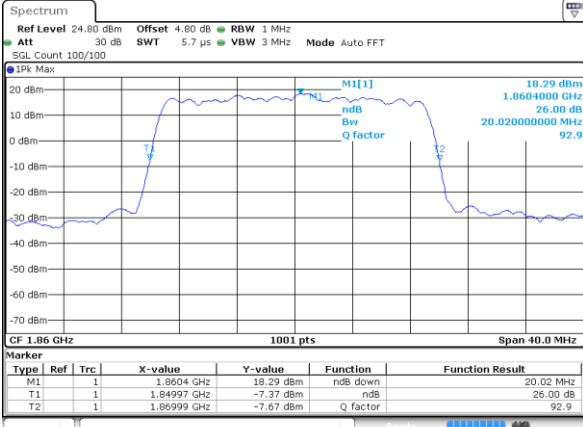

Date: 24 APR 2018 15:23:17

Lowest Channel / 20MHz / 16QAM

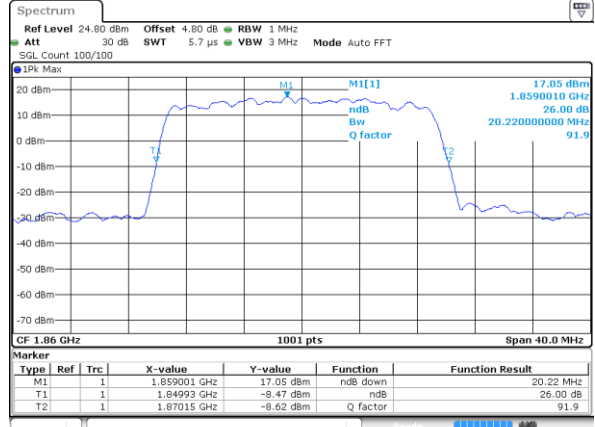

Date: 24 APR 2018 15:23:27

Middle Channel / 20MHz / QPSK

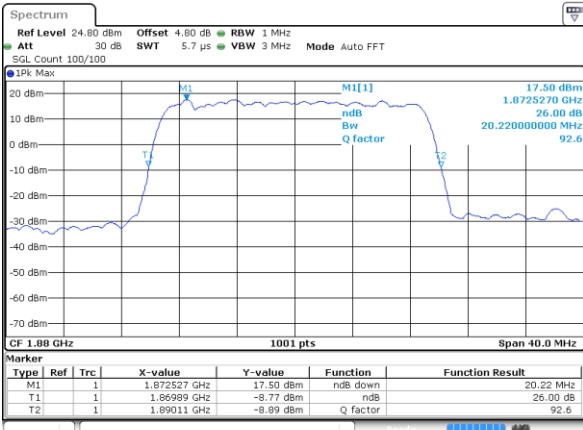

Date: 24 APR 2018 15:30:23

Middle Channel / 20MHz / 16QAM

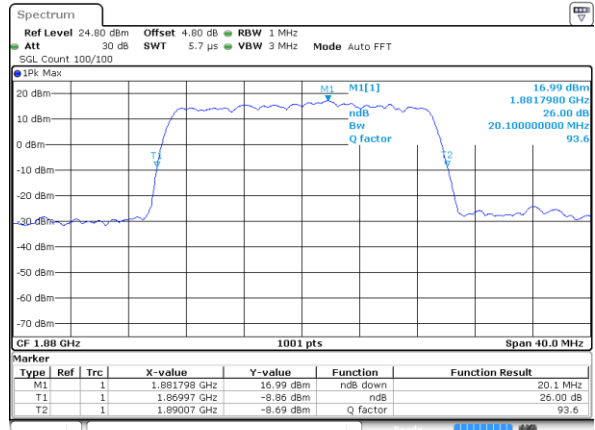

Date: 24 APR 2018 15:30:34

Highest Channel / 20MHz / QPSK

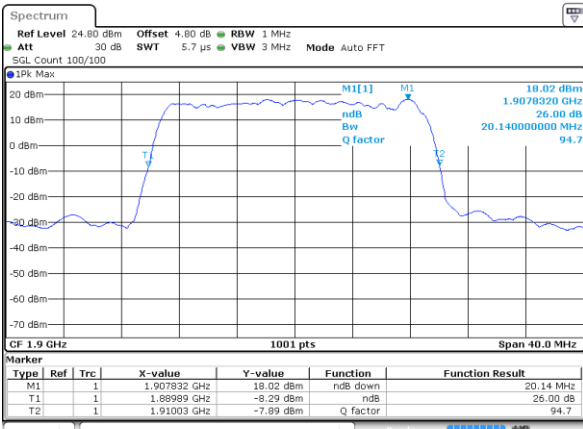

Date: 24 APR 2018 15:32:57

Highest Channel / 20MHz / 16QAM

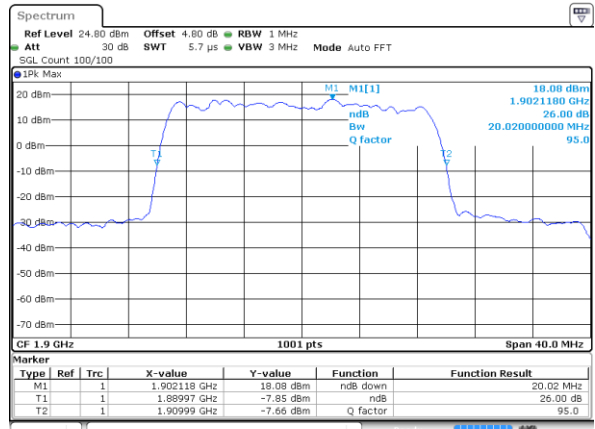

Date: 24 APR 2018 15:33:07



LTE Band 4

Lowest Channel / 1.4MHz / QPSK

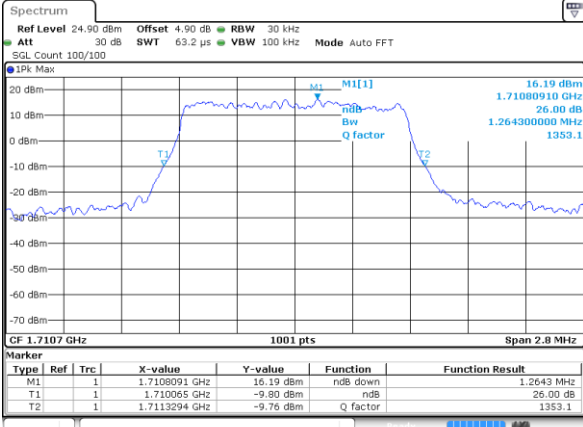

Date: 25 APR 2018 08:40:08

Lowest Channel / 1.4MHz / 16QAM

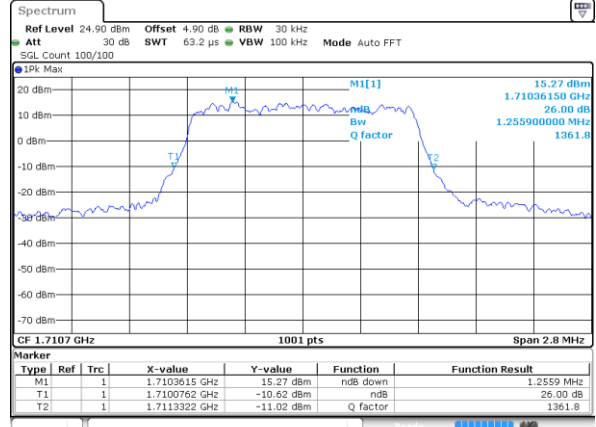

Date: 25 APR 2018 08:40:19

Middle Channel / 1.4MHz / QPSK

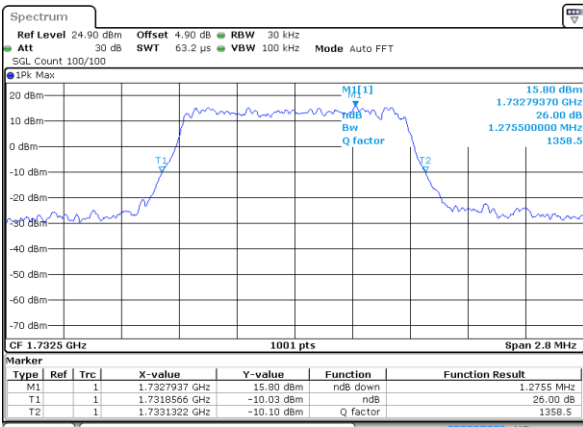

Date: 25 APR 2018 08:47:14

Middle Channel / 1.4MHz / 16QAM

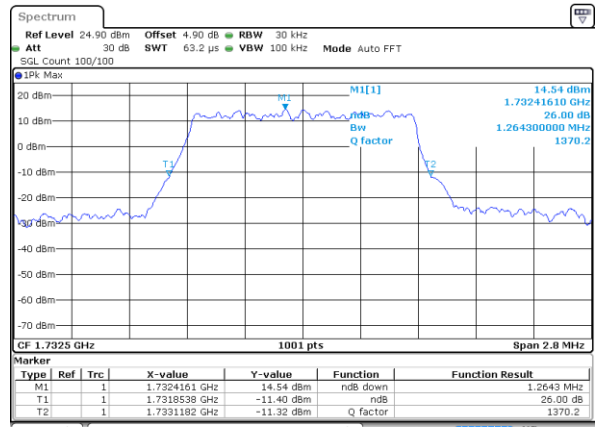

Date: 25 APR 2018 08:47:25

Highest Channel / 1.4MHz / QPSK

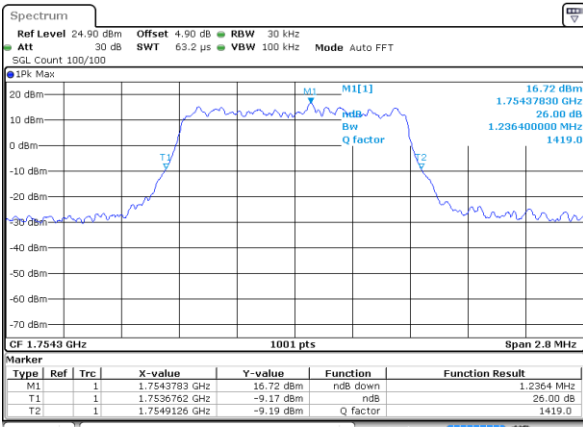

Date: 25 APR 2018 08:49:48

Highest Channel / 1.4MHz / 16QAM

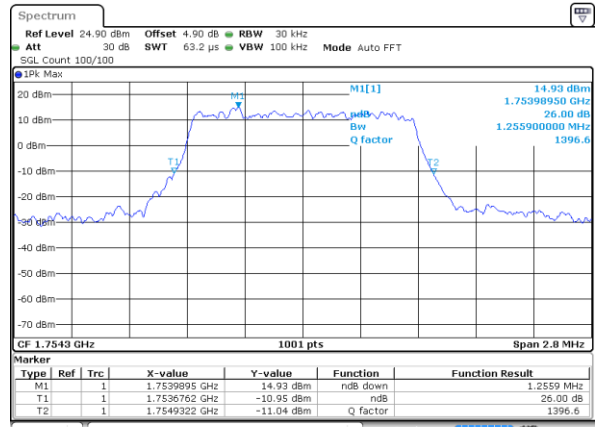

Date: 25 APR 2018 08:49:58



LTE Band 4

Lowest Channel / 3MHz / QPSK

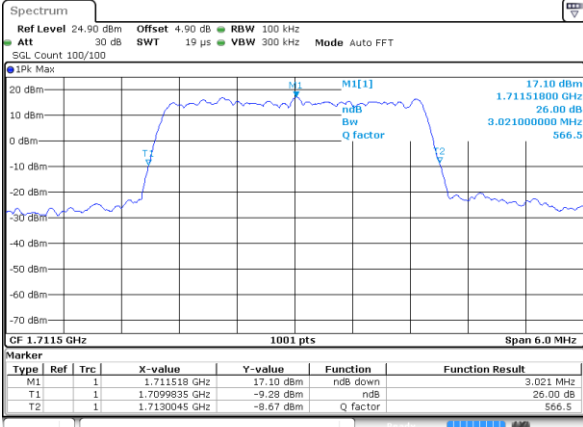

Date: 25 APR 2018 08:56:53

Lowest Channel / 3MHz / 16QAM

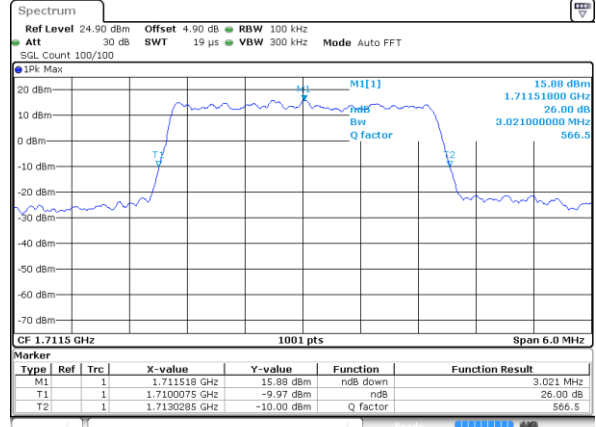

Date: 25 APR 2018 08:57:03

Middle Channel / 3MHz / QPSK

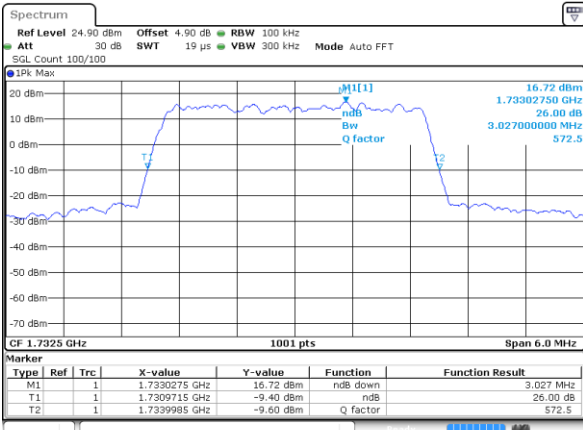

Date: 25 APR 2018 09:03:58

Middle Channel / 3MHz / 16QAM

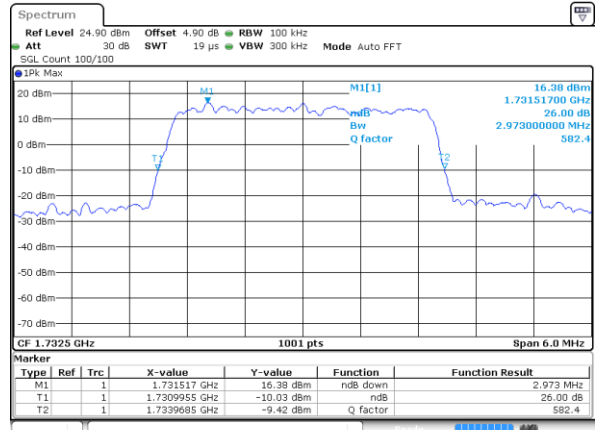

Date: 25 APR 2018 09:04:09

Highest Channel / 3MHz / QPSK

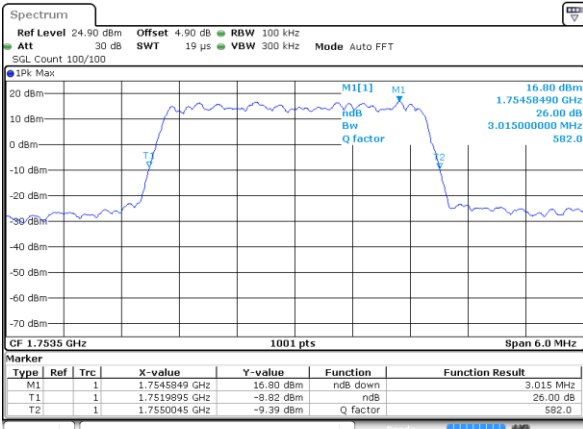

Date: 25 APR 2018 09:06:31

Highest Channel / 3MHz / 16QAM

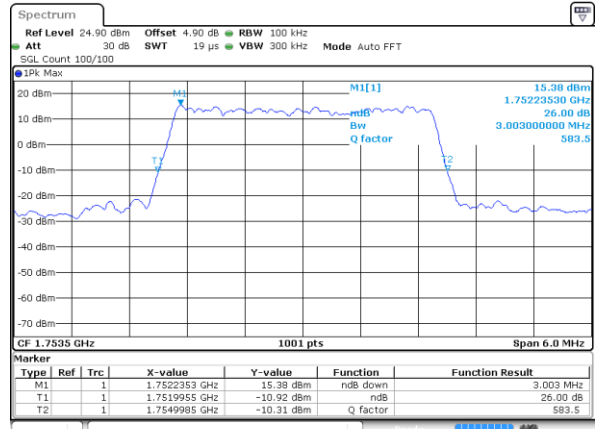

Date: 25 APR 2018 09:06:42



LTE Band 4

Lowest Channel / 5MHz / QPSK

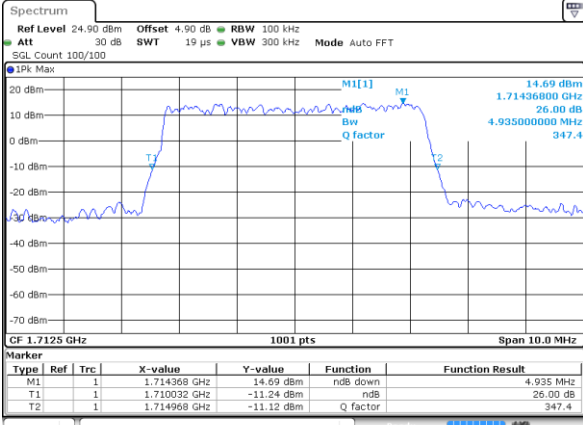

Date: 25 APR 2018 09:13:36

Lowest Channel / 5MHz / 16QAM

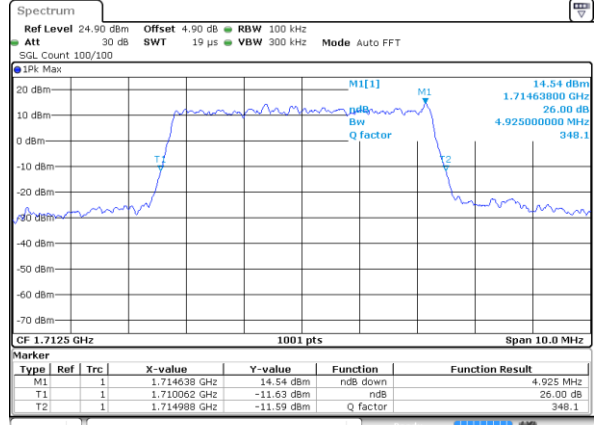

Date: 25 APR 2018 09:13:47

Middle Channel / 5MHz / QPSK

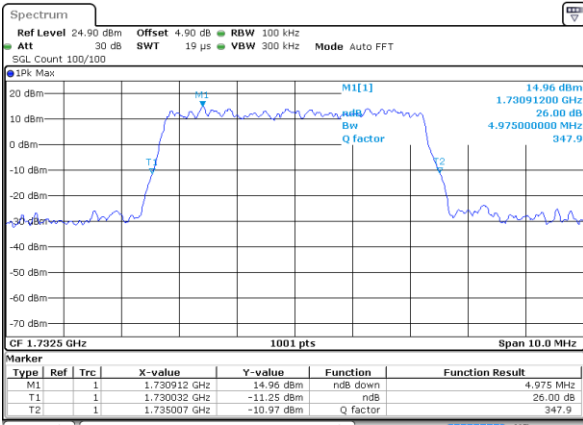

Date: 25 APR 2018 09:20:43

Middle Channel / 5MHz / 16QAM

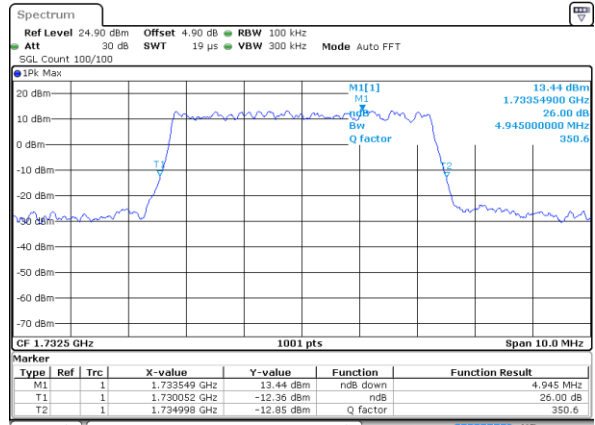

Date: 25 APR 2018 09:20:53

Highest Channel / 5MHz / QPSK

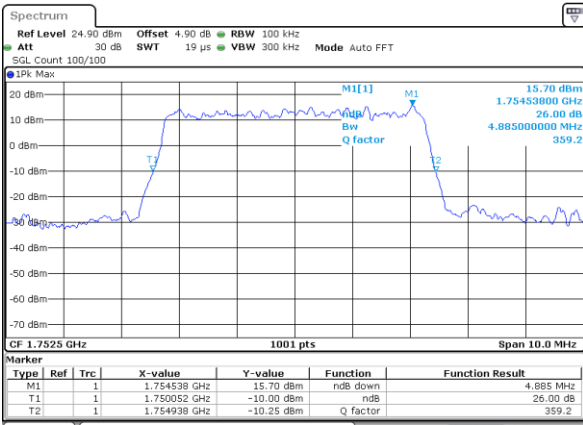

Date: 25 APR 2018 09:23:16

Highest Channel / 5MHz / 16QAM

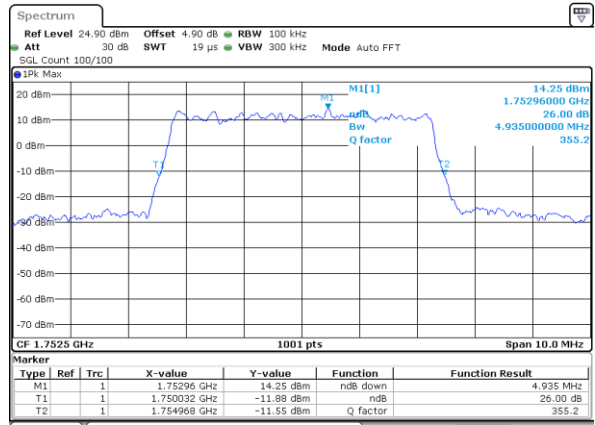

Date: 25 APR 2018 09:23:27





LTE Band 4

Lowest Channel / 10MHz / QPSK

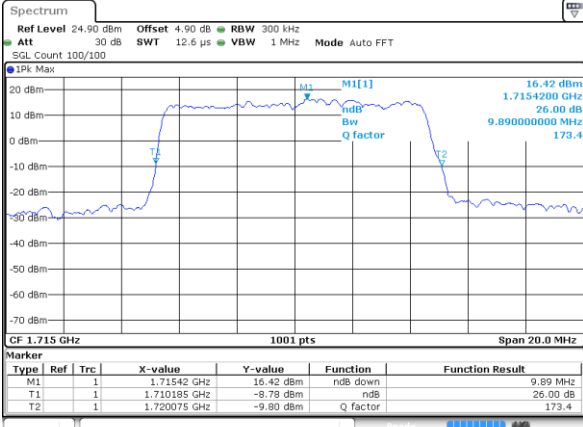

Date: 25 APR 2018 09:30:22

Lowest Channel / 10MHz / 16QAM

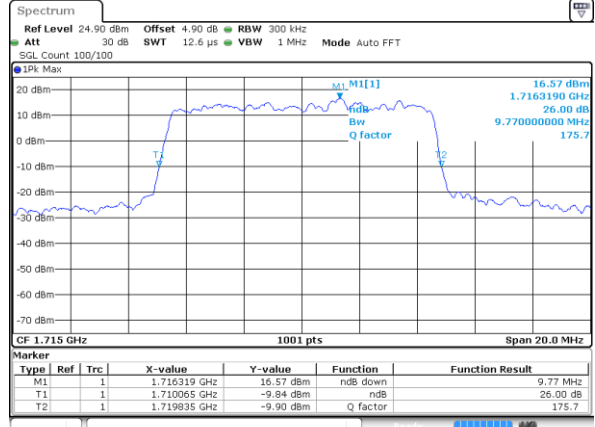

Date: 25 APR 2018 09:30:33

Middle Channel / 10MHz / QPSK

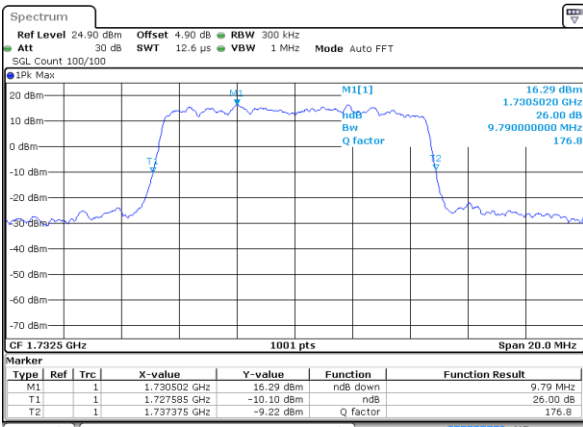

Date: 25 APR 2018 09:37:28

Middle Channel / 10MHz / 16QAM

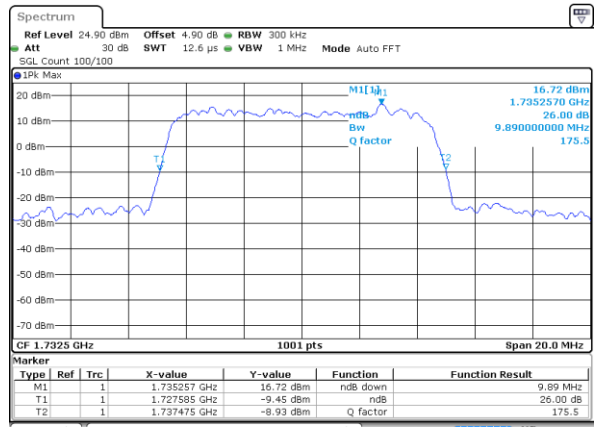

Date: 25 APR 2018 09:37:38

Highest Channel / 10MHz / QPSK

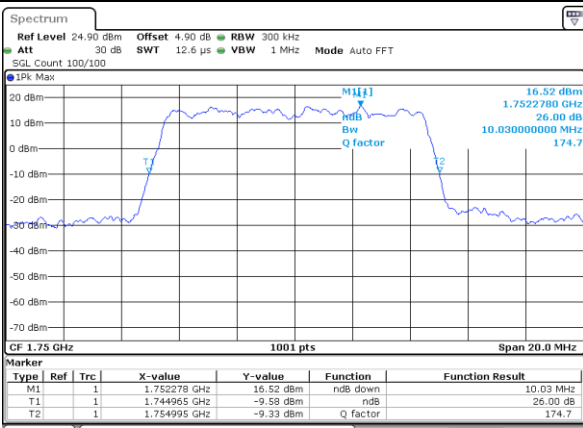

Date: 25 APR 2018 09:40:01

Highest Channel / 10MHz / 16QAM

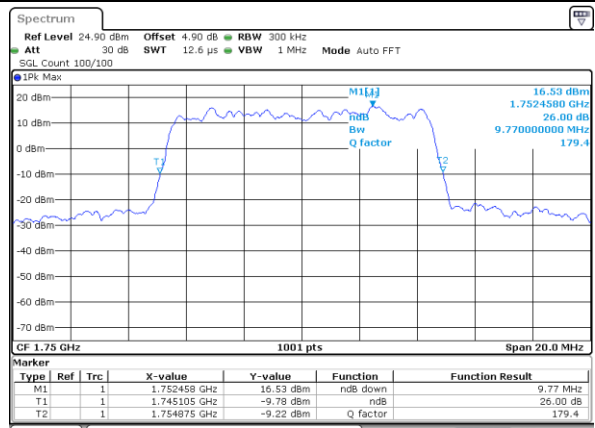

Date: 25 APR 2018 09:40:12