



# FCC RF Test Report

**APPLICANT** : Motorola Mobility LLC  
**EQUIPMENT** : Mobile Cellular Phone  
**BRAND NAME** : Motorola  
**MODEL NAME** : XT1922-5, XT1922-4  
**FCC ID** : IHDT56XB5  
**STANDARD** : FCC Part 15 Subpart C §15.247  
**CLASSIFICATION** : (DTS) Digital Transmission System

The product was received on Dec. 05, 2017 and testing was completed on Dec. 16, 2017. We, Sporton International (Kunshan) Inc., would like to declare that the tested sample has been evaluated in accordance with the test procedures and has been in compliance with the applicable technical standards.

The test results in this report apply exclusively to the tested model / sample. Without written approval of Sporton International (Kunshan) Inc., the test report shall not be reproduced except in full.



Approved by: James Huang / Manager

**Sporton International (Kunshan) Inc.**

**No.3-2 Ping-Xiang Rd, Kunshan Development Zone Kunshan City Jiangsu Province 215335  
China**



# TABLE OF CONTENTS

**SUMMARY OF TEST RESULT ..... 4**

**1 GENERAL DESCRIPTION..... 5**

1.1 Applicant ..... 5

1.2 Manufacturer ..... 5

1.3 Product Feature of Equipment Under Test..... 5

1.4 Product Specification of Equipment Under Test..... 6

1.5 Modification of EUT ..... 6

1.6 Testing Location ..... 6

1.7 Specification of Accessory..... 7

1.8 Applicable Standards..... 8

**2 TEST CONFIGURATION OF EQUIPMENT UNDER TEST..... 9**

2.1 Descriptions of Test Mode ..... 9

2.2 Test Mode ..... 10

2.3 Connection Diagram of Test System ..... 11

2.4 Support Unit used in test configuration and system ..... 12

2.5 EUT Operation Test Setup ..... 12

2.6 Measurement Results Explanation Example..... 12

**3 TEST RESULT ..... 13**

3.1 6dB Bandwidth Measurement ..... 13

3.2 Peak Output Power Measurement ..... 16

3.3 Power Spectral Density Measurement ..... 17

3.4 Conducted Band Edges and Spurious Emission Measurement ..... 22

3.5 Radiated Band Edges and Spurious Emission Measurement ..... 27

3.6 AC Conducted Emission Measurement..... 31

3.7 Antenna Requirements ..... 35

**4 LIST OF MEASURING EQUIPMENT ..... 36**

**5 UNCERTAINTY OF EVALUATION..... 37**

**APPENDIX A. CONDUCTED TEST RESULTS**

**APPENDIX B. RADIATED SPURIOUS EMISSION**

**APPENDIX C. DUTY CYCLE PLOTS**

**APPENDIX D. SETUP PHOTOGRAPHS**





### SUMMARY OF TEST RESULT

Report Section	FCC Rule	Description	Limit	Result	Remark
3.1	15.247(a)(2)	6dB Bandwidth	$\geq 0.5\text{MHz}$	Pass	-
3.2	15.247(b)(3)	Peak Output Power	$\leq 30\text{dBm}$	Pass	-
3.3	15.247(e)	Power Spectral Density	$\leq 8\text{dBm}/3\text{kHz}$	Pass	-
3.4	15.247(d)	Conducted Band Edges and Spurious Emission	$\leq 20\text{dBc}$	Pass	-
3.5	15.247(d)	Radiated Band Edges and Spurious Emission	15.209(a) & 15.247(d)	Pass	Under limit 5.94 dB at 2494.900 MHz
3.6	15.207	AC Conducted Emission	15.207(a)	Pass	Under limit 7.36 dB at 0.155 MHz
3.7	15.203 & 15.247(b)	Antenna Requirement	N/A	Pass	-



# 1 General Description

## 1.1 Applicant

Motorola Mobility LLC  
222 W,Merchandise Mart Plaza, Chicago IL 60654 USA

## 1.2 Manufacturer

Motorola Mobility LLC  
222 W,Merchandise Mart Plaza, Chicago IL 60654 USA

## 1.3 Product Feature of Equipment Under Test

Product Feature	
Equipment	Mobile Cellular Phone
Brand Name	Motorola
Model Name	XT1922-5, XT1922-4
FCC ID	IHDT56XB5
EUT supports Radios application	GSM/GPRS/EGPRS/WCDMA/HSPA/DC-HSDPA/ HSPA+(16QAM uplink is not supported)/LTE WLAN 2.4GHz 802.11b/g/n HT20 Bluetooth v3.0+EDR/ Bluetooth v4.0 LE/ Bluetooth v4.1 LE/ Bluetooth v4.2 LE
IMEI Code	Conducted : N/A Conduction: 351842090038191/351842090038209 Radiation: 351842090040031/351842090040049
HW Version	DVT1B
SW Version	fastboot_aljeter_oem_userdebug_8.0.0_OPP27.38_1080_in tcfg-test-keys
EUT Stage	Identical Prototype

**Remark:**

1. The above EUT's information was declared by manufacturer. Please refer to the specifications or user's manual for more detailed description.
2. There are two types of EUT sample 1 and sample 2, the differences between two samples are only for SIM slot, sample 1(model name XT1922-5) is dual SIM slot, sample 2(model name XT1922-4) is single SIM slot. According to the difference, only sample 1 need to perform full test.



### 1.4 Product Specification of Equipment Under Test

Standards-related Product Specification	
Tx/Rx Frequency Range	2402 MHz ~ 2480 MHz
Number of Channels	40
Carrier Frequency of Each Channel	40 Channel(37 hopping + 3 advertising channel)
Maximum Output Power to Antenna	1.89 dBm (0.0015 W)
Antenna Type / Gain	Monopole Antenna with gain -1.35 dBi
Type of Modulation	Bluetooth LE : GFSK

### 1.5 Modification of EUT

No modifications are made to the EUT during all test items.

### 1.6 Testing Location

Sporton International (Kunshan) Inc. is accredited to ISO 17025 by National Voluntary Laboratory Accreditation Program (NVLAP code: 600155-0) and the FCC designation No. is CN5013.

Test Site	Sporton International (Kunshan) Inc.			
Test Site Location	No.3-2 Ping-Xiang Rd, Kunshan Development Zone Kunshan City Jiangsu Province 215335 China TEL : +86-512-57900158 FAX : +86-512-57900958			
Test Site No.	Sporton Site No.			FCC Test Firm Registration No.
	TH01-KS	03CH03-KS	CO01-KS	630927

**Note:** The test site complies with ANSI C63.4 2014 requirement.



### 1.7 Specification of Accessory

Specification of Accessory			
AC Adapter 1(US)	Brand Name	Motorola (Salom)	Model Name SC-22 SPN5970A
	Power Rating	I/P: 100-240 Vac, 500mA, O/P: 5Vdc,3000mA or 9Vdc,1600mA or 12Vdc,1200mA	
AC Adapter 1(EU)	Brand Name	Motorola (Salom)	Model Name SC-23 SPN5971A
	Power Rating	I/P: 100-240 Vac, 500mA, O/P: 5Vdc,3000mA or 9Vdc,1600mA or 12Vdc,1200mA	
AC Adapter 1(UK)	Brand Name	Motorola (Salom)	Model Name SC-24 SPN5972A
	Power Rating	I/P: 100-240 Vac, 500mA, O/P: 5Vdc,3000mA or 9Vdc,1600mA or 12Vdc,1200mA	
AC Adapter 1(IN)	Brand Name	Motorola (Salom)	Model Name SC-25 SPN5973A
	Power Rating	I/P: 100-240 Vac, 500mA, O/P: 5Vdc,3000mA or 9Vdc,1600mA or 12Vdc,1200mA	
AC Adapter 1(AU)	Brand Name	Motorola (Salom)	Model Name SC-26 SPN5974A
	Power Rating	I/P: 100-240 Vac, 500mA, O/P: 5Vdc,3000mA or 9Vdc,1600mA or 12Vdc,1200mA	
AC Adapter 1(AR)	Brand Name	Motorola (Salom)	Model Name SC-27 SPN5975A
	Power Rating	I/P: 100-240 Vac, 500mA, O/P: 5Vdc,3000mA or 9Vdc,1600mA or 12Vdc,1200mA	
AC Adapter 1(BR)	Brand Name	Motorola (Salom)	Model Name SC-28 SPN5976A
	Power Rating	I/P: 100-240 Vac, 500mA, O/P: 5Vdc,3000mA or 9Vdc,1600mA or 12Vdc,1200mA	
AC Adapter 1(BR)	Brand Name	Motorola (Salom)	Model Name SC-28 SPN5997A
	Power Rating	I/P: 100-240 Vac, 500mA, O/P: 5Vdc,3000mA or 9Vdc,1600mA or 12Vdc,1200mA	
AC Adapter 2(US)	Brand Name	Motorola (Chenyang)	Model Name SC-22 SPN5993A
	Power Rating	I/P: 100-240 Vac, 500mA, O/P: 5Vdc,3000mA or 9Vdc,1600mA or 12Vdc,1200mA	
AC Adapter 2(EU)	Brand Name	Motorola (Chenyang)	Model Name SC-23 SPN5989A
	Power Rating	I/P: 100-240 Vac, 500mA, O/P: 5Vdc,3000mA or 9Vdc,1600mA or 12Vdc,1200mA	
AC Adapter 2(UK)	Brand Name	Motorola (Chenyang)	Model Name SC-24 SPN5990A
	Power Rating	I/P: 100-240 Vac, 500mA, O/P: 5Vdc,3000mA or 9Vdc,1600mA or 12Vdc,1200mA	
AC Adapter 2(IN)	Brand Name	Motorola (Chenyang)	Model Name SC-25 SPN5991A
	Power Rating	I/P: 100-240 Vac, 500mA, O/P: 5Vdc,3000mA or 9Vdc,1600mA or 12Vdc,1200mA	
AC Adapter 2(AU)	Brand Name	Motorola (Chenyang)	Model Name SC-26 SPN5988A
	Power Rating	I/P: 100-240 Vac, 500mA, O/P: 5Vdc,3000mA or 9Vdc,1600mA or 12Vdc,1200mA	
AC Adapter 2(AR)	Brand Name	Motorola (Chenyang)	Model Name SC-27 SPN5992A
	Power Rating	I/P: 100-240 Vac, 500mA, O/P: 5Vdc,3000mA or 9Vdc,1600mA or 12Vdc,1200mA	



AC Adapter 3(BR)	Brand Name	Motorola (Cliptech)	Model Name	SC-28 SPN5998A
	Power Rating	I/P: 100-240 Vac, 500mA, O/P: 5Vdc,3000mA or 9Vdc,1600mA or 12Vdc,1200mA		
Battery	Brand Name	Lenovo (SCUD)	Model Name	BL270
	Power Rating	3.85/4.4Vdc,4000mAh	Type	Li-ion
Earphone	Brand Name	Motorola(NEW LEADER)	Model Name	NLD-EM307E-02SF
	Signal Line Type	1.2 meter, non-shielded cable, without ferrite core		
USB Cable	Brand Name	Motorola (Saibao)	Model Name	SLQ-A077A
	Signal Line Type	1.0 meter, shielded cable, without ferrite core		

### 1.8 Applicable Standards

According to the specifications of the manufacturer, the EUT must comply with the requirements of the following standards:

- FCC Part 15 Subpart C §15.247
- FCC KDB Publication No. 558074 D01 DTS Meas. Guidance v04
- ANSI C63.10-2013

**Remark:**

1. All test items were verified and recorded according to the standards and without any deviation during the test.
2. This EUT has also been tested and complied with the requirements of FCC Part 15, Subpart B, recorded in a separate test report.





## 2 Test Configuration of Equipment Under Test

### 2.1 Descriptions of Test Mode

The RF output power was recorded in the following table:

Channel	Frequency	Bluetooth – LE RF Output Power	
		Data Rate / Modulation	
		GFSK	
		1Mbps	
Ch00	2402MHz	0.66 dBm	
Ch19	2440MHz	1.89 dBm	
Ch39	2480MHz	0.74 dBm	

- a. The EUT has been associated with peripherals and configuration operated in a manner tended to maximize its emission characteristics in a typical application. Frequency range investigated: conduction (150 kHz to 30 MHz), radiation (9 kHz to the 10th harmonic of the highest fundamental frequency or to 40 GHz, whichever is lower). Pre-scanned tests, X, Y, Z in three orthogonal panels to determine the final configuration (Y plane as worst plane) from all possible combinations.
  
- b. AC power line Conducted Emission was tested under maximum output power.



## 2.2 Test Mode

The following summary table is showing all test modes to demonstrate in compliance with the standard.

Summary table of Test Cases	
Test Item	Data Rate / Modulation
	Bluetooth – LE / GFSK
<b>Conducted TCs</b>	Mode 1: Bluetooth Tx CH00_2402 MHz_1Mbps Mode 2: Bluetooth Tx CH19_2440 MHz_1Mbps Mode 3: Bluetooth Tx CH39_2480 MHz_1Mbps
<b>Radiated TCs</b>	Mode 1: Bluetooth Tx CH00_2402 MHz_1Mbps Mode 2: Bluetooth Tx CH19_2440 MHz_1Mbps Mode 3: Bluetooth Tx CH39_2480 MHz_1Mbps
<b>AC Conducted Emission</b>	Mode 1 : GSM 850 Idle + Bluetooth Link + WLAN Link (2.4G) + USB Cable (Charging from Adapter1) + Earphone for Sample 1 Mode 2 : GSM 850 Idle + Bluetooth Link + WLAN Link (2.4G) + USB Cable (Charging from Adapter2) + Earphone for Sample 1
<b>Remark:</b>	
1. The worst case of conducted emission is mode 2; only the test data of it was reported.	
2. For Radiated Test Cases, The tests were performed with Adapter 1, Earphone, and USB Cable.	

## 2.3 Connection Diagram of Test System

### <Bluetooth – LE Tx Mode>

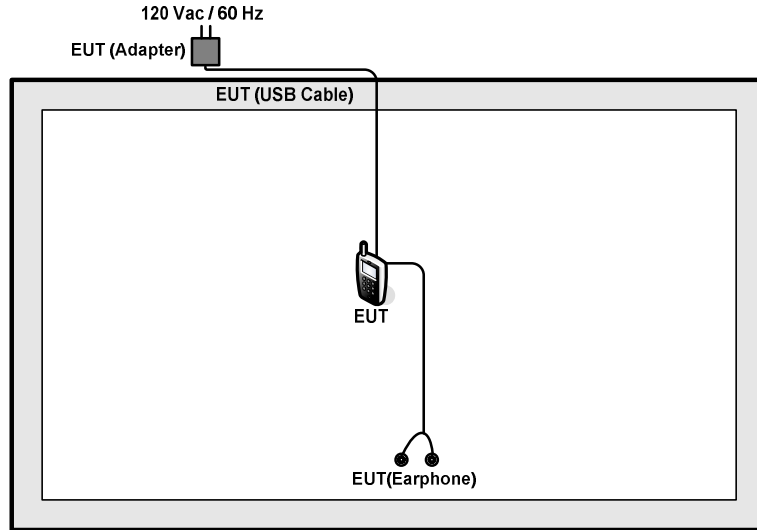

### <AC Conducted Emission Mode>

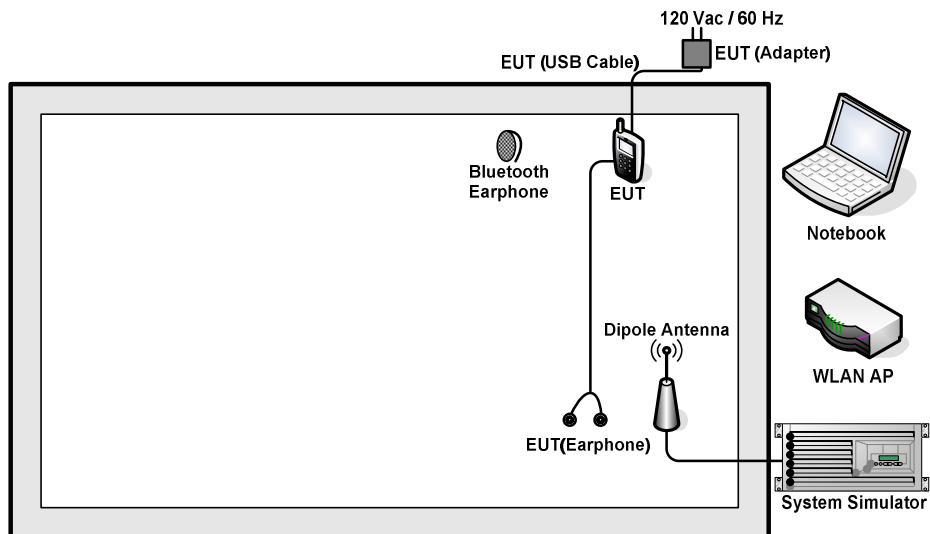

## 2.4 Support Unit used in test configuration and system

Item	Equipment	Trade Name	Model Name	FCC ID	Data Cable	Power Cord
1.	System Simulator	Anritsu	MT8820C	N/A	N/A	Unshielded, 1.8m
2.	WLAN AP	D-Link	DIR-855	KA2DIR855A2	N/A	Unshielded, 1.8 m
3.	Notebook	Lenovo	G480	N/A	N/A	Shielded cable DC O/P 1.8 m Unshielded AC I/P cable 1.2 m
4.	Bluetooth Earphone	Lenovo	LBH308	NA	N/A	N/A

## 2.5 EUT Operation Test Setup

For Bluetooth LE function, the engineering test program was provided and enabled to make EUT continuous transmit/receive.

For AC power line conducted emissions, the EUT was set to connect with the WLAN AP under large package sizes transmission.

## 2.6 Measurement Results Explanation Example

**For all conducted test items:**

The offset level is set in the spectrum analyzer to compensate the RF cable loss between EUT conducted output port and spectrum analyzer. With the offset compensation, the spectrum analyzer reading level is exactly the EUT RF output level.

Example :

The spectrum analyzer offset is derived from RF cable loss.

*Offset = RF cable loss*

Following shows an offset computation example with cable loss 5.5 dB.

$$\begin{aligned} \text{Offset(dB)} &= \text{RF cable loss(dB)}. \\ &= 5.5 \text{ (dB)} \end{aligned}$$

### 3 Test Result

#### 3.1 6dB Bandwidth Measurement

##### 3.1.1 Limit of 6dB Bandwidth

The minimum 6 dB bandwidth shall be at least 500 kHz.

##### 3.1.2 Measuring Instruments

The section 4.0 of List of Measuring Equipment of this test report is used for test.

##### 3.1.3 Test Procedures

1. The testing follows FCC KDB Publication No. 558074 D01 DTS Meas. Guidance v04.
2. The RF output of EUT was connected to the spectrum analyzer by RF cable and attenuator. The path loss was compensated to the results for each measurement.
3. Set to the maximum power setting and enable the EUT transmit continuously.
4. Make the measurement with the spectrum analyzer's resolution bandwidth (RBW) = 100 kHz. Set the Video bandwidth (VBW) = 300 kHz. In order to make an accurate measurement. The 6 dB bandwidth must be greater than 500 kHz.
5. Measure and record the results in the test report.

##### 3.1.4 Test Setup





### 3.1.5 Test Result of 6dB Bandwidth

Test data refer to Appendix A.

#### 6 dB Bandwidth Plot on Channel 00

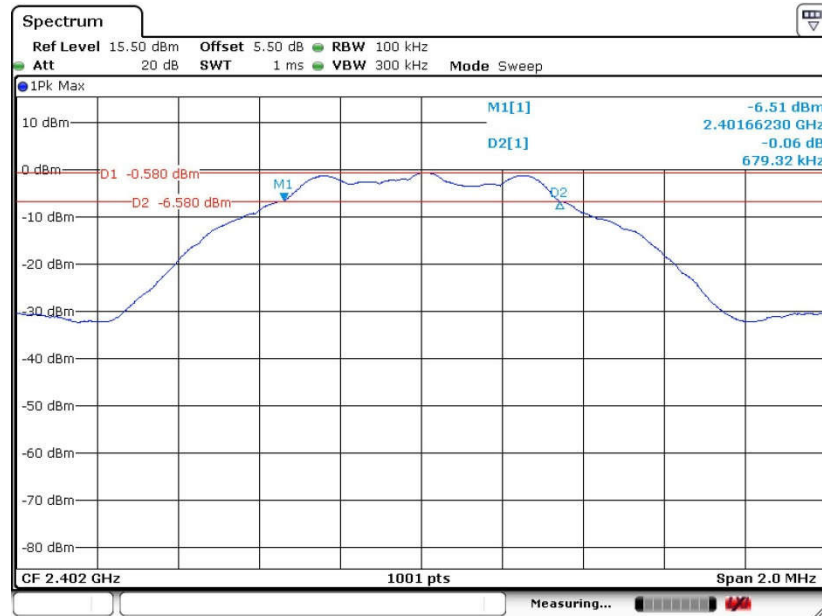

#### 6 dB Bandwidth Plot on Channel 19

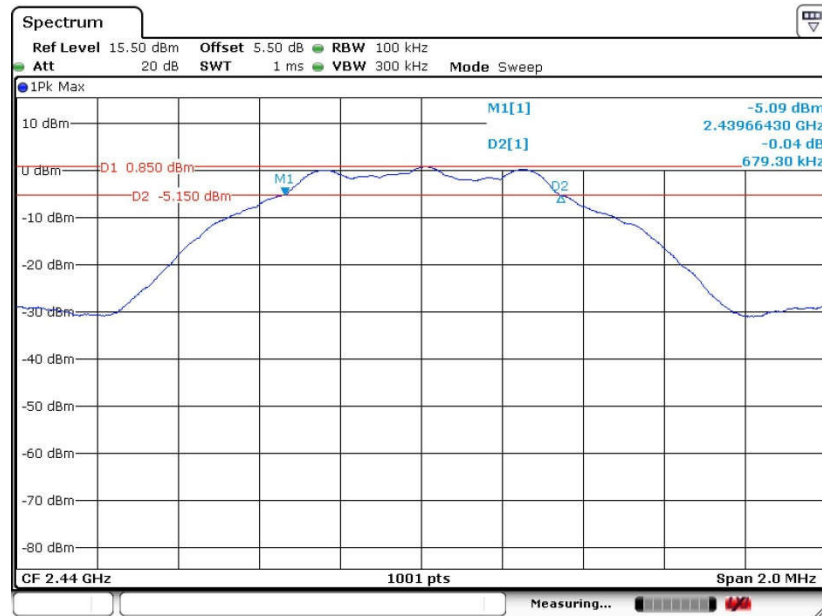



6 dB Bandwidth Plot on Channel 39

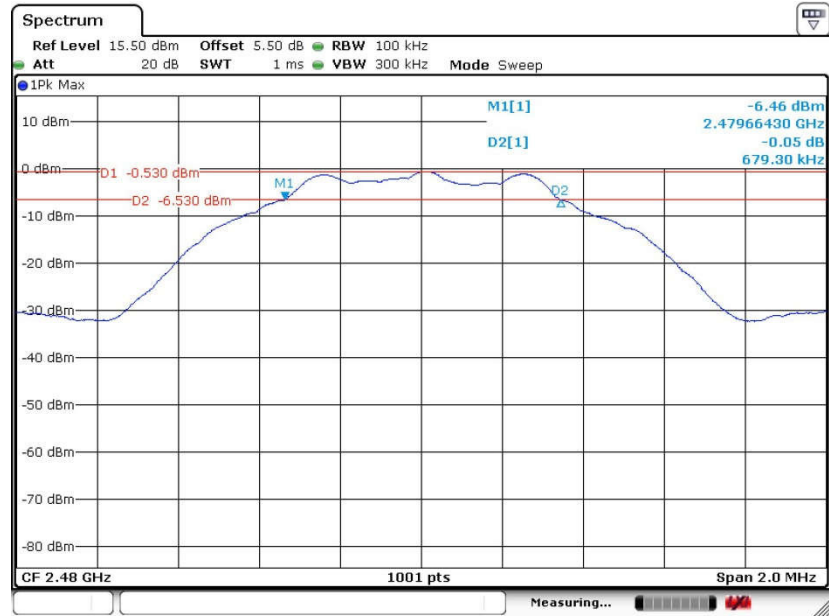

Date: 7.DEC.2017 18:45:07

## 3.2 Peak Output Power Measurement

### 3.2.1 Limit of Peak Output Power

For systems using digital modulation in the 2400-2483.5MHz, the limit for peak output power is 30dBm. If transmitting antenna of directional gain greater than 6dBi is used, the peak output power from the intentional radiator shall be reduced below the above stated value by the amount in dB that the directional gain of the antenna exceeds 6 dBi. In case of point-to-point operation, the limit has to be reduced by 1dB for every 3dB that the directional gain of the antenna exceeds 6dBi.

### 3.2.2 Measuring Instruments

The section 4.0 of List of Measuring Equipment of this test report is used for test.

### 3.2.3 Test Procedures

1. The testing follows the Measurement Procedure of FCC KDB No. 558074 DTS D01 Meas. Guidance v04 section 9.1.2 PKPM1 Peak power meter method.
2. The RF output of EUT was connected to the power meter by RF cable and attenuator. The path loss was compensated to the results for each measurement.
3. Set to the maximum power setting and enable the EUT transmit continuously.
4. Measure the conducted output power and record the results in the test report.

### 3.2.4 Test Setup

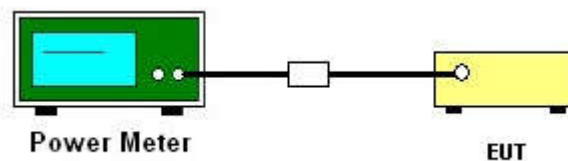

### 3.2.5 Test Result of Peak Output Power

Test data refers to Appendix A.



### 3.3 Power Spectral Density Measurement

#### 3.3.1 Limit of Power Spectral Density

The peak power spectral density shall not be greater than 8dBm in any 3kHz band at any time interval of continuous transmission.

#### 3.3.2 Measuring Instruments

The section 4.0 of List of Measuring Equipment of this test report is used for test.

#### 3.3.3 Test Procedures

1. The testing follows Measurement Procedure 10.2 Method PKPSD of FCC KDB Publication No. 558074 D01 DTS Meas. Guidance v04
2. The RF output of EUT was connected to the spectrum analyzer by RF cable and attenuator. The path loss was compensated to the results for each measurement.
3. Set to the maximum power setting and enable the EUT transmit continuously.
4. Make the measurement with the spectrum analyzer's resolution bandwidth (RBW) = 3 kHz. Video bandwidth VBW = 10 kHz In order to make an accurate measurement, set the span to 1.5 times DTS Channel Bandwidth. (6dB BW)
5. Detector = peak, Sweep time = auto couple, Trace mode = max hold, Allow trace to fully stabilize. Use the peak marker function to determine the maximum power level.
6. Measure and record the results in the test report.
7. The Measured power density (dBm)/ 100kHz is a reference level and used as 20dBc down limit line for Conducted Band Edges and Conducted Spurious Emission.

#### 3.3.4 Test Setup

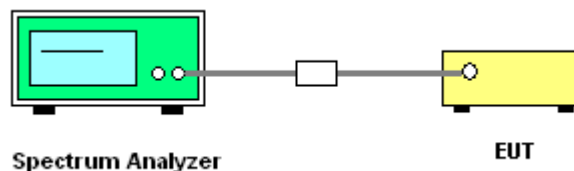



### 3.3.5 Test Result of Power Spectral Density

Test data refers to Appendix A.

### 3.3.6 Test Result of Power Spectral Density Plots (100kHz)

PSD 100kHz Plot on Channel 00

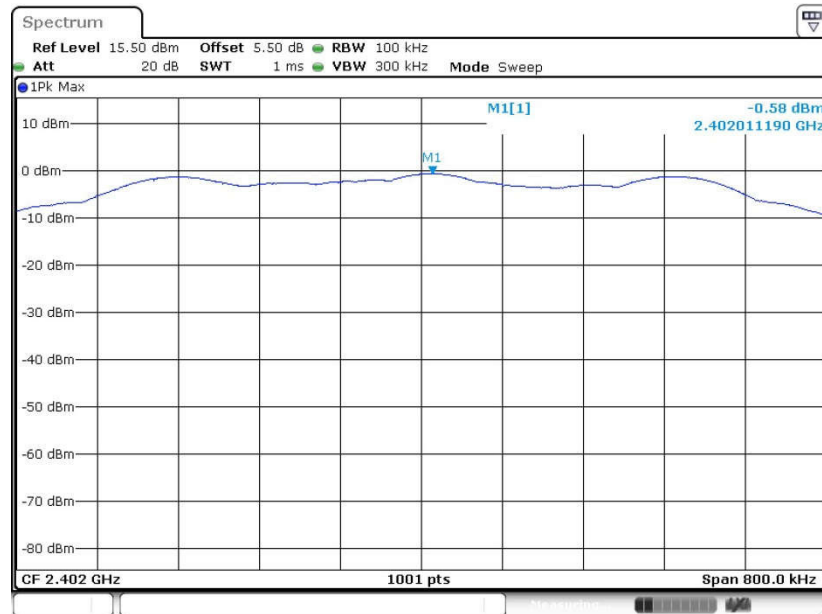

Date: 7.DEC.2017 18:35:31



PSD 100kHz Plot on Channel 19

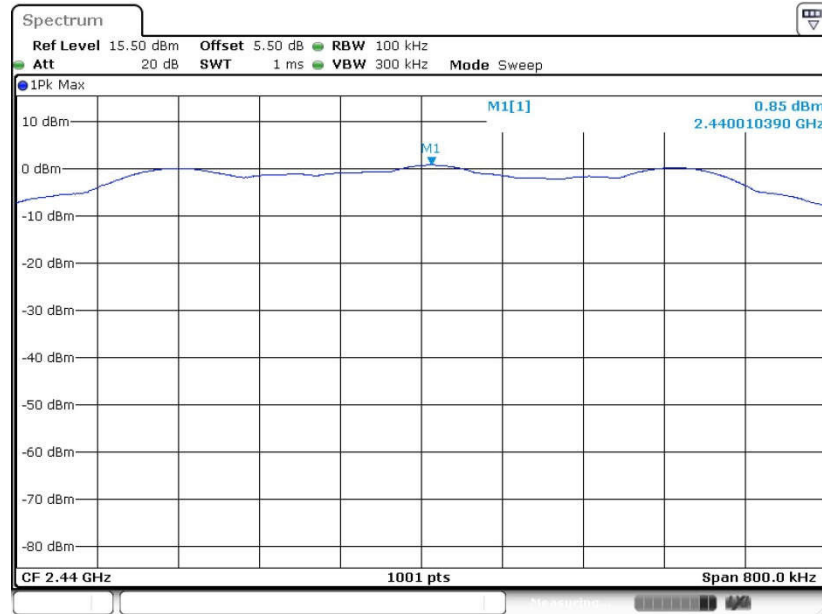

Date: 7.DEC.2017 18:40:45

PSD 100kHz Plot on Channel 39

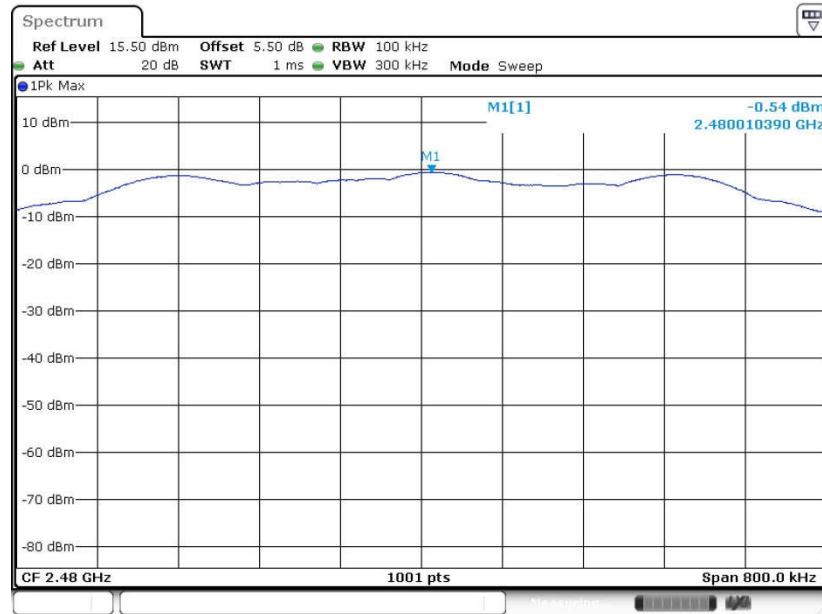

Date: 7.DEC.2017 18:45:39



### 3.3.7 Test Result of Power Spectral Density Plots (3kHz)

PSD 3kHz Plot on Channel 00

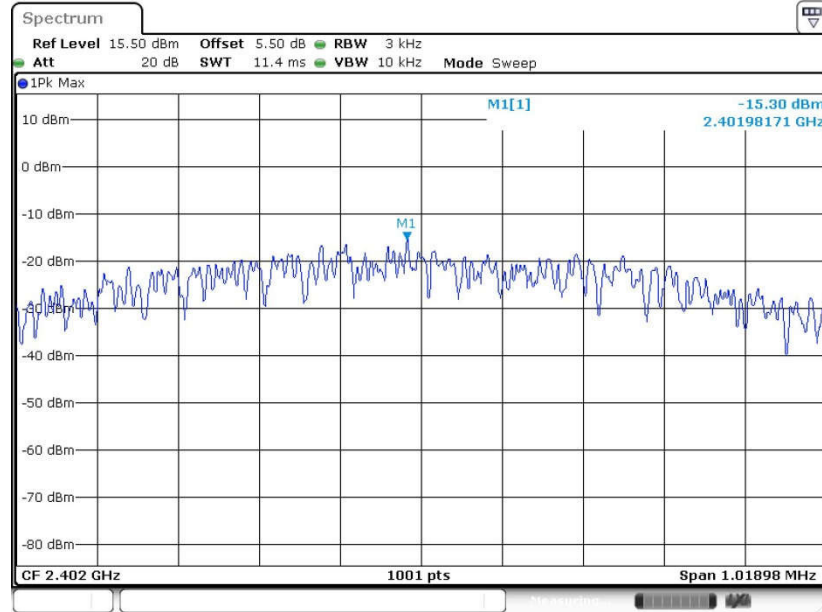

Date: 7.DEC.2017 18:35:16



PSD 3kHz Plot on Channel 19

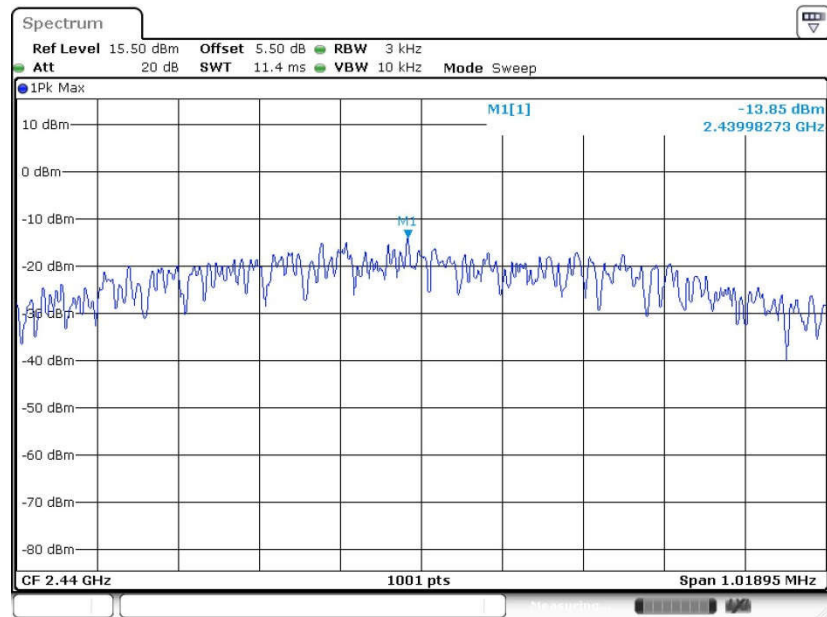

Date: 7.DEC.2017 18:40:20

PSD 3kHz Plot on Channel 39

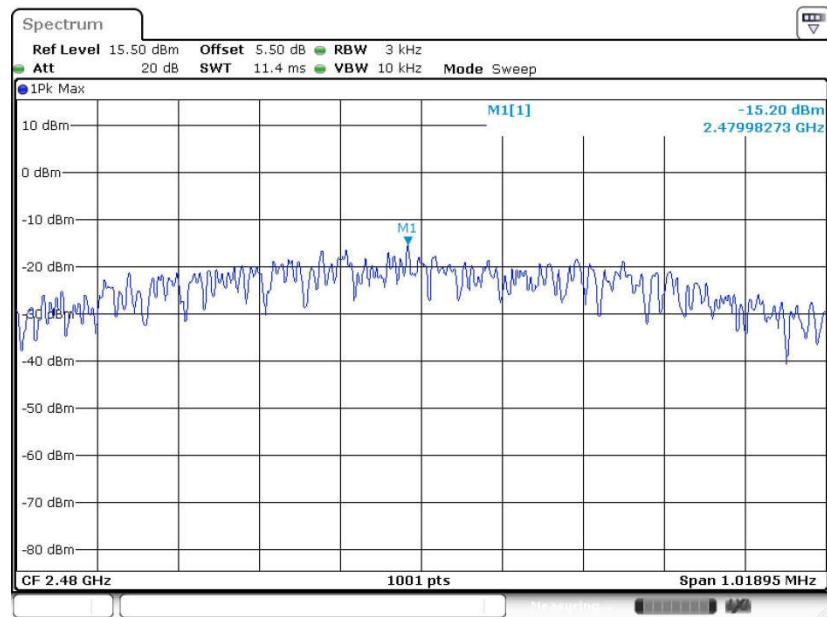

Date: 7.DEC.2017 18:45:27

## 3.4 Conducted Band Edges and Spurious Emission Measurement

### 3.4.1 Limit of Conducted Band Edges and Spurious Emission

All harmonics/spurious must be at least 20 dB down from the highest emission level within the authorized band.

### 3.4.2 Measuring Instruments

The section 4.0 of List of Measuring Equipment of this test report is used for test.

### 3.4.3 Test Procedure

1. The testing follows FCC KDB Publication No. 558074 D01 DTS Meas. Guidance v04.
2. The RF output of EUT was connected to the spectrum analyzer by RF cable and attenuator. The path loss was compensated to the results for each measurement.
3. Set to the maximum power setting and enable the EUT transmit continuously.
4. Set RBW = 100 kHz, VBW=300 kHz, Peak Detector. Unwanted Emissions measured in any 100 kHz bandwidth outside of the authorized frequency band shall be attenuated by at least 20 dB relative to the maximum in-band peak PSD level in 100 kHz when maximum peak conducted output power procedure is used. If the transmitter complies with the conducted power limits based on the use of RMS averaging over a time interval, the attenuation required under this paragraph shall be 30 dB instead of 20 dB.
5. Measure and record the results in the test report.
6. The RF fundamental frequency should be excluded against the limit line in the operating frequency band.

### 3.4.4 Test Setup

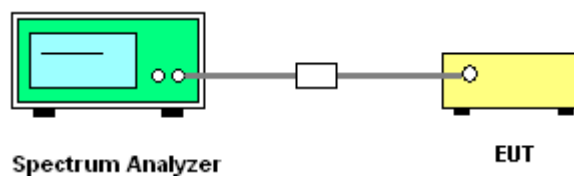



### 3.4.5 Test Result of Conducted Band Edges Plots

Low Band Edge Plot on Channel 00

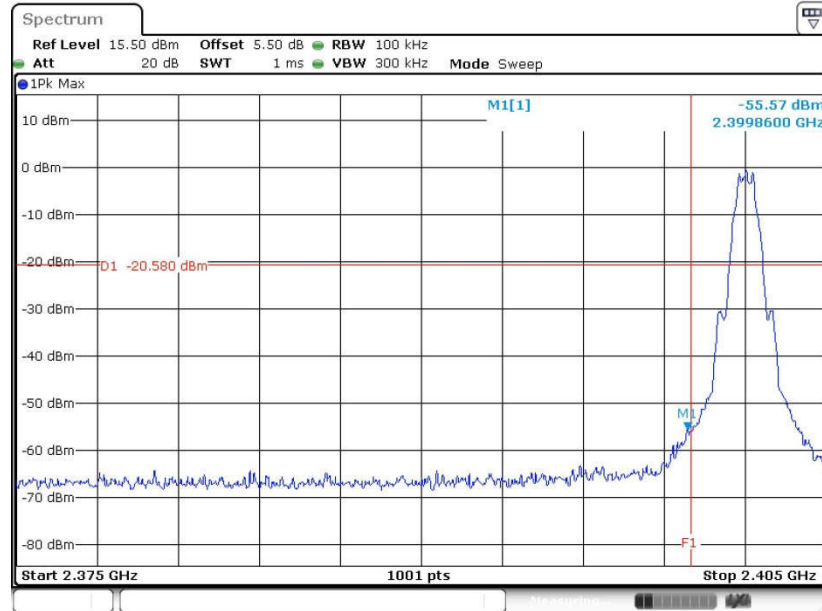

Date: 7.DEC.2017 18:35:57

High Band Edge Plot on Channel 39

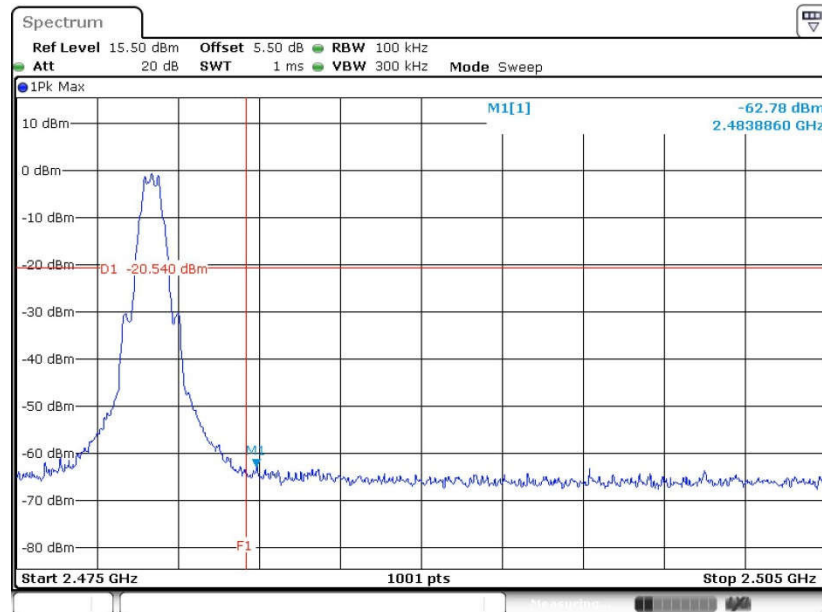

Date: 7.DEC.2017 18:45:53



### 3.4.6 Test Result of Conducted Spurious Emission Plots

#### Conducted Spurious Emission Plot on Bluetooth LE 1Mbps GFSK Channel 00

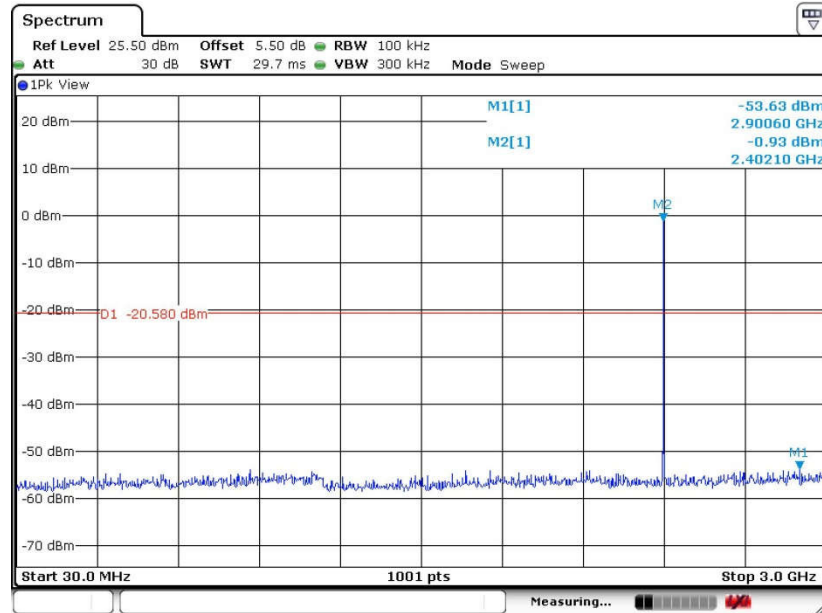

Date: 7.DEC.2017 18:37:51

#### Conducted Spurious Emission Plot on Bluetooth LE 1Mbps GFSK Channel 00

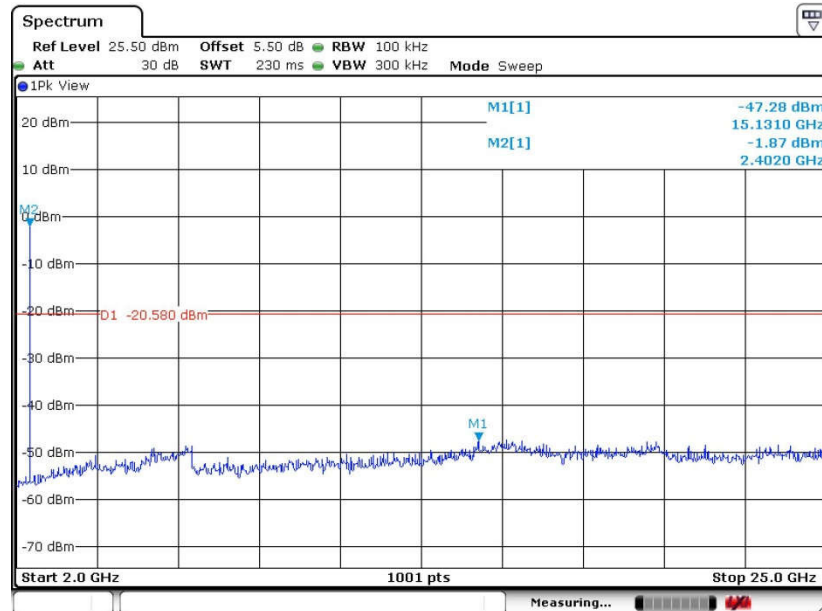

Date: 7.DEC.2017 18:49:50





Conducted Spurious Emission Plot on Bluetooth LE 1Mbps  
GFSK Channel 19

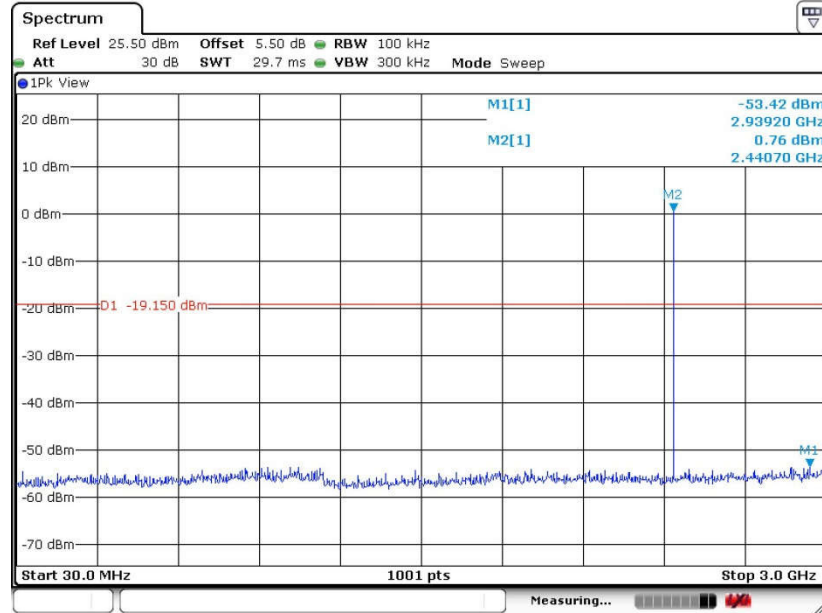

Date: 7.DEC.2017 18:42:40

Conducted Spurious Emission Plot on Bluetooth LE 1Mbps  
GFSK Channel 19

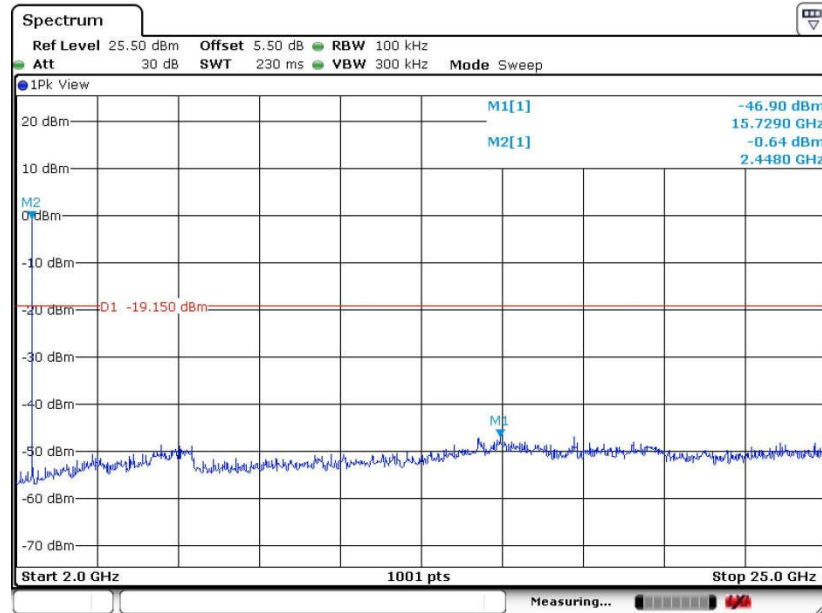

Date: 7.DEC.2017 18:41:30



Conducted Spurious Emission Plot on Bluetooth LE 1Mbps GFSK Channel 39

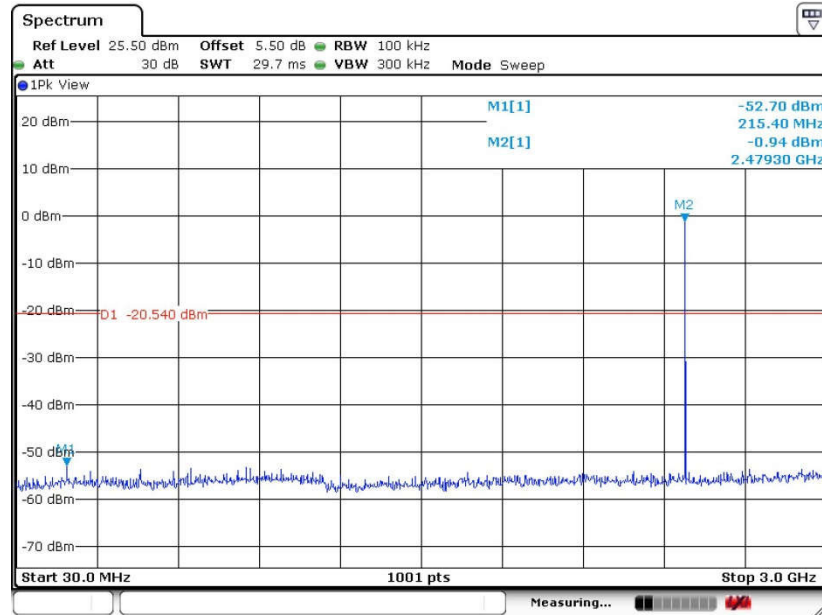

Date: 7.DEC.2017 18:47:14

Conducted Spurious Emission Plot on Bluetooth LE 1Mbps GFSK Channel 39

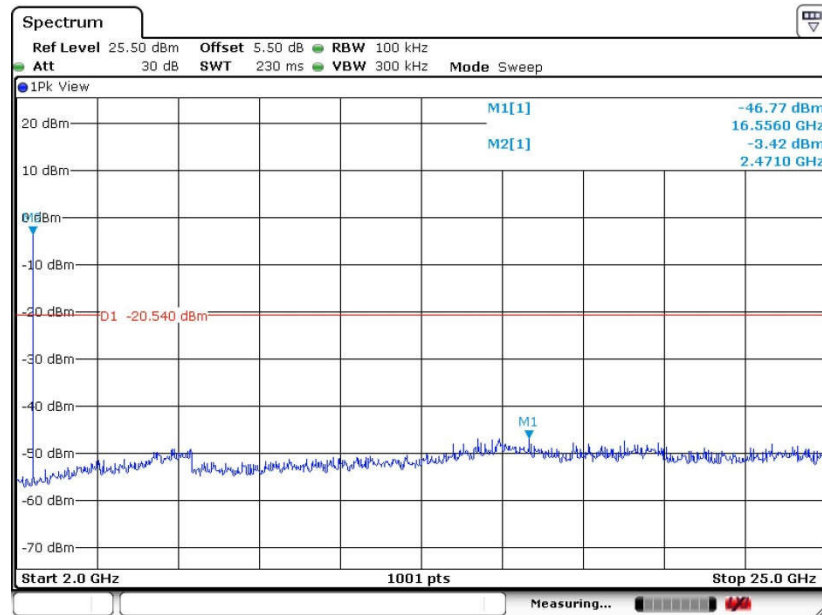

Date: 7.DEC.2017 18:46:38



### 3.5 Radiated Band Edges and Spurious Emission Measurement

#### 3.5.1 Limit of Radiated Band Edges and Spurious Emission

In any 100 kHz bandwidth outside the intentional radiator frequency band, all harmonics/spurious must be at least 20 dB below the highest emission level within the authorized band. If the output power of this device was measured by spectrum analyzer, the attenuation under this paragraph shall be 30 dB instead of 20 dB. In addition, radiated emissions which fall in the restricted bands must also comply with the limits as below.

Frequency (MHz)	Field Strength (microvolts/meter)	Measurement Distance (meters)
0.009 – 0.490	2400/F(kHz)	300
0.490 – 1.705	24000/F(kHz)	30
1.705 – 30.0	30	30
30 – 88	100	3
88 – 216	150	3
216 - 960	200	3
Above 960	500	3

#### 3.5.2 Measuring Instruments

The section 4.0 of List of Measuring Equipment of this test report is used for test.



### 3.5.3 Test Procedures

1. The testing follows FCC KDB Publication No. 558074 D01 DTS Meas. Guidance v04.
2. The EUT was arranged to its worst case and then tune the antenna tower (from 1 m to 4 m) and turntable (from 0 degree to 360 degrees) to find the maximum reading. A pre-amp and a high pass filter are used for the test in order to get better signal level.
3. The EUT was placed on a turntable with 0.8 meter for frequency below 1GHz and 1.5 meter for frequency above 1GHz respectively above ground.
4. The EUT was set 3 meters from the interference receiving antenna, which was mounted on the top of a variable height antenna tower.
5. Corrected Reading: Antenna Factor + Cable Loss + Read Level - Preamp Factor = Level
6. For measurement below 1GHz, If the emission level of the EUT measured by the peak detector is 3 dB lower than the applicable limit, the peak emission level will be reported. Otherwise, the emission measurement will be repeated using the quasi-peak detector and reported.
7. Use the following spectrum analyzer settings:
  - (1) Span shall wide enough to fully capture the emission being measured;
  - (2) Set RBW=100 kHz for  $f < 1$  GHz; VBW  $\geq$  RBW; Sweep = auto; Detector function = peak; Trace = max hold;
  - (3) Set RBW = 1 MHz, VBW= 3MHz for  $f \geq 1$  GHz for peak measurement.

For average measurement:

    - VBW = 10 Hz, when duty cycle is no less than 98 percent.
    - VBW  $\geq 1/T$ , when duty cycle is less than 98 percent where T is the minimum transmission duration over which the transmitter is on and is transmitting at its maximum power control level for the tested mode of operation.

### 3.5.4 Test Setup

For radiated emissions below 30MHz

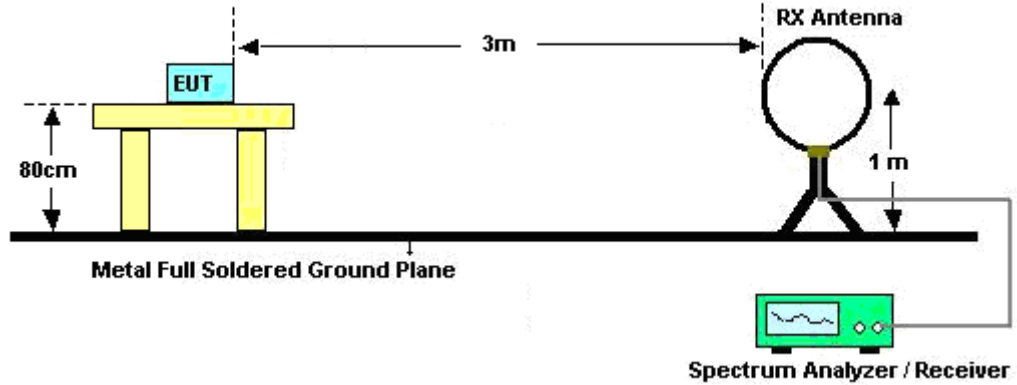

For radiated emissions from 30MHz to 1GHz

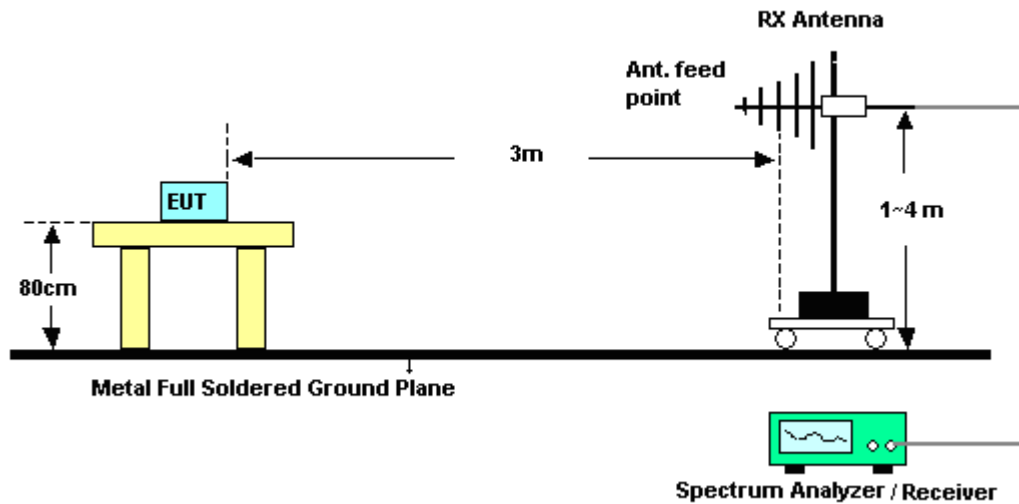

For radiated emissions above 1GHz

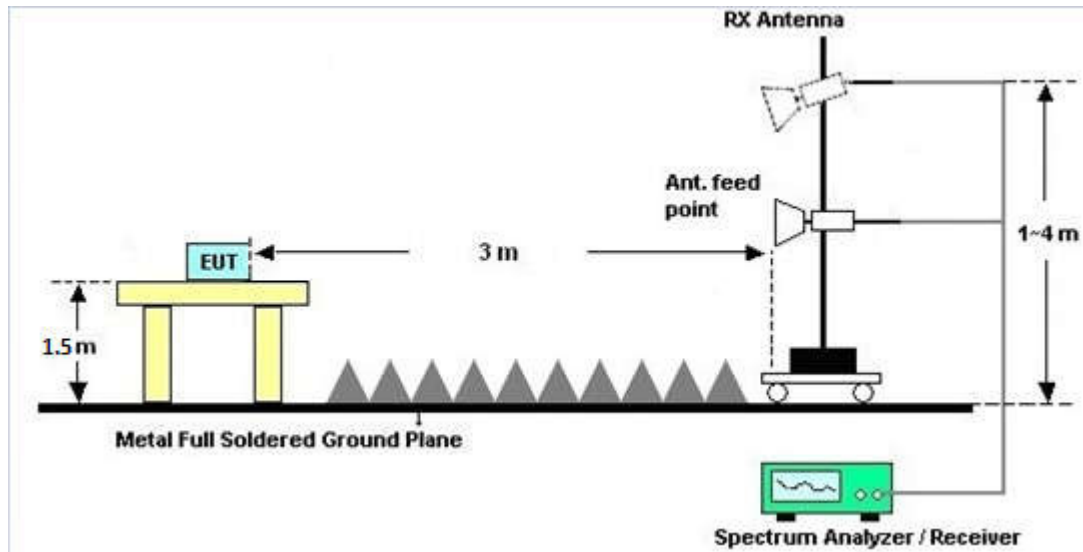

### 3.5.5 Test Results of Radiated Spurious Emissions (9 kHz ~ 30 MHz)

The low frequency, which started from 9 kHz to 30MHz, was pre-scanned and the result which was 20dB lower than the limit line was not reported.

### 3.5.6 Test Result of Radiated Spurious at Band Edges

Please refer to Appendix B.

### 3.5.7 Duty Cycle

Please refer to Appendix C.

### 3.5.8 Test Result of Radiated Spurious Emission (30MHz ~ 10th Harmonic)

Please refer to Appendix B.



### 3.6 AC Conducted Emission Measurement

#### 3.6.1 Limit of AC Conducted Emission

For equipment that is designed to be connected to the public utility (AC) power line, the radio frequency voltage that is conducted back onto the AC power line on any frequency or frequencies within the band 150 kHz to 30 MHz shall not exceed the limits in the following table.

Frequency of emission (MHz)	Conducted limit (dBµV)	
	Quasi-peak	Average
0.15-0.5	66 to 56*	56 to 46*
0.5-5	56	46
5-30	60	50

\*Decreases with the logarithm of the frequency.

#### 3.6.2 Measuring Instruments

The section 4.0 of List of Measuring Equipment of this test report is used for test.

#### 3.6.3 Test Procedures

1. The EUT was placed 0.4 meter from the conducting wall of the shielding room was kept at least 80 centimeters from any other grounded conducting surface.
2. Connect EUT to the power mains through a line impedance stabilization network (LISN).
3. All the support units are connecting to the other LISN.
4. The LISN provides 50 ohm coupling impedance for the measuring instrument.
5. The FCC states that a 50 ohm, 50 microhenry LISN should be used.
6. Both sides of AC line were checked for maximum conducted interference.
7. The frequency range from 150 kHz to 30 MHz was searched.
8. Set the test-receiver system to Peak Detect Function and specified bandwidth (IF Bandwidth = 9kHz) with Maximum Hold Mode. Then measurement is also conducted by Average Detector and Quasi-Peak Detector Function respectively.

### 3.6.4 Test Setup

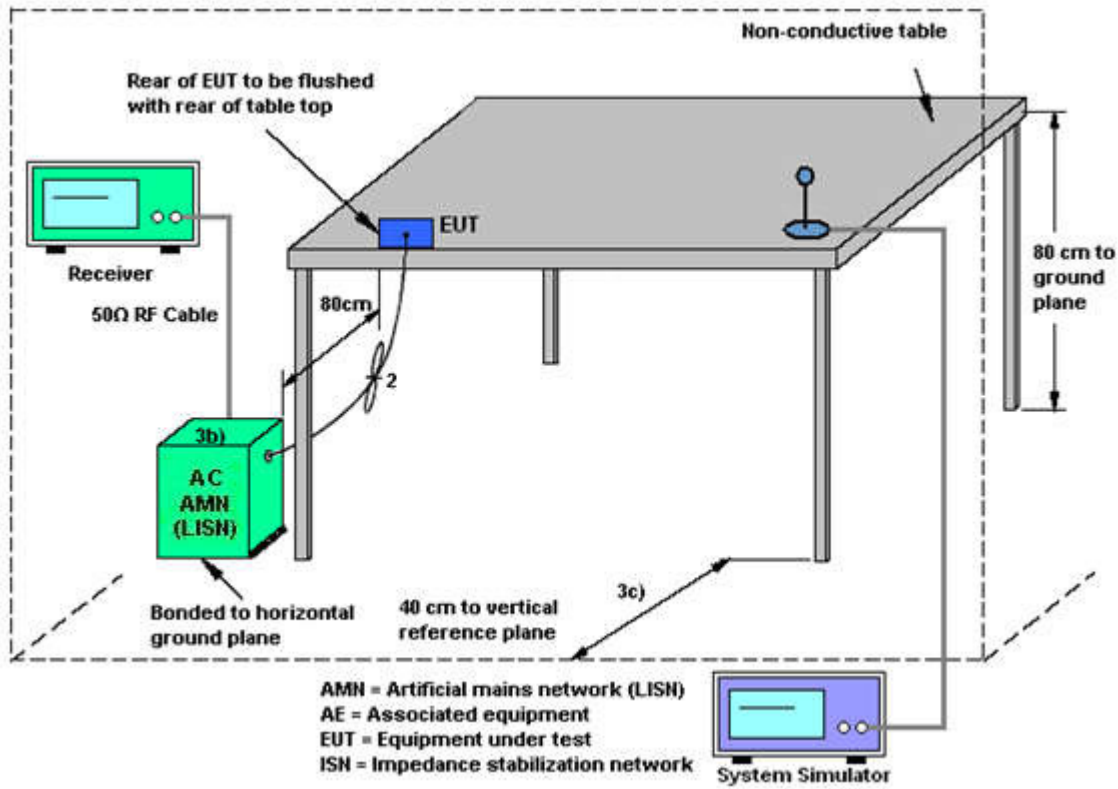





3.6.5 Test Result of AC Conducted Emission

Test Mode :	Mode 2	Temperature :	22~24°C
Test Engineer :	Amos Zhang	Relative Humidity :	42~46%
Test Voltage :	120Vac / 60Hz	Phase :	Line
Function Type :	GSM 850 Idle + Bluetooth Link + WLAN Link (2.4G) + USB Cable (Charging from Adapter2) + Earphone for Sample 1		

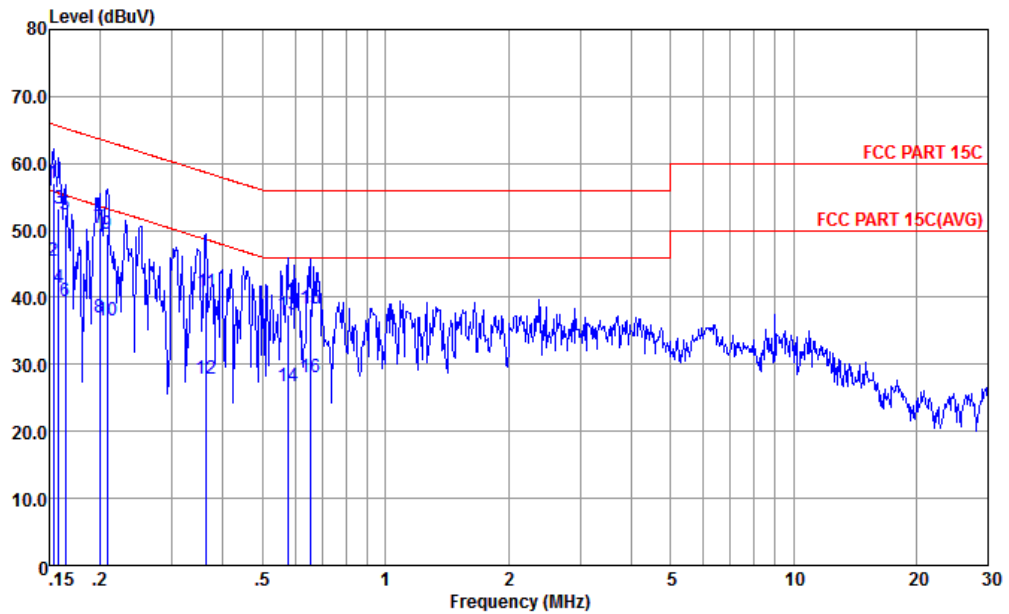

Site : CO01-KS  
 Condition : FCC PART 15C LISN-L-171013-060103 LINE

	Freq	Level	Over Limit	Limit Line	Read Level	LISN Factor	Cable Loss	Remark
	MHz	dBuV	dB	dBuV	dBuV	dB	dB	
1 *	0.153	56.97	-8.85	65.82	46.20	0.16	10.61	QP
2	0.153	45.37	-10.45	55.82	34.60	0.16	10.61	Average
3	0.158	53.36	-12.20	65.56	42.60	0.17	10.59	QP
4	0.158	41.36	-14.20	55.56	30.60	0.17	10.59	Average
5	0.164	52.34	-12.91	65.25	41.60	0.17	10.57	QP
6	0.164	39.34	-15.91	55.25	28.60	0.17	10.57	Average
7	0.200	50.46	-13.16	63.62	39.80	0.20	10.46	QP
8	0.200	36.96	-16.66	53.62	26.30	0.20	10.46	Average
9	0.208	49.55	-13.72	63.27	38.90	0.20	10.45	QP
10	0.208	36.55	-16.72	53.27	25.90	0.20	10.45	Average
11	0.363	40.85	-17.80	58.65	30.20	0.24	10.41	QP
12	0.363	27.95	-20.70	48.65	17.30	0.24	10.41	Average
13	0.576	37.41	-18.59	56.00	26.90	0.26	10.25	QP
14	0.576	26.71	-19.29	46.00	16.20	0.26	10.25	Average
15	0.658	38.25	-17.75	56.00	27.80	0.26	10.19	QP
16	0.658	28.05	-17.95	46.00	17.60	0.26	10.19	Average



Test Mode :	Mode 2	Temperature :	22~24°C
Test Engineer :	Amos Zhang	Relative Humidity :	42~46%
Test Voltage :	120Vac / 60Hz	Phase :	Neutral
Function Type :	GSM 850 Idle + Bluetooth Link + WLAN Link (2.4G) + USB Cable (Charging from Adapter2) + Earphone for Sample 1		

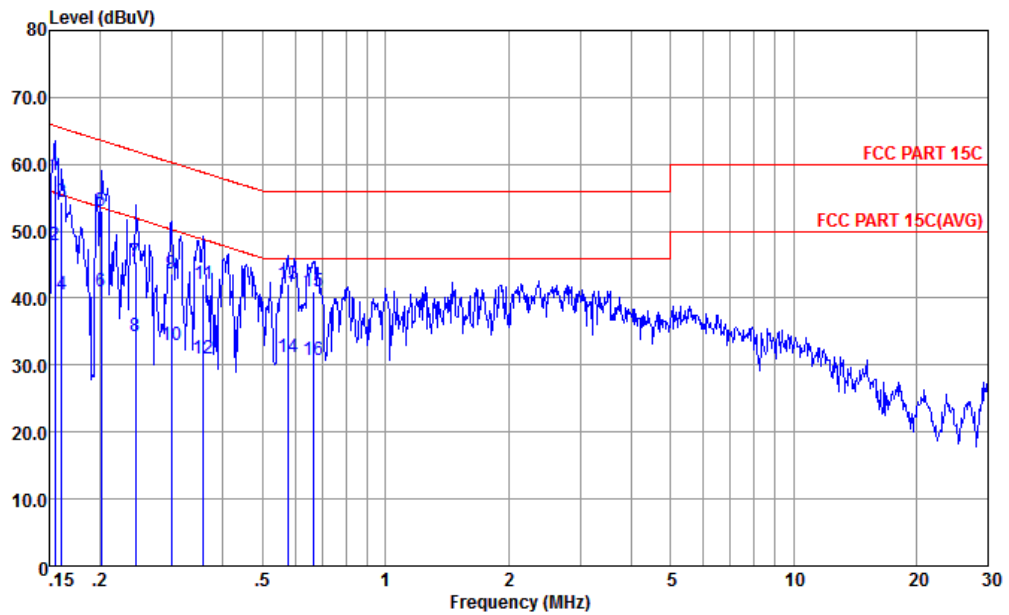

Site : CO01-KS  
 Condition : FCC PART 15C LISN-N-171013-060103 NEUTRAL

	Freq	Level	Over Limit	Limit Line	Read Level	LISN Factor	Cable Loss	Remark
	MHz	dBuV	dB	dBuV	dBuV	dB	dB	
1 *	0.155	58.38	-7.36	65.74	47.50	0.28	10.60	QP
2	0.155	47.98	-7.76	55.74	37.10	0.28	10.60	Average
3	0.161	54.46	-10.97	65.43	43.60	0.28	10.58	QP
4	0.161	40.46	-14.97	55.43	29.60	0.28	10.58	Average
5	0.201	53.04	-10.54	63.58	42.31	0.28	10.45	QP
6	0.201	41.04	-12.54	53.58	30.31	0.28	10.45	Average
7	0.244	45.52	-16.43	61.95	34.80	0.28	10.44	QP
8	0.244	34.22	-17.73	51.95	23.50	0.28	10.44	Average
9	0.299	43.61	-16.67	60.28	32.90	0.28	10.43	QP
10	0.299	33.01	-17.27	50.28	22.30	0.28	10.43	Average
11	0.358	42.20	-16.58	58.78	31.50	0.29	10.41	QP
12	0.358	31.00	-17.78	48.78	20.30	0.29	10.41	Average
13	0.576	42.04	-13.96	56.00	31.50	0.29	10.25	QP
14	0.576	31.14	-14.86	46.00	20.60	0.29	10.25	Average
15	0.665	41.08	-14.92	56.00	30.60	0.30	10.18	QP
16	0.665	30.78	-15.22	46.00	20.30	0.30	10.18	Average



## 3.7 Antenna Requirements

### 3.7.1 Standard Applicable

If directional gain of transmitting antennas is greater than 6dBi, the power shall be reduced by the same level in dB comparing to gain minus 6dBi. The use of a permanently attached antenna or of an antenna that uses a unique coupling to the intentional radiator shall be considered sufficient to comply with the rule.

### 3.7.2 Antenna Anti-Replacement Construction

An embedded-in antenna design is used.

### 3.7.3 Antenna Gain

The antenna peak gain of EUT is less than 6 dBi. Therefore, it is not necessary to reduce maximum peak output power limit.



## 4 List of Measuring Equipment

Instrument	Manufacturer	Model No.	Serial No.	Characteristics	Calibration Date	Test Date	Due Date	Remark
Spectrum Analyzer	R&S	FSV40	101040	10Hz~40GHz	Aug. 08, 2017	Dec. 07, 2017~ Dec. 12, 2017	Aug. 07, 2018	Conducted (TH01-KS)
Pulse Power Sensor	Anritsu	MA2411B	0917070	300MHz~40GHz	Jan. 19, 2017	Dec. 07, 2017~ Dec. 12, 2017	Jan. 18, 2018	Conducted (TH01-KS)
Power Meter	Anritsu	ML2495A	1005002	50MHz Bandwidth	Jan. 19, 2017	Dec. 07, 2017~ Dec. 12, 2017	Jan. 18, 2018	Conducted (TH01-KS)
EMI Test Receiver	Keysight	N9038A	MY564000 04	3Hz~8.5GHz; Max 30dBm	Oct. 19, 2017	Dec. 16, 2017	Oct. 18, 2018	Radiation (03CH03-KS)
EXA Spectrum Analyzer	Keysight	N9010A	MY551502 44	10Hz~44GHz	Apr. 18, 2017	Dec. 16, 2017	Apr. 17, 2018	Radiation (03CH03-KS)
Loop Antenna	R&S	HFH2-Z2	100321	9kHz~30MHz	Oct. 22, 2017	Dec. 16, 2017	Oct. 21, 2018	Radiation (03CH03-KS)
Bilog Antenna	TeseQ	CBL6112D	35406	25MHz~2GHz	Apr. 22, 2017	Dec. 16, 2017	Apr. 21, 2018	Radiation (03CH03-KS)
Double Ridge Horn Antenna	ETS-Lindgren	3117	75957	1GHz~18GHz	Oct. 21, 2017	Dec. 16, 2017	Oct. 20, 2018	Radiation (03CH03-KS)
SHF-EHF Horn	Schwarzbeck	BBHA 9170	BBHA1702 49	15GHz~40GHz	Feb. 15, 2017	Dec. 16, 2017	Feb. 14, 2018	Radiation (03CH03-KS)
Amplifier	com-power	PA-103A	161069	1MHz ~1000MHz / 32 dB	Apr. 18, 2017	Dec. 16, 2017	Apr. 17, 2018	Radiation (03CH03-KS)
Amplifier	MITEQ	TTA1840-35- HG	1887435	18GHz~40GHz	Oct. 12, 2017	Dec. 16, 2017	Oct. 11, 2018	Radiation (03CH03-KS)
high gain Amplifier	MITEQ	AMF-7D-0010 1800-30-10P	2025788	1Ghz-18Ghz	Apr. 18, 2017	Dec. 16, 2017	Apr. 17, 2018	Radiation (03CH03-KS)
AC Power Source	Chroma	61601	F1040900 04	N/A	NCR	Dec. 16, 2017	NCR	Radiation (03CH03-KS)
Turn Table	ChamPro	EM 1000-T	060762-T	0~360 degree	NCR	Dec. 16, 2017	NCR	Radiation (03CH03-KS)
Antenna Mast	ChamPro	EM 1000-A	060762-A	1 m~4 m	NCR	Dec. 16, 2017	NCR	Radiation (03CH03-KS)
EMI Receiver	R&S	ESC17	100768	9kHz~7GHz;	Apr. 20, 2017	Dec. 14, 2017	Apr. 19, 2018	Conduction (CO01-KS)
AC LISN	MessTec	AN3016	060103	9kHz~30MHz	Oct. 13, 2017	Dec. 14, 2017	Oct. 12, 2018	Conduction (CO01-KS)
AC LISN (for auxiliary equipment)	MessTec	AN3016	060105	9kHz~30MHz	Oct. 13, 2017	Dec. 14, 2017	Oct. 12, 2018	Conduction (CO01-KS)
AC Power Source	Chroma	61602	ABP00000 0811	AC 0V~300V, 45Hz~1000Hz	Oct. 12, 2017	Dec. 14, 2017	Oct. 11, 2018	Conduction (CO01-KS)

NCR: No Calibration Required



## 5 Uncertainty of Evaluation

### Uncertainty of Conducted Emission Measurement (150 kHz ~ 30 MHz)

Measuring Uncertainty for a Level of Confidence of 95% ( $U = 2Uc(y)$ )	2.3dB
---	-------

### Uncertainty of Radiated Emission Measurement (30 MHz ~ 1000 MHz)

Measuring Uncertainty for a Level of Confidence of 95% ( $U = 2Uc(y)$ )	4.6dB
---	-------

### Uncertainty of Radiated Emission Measurement (1000 MHz ~ 18000 MHz)

Measuring Uncertainty for a Level of Confidence of 95% ( $U = 2Uc(y)$ )	4.5dB
---	-------

### Uncertainty of Radiated Emission Measurement (18000 MHz ~ 40000 MHz)

Measuring Uncertainty for a Level of Confidence of 95% ( $U = 2Uc(y)$ )	4.7dB
---	-------



## **Appendix A. Conducted Test Results**

**Bluetooth Low Energy**

Test Engineer:	Silent Hai	Temperature:	21~25	°C
Test Date:	2017/12/07~2017/12/12	Relative Humidity:	51~55	%

**TEST RESULTS DATA**  
**6dB and 99% Occupied Bandwidth**

Mod.	Data Rate	NTX	CH.	Freq. (MHz)	99% Occupied BW (MHz)	6dB BW (MHz)	6dB BW Limit (MHz)	Pass/Fail
BLE	1Mbps	1	0	2402	1.05	0.68	0.50	Pass
BLE	1Mbps	1	19	2440	1.05	0.68	0.50	Pass
BLE	1Mbps	1	39	2480	1.06	0.68	0.50	Pass

**TEST RESULTS DATA**  
**Peak Power Table**

Mod.	Data Rate	NTX	CH.	Freq. (MHz)	Peak Conducted Power (dBm)	Conducted Power Limit (dBm)	DG (dBi)	EIRP Power (dBm)	EIRP Power Limit (dBm)	Pass /Fail
BLE	1Mbps	1	0	2402	0.66	30.00	-1.35	-0.69	36.00	Pass
BLE	1Mbps	1	19	2440	1.89	30.00	-1.35	0.54	36.00	Pass
BLE	1Mbps	1	39	2480	0.74	30.00	-1.35	-0.61	36.00	Pass

**TEST RESULTS DATA**  
**Average Power Table**  
**(Reporting Only)**

Mod.	Data Rate	NTX	CH.	Freq. (MHz)	Duty Factor (dB)	Average Conducted Power (dBm)
BLE	1Mbps	1	0	2402	2.05	0.43
BLE	1Mbps	1	19	2440	2.05	1.80
BLE	1Mbps	1	39	2480	2.05	0.53

**TEST RESULTS DATA**  
**Peak Power Density**

Mod.	Data Rate	NTX	CH.	Freq. (MHz)	Peak PSD (dBm /100kHz)	Peak PSD (dBm /3kHz)	DG (dBi)	Peak PSD Limit (dBm /3kHz)	Pass/Fail
BLE	1Mbps	1	0	2402	-0.58	-15.30	-1.35	8.00	Pass
BLE	1Mbps	1	19	2440	0.85	-13.85	-1.35	8.00	Pass
BLE	1Mbps	1	39	2480	-0.54	-15.20	-1.35	8.00	Pass

Note: PSD (dBm/ 100kHz) is a reference level used for Conducted Band Edges and Conducted Spurious Emission 20dBc limit.



# Appendix B. Radiated Spurious Emission

## 2.4GHz 2400~2483.5MHz

### BLE (Band Edge @ 3m)

BLE	Note	Frequency	Level	Over	Limit	Read	Antenna	Cable	Preamp	Ant	Table	Peak	Pol.
				Limit	Line	Level	Factor	Loss	Factor	Pos	Pos	Avg.	
		( MHz )	( dBμV/m )	( dB )	( dBμV/m )	( dBμV )	( dB/m )	( dB )	( dB )	( cm )	( deg )	( P/A )	( H/V )
BLE CH 00 2402MHz		2381.89	57.47	-16.53	74	55.3	31.27	7.55	36.65	107	146	P	H
		2370.06	47.49	-6.51	54	45.32	31.27	7.55	36.65	107	146	A	H
	*	2402	95.6	-	-	93.35	31.3	7.59	36.64	107	146	P	H
	*	2402	94.92	-	-	92.67	31.3	7.59	36.64	107	146	A	H
		2340.55	58.09	-15.91	74	56.06	31.22	7.48	36.67	100	279	P	V
		2386.18	47.6	-6.4	54	45.36	31.3	7.59	36.65	100	279	A	V
	*	2402	93.06	-	-	90.81	31.3	7.59	36.64	100	279	P	V
	*	2402	92.46	-	-	90.21	31.3	7.59	36.64	100	279	A	V
BLE CH 19 2440MHz		2384.88	58.14	-15.86	74	55.97	31.27	7.55	36.65	161	151	P	H
		2386.57	47.49	-6.51	54	45.25	31.3	7.59	36.65	161	151	A	H
	*	2440	96.1	-	-	93.69	31.39	7.67	36.65	161	151	P	H
	*	2440	95.53	-	-	93.12	31.39	7.67	36.65	161	151	A	H
		2484.76	57.81	-16.19	74	55.33	31.44	7.72	36.68	161	151	P	H
		2494.9	48.06	-5.94	54	45.54	31.47	7.74	36.69	161	151	A	H
		2354.46	57.56	-16.44	74	55.46	31.25	7.52	36.67	337	301	P	V
		2343.02	47.55	-6.45	54	45.52	31.22	7.48	36.67	337	301	A	V
	*	2440	92.52	-	-	90.11	31.39	7.67	36.65	337	301	P	V
	*	2440	91.92	-	-	89.51	31.39	7.67	36.65	337	301	A	V
		2487.82	57.76	-16.24	74	55.23	31.47	7.74	36.68	337	301	P	V
	2491.42	47.74	-6.26	54	45.21	31.47	7.74	36.68	337	301	A	V	





BLE CH 39 2480MHz	*	2480	93.93	-	-	91.45	31.44	7.72	36.68	100	158	P	H
	*	2480	93.21	-	-	90.73	31.44	7.72	36.68	100	158	A	H
		2490.64	57.94	-16.06	74	55.41	31.47	7.74	36.68	100	158	P	H
		2494.24	47.95	-6.05	54	45.43	31.47	7.74	36.69	100	158	A	H
	*	2480	91.34	-	-	88.86	31.44	7.72	36.68	207	257	P	V
	*	2480	90.68	-	-	88.2	31.44	7.72	36.68	207	257	A	V
		2485.24	58.19	-15.81	74	55.71	31.44	7.72	36.68	207	257	P	V
		2492.26	47.93	-6.07	54	45.41	31.47	7.74	36.69	207	257	A	V
Remark	<ol style="list-style-type: none"> <li>No other spurious found.</li> <li>All results are PASS against Peak and Average limit line.</li> </ol>												



2.4GHz 2400~2483.5MHz
BLE (Harmonic @ 3m)

Table with 14 columns: BLE, Note, Frequency (MHz), Level (dBµV/m), Over Limit (dB), Limit Line (dBµV/m), Read Level (dBµV), Antenna Factor (dB/m), Cable Loss (dB), Preamp Factor (dB), Ant Pos (cm), Table Pos (deg), Peak Avg. (P/A), Pol. (H/V). Rows include data for BLE CH 00 (2402MHz), BLE CH 19 (2440MHz), and BLE CH 39 (2480MHz).



Emission below 1GHz

2.4GHz BLE (LF)

BLE	Note	Frequency	Level	Over	Limit	Read	Antenna	Cable	Preamp	Ant	Table	Peak	Pol.
		( MHz )	( dBμV/m )	( dB )	( dBμV/m )	( dBμV )	( dB/m )	( dB )	( dB )	( cm )	( deg )	( P/A )	( H/V )
2.4GHz BLE LF		33.88	29.47	-10.53	40	35.04	25.92	0.81	32.3	-	-	P	H
		41.64	29.68	-10.32	40	39.31	21.6	0.97	32.2	135	25	P	H
		59.1	29.34	-10.66	40	46.12	14.32	1.11	32.21	-	-	P	H
		188.11	33.09	-10.41	43.5	46.22	17.12	2.01	32.26	-	-	P	H
		208.48	32.79	-10.71	43.5	45.87	17.03	2.12	32.23	-	-	P	H
		219.15	32.05	-13.95	46	44.99	17.08	2.18	32.2	-	-	P	H
		42.61	30.01	-9.99	40	40.42	20.8	0.99	32.2	-	-	P	V
		58.13	33.02	-6.98	40	49.49	14.64	1.1	32.21	250	254	P	V
		94.99	25.64	-17.86	43.5	38.21	18.3	1.37	32.24	-	-	P	V
		136.7	27.37	-16.13	43.5	40.03	17.9	1.72	32.28	-	-	P	V
		187.14	27.19	-16.31	43.5	40.32	17.13	2.01	32.27	-	-	P	V
		323.91	29.31	-16.69	46	37.9	20.61	2.88	32.08	-	-	P	V

Remark

1. No other spurious found.
2. All results are PASS against limit line.



**Note symbol**

*	<b>Fundamental Frequency</b> which can be ignored. However, the level of any unwanted emissions shall not exceed the level of the fundamental frequency.
!	Test result is <b>over limit</b> line.
P/A	<b>Peak</b> or <b>Average</b>
H/V	<b>Horizontal</b> or <b>Vertical</b>



A calculation example for radiated spurious emission is shown as below:

WIFI	Note	Frequency	Level	Over	Limit	Read	Antenna	Cable	Preamp	Ant	Table	Peak	Pol.
Ant.				Limit	Line	Level	Factor	Loss	Factor	Pos	Pos	Avg.	
1+2		( MHz )	( dBμV/m )	( dB )	( dBμV/m )	( dBμV )	( dB/m )	( dB )	( dB )	( cm )	( deg )	( P/A )	( H/V )
802.11b		2390	55.45	-18.55	74	54.51	32.22	4.58	35.86	103	308	P	H
CH 01													
2412MHz		2390	43.54	-10.46	54	42.6	32.22	4.58	35.86	103	308	A	H

- Level(dBμV/m) =  
Antenna Factor(dB/m) + Cable Loss(dB) + Read Level(dBμV) - Preamp Factor(dB)
- Over Limit(dB) = Level(dBμV/m) – Limit Line(dBμV/m)

**For Peak Limit @ 2390MHz:**

- Level(dBμV/m)  
= Antenna Factor(dB/m) + Cable Loss(dB) + Read Level(dBμV) - Preamp Factor(dB)  
= 32.22(dB/m) + 4.58(dB) + 54.51(dBμV) – 35.86 (dB)  
= 55.45 (dBμV/m)
- Over Limit(dB)  
= Level(dBμV/m) – Limit Line(dBμV/m)  
= 55.45(dBμV/m) – 74(dBμV/m)  
= -18.55(dB)

**For Average Limit @ 2390MHz:**

- Level(dBμV/m)  
= Antenna Factor(dB/m) + Cable Loss(dB) + Read Level(dBμV) - Preamp Factor(dB)  
= 32.22(dB/m) + 4.58(dB) + 42.6(dBμV) – 35.86 (dB)  
= 43.54 (dBμV/m)
- Over Limit(dB)  
= Level(dBμV/m) – Limit Line(dBμV/m)  
= 43.54(dBμV/m) – 54(dBμV/m)  
= -10.46(dB)

Both peak and average measured complies with the limit line, so test result is “PASS”.



## Appendix C. Duty Cycle Plots

Band	Duty Cycle(%)	T(ms)	1/T(kHz)	VBW Setting
Bluetooth v4.2 LE	62.41	0.390	2.565	3KHz

### Bluetooth v4.2 LE

