



FCC RF Test Report

APPLICANT : Motorola Mobility LLC
EQUIPMENT : Mobile Cellular Phone
BRAND NAME : Motorola
MODEL NAME : XT1944-3, XT1944-4
FCC ID : IHDT56XF4
STANDARD : FCC Part 15 Subpart C §15.247
CLASSIFICATION : (DTS) Digital Transmission System

The product was received on Dec. 20, 2017 and testing was completed on Jan. 23, 2018. We, Sporton International (Kunshan) Inc., would like to declare that the tested sample has been evaluated in accordance with the test procedures and has been in compliance with the applicable technical standards.

The test results in this report apply exclusively to the tested model / sample. Without written approval of Sporton International (Kunshan) Inc., the test report shall not be reproduced except in full.



Approved by: James Huang / Manager

Sporton International (Kunshan) Inc.
No.3-2 Ping-Xiang Rd, Kunshan Development Zone Kunshan City Jiangsu Province 215335
China



TABLE OF CONTENTS

SUMMARY OF TEST RESULT 4

1 GENERAL DESCRIPTION..... 5

1.1 Applicant 5

1.2 Manufacturer 5

1.3 Product Feature of Equipment Under Test..... 5

1.4 Product Specification of Equipment Under Test..... 6

1.5 Modification of EUT 6

1.6 Specification of Accessory..... 6

1.7 Re-use of Measured Data 8

1.8 Testing Location 9

1.9 Applicable Standards..... 9

2 TEST CONFIGURATION OF EQUIPMENT UNDER TEST..... 10

2.1 Descriptions of Test Mode 10

2.2 Test Mode 10

2.3 Connection Diagram of Test System..... 11

2.4 Support Unit used in test configuration and system 12

2.5 EUT Operation Test Setup 12

3 TEST RESULT 13

3.1 Radiated Band Edges and Spurious Emission Measurement 13

3.2 AC Conducted Emission Measurement..... 17

3.3 Antenna Requirements 21

4 LIST OF MEASURING EQUIPMENT..... 22

5 UNCERTAINTY OF EVALUATION..... 23

APPENDIX A. RADIATED SPURIOUS EMISSION

APPENDIX B. DUTY CYCLE PLOTS

APPENDIX C. SETUP PHOTOGRAPHS

APPENDIX D. REFERENCE REPORT



REVISION HISTORY

REPORT NO.	VERSION	DESCRIPTION	ISSUED DATE
FR7D2007B	Rev. 01	Initial issue of report	Feb. 08, 2018



SUMMARY OF TEST RESULT

Report Section	FCC Rule	Description	Limit	Result	Remark
3.1	15.247(d)	Radiated Band Edges and Spurious Emission	15.209(a) & 15.247(d)	Pass	Under limit 9.60 dB at 450.980 MHz
3.2	15.207	AC Conducted Emission	15.207(a)	Pass	Under limit 12.48 dB at 0.155 MHz
3.3	15.203 & 15.247(b)	Antenna Requirement	N/A	Pass	-



1 General Description

1.1 Applicant

Motorola Mobility LLC
222 W, Merchandise Mart Plaza, Chicago IL 60654 USA

1.2 Manufacturer

Motorola Mobility LLC
222 W, Merchandise Mart Plaza, Chicago IL 60654 USA

1.3 Product Feature of Equipment Under Test

Product Feature	
Equipment	Mobile Cellular Phone
Brand Name	Motorola
Model Name	XT1944-3, XT1944-4
FCC ID	IHDT56XF4
EUT supports Radios application	GSM/GPRS/EGPRS/WCDMA/HSPA/DC-HSDPA/ HSPA+(16QAM uplink is not supported)/LTE/ WLAN 2.4GHz 802.11b/g/n HT20/ Bluetooth v3.0 + EDR/ Bluetooth v 4.0 LE/ Bluetooth v4.1 LE/ Bluetooth v4.2 LE/
IMEI Code	Conduction: 354123090006638/354123090006646 Radiation: 354123090006794/354123090006802
HW Version	DVT1B
SW Version	nora_row_n-userdebug 8.0.0 OPP27.60 222 intcfg,test-keys
EUT Stage	Identical Prototype

Remark:

1. The above EUT's information was declared by manufacturer. Please refer to the specifications or user's manual for more detailed description.
2. There are two types of EUT, the only difference between two samples is SIM slot: sample 1(Model: XT1944-4) is dual SIM slot, sample 2(Model: XT1944-3) is single SIM slot. According to the difference, we chose sample 1 to evaluate for full test



1.4 Product Specification of Equipment Under Test

Standards-related Product Specification	
Tx/Rx Frequency Range	2402 MHz ~ 2480 MHz
Number of Channels	40
Carrier Frequency of Each Channel	40 Channel(37 hopping + 3 advertising channel)
Antenna Type / Gain	Monopole Antenna with gain -1.35 dBi
Type of Modulation	Bluetooth LE : GFSK

1.5 Modification of EUT

No modifications are made to the EUT during all test items.

1.6 Specification of Accessory

Specification of Accessory			
AC Adapter 1(US)	Brand Name	Motorola (Acbel)	Model Name SPN5945A C-P35
	Power Rating	I/P: 100-240 Vac, 300mA, O/P: 5.2Vdc,2000mA	
AC Adapter 1(EU)	Brand Name	Motorola (Acbel)	Model Name SPN5944A C-P36
	Power Rating	I/P: 100-240 Vac, 300mA, O/P: 5.2Vdc,2000mA	
AC Adapter 1(UK)	Brand Name	Motorola (Acbel)	Model Name SPN5940A C-P37
	Power Rating	I/P: 100-240 Vac, 300mA, O/P: 5.2Vdc,2000mA	
AC Adapter 1(IN)	Brand Name	Motorola (Acbel)	Model Name SA18C19493 C-P49
	Power Rating	I/P: 100-240 Vac, 300mA, O/P: 5.2Vdc,2000mA	
AC Adapter 1(AU)	Brand Name	Motorola (Acbel)	Model Name SPN5953A C-P48
	Power Rating	I/P: 100-240 Vac, 300mA, O/P: 5.2Vdc,2000mA	
AC Adapter 1(AR)	Brand Name	Motorola (Acbel)	Model Name SPN5942A C-P47
	Power Rating	I/P: 100-240 Vac, 500mA, O/P: 5.2Vdc,2000mA	
AC Adapter 2(US)	Brand Name	Motorola (Salom)	Model Name SSW-2919UMTJ C-P35 SPN5945A
	Power Rating	I/P: 100-240 Vac, 300mA, O/P: 5.2Vdc,2000mA	



AC Adapter 2(EU)	Brand Name	Motorola (Salom)	Model Name	SSW-2919EU C-P36 SPN5944A
	Power Rating	I/P: 100-240 Vac, 300mA, O/P: 5.2Vdc,2000mA		
AC Adapter 2(UK)	Brand Name	Motorola (Salom)	Model Name	SSW-2919UK C-P37 SPN5940A
	Power Rating	I/P: 100-240 Vac, 300mA, O/P: 5.2Vdc,2000mA		
AC Adapter 2(AU)	Brand Name	Motorola (Salom)	Model Name	SSW-2919AU C-P48 SPN5953A
	Power Rating	I/P: 100-240 Vac, 300mA, O/P: 5.2Vdc,2000mA		
AC Adapter 2(AR)	Brand Name	Motorola (Salom)	Model Name	SSW-2919AR C-P47 SPN5955A
	Power Rating	I/P: 100-240 Vac, 500mA, O/P: 5.2Vdc,2000mA		
Battery	Brand Name	Lenovo (SCUD)	Model Name	BL270
	Power Rating	3.85/4.4Vdc,4000mAh	Type	Li-ion
Earphone 1	Brand Name	Motorola(NEW Leaders)	Model Name	NLD-EM300V-01SF
	Signal Line Type	1.2 meter, non-shielded cable, without ferrite core		
Earphone 2	Brand Name	Motorola(Cosonic)	Model Name	SH38C16617
	Signal Line Type	1.1 meter, non-shielded cable, without ferrite core		
USB Cable	Brand Name	Motorola (Saibao)	Model Name	SLQ-A081A
	Signal Line Type	1.0 meter, shielded cable, without ferrite core		



1.7 Re-use of Measured Data

1.7.1 Introduction Section

This application re-uses data collected on a similar device. The subject device of this application (Model: XT1944-3, XT1944-4, FCC ID: IHDT56XF4) is electrically identical to the reference device (Model: XT1922-5, XT1922-4, FCC ID: IHDT56XB5) for the portions of the circuitry corresponding to the data being re-used, as treated by KDB Publication 178919 D01.

1.7.2 Difference Section

For details concerning the similarity with respect to component placement, mechanical/electrical design etc., some difference of population/depoulation to enable support of different cellular bands, please refer to the Product Equality Declaration.

The re-used RF data includes the following bands provided in Appendix D (Sporton RF Report No. FR7D0507B for the reference device Model: XT1922-5, XT1922-4, FCC ID: IHDT56XB5):

1.7.3 Spot Check Verification Data Section

In order to confirm hardware similarity of the subject device with the reference device, spot check measurements were performed on the subject device for Conducted Power and Conducted spurious emission, the test result were consistent with FCC ID: IHDT56XB5 and radiated spurious emission, conducted Emission to re-test.

Assertions concerning the similarity of these devices are based on representations by the applicant. The applicant accepts full responsibility for the validity of the similarity claim, and for the determination that verification test data are sufficient to support it.

1.7.4 Reference detail Section:

Equipment Class	Reference FCC ID	Folder Test	Report Title/Section
DSS	IHDT56XB5	Part15C(FR7D0507A)	All conducted sections applicable
DTS (BLE)	IHDT56XB5	Part15C(FR7D0507B)	All conducted sections applicable



1.8 Testing Location

Sporton International (Kunshan) Inc. is accredited to ISO 17025 by National Voluntary Laboratory Accreditation Program (NVLAP code: 600155-0) and the FCC designation No. is CN5013.

Test Site	Sporton International (Kunshan) Inc.		
Test Site Location	No.3-2 Ping-Xiang Rd, Kunshan Development Zone Kunshan City Jiangsu Province 215335 China TEL : +86-512-57900158 FAX : +86-512-57900958		
Test Site No.	Sporton Site No.		FCC Test Firm Registration No.
	03CH03-KS	CO01-KS	630927

Note: The test site complies with ANSI C63.4 2014 requirement.

1.9 Applicable Standards

According to the specifications of the manufacturer, the EUT must comply with the requirements of the following standards:

- ♦ FCC Part 15 Subpart C §15.247
- ♦ FCC KDB Publication No. 558074 D01 DTS Meas. Guidance v04
- ♦ ANSI C63.10-2013

Remark:

1. All test items were verified and recorded according to the standards and without any deviation during the test.
2. This EUT has also been tested and complied with the requirements of FCC Part 15, Subpart B, recorded in a separate test report.



2 Test Configuration of Equipment Under Test

2.1 Descriptions of Test Mode

- a. The EUT has been associated with peripherals and configuration operated in a manner tended to maximize its emission characteristics in a typical application. Frequency range investigated: conduction (150 kHz to 30 MHz), radiation (9 kHz to the 10th harmonic of the highest fundamental frequency or to 40 GHz, whichever is lower). Pre-scanned tests, X, Y, Z in three orthogonal panels to determine the final configuration (Y plane as worst plane) from all possible combinations.
- b. AC power line Conducted Emission was tested under maximum output power.

2.2 Test Mode

The following summary table is showing all test modes to demonstrate in compliance with the standard.

Summary table of Test Cases	
Test Item	Data Rate / Modulation
	Bluetooth LE / GFSK
Radiated TCs	Mode 1: Bluetooth Tx CH00_2402 MHz_1Mbps Mode 2: Bluetooth Tx CH19_2440 MHz_1Mbps Mode 3: Bluetooth Tx CH39_2480 MHz_1Mbps
AC Conducted Emission	Mode 1 : GSM 850 Idle + Bluetooth Link + WLAN Link (2.4G) + USB Cable (Charging from Adapter1) + Earphone 1 for Sample 1 Mode 2 : GSM 850 Idle + Bluetooth Link + WLAN Link (2.4G) + USB Cable (Charging from Adapter2) + Earphone 2 for Sample 1
Remark:	
1. The worst case of conducted emission is mode 1; only the test data of it was reported.	
2. For Radiated TCs, The tests were performed with Adapter 1, Earphone 1 and USB Cable.	

2.3 Connection Diagram of Test System

<Bluetooth LE Tx Mode>

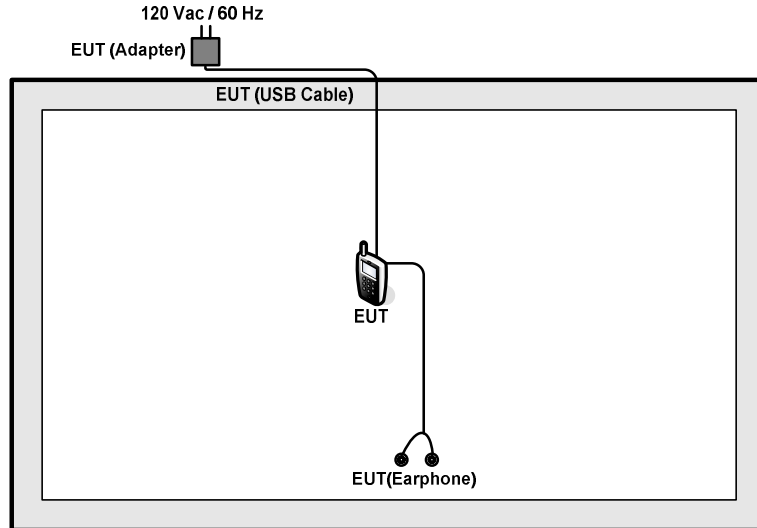

<AC Conducted Emission Mode>

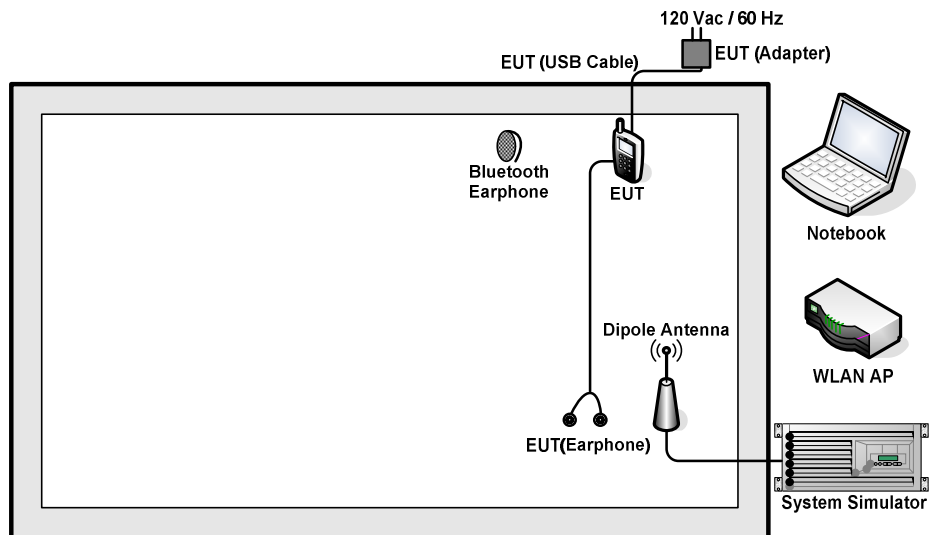



2.4 Support Unit used in test configuration and system

Item	Equipment	Trade Name	Model Name	FCC ID	Data Cable	Power Cord
1.	System Simulator	R&S	CMU 200	N/A	N/A	Unshielded, 1.8 m
2.	WLAN AP	D-Link	DIR-855	KA2DIR855A2	N/A	Unshielded, 1.8 m
3.	Notebook	Lenovo	G480	N/A	N/A	AC I/P: Unshielded, 1.8 m DC O/P: Shielded, 1.8 m
4.	Bluetooth Earphone	Lenovo	LBH308	NA	N/A	N/A

2.5 EUT Operation Test Setup

For Bluetooth LE function, the engineering test program was provided and enabled to make EUT continuous transmit/receive.

For AC power line conducted emissions, the EUT was set to connect with the WLAN AP under large package sizes transmission.



3 Test Result

3.1 Radiated Band Edges and Spurious Emission Measurement

3.1.1 Limit of Radiated Band Edges and Spurious Emission

In any 100 kHz bandwidth outside the intentional radiator frequency band, all harmonics/spurious must be at least 20 dB below the highest emission level within the authorized band. If the output power of this device was measured by spectrum analyzer, the attenuation under this paragraph shall be 30 dB instead of 20 dB. In addition, radiated emissions which fall in the restricted bands must also comply with the limits as below.

Frequency (MHz)	Field Strength (microvolts/meter)	Measurement Distance (meters)
0.009 – 0.490	2400/F(kHz)	300
0.490 – 1.705	24000/F(kHz)	30
1.705 – 30.0	30	30
30 – 88	100	3
88 – 216	150	3
216 - 960	200	3
Above 960	500	3

3.1.2 Measuring Instruments

The section 4.0 of List of Measuring Equipment of this test report is used for test.



3.1.3 Test Procedures

1. The testing follows FCC KDB Publication No. 558074 D01 DTS Meas. Guidance v04.
2. The EUT was arranged to its worst case and then tune the antenna tower (from 1 m to 4 m) and turntable (from 0 degree to 360 degrees) to find the maximum reading. A pre-amp and a high pass filter are used for the test in order to get better signal level.
3. The EUT was placed on a turntable with 0.8 meter for frequency below 1GHz and 1.5 meter for frequency above 1GHz respectively above ground.
4. The EUT was set 3 meters from the interference receiving antenna, which was mounted on the top of a variable height antenna tower.
5. Corrected Reading: Antenna Factor + Cable Loss + Read Level - Preamp Factor = Level
6. For measurement below 1GHz, If the emission level of the EUT measured by the peak detector is 3 dB lower than the applicable limit, the peak emission level will be reported. Otherwise, the emission measurement will be repeated using the quasi-peak detector and reported.
7. Use the following spectrum analyzer settings:
 - (1) Span shall wide enough to fully capture the emission being measured;
 - (2) Set RBW=100 kHz for $f < 1$ GHz; VBW \geq RBW; Sweep = auto; Detector function = peak; Trace = max hold;
 - (3) Set RBW = 1 MHz, VBW= 3MHz for $f \geq 1$ GHz for peak measurement.

For average measurement:

 - VBW = 10 Hz, when duty cycle is no less than 98 percent.
 - VBW $\geq 1/T$, when duty cycle is less than 98 percent where T is the minimum transmission duration over which the transmitter is on and is transmitting at its maximum power control level for the tested mode of operation.

3.1.4 Test Setup

For radiated emissions below 30MHz

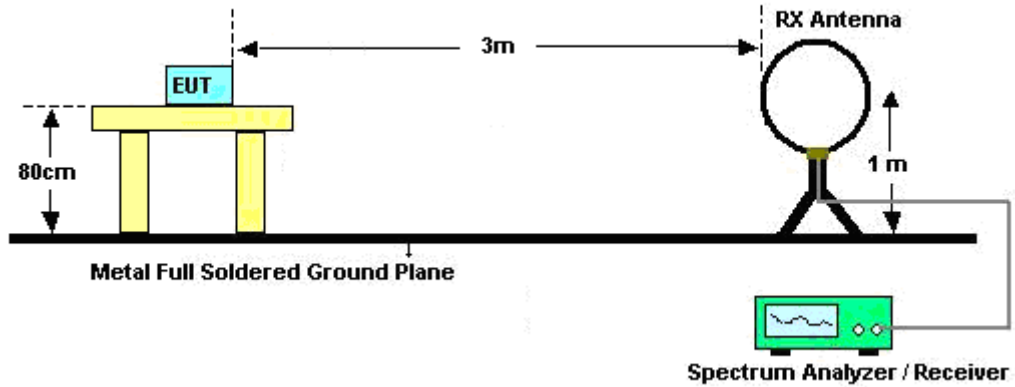

For radiated emissions from 30MHz to 1GHz

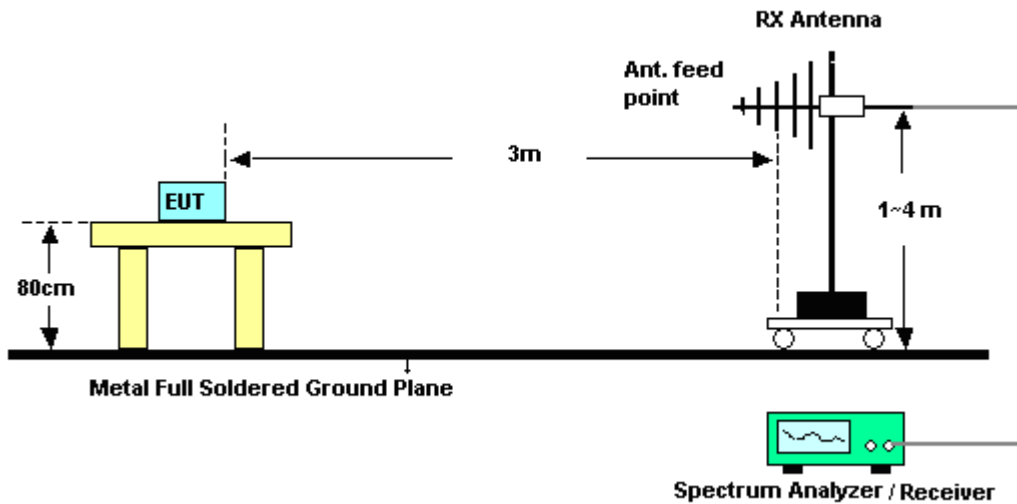

For radiated emissions above 1GHz

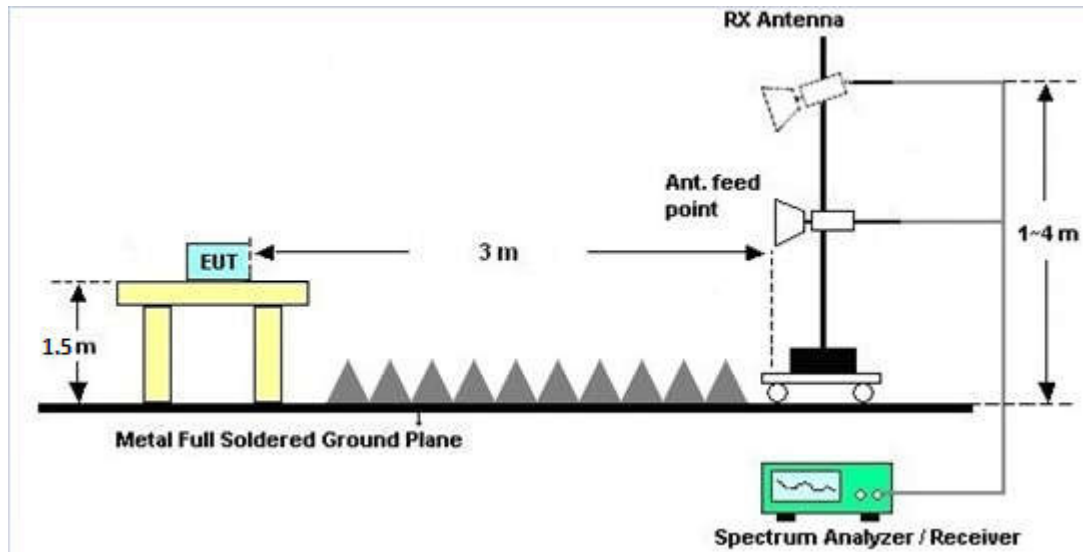

3.1.5 Test Results of Radiated Spurious Emissions (9 kHz ~ 30 MHz)

The low frequency, which started from 9 kHz to 30MHz, was pre-scanned and the result which was 20dB lower than the limit line was not reported.

3.1.6 Test Result of Radiated Spurious at Band Edges

Please refer to Appendix A.

3.1.7 Duty Cycle

Please refer to Appendix B.

3.1.8 Test Result of Radiated Spurious Emission (30MHz ~ 10th Harmonic)

Please refer to Appendix A.



3.2 AC Conducted Emission Measurement

3.2.1 Limit of AC Conducted Emission

For equipment that is designed to be connected to the public utility (AC) power line, the radio frequency voltage that is conducted back onto the AC power line on any frequency or frequencies within the band 150 kHz to 30 MHz shall not exceed the limits in the following table.

Frequency of emission (MHz)	Conducted limit (dBµV)	
	Quasi-peak	Average
0.15-0.5	66 to 56*	56 to 46*
0.5-5	56	46
5-30	60	50

*Decreases with the logarithm of the frequency.

3.2.2 Measuring Instruments

The section 4.0 of List of Measuring Equipment of this test report is used for test.

3.2.3 Test Procedures

1. The EUT was placed 0.4 meter from the conducting wall of the shielding room was kept at least 80 centimeters from any other grounded conducting surface.
2. Connect EUT to the power mains through a line impedance stabilization network (LISN).
3. All the support units are connecting to the other LISN.
4. The LISN provides 50 ohm coupling impedance for the measuring instrument.
5. The FCC states that a 50 ohm, 50 microhenry LISN should be used.
6. Both sides of AC line were checked for maximum conducted interference.
7. The frequency range from 150 kHz to 30 MHz was searched.
8. Set the test-receiver system to Peak Detect Function and specified bandwidth (IF Bandwidth = 9kHz) with Maximum Hold Mode. Then measurement is also conducted by Average Detector and Quasi-Peak Detector Function respectively.

3.2.4 Test Setup

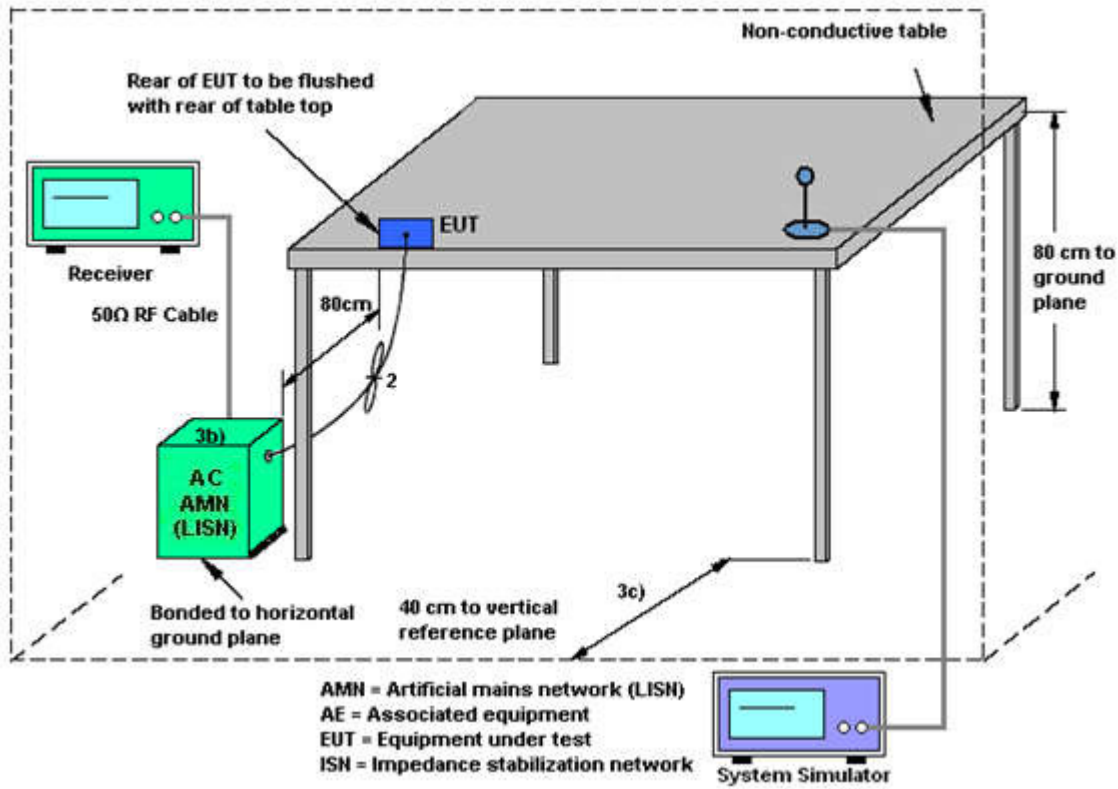



3.2.5 Test Result of AC Conducted Emission

Test Mode :	Mode 1	Temperature :	23~24°C
Test Engineer :	Amos Zhang	Relative Humidity :	42~46%
Test Voltage :	120Vac / 60Hz	Phase :	Line
Function Type :	GSM 850 Idle + Bluetooth Link + WLAN Link (2.4G) + USB Cable (Charging from Adapter1) + Earphone 1 for Sample 1		

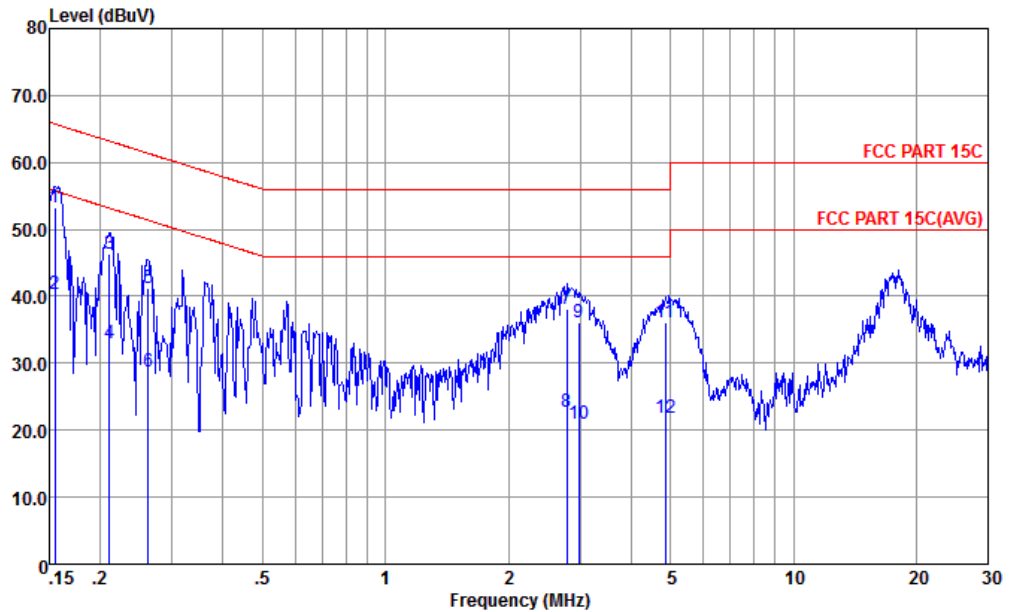

Site : CO01-KS
 Condition : FCC PART 15C LISN-L-171013-060103 LINE
 mode : Mode 1
 : 354123090006638/354123090006646 #8

	Freq	Level	Over Limit	Limit	Read	LISN	Cable	Remark
	MHz	dBuV		dB	dBuV	dB	dB	
1 *	0.155	53.26	-12.48	65.74	42.50	0.16	10.60	QP
2	0.155	40.36	-15.38	55.74	29.60	0.16	10.60	Average
3	0.211	46.26	-16.92	63.18	35.61	0.20	10.45	QP
4	0.211	32.96	-20.22	53.18	22.31	0.20	10.45	Average
5	0.262	41.25	-20.13	61.38	30.59	0.22	10.44	QP
6	0.262	28.85	-22.53	51.38	18.19	0.22	10.44	Average
7	2.779	38.00	-18.00	56.00	27.50	0.31	10.19	QP
8	2.779	22.80	-23.20	46.00	12.30	0.31	10.19	Average
9	2.978	36.10	-19.90	56.00	25.59	0.32	10.19	QP
10	2.978	21.00	-25.00	46.00	10.49	0.32	10.19	Average
11	4.848	36.09	-19.91	56.00	25.50	0.37	10.22	QP
12	4.848	21.89	-24.11	46.00	11.30	0.37	10.22	Average



Test Mode :	Mode 1	Temperature :	23~24°C
Test Engineer :	Amos Zhang	Relative Humidity :	42~46%
Test Voltage :	120Vac / 60Hz	Phase :	Neutral
Function Type :	GSM 850 Idle + Bluetooth Link + WLAN Link (2.4G) + USB Cable (Charging from Adapter1) + Earphone 1 for Sample 1		

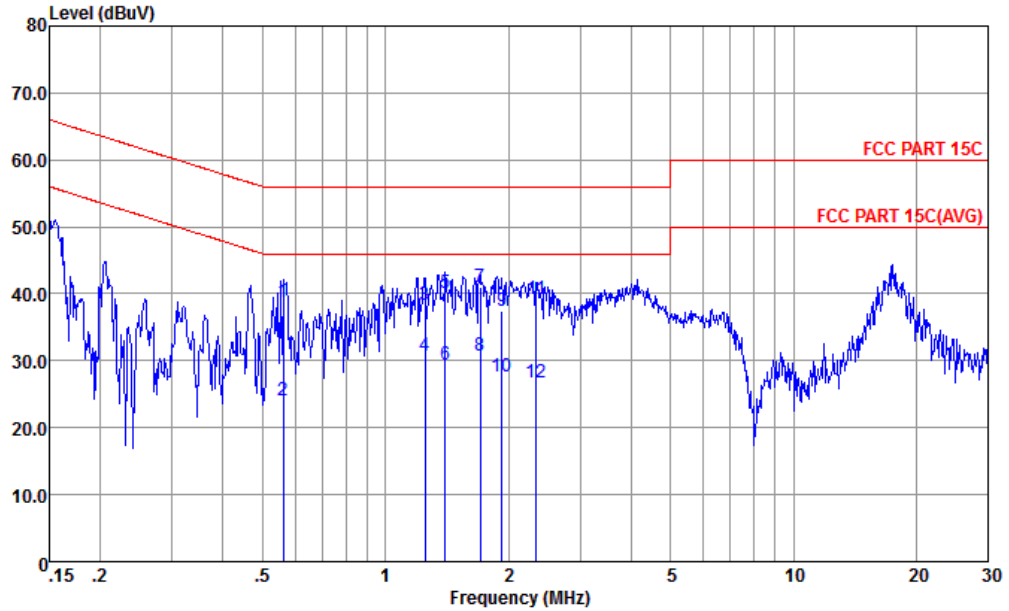

Site : CO01-KS
 Condition : FCC PART 15C LISN-N-171013-060103 NEUTRAL

mode : Mode 1
 : 354123090006638/354123090006646 #8

	Freq	Level	Over Limit	Limit Line	Read Level	LISN Factor	Cable Loss	Remark
	MHz	dBuV	dB	dBuV	dBuV	dB	dB	
1	0.561	38.75	-17.25	56.00	28.20	0.29	10.26	QP
2	0.561	24.05	-21.95	46.00	13.50	0.29	10.26	Average
3	1.249	38.36	-17.64	56.00	27.91	0.31	10.14	QP
4	1.249	30.66	-15.34	46.00	20.21	0.31	10.14	Average
5	1.403	40.07	-15.93	56.00	29.60	0.31	10.16	QP
6	1.403	29.37	-16.63	46.00	18.90	0.31	10.16	Average
7 *	1.707	41.01	-14.99	56.00	30.50	0.32	10.19	QP
8	1.707	30.81	-15.19	46.00	20.30	0.32	10.19	Average
9	1.928	37.43	-18.57	56.00	26.90	0.32	10.21	QP
10	1.928	27.73	-18.27	46.00	17.20	0.32	10.21	Average
11	2.346	39.33	-16.67	56.00	28.81	0.32	10.20	QP
12	2.346	26.73	-19.27	46.00	16.21	0.32	10.20	Average



3.3 Antenna Requirements

3.3.1 Standard Applicable

If directional gain of transmitting antennas is greater than 6dBi, the power shall be reduced by the same level in dB comparing to gain minus 6dBi. The use of a permanently attached antenna or of an antenna that uses a unique coupling to the intentional radiator shall be considered sufficient to comply with the rule.

3.3.2 Antenna Anti-Replacement Construction

An embedded-in antenna design is used.

3.3.3 Antenna Gain

The antenna peak gain of EUT is less than 6 dBi. Therefore, it is not necessary to reduce maximum peak output power limit.



4 List of Measuring Equipment

Instrument	Manufacturer	Model No.	Serial No.	Characteristics	Calibration Date	Test Date	Due Date	Remark
EMI Test Receiver	Keysight	N9038A	MY564000 04	3Hz~8.5GHz; Max 30dBm	Oct. 19, 2017	Jan. 23, 2018	Oct. 18, 2018	Radiation (03CH03-KS)
EXA Spectrum Analyzer	Keysight	N9010A	MY551502 44	10Hz-44GHz	Apr. 18, 2017	Jan. 23, 2018	Apr. 17, 2018	Radiation (03CH03-KS)
Loop Antenna	R&S	HFH2-Z2	100321	9kHz~30MHz	Oct. 22, 2017	Jan. 23, 2018	Oct. 21, 2018	Radiation (03CH03-KS)
Bilog Antenna	TeseQ	CBL6112D	35406	25MHz-2GHz	Apr. 22, 2017	Jan. 23, 2018	Apr. 21, 2018	Radiation (03CH03-KS)
Horn Antenna	Schwarzbeck	BBHA9120D	9120D-135 6	1GHz~18GHz	Apr. 22, 2017	Jan. 23, 2018	Apr. 21, 2018	Radiation (03CH03-KS)
SHF-EHF Horn	Schwarzbeck	BBHA 9170	BBHA1702 49	15GHz~40GHz	Feb. 15, 2017	Jan. 23, 2018	Feb. 14, 2018	Radiation (03CH03-KS)
Amplifier	com-power	PA-103A	161069	1MHz ~1000MHz / 32 dB	Apr. 18, 2017	Jan. 23, 2018	Apr. 17, 2018	Radiation (03CH03-KS)
Amplifier	MITEQ	TTA1840-35- HG	1887435	18GHz~40GHz	Oct. 12, 2017	Jan. 23, 2018	Oct. 11, 2018	Radiation (03CH03-KS)
high gain Amplifier	MITEQ	AMF-7D-0010 1800-30-10P	2025788	1Ghz-18Ghz	Apr. 18, 2017	Jan. 23, 2018	Apr. 17, 2018	Radiation (03CH03-KS)
AC Power Source	Chroma	61601	F1040900 04	N/A	NCR	Jan. 23, 2018	NCR	Radiation (03CH03-KS)
Turn Table	ChamPro	EM 1000-T	060762-T	0~360 degree	NCR	Jan. 23, 2018	NCR	Radiation (03CH03-KS)
Antenna Mast	ChamPro	EM 1000-A	060762-A	1 m~4 m	NCR	Jan. 23, 2018	NCR	Radiation (03CH03-KS)
EMI Receiver	R&S	ESCI7	100768	9kHz~7GHz;	Apr. 20, 2017	Dec. 30, 2017	Apr. 19, 2018	Conduction (CO01-KS)
AC LISN	MessTec	AN3016	060103	9kHz~30MHz	Oct. 13, 2017	Dec. 30, 2017	Oct. 12, 2018	Conduction (CO01-KS)
AC LISN (for auxiliary equipment)	MessTec	AN3016	060105	9kHz~30MHz	Oct. 13, 2017	Dec. 30, 2017	Oct. 12, 2018	Conduction (CO01-KS)
AC Power Source	Chroma	61602	ABP00000 0811	AC 0V~300V, 45Hz~1000Hz	Oct. 12, 2017	Dec. 30, 2017	Oct. 11, 2018	Conduction (CO01-KS)

NCR: No Calibration Required



5 Uncertainty of Evaluation

Uncertainty of Conducted Emission Measurement (150 kHz ~ 30 MHz)

Measuring Uncertainty for a Level of Confidence of 95% ($U = 2Uc(y)$)	2.3dB
---	-------

Uncertainty of Radiated Emission Measurement (30 MHz ~ 1000 MHz)

Measuring Uncertainty for a Level of Confidence of 95% ($U = 2Uc(y)$)	4.6dB
---	-------

Uncertainty of Radiated Emission Measurement (1000 MHz ~ 18000 MHz)

Measuring Uncertainty for a Level of Confidence of 95% ($U = 2Uc(y)$)	4.5dB
---	-------

Uncertainty of Radiated Emission Measurement (18000 MHz ~ 40000 MHz)

Measuring Uncertainty for a Level of Confidence of 95% ($U = 2Uc(y)$)	4.5dB
---	-------



Appendix A. Radiated Spurious Emission

2.4GHz 2400~2483.5MHz

BLE (Band Edge @ 3m)

BLE	Note	Frequency	Level	Over	Limit	Read	Antenna	Cable	Preamp	Ant	Table	Peak	Pol.
		(MHz)	(dBμV/m)	(dB)	(dBμV/m)	(dBμV)	(dB/m)	(dB)	(dB)	(cm)	(deg)	(P/A)	(H/V)
BLE CH 00 2402MHz		2358.49	46.52	-27.48	74	41.54	31.63	5.61	32.26	100	3	P	H
		2389.43	37.14	-16.86	54	32.09	31.7	5.65	32.3	100	3	A	H
	*	2402	94.32	-	-	89.27	31.7	5.65	32.3	100	3	P	H
	*	2402	93.86	-	-	88.81	31.7	5.65	32.3	100	3	A	H
		2378.51	47.1	-26.9	74	42.09	31.66	5.63	32.28	165	273	P	V
		2353.03	36.87	-17.13	54	31.89	31.63	5.61	32.26	165	273	A	V
	*	2402	92.29	-	-	87.24	31.7	5.65	32.3	165	273	P	V
	*	2402	92.04	-	-	86.99	31.7	5.65	32.3	165	273	A	V
BLE CH 19 2440MHz		2373.57	46.81	-27.19	74	41.8	31.66	5.63	32.28	303	7	P	H
		2350.43	36.91	-17.09	54	31.98	31.59	5.59	32.25	303	7	A	H
	*	2440	94.94	-	-	89.7	31.87	5.71	32.34	303	7	P	H
	*	2440	94.46	-	-	89.22	31.87	5.71	32.34	303	7	A	H
		2496.76	47.28	-26.72	74	41.86	32.04	5.77	32.39	303	7	P	H
		2486.08	37.42	-16.58	54	32.05	31.99	5.75	32.37	303	7	A	H
		2356.8	47.49	-26.51	74	42.51	31.63	5.61	32.26	264	245	P	V
		2358.49	36.86	-17.14	54	31.88	31.63	5.61	32.26	264	245	A	V
	*	2440	92.96	-	-	87.72	31.87	5.71	32.34	264	245	P	V
	*	2440	92.47	-	-	87.23	31.87	5.71	32.34	264	245	A	V
		2484.1	47.75	-26.25	74	42.38	31.99	5.75	32.37	264	245	P	V
		2484.34	37.26	-16.74	54	31.89	31.99	5.75	32.37	264	245	A	V



BLE CH 39 2480MHz		2497.6	46.67	-27.33	74	41.25	32.04	5.77	32.39	291	3	P	H
		2483.5	38.46	-15.54	54	33.09	31.99	5.75	32.37	291	3	A	H
	*	2480	92.91	-	-	87.54	31.99	5.75	32.37	291	3	P	H
	*	2480	92.06	-	-	86.69	31.99	5.75	32.37	291	3	A	H
		2484.94	47.24	-26.76	74	41.87	31.99	5.75	32.37	260	253	P	V
		2483.5	38.76	-15.24	54	33.39	31.99	5.75	32.37	260	253	A	V
	*	2480	92.62	-	-	87.25	31.99	5.75	32.37	260	253	P	V
	*	2480	92.09	-	-	86.72	31.99	5.75	32.37	260	253	A	V
Remark	<ol style="list-style-type: none"> No other spurious found. All results are PASS against Peak and Average limit line. 												



2.4GHz 2400~2483.5MHz
BLE (Harmonic @ 3m)

BLE	Note	Frequency (MHz)	Level (dBμV/m)	Over Limit (dB)	Limit Line (dBμV/m)	Read Level (dBμV)	Antenna Factor (dB/m)	Cable Loss (dB)	Preamp Factor (dB)	Ant Pos (cm)	Table Pos (deg)	Peak Avg. (P/A)	Pol. (H/V)
BLE CH 00 2402MHz		4806	43.53	-30.47	74	62.1	34.94	7.84	61.35	100	360	P	H
		4806	42.31	-31.69	74	60.88	34.94	7.84	61.35	100	0	P	V
BLE CH 19 2440MHz		4878	41.62	-32.38	74	59.93	34.99	7.9	61.2	100	0	P	H
		7320	40.05	-33.95	74	57.91	35.74	9.51	63.11	100	0	P	H
		4878	40.66	-33.34	74	58.97	34.99	7.9	61.2	100	7	P	V
BLE CH 39 2480MHz		7320	41.65	-32.35	74	59.51	35.74	9.51	63.11	100	7	P	V
		4962	42.75	-31.25	74	60.73	35.06	7.97	61.01	100	360	P	H
		7440	40.99	-33.01	74	59.07	35.57	9.57	63.22	100	360	P	H
		4962	42.01	-31.99	74	59.99	35.06	7.97	61.01	100	342	P	V
		7440	41.4	-32.6	74	59.48	35.57	9.57	63.22	100	342	P	V
Remark	1. No other spurious found. 2. All results are PASS against Peak and Average limit line.												



Emission below 1GHz

2.4GHz BLE (LF)

BLE	Note	Frequency	Level	Over	Limit	Read	Antenna	Cable	Preamp	Ant	Table	Peak	Pol.
		(MHz)	(dBμV/m)	(dB)	(dBμV/m)	(dBμV)	(dB/m)	(dB)	(dB)	(cm)	(deg)	(P/A)	(H/V)
2.4GHz BLE LF		30	25.04	-14.96	40	29.27	26.3	0.57	31.1	100	360	P	H
		54.25	23.43	-16.57	40	40.01	14.12	0.8	31.5	-	-	P	H
		83.35	21.51	-18.49	40	36.02	15.88	1.01	31.4	-	-	P	H
		129.91	25.65	-17.85	43.5	37.73	17.5	1.24	30.82	-	-	P	H
		148.34	25.27	-18.23	43.5	37.53	17.32	1.31	30.89	-	-	P	H
		296.75	20.56	-25.44	46	30.65	19.5	1.89	31.48	-	-	P	H
		36.79	26.69	-13.31	40	34.97	22.14	0.66	31.08	-	-	P	V
		82.38	26.02	-13.98	40	40.7	15.72	1	31.4	-	-	P	V
		103.72	20.68	-22.82	43.5	32.54	17.76	1.1	30.72	-	-	P	V
		223.03	26.57	-19.43	46	39.39	16.72	1.61	31.15	-	-	P	V
		450.98	36.4	-9.6	46	42.33	23.32	2.35	31.6	100	0	P	V
		555.74	28.72	-17.28	46	32.73	24.88	2.61	31.5	-	-	P	V
Remark	1. No other spurious found. 2. All results are PASS against limit line.												



Note symbol

*	Fundamental Frequency which can be ignored. However, the level of any unwanted emissions shall not exceed the level of the fundamental frequency.
!	Test result is over limit line.
P/A	Peak or Average
H/V	Horizontal or Vertical



A calculation example for radiated spurious emission is shown as below:

WIFI	Note	Frequency	Level	Over	Limit	Read	Antenna	Cable	Preamp	Ant	Table	Peak	Pol.
Ant.				Limit	Line	Level	Factor	Loss	Factor	Pos	Pos	Avg.	
1+2		(MHz)	(dBμV/m)	(dB)	(dBμV/m)	(dBμV)	(dB/m)	(dB)	(dB)	(cm)	(deg)	(P/A)	(H/V)
802.11b		2390	55.45	-18.55	74	54.51	32.22	4.58	35.86	103	308	P	H
CH 01													
2412MHz		2390	43.54	-10.46	54	42.6	32.22	4.58	35.86	103	308	A	H

- Level(dBμV/m) =
Antenna Factor(dB/m) + Cable Loss(dB) + Read Level(dBμV) - Preamp Factor(dB)
- Over Limit(dB) = Level(dBμV/m) – Limit Line(dBμV/m)

For Peak Limit @ 2390MHz:

- Level(dBμV/m)
= Antenna Factor(dB/m) + Cable Loss(dB) + Read Level(dBμV) - Preamp Factor(dB)
= 32.22(dB/m) + 4.58(dB) + 54.51(dBμV) – 35.86 (dB)
= 55.45 (dBμV/m)
- Over Limit(dB)
= Level(dBμV/m) – Limit Line(dBμV/m)
= 55.45(dBμV/m) – 74(dBμV/m)
= -18.55(dB)

For Average Limit @ 2390MHz:

- Level(dBμV/m)
= Antenna Factor(dB/m) + Cable Loss(dB) + Read Level(dBμV) - Preamp Factor(dB)
= 32.22(dB/m) + 4.58(dB) + 42.6(dBμV) – 35.86 (dB)
= 43.54 (dBμV/m)
- Over Limit(dB)
= Level(dBμV/m) – Limit Line(dBμV/m)
= 43.54(dBμV/m) – 54(dBμV/m)
= -10.46(dB)

Both peak and average measured complies with the limit line, so test result is “PASS”.



Appendix B. Duty Cycle Plots

Band	Duty Cycle(%)	T(ms)	1/T(kHz)	VBW Setting
Bluetooth v4.2 LE	62.41	0.390	2.565	3KHz

Bluetooth v4.2 LE

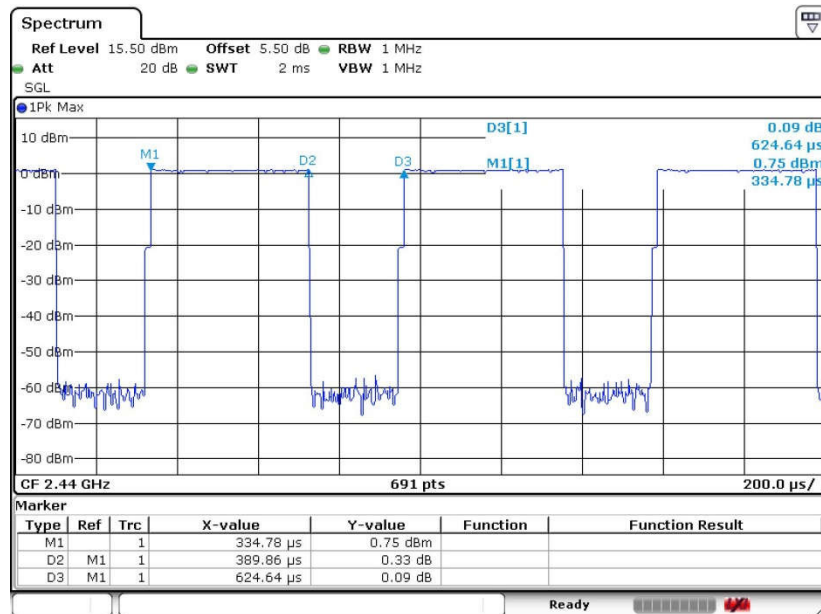



Appendix D. Reference Report

Please refer to Sporton report number FR7D0507B which is issued separately.