



FCC Test Report

APPLICANT : Motorola Mobility LLC
EQUIPMENT : Mobile Cellular Phone
BRAND NAME : Motorola
MODEL NAME : XT1944-2
FCC ID : IHDT56XF3
STANDARD : FCC 47 CFR FCC Part 15 Subpart B
CLASSIFICATION : Certification

The product was received on Dec. 20, 2017 and testing was completed on Jan. 06, 2018. We, Sporton International (Kunshan) Inc., would like to declare that the tested sample has been evaluated in accordance with the test procedures given in ANSI C63.4-2014 and has been in compliance with the applicable technical standards.

The test results in this report apply exclusively to the tested model / sample. Without written approval of Sporton International (Kunshan) Inc., the test report shall not be reproduced except in full.



Approved by: James Huang / Manager

Sporton International (Kunshan) Inc.
No.3-2 Ping-Xiang Rd, Kunshan Development Zone Kunshan City Jiangsu Province 215335
China



TABLE OF CONTENTS

REVISION HISTORY..... 3

SUMMARY OF TEST RESULT 4

1. GENERAL DESCRIPTION 5

 1.1. Applicant..... 5

 1.2. Manufacturer 5

 1.3. Product Feature of Equipment Under Test 5

 1.4. Product Specification of Equipment Under Test 6

 1.5. Specification of Accessory 7

 1.6. Modification of EUT 8

 1.7. Test Location 8

 1.8. Applicable Standards 8

2. TEST CONFIGURATION OF EQUIPMENT UNDER TEST 9

 2.1. Test Mode 9

 2.2. Connection Diagram of Test System 11

 2.3. Support Unit used in test configuration and system 13

 2.4. EUT Operation Test Setup 13

3. TEST RESULT 14

 3.1. Test of AC Conducted Emission Measurement 14

 3.2. Test of Radiated Emission Measurement 20

4. LIST OF MEASURING EQUIPMENT 26

5. UNCERTAINTY OF EVALUATION 27

APPENDIX A. SETUP PHOTOGRAPHS



REVISION HISTORY

REPORT NO.	VERSION	DESCRIPTION	ISSUED DATE
FC7D2007-02	Rev. 01	Initial issue of report	Feb. 24, 2018



SUMMARY OF TEST RESULT

Report Section	FCC Rule	Description	Limit	Result	Remark
3.1	15.107	AC Conducted Emission	< 15.107 limits	PASS	Under limit 9.13 dB at 0.157 MHz
3.2	15.109	Radiated Emission	< 15.109 limits	PASS	Under limit 9.44 dB at 45.930 MHz



1. General Description

1.1. Applicant

Motorola Mobility LLC
222 W, Merchandise Mart Plaza, Chicago IL 60654 USA

1.2. Manufacturer

Motorola Mobility LLC
222 W, Merchandise Mart Plaza, Chicago IL 60654 USA

1.3. Product Feature of Equipment Under Test

Product Feature	
Equipment	Mobile Cellular Phone
Brand Name	Motorola
Model Name	XT1944-2
FCC ID	IHDT56XF3
EUT supports Radios application	GSM/GPRS/EGPRS/WCDMA/HSPA/DC-HSDPA/ HSPA+(16QAM uplink is not supported)/LTE WLAN 2.4GHz 802.11b/g/n HT20 Bluetooth v3.0+ EDR / Bluetooth v4.0 LE/ Bluetooth v4.1 LE / Bluetooth v4.2 LE
IMEI Code	Conduction: 3541230090007599/3541230090007607 Radiation: 3541230090006674/3541230090006682
HW Version	DVT1B
SW Version	nora_row_n-userdebug 8.0.0 OPP27.60 222 intcfg,test-keys
EUT Stage	Identical Prototype

Remark: The above EUT's information was declared by manufacturer. Please refer to the specifications or user's manual for more detailed description.



1.4. Product Specification of Equipment Under Test

Standards-related Product Specification	
Tx Frequency	GSM850: 824.2 MHz ~ 848.8 MHz GSM1900: 1850.2 MHz ~ 1909.8MHz WCDMA Band V: 826.4 MHz ~ 846.6 MHz WCDMA Band II: 1852.4 MHz ~ 1907.6 MHz LTE Band 5 : 824.7 MHz ~ 848.3 MHz LTE Band 7 :2502.5 MHz ~ 2567.5 MHz LTE Band 38 :2572.5 MHz ~ 2617.5 MHz 802.11b/g/n: 2412 MHz ~ 2462 MHz Bluetooth: 2402 MHz ~ 2480 MHz
Rx Frequency	GSM850: 869.2 MHz ~ 893.8 MHz GSM1900: 1930.2 MHz ~ 1989.8 MHz WCDMA Band V: 871.4 MHz ~ 891.6 MHz WCDMA Band II: 1932.4 MHz ~ 1987.6 MHz LTE Band 5 : 869.7 MHz ~ 893.3 MHz LTE Band 7 : 2622.5MHz ~ 2687.5 MHz LTE Band 38 :2572.5 MHz ~ 2617.5 MHz 802.11b/g/n: 2412 MHz ~ 2462 MHz Bluetooth: 2402 MHz ~ 2480 MHz GNSS: 1559 MHz to 1610 MHz FM : 87.5 MHz ~ 108 MHz
Antenna Type	WWAN : LDS Antenna WLAN : Monopole Antenna Bluetooth : Monopole Antenna GNSS: Monopole Antenna FM: External headset Antenna
Type of Modulation	GSM: GMSK GPRS: GMSK EDGE(MCS 0-4): GMSK / (MCS 5-9): 8PSK WCDMA : BPSK (Uplink) HSDPA/DC-HSDPA : QPSK (Uplink) HSUPA : QPSK (Uplink) HSPA+ : 16QAM(Uplink is not supported) DC-HSDPA : 64QAM LTE: QPSK / 16QAM 802.11b : DSSS (DBPSK / DQPSK / CCK) 802.11g/n : OFDM (BPSK / QPSK / 16QAM / 64QAM) Bluetooth LE : GFSK Bluetooth (1Mbps) : GFSK Bluetooth (2Mbps) : π /4-DQPSK Bluetooth (3Mbps) : 8-DPSK GNSS : BPSK FM



1.5. Specification of Accessory

Specification of Accessory				
AC Adapter 1 (US)	Brand Name	Motorola (Acbel)	Model Name	SPN5945A C-P35
	Power Rating	I/P: 100-240 Vac, 300mA, O/P: 5.2Vdc,2000mA		
AC Adapter 1 (EU)	Brand Name	Motorola (Acbel)	Model Name	SPN5944A C-P36
	Power Rating	I/P: 100-240 Vac, 300mA, O/P: 5.2Vdc,2000mA		
AC Adapter 1 (UK)	Brand Name	Motorola (Acbel)	Model Name	SPN5940A C-P37
	Power Rating	I/P: 100-240 Vac, 300mA, O/P: 5.2Vdc,2000mA		
AC Adapter 1 (IN)	Brand Name	Motorola (Acbel)	Model Name	SA18C1949 C-P49
	Power Rating	I/P: 100-240 Vac, 300mA, O/P: 5.2Vdc,2000mA		
AC Adapter 1 (AU)	Brand Name	Motorola (Acbel)	Model Name	SPN5953A C-P48
	Power Rating	I/P: 100-240 Vac, 300mA, O/P: 5.2Vdc,2000mA		
AC Adapter 1 (AR)	Brand Name	Motorola (Acbel)	Model Name	SPN5942A C-P47
	Power Rating	I/P: 100-240 Vac, 500mA, O/P: 5.2Vdc,2000mA		
AC Adapter 2 (US)	Brand Name	Motorola (Salom)	Model Name	SSW-2919UMTJ C-P35 SPN5945A
	Power Rating	I/P: 100-240 Vac, 300mA, O/P: 5.2Vdc,2000mA		
AC Adapter 2 (EU)	Brand Name	Motorola (Salom)	Model Name	SSW-2919EU C-P36 SPN5944A
	Power Rating	I/P: 100-240 Vac, 300mA, O/P: 5.2Vdc,2000mA		
AC Adapter 2 (UK)	Brand Name	Motorola (Salom)	Model Name	SSW-2919UK C-P37 SPN5940A
	Power Rating	I/P: 100-240 Vac, 300mA, O/P: 5.2Vdc,2000mA		
AC Adapter 2 (AU)	Brand Name	Motorola (Salom)	Model Name	SSW-2919AU C-P48 SPN5953A
	Power Rating	I/P: 100-240 Vac, 300mA, O/P: 5.2Vdc,2000mA		
AC Adapter 2 (AR)	Brand Name	Motorola (Salom)	Model Name	SSW-2919AR C-P47 SPN5955A
	Power Rating	I/P: 100-240 Vac, 500mA, O/P: 5.2Vdc,2000mA		
Battery	Brand Name	Lenovo (SCUD)	Model Name	BL270
	Power Rating	3.85/4.4Vdc,4000mAh	Type	Li-ion
Earphone	Brand Name	Motorola (NEW Leaders)	Model Name	NLD-EM300V-01SF
	Signal Line Type	1.2 meter, non-shielded cable, without ferrite core		
USB Cable	Brand Name	Motorola (Saibao)	Model Name	SLQ-A081A
	Signal Line Type	1.0 meter, shielded cable, without ferrite core		



1.6. Modification of EUT

No modifications are made to the EUT during all test items.

1.7. Test Location

Sporton International (Kunshan) Inc. is accredited to ISO 17025 by National Voluntary Laboratory Accreditation Program (NVLAP code: 600155-0) and the FCC designation No. is CN5013.

Test Site	Sporton International (Kunshan) Inc.		
Test Site Location	No.3-2 Ping-Xiang Rd, Kunshan Development Zone Kunshan City Jiangsu Province 215335 China TEL : +86-512-57900158 FAX : +86-512-57900958		
Test Site No.	Sporton Site No.		FCC Test Firm Registration No.
	CO01-KS	03CH02-KS	630927

Note: The test site complies with ANSI C63.4 2014 requirement.

1.8. Applicable Standards

According to the specifications of the manufacturer, the EUT must comply with the requirements of the following standards:

- ♦ FCC 47 CFR FCC Part 15 Subpart B
- ♦ ANSI C63.4-2014

Remark: All test items were verified and recorded according to the standards and without any deviation during the test.



2. Test Configuration of Equipment Under Test

2.1. Test Mode

The EUT has been associated with peripherals pursuant to ANSI C63.4-2014 and configuration operated in a manner tended to maximize its emission characteristics in a typical application.

Frequency range investigated: conduction (150 kHz to 30 MHz), radiation (30MHz to the 5th harmonic of the highest fundamental frequency or to 40 GHz, whichever is lower).

Test Items	Function Type
AC Conducted Emission	Mode 1: GSM850 Idle + Bluetooth Idle + WLAN Idle + USB Cable (Charging from Adapter 1) + Earphone + Battery + Camera (Rear) + SIM 1<Fig.1>
	Mode 2: GSM1900 Idle + Bluetooth Idle + WLAN Idle + USB Cable (Charging from Adapter 1) + Earphone + Battery + Camera (Front) + SIM 2 <Fig.1>
	Mode 3: WCDMA Band V Idle + Bluetooth Idle + WLAN Idle + USB Cable (Charging from Adapter 1) + Earphone + Battery + MPEG4 + SIM 1 <Fig.1>
	Mode 4: WCDMA Band II Idle + Bluetooth Idle + WLAN Idle + USB Cable (Charging from Adapter 1) + Earphone + Battery + GNSS Rx + SIM 2 <Fig.2>
	Mode 5: GSM850 Idle + Bluetooth Idle + WLAN Idle + USB Cable (Charging from Adapter 2) + Earphone + Battery + Camera (Rear) + SIM 1<Fig.1>
	Mode 6: USB Cable (Charging from Adapter 1) + Earphone + Battery + FM Rx (88MHz)<Fig.3>
	Mode 7: USB Cable (Charging from Adapter 1) + Earphone + Battery + FM Rx (98MHz)<Fig.3>
	Mode 8: USB Cable (Charging from Adapter 1) + Earphone + Battery + FM Rx (108MHz)<Fig.3>
	Mode 9: USB Cable (Charging from Adapter 2) + Earphone + Battery + FM Rx (98MHz)<Fig.3>
	Mode 10 : LTE Band 7 Idle + Bluetooth Idle + WLAN Idle + Earphone + USB Cable (Data Link with Notebook) + Battery + GNSS Rx + SIM 1<Fig.4>



Radiated Emissions < 1GHz	<p>Mode 1: GSM850 Idle + Bluetooth Idle + WLAN Idle + USB Cable (Charging from Adapter 1) + Earphone + Battery + Camera (Rear) + SIM 1<Fig.1></p> <p>Mode 2: GSM1900 Idle + Bluetooth Idle + WLAN Idle + USB Cable (Charging from Adapter 1) + Earphone + Battery + Camera (Front) + SIM 2 <Fig.1></p> <p>Mode 3: WCDMA Band V Idle + Bluetooth Idle + WLAN Idle + USB Cable (Charging from Adapter 1) + Earphone + Battery + MPEG4 + SIM 1 <Fig.1></p> <p>Mode 4: WCDMA Band II Idle + Bluetooth Idle + WLAN Idle + USB Cable (Charging from Adapter 1) + Earphone + Battery + GNSS Rx + SIM 2 <Fig.2></p> <p>Mode 5: GSM1900 Idle + Bluetooth Idle + WLAN Idle + USB Cable (Charging from Adapter 2) + Earphone + Battery + Camera (Front) + SIM 2<Fig.1></p> <p>Mode 6: USB Cable (Charging from Adapter 1) + Earphone + Battery + FM Rx (88MHz)<Fig.3></p> <p>Mode 7: USB Cable (Charging from Adapter 1) + Earphone + Battery + FM Rx (98MHz)<Fig.3></p> <p>Mode 8: USB Cable (Charging from Adapter 1) + Earphone + Battery + FM Rx (108MHz)<Fig.3></p> <p>Mode 9: USB Cable (Charging from Adapter 2) + Earphone + Battery + FM Rx (88MHz)<Fig.3></p> <p>Mode 10 : LTE Band 7 Idle + Bluetooth Idle + WLAN Idle + Earphone + USB Cable (Data Link with Notebook) + Battery + GNSS Rx + SIM 1<Fig.4></p>
Radiated Emissions ≥ 1GHz	<p>Mode 1: USB Cable (Charging from Adapter 2) + Earphone + Battery + FM Rx (88MHz) <Fig.3></p> <p>Mode 2: LTE Band 7 Idle + Bluetooth Idle + WLAN Idle + Earphone + USB Cable (Data Link with Notebook) + Battery + GNSS Rx + SIM 1<Fig.4></p>
<p>Remark:</p> <ol style="list-style-type: none"> 1. The worst case of AC is mode 7, and the USB Link mode of AC is mode 10; the test data of these modes were reported. 2. The worst case of RE < 1G is mode 9, and the USB Link mode of RE is mode 10; the test data of these modes were reported. 	

2.2. Connection Diagram of Test System

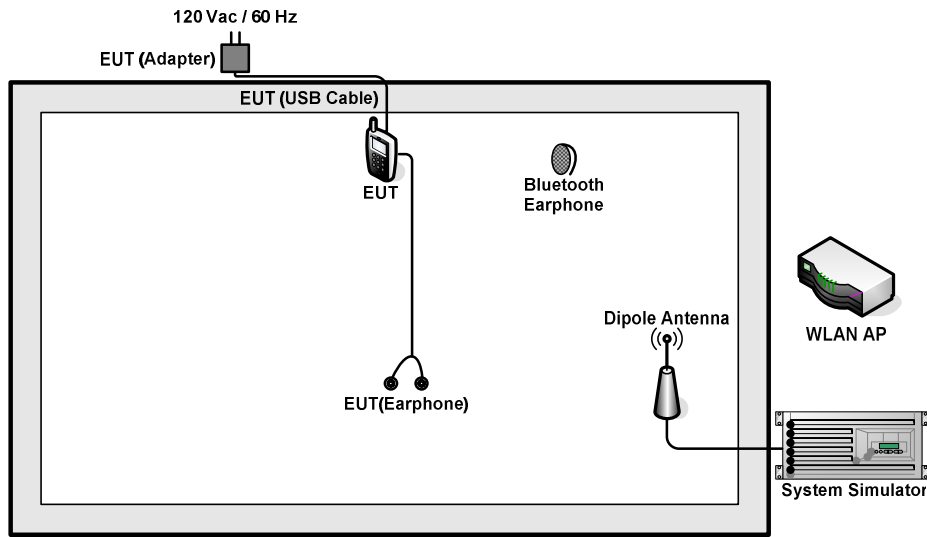

<Fig.1>

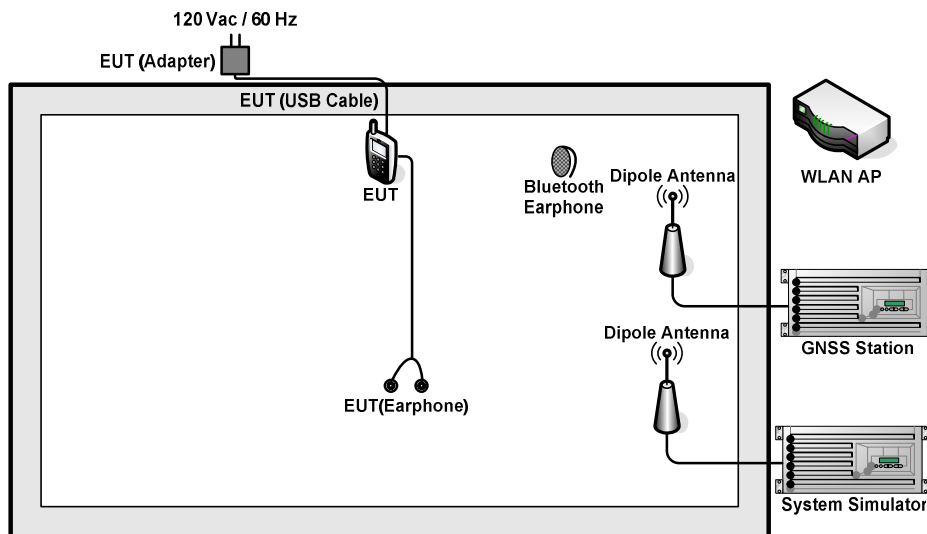

<Fig.2>

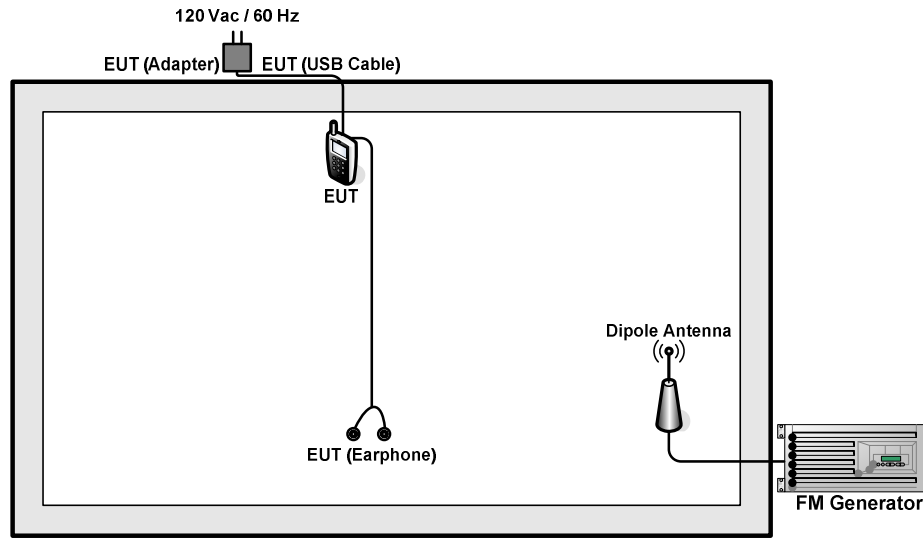

<Fig.3>

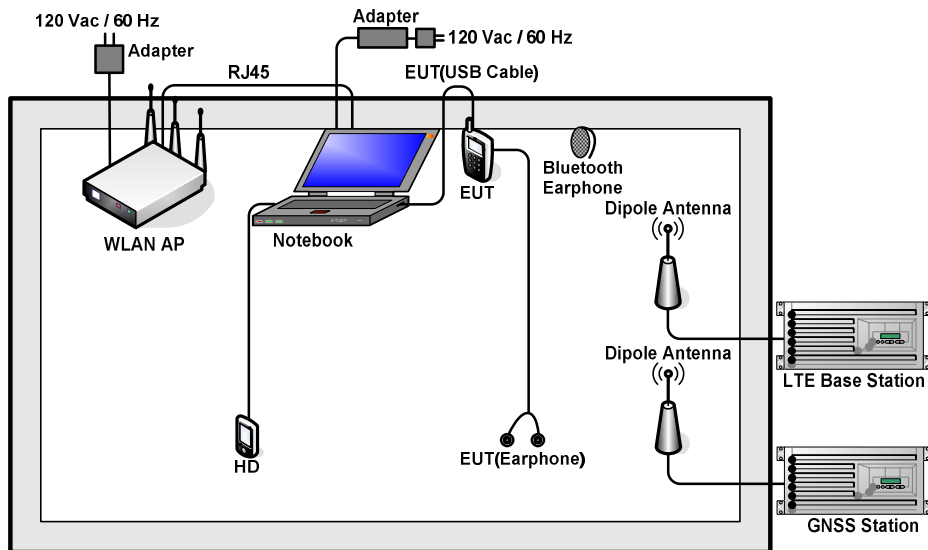

<Fig.4>

2.3. Support Unit used in test configuration and system

Item	Equipment	Trade Name	Model Name	FCC ID	Data Cable	Power Cord
1.	LTE Base Station	Anritsu	MT8820C	N/A	N/A	Unshielded, 1.8 m
2.	System Simulator	R&S	CMU 200	N/A	N/A	Unshielded, 1.8 m
3.	GNSS Station	ADIVIC	MP9000	N/A	N/A	Unshielded, 1.8 m
4.	FM Generator	R&S	SMBV100A	N/A	N/A	Unshielded, 1.8 m
5.	WLAN AP	D-Link	DIR-855	KA2DIR855A2	N/A	Unshielded, 1.8 m
6.	WLAN AP	TP-Link	TL-WDR5600	N/A	N/A	Unshielded, 1.8 m
7.	Notebook	Lenovo	Y510P	N/A	N/A	AC I/P: Unshielded, 1.8 m DC O/P: Shielded, 1.8 m
8.	Notebook	Lenovo	G480	N/A	N/A	AC I/P: Unshielded, 1.8 m DC O/P: Shielded, 1.8 m
9.	Bluetooth Earphone	Lenovo	LBH308	N/A	N/A	N/A
10.	Hard Disk	Lenovo	F310	FCC DoC	Shielded, 0.5 m	N/A
11.	SD Card	Kingston	8GB	N/A	N/A	N/A
12.	SD Card	SanDisk	Uitra	N/A	N/A	N/A
13.	GNSS Station	RACELOGIC	RLLS03-2RP	N/A	N/A	Unshielded, 1.8 m

2.4. EUT Operation Test Setup

The EUT was in GSM or WCDMA or LTE idle mode during the testing. The EUT was synchronized to the BCCH, and is in continuous receiving mode by setting system simulator’s paging reorganization.

At the same time, the EUT was attached to the Bluetooth earphone or WLAN AP, and the following programs installed in the EUT were programmed during the test.

1. Data application is transferred between Notebook and EUT via USB cable.
2. Turn on GNSS function to make the EUT receive continuous signals from GNSS station.
3. Turn on FM function to make the EUT receive continuous signals from FM Generator.
4. Execute “Video Player” to play MPEG4 files.
5. Turn on camera to capture images.



3. Test Result

3.1. Test of AC Conducted Emission Measurement

3.1.1 Limits of AC Conducted Emission

For equipment that is designed to be connected to the public utility (AC) power line, the radio frequency voltage that is conducted back onto the AC power line on any frequency or frequencies within the band 150 kHz to 30 MHz shall not exceed the limits in the following table.

Frequency of emission (MHz)	Conducted limit (dBuV)	
	Quasi-peak	Average
0.15-0.5	66 to 56*	56 to 46*
0.5-5	56	46
5-30	60	50

*Decreases with the logarithm of the frequency.

3.1.2 Measuring Instruments

The measuring equipment is listed in the section 4 of this test report.

3.1.3 Test Procedure

1. The EUT was placed 0.4 meter from the conducting wall of the shielding room was kept at least 80 centimeters from any other grounded conducting surface.
2. Connect EUT to the power mains through a line impedance stabilization network (LISN).
3. All the support units are connecting to the other LISN.
4. The LISN provides 50 ohm coupling impedance for the measuring instrument.
5. The FCC states that a 50 ohm, 50 microhenry LISN should be used.
6. Both sides of AC line were checked for maximum conducted interference.
7. The frequency range from 150 kHz to 30 MHz was searched.
8. Set the test-receiver system to Peak Detect Function and specified bandwidth (IF Bandwidth = 9kHz) with Maximum Hold Mode. Then measurement is also conducted by Average Detector and Quasi-Peak Detector Function respectively.

3.1.4 Test Setup

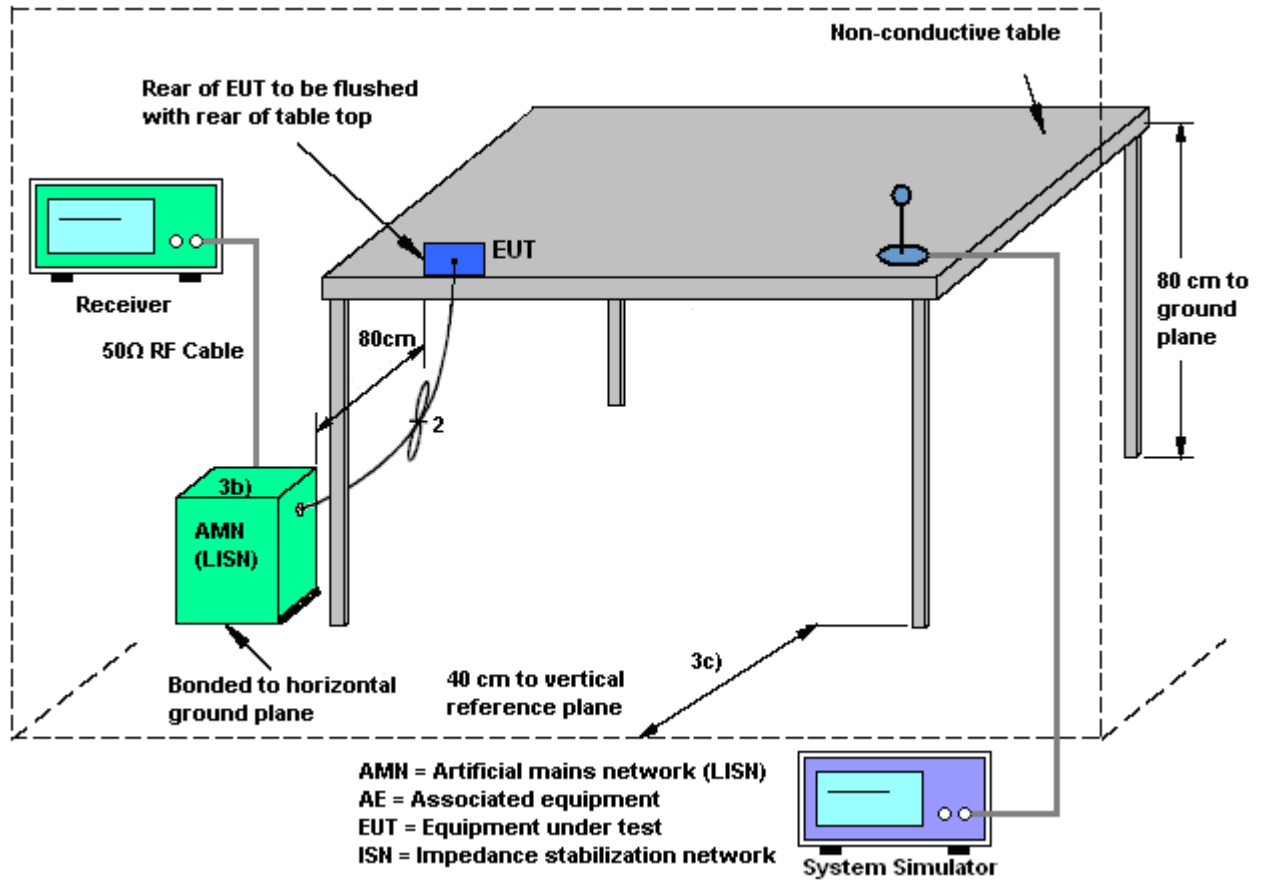



3.1.5 Test Result of AC Conducted Emission

Test Mode :	Mode 7	Temperature :	22~24°C
Test Engineer :	Amos Zhang	Relative Humidity :	42~44%
Test Voltage :	120Vac / 60Hz	Phase :	Line
Function Type :	USB Cable (Charging from Adapter 1) + Earphone + Battery + FM Rx (98MHz)		

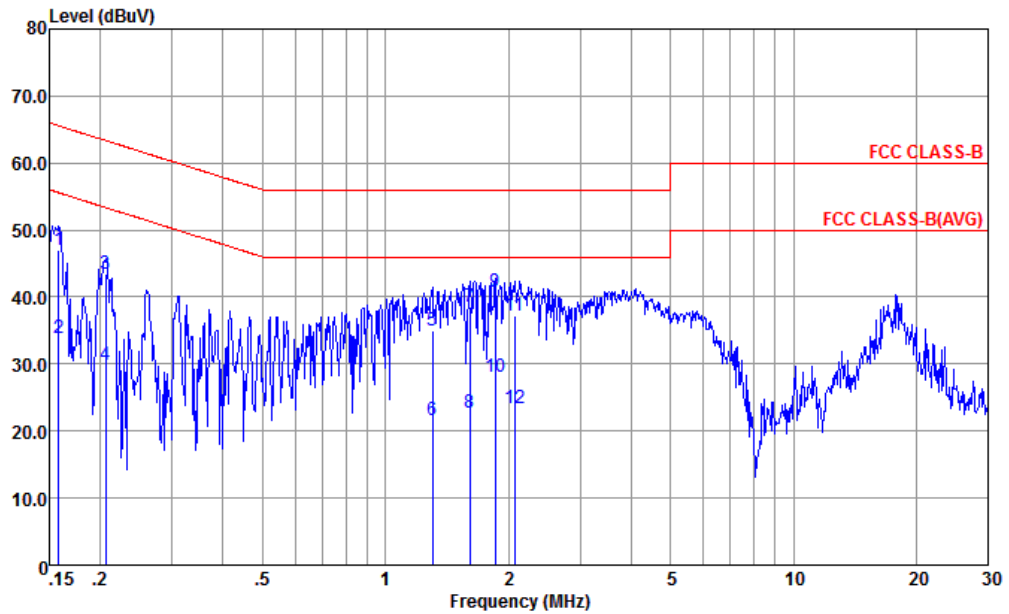

Site : CO01-KS
 Condition : FCC CLASS-B LISN-L-171013-060103 LINE
 Project : (FC) 7D2007-02

: 354130090007599/354130090007607 #9

	Freq	Level	Over Limit	Limit	Read	LISN	Cable	Remark
	MHz	dBuV	dB	dBuV	dBuV	dB	dB	
1	0.158	47.06	-18.50	65.56	36.30	0.17	10.59	QP
2	0.158	33.96	-21.60	55.56	23.20	0.17	10.59	Average
3	0.206	43.56	-19.80	63.36	32.91	0.20	10.45	QP
4	0.206	29.86	-23.50	53.36	19.21	0.20	10.45	Average
5	1.303	34.92	-21.08	56.00	24.50	0.27	10.15	QP
6	1.303	21.62	-24.38	46.00	11.20	0.27	10.15	Average
7	1.610	38.65	-17.35	56.00	28.20	0.27	10.18	QP
8	1.610	22.65	-23.35	46.00	12.20	0.27	10.18	Average
9 *	1.858	40.68	-15.32	56.00	30.20	0.28	10.20	QP
10	1.858	27.98	-18.02	46.00	17.50	0.28	10.20	Average
11	2.077	37.30	-18.70	56.00	26.81	0.28	10.21	QP
12	2.077	23.40	-22.60	46.00	12.91	0.28	10.21	Average



Test Mode :	Mode 7	Temperature :	22~24°C
Test Engineer :	Amos Zhang	Relative Humidity :	42~44%
Test Voltage :	120Vac / 60Hz	Phase :	Neutral
Function Type :	USB Cable (Charging from Adapter 1) + Earphone + Battery + FM Rx (98MHz)		

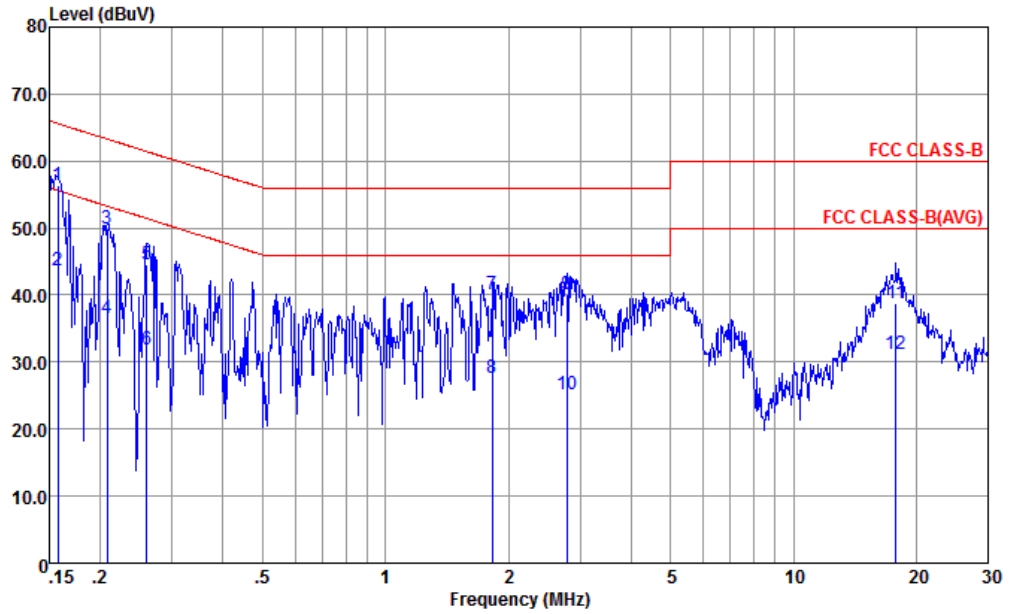

Site : CO01-KS
 Condition : FCC CLASS-B LISN-N-171013-060103 NEUTRAL
 Project : (FC) 7D2007-02

: 354130090007599/354130090007607 #9

	Freq	Level	Over Limit	Limit Line	Read Level	LISN Factor	Cable Loss	Remark
	MHz	dBuV	dB	dBuV	dBuV	dB	dB	
1 *	0.157	56.47	-9.13	65.60	45.60	0.28	10.59	QP
2	0.157	43.77	-11.83	55.60	32.90	0.28	10.59	Average
3	0.208	49.93	-13.34	63.27	39.20	0.28	10.45	QP
4	0.208	36.63	-16.64	53.27	25.90	0.28	10.45	Average
5	0.260	44.62	-16.80	61.42	33.90	0.28	10.44	QP
6	0.260	31.82	-19.60	51.42	21.10	0.28	10.44	Average
7	1.829	40.12	-15.88	56.00	29.60	0.32	10.20	QP
8	1.829	27.72	-18.28	46.00	17.20	0.32	10.20	Average
9	2.779	40.02	-15.98	56.00	29.50	0.33	10.19	QP
10	2.779	25.12	-20.88	46.00	14.60	0.33	10.19	Average
11	17.849	38.80	-21.20	60.00	28.20	0.15	10.45	QP
12	17.849	31.10	-18.90	50.00	20.50	0.15	10.45	Average



Test Mode :	Mode 10	Temperature :	22~24°C
Test Engineer :	Amos Zhang	Relative Humidity :	42~44%
Test Voltage :	120Vac / 60Hz	Phase :	Line
Function Type :	LTE Band 7 Idle + Bluetooth Idle + WLAN Idle + Earphone + USB Cable (Data Link with Notebook) + Battery + GNSS Rx + SIM 1		

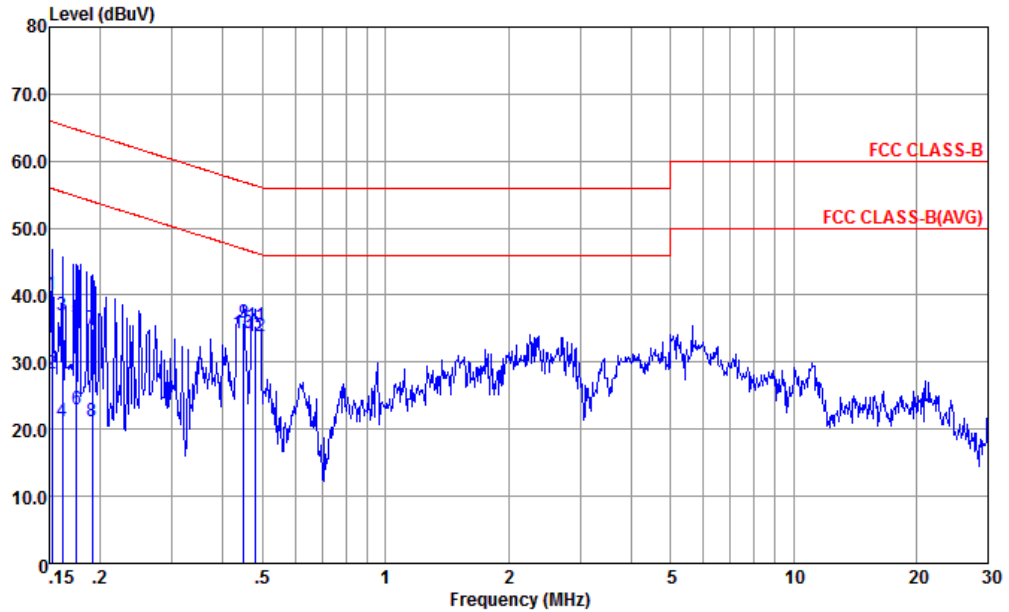

Site : CO01-KS
 Condition : FCC CLASS-B LISN-L-171013-060103 LINE
 Project : (FC) 7D2007-01

: 354130090007599/354130090007607 #9

	Freq	Level	Over Limit	Limit	Read	LISN	Cable	Loss	Remark
	MHz	dBuV		dB	dBuV	dB	dB		
1	0.152	40.07	-25.80	65.87	29.30	0.16	10.61		QP
2	0.152	28.27	-27.60	55.87	17.50	0.16	10.61		Average
3	0.162	37.05	-28.33	65.38	26.30	0.17	10.58		QP
4	0.162	21.25	-34.13	55.38	10.50	0.17	10.58		Average
5	0.175	36.51	-28.21	64.72	25.80	0.18	10.53		QP
6	0.175	22.91	-31.81	54.72	12.20	0.18	10.53		Average
7	0.191	34.88	-29.10	63.98	24.21	0.19	10.48		QP
8	0.191	21.28	-32.70	53.98	10.61	0.19	10.48		Average
9	0.449	35.91	-20.98	56.89	25.30	0.25	10.36		QP
10	0.449	34.21	-12.68	46.89	23.60	0.25	10.36		Average
11	0.481	35.38	-20.94	56.32	24.80	0.26	10.32		QP
12 *	0.481	33.78	-12.54	46.32	23.20	0.26	10.32		Average



Test Mode :	Mode 10	Temperature :	22~24°C
Test Engineer :	Amos Zhang	Relative Humidity :	42~44%
Test Voltage :	120Vac / 60Hz	Phase :	Neutral
Function Type :	LTE Band 7 Idle + Bluetooth Idle + WLAN Idle + Earphone + USB Cable (Data Link with Notebook) + Battery + GNSS Rx + SIM 1		

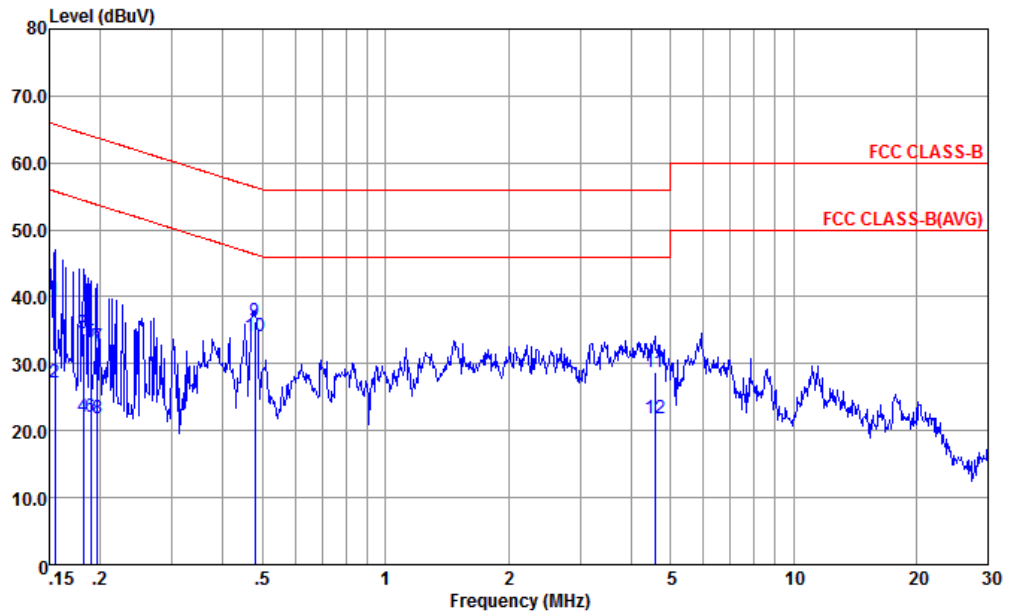

Site : CO01-KS
 Condition : FCC CLASS-B LISN-N-171013-060103 NEUTRAL
 Project : (FC) 7D2903-01

: 354130090007599/354130090007607 #9

	Freq	Level	Over Limit	Limit Line	Read Level	LISN Factor	Cable Loss	Remark
	MHz	dBuV	dB	dBuV	dBuV	dB	dB	
1	0.155	39.38	-26.36	65.74	28.50	0.28	10.60	QP
2	0.155	27.18	-28.56	55.74	16.30	0.28	10.60	Average
3	0.182	34.59	-29.83	64.42	23.80	0.28	10.51	QP
4	0.182	21.99	-32.43	54.42	11.20	0.28	10.51	Average
5	0.189	33.27	-30.79	64.06	22.50	0.28	10.49	QP
6	0.189	21.97	-32.09	54.06	11.20	0.28	10.49	Average
7	0.197	32.53	-31.23	63.76	21.78	0.28	10.47	QP
8	0.197	21.95	-31.81	53.76	11.20	0.28	10.47	Average
9	0.479	36.41	-19.95	56.36	25.80	0.29	10.32	QP
10 *	0.479	34.01	-12.35	46.36	23.40	0.29	10.32	Average
11	4.574	28.74	-27.26	56.00	18.19	0.34	10.21	QP
12	4.574	21.84	-24.16	46.00	11.29	0.34	10.21	Average



3.2. Test of Radiated Emission Measurement

3.2.1. Limit of Radiated Emission

The emissions from an unintentional radiator shall not exceed the field strength levels specified in the following table:

Frequency (MHz)	Field Strength (microvolts/meter)	Measurement Distance (meters)
30 – 88	100	3
88 – 216	150	3
216 - 960	200	3
Above 960	500	3

3.2.2. Measuring Instruments

The measuring equipment is listed in the section 4 of this test report.

3.2.3. Test Procedures

1. The EUT was placed on a turntable with 0.8 meter above ground.
2. The EUT was set 3 meters from the interference receiving antenna, which was mounted on the top of a variable height antenna tower.
3. The table was rotated 360 degrees to determine the position of the highest radiation.
4. The antenna is a Bi-Log antenna and its height is adjusted between one to four meters above ground to find the maximum value of the field strength for both horizontal polarization and vertical polarization of the antenna.
5. For each suspected emission, the EUT was arranged to its worst case and then tune the antenna tower (from 1 m to 4 m) and turntable (from 0 degree to 360 degrees) to find the maximum reading.
6. Set the test-receiver system to Peak Detect Function and specified bandwidth with Maximum Hold Mode (RBW=120kHz/VBW=300kHz for frequency below 1GHz; RBW=1MHz VBW=3MHz (Peak), RBW=1MHz/VBW=10Hz (Average) for frequency above 1GHz).
7. If the emission level of the EUT in peak mode was 3 dB lower than the limit specified, peak values of EUT will be reported. Otherwise, the emission will be repeated by using the quasi-peak method and reported.
8. Emission level (dBµV/m) = 20 log Emission level (µV/m)
9. Corrected Reading: Antenna Factor + Cable Loss + Read Level - Preamp Factor = Level

3.2.4. Test Setup of Radiated Emission

For radiated emissions from 30MHz to 1GHz

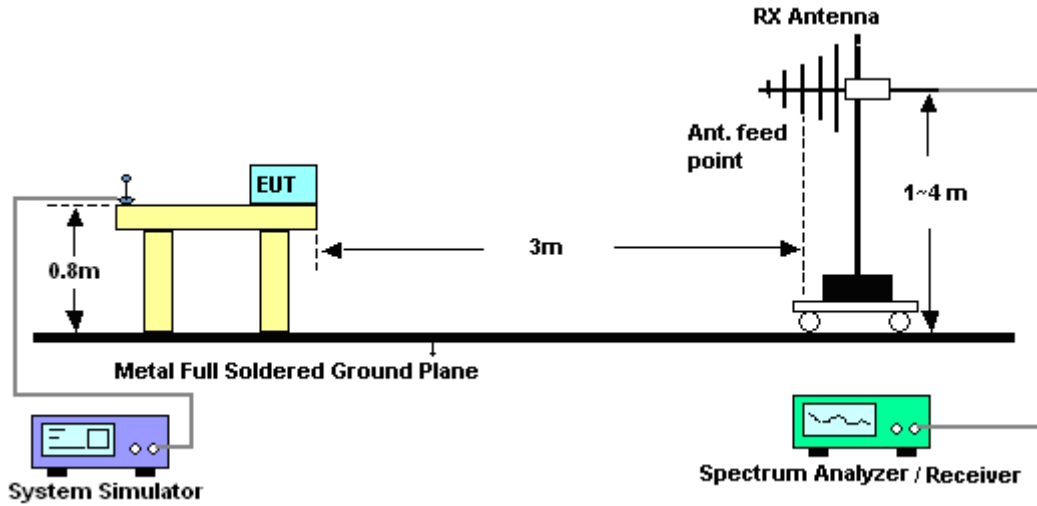

For radiated emissions above 1GHz

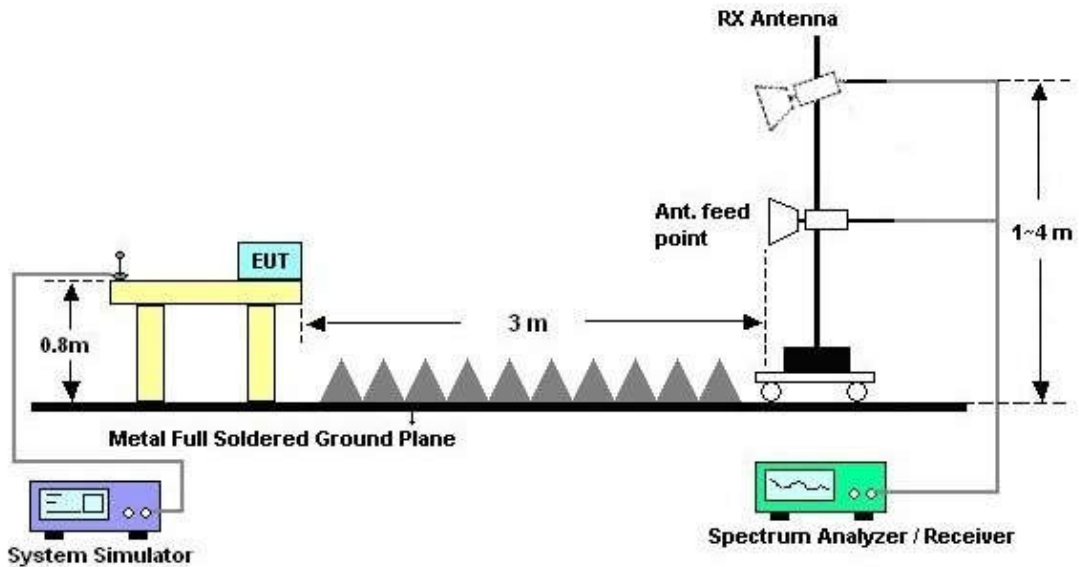



3.2.5. Test Result of Radiated Emission

Test Mode :	Mode 9	Temperature :	21~22°C
Test Engineer :	Carl Ni	Relative Humidity :	41~42%
Test Distance :	3m	Polarization :	Horizontal
Function Type :	USB Cable (Charging from Adapter 2) + Earphone + Battery + FM Rx (88MHz)		
Remark :	#2 is system simulator (FM Option) signal which can be ignored.		

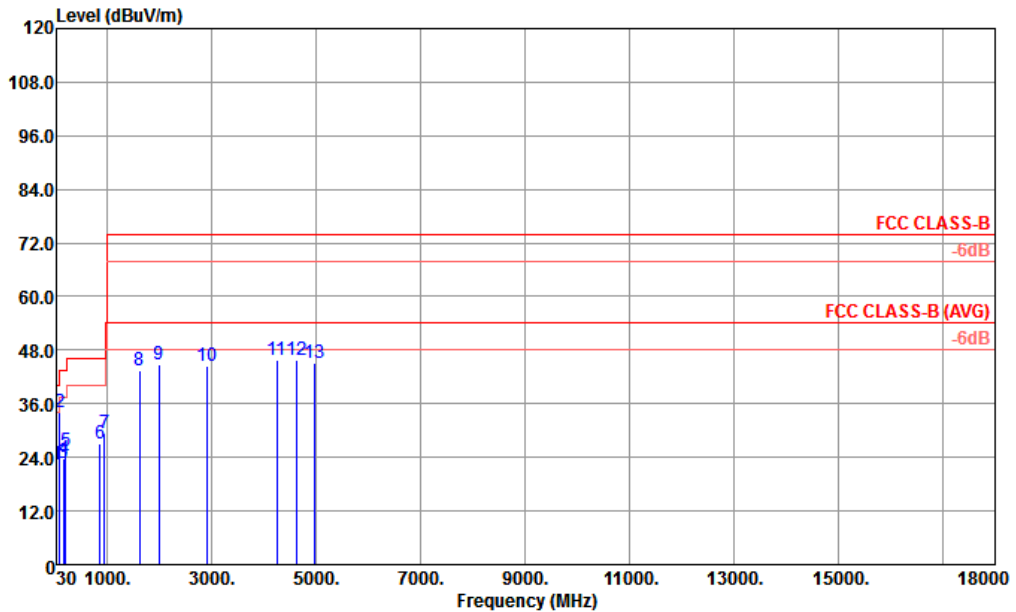

Site : 03CH02-KS
 Condition : FCC CLASS-B 3m 02 LF ANT HORIZONTAL
 Project : (FC)7D2007-02
 IMEI : 354130090006674 354130090006682 #12

	Freq	Level	Over	Limit	ReadAntenna	Cable	Preamp	A/Pos	T/Pos	Remark	
	MHz	dBuV/m	dB	dBuV/m	dBuV	dB/m	dB	dB	cm	deg	
1	30.00	22.29	-17.71	40.00	28.15	25.60	0.57	32.03	---	---	Peak
2	88.05	34.25			49.06	16.25	0.97	32.03	---	---	Peak
3	171.21	22.73	-20.77	43.50	36.41	16.75	1.34	31.77	---	---	Peak
4	184.44	23.69	-19.81	43.50	37.68	16.34	1.39	31.72	---	---	Peak
5	202.80	25.29	-18.21	43.50	39.61	15.88	1.46	31.66	---	---	Peak
6	871.90	27.07	-18.93	46.00	24.47	27.27	3.07	27.74	---	---	Peak
7	952.40	29.35	-16.65	46.00	24.72	28.54	3.21	27.12	100	0	Peak
8	1620.00	43.31	-30.69	74.00	45.52	29.00	4.23	35.44	---	---	Peak
9	1998.00	44.72	-29.28	74.00	42.41	30.30	4.63	32.62	---	---	Peak
10	2902.00	44.50	-29.50	74.00	35.77	32.30	5.90	29.47	---	---	Peak
11	4257.00	45.85	-28.15	74.00	34.16	35.53	7.25	31.09	---	---	Peak
12	4635.00	45.80	-28.20	74.00	34.44	35.79	7.65	32.08	---	---	Peak
13	4962.00	45.20	-28.80	74.00	35.25	35.54	7.82	33.41	---	---	Peak



Test Mode :	Mode 9	Temperature :	21~22°C
Test Engineer :	Carl Ni	Relative Humidity :	41~42%
Test Distance :	3m	Polarization :	Vertical
Function Type :	USB Cable (Charging from Adapter 2) + Earphone + Battery + FM Rx (88MHz)		
Remark :	#5 is system simulator (FM Option) signal which can be ignored.		

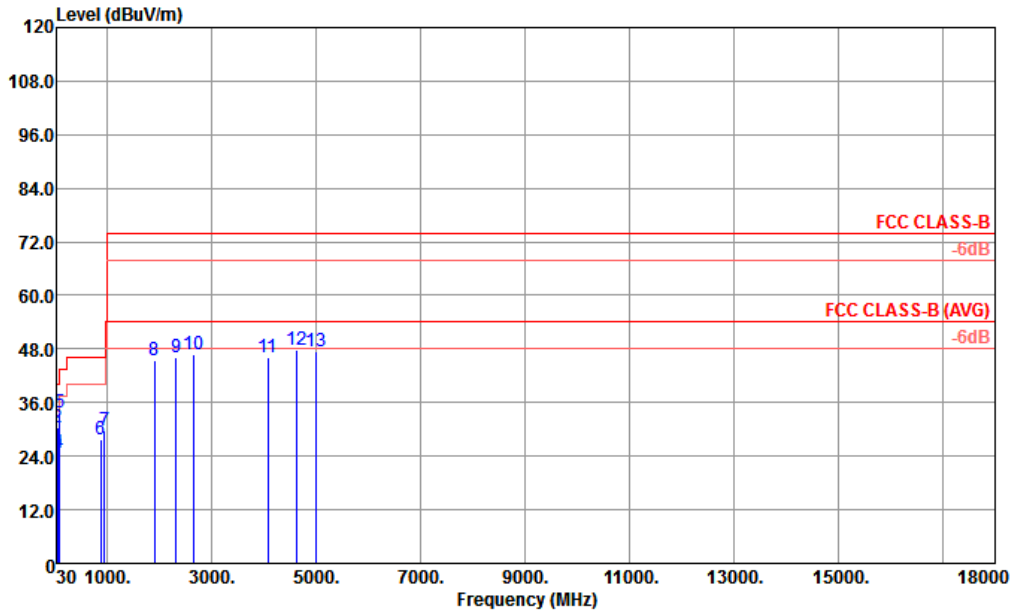

Site : 03CH02-KS
 Condition : FCC CLASS-B 3m 02 LF ANT VERTICAL
 Project : (FC)7D2007-02
 IMEI : 354130090006674 354130090006682 #12

	Freq	Level	Over Limit	Limit Line	ReadAntenna Level	Antenna Factor	Cable Loss	Preamp Factor	A/Pos	T/Pos	Remark
	MHz	dBuV/m	dB	dBuV/m	dBuV	dB/m	dB	dB	cm	deg	
1	30.27	25.34	-14.66	40.00	31.20	25.60	0.57	32.03	---	---	Peak
2	45.93	30.56	-9.44	40.00	42.20	19.80	0.67	32.11	100	0	Peak
3	51.06	25.46	-14.54	40.00	41.74	15.10	0.72	32.10	---	---	Peak
4	61.32	24.61	-15.39	40.00	42.95	13.00	0.81	32.15	---	---	Peak
5	88.05	33.72			48.53	16.25	0.97	32.03	---	---	Peak
6	874.70	27.80	-18.20	46.00	25.15	27.30	3.07	27.72	---	---	Peak
7	953.80	29.91	-16.09	46.00	25.24	28.58	3.21	27.12	---	---	Peak
8	1910.00	45.56	-28.44	74.00	44.56	29.73	4.54	33.27	---	---	Peak
9	2324.00	46.20	-27.80	74.00	41.84	31.19	5.07	31.90	---	---	Peak
10	2652.00	46.80	-27.20	74.00	40.03	31.74	5.48	30.45	---	---	Peak
11	4083.00	46.12	-27.88	74.00	34.74	35.23	6.94	30.79	---	---	Peak
12	4626.00	47.79	-26.21	74.00	36.29	35.81	7.65	31.96	---	---	Peak
13	5007.00	47.31	-26.69	74.00	37.58	35.50	7.86	33.63	---	---	Peak



Test Mode :	Mode 10	Temperature :	21~22°C
Test Engineer :	Carl Ni	Relative Humidity :	41~42%
Test Distance :	3m	Polarization :	Horizontal
Function Type :	LTE Band 7 Idle + Bluetooth Idle + WLAN Idle + Earphone + USB Cable (Data Link with Notebook) + Battery + GNSS Rx + SIM 1		

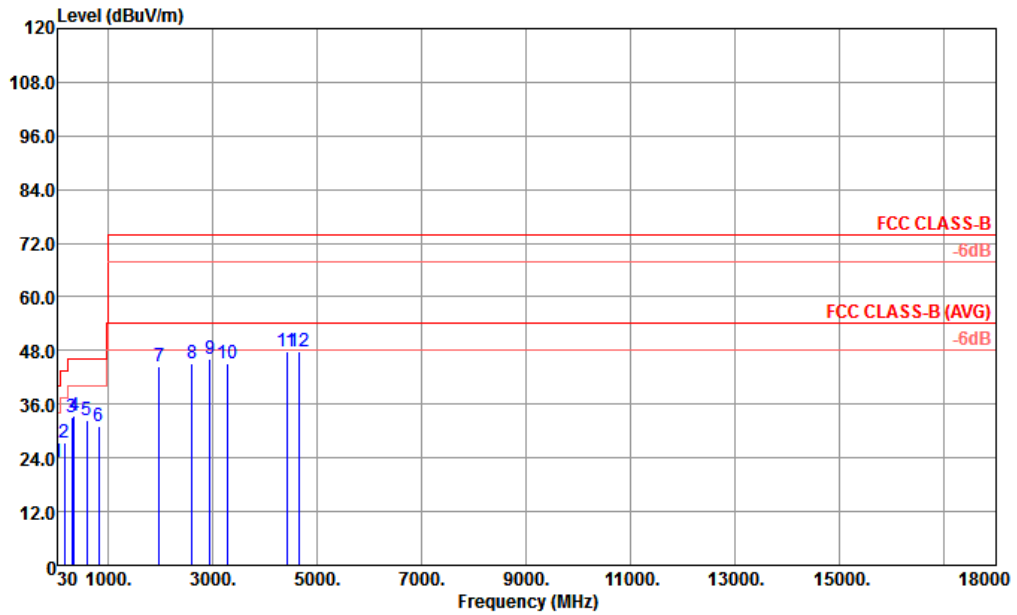

Site : 03CH02-KS
 Condition : FCC CLASS-B 3m 02 LF ANT HORIZONTAL
 Project : (FC)7D2007-02
 IMEI : 354130090006674 354130090006682 #12

	Freq	Level	Over Limit	Limit Line	ReadAntenna Level	Cable Factor	Preamp Loss	A/Pos	T/Pos	Remark	
	MHz	dBuV/m	dB	dBuV/m	dBuV	dB/m	dB	dB	cm	deg	
1	35.13	23.02	-16.98	40.00	29.92	24.50	0.64	32.04	---	---	Peak
2	165.54	27.47	-16.03	43.50	40.98	16.96	1.32	31.79	---	---	Peak
3	314.00	32.98	-13.02	46.00	43.47	18.65	1.92	31.06	---	---	Peak
4	344.80	33.47	-12.53	46.00	42.81	19.67	1.91	30.92	100	0	Peak
5	597.50	32.33	-13.67	46.00	34.79	24.60	2.62	29.68	---	---	Peak
6	825.70	31.10	-14.90	46.00	29.55	26.81	2.86	28.12	---	---	Peak
7	1982.00	44.33	-29.67	74.00	42.15	30.19	4.61	32.62	---	---	Peak
8	2606.00	45.17	-28.83	74.00	38.65	31.65	5.36	30.49	---	---	Peak
9	2950.00	46.24	-27.76	74.00	37.13	32.45	5.92	29.26	---	---	Peak
10	3294.00	45.08	-28.92	74.00	36.09	33.23	6.25	30.49	---	---	Peak
11	4416.00	47.84	-26.16	74.00	36.25	35.77	7.13	31.31	---	---	Peak
12	4644.00	47.69	-26.31	74.00	36.32	35.79	7.66	32.08	---	---	Peak



Test Mode :	Mode 10	Temperature :	21~22°C
Test Engineer :	Carl Ni	Relative Humidity :	41~42%
Test Distance :	3m	Polarization :	Vertical
Function Type :	LTE Band 7 Idle + Bluetooth Idle + WLAN Idle + Earphone + USB Cable (Data Link with Notebook) + Battery + GNSS Rx + SIM 1		

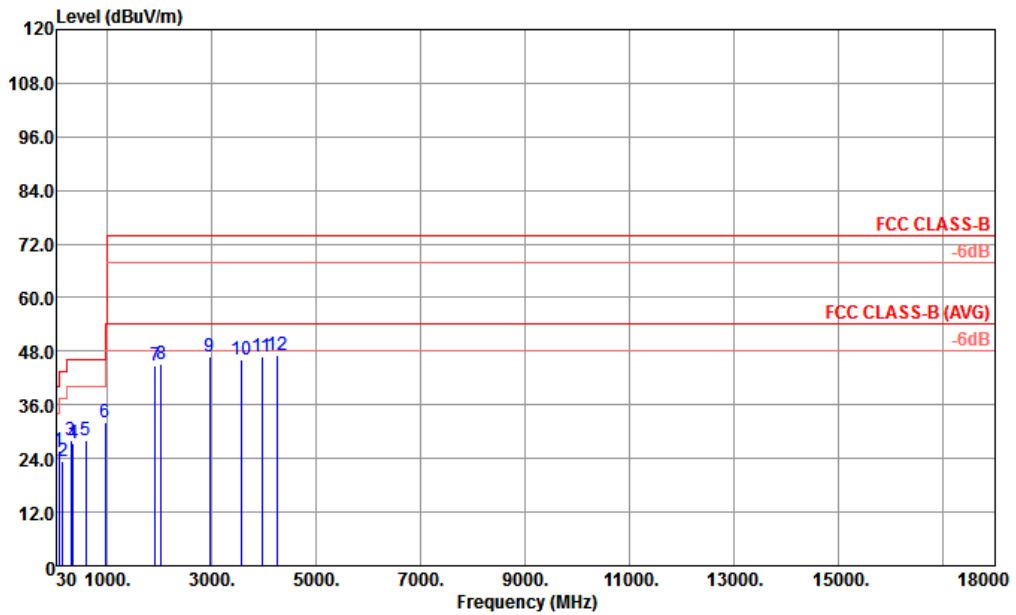

Site : 03CH02-KS
 Condition : FCC CLASS-B 3m 02 LF ANT VERTICAL
 Project : (FC)7D2007-02
 IMEI : 354130090006674 354130090006682

	Freq	Level	Over Limit	Limit Line	ReadAntenna Level	Cable Factor	Preamp Loss	A/Pos	T/Pos	Remark	
	MHz	dBuV/m	dB	dBuV/m	dBuV	dB/m	dB	dB	cm	deg	
1	81.57	25.89	-14.11	40.00	41.84	15.17	0.93	32.05	---	---	Peak
2	155.28	23.39	-20.11	43.50	36.63	17.30	1.28	31.82	---	---	Peak
3	314.00	28.24	-17.76	46.00	38.73	18.65	1.92	31.06	---	---	Peak
4	344.80	27.44	-18.56	46.00	36.78	19.67	1.91	30.92	---	---	Peak
5	597.50	27.96	-18.04	46.00	30.42	24.60	2.62	29.68	---	---	Peak
6	959.90	32.14	-13.86	46.00	27.31	28.70	3.21	27.08	100	0	Peak
7	1924.00	44.75	-29.25	74.00	43.75	29.73	4.54	33.27	---	---	Peak
8	2040.00	45.22	-28.78	74.00	43.02	30.42	4.67	32.89	---	---	Peak
9	2962.00	46.78	-27.22	74.00	37.43	32.45	5.94	29.04	---	---	Peak
10	3573.00	46.18	-27.82	74.00	36.22	33.65	6.43	30.12	---	---	Peak
11	3963.00	46.75	-27.25	74.00	35.55	35.04	6.69	30.53	---	---	Peak
12	4257.00	47.01	-26.99	74.00	35.32	35.53	7.25	31.09	---	---	Peak



4. List of Measuring Equipment

Instrument	Manufacturer	Model No.	Serial No.	Characteristics	Calibration Date	Test Date	Due Date	Remark
EMI Receiver	R&S	ESCI7	100768	9kHz~7GHz;	Apr. 20, 2017	Jan. 05, 2018	Apr. 19, 2018	Conduction (CO01-KS)
AC LISN	MessTec	AN3016	060103	9kHz~30MHz	Oct. 13, 2017	Jan. 05, 2018	Oct. 12, 2018	Conduction (CO01-KS)
AC LISN (for auxiliary equipment)	MessTec	AN3016	060105	9kHz~30MHz	Oct. 13, 2017	Jan. 05, 2018	Oct. 12, 2018	Conduction (CO01-KS)
AC Power Source	Chroma	61602	ABP0000008 11	AC 0V~300V, 45Hz~1000Hz	Oct. 12, 2017	Jan. 05, 2018	Oct. 11, 2018	Conduction (CO01-KS)
EMI Test Receiver	R&S	ESR7	101403	9kHz~7GHz; Max 30dBm	Aug. 08, 2017	Jan. 06, 2018	Aug. 07, 2018	Radiation (03CH02-KS)
EXA Spectrum Analyzer	Keysight	N9010A	MY55150208	10Hz~44GHz, MAX 30dB	Apr. 18, 2017	Jan. 06, 2018	Apr. 17, 2018	Radiation (03CH02-KS)
Bilog Antenna	TeseQ	CBL6112D	23182	30MHz~2GHz	Jan. 22, 2017	Jan. 06, 2018	Jan. 21, 2018	Radiation (03CH02-KS)
Double Ridge Horn Antenna	ETS-Lindgren	3117	75957	1GHz~18GHz	Oct. 21, 2017	Jan. 06, 2018	Oct. 20, 2018	Radiation (03CH02-KS)
SHF-EHF Horn	Schwarzbeck	BBHA 9170	BBHA170249	15GHz~40GHz	Feb. 15, 2017	Jan. 06, 2018	Feb. 14, 2018	Radiation (03CH02-KS)
Amplifier	MITEQ	TTA1840-35-H G	1887435	18GHz~40GHz	Oct. 12, 2017	Jan. 06, 2018	Oct. 11, 2018	Radiation (03CH02-KS)
Amplifier	SONOMA	310N	187289	9kHz~1GHz	Aug. 07, 2017	Jan. 06, 2018	Aug. 06, 2018	Radiation (03CH02-KS)
Amplifier	Agilent	8449B	3008A02384	1-26.5GHz Gain 30dB	Oct. 12, 2017	Jan. 06, 2018	Oct. 11, 2018	Radiation (03CH02-KS)
AC Power Source	Chroma	61601	61601000247 3	N/A	NCR	Jan. 06, 2018	NCR	Radiation (03CH02-KS)
Turn Table	MF	MF7802	N/A	0~360 degree	NCR	Jan. 06, 2018	NCR	Radiation (03CH02-KS)
Antenna Mast	MF	MF7802	N/A	1 m~4 m	NCR	Jan. 06, 2018	NCR	Radiation (03CH02-KS)

NCR: No Calibration Required



5. Uncertainty of Evaluation

Uncertainty of Conducted Emission Measurement (150 kHz ~ 30 MHz)

Measuring Uncertainty for a Level of Confidence of 95% ($U = 2Uc(y)$)	2.3dB
-------------------------------------------------------------------------	-------

Uncertainty of Radiated Emission Measurement (30 MHz ~ 1000 MHz)

Measuring Uncertainty for a Level of Confidence of 95% ($U = 2Uc(y)$)	4.5dB
-------------------------------------------------------------------------	-------

Uncertainty of Radiated Emission Measurement (1GHz ~ 18GHz)

Measuring Uncertainty for a Level of Confidence of 95% ($U = 2Uc(y)$)	4.2dB
-------------------------------------------------------------------------	-------