



FCC RF Test Report

APPLICANT : Motorola Mobility LLC
EQUIPMENT : Mobile Cellular Phone
BRAND NAME : Motorola
MODEL NAME : XT1922-1
FCC ID : IHDT56XB6
STANDARD : 47 CFR Part 2, 22(H), 27(M)
CLASSIFICATION : PCS Licensed Transmitter Held to Ear (PCE)

The product was received on Dec. 05, 2017 and completely tested on Jan. 31, 2018. We, Sporton International (Kunshan) Inc., would like to declare that the tested sample has been evaluated in accordance with the test procedures given in ANSI/TIA-603-E and the testing has shown the tested sample to be in compliance with the applicable technical standards. The test results in this report apply exclusively to the tested model / sample. Without written approval of Sporton International (Kunshan) Inc., the test report shall not be reproduced except in full.



Approved by: James Huang / Manager

Sporton International (Kunshan) Inc.
No.3-2 Ping-Xiang Rd, Kunshan Development Zone Kunshan City Jiangsu Province 215335
China



TABLE OF CONTENTS

REVISION HISTORY.....4
SUMMARY OF TEST RESULT5
1 GENERAL DESCRIPTION6
1.1 Applicant.....6
1.2 Manufacturer.....6
1.3 Product Feature of Equipment Under Test.....6
1.4 Product Specification of Equipment Under Test.....7
1.5 Modification of EUT7
1.6 Specification of Accessory.....8
1.7 Re-use of Measured Data10
1.8 Maximum ERP/EIRP Power, Frequency Tolerance, and Emission Designator11
1.9 Testing Location12
1.10 Applicable Standards.....12
2 TEST CONFIGURATION OF EQUIPMENT UNDER TEST13
2.1 Test Mode.....13
2.2 Connection Diagram of Test System.....15
2.3 Support Unit used in test configuration and system16
2.4 Measurement Results Explanation Example.....16
2.5 Frequency List of Low/Middle/High Channels17
3 CONDUCTED TEST ITEMS19
3.1 Measuring Instruments19
3.2 Test Setup19
3.3 Test Result of Conducted Test19
3.4 Conducted Output Power and ERP/EIRP20
3.5 Peak-to-Average Ratio21
3.6 Occupied Bandwidth.....22
3.7 Conducted Band Edge23
3.8 Conducted Spurious Emission25
3.9 Frequency Stability26
4 RADIATED TEST ITEMS27
4.1 Measuring Instruments27
4.2 Test Setup27
4.3 Test Result of Radiated Test27
4.4 Radiated Spurious Emission28
5 LIST OF MEASURING EQUIPMENT29
6 UNCERTAINTY OF EVALUATION30
APPENDIX A. TEST RESULTS OF CONDUCTED TEST
APPENDIX B. TEST RESULTS OF RADIATED TEST
APPENDIX C. TEST SETUP PHOTOGRAPHS



APPENDIX D. REFERENCE REPORT



REVISION HISTORY

REPORT NO.	VERSION	DESCRIPTION	ISSUED DATE
FG7D0507-01B	Rev. 01	Initial issue of report	Feb. 01, 2018



SUMMARY OF TEST RESULT

Report Section	FCC Rule	Description	Limit	Result	Remark
3.4	§2.1046	Conducted Output Power	Reporting Only	PASS	-
	§22.913(a)(2)	Effective Radiated Power (Band 5) (Band 26)	ERP < 7 Watt	PASS	-
	§27.50(h)(2)	Equivalent Isotropic Radiated Power (Band 38)(Band 41)	EIRP < 2Watt	PASS	-
3.5	N/A	Peak-to-Average Ratio	<13 dB	PASS	-
3.6	§2.1049	Occupied Bandwidth	Reporting Only	PASS	-
3.7	§2.1051 §22.917(a)	Conducted Band Edge Measurement (Band 5)(Band 26)	< 43+10log ₁₀ (P[Watts])	PASS	-
	§27.53(m)(4)	Conducted Band Edge Measurement (Band 38) (Band 41)	§27.53(m)(4)		
3.8	§2.1051 §22.917(a)	Conducted Spurious Emission (Band 5)(Band 26)	< 43+10log ₁₀ (P[Watts])	PASS	-
	§2.1051 §27.53(m)(4)	Conducted Spurious Emission (Band 38)(Band 41)	< 55+10log ₁₀ (P[Watts])		
3.9	§2.1055 §22.355	Frequency Stability Temperature & Voltage	< 2.5 ppm for Part 22H	PASS	-
	§2.1055 §27.54		Within Authorized Band		
4.4	§2.1053 §22.917(a)	Radiated Spurious Emission (Band 5)(Band 26)	< 43+10log ₁₀ (P[Watts])	PASS	Under limit 20.32 dB at 2496.000 MHz
	§2.1053 §27.53(m)(4)	Radiated Spurious Emission (Band 38)(Band 41)	< 55+10log ₁₀ (P[Watts])		



1 General Description

1.1 Applicant

Motorola Mobility LLC
222 W, Merchandise Mart Plaza, Chicago IL 60654 USA

1.2 Manufacturer

Motorola Mobility LLC
222 W, Merchandise Mart Plaza, Chicago IL 60654 USA

1.3 Product Feature of Equipment Under Test

Product Feature	
Equipment	Mobile Cellular Phone
Brand Name	Motorola
Model Name	XT1922-1
FCC ID	IHDT56XB6
EUT supports Radios application	GSM/GPRS/EGPRS/WCDMA/HSPA/DC-HSDPA/ HSPA+(16QAM uplink is not supported)/LTE WLAN2.4GHz 802.11b/g/n HT20 Bluetooth v3.0+EDR/ Bluetooth v4.0 LE/ Bluetooth v4.1 LE/ Bluetooth v4.2 LE
IMEI Code	Conducted: 351859090027917/351859090027925 Radiation: 351859090027230/351859090027248
HW Version	DVT1B
SW Version	fastboot_aljeter_oem_userdebug_8.0.0_OPP27.38_1080_int cfg-test-keys
EUT Stage	Identical Prototype

Note: There are two types of EUT sample 1 and sample 2, the differences between two samples are only for SIM slot, the sample 1 is dual SIM slot, the sample 2 is single SIM slot. According to the difference, we chose sample 1 to evaluate for full test.



1.4 Product Specification of Equipment Under Test

Standards-related Product Specification	
Tx Frequency	LTE Band 5 : 824.7 MHz ~ 848.3 MHz LTE Band 7 : 2502.5 MHz ~ 2567.5 MHz LTE Band 26 : 824.7MHz ~ 848.3 MHz LTE Band 38 : 2572.5MHz ~ 2617.5MHz LTE Band 41 : 2537.5 MHz ~ 2652.5 MHz
Rx Frequency	LTE Band 5 : 869.7 MHz ~ 893.3 MHz LTE Band 7 : 2622.5MHz ~ 2687.5 MHz LTE Band 26 : 869.7MHz ~ 893.3MHz LTE Band 38 : 2572.5MHz ~ 2617.5MHz LTE Band 41 : 2537.5 MHz ~ 2652.5 MHz
Bandwidth	LTE Band 5 : 1.4MHz / 3MHz / 5MHz / 10MHz LTE Band 7 : 5MHz / 10MHz / 15MHz / 20MHz LTE Band 26 : 1.4MHz / 3MHz / 5MHz / 10MHz / 15MHz LTE Band 38 : 5MHz / 10MHz / 15MHz / 20MHz LTE Band 41 : 5MHz / 10MHz / 15MHz / 20MHz
Maximum Output Power to Antenna	LTE Band 5 : 23.45 dBm LTE Band 26 : 23.37 dBm LTE Band 38 : 23.21 dBm LTE Band 41 : 23.22 dBm
Antenna Gain	LTE Band 5 : -3.05 dBi LTE Band 26 : -3.05 dBi LTE Band 38 : 2.27 dBi LTE Band 41 : 3.06 dBi
Type of Modulation	QPSK / 16QAM

1.5 Modification of EUT

No modifications are made to the EUT during all test items.



1.6 Specification of Accessory

Specification of Accessory			
AC Adapter 1(US)	Brand Name	Motorola (Salom)	Model Name SC-22 SPN5970A
	Power Rating	I/P: 100-240 Vac, 500mA, O/P: 5Vdc,3000mA or 9Vdc,1600mA or 12Vdc,1200mA	
AC Adapter 1(EU)	Brand Name	Motorola (Salom)	Model Name SC-23 SPN5971A
	Power Rating	I/P: 100-240 Vac, 500mA, O/P: 5Vdc,3000mA or 9Vdc,1600mA or 12Vdc,1200mA	
AC Adapter 1(UK)	Brand Name	Motorola (Salom)	Model Name SC-24 SPN5972A
	Power Rating	I/P: 100-240 Vac, 500mA, O/P: 5Vdc,3000mA or 9Vdc,1600mA or 12Vdc,1200mA	
AC Adapter 1(IN)	Brand Name	Motorola (Salom)	Model Name SC-25 SPN5973A
	Power Rating	I/P: 100-240 Vac, 500mA, O/P: 5Vdc,3000mA or 9Vdc,1600mA or 12Vdc,1200mA	
AC Adapter 1(AU)	Brand Name	Motorola (Salom)	Model Name SC-26 SPN5974A
	Power Rating	I/P: 100-240 Vac, 500mA, O/P: 5Vdc,3000mA or 9Vdc,1600mA or 12Vdc,1200mA	
AC Adapter 1(AR)	Brand Name	Motorola (Salom)	Model Name SC-27 SPN5975A
	Power Rating	I/P: 100-240 Vac, 500mA, O/P: 5Vdc,3000mA or 9Vdc,1600mA or 12Vdc,1200mA	
AC Adapter 1(BR)	Brand Name	Motorola (Salom)	Model Name SC-28 SPN5976A
	Power Rating	I/P: 100-240 Vac, 500mA, O/P: 5Vdc,3000mA or 9Vdc,1600mA or 12Vdc,1200mA	
AC Adapter 1(BR)	Brand Name	Motorola (Salom)	Model Name SC-28 SPN5997A
	Power Rating	I/P: 100-240 Vac, 500mA, O/P: 5Vdc,3000mA or 9Vdc,1600mA or 12Vdc,1200mA	
AC Adapter 2(US)	Brand Name	Motorola (Chenyang)	Model Name SC-22 SPN5993A
	Power Rating	I/P: 100-240 Vac, 500mA, O/P: 5Vdc,3000mA or 9Vdc,1600mA or 12Vdc,1200mA	
AC Adapter 2(EU)	Brand Name	Motorola (Chenyang)	Model Name SC-23 SPN5989A
	Power Rating	I/P: 100-240 Vac, 500mA, O/P: 5Vdc,3000mA or 9Vdc,1600mA or 12Vdc,1200mA	
AC Adapter 2(UK)	Brand Name	Motorola (Chenyang)	Model Name SC-24 SPN5990A
	Power Rating	I/P: 100-240 Vac, 500mA, O/P: 5Vdc,3000mA or 9Vdc,1600mA or 12Vdc,1200mA	
AC Adapter 2(IN)	Brand Name	Motorola (Chenyang)	Model Name SC-25 SPN5991A
	Power Rating	I/P: 100-240 Vac, 500mA, O/P: 5Vdc,3000mA or 9Vdc,1600mA or 12Vdc,1200mA	
AC Adapter 2(AU)	Brand Name	Motorola (Chenyang)	Model Name SC-26 SPN5988A
	Power Rating	I/P: 100-240 Vac, 500mA, O/P: 5Vdc,3000mA or 9Vdc,1600mA or 12Vdc,1200mA	
AC Adapter 2(AR)	Brand Name	Motorola (Chenyang)	Model Name SC-27 SPN5992A
	Power Rating	I/P: 100-240 Vac, 500mA, O/P: 5Vdc,3000mA or 9Vdc,1600mA or 12Vdc,1200mA	



Battery	Brand Name	Lenovo (SCUD)	Model Name	BL270
	Power Rating	3.85/4.4Vdc,4000mAh	Type	Li-ion
Earphone	Brand Name	Motorola(NEW LEADER)	Model Name	NLD-EM307E-02SF
	Signal Line Type	1.2 meter, non-shielded cable, without ferrite core		
USB Cable	Brand Name	Motorola (Saibao)	Model Name	SLQ-A077A
	Signal Line Type	1.0 meter, shielded cable, without ferrite core		



1.7 Re-use of Measured Data

1.7.1 Introduction Section

This application re-uses data collected on a similar device. The subject device of this application (Model: XT1922-1, FCC ID: IHDT56XB6) is electrically identical to the reference device (Model: XT1922-5, XT1922-4, FCC ID: IHDT56XB5) for the portions of the circuitry corresponding to the data being re-used, as treated by KDB Publication 178919 D01.

1.7.2 Difference Section

For details concerning the similarity with respect to component placement, mechanical/electrical design etc., some difference of population/depopulation to enable support of different cellular bands, please refer to the Product Equality Declaration.

The re-used RF data includes the following bands provided in Appendix D (Sporton RF Report No. FG7D0507B for the reference device Model: XT1922-5, XT1922-4, FCC ID: IHDT56XB5):

1.7.3 Spot Check Verification Data Section

In order to confirm hardware similarity of the subject device with the reference device, spot check measurements were performed on the subject device for Band 7 of radiated spurious emission, Conducted Band-edge and Conducted spurious emission, the test result were consistent with FCC ID: IHDT56XB5 and added new Band to full test, LTE Band 5 to re-test.

Assertions concerning the similarity of these devices are based on representations by the applicant. The applicant accepts full responsibility for the validity of the similarity claim, and for the determination that verification test data are sufficient to support it.

1.7.4 Reference detail Section:

Equipment Class	Reference FCC ID	Folder Test	Report Title/Section
PCE (LTE)	IHDT56XB5	Part22H.24E.27L.27M (FG7D0507B)	All sections applicable for LTE Band 7



1.8 Maximum ERP/EIRP Power, Frequency Tolerance, and Emission Designator

LTE Band 5		QPSK			16QAM		
BW (MHz)	Frequency Range (MHz)	Emission Designator (99%OBW)	Frequency Tolerance (ppm)	Maximum ERP(W)	Emission Designator (99%OBW)	Frequency Tolerance (ppm)	Maximum ERP(W)
1.4	824.7 ~ 848.3	1M10G7D	-	0.0653	1M09W7D	-	0.0504
3	825.5 ~ 847.5	2M72G7D	-	0.0627	2M73W7D	-	0.0511
5	826.5 ~ 846.5	4M50G7D	-	0.0647	4M51W7D	-	0.0473
10	829.0 ~ 844.0	9M01G7D	0.0045	0.0668	9M03W7D	-	0.0452
LTE Band 26		QPSK			16QAM		
BW (MHz)	Frequency Range (MHz)	Emission Designator (99%OBW)	Frequency Tolerance (ppm)	Maximum EIRP(W)	Emission Designator (99%OBW)	Frequency Tolerance (ppm)	Maximum EIRP(W)
1.4	824.7 ~ 848.3	1M10G7D	-	0.0644	1M10W7D	-	0.0525
3	825.5 ~ 847.5	2M72G7D	-	0.0644	2M74W7D	-	0.0515
5	826.5 ~ 846.5	4M51G7D	-	0.0621	4M52W7D	-	0.0521
10	829.0 ~ 844.0	9M07G7D	0.0117	0.0656	9M01W7D	-	0.0498
15	831.5 ~ 841.5	13M4G7D	-	0.0634	13M5W7D	-	0.0520
CH26765	821.5	13M5G7D	-	0.0643	13M4W7D	-	0.0481
LTE Band 38		QPSK			16QAM		
BW (MHz)	Frequency Range (MHz)	Emission Designator (99%OBW)	Frequency Tolerance (ppm)	Maximum EIRP(W)	Emission Designator (99%OBW)	Frequency Tolerance (ppm)	Maximum EIRP(W)
5	2572.5 ~ 2617.5	4M52G7D	-	0.3404	4M50W7D	-	0.2594
10	2575.0 ~ 2615.0	9M09G7D	0.0027	0.3373	9M03W7D	-	0.2600
15	2577.5 ~ 2612.5	13M4G7D	-	0.3508	13M4W7D	-	0.2679
20	2580.0 ~ 2610.0	18M2G7D	-	0.3532	18M4W7D	-	0.2618
LTE Band 41		QPSK			16QAM		
BW (MHz)	Frequency Range (MHz)	Emission Designator (99%OBW)	Frequency Tolerance (ppm)	Maximum EIRP(W)	Emission Designator (99%OBW)	Frequency Tolerance (ppm)	Maximum EIRP(W)
5	2537.5 ~ 2652.5	4M51G7D	-	0.4064	4M51W7D	-	0.3266
10	2540.0 ~ 2650.0	9M03G7D	0.0022	0.4169	8M99W7D	-	0.3412
15	2542.5 ~ 2647.5	13M4G7D	-	0.4295	13M5W7D	-	0.3296
20	2545.0 ~ 2645.0	18M4G7D	-	0.4246	18M3W7D	-	0.3221



1.9 Testing Location

Sporton International (Kunshan) Inc. is accredited to ISO 17025 by National Voluntary Laboratory Accreditation Program (NVLAP code: 600155-0) and the FCC designation No. is CN5013.

Test Site	Sporton International (Kunshan) Inc.		
Test Site Location	No.3-2 Ping-Xiang Rd, Kunshan Development Zone Kunshan City Jiangsu Province 215335 China TEL : +86-512-57900158 FAX : +86-512-57900958		
Test Site No.	Sporton Site No.		FCC Test Firm Registration No.
	TH01-KS	03CH03-KS	630927

Note: The test site complies with ANSI C63.4 2014 requirement.

1.10 Applicable Standards

According to the specifications of the manufacturer, the EUT must comply with the requirements of the following standards:

- ♦ 47 CFR Part 2, 22(H), 27(M)
- ♦ ANSI/TIA-603-E
- ♦ FCC KDB 971168 D01 Power Meas License Digital Systems v03
- ♦ FCC KDB 412172 D01 Determining ERP and EIRP v01r01

Remark:

1. All test items were verified and recorded according to the standards and without any deviation during the test.
2. This EUT has also been tested and complied with the requirements of FCC Part 15, Subpart B, recorded in a separate test report.



2 Test Configuration of Equipment Under Test

2.1 Test Mode

Antenna port conducted and radiated test items listed below are performed according to KDB 971168 D01 Power Meas License Digital Systems v03 with maximum output power.

Radiated measurements are performed by rotating the EUT in three different orthogonal test planes to find the maximum emission.

Test Items	Band	Bandwidth (MHz)						Modulation		RB #			Test Channel		
		1.4	3	5	10	15	20	QPSK	16QAM	1	Half	Full	L	M	H
Max. Output Power	5	Y	Y	Y	Y	-	-	Y	Y	Y	Y	Y	Y	Y	Y
	26	Y	Y	Y	Y	Y	-	Y	Y	Y	Y	Y	Y	Y	Y
	38	-	-	Y	Y	Y	Y	Y	Y	Y	Y	Y	Y	Y	Y
	41	-	-	Y	Y	Y	Y	Y	Y	Y	Y	Y	Y	Y	Y
Peak-to-Average Ratio	5				Y	-	-	Y	Y	Y		Y	Y	Y	Y
	26					Y	-	Y	Y	Y		Y	Y	Y	Y
	38	-	-				Y	Y	Y	Y		Y	Y	Y	Y
	41	-	-				Y	Y	Y	Y		Y	Y	Y	Y
26dB and 99% Bandwidth	5	Y	Y	Y	Y	-	-	Y	Y			Y	Y	Y	Y
	26	Y	Y	Y	Y	Y	-	Y	Y			Y	Y	Y	Y
	38	-	-	Y	Y	Y	Y	Y	Y			Y	Y	Y	Y
	41	-	-	Y	Y	Y	Y	Y	Y			Y	Y	Y	Y
Conducted Band Edge	5	Y	Y	Y	Y	-	-	Y	Y	Y		Y	Y		Y
	26	Y	Y	Y	Y	Y	-	Y	Y	Y		Y	Y		Y
	38	-	-	Y	Y	Y	Y	Y	Y	Y		Y	Y		Y
	41	-	-	Y	Y	Y	Y	Y	Y	Y		Y	Y		Y



Test Items	Band	Bandwidth (MHz)						Modulation		RB #			Test Channel		
		1.4	3	5	10	15	20	QPSK	16QAM	1	Half	Full	L	M	H
Conducted Spurious Emission	5	√	√	√	√	-	-	√	√	√			√	√	√
	26	√	√	√	√	√	-	√	√	√			√	√	√
	38	-	-	√	√	√	√	√	√	√			√	√	√
	41	-	-	√	√	√	√	√	√	√			√	√	√
Frequency Stability	5				√	-	-	√				√		√	
	26				√		-	√				√		√	
	38	-	-		√			√				√		√	
	41	-	-		√			√				√		√	
E.R.P./ E.I.R.P.	5	√	√	√	√	-	-	√	√	√			√	√	√
	26	√	√	√	√	√	-	√	√	√			√	√	√
	38	-	-	√	√	√	√	√	√	√			√	√	√
	41	-	-	√	√	√	√	√	√	√			√	√	√
Radiated Spurious Emission	5				√	-	-	√		√				√	
	26				√		-	√		√				√	
	38	-	-				√	√		√				√	
	41	-	-				√	√		√				√	
Note	<p>1. The mark “√” means that this configuration is chosen for testing</p> <p>2. The mark “-” means that this bandwidth is not supported.</p> <p>3. The device is investigated from 30MHz to 10 times of fundamental signal for radiated spurious emission test under different BW/RB size/offset and modulations in exploratory test. Subsequently, only the worst case emissions are reported.</p>														

2.2 Connection Diagram of Test System

LTE Band 5 / 26 / 38

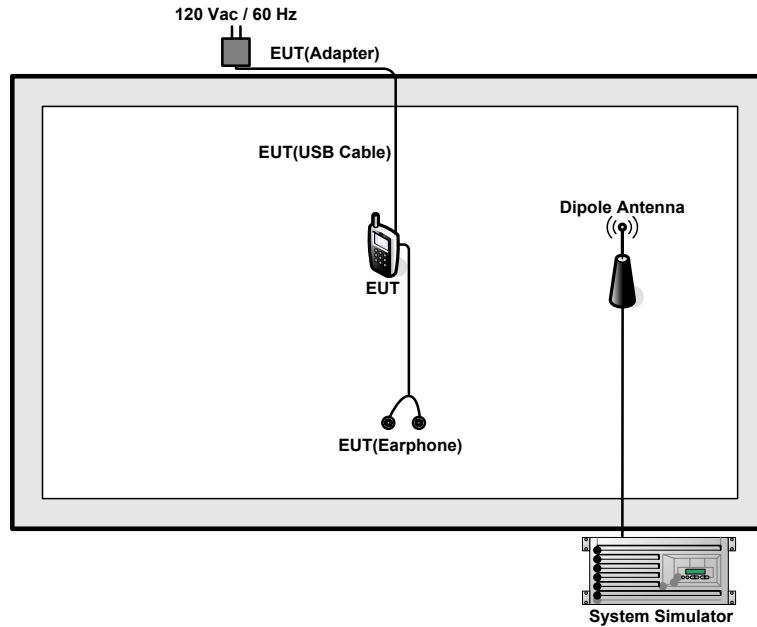

LTE Band 41

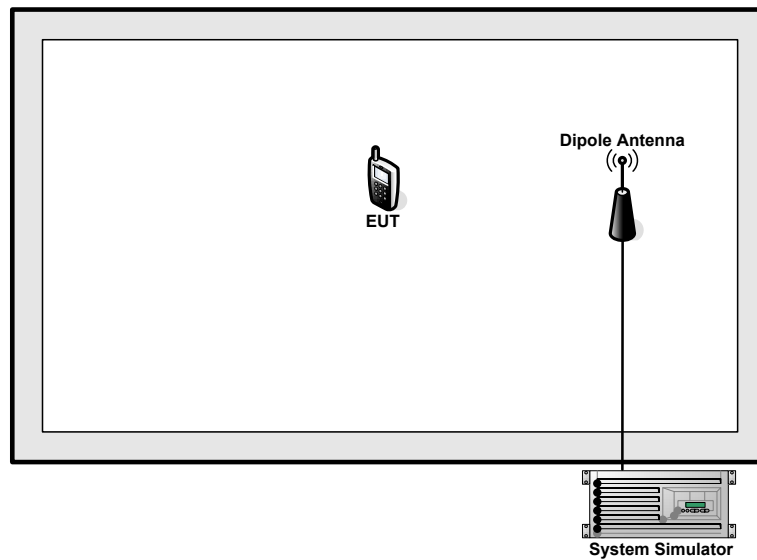



2.3 Support Unit used in test configuration and system

Item	Equipment	Trade Name	Model No.	FCC ID	Data Cable	Power Cord
1.	Power Supply	GW	GPS-3030D	N/A	N/A	Unshielded, 1.8 m
2.	System Simulator	Anritsu	MT8820C	N/A	N/A	Unshielded, 1.8 m

2.4 Measurement Results Explanation Example

For all conducted test items:

The offset level is set in the spectrum analyzer to compensate the RF cable loss between EUT conducted output port and spectrum analyzer. With the offset compensation, the spectrum analyzer reading level is exactly the EUT RF output level.

The spectrum analyzer offset is derived from RF cable loss.

Offset = RF cable loss.

Following shows an offset computation example with cable loss 5.5 dB.

Example :

$$\begin{aligned} \text{Offset(dB)} &= \text{RF cable loss(dB)}. \\ &= 5.5 \text{ (dB)} \end{aligned}$$



2.5 Frequency List of Low/Middle/High Channels

LTE Band 5 Channel and Frequency List				
BW [MHz]	Channel/Frequency(MHz)	Lowest	Middle	Highest
10	Channel	20450	20525	20600
	Frequency	829	836.5	844
5	Channel	20425	20525	20625
	Frequency	826.5	836.5	846.5
3	Channel	20415	20525	20635
	Frequency	825.5	836.5	847.5
1.4	Channel	20407	20525	20643
	Frequency	824.7	836.5	848.3

LTE Band 26 Channel and Frequency List				
BW [MHz]	Channel/Frequency(MHz)	Lowest	Middle	Highest
15	Channel	26865	26915	26965
	Frequency	831.5	836.5	841.5
10	Channel	26840	26915	26990
	Frequency	829	836.5	844
5	Channel	26815	26915	27015
	Frequency	826.5	836.5	846.5
3	Channel	26805	26915	27025
	Frequency	825.5	836.5	847.5
1.4	Channel	26797	26915	27033
	Frequency	824.7	836.5	848.3



LTE Band 38 Channel and Frequency List				
BW [MHz]	Channel/Frequency(MHz)	Lowest	Middle	Highest
20	Channel	37850	38000	38150
	Frequency	2580	2595	2610
15	Channel	37825	38000	38175
	Frequency	2577.5	2595	2612.5
10	Channel	37800	38000	38200
	Frequency	2575	2595	2615
5	Channel	37775	38000	38225
	Frequency	2572.5	2595	2617.5

LTE Band 41 Channel and Frequency List				
BW [MHz]	Channel/Frequency(MHz)	Lowest	Middle	Highest
20	Channel	40140	40640	41140
	Frequency	2545	2595	2645
15	Channel	40115	40640	41165
	Frequency	2542.5	2595	2647.5
10	Channel	40090	40640	41190
	Frequency	2540	2595	2650
5	Channel	40065	40640	41215
	Frequency	2537.5	2595	2652.5

3 Conducted Test Items

3.1 Measuring Instruments

See list of measuring instruments of this test report.

3.2 Test Setup

3.2.1 Conducted Output Power

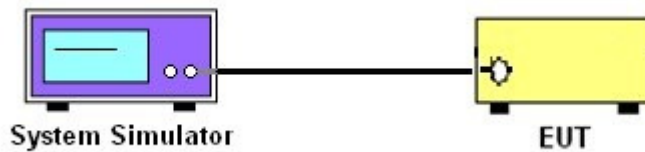

3.2.2 Peak-to-Average Ratio, Occupied Bandwidth ,Conducted Band-Edge and Conducted Spurious Emission

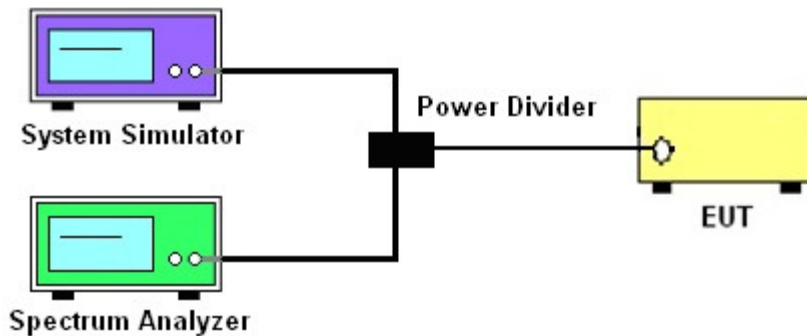

3.2.3 Frequency Stability

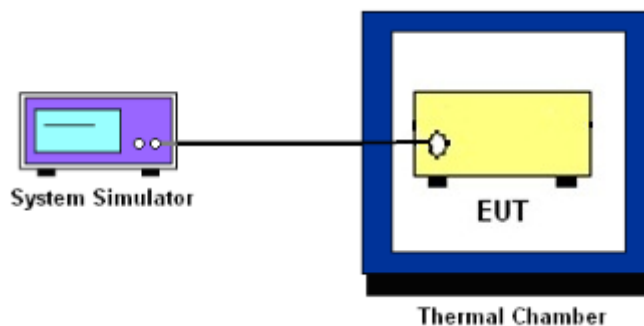

3.3 Test Result of Conducted Test

Please refer to Appendix A.



3.4 Conducted Output Power and ERP/EIRP

3.4.1 Description of the Conducted Output Power Measurement and ERP/EIRP Measurement

A system simulator was used to establish communication with the EUT. Its parameters were set to force the EUT transmitting at maximum output power. The measured power in the radio frequency on the transmitter output terminals shall be reported.

The ERP of mobile transmitters must not exceed 7 Watts for LTE Band 5, and Band 26.

The EIRP of mobile transmitters must not exceed 2 Watts for LTE Band 38, and Band 41.

According to KDB 412172 D01 Power Approach,

$EIRP = P_T + G_T - L_C$, $ERP = EIRP - 2.15$, where

P_T = transmitter output power in dBm

G_T = gain of the transmitting antenna in dBi

L_C = signal attenuation in the connecting cable between the transmitter and antenna in dB

3.4.2 Test Procedures

1. The transmitter output port was connected to the system simulator.
2. Set EUT at maximum power through the system simulator.
3. Select lowest, middle, and highest channels for each band and different modulation.
4. Measure and record the power level from the system simulator.



3.5 Peak-to-Average Ratio

3.5.1 Description of the PAR Measurement

Power Complementary Cumulative Distribution Function (CCDF) curves provide a means for characterizing the power peaks of a digitally modulated signal on a statistical basis. A CCDF curve depicts the probability of the peak signal amplitude exceeding the average power level. Most contemporary measurement instrumentation include the capability to produce CCDF curves for an input signal provided that the instrument's resolution bandwidth can be set wide enough to accommodate the entire input signal bandwidth. In measuring transmissions in this band using an average power technique, the peak-to-average ratio (PAR) of the transmission may not exceed 13 dB.

3.5.2 Test Procedures

1. The testing follows FCC KDB 971168 v03 Section 5.7.1.
2. The EUT was connected to spectrum and system simulator via a power divider.
3. Set the CCDF (Complementary Cumulative Distribution Function) option in spectrum analyzer.
4. The highest RF powers were measured and recorded the maximum PAPR level associated with a probability of 0.1 %.
5. Record the deviation as Peak to Average Ratio.



3.6 Occupied Bandwidth

3.6.1 Description of Occupied Bandwidth Measurement

The occupied bandwidth is the width of a frequency band such that, below the lower and above the upper frequency limits, the mean powers emitted are each equal to a specified percentage 0.5% of the total mean transmitted power.

The 26 dB emission bandwidth is defined as the frequency range between two points, one above and one below the carrier frequency, at which the spectral density of the emission is attenuated 26 dB below the maximum in-band spectral density of the modulated signal. Spectral density (power per unit bandwidth) is to be measured with a detector of resolution bandwidth equal to approximately 1.0% of the emission bandwidth.

3.6.2 Test Procedures

1. The testing follows FCC KDB 971168 v03 Section 4.1 and 4.2.
2. The EUT was connected to spectrum analyzer and system simulator via a power divider.
3. The spectrum analyzer center frequency is set to the nominal EUT channel center frequency. The span range for the spectrum analyzer shall be between two and five times the anticipated OBW.
4. The nominal resolution bandwidth (RBW) shall be in the range of 1 to 5 % of the anticipated OBW, and the VBW shall be at least 3 times the RBW.
5. Set the detection mode to peak, and the trace mode to max hold.
6. Determine the reference value: Set the EUT to transmit a modulated signal. Allow the trace to stabilize. Set the spectrum analyzer marker to the highest level of the displayed trace.
(this is the reference value)
7. Determine the “-26 dB down amplitude” as equal to (Reference Value – X).
8. Place two markers, one at the lowest and the other at the highest frequency of the envelope of the spectral display such that each marker is at or slightly below the “-X dB down amplitude” determined in step 6. If a marker is below this “-X dB down amplitude” value it shall be placed as close as possible to this value. The OBW is the positive frequency difference between the two markers.
9. Use the 99 % power bandwidth function of the spectrum analyzer and report the measured bandwidth.



3.7 Conducted Band Edge

3.7.1 Description of Conducted Band Edge Measurement

22.917(a)

For operations in the 824 – 849 MHz band, the FCC limit is $43 + 10\log_{10}(P[\text{Watts}])$ dB below the transmitter power $P(\text{Watts})$ in a 100kHz bandwidth. However, in the 1MHz bands immediately outside and adjacent to the licensee's frequency block, a resolution bandwidth of at least one percent of the emission bandwidth of the fundamental emission of the transmitter may be employed.

27.53(m)(4)

For mobile digital stations, the attenuation factor shall be not less than $40 + 10 \log (P)$ dB on all frequencies between the channel edge and 5 megahertz from the channel edge, $43 + 10 \log (P)$ dB on all frequencies between 5 megahertz and X megahertz from the channel edge, and $55 + 10 \log (P)$ dB on all frequencies more than X megahertz from the channel edge, where X is the greater of 6 megahertz or the actual emission bandwidth as defined in paragraph (m)(6) of this section. In addition, the attenuation factor shall not be less that $43 + 10 \log (P)$ dB on all frequencies between 2490.5 MHz and 2496 MHz and $55 + 10 \log (P)$ dB at or below 2490.5 MHz. Mobile Satellite Service licensees operating on frequencies below 2495 MHz may also submit a documented interference complaint against BRS licensees operating on channel BRS Channel 1 on the same terms and conditions as adjacent channel BRS or EBS licensees.



3.7.2 Test Procedures

1. The testing follows FCC KDB 971168 v03 Section 6.0.
2. The EUT was connected to spectrum analyzer and system simulator via a power divider.
3. The band edges of low and high channels for the highest RF powers were measured.
4. Set RBW \geq 1% EBW in the 1MHz band immediately outside and adjacent to the band edge.
5. Beyond the 1 MHz band from the band edge, RBW=1MHz was used.
6. Set spectrum analyzer with RMS detector.
7. The RF fundamental frequency should be excluded against the limit line in the operating frequency band.
8. Checked that all the results comply with the emission limit line.

Example:

The limit line is derived from $43 + 10\log(P)$ dB below the transmitter power P(Watts)

$$= P(W) - [43 + 10\log(P)] \text{ (dB)}$$

$$= [30 + 10\log(P)] \text{ (dBm)} - [43 + 10\log(P)] \text{ (dB)} = -13\text{dBm}.$$

9. For LTE Band 38, 41, the other 40 dB, and 55 dB have additionally applied same calculation above.



3.8 Conducted Spurious Emission

3.8.1 Description of Conducted Spurious Emission Measurement

The power of any emission outside of the authorized operating frequency ranges must be lower than the transmitter power (P) by a factor of at least $43 + 10 \log (P)$ dB.

For Band 38,41:

The power of any emission outside of the authorized operating frequency ranges must be lower than the transmitter power (P) by a factor of at least $55 + 10 \log (P)$ dB.

It is measured by means of a calibrated spectrum analyzer and scanned from 30 MHz up to a frequency including its 10th harmonic.

3.8.2 Test Procedures

1. The testing follows FCC KDB 971168 v03 Section 6.0.
2. The EUT was connected to spectrum analyzer and system simulator via a power divider.
3. The RF output of EUT was connected to the spectrum analyzer by RF cable and attenuator. The path loss was compensated to the results for each measurement.
4. The middle channel for the highest RF power within the transmitting frequency was measured.
5. The conducted spurious emission for the whole frequency range was taken.
6. Make the measurement with the spectrum analyzer's RBW = 1MHz, VBW = 3MHz.
7. Set spectrum analyzer with RMS detector.
8. Taking the record of maximum spurious emission.
9. The RF fundamental frequency should be excluded against the limit line in the operating frequency band.
10. The limit line is derived from $43 + 10\log(P)$ dB below the transmitter power P(Watts)
 $= P(W) - [43 + 10\log(P)]$ (dB)
 $= [30 + 10\log(P)]$ (dBm) - $[43 + 10\log(P)]$ (dB)
 $= -13$ dBm.
11. For Band 38, 41
The limit line is derived from $55 + 10\log(P)$ dB below the transmitter power P(Watts)
 $= P(W) - [55 + 10\log(P)]$ (dB)
 $= [30 + 10\log(P)]$ (dBm) - $[55 + 10\log(P)]$ (dB)
 $= -25$ dBm.



3.9 Frequency Stability

3.9.1 Description of Frequency Stability Measurement

The frequency stability shall be measured by variation of ambient temperature and variation of primary supply voltage to ensure that the fundamental emission stays within the authorized frequency block. The frequency stability of the transmitter shall be maintained within $\pm 0.00025\%$ ($\pm 2.5\text{ppm}$) of the center frequency.

3.9.2 Test Procedures for Temperature Variation

1. The testing follows FCC KDB 971168 v03 Section 9.0.
2. The EUT was set up in the thermal chamber and connected with the system simulator.
3. With power OFF, the temperature was decreased to -30°C and the EUT was stabilized before testing. Power was applied and the maximum change in frequency was recorded within one minute.
4. With power OFF, the temperature was raised in 10°C step up to 50°C . The EUT was stabilized at each step for at least half an hour. Power was applied and the maximum frequency change was recorded within one minute.

3.9.3 Test Procedures for Voltage Variation

1. The testing follows FCC KDB 971168 v03 Section 9.0.
2. The EUT was placed in a temperature chamber at $20\pm 5^{\circ}\text{C}$ and connected with the system simulator.
3. The power supply voltage to the EUT was varied from 85% to 115% of the nominal value measured at the input to the EUT.
4. The variation in frequency was measured for the worst case.

4 Radiated Test Items

4.1 Measuring Instruments

See list of measuring instruments of this test report.

4.2 Test Setup

4.2.1 For radiated test from 30MHz to 1GHz

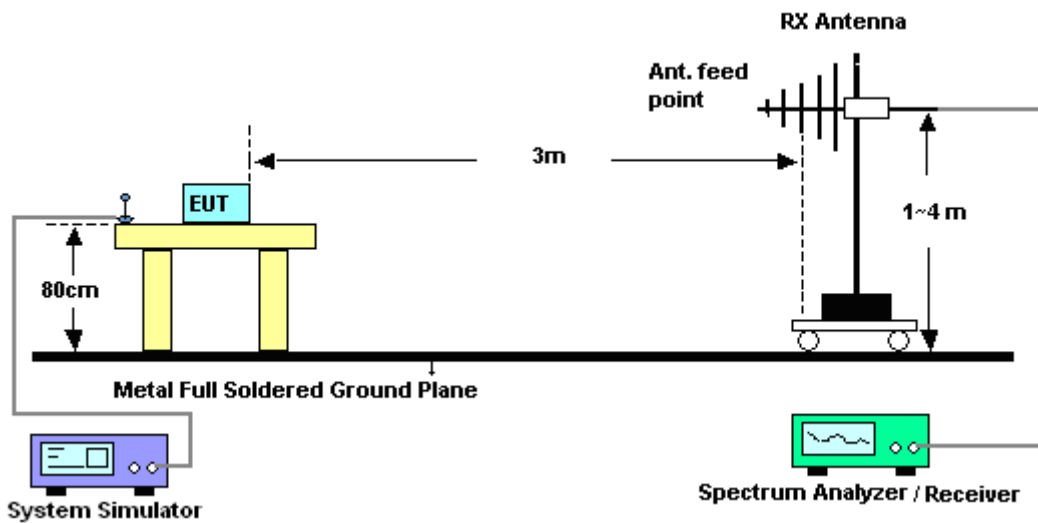

4.2.2 For radiated test above 1GHz

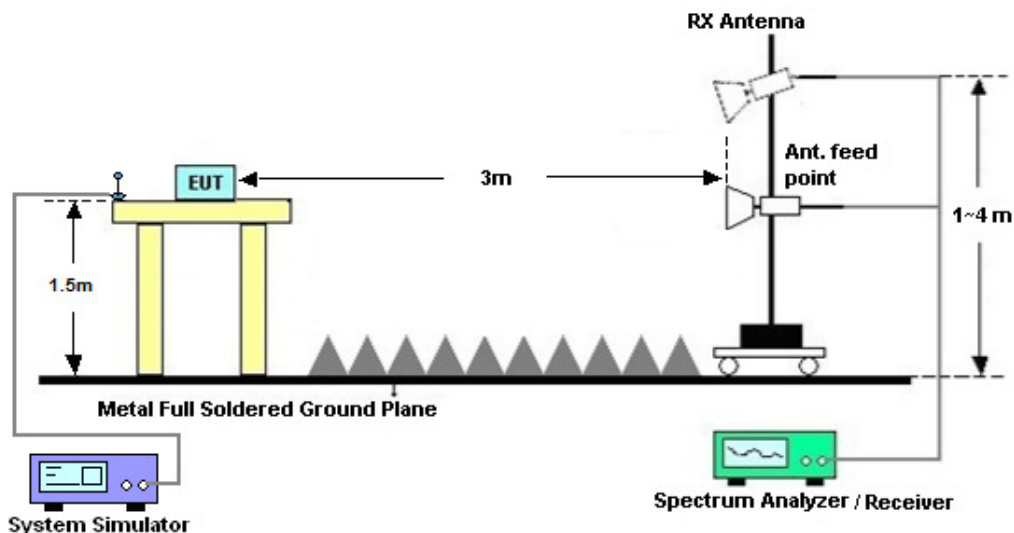

4.3 Test Result of Radiated Test

Please refer to Appendix B.



4.4 Radiated Spurious Emission

4.4.1 Description of Radiated Spurious Emission

The radiated spurious emission was measured by substitution method according to ANSI/TIA-603-E. The power of any emission outside of the authorized operating frequency ranges must be attenuated below the transmitter power (P) by a factor of at least $43 + 10 \log (P)$ dB.

For Band 38, 41

The power of any emission outside of the authorized operating frequency ranges must be attenuated below the transmitter power (P) by a factor of at least $55 + 10 \log (P)$ dB.

The spectrum is scanned from 30 MHz up to a frequency including its 10th harmonic.

4.4.2 Test Procedures

1. The testing follows FCC KDB 971168 v03 Section 5.8 and ANSI/TIA-603-E Section 2.2.12.
2. The EUT was placed on a turntable with 0.8 meter height for frequency below 1GHz and 1.5 meter height for frequency above 1GHz respectively above ground.
3. The EUT was set 3 meters from the receiving antenna mounted on the antenna tower.
4. The table was rotated 360 degrees to determine the position of the highest spurious emission.
5. The height of the receiving antenna is varied between 1m to 4m to search the maximum spurious emission for both horizontal and vertical polarizations.
6. During the measurement, the system simulator parameters were set to force the EUT transmitting at maximum output power.
7. Make the measurement with the spectrum analyzer's RBW = 1MHz, VBW = 3MHz, taking the record of maximum spurious emission.
8. A horn antenna was substituted in place of the EUT and was driven by a signal generator.
9. Tune the output power of signal generator to the same emission level with EUT maximum spurious emission.
10. $EIRP (dBm) = S.G. Power - Tx Cable Loss + Tx Antenna Gain$
11. $ERP (dBm) = EIRP - 2.15$
12. The RF fundamental frequency should be excluded against the limit line in the operating frequency band.

The limit line is derived from $43 + 10\log(P)$ dB below the transmitter power P(Watts)
 $= P(W) - [43 + 10\log(P)] (dB)$
 $= [30 + 10\log(P)] (dBm) - [43 + 10\log(P)] (dB)$
 $= -13dBm.$

13. For Band 38, 41:

The limit line is derived from $55 + 10\log(P)$ dB below the transmitter power P(Watts)
 $EIRP (dBm) = S.G. Power - Tx Cable Loss + Tx Antenna Gain$
 $ERP (dBm) = EIRP - 2.15$



5 List of Measuring Equipment

Instrument	Manufacturer	Model No.	Serial No.	Characteristics	Calibration Date	Test Date	Due Date	Remark
Spectrum Analyzer	R&S	FSV40	101040	10Hz~40GHz	Aug. 08, 2017	Dec. 25, 2017~ Jan. 26, 2018	Aug. 07, 2018	Conducted (TH01-KS)
Radio communication analyzer	Anritsu	MT8820C	6201300652	2G/3G/LTE_ full band	Aug. 08, 2017	Dec. 25, 2017~ Jan. 26, 2018	Aug. 07, 2018	Conducted (TH01-KS)
Thermal Chamber	Hongzhan	LP-150U	HZ014011440	-40~+150°C 20%~95%RH	Apr. 18, 2017	Dec. 25, 2017~ Jan. 26, 2018	Apr. 17, 2018	Conducted (TH01-KS)
EXA Spectrum Analyzer	Keysight	N9010A	MY55150244	10Hz~44GHz	Apr. 18, 2017	Jan. 31, 2018	Apr. 17, 2018	Radiation (03CH03-KS)
Bilog Antenna	TeseQ	CBL6112D	35406	25MHz~2GHz	Apr. 22, 2017	Jan. 31, 2018	Apr. 21, 2018	Radiation (03CH03-KS)
Horn Antenna	Schwarzbeck	BBHA9120D	9120D-1356	1GHz~18GHz	Apr. 22, 2017	Jan. 31, 2018	Apr. 21, 2018	Radiation (03CH03-KS)
SHF-EHF Horn	Schwarzbeck	BBHA 9170	BBHA170249	15GHz~40GHz	Feb. 15, 2017	Jan. 31, 2018	Feb. 14, 2018	Radiation (03CH03-KS)
Amplifier	com-power	PA-103A	161069	1MHz~1000MHz / 32 dB	Apr. 18, 2017	Jan. 31, 2018	Apr. 17, 2018	Radiation (03CH03-KS)
Amplifier	MITEQ	TTA1840-35 -HG	1887435	18GHz~40GHz	Oct. 12, 2017	Jan. 31, 2018	Oct. 11, 2018	Radiation (03CH03-KS)
high gain Amplifier	MITEQ	AMF-7D-00 101800-30-1	2025788	1GHz~18GHz	Apr. 18, 2017	Jan. 31, 2018	Apr. 17, 2018	Radiation (03CH03-KS)
Amplifier	Agilent	8449B	3008A02370	1GHz~26.5GHz	Oct. 12, 2017	Jan. 31, 2018	Oct. 11, 2018	Radiation (03CH03-KS)
AC Power Source	Chroma	61601	F104090004	N/A	NCR	Jan. 31, 2018	NCR	Radiation (03CH03-KS)
Turn Table	ChamPro	EM 1000-T	060762-T	0~360 degree	NCR	Jan. 31, 2018	NCR	Radiation (03CH03-KS)
Antenna Mast	ChamPro	EM 1000-A	060762-A	1 m~4 m	NCR	Jan. 31, 2018	NCR	Radiation (03CH03-KS)

NCR: No Calibration Required



6 Uncertainty of Evaluation

Uncertainty of Radiated Emission Measurement (30 MHz ~ 1000 MHz)

Measuring Uncertainty for a Level of Confidence of 95% ($U = 2Uc(y)$)	2.8 dB
---	--------

Uncertainty of Radiated Emission Measurement (1 GHz ~ 40 GHz)

Measuring Uncertainty for a Level of Confidence of 95% ($U = 2Uc(y)$)	3.3 dB
---	--------



Appendix A. Test Results of Conducted Test

Conducted Output Power(Average power)

LTE Band 5 Maximum Average Power [dBm]						
BW [MHz]	RB Size	RB Offset	Mod	Lowest	Middle	Highest
10	1	0	QPSK	22.92	23.22	22.86
10	1	25		23.31	23.45	22.89
10	1	49		23.12	23.26	22.91
10	25	0		22.15	22.16	22.23
10	25	12		22.76	22.25	22.32
10	25	25		22.23	22.23	22.29
10	50	0		22.14	22.26	22.23
10	1	0	16-QAM	21.39	21.45	21.51
10	1	25		21.68	21.74	21.75
10	1	49		21.66	21.72	21.72
10	25	0		21.10	21.16	21.14
10	25	12		21.24	21.28	21.23
10	25	25		21.33	21.23	21.29
10	50	0		21.31	21.26	21.23
5	1	0	QPSK	22.90	22.93	23.04
5	1	12		23.10	23.21	23.31
5	1	24		22.98	23.14	22.97
5	12	0		22.11	22.11	22.20
5	12	7		22.17	22.18	22.18
5	12	13		22.12	22.24	22.17
5	25	0		22.19	22.15	22.12
5	1	0	16-QAM	21.45	21.91	21.65
5	1	12		21.82	21.95	21.88
5	1	24		21.63	21.83	21.59
5	12	0		20.91	20.91	21.03
5	12	7		21.00	21.00	21.00
5	12	13		20.92	20.96	20.99
5	25	0		20.98	21.15	21.14



LTE Band 5 Maximum Average Power [dBm]						
BW [MHz]	RB Size	RB Offset	Mod	Lowest	Middle	Highest
3	1	0	QPSK	23.05	23.11	23.17
3	1	8		23.10	22.98	22.95
3	1	14		23.04	22.99	23.13
3	8	0		22.17	22.18	22.17
3	8	4		22.23	22.25	22.26
3	8	7		22.21	22.23	22.16
3	15	0		22.18	22.19	22.11
3	1	0	16-QAM	22.23	21.66	22.20
3	1	8		21.89	21.71	22.00
3	1	14		22.12	22.28	21.81
3	8	0		20.92	21.18	21.15
3	8	4		21.18	21.11	21.13
3	8	7		21.16	21.18	21.12
3	15	0		21.30	21.34	20.85
1.4	1	0	QPSK	23.03	22.98	23.01
1.4	1	3		23.20	23.16	23.13
1.4	1	5		23.15	23.02	23.01
1.4	3	0		23.19	23.22	23.20
1.4	3	1		23.22	23.35	23.22
1.4	3	3		23.21	23.34	23.21
1.4	6	0		22.07	22.26	22.09
1.4	1	0	16-QAM	21.72	21.73	21.67
1.4	1	3		21.59	22.02	22.02
1.4	1	5		21.69	21.65	21.76
1.4	3	0		22.09	21.98	22.03
1.4	3	1		22.12	22.22	22.06
1.4	3	3		22.14	22.01	22.00
1.4	6	0		21.14	20.97	20.86



LTE Band 26 Maximum Average Power [dBm]						
BW [MHz]	RB Size	RB Offset	Mod	Lowest	Middle	Highest
15	1	0	QPSK	22.87	22.89	22.84
15	1	37		23.12	23.22	22.89
15	1	74		22.92	23.01	22.75
15	36	0		21.96	22.08	22.07
15	36	20		22.04	22.07	21.99
15	36	39		21.97	22.01	22.11
15	75	0		22.03	22.09	22.06
15	1	0	16-QAM	21.65	21.61	21.53
15	1	37		21.68	21.95	22.36
15	1	74		21.58	21.55	21.66
15	36	0		21.01	21.07	20.96
15	36	20		21.09	20.96	20.76
15	36	39		20.92	21.01	21.00
15	75	0		20.98	20.96	20.94
10	1	0	QPSK	22.80	22.80	22.87
10	1	25		23.11	23.02	23.37
10	1	49		22.82	22.80	22.94
10	25	0		22.02	22.12	22.08
10	25	12		21.98	22.11	22.12
10	25	25		22.03	22.13	22.06
10	50	0		22.08	22.05	22.05
10	1	0	16-QAM	21.72	21.72	21.72
10	1	25		22.11	22.17	21.73
10	1	49		21.52	21.77	21.53
10	25	0		21.18	21.01	21.11
10	25	12		21.06	21.01	21.25
10	25	25		21.00	20.95	20.99
10	50	0		21.06	21.06	21.06



LTE Band 26 Maximum Average Power [dBm]						
5	1	0	QPSK	22.81	22.81	22.87
5	1	12		23.00	23.07	23.13
5	1	24		22.74	22.94	22.83
5	12	0		22.08	22.01	21.97
5	12	7		22.05	22.10	22.09
5	12	13		22.05	22.09	22.08
5	25	0		22.03	22.10	22.09
5	1	0	16-QAM	21.53	22.06	21.93
5	1	12		21.72	22.37	22.36
5	1	24		21.60	22.11	21.87
5	12	0		20.74	21.15	21
5	12	7		20.79	21.20	21.07
5	12	13		20.80	21.18	21.03
5	25	0		20.87	21.02	21.02
3	1	0	QPSK	23.05	23.08	22.74
3	1	8		23.20	23.29	23.03
3	1	14		22.97	23.04	23.07
3	8	0		22.15	22.04	22.07
3	8	4		22.08	22.19	22.11
3	8	7		21.98	22.14	22.07
3	15	0		22.01	22.03	22.07
3	1	0	16-QAM	22.03	22.30	22.08
3	1	8		21.51	22.32	21.83
3	1	14		21.56	21.97	21.87
3	8	0		21.04	21.02	20.74
3	8	4		21.07	21.07	20.79
3	8	7		21.07	21.11	21.07
3	15	0		20.96	21.08	21.21



LTE Band 26 Maximum Average Power [dBm]						
1.4	1	0	QPSK	22.88	22.86	22.97
1.4	1	3		22.89	23.04	23.00
1.4	1	5		22.85	22.96	23.03
1.4	3	0		23.15	23.03	23.13
1.4	3	1		23.25	23.11	23.08
1.4	3	3		23.29	23.07	23.18
1.4	6	0		22.04	22.03	22.05
1.4	1	0	16-QAM	22.21	21.72	22.20
1.4	1	3		22.29	21.47	22.28
1.4	1	5		22.12	21.44	22.25
1.4	3	0		21.92	21.75	22.21
1.4	3	1		22.31	21.68	22.35
1.4	3	3		22.40	22.12	22.36
1.4	6	0		20.89	20.95	20.86



LTE Band 38 Maximum Average Power [dBm]						
BW [MHz]	RB Size	RB Offset	Mod	Lowest	Middle	Highest
20	1	0	QPSK	22.81	22.91	22.86
20	1	49		23.21	22.99	22.87
20	1	99		22.85	22.77	22.83
20	50	0		22.20	22.09	21.90
20	50	24		22.09	22.02	21.88
20	50	50		21.99	21.85	21.81
20	100	0		22.01	21.92	21.84
20	1	0	16-QAM	21.64	21.50	21.60
20	1	49		21.91	21.59	21.67
20	1	99		21.66	21.35	21.56
20	50	0		21.02	20.75	20.65
20	50	24		21.09	20.72	20.66
20	50	50		21.06	20.83	20.57
20	100	0		20.99	20.79	20.70
15	1	0	QPSK	22.87	22.77	22.86
15	1	37		23.18	22.78	22.88
15	1	74		22.87	22.67	23.03
15	36	0		22.06	21.95	21.95
15	36	20		22.16	22.08	21.91
15	36	39		22.08	21.98	21.98
15	75	0		22.01	21.91	22.01
15	1	0	16-QAM	21.62	21.77	21.87
15	1	37		22.01	21.78	21.68
15	1	74		21.70	21.70	21.87
15	36	0		20.96	20.73	20.65
15	36	20		21.06	20.81	20.71
15	36	39		21.01	20.73	20.81
15	75	0		20.97	20.88	20.97



LTE Band 38 Maximum Average Power [dBm]						
BW [MHz]	RB Size	RB Offset	Mod	Lowest	Middle	Highest
10	1	0	QPSK	22.88	22.78	22.72
10	1	25		22.85	22.83	22.87
10	1	49		22.99	22.77	23.01
10	25	0		21.99	21.94	21.86
10	25	12		22.02	21.96	21.81
10	25	25		22.04	21.97	21.93
10	50	0		22.11	22.04	21.93
10	1	0	16-QAM	21.71	21.38	21.73
10	1	25		21.79	21.64	21.77
10	1	49		21.88	21.57	21.78
10	25	0		21.16	21.10	20.72
10	25	12		21.09	21.06	20.68
10	25	25		21.01	21.04	20.81
10	50	0		20.97	20.71	20.70
5	1	0	QPSK	22.76	22.69	22.79
5	1	12		23.05	22.79	22.72
5	1	24		22.89	22.50	22.86
5	12	0		21.89	21.85	21.83
5	12	7		21.86	21.85	21.78
5	12	13		22.00	21.86	22.06
5	25	0		22.00	21.88	21.96
5	1	0	16-QAM	21.46	21.77	21.34
5	1	12		21.87	21.69	21.42
5	1	24		21.87	21.66	21.72
5	12	0		20.80	20.76	20.74
5	12	7		20.98	20.75	20.79
5	12	13		20.76	20.77	20.87
5	25	0		21.13	20.99	20.91



LTE Band 41 Maximum Average Power [dBm]						
BW [MHz]	RB Size	RB Offset	Mod	Lowest	Middle	Highest
20	1	0	QPSK	23.07	23.04	23.22
20	1	49		23.15	23.01	23.08
20	1	99		23.11	22.83	22.81
20	50	0		22.10	22.24	22.17
20	50	24		22.06	22.09	22.08
20	50	50		22.25	22.13	22.07
20	100	0		22.11	22.17	22.17
20	1	0	16-QAM	22.02	21.97	21.79
20	1	49		22.01	21.93	21.99
20	1	99		21.59	21.83	21.63
20	50	0		20.95	21.18	21.13
20	50	24		21.13	21.15	21.08
20	50	50		21.00	21.07	21.06
20	100	0		20.98	21.13	21.06
15	1	0	QPSK	23.27	23.21	23.04
15	1	37		23.07	23.01	23.08
15	1	74		23.07	22.91	22.95
15	36	0		22.07	22.20	22.16
15	36	20		22.01	22.03	22.11
15	36	39		22.08	22.24	22.17
15	75	0		22.02	22.17	22.16
15	1	0	16-QAM	21.98	21.90	22.12
15	1	37		22.04	21.90	22.03
15	1	74		22.06	21.92	21.86
15	36	0		21.05	20.99	21.08
15	36	20		20.90	21.02	20.86
15	36	39		20.99	21.14	21.04
15	75	0		20.97	21.21	21.04



LTE Band 41 Maximum Average Power [dBm]						
BW [MHz]	RB Size	RB Offset	Mod	Lowest	Middle	Highest
10	1	0	QPSK	23.03	23.14	23.03
10	1	25		22.97	23.06	22.93
10	1	49		23.00	22.94	23.01
10	25	0		22.10	22.19	22.19
10	25	12		22.04	22.02	22.15
10	25	25		22.05	22.13	22.19
10	50	0		22.08	22.17	22.04
10	1	0	16-QAM	22.27	22.04	21.89
10	1	25		22.09	21.88	21.88
10	1	49		21.45	21.80	21.87
10	25	0		21.06	21.03	20.97
10	25	12		20.99	20.97	20.94
10	25	25		21.22	20.83	21.00
10	50	0		20.93	21.22	21.03
5	1	0	QPSK	23.03	23.00	23.00
5	1	12		23.03	22.93	22.88
5	1	24		22.76	22.90	22.92
5	12	0		22.00	21.90	22.14
5	12	7		22.00	21.96	22.11
5	12	13		22.01	21.90	22.03
5	25	0		22.09	21.99	22.19
5	1	0	16-QAM	21.57	22.08	21.63
5	1	12		21.65	21.92	21.89
5	1	24		21.48	21.89	21.81
5	12	0		20.93	20.82	20.97
5	12	7		20.90	20.97	20.94
5	12	13		20.90	20.95	20.88
5	25	0		21.26	20.84	20.90



ERP/EIRP

LTE Band 5 ($G_T - L_C = -3.05$ dB) QPSK									
Bandwidth	1.4M			3M			5M		
Channel	20407	20525	20643	20415	20525	20635	20425	20525	20625
	(Low)	(Mid)	(High)	(Low)	(Mid)	(High)	(Low)	(Mid)	(High)
Frequency	824.7	836.5	848.3	825.5	836.5	847.5	826.5	836.5	846.5
(MHz)									
Conducted Power (dBm)	23.22	23.35	23.22	23.05	23.11	23.17	23.10	23.21	23.31
Conducted Power (Watts)	0.2099	0.2163	0.2099	0.2018	0.2046	0.2075	0.2042	0.2094	0.2143
ERP(dBm)	18.02	18.15	18.02	17.85	17.91	17.97	17.90	18.01	18.11
ERP(Watts)	0.0634	0.0653	0.0634	0.0610	0.0618	0.0627	0.0617	0.0632	0.0647

LTE Band 5 ($G_T - L_C = -3.05$ dBi) QPSK			
Bandwidth	10M		
Channel	20450	20525	20600
	(Low)	(Mid)	(High)
Frequency	829	836.5	844
(MHz)			
Conducted Power (dBm)	23.31	23.45	22.89
Conducted Power (Watts)	0.2143	0.2213	0.1945
ERP(dBm)	18.11	18.25	17.69
ERP(Watts)	0.0647	0.0668	0.0587



LTE Band 5 (G _T - L _C = -3.05 dBi) 16QAM									
Bandwidth	1.4M			3M			5M		
Channel	20407	20525	20643	20415	20525	20635	20425	20525	20625
	(Low)	(Mid)	(High)	(Low)	(Mid)	(High)	(Low)	(Mid)	(High)
Frequency (MHz)	824.7	836.5	848.3	825.5	836.5	847.5	826.5	836.5	846.5
Conducted Power (dBm)	22.12	22.22	22.06	22.12	22.28	21.81	21.82	21.95	21.88
Conducted Power (Watts)	0.1629	0.1667	0.1607	0.1629	0.1690	0.1517	0.1521	0.1567	0.1542
ERP(dBm)	16.92	17.02	16.86	16.92	17.08	16.61	16.62	16.75	16.68
ERP(Watts)	0.0492	0.0504	0.0485	0.0492	0.0511	0.0458	0.0459	0.0473	0.0466

LTE Band 5 (G _T - L _C = -3.05 dBi) 16QAM			
Bandwidth	10M		
Channel	20450	20525	20600
	(Low)	(Mid)	(High)
Frequency (MHz)	829	836.5	844
Conducted Power (dBm)	21.68	21.74	21.75
Conducted Power (Watts)	0.1472	0.1493	0.1496
ERP(dBm)	16.48	16.54	16.55
ERP(Watts)	0.0445	0.0451	0.0452



LTE Band 26 (G _T - L _C = -3.05 dBi) QPSK									
Bandwidth	1.4M			3M			5M		
Channel	26797	26915	27033	26805	26915	27025	26815	26915	27015
	(Low)	(Mid)	(High)	(Low)	(Mid)	(High)	(Low)	(Mid)	(High)
Frequency	824.7	836.5	848.3	825.5	836.5	847.5	826.5	836.5	846.5
(MHz)									
Conducted Power (dBm)	23.29	23.07	23.18	23.20	23.29	23.03	23.00	23.07	23.13
Conducted Power (Watts)	0.2133	0.2028	0.2080	0.2089	0.2133	0.2009	0.1995	0.2028	0.2056
ERP(dBm)	18.09	17.87	17.98	18.00	18.09	17.83	17.80	17.87	17.93
ERP(Watts)	0.0644	0.0612	0.0628	0.0631	0.0644	0.0607	0.0603	0.0612	0.0621

LTE Band 26 (G _T - L _C = -3.05 dBi) QPSK							
Bandwidth	10M			15M			15M
Channel	26840	26915	26990	26865	26915	26965	26765
	(Low)	(Mid)	(High)	(Low)	(Mid)	(High)	(Low)
Frequency	829	836.5	844	831.5	836.5	841.5	821.5
(MHz)							
Conducted Power (dBm)	23.11	23.02	23.37	23.12	23.22	22.89	23.28
Conducted Power (Watts)	0.2046	0.2004	0.2173	0.2051	0.2099	0.1945	0.2128
ERP(dBm)	17.91	17.82	18.17	17.92	18.02	17.69	18.08
ERP(Watts)	0.0618	0.0605	0.0656	0.0619	0.0634	0.0587	0.0643



LTE Band 26 (G _T - L _C = -3.05 dBi) 16QAM									
Bandwidth	1.4M			3M			5M		
Channel	26797	26915	27033	26805	26915	27025	26815	26915	27015
	(Low)	(Mid)	(High)	(Low)	(Mid)	(High)	(Low)	(Mid)	(High)
Frequency	824.7	836.5	848.3	825.5	836.5	847.5	826.5	836.5	846.5
(MHz)									
Conducted Power (dBm)	22.40	22.12	22.36	21.51	22.32	21.83	21.72	22.37	22.36
Conducted Power (Watts)	0.1738	0.1629	0.1722	0.1416	0.1706	0.1524	0.1486	0.1726	0.1722
ERP(dBm)	17.20	16.92	17.16	16.31	17.12	16.63	16.52	17.17	17.16
ERP(Watts)	0.0525	0.0492	0.0520	0.0428	0.0515	0.0460	0.0449	0.0521	0.0520

LTE Band 26 (G _T - L _C = -3.05 dBi) 16QAM							
Bandwidth	10M			15M			15M
Channel	26840	26915	26990	26865	26915	26965	26765
	(Low)	(Mid)	(High)	(Low)	(Mid)	(High)	(Low)
Frequency	829	836.5	844	831.5	836.5	841.5	821.5
(MHz)							
Conducted Power (dBm)	22.11	22.17	21.73	21.68	21.95	22.36	22.02
Conducted Power (Watts)	0.1626	0.1648	0.1489	0.1472	0.1567	0.1722	0.1592
ERP(dBm)	16.91	16.97	16.53	16.48	16.75	17.16	16.82
ERP(Watts)	0.0491	0.0498	0.0450	0.0445	0.0473	0.0520	0.0481



LTE Band 38 (G _T - L _C = 2.27 dBi) QPSK									
Bandwidth	5M			10M			15M		
Channel	37775	38000	38225	37800	38000	38200	37825	38000	38175
	(Low)	(Mid)	(High)	(Low)	(Mid)	(High)	(Low)	(Mid)	(High)
Frequency	2572.5	2595	2617.5	2575	2595	2615	2577.5	2595	2612.5
(MHz)									
Conducted Power (dBm)	23.05	22.79	22.72	22.99	22.77	23.01	23.18	22.78	22.88
Conducted Power (Watts)	0.2018	0.1901	0.1871	0.1991	0.1892	0.2000	0.2080	0.1897	0.1941
EIRP(dBm)	25.32	25.06	24.99	25.26	25.04	25.28	25.45	25.05	25.15
EIRP(Watts)	0.3404	0.3206	0.3155	0.3357	0.3192	0.3373	0.3508	0.3199	0.3273

LTE Band 38 (G _T - L _C = 2.27 dBi) QPSK			
Bandwidth	20M		
Channel	37850	38000	38150
	(Low)	(Mid)	(High)
Frequency	2580	2595	2610
(MHz)			
Conducted Power (dBm)	23.21	22.99	22.87
Conducted Power (Watts)	0.2094	0.1991	0.1936
EIRP(dBm)	25.48	25.26	25.14
EIRP(Watts)	0.3532	0.3357	0.3266



LTE Band 38 (G _T - L _C = 2.27 dBi) 16QAM									
Bandwidth	5M			10M			15M		
Channel	37775	38000	38225	37800	38000	38200	37825	38000	38175
	(Low)	(Mid)	(High)	(Low)	(Mid)	(High)	(Low)	(Mid)	(High)
Frequency (MHz)	2572.5	2595	2617.5	2575	2595	2615	2577.5	2595	2612.5
Conducted Power (dBm)	21.87	21.69	21.42	21.88	21.57	21.78	22.01	21.78	21.68
Conducted Power (Watts)	0.1538	0.1476	0.1387	0.1542	0.1435	0.1507	0.1589	0.1507	0.1472
EIRP(dBm)	24.14	23.96	23.69	24.15	23.84	24.05	24.28	24.05	23.95
EIRP(Watts)	0.2594	0.2489	0.2339	0.2600	0.2421	0.2541	0.2679	0.2541	0.2483

LTE Band 38 (G _T - L _C = 2.27 dBi) 16QAM			
Bandwidth	20M		
Channel	37850	38000	38150
	(Low)	(Mid)	(High)
Frequency (MHz)	2580	2595	2610
Conducted Power (dBm)	21.91	21.59	21.67
Conducted Power (Watts)	0.1552	0.1442	0.1469
EIRP(dBm)	24.18	23.86	23.94
EIRP(Watts)	0.2618	0.2432	0.2477



LTE Band 41 (G _T - L _C = 3.06 dBi) QPSK									
Bandwidth	5M			10M			15M		
Channel	40065	40640	41215	40090	40640	41190	40115	40640	41165
	(Low)	(Mid)	(High)	(Low)	(Mid)	(High)	(Low)	(Mid)	(High)
Frequency (MHz)	2537.5	2595	2652.5	2540	2595	2650	2542.5	2595	2647.5
Conducted Power (dBm)	23.03	23.00	23.00	23.03	23.14	23.03	23.27	23.21	23.04
Conducted Power (Watts)	0.2009	0.1995	0.1995	0.2009	0.2061	0.2009	0.2123	0.2094	0.2014
EIRP(dBm)	26.09	26.06	26.06	26.09	26.20	26.09	26.33	26.27	26.10
EIRP(Watts)	0.4064	0.4036	0.4036	0.4064	0.4169	0.4064	0.4295	0.4236	0.4074

LTE Band 41 (G _T - L _C = 3.06 dBi) QPSK			
Bandwidth	20M		
Channel	40140	40640	41140
	(Low)	(Mid)	(High)
Frequency (MHz)	2545	2595	2645
Conducted Power (dBm)	23.07	23.04	23.22
Conducted Power (Watts)	0.2028	0.2014	0.2099
EIRP(dBm)	26.13	26.10	26.28
EIRP(Watts)	0.4102	0.4074	0.4246



LTE Band 41 (G _T - L _C = 3.06 dBi) 16QAM									
Bandwidth	5M			10M			15M		
Channel	40065	40640	41215	40090	40640	41190	40115	40640	41165
	(Low)	(Mid)	(High)	(Low)	(Mid)	(High)	(Low)	(Mid)	(High)
Frequency (MHz)	2537.5	2595	2652.5	2540	2595	2650	2542.5	2595	2647.5
Conducted Power (dBm)	21.57	22.08	21.63	22.27	22.04	21.89	21.98	21.90	22.12
Conducted Power (Watts)	0.1435	0.1614	0.1455	0.1687	0.1600	0.1545	0.1578	0.1549	0.1629
EIRP(dBm)	24.63	25.14	24.69	25.33	25.10	24.95	25.04	24.96	25.18
EIRP(Watts)	0.2904	0.3266	0.2944	0.3412	0.3236	0.3126	0.3192	0.3133	0.3296

LTE Band 41 (G _T - L _C = 3.06 dBi) 16QAM			
Bandwidth	20M		
Channel	40140	40640	41140
	(Low)	(Mid)	(High)
Frequency (MHz)	2545	2595	2645
Conducted Power (dBm)	22.02	21.97	21.79
Conducted Power (Watts)	0.1592	0.1574	0.1510
EIRP(dBm)	25.08	25.03	24.85
EIRP(Watts)	0.3221	0.3184	0.3055



Peak-to-Average Ratio

Mode	LTE Band 5 / 10MHz				
Mod.	QPSK		16QAM		Limit: 13dB
RB Size	1RB	Full RB	1RB	Full RB	Result
Lowest CH	4.75	5.13	5.62	6.03	PASS
Middle CH	4.72	5.10	5.48	6.06	
Highest CH	4.61	5.01	5.57	6.00	

Mode	LTE Band 26 / 15MHz				
Mod.	QPSK		16QAM		Limit: 13dB
RB Size	1RB	Full RB	1RB	Full RB	Result
Lowest CH	3.74	5.16	4.58	6.06	PASS
Middle CH	3.71	5.16	4.61	6.14	
Highest CH	3.74	5.07	4.67	6.06	

Mode	LTE Band 38 / 20MHz				
Mod.	QPSK		16QAM		Limit: 13dB
RB Size	1RB	Full RB	1RB	Full RB	Result
Lowest CH	5.01	5.30	5.39	6.12	PASS
Middle CH	4.32	5.13	6.09	6.14	
Highest CH	6.32	5.07	6.09	5.97	

Mode	LTE Band 41 / 20MHz				
Mod.	QPSK		16QAM		Limit: 13dB
RB Size	1RB	Full RB	1RB	Full RB	Result
Lowest CH	3.83	4.67	4.96	6.00	PASS
Middle CH	5.10	6.12	5.25	6.29	
Highest CH	5.25	5.33	4.78	6.41	



LTE Band 5 / 10MHz / QPSK

Lowest Channel / 1RB

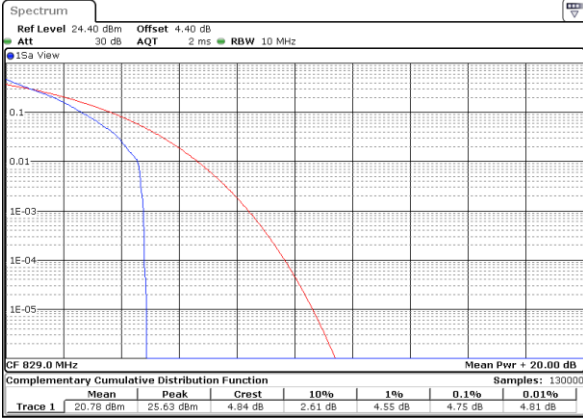

Date: 25 DEC 2017 19:46:55

Lowest Channel / Full RB



Date: 25 DEC 2017 19:46:40

Middle Channel / 1RB

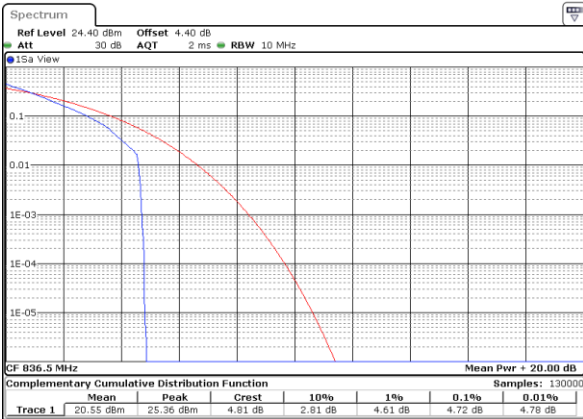

Date: 25 DEC 2017 19:47:07

Middle Channel / Full RB

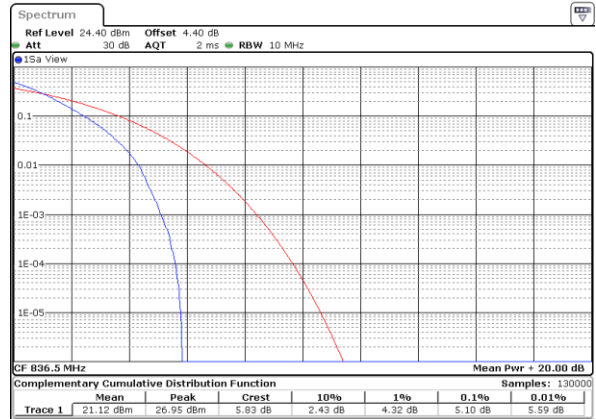

Date: 25 DEC 2017 19:46:26

Highest Channel / 1RB

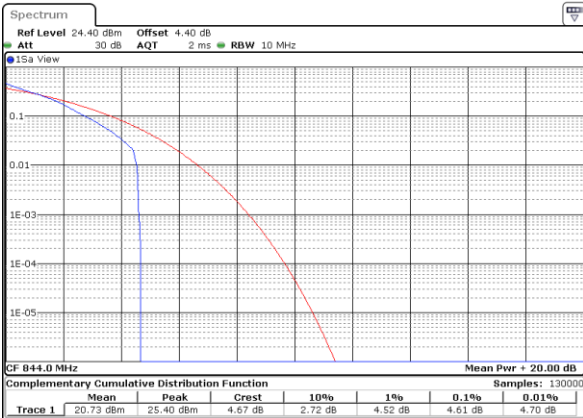

Date: 25 DEC 2017 19:47:20

Highest Channel / Full RB



Date: 25 DEC 2017 19:46:12



LTE Band 5 / 10MHz / 16QAM

Lowest Channel / 1RB

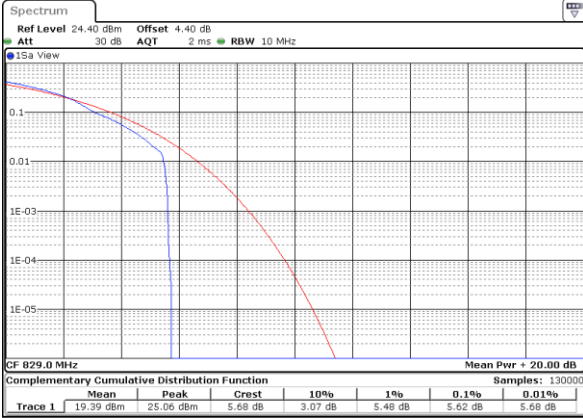

Date: 25 DEC 2017 19:44:01

Lowest Channel / Full RB

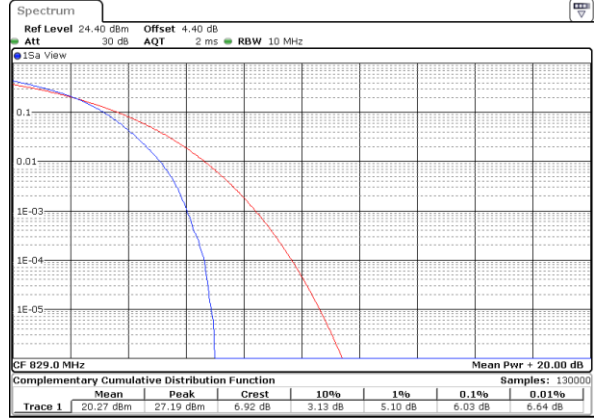

Date: 25 DEC 2017 19:44:11

Middle Channel / 1RB

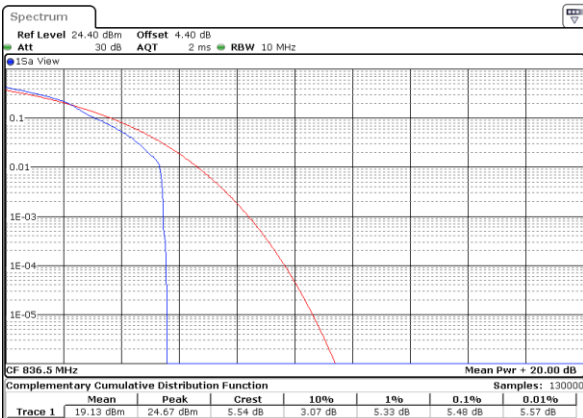

Date: 25 DEC 2017 19:44:20

Middle Channel / Full RB

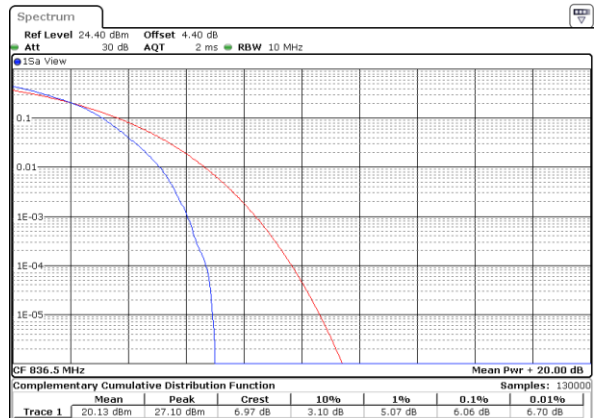

Date: 25 DEC 2017 19:44:29

Highest Channel / 1RB

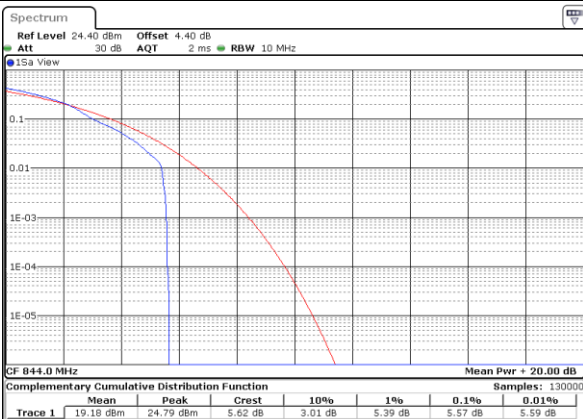

Date: 25 DEC 2017 19:44:38

Highest Channel / Full RB



Date: 25 DEC 2017 19:44:49



LTE Band 26 / 15MHz / QPSK

Lowest Channel / 1RB

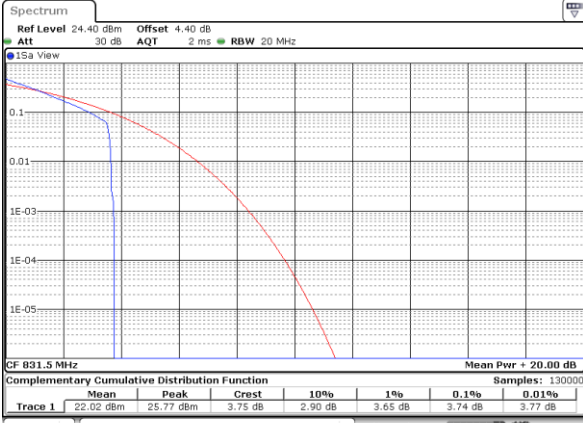

Date: 26 DEC 2017 12:54:32

Lowest Channel / Full RB

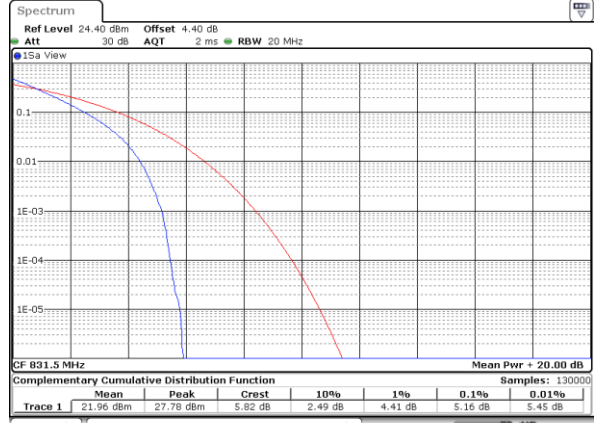

Date: 26 DEC 2017 12:56:31

Middle Channel / 1RB

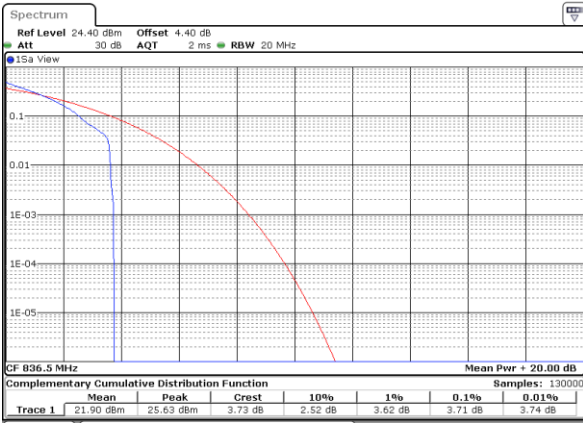

Date: 26 DEC 2017 12:55:11

Middle Channel / Full RB

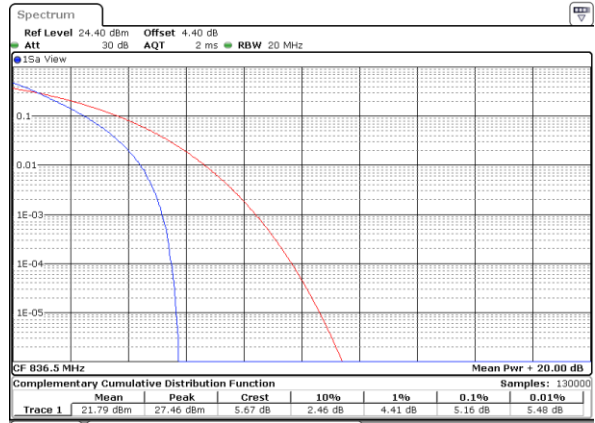

Date: 26 DEC 2017 12:57:20

Highest Channel / 1RB

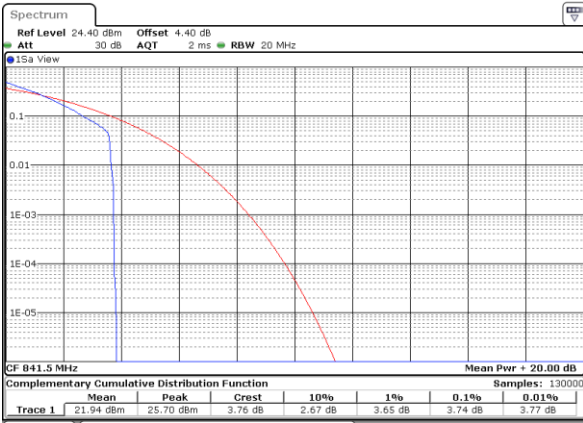

Date: 26 DEC 2017 12:55:38

Highest Channel / Full RB

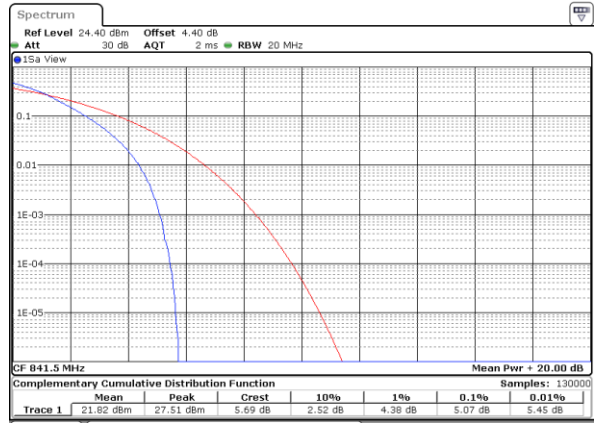

Date: 26 DEC 2017 12:57:34



LTE Band 26 / 15MHz / 16QAM

Lowest Channel / 1RB

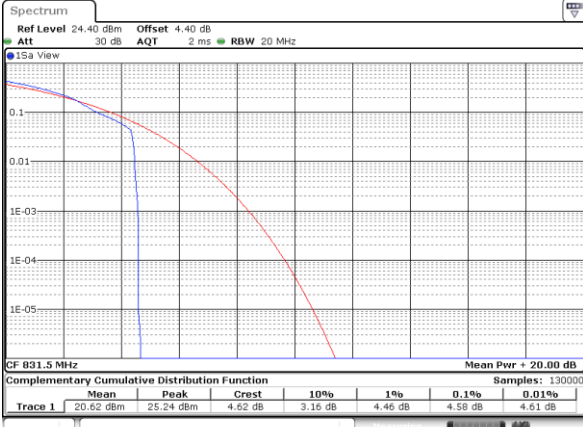

Date: 26 DEC 2017 12:54:49

Lowest Channel / Full RB

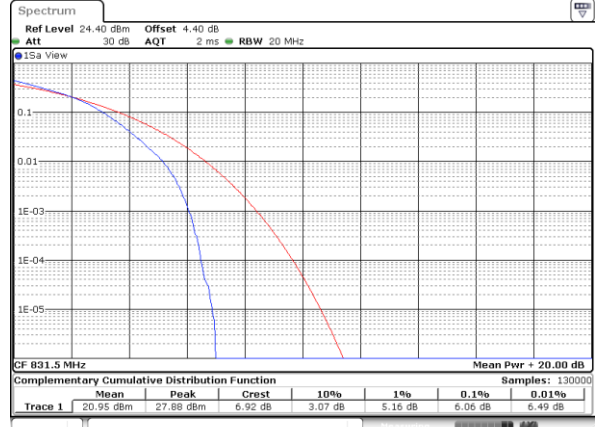

Date: 26 DEC 2017 12:56:46

Middle Channel / 1RB

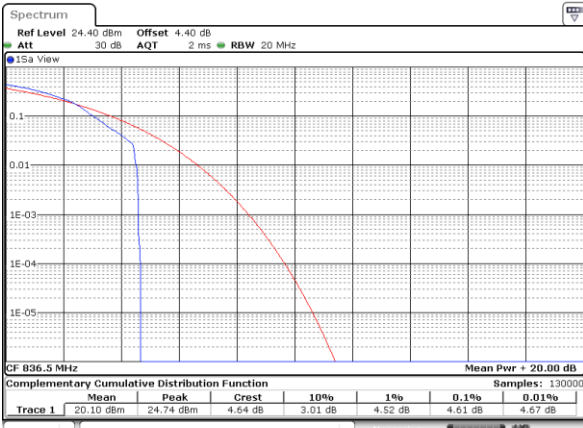

Date: 26 DEC 2017 12:55:00

Middle Channel / Full RB

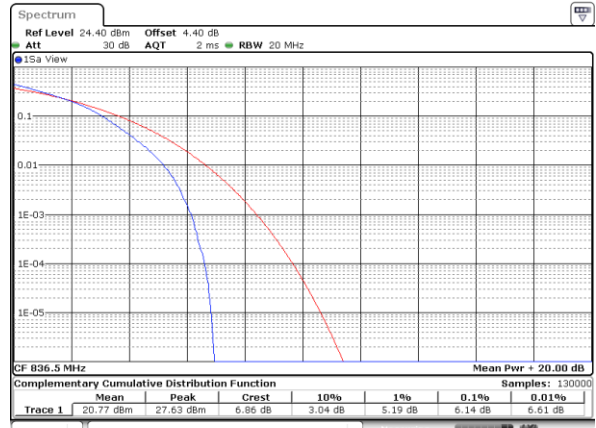

Date: 26 DEC 2017 12:56:58

Highest Channel / 1RB

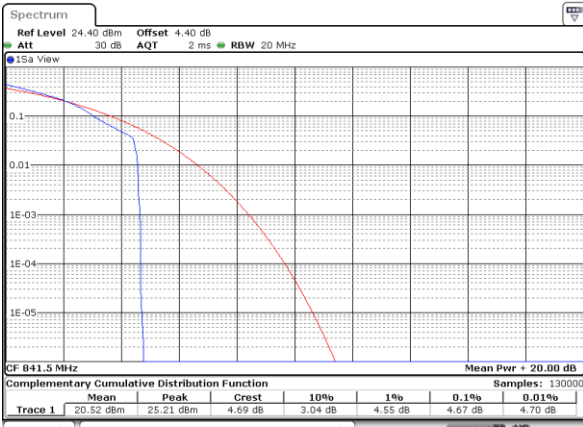

Date: 26 DEC 2017 12:56:14

Highest Channel / Full RB

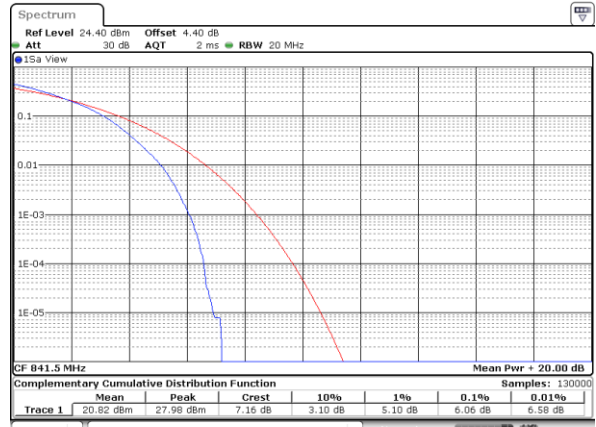

Date: 26 DEC 2017 12:57:47



LTE Band 38 / 20MHz / QPSK

Lowest Channel / 1RB

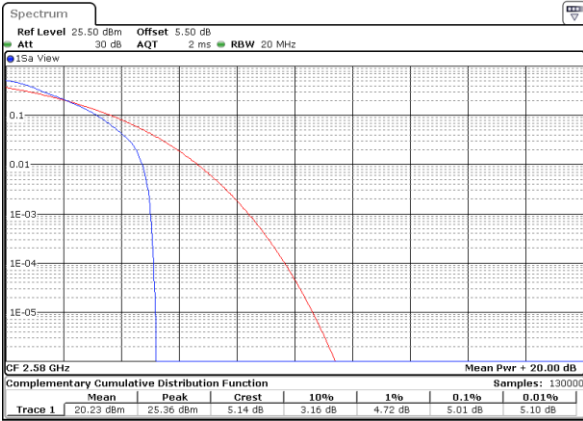

Date: 26 DEC 2017 08:56:27

Lowest Channel / Full RB

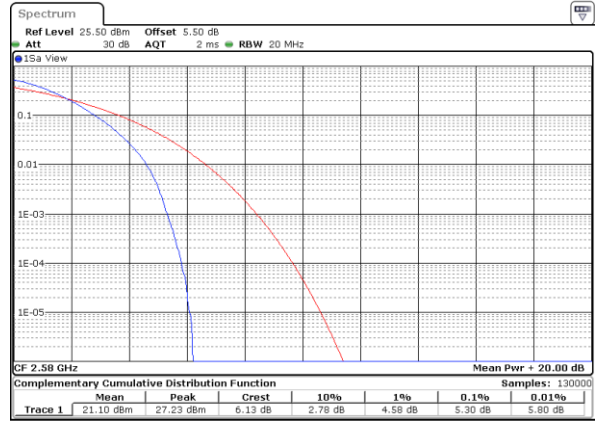

Date: 26 DEC 2017 08:57:41

Middle Channel / 1RB



Date: 26 DEC 2017 08:58:00

Middle Channel / Full RB

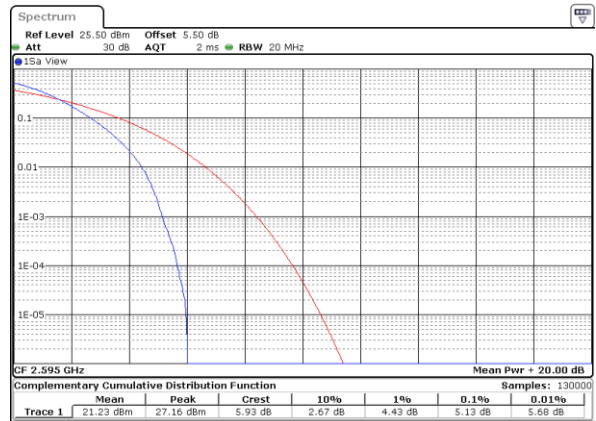

Date: 26 DEC 2017 08:59:08

Highest Channel / 1RB



Date: 26 DEC 2017 08:59:31

Highest Channel / Full RB

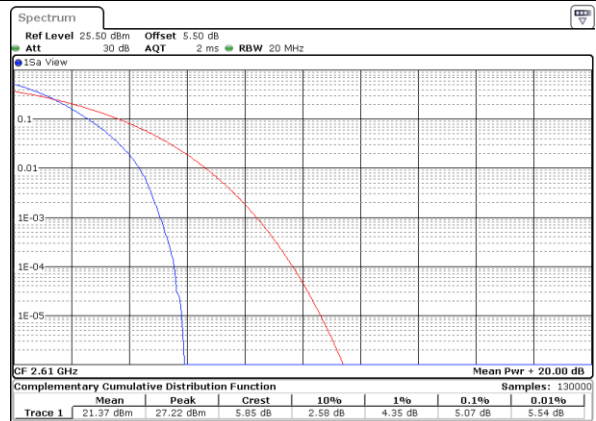

Date: 26 DEC 2017 09:00:49



LTE Band 38 / 20MHz / 16QAM

Lowest Channel / 1RB

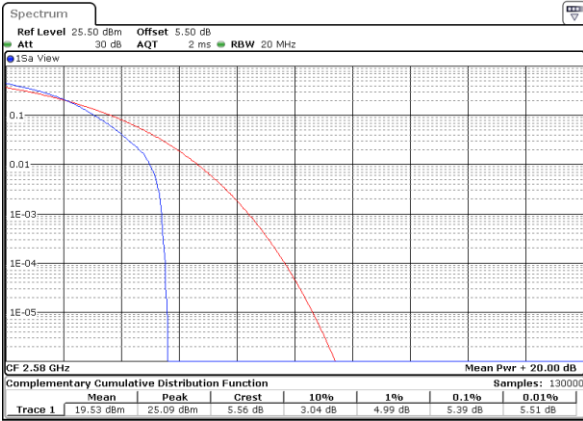

Date: 26 DEC 2017 08:56:53

Lowest Channel / Full RB

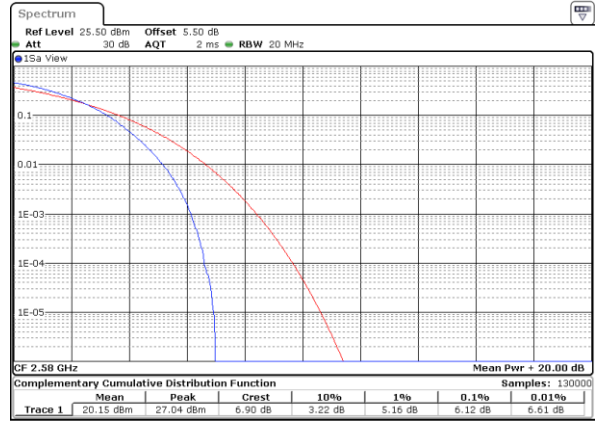

Date: 26 DEC 2017 08:57:22

Middle Channel / 1RB



Date: 26 DEC 2017 08:58:24

Middle Channel / Full RB

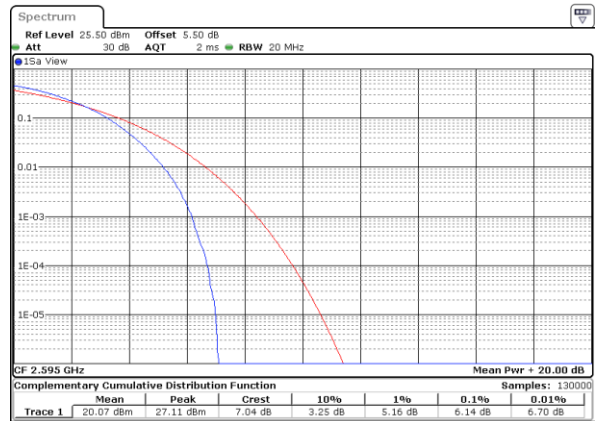

Date: 26 DEC 2017 08:58:51

Highest Channel / 1RB



Date: 26 DEC 2017 08:59:59

Highest Channel / Full RB

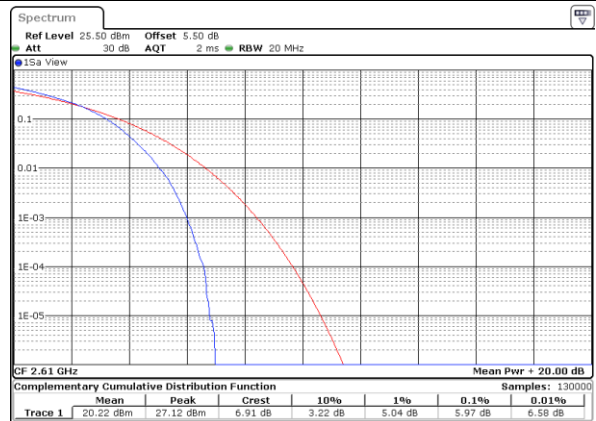

Date: 26 DEC 2017 09:00:20



LTE Band 41 / 20MHz / QPSK

Lowest Channel / 1RB

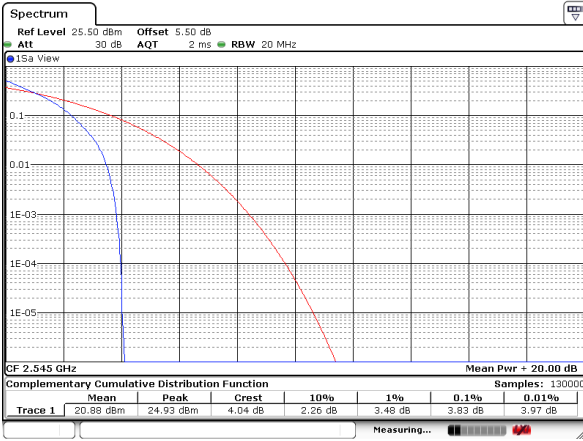

Date: 27 DEC 2017 22:32:22

Lowest Channel / Full RB

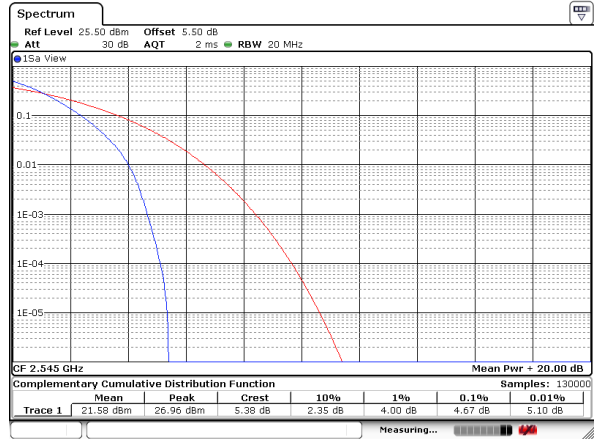

Date: 27 DEC 2017 22:31:03

Middle Channel / 1RB

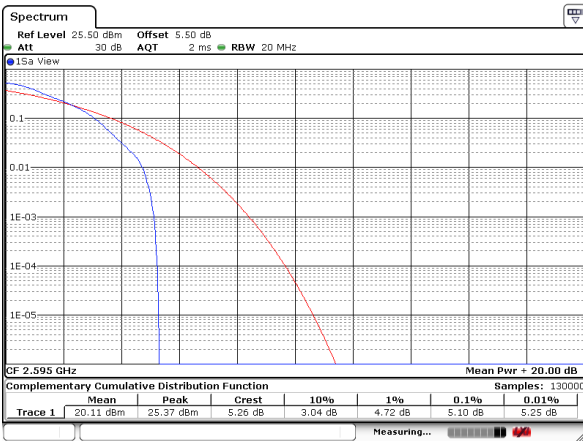

Date: 27 DEC 2017 22:32:54

Middle Channel / Full RB

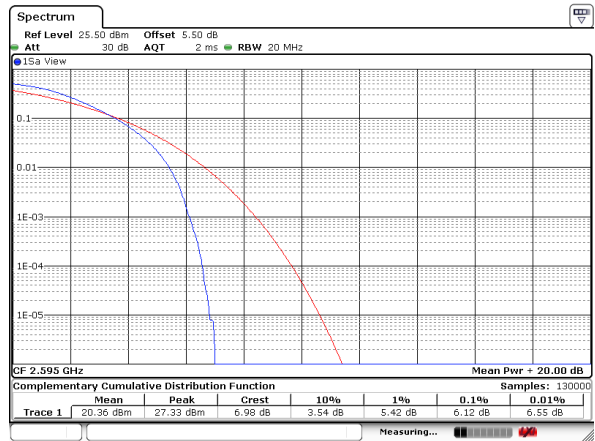

Date: 27 DEC 2017 22:33:56

Highest Channel / 1RB

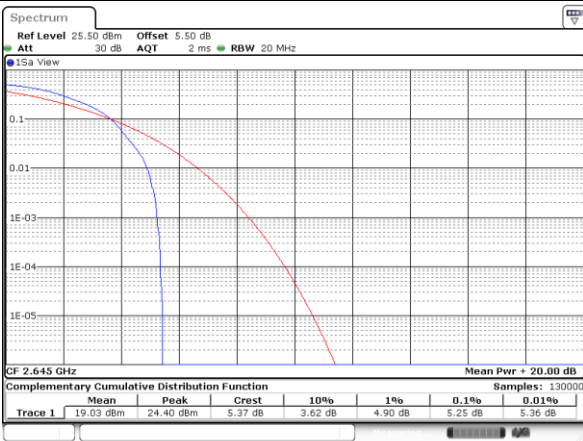

Date: 27 DEC 2017 21:06:03

Highest Channel / Full RB

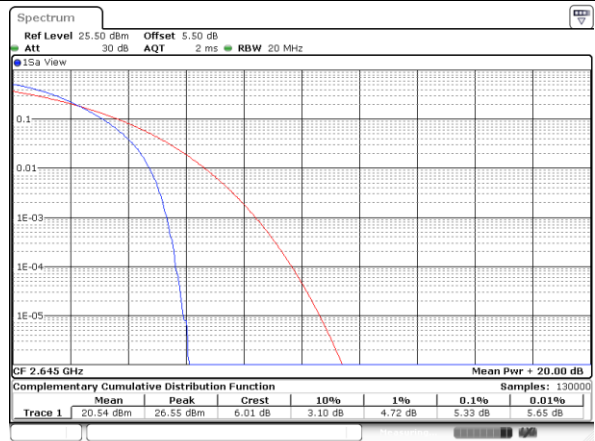

Date: 27 DEC 2017 21:07:00



LTE Band 41 / 20MHz / 16QAM

Lowest Channel / 1RB

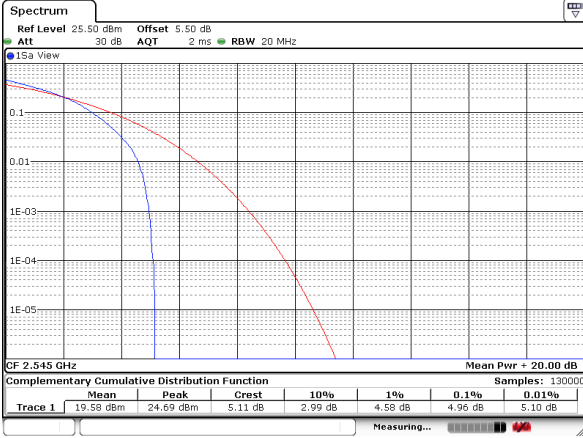

Date: 27.DEC.2017 22:32:03

Lowest Channel / Full RB

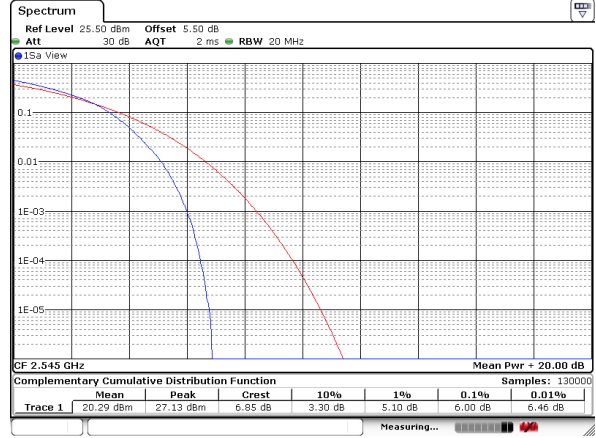

Date: 27.DEC.2017 22:31:49

Middle Channel / 1RB

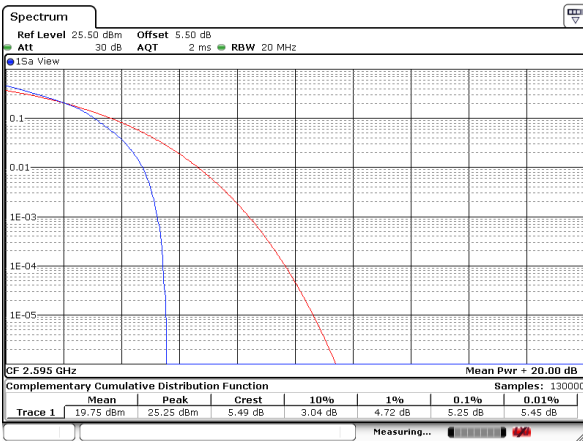

Date: 27.DEC.2017 22:33:08

Middle Channel / Full RB

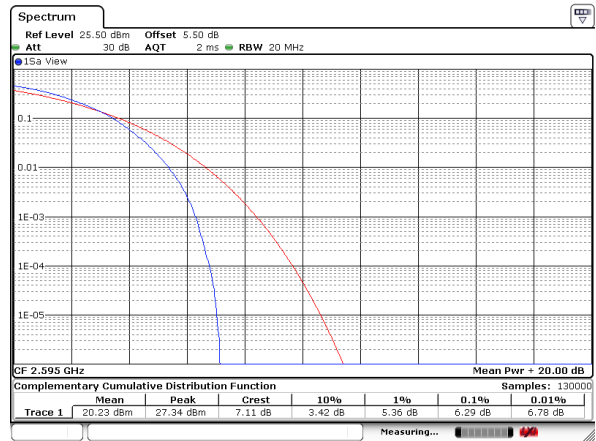

Date: 27.DEC.2017 22:33:30

Highest Channel / 1RB

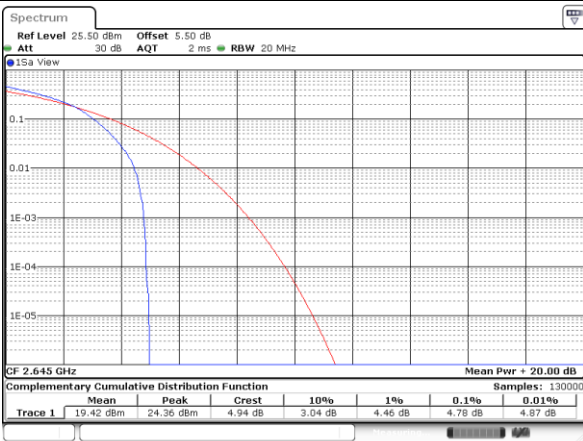

Date: 27.DEC.2017 21:06:25

Highest Channel / Full RB



Date: 27.DEC.2017 21:06:45



26dB Bandwidth

Mode	LTE Band 5 : 26dB BW(MHz)											
	1.4MHz		3MHz		5MHz		10MHz		15MHz		20MHz	
Mod.	QPSK	16QAM	QPSK	16QAM	QPSK	16QAM	QPSK	16QAM	QPSK	16QAM	QPSK	16QAM
Lowest CH	1.259	1.278	2.991	3.021	4.915	5.005	9.93	9.75	-	-	-	-
Middle CH	1.281	1.267	3.003	3.009	4.895	4.925	9.71	9.83	-	-	-	-
Highest CH	1.287	1.298	3.015	2.991	4.905	4.885	9.67	9.71	-	-	-	-

Mode	LTE Band 26 : 26dB BW(MHz)											
	1.4MHz		3MHz		5MHz		10MHz		15MHz		CH26765	
Mod.	QPSK	16QAM	QPSK	16QAM	QPSK	16QAM	QPSK	16QAM	QPSK	16QAM	QPSK	16QAM
Lowest CH	1.264	1.292	2.985	3.045	4.885	4.925	9.81	9.83	14.625	14.416	14.446	14.356
Middle CH	1.262	1.276	3.051	2.997	4.875	4.845	9.73	9.89	14.296	14.476	-	-
Highest CH	1.284	1.287	2.997	3.015	4.945	4.915	9.85	9.61	14.146	14.505	-	-

Mode	LTE Band 38 : 26dB BW(MHz)											
	1.4MHz		3MHz		5MHz		10MHz		15MHz		20MHz	
Mod.	QPSK	16QAM	QPSK	16QAM	QPSK	16QAM	QPSK	16QAM	QPSK	16QAM	QPSK	16QAM
Lowest CH	-	-	-	-	4.935	4.805	9.65	9.85	14.476	14.416	20.06	19.98
Middle CH	-	-	-	-	4.855	4.835	9.63	9.89	14.655	14.266	20.18	20.02
Highest CH	-	-	-	-	5.015	4.915	9.69	9.67	14.446	14.146	20.18	20.14

Mode	LTE Band 41 : 26dB BW(MHz)											
	1.4MHz		3MHz		5MHz		10MHz		15MHz		20MHz	
Mod.	QPSK	16QAM	QPSK	16QAM	QPSK	16QAM	QPSK	16QAM	QPSK	16QAM	QPSK	16QAM
Lowest CH	-	-	-	-	4.775	4.745	9.81	9.91	14.116	14.146	20.06	20.02
Middle CH	-	-	-	-	4.925	4.905	9.73	9.85	14.595	14.236	20.10	20.06
Highest CH	-	-	-	-	5.025	4.795	9.67	9.71	14.416	14.505	20.10	20.02



LTE Band 5

Lowest Channel / 1.4MHz / QPSK

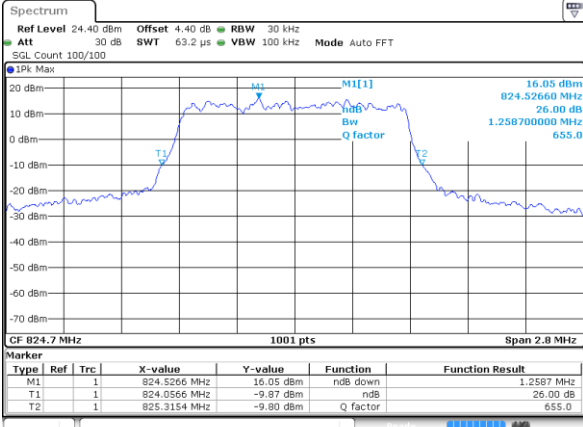

Date: 25 DEC 2017 18:22:31

Lowest Channel / 1.4MHz / 16QAM

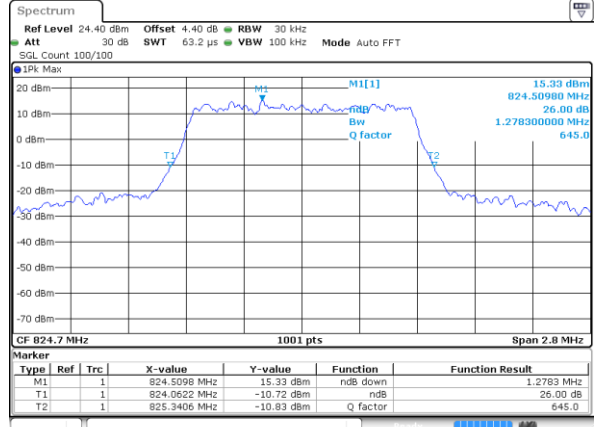

Date: 25 DEC 2017 18:22:21

Middle Channel / 1.4MHz / QPSK

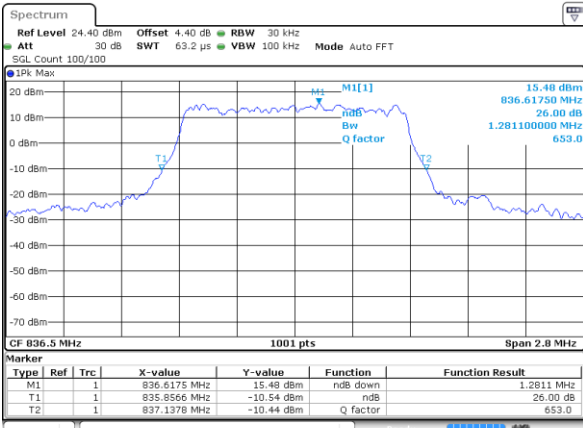

Date: 25 DEC 2017 18:31:20

Middle Channel / 1.4MHz / 16QAM

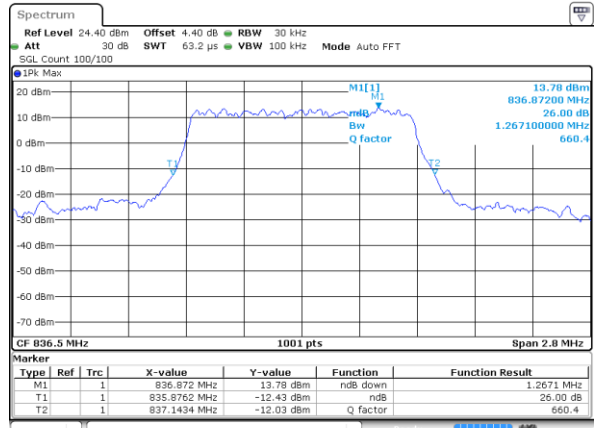

Date: 25 DEC 2017 18:31:30

Highest Channel / 1.4MHz / QPSK

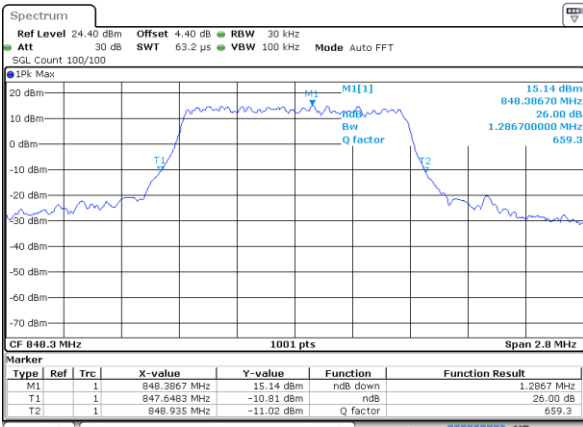

Date: 25 DEC 2017 18:33:49

Highest Channel / 1.4MHz / 16QAM

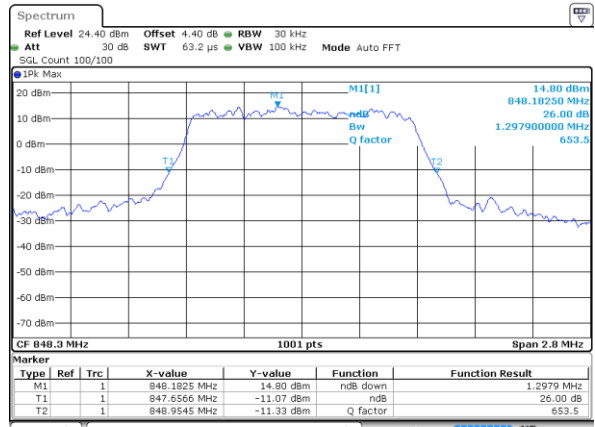

Date: 25 DEC 2017 18:33:59



LTE Band 5

Lowest Channel / 3MHz / QPSK

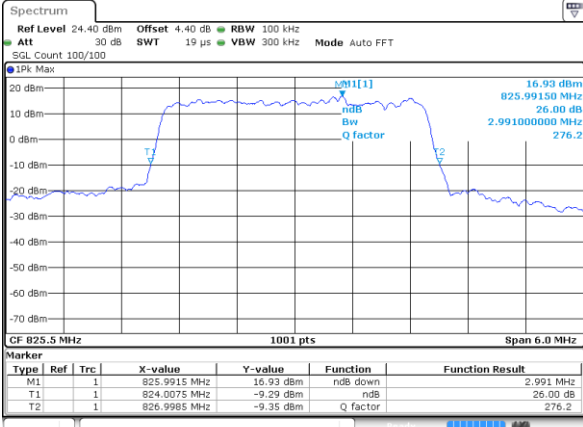

Date: 25 DEC 2017 18:42:48

Lowest Channel / 3MHz / 16QAM

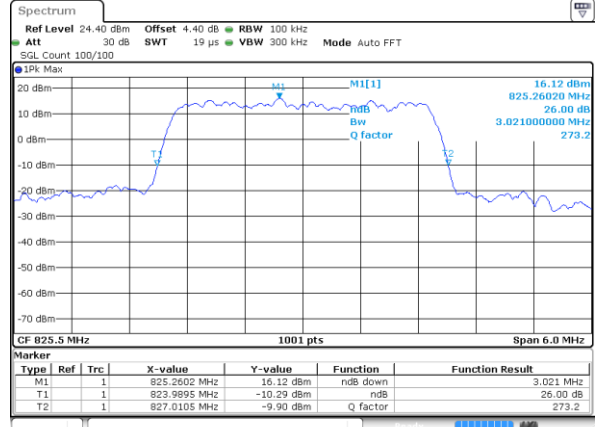

Date: 25 DEC 2017 18:42:58

Middle Channel / 3MHz / QPSK

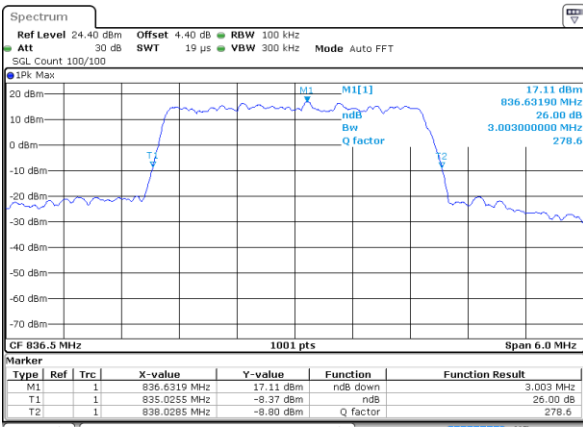

Date: 25 DEC 2017 18:51:48

Middle Channel / 3MHz / 16QAM

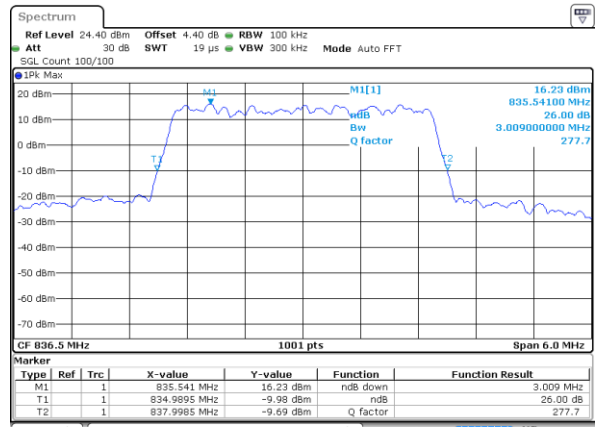

Date: 25 DEC 2017 18:51:58

Highest Channel / 3MHz / QPSK

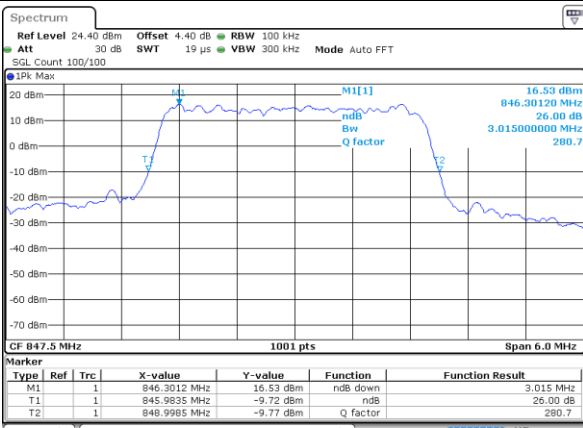

Date: 25 DEC 2017 18:54:17

Highest Channel / 3MHz / 16QAM

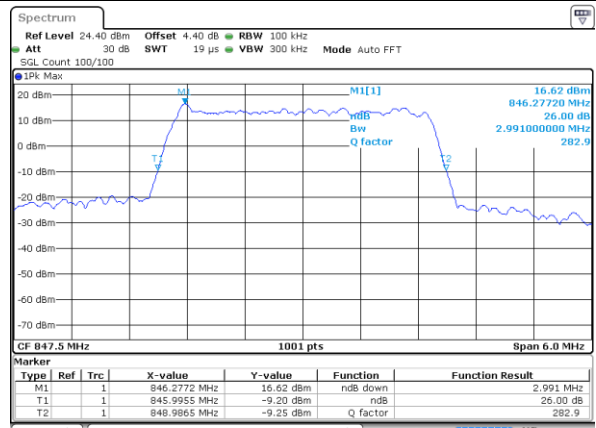

Date: 25 DEC 2017 18:54:27



LTE Band 5

Lowest Channel / 5MHz / QPSK

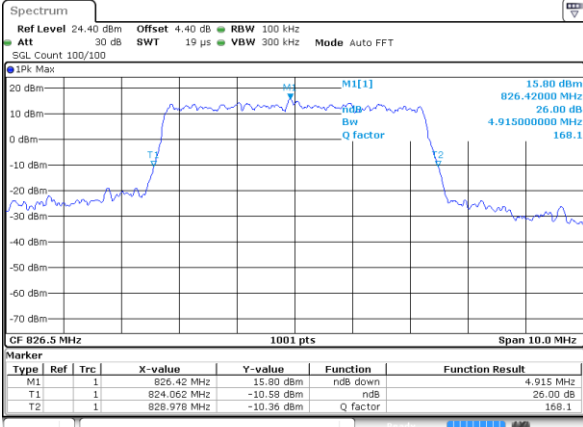

Date: 25 DEC 2017 19:03:16

Lowest Channel / 5MHz / 16QAM

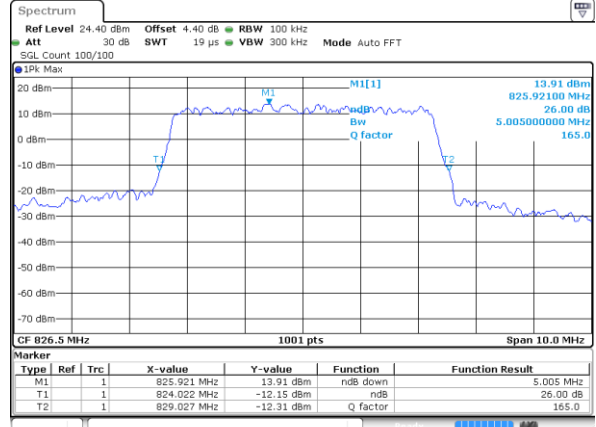

Date: 25 DEC 2017 19:03:26

Middle Channel / 5MHz / QPSK

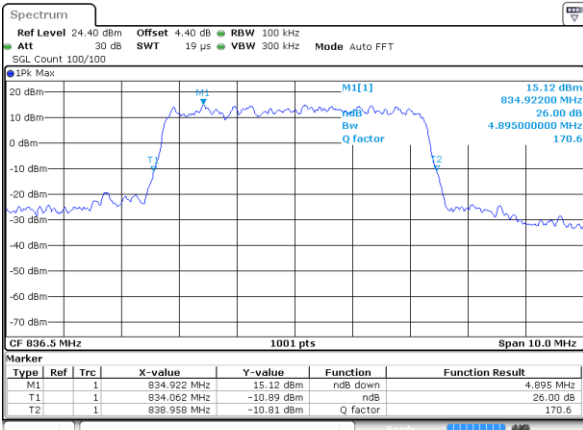

Date: 25 DEC 2017 19:12:15

Middle Channel / 5MHz / 16QAM

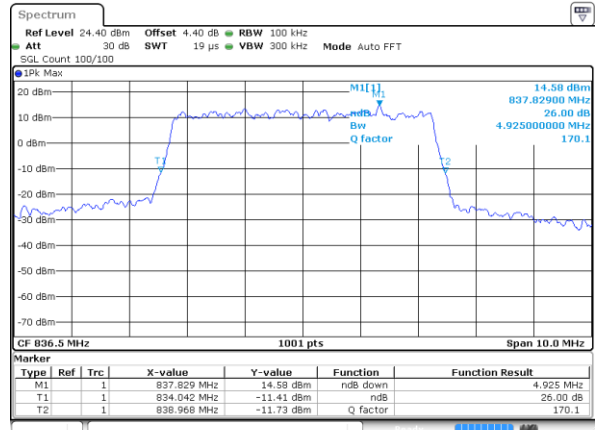

Date: 25 DEC 2017 19:12:25

Highest Channel / 5MHz / QPSK

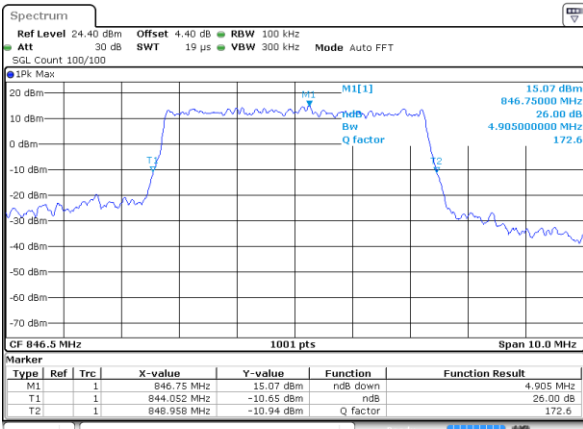

Date: 25 DEC 2017 19:14:44

Highest Channel / 5MHz / 16QAM

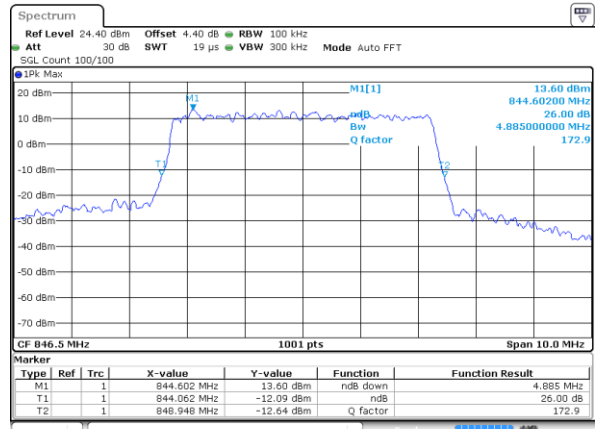

Date: 25 DEC 2017 19:14:54



LTE Band 5

Lowest Channel / 10MHz / QPSK

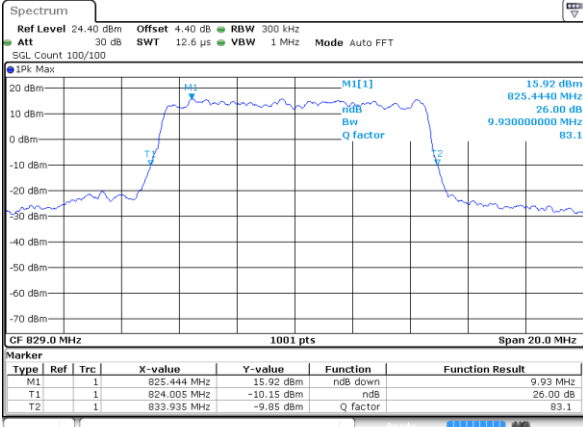

Date: 25 DEC 2017 19:23:43

Lowest Channel / 10MHz / 16QAM

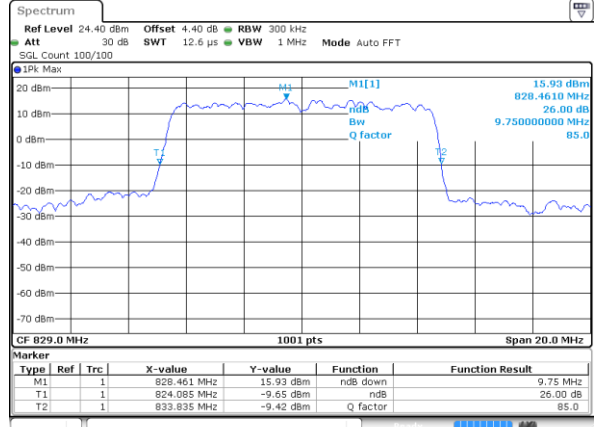

Date: 25 DEC 2017 19:23:53

Middle Channel / 10MHz / QPSK

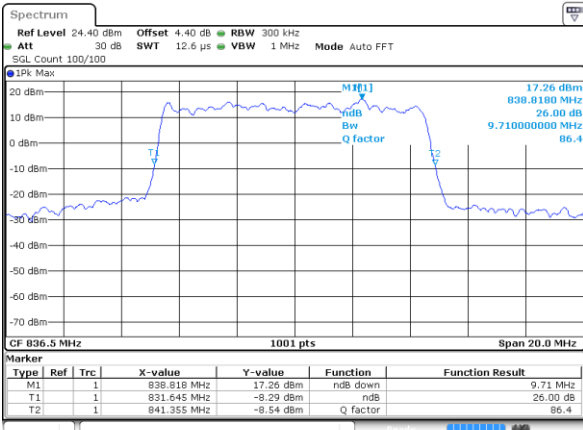

Date: 25 DEC 2017 19:32:42

Middle Channel / 10MHz / 16QAM

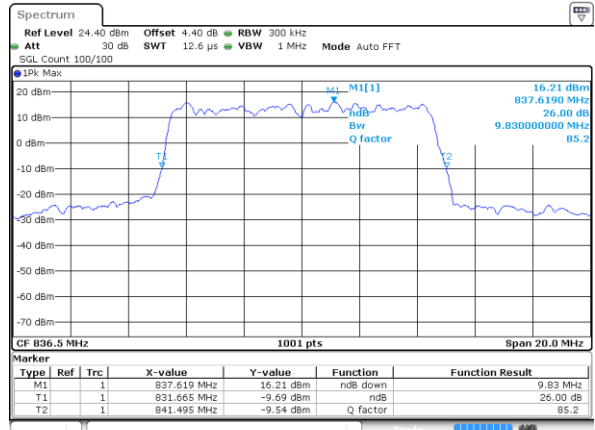

Date: 25 DEC 2017 19:32:52

Highest Channel / 10MHz / QPSK

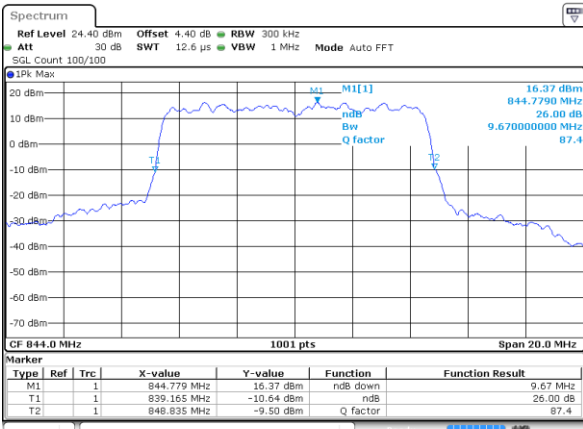

Date: 25 DEC 2017 19:35:11

Highest Channel / 10MHz / 16QAM

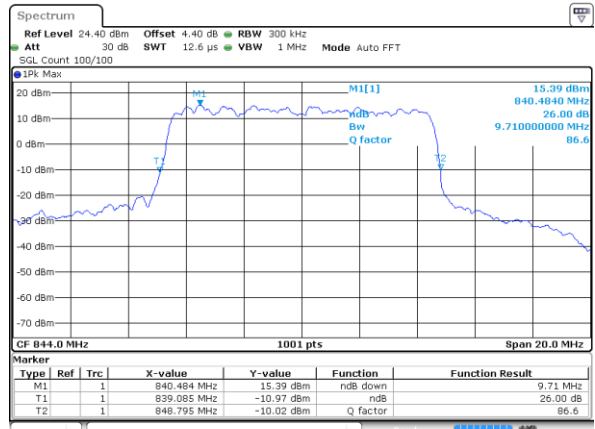

Date: 25 DEC 2017 19:35:21



LTE Band 26

Lowest Channel / 1.4MHz / QPSK

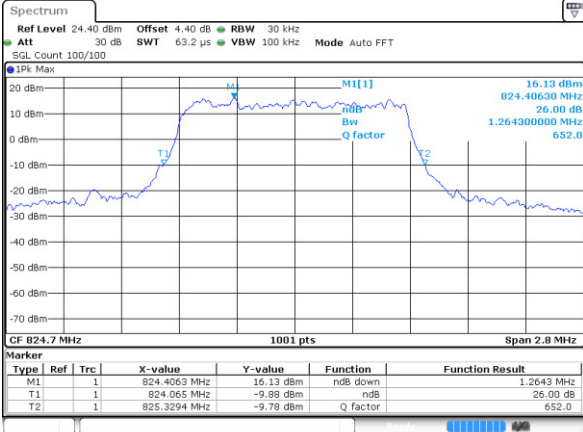

Date: 26 DEC 2017 10:51:26

Lowest Channel / 1.4MHz / 16QAM

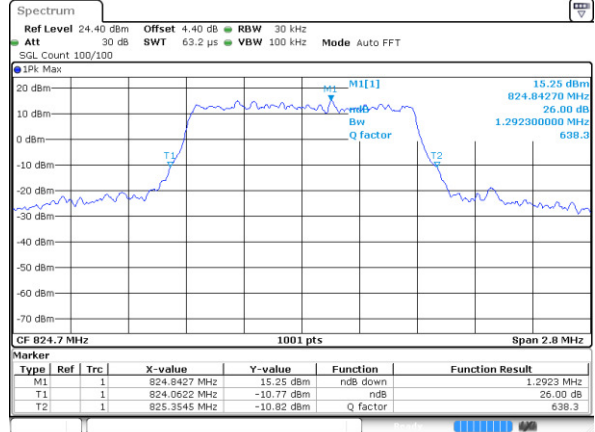

Date: 26 DEC 2017 10:51:03

Middle Channel / 1.4MHz / QPSK

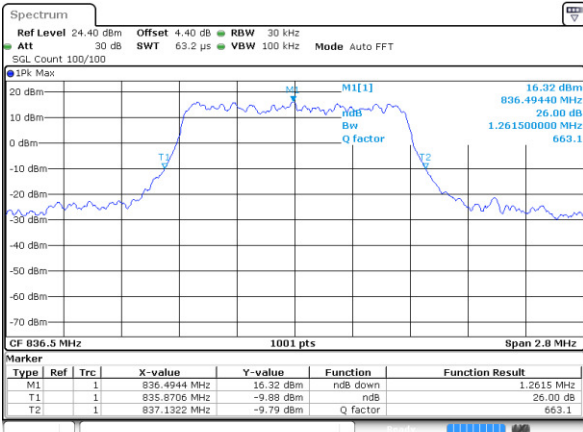

Date: 26 DEC 2017 10:51:56

Middle Channel / 1.4MHz / 16QAM

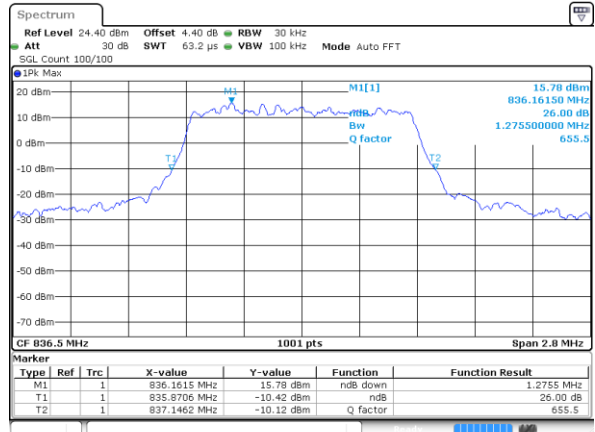

Date: 26 DEC 2017 10:52:14

Highest Channel / 1.4MHz / QPSK

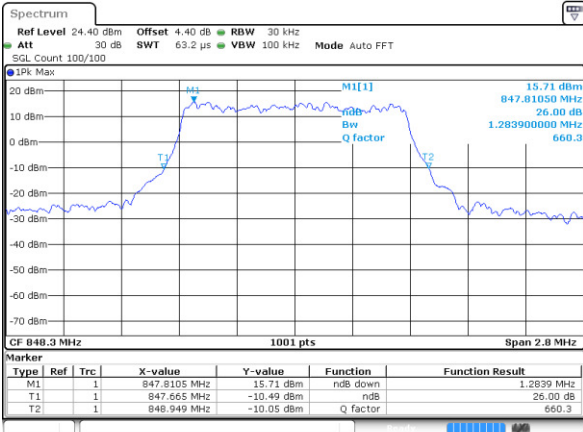

Date: 26 DEC 2017 10:52:57

Highest Channel / 1.4MHz / 16QAM

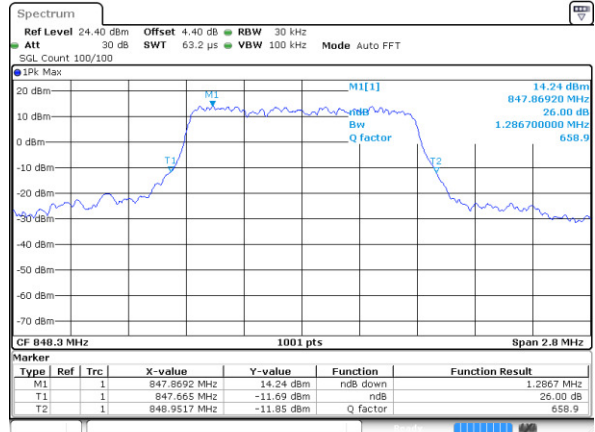

Date: 26 DEC 2017 10:52:39



LTE Band 26

Lowest Channel / 3MHz / QPSK

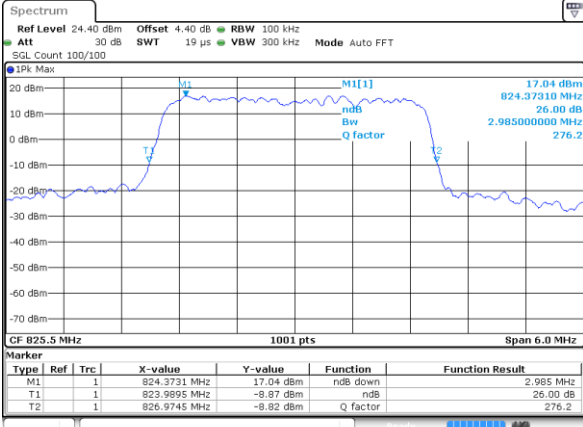

Date: 26 DEC 2017 12:33:19

Lowest Channel / 3MHz / 16QAM

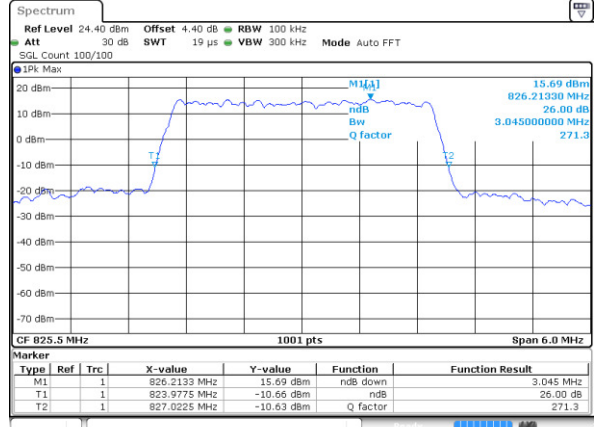

Date: 26 DEC 2017 12:33:40

Middle Channel / 3MHz / QPSK

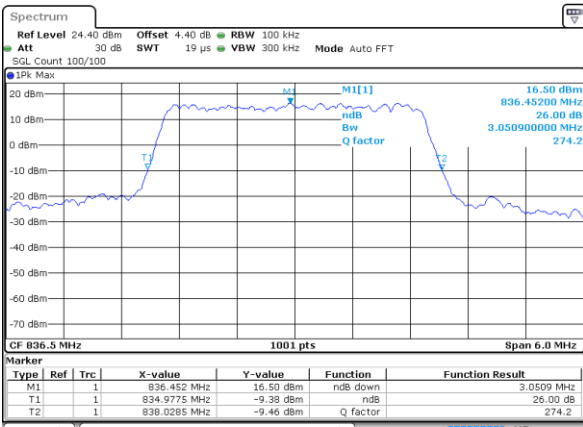

Date: 26 DEC 2017 12:34:52

Middle Channel / 3MHz / 16QAM

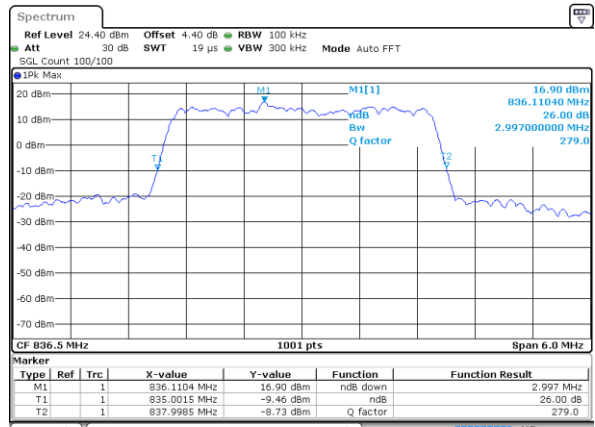

Date: 26 DEC 2017 12:34:09

Highest Channel / 3MHz / QPSK

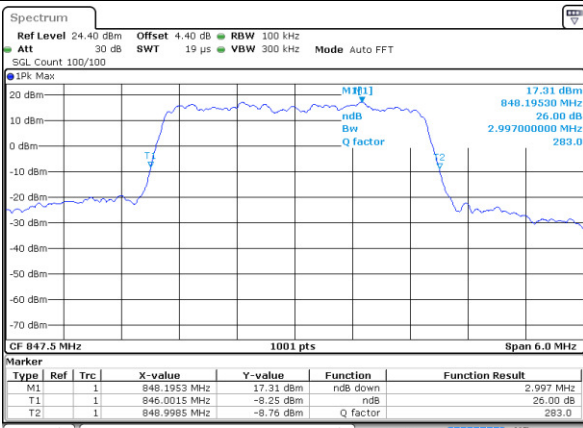

Date: 26 DEC 2017 12:35:18

Highest Channel / 3MHz / 16QAM

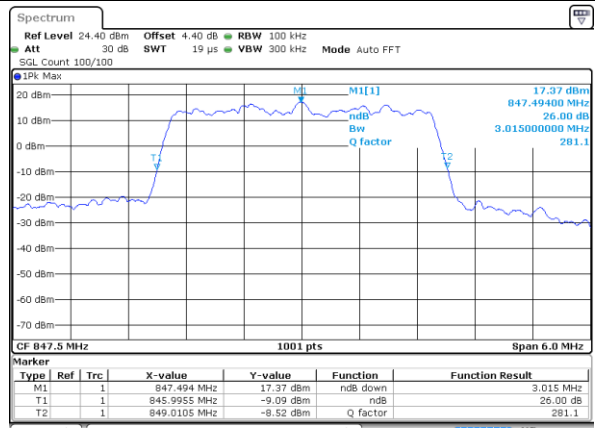

Date: 26 DEC 2017 12:36:04



LTE Band 26

Lowest Channel / 5MHz / QPSK

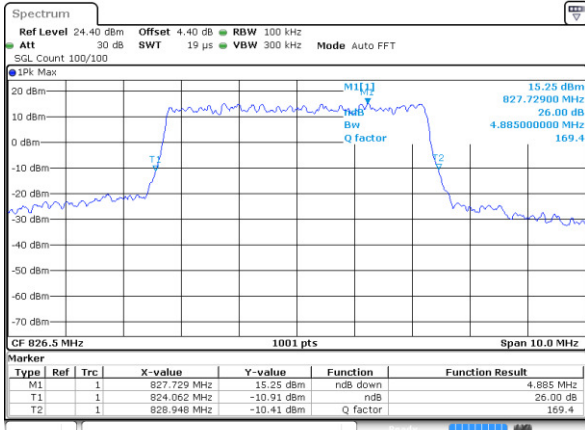

Date: 26 DEC 2017 12:37:08

Lowest Channel / 5MHz / 16QAM

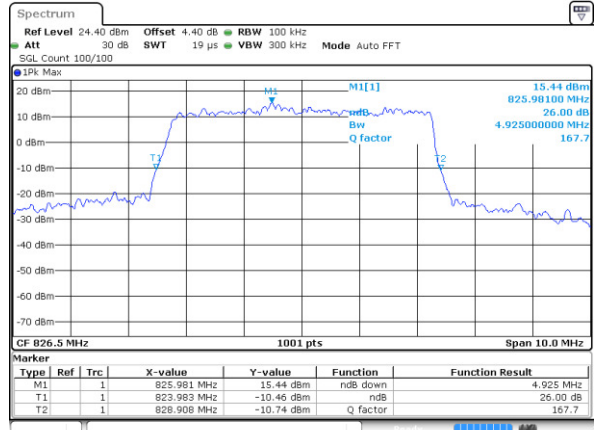

Date: 26 DEC 2017 12:37:29

Middle Channel / 5MHz / QPSK

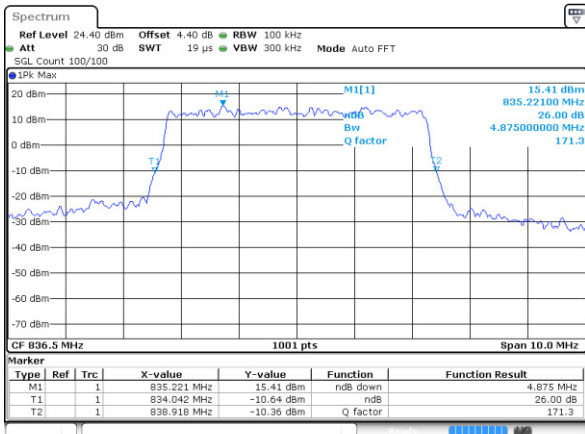

Date: 26 DEC 2017 12:39:39

Middle Channel / 5MHz / 16QAM

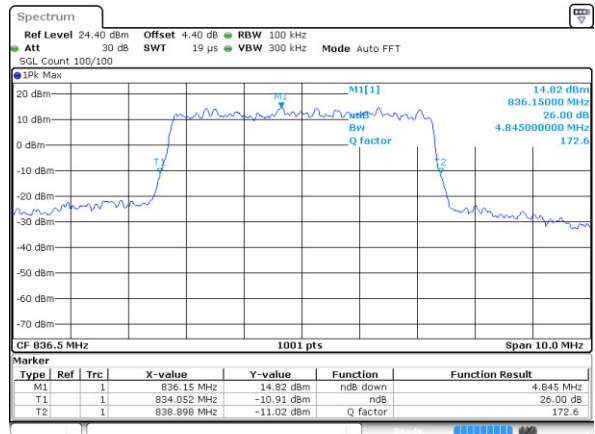

Date: 26 DEC 2017 12:37:59

Highest Channel / 5MHz / QPSK

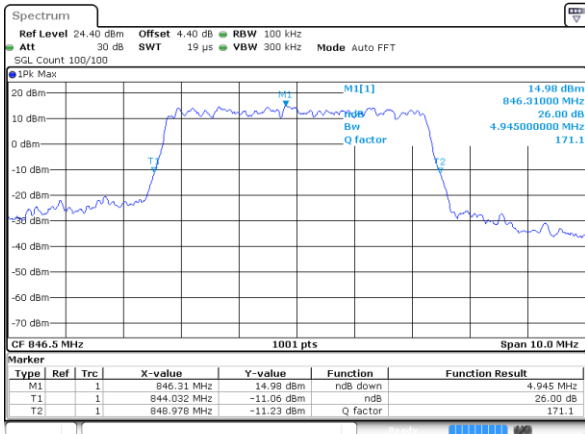

Date: 26 DEC 2017 12:38:40

Highest Channel / 5MHz / 16QAM

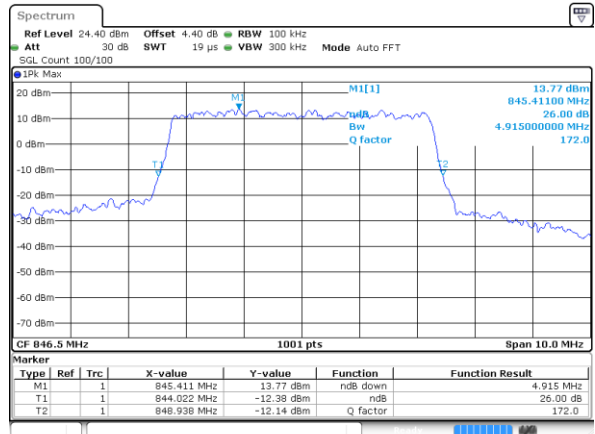

Date: 26 DEC 2017 12:39:20



LTE Band 26

Lowest Channel / 10MHz / QPSK

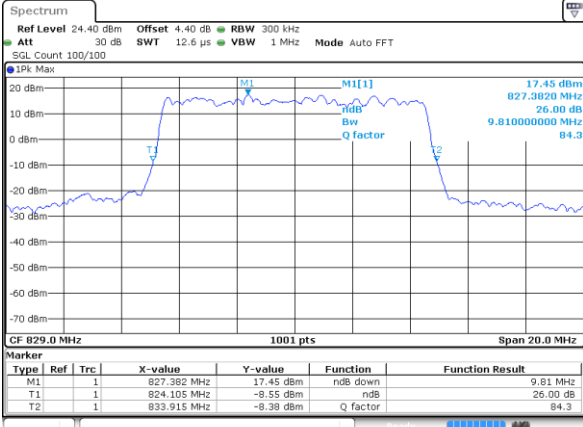

Date: 26 DEC 2017 12:40:14

Lowest Channel / 10MHz / 16QAM

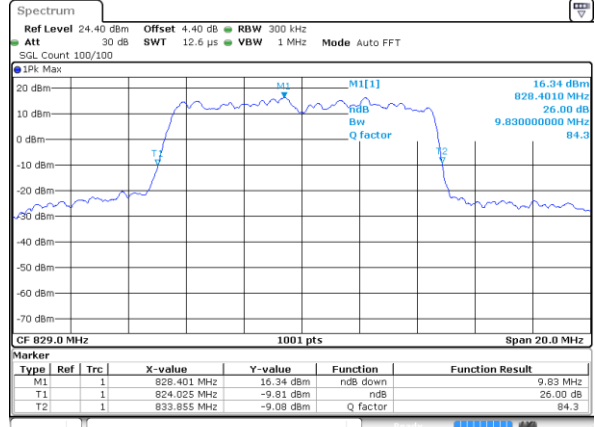

Date: 26 DEC 2017 12:40:36

Middle Channel / 10MHz / QPSK

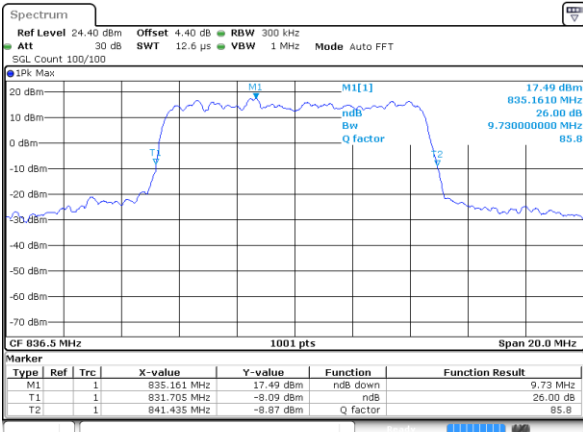

Date: 26 DEC 2017 12:41:21

Middle Channel / 10MHz / 16QAM

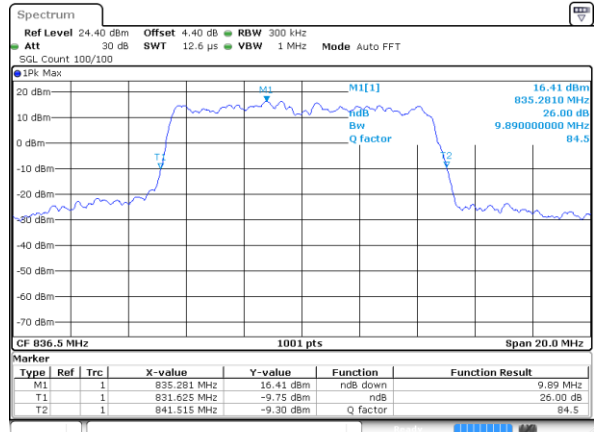

Date: 26 DEC 2017 12:41:00

Highest Channel / 10MHz / QPSK

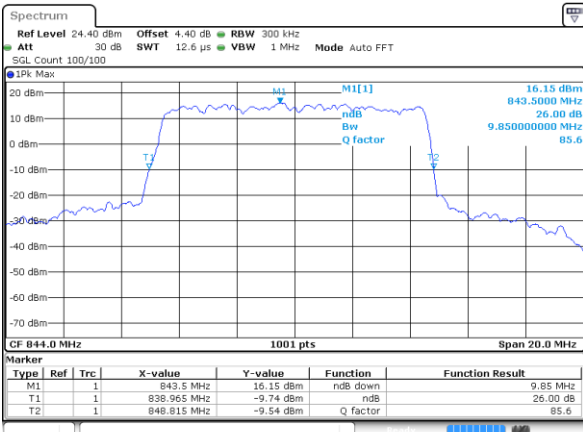

Date: 26 DEC 2017 12:41:46

Highest Channel / 10MHz / 16QAM

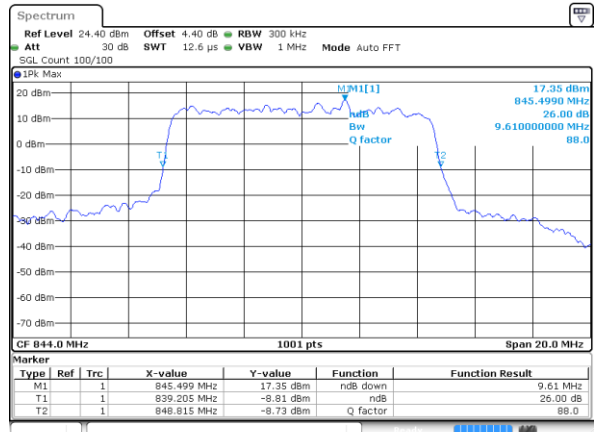

Date: 26 DEC 2017 12:42:11



LTE Band 26

Lowest Channel / 15MHz / QPSK

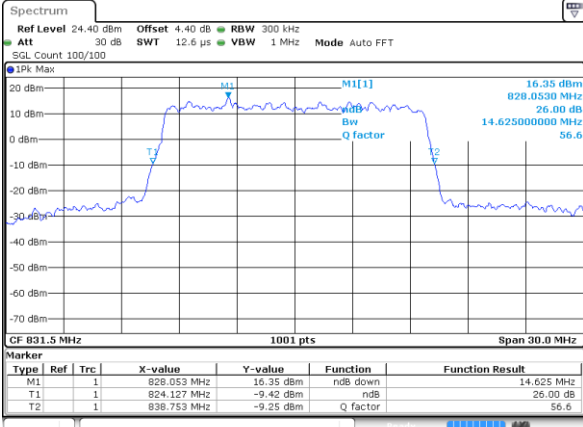

Date: 26 DEC 2017 12:42:40

Lowest Channel / 15MHz / 16QAM

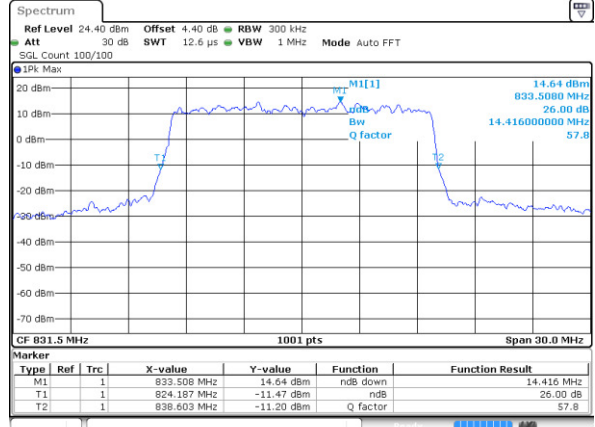

Date: 26 DEC 2017 12:43:02

Middle Channel / 15MHz / QPSK

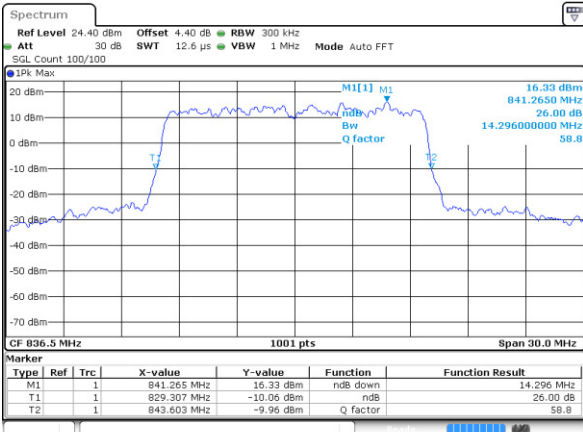

Date: 26 DEC 2017 12:44:02

Middle Channel / 15MHz / 16QAM

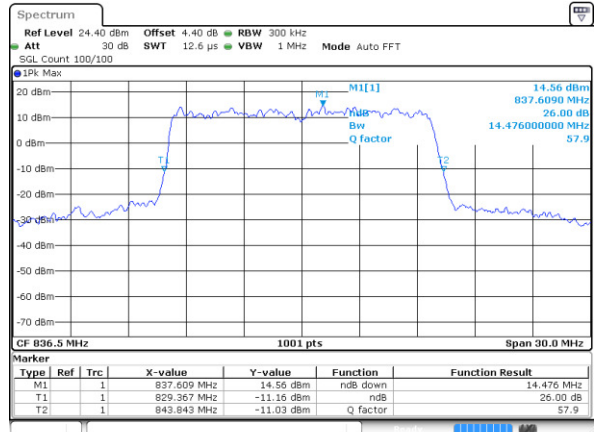

Date: 26 DEC 2017 12:43:37

Highest Channel / 15MHz / QPSK

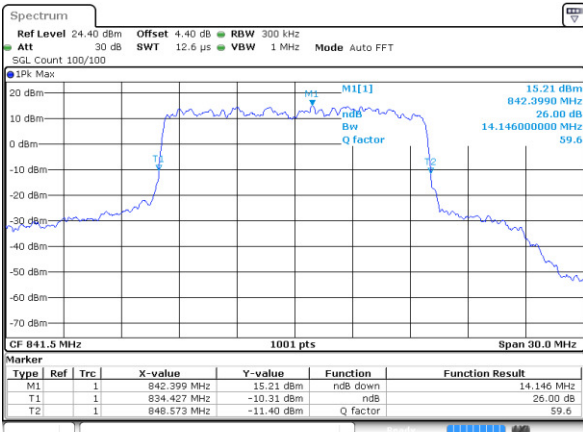

Date: 26 DEC 2017 12:44:29

Highest Channel / 15MHz / 16QAM

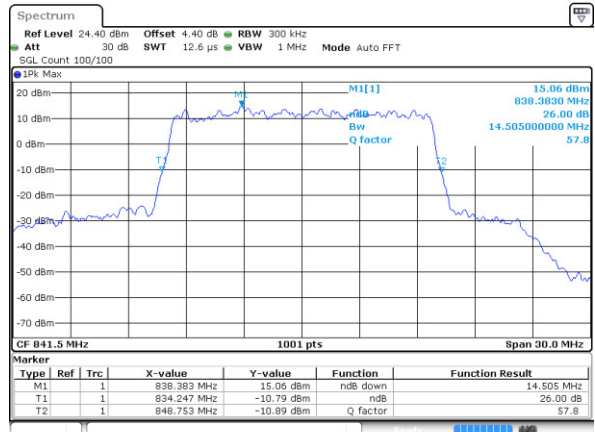

Date: 26 DEC 2017 12:44:49



LTE Band 26

CH26765 / 15MHz / QPSK

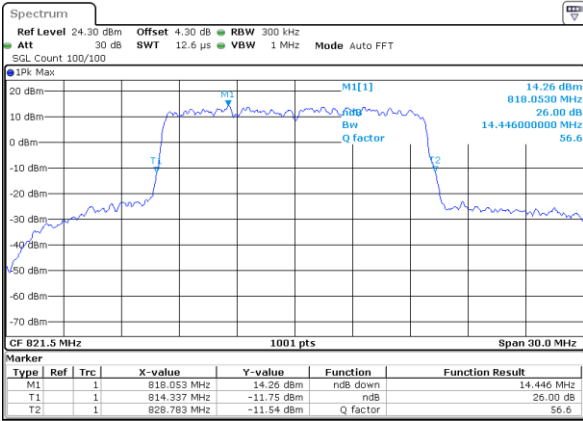

Date: 1 JAN 2018 14:50:22

CH26765 / 15MHz / 16QAM

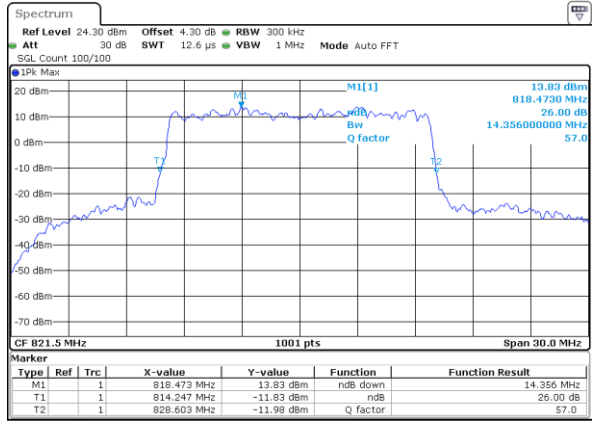

Date: 1 JAN 2018 14:49:55



LTE Band 38

Lowest Channel / 5MHz / QPSK

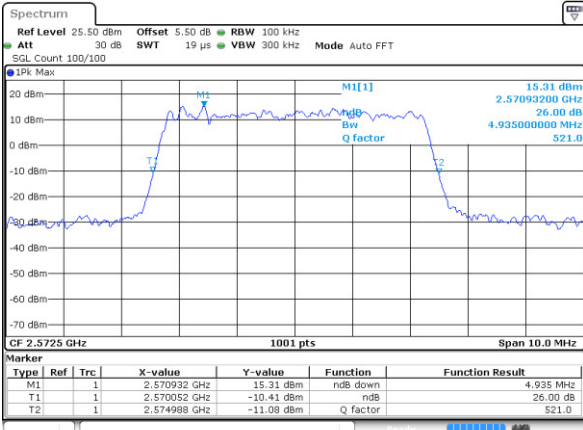

Date: 26 DEC 2017 08:29:29

Lowest Channel / 5MHz / 16QAM

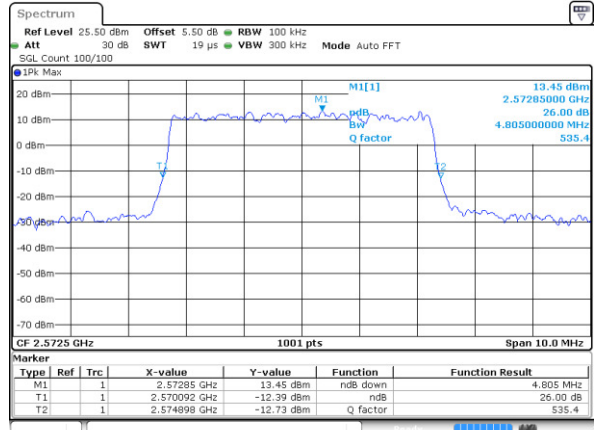

Date: 26 DEC 2017 08:29:50

Middle Channel / 5MHz / QPSK

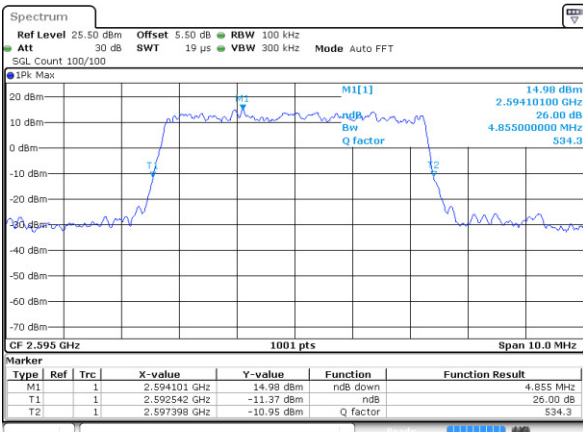

Date: 26 DEC 2017 08:30:28

Middle Channel / 5MHz / 16QAM

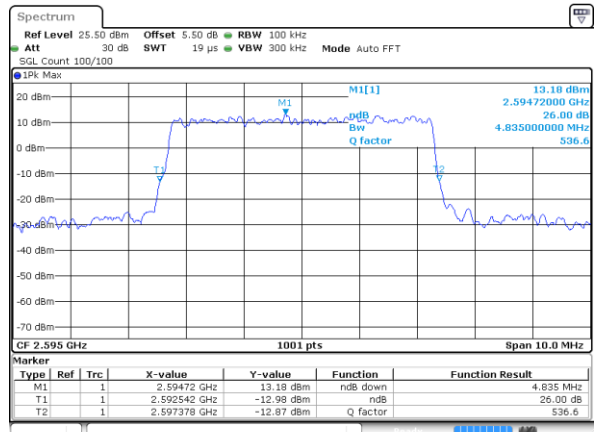

Date: 26 DEC 2017 08:30:09

Highest Channel / 5MHz / QPSK

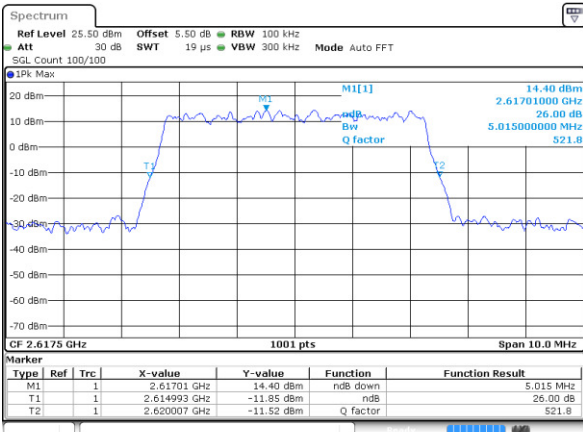

Date: 26 DEC 2017 08:30:50

Highest Channel / 5MHz / 16QAM

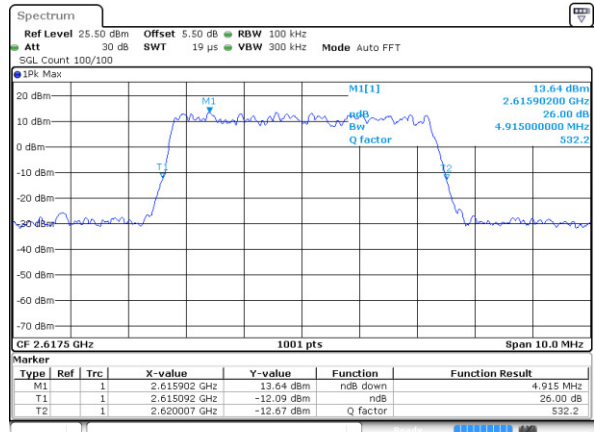

Date: 26 DEC 2017 08:31:26