

FCC SAR Test Report

APPLICANT : Motorola Mobility LLC
EQUIPMENT : Mobile Cellular Phone
BRAND NAME : Motorola
MODEL NAME : XT1920DL
FCC ID : IHDT56XF2
STANDARD : FCC 47 CFR Part 2 (2.1093)
ANSI/IEEE C95.1-1992
IEEE 1528-2013

We, Sporton International (Shenzhen) Inc., would like to declare that the tested sample has been evaluated in accordance with the procedures and had been in compliance with the applicable technical standards.

The test results in this report apply exclusively to the tested model / sample. Without written approval of Sporton International (Shenzhen) Inc., the test report shall not be reproduced except in full.



Approved by: Mark Qu / Manager



Sporton International (Shenzhen) Inc.
1/F, 2/F, Bldg 5, Shiling Industrial Zone, Xinwei Village, Xili, Nanshan Shenzhen City
Guangdong Province 518055 China



Table of Contents

1. Statement of Compliance 4
2. Administration Data 5
3. Guidance Applied..... 5
4. Equipment Under Test (EUT) Information 6
4.1 General Information 6
4.2 Specification of Accessory 7
4.3 General LTE SAR Test and Reporting Considerations 8
5. Proximity Sensor Triggering Test.....10
5.1 Proximity sensor triggering distances(Per KDB616217§6.2)10
5.2 Tilt angle influences to proximity sensor triggering(Per KDB616217 §6.4).....16
6. RF Exposure Limits.....17
6.1 Uncontrolled Environment.....17
6.2 Controlled Environment.....17
7. Specific Absorption Rate (SAR).....18
7.1 Introduction18
7.2 SAR Definition.....18
8. System Description and Setup19
8.1 E-Field Probe20
8.2 Data Acquisition Electronics (DAE)20
8.3 Phantom.....21
8.4 Device Holder.....22
9. Measurement Procedures23
9.1 Spatial Peak SAR Evaluation23
9.2 Power Reference Measurement.....24
9.3 Area Scan24
9.4 Zoom Scan.....25
9.5 Volume Scan Procedures.....25
9.6 Power Drift Monitoring.....25
10. Test Equipment List.....26
11. System Verification27
11.1 Tissue Simulating Liquids27
11.2 Tissue Verification28
11.3 System Performance Check Results29
12. RF Exposure Positions30
12.1 Ear and handset reference point30
12.2 Definition of the cheek position31
12.3 Definition of the tilt position32
12.4 Body Worn Accessory33
12.5 Product Specific 10g SAR Exposure.....34
12.6 Wireless Router.....34
13. Conducted RF Output Power (Unit: dBm).....35
14. Antenna Location85
15. SAR Test Results87
15.1 Head SAR90
15.2 Hotspot SAR93
15.3 Body Worn Accessory SAR.....98
15.4 Product specific 10g SAR101
15.5 Repeated SAR Measurement103
16. Simultaneous Transmission Analysis104
16.1 Head Exposure Conditions105
16.2 Hotspot Exposure Conditions.....107
16.3 Body-Worn Accessory Exposure Conditions109
16.4 Product specific 10g SAR Exposure Conditions.....110
16.5 SPLSR Evaluation and Analysis.....111
17. Uncertainty Assessment119
18. References120
Appendix A. Plots of System Performance Check
Appendix B. Plots of High SAR Measurement
Appendix C. DASy Calibration Certificate
Appendix D. Test Setup Photos



Revision History

REPORT NO.	VERSION	DESCRIPTION	ISSUED DATE
FA832306	Rev. 01	Initial issue of report	May 14, 2018



1. Statement of Compliance

The maximum results of Specific Absorption Rate (SAR) found during testing for **Motorola Mobility LLC, Mobile Cellular Phone, XT1920DL**, are as follows.

Highest 1g SAR Summary						
Equipment Class	Frequency Band		Head (Separation 0mm)	Hotspot (Separation 5mm)	Body-worn (Separation 5mm)	Highest Simultaneous Transmission 1g SAR (W/kg)
			1g SAR (W/kg)			
Licensed	GSM	GSM850	0.26	1.01	1.01	1.58
		GSM1900	0.11	0.98	0.75	
	WCDMA	Band V	0.41	0.95	0.95	
		Band IV	0.20	0.97	0.77	
		Band II	0.22	1.16	0.72	
	CDMA2000	BC0	0.48	0.67	0.74	
		BC1	0.25	1.11	0.73	
	LTE	Band 71	0.24	0.84	0.84	
		Band 5	0.38	0.74	0.74	
		Band 12	0.26	0.70	0.70	
		Band 13	0.36	0.85	0.85	
		Band 66/Band 4	0.16	1.15	0.94	
		Band 2	0.20	1.16	0.97	
DTS	WLAN	2.4GHz WLAN	0.75	0.63	0.63	1.55
NII		5GHz WLAN	0.84	1.05	1.17	1.58
DSS	Bluetooth	2.4GHz Bluetooth		0.10	0.10	1.16
Highest 10g SAR Summary						
Equipment Class	Frequency Band		Product Specific 10g SAR (W/kg) (Separation 0mm)			Highest Simultaneous Transmission 10g SAR (W/kg)
Licensed	GSM	GSM1900	2.78			3.99
	WCDMA	Band IV	2.59			
		Band II	2.86			
	CDMA2000	BC1	3.00			
	LTE	Band 66/Band 4	3.07			
Band 2		2.47				
NII	WLAN	5GHz WLAN	1.69			3.99
Date of Testing:			2018/4/14 ~ 2018/4/26			
Remark: This device supports LTE B4 and B66. Since the supported frequency span for LTE B4 falls completely within the supports frequency span for LTE B66, both LTE bands have the same target power, and both LTE bands share the same transmission path; therefore, SAR was only assessed for LTE B66.						

This device is in compliance with Specific Absorption Rate (SAR) for general population/uncontrolled exposure limits (1.6 W/kg for Partial-Body 1g SAR, 4.0 W/kg for Product Specific 10g SAR) specified in FCC 47 CFR part 2 (2.1093) and ANSI/IEEE C95.1-1992, and had been tested in accordance with the measurement methods and procedures specified in IEEE 1528-2013 and FCC KDB publications.



2. Administration Data

Testing Laboratory	
Test Site	Sporton International (Shenzhen) Inc.
Test Site Location	1/F, 2/F, Bldg 5, Shiling Industrial Zone, Xinwei Village, Xili, Nanshan Shenzhen City Guangdong Province 518055 China TEL: +86-755-8637-9589 FAX: +86-755-8637-9595

Applicant	
Company Name	Motorola Mobility LLC
Address	222 W,Merchandise Mart Plaza, Chicago IL 60654 USA

Manufacturer	
Company Name	Motorola Mobility LLC
Address	222 W,Merchandise Mart Plaza, Chicago IL 60654 USA

3. Guidance Applied

The Specific Absorption Rate (SAR) testing specification, method, and procedure for this device is in accordance with the following standards:

- FCC 47 CFR Part 2 (2.1093)
- ANSI/IEEE C95.1-1992
- IEEE 1528-2013
- FCC KDB 865664 D01 SAR Measurement 100 MHz to 6 GHz v01r04
- FCC KDB 865664 D02 SAR Reporting v01r02
- FCC KDB 447498 D01 General RF Exposure Guidance v06
- FCC KDB 648474 D04 SAR Evaluation Considerations for Wireless Handsets v01r03
- FCC KDB 248227 D01 802.11 Wi-Fi SAR v02r02
- FCC KDB 941225 D01 3G SAR Procedures v03r01
- FCC KDB 941225 D05 SAR for LTE Devices v02r05
- FCC KDB 941225 D06 Hotspot Mode SAR v02r01
- FCC KDB 616217 D04 SAR for laptop and tablets v01r02



4. Equipment Under Test (EUT) Information

4.1 General Information

Product Feature & Specification	
Equipment Name	Mobile Cellular Phone
Brand Name	Motorola
Model Name	XT1920DL
FCC ID	IHDT56XF2
IMEI Code	354132090008437
Wireless Technology and Frequency Range	GSM850: 824.2 MHz ~ 848.8 MHz GSM1900: 1850.2 MHz ~ 1909.8 MHz WCDMA Band II: 1852.4 MHz ~ 1907.6 MHz WCDMA Band IV: 1712.4 MHz ~ 1752.6 MHz WCDMA Band V: 826.4 MHz ~ 846.6 MHz CDMA2000 BC0: 824.7 MHz ~ 848.31 MHz CDMA 2000 BC1: 1851.25 MHz ~ 1908.75 MHz LTE Band 2: 1850.7 MHz ~ 1909.3 MHz LTE Band 4: 1710.7 MHz ~ 1754.3 MHz LTE Band 5: 824.7 MHz ~ 848.3 MHz LTE Band 12: 699.7 MHz ~ 715.3 MHz LTE Band 13: 779.5 MHz ~ 784.5 MHz LTE Band 66: 1710.7 MHz ~ 1779.3 MHz LTE Band 71: 665.5 MHz ~ 695.5MHz WLAN 2.4GHz Band: 2412 MHz ~ 2462 MHz WLAN 5.2GHz Band: 5180 MHz ~ 5240 MHz WLAN 5.3GHz Band: 5260 MHz ~ 5320 MHz WLAN 5.5GHz Band: 5500 MHz ~ 5700 MHz WLAN 5.8GHz Band: 5745 MHz ~ 5825 MHz Bluetooth: 2402 MHz ~ 2480 MHz
Mode	GSM/GPRS/EGPRS RMC/AMR 12.2Kbps HSDPA HSUPA DC-HSDPA HSPA+ (16QAM uplink is not supported) CDMA2000 : 1xRTT/1xEv-Do(Rev.0)/1xEv-Do(Rev.A) LTE: QPSK, 16QAM, 64QAM WLAN 2.4GHz 802.11b/g/n HT20 WLAN 5GHz 802.11a/n HT20/HT40 Bluetooth v3.0+EDR, Bluetooth v4.0 LE, Bluetooth v4.1 LE, Bluetooth v4.2 LE
HW Version	DVT1B
SW Version	OPP28.1
GSM / (E)GPRS Transfer mode	Class B – EUT cannot support Packet Switched and Circuit Switched Network simultaneously but can automatically switch between Packet and Circuit Switched Network.
EUT Stage	Identical Prototype
Remark:	<ol style="list-style-type: none"> WLAN operation in 5600 MHz ~ 5650 MHz is notched. This device supports VoIP in GPRS, EGPRS, CDMA, WCDMA and LTE (e.g. for 3rd-party VoIP), LTE supports VoLTE operation. This device 2.4GHz WLAN support hotspot operation and Bluetooth support tethering applications. This device 2.4GHz WLAN/5.2GHz WLAN/5.8GHz WLAN support hotspot operation, and 5.2GHz WLAN/5.8GHz WLAN supports WiFi Direct (GC/GO), and 5.3GHz / 5.5GHz supports WiFi Direct (GC only). This device does not support DTM operation and supports GRPS/EGPRS mode up to multi-slot class 12. The device employs proximity sensors that detect the presence of the user's body at the front or back faces of the device. When front or back body worn condition is detected, GSM1900, WCDMA band II/IV/V, CDMA2000 BC0/BC1, LTE band 2/4/5/66 and WLAN 5.5/5.8GHz reduced power will be active. (P-sensor can't work at detecting presence of the user's body at the four edges of the device.) When hotspot mode is enabled, power reduction will be activated to limit the maximum power of GSM1900, WCDMA band II/IV/V, CDMA2000 BC0/BC1, LTE band 2/4/5/66 and WLAN 5.8GHz.

8. For WWAN bands, this device hotspot reduced power and P-sensor reduced power level are the same. So only show one reduced power level for hotspot reduced power and P-sensor reduced power for this application.
9. The device additionally employs proximity sensors that detect the presence of tissue near the currently active transmit antenna, the handheld reduced power table which at WCDMA band II/IV, CDMA2000 BC1, LTE band 2/4/66 reduced powers will be active.
10. When the phone is in talking mode and receiver worked, then power reduction will be implemented immediately at WLAN2.4GHz.

4.2 Specification of Accessory

Specification of Accessory				
AC Adapter 1	Brand Name	Motorola (Acbel)	Model Name	C-P35 SPN5945A
	Power Rating	I/P: 100-240 Vac, 300mA, O/P: 5.2Vdc,2000mA		
AC Adapter 2	Brand Name	Motorola (Salom)	Model Name	SSW-2919UMTJ C-P35 SPN5945A
	Power Rating	I/P: 100-240 Vac, 300mA, O/P: 5.2Vdc,2000mA		
Battery	Brand Name	Motorola (SCUD)	Model Name	BL270
	Power Rating	3.85Vdc,4000mAh	Type	Li-ion, ATL426580
USB Cable	Brand Name	Motorola (Saibao)	Model Name	SLQ-A077A
	Signal Line Type	1.0 meter, shielded cable, without ferrite core		



4.3 General LTE SAR Test and Reporting Considerations

Summarized necessary items addressed in KDB 941225 D05 v02r05																																																															
FCC ID	IHDT56XF2																																																														
Equipment Name	Mobile Cellular Phone																																																														
Operating Frequency Range of each LTE transmission band	LTE Band 2: 1850.7 MHz ~ 1909.3 MHz LTE Band 4: 1710.7 MHz ~ 1754.3 MHz LTE Band 5: 824.7 MHz ~ 848.3 MHz LTE Band 12: 699.7 MHz ~ 715.3 MHz LTE Band 13: 779.5 MHz ~ 784.5 MHz LTE Band 66: 1710.7 MHz ~ 1779.3 MHz LTE Band 71: 665.5 MHz ~ 695.5MHz																																																														
Channel Bandwidth	LTE Band 2: 1.4MHz, 3MHz, 5MHz, 10MHz, 15MHz, 20MHz LTE Band 4: 1.4MHz, 3MHz, 5MHz, 10MHz, 15MHz, 20MHz LTE Band 5: 1.4MHz, 3MHz, 5MHz, 10MHz LTE Band 12: 1.4MHz, 3MHz, 5MHz, 10MHz LTE Band 13: 5MHz, 10MHz LTE Band 66: 1.4MHz, 3MHz, 5MHz, 10MHz, 15MHz, 20MHz LTE Band 71 :5MHz, 10MHz, 5MHz, 20MHz																																																														
uplink modulations used	QPSK, 16QAM and 64QAM																																																														
LTE Voice / Data requirements	Voice and Data																																																														
LTE Release Version	R10, Cat4																																																														
CA support	NO																																																														
LTE MPR permanently built-in by design	<p>Table 6.2.3-1: Maximum Power Reduction (MPR) for Power Class 1, 2 and 3</p> <table border="1"> <thead> <tr> <th rowspan="2">Modulation</th> <th colspan="6">Channel bandwidth / Transmission bandwidth (N_{RB})</th> <th rowspan="2">MPR (dB)</th> </tr> <tr> <th>1.4 MHz</th> <th>3.0 MHz</th> <th>5 MHz</th> <th>10 MHz</th> <th>15 MHz</th> <th>20 MHz</th> </tr> </thead> <tbody> <tr> <td>QPSK</td> <td>> 5</td> <td>> 4</td> <td>> 8</td> <td>> 12</td> <td>> 16</td> <td>> 18</td> <td>≤ 1</td> </tr> <tr> <td>16 QAM</td> <td>≤ 5</td> <td>≤ 4</td> <td>≤ 8</td> <td>≤ 12</td> <td>≤ 16</td> <td>≤ 18</td> <td>≤ 1</td> </tr> <tr> <td>16 QAM</td> <td>> 5</td> <td>> 4</td> <td>> 8</td> <td>> 12</td> <td>> 16</td> <td>> 18</td> <td>≤ 2</td> </tr> <tr> <td>64 QAM</td> <td>≤ 5</td> <td>≤ 4</td> <td>≤ 8</td> <td>≤ 12</td> <td>≤ 16</td> <td>≤ 18</td> <td>≤ 2</td> </tr> <tr> <td>64 QAM</td> <td>> 5</td> <td>> 4</td> <td>> 8</td> <td>> 12</td> <td>> 16</td> <td>> 18</td> <td>≤ 3</td> </tr> <tr> <td>256 QAM</td> <td colspan="6" style="text-align: center;">≥ 1</td> <td>≤ 5</td> </tr> </tbody> </table>	Modulation	Channel bandwidth / Transmission bandwidth (N _{RB})						MPR (dB)	1.4 MHz	3.0 MHz	5 MHz	10 MHz	15 MHz	20 MHz	QPSK	> 5	> 4	> 8	> 12	> 16	> 18	≤ 1	16 QAM	≤ 5	≤ 4	≤ 8	≤ 12	≤ 16	≤ 18	≤ 1	16 QAM	> 5	> 4	> 8	> 12	> 16	> 18	≤ 2	64 QAM	≤ 5	≤ 4	≤ 8	≤ 12	≤ 16	≤ 18	≤ 2	64 QAM	> 5	> 4	> 8	> 12	> 16	> 18	≤ 3	256 QAM	≥ 1						≤ 5
Modulation	Channel bandwidth / Transmission bandwidth (N _{RB})						MPR (dB)																																																								
	1.4 MHz	3.0 MHz	5 MHz	10 MHz	15 MHz	20 MHz																																																									
QPSK	> 5	> 4	> 8	> 12	> 16	> 18	≤ 1																																																								
16 QAM	≤ 5	≤ 4	≤ 8	≤ 12	≤ 16	≤ 18	≤ 1																																																								
16 QAM	> 5	> 4	> 8	> 12	> 16	> 18	≤ 2																																																								
64 QAM	≤ 5	≤ 4	≤ 8	≤ 12	≤ 16	≤ 18	≤ 2																																																								
64 QAM	> 5	> 4	> 8	> 12	> 16	> 18	≤ 3																																																								
256 QAM	≥ 1						≤ 5																																																								
LTE A-MPR	In the base station simulator configuration, Network Setting value is set to NS_01 to disable A-MPR during SAR testing and the LTE SAR tests was transmitting on all TTI frames (Maximum TTI)																																																														
Spectrum plots for RB configuration	A properly configured base station simulator was used for the SAR and power measurement; therefore, spectrum plots for each RB allocation and offset configuration are not included in the SAR report.																																																														
Power reduction applied to satisfy SAR compliance	Yes 1. The device employs proximity sensors that detect the presence of the user's body at the front or back faces of the device. When front or back body worn condition is detected, LTE band 2/4/5/66 reduced power will be active. (P-sensor can't work at detecting presence of the user's body at the four edges of the device.) 2. When hotspot mode is enabled, power reduction will be activated to limit the maximum power of LTE band 2/4/5/66. 3. The device additionally employs proximity sensors that detect the presence of tissue near the currently active transmit antenna, the handheld reduced power table which at LTE band 2/4/66 reduced powers will be active.																																																														



Transmission (H, M, L) channel numbers and frequencies in each LTE band												
LTE Band 2												
	Bandwidth 1.4 MHz		Bandwidth 3 MHz		Bandwidth 5 MHz		Bandwidth 10 MHz		Bandwidth 15 MHz		Bandwidth 20 MHz	
	Ch. #	Freq. (MHz)	Ch. #	Freq. (MHz)	Ch. #	Freq. (MHz)	Ch. #	Freq. (MHz)	Ch. #	Freq. (MHz)	Ch. #	Freq. (MHz)
L	18607	1850.7	18615	1851.5	18625	1852.5	18650	1855	18675	1857.5	18700	1860
M	18900	1880	18900	1880	18900	1880	18900	1880	18900	1880	18900	1880
H	19193	1909.3	19185	1908.5	19175	1907.5	19150	1905	19125	1902.5	19100	1900
LTE Band 4												
	Bandwidth 1.4 MHz		Bandwidth 3 MHz		Bandwidth 5 MHz		Bandwidth 10 MHz		Bandwidth 15 MHz		Bandwidth 20 MHz	
	Ch. #	Freq. (MHz)	Ch. #	Freq. (MHz)	Ch. #	Freq. (MHz)	Ch. #	Freq. (MHz)	Ch. #	Freq. (MHz)	Ch. #	Freq. (MHz)
L	19957	1710.7	19965	1711.5	19975	1712.5	20000	1715	20025	1717.5	20050	1720
M	20175	1732.5	20175	1732.5	20175	1732.5	20175	1732.5	20175	1732.5	20175	1732.5
H	20393	1754.3	20385	1753.5	20375	1752.5	20350	1750	20325	1747.5	20300	1745
LTE Band 5												
	Bandwidth 1.4 MHz		Bandwidth 3 MHz		Bandwidth 5 MHz		Bandwidth 10 MHz					
	Ch. #	Freq. (MHz)	Ch. #	Freq. (MHz)	Ch. #	Freq. (MHz)	Ch. #	Freq. (MHz)	Ch. #	Freq. (MHz)	Ch. #	Freq. (MHz)
L	20407	824.7	20415	825.5	20425	826.5	20450	829				
M	20525	836.5	20525	836.5	20525	836.5	20525	836.5				
H	20643	848.3	20635	847.5	20625	846.5	20600	844				
LTE Band 12												
	Bandwidth 1.4 MHz		Bandwidth 3 MHz		Bandwidth 5 MHz		Bandwidth 10 MHz					
	Ch. #	Freq. (MHz)	Ch. #	Freq. (MHz)	Ch. #	Freq. (MHz)	Ch. #	Freq. (MHz)	Ch. #	Freq. (MHz)	Ch. #	Freq. (MHz)
L	23017	699.7	23025	700.5	23035	701.5	23060	704				
M	23095	707.5	23095	707.5	23095	707.5	23095	707.5				
H	23173	715.3	23165	714.5	23155	713.5	23130	711				
LTE Band 13												
	Bandwidth 5 MHz				Bandwidth 10 MHz							
	Channel #		Freq.(MHz)		Channel #		Freq.(MHz)		Channel #		Freq.(MHz)	
L	23205		779.5		23230		782					
M	23230		782									
H	23255		784.5									
LTE Band 66												
	Bandwidth 1.4 MHz		Bandwidth 3 MHz		Bandwidth 5 MHz		Bandwidth 10 MHz		Bandwidth 15 MHz		Bandwidth 20 MHz	
	Ch. #	Freq. (MHz)	Ch. #	Freq. (MHz)	Ch. #	Freq. (MHz)	Ch. #	Freq. (MHz)	Ch. #	Freq. (MHz)	Ch. #	Freq. (MHz)
L	131979	1710.7	131987	1711.5	131997	1712.5	132022	1715	132047	1717.5	132072	1720
M	132322	1745	132322	1745	132322	1745	132322	1745	132322	1745	132322	1745
H	132665	1779.3	132657	1778.5	132647	1777.5	132622	1775	132597	1772.5	132572	1770
LTE Band 71												
	Bandwidth 5 MHz		Bandwidth 10 MHz		Bandwidth 15 MHz		Bandwidth 20 MHz					
	Ch. #	Freq. (MHz)	Ch. #	Freq. (MHz)	Ch. #	Freq. (MHz)	Ch. #	Freq. (MHz)	Ch. #	Freq. (MHz)	Ch. #	Freq. (MHz)
L	133147	665.5	133172	668	133197	670.5	133222	673				
M	133247	675.5	133272	678	133297	680.5	133322	683				
H	133447	695.5	133422	693	133397	690.5	133372	688				

5. Proximity Sensor Triggering Test

5.1 Proximity sensor triggering distances(Per KDB616217§6.2)

1. Proximity sensor triggering distance testing was performed according to the procedures outlined in KDB 616217 D04 section 6.2, and EUT moving further away from the flat phantom and EUT moving toward the flat phantom were both assessed and the tissue-equivalent medium for highest frequency (5850MHz) and lowest (850MHz) frequency was used for proximity sensor triggering testing.
2. Capacitive proximity sensors placed coincident with antenna elements at the top and bottom ends of the phone are utilized to determine when the device comes in proximity of the user's body at the front or back of the device.
3. The output power will reduce to body worn power level when top and bottom sensor pad be detected, the output power will reduce to handheld power level when bottom sensor pad only be detected.
4. The sensors used to detect the proximity of the user's body (Body-worn condition) at the front or back surface of the device use a detection threshold distance. The data shown in the sections below shows the distance(s). When the sensor is active, GSM1900, WCDMA band II/IV/V, CDMA2000 BC0/BC1, LTE band 2/4/5/6/6 and WLAN 5.5/5.8GHZ reduced power will be active.
5. The device additionally employs proximity sensors that detect the presence of tissue near the currently active transmit antenna (if that antenna may require reduced power relative the Default power table in order to meet extremity SAR limits). The control logic is such that, if the Body-Worn, At-Head or WiFi Hotspot conditions are not detected, but tissue (as a finger or hand, for example) is detected near the transmitting antenna, the handheld reduced power table which at WCDMA band II/IV, CDMA2000 BC1, LTE band 2/4/66 will be applied.

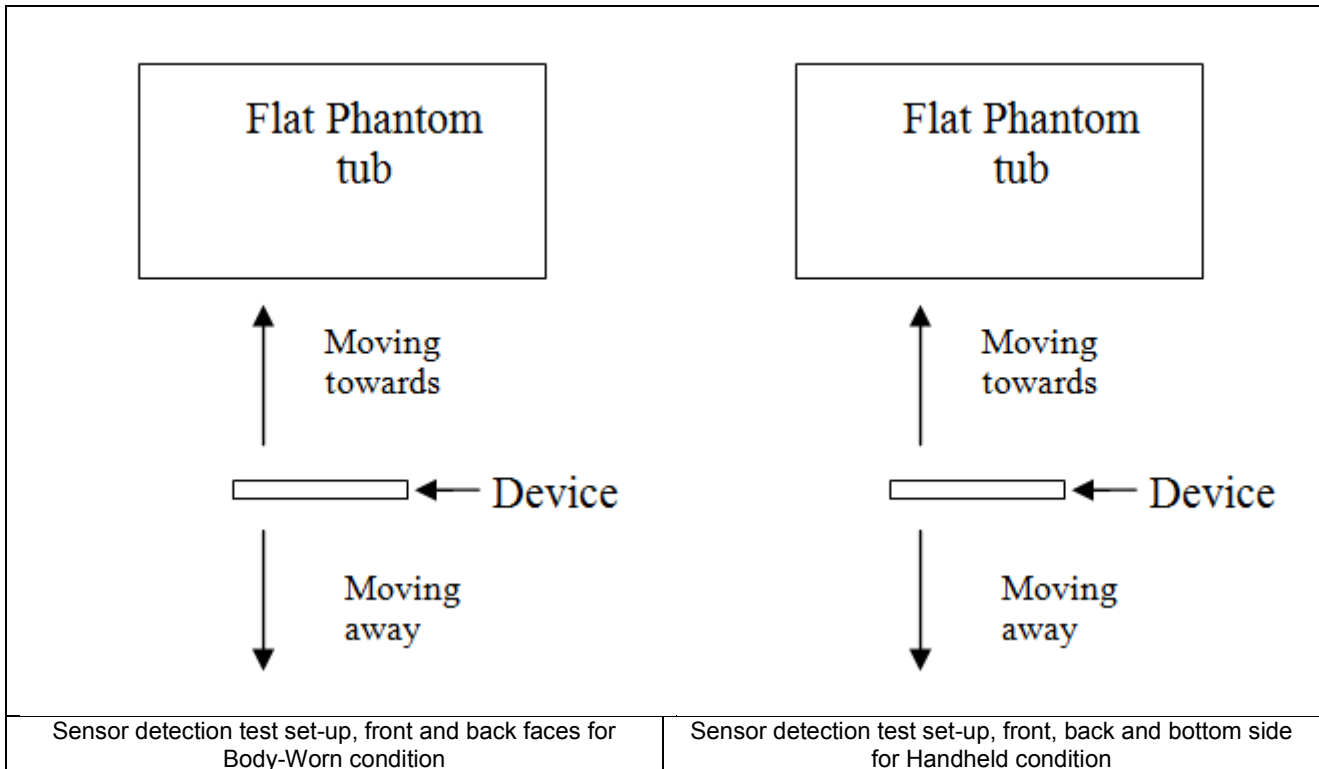

Proximity Sensor Triggering Distance (mm)										
Condition	Body-worn				Handheld					
Position	Front		Back		Front		Back		Bottom Side	
	Moving towards	Moving away	Moving towards	Moving away	Moving towards	Moving away	Moving towards	Moving away	Moving towards	Moving away
Minimum	16	16	16	16	17	18	17	19	18	21

<Sensor Trigger Distance and Measured Power>

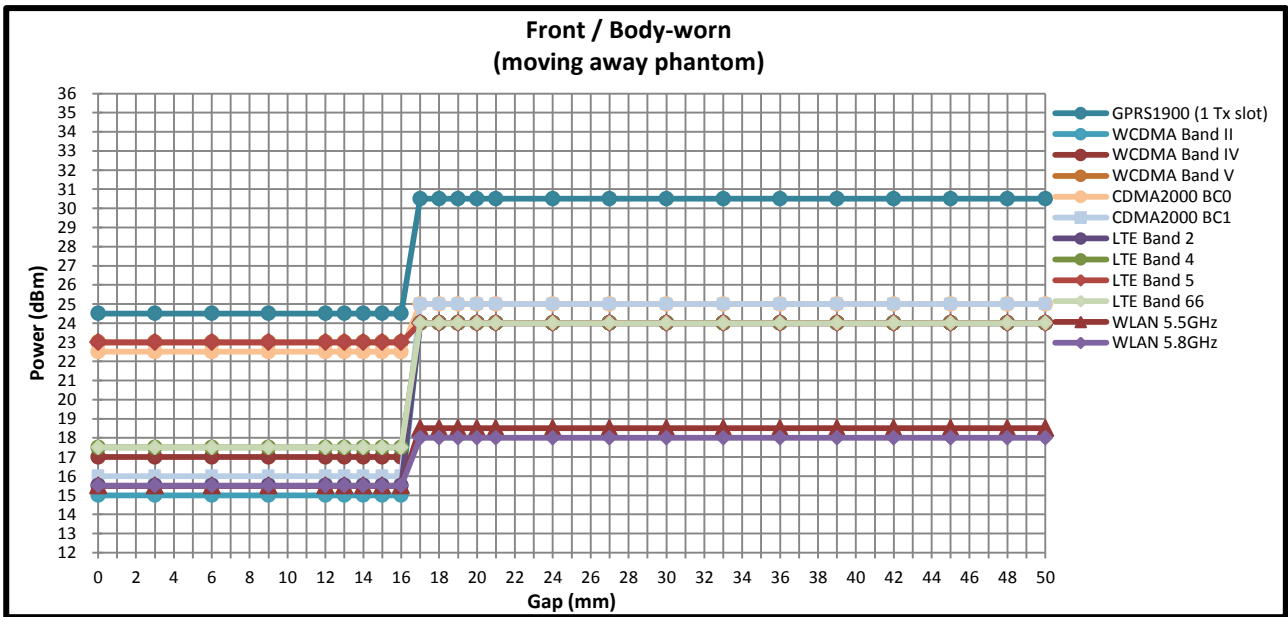
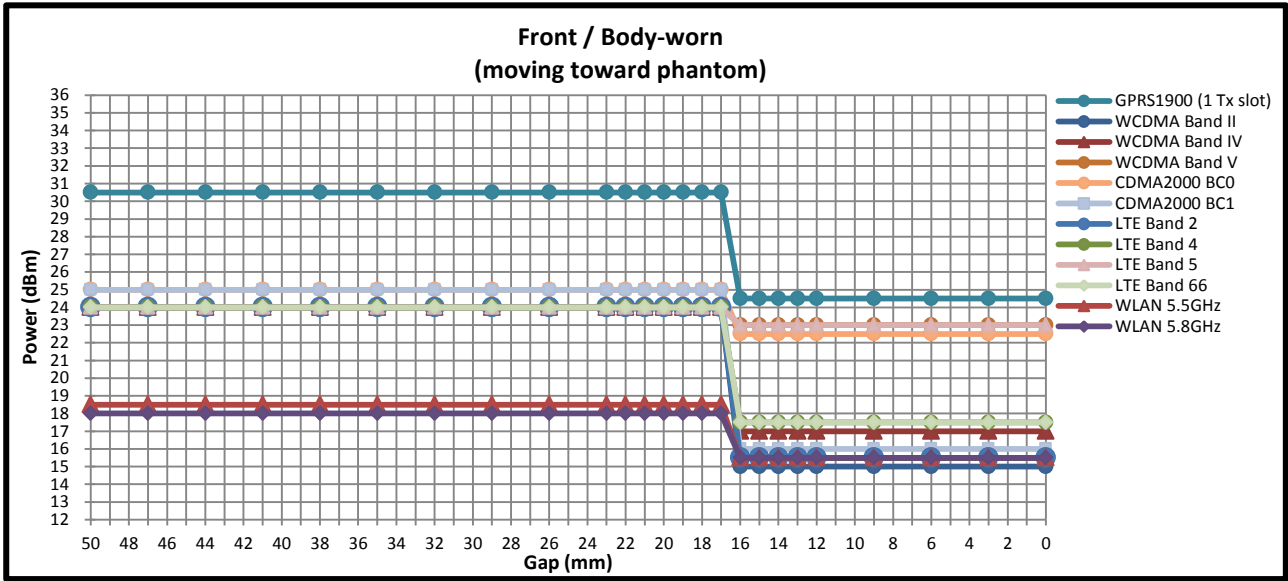

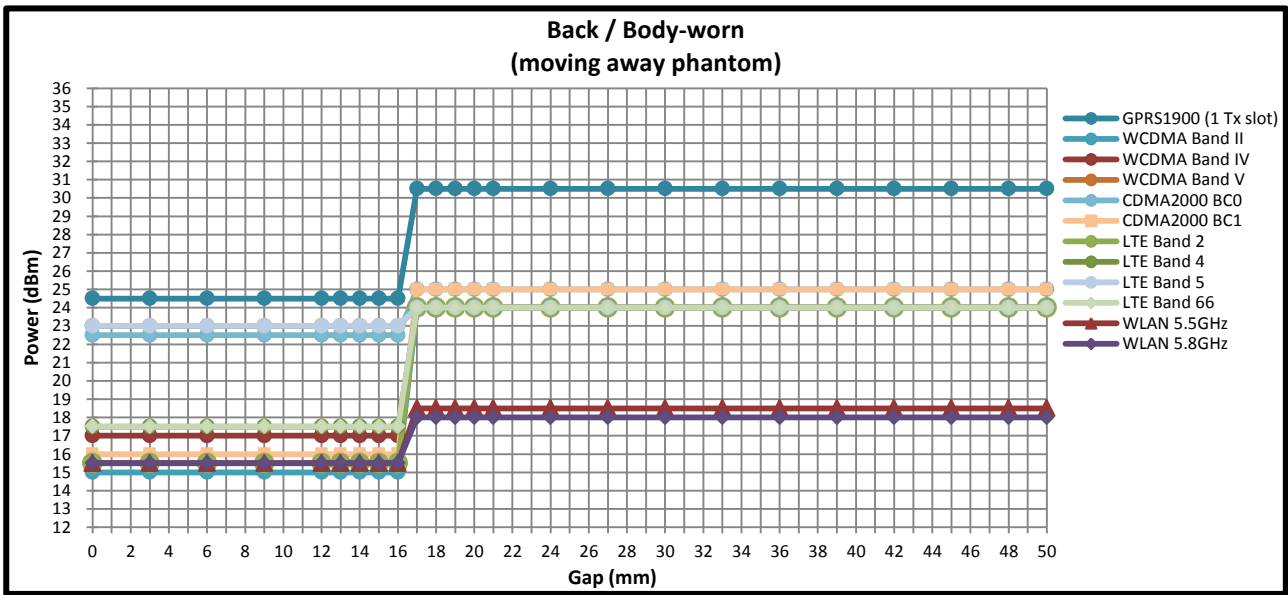
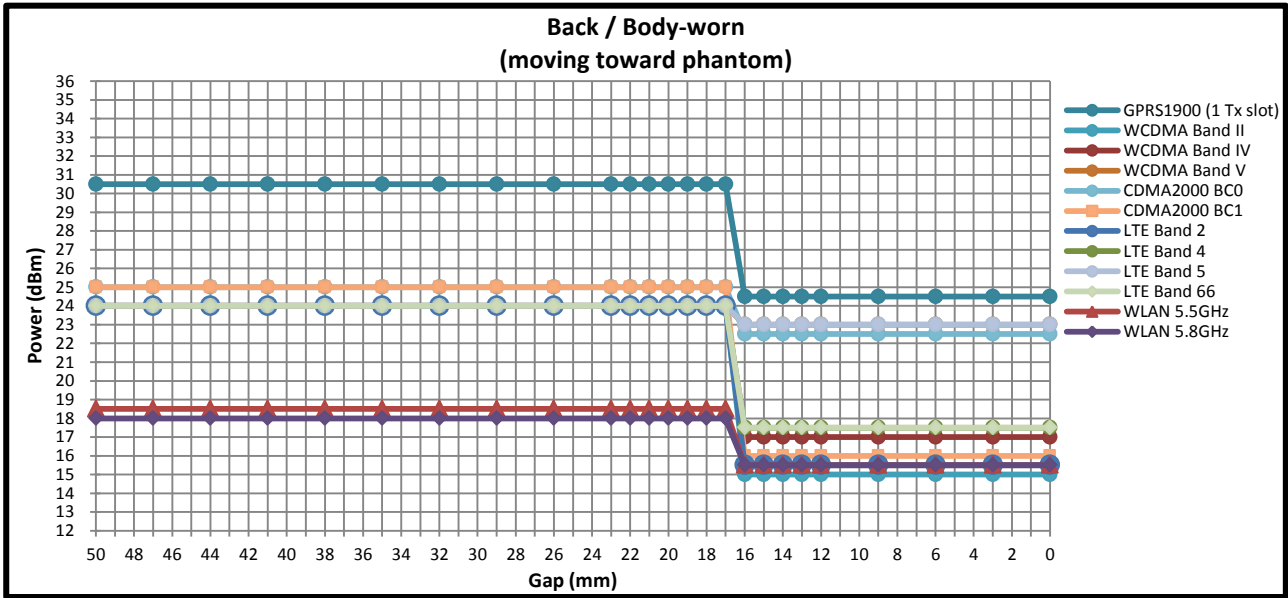

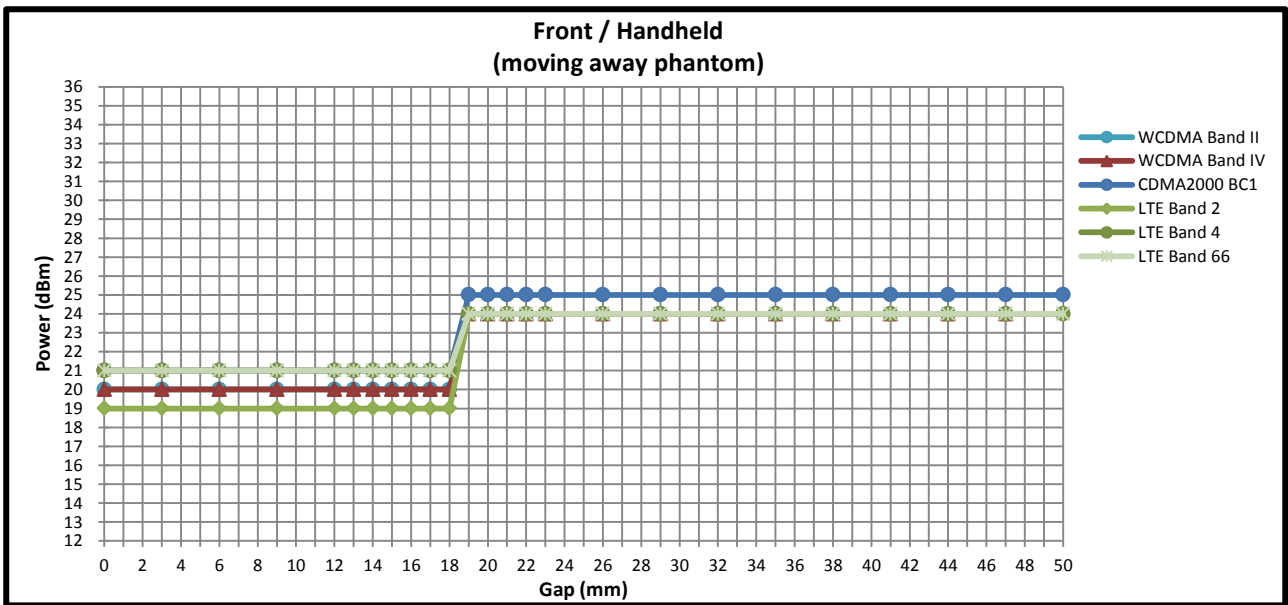
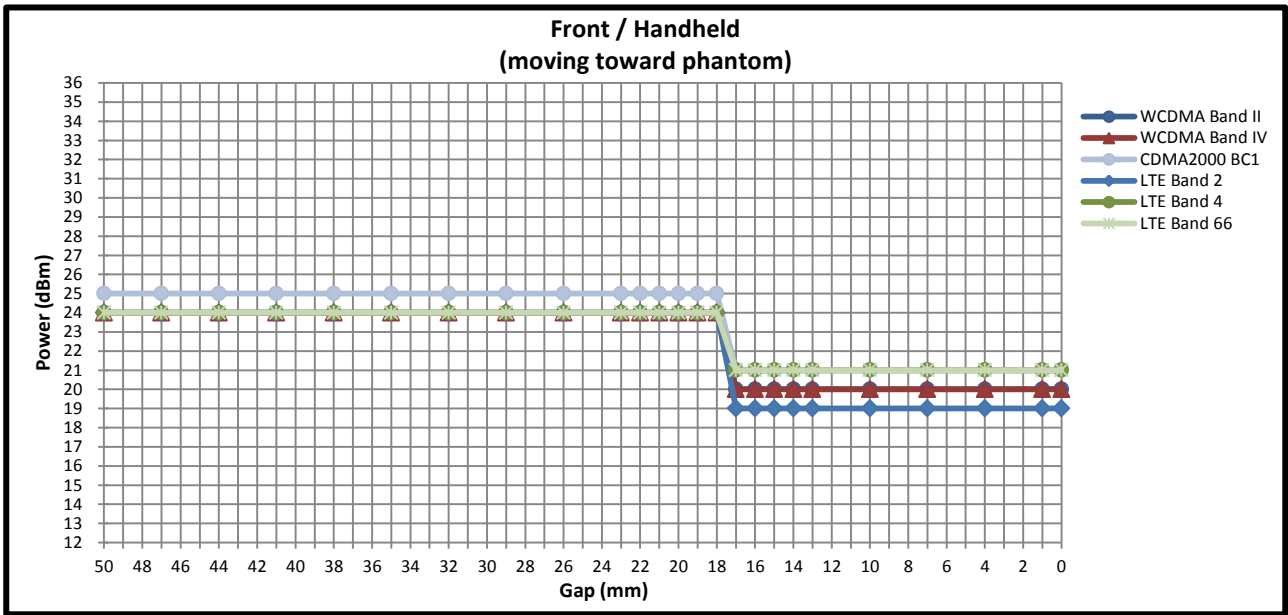

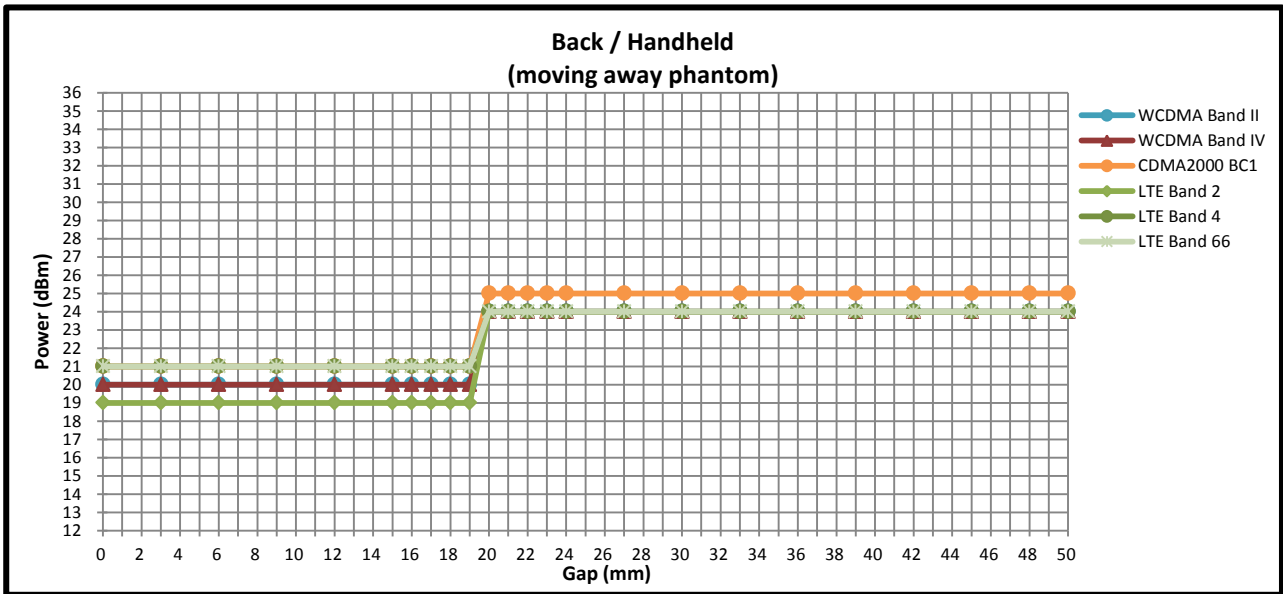
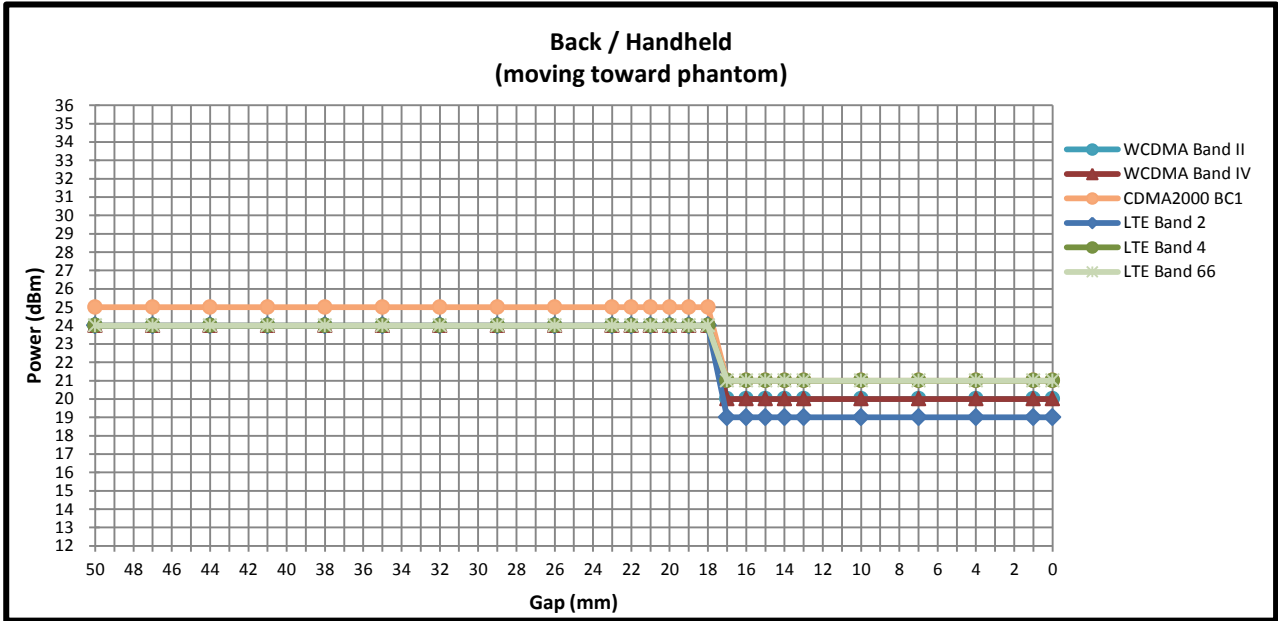

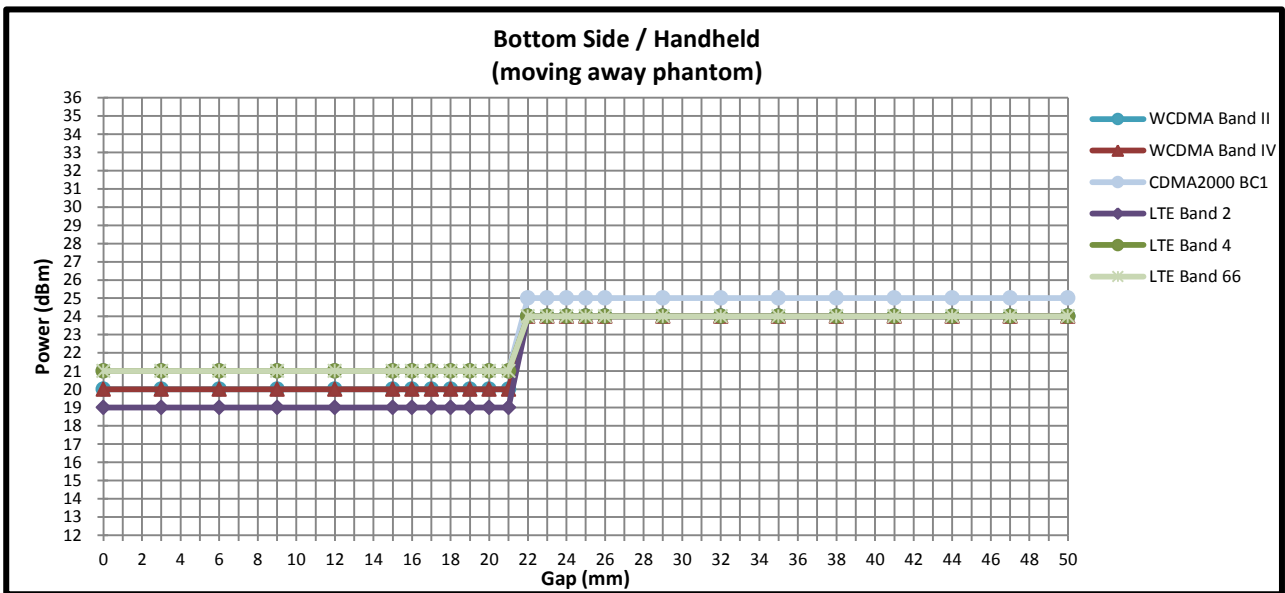
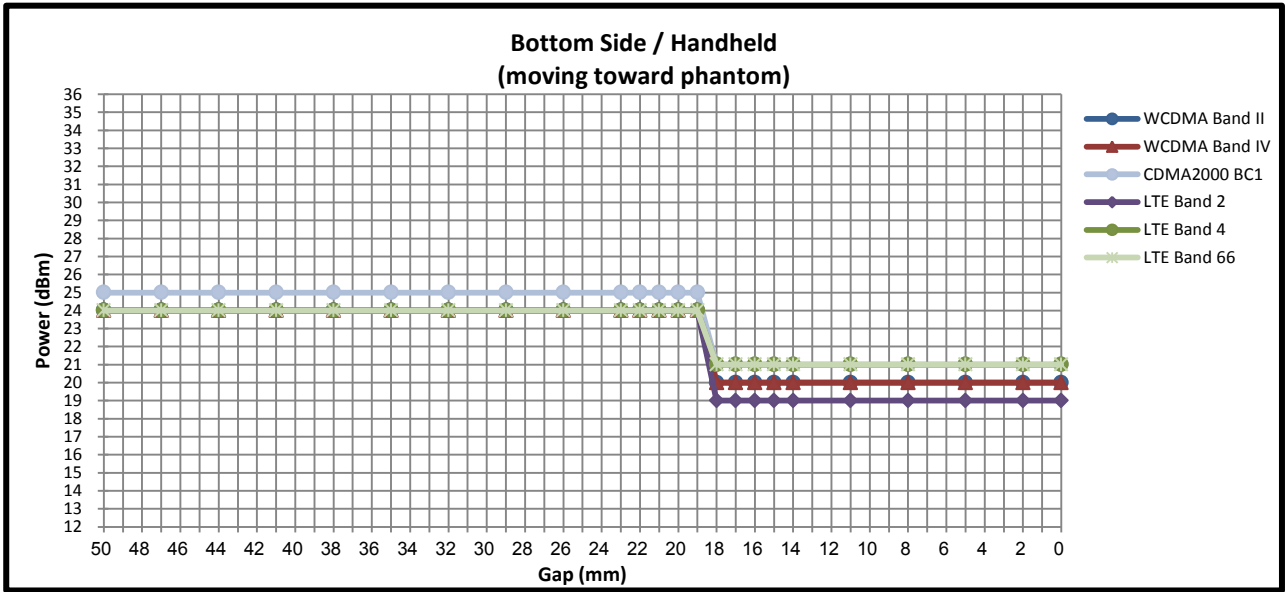

5.2 Tilt angle influences to proximity sensor triggering(Per KDB616217 §6.4)

The DUT was positioned directly below the flat phantom at the minimum measured trigger distance with bottom side parallel to the base of the flat phantom for each band.
 The EUT was rotated about bottom side for angles up to +/- 45°. If the output power increased during the rotation the DUT was moved 1mm toward the phantom and the rotation repeated. This procedure was repeated until the power remained reduced for all angles up to +/- 45°.

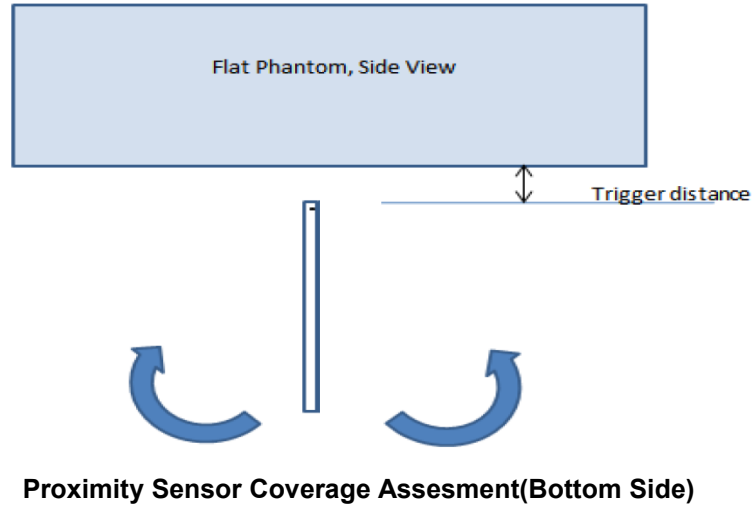

Table: Summary of Tablet Tilt Angle Influence to Proximity Sensor Triggering (Bottom Side)

Main ant Band(MHz)	Minimum trigger distance at which power reduction was maintained over ±45°	Power Reduction Status											
		-45°	-35°	-25°	-15°	-5°	0°	5°	15°	25°	35°	45°	
WCDMA Band II	18mm	on	on	on	on	on	on	on	on	on	on	on	on
WCDMA Band IV	18mm	on	on	on	on	on	on	on	on	on	on	on	on
CDMA2000 BC1	18mm	on	on	on	on	on	on	on	on	on	on	on	on
LTE Band 2	18mm	on	on	on	on	on	on	on	on	on	on	on	on
LTE Band 4	18mm	on	on	on	on	on	on	on	on	on	on	on	on
LTE Band 66	18mm	on	on	on	on	on	on	on	on	on	on	on	on

Conclusion: As is shown from the validation data, it can be ensured that the proximity sensor can be valid triggered for the DUT tilt coverage exposure condition.

6. RF Exposure Limits

6.1 Uncontrolled Environment

Uncontrolled Environments are defined as locations where there is the exposure of individuals who have no knowledge or control of their exposure. The general population/uncontrolled exposure limits are applicable to situations in which the general public may be exposed or in which persons who are exposed as a consequence of their employment may not be made fully aware of the potential for exposure or cannot exercise control over their exposure. Members of the general public would come under this category when exposure is not employment-related; for example, in the case of a wireless transmitter that exposes persons in its vicinity.

6.2 Controlled Environment

Controlled Environments are defined as locations where there is exposure that may be incurred by persons who are aware of the potential for exposure, (i.e. as a result of employment or occupation). In general, occupational/controlled exposure limits are applicable to situations in which persons are exposed as a consequence of their employment, who have been made fully aware of the potential for exposure and can exercise control over their exposure. The exposure category is also applicable when the exposure is of a transient nature due to incidental passage through a location where the exposure levels may be higher than the general population/uncontrolled limits, but the exposed person is fully aware of the potential for exposure and can exercise control over his or her exposure by leaving the area or by some other appropriate means.

Limits for Occupational/Controlled Exposure (W/kg)

Whole-Body	Partial-Body	Hands, Wrists, Feet and Ankles
0.4	8.0	20.0

Limits for General Population/Uncontrolled Exposure (W/kg)

Whole-Body	Partial-Body	Hands, Wrists, Feet and Ankles
0.08	1.6	4.0

Whole-Body SAR is averaged over the entire body, partial-body SAR is averaged over any 1gram of tissue defined as a tissue volume in the shape of a cube. SAR for hands, wrists, feet and ankles is averaged over any 10 grams of tissue defined as a tissue volume in the shape of a cube.

7. Specific Absorption Rate (SAR)

7.1 Introduction

SAR is related to the rate at which energy is absorbed per unit mass in an object exposed to a radio field. The SAR distribution in a biological body is complicated and is usually carried out by experimental techniques or numerical modeling. The standard recommends limits for two tiers of groups, occupational/controlled and general population/uncontrolled, based on a person's awareness and ability to exercise control over his or her exposure. In general, occupational/controlled exposure limits are higher than the limits for general population/uncontrolled.

7.2 SAR Definition

The SAR definition is the time derivative (rate) of the incremental energy (dW) absorbed by (dissipated in) an incremental mass (dm) contained in a volume element (dv) of a given density (ρ). The equation description is as below:

$$SAR = \frac{d}{dt} \left(\frac{dW}{dm} \right) = \frac{d}{dt} \left(\frac{dW}{\rho dv} \right)$$

SAR is expressed in units of Watts per kilogram (W/kg)

$$SAR = \frac{\sigma |E|^2}{\rho}$$

Where: σ is the conductivity of the tissue, ρ is the mass density of the tissue and E is the RMS electrical field strength.

8. System Description and Setup

The DASY system used for performing compliance tests consists of the following items:

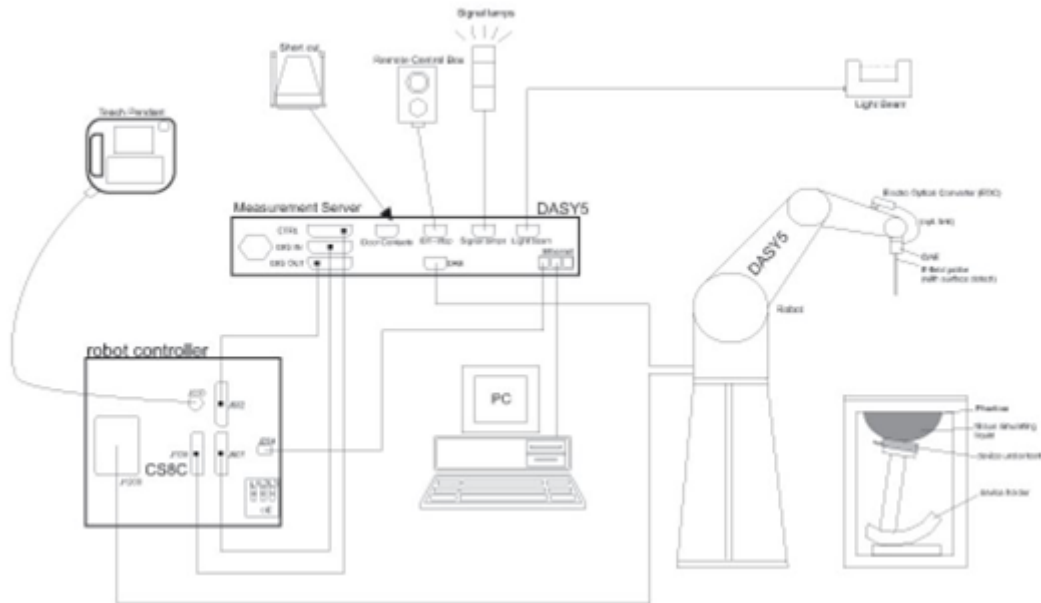

- A standard high precision 6-axis robot with controller, teach pendant and software. An arm extension for accommodating the data acquisition electronics (DAE).
- An isotropic Field probe optimized and calibrated for the targeted measurement.
- A data acquisition electronics (DAE) which performs the signal amplification, signal multiplexing, AD-conversion, offset measurements, mechanical surface detection, collision detection, etc. The unit is battery powered with standard or rechargeable batteries. The signal is optically transmitted to the EOC.
- The Electro-optical converter (EOC) performs the conversion from optical to electrical signals for the digital communication to the DAE. To use optical surface detection, a special version of the EOC is required. The EOC signal is transmitted to the measurement server.
- The function of the measurement server is to perform the time critical tasks such as signal filtering, control of the robot operation and fast movement interrupts.
- The Light Beam used is for probe alignment. This improves the (absolute) accuracy of the probe positioning.
- A computer running WinXP or Win7 and the DASY5 software.
- Remote control and teach pendant as well as additional circuitry for robot safety such as warning lamps, etc.
- The phantom, the device holder and other accessories according to the targeted measurement.

8.1 E-Field Probe

The SAR measurement is conducted with the dosimetric probe (manufactured by SPEAG). The probe is specially designed and calibrated for use in liquid with high permittivity. The dosimetric probe has special calibration in liquid at different frequency. This probe has a built in optical surface detection system to prevent from collision with phantom.

<EX3DV4 Probe>

Construction	Symmetric design with triangular core Built-in shielding against static charges PEEK enclosure material (resistant to organic solvents, e.g., DGBE)	
Frequency	10 MHz – >6 GHz Linearity: ±0.2 dB (30 MHz – 6 GHz)	
Directivity	±0.3 dB in TSL (rotation around probe axis) ±0.5 dB in TSL (rotation normal to probe axis)	
Dynamic Range	10 µW/g – >100 mW/g Linearity: ±0.2 dB (noise: typically <1 µW/g)	
Dimensions	Overall length: 337 mm (tip: 20 mm) Tip diameter: 2.5 mm (body: 12 mm) Typical distance from probe tip to dipole centers: 1 mm	

8.2 Data Acquisition Electronics (DAE)

The data acquisition electronics (DAE) consists of a highly sensitive electrometer-grade preamplifier with auto-zeroing, a channel and gain-switching multiplexer, a fast 16 bit AD-converter and a command decoder and control logic unit. Transmission to the measurement server is accomplished through an optical downlink for data and status information as well as an optical uplink for commands and the clock.

The input impedance of the DAE is 200 MOhm; the inputs are symmetrical and floating. Common mode rejection is above 80 dB.



Photo of DAE

8.3 Phantom

<SAM Twin Phantom>

Shell Thickness	2 ± 0.2 mm; Center ear point: 6 ± 0.2 mm
Filling Volume	Approx. 25 liters
Dimensions	Length: 1000 mm; Width: 500 mm; Height: adjustable feet
Measurement Areas	Left Hand, Right Hand, Flat Phantom



The bottom plate contains three pair of bolts for locking the device holder. The device holder positions are adjusted to the standard measurement positions in the three sections. A white cover is provided to tap the phantom during off-periods to prevent water evaporation and changes in the liquid parameters. On the phantom top, three reference markers are provided to identify the phantom position with respect to the robot.

<ELI Phantom>

Shell Thickness	2 ± 0.2 mm (sagging: <1%)
Filling Volume	Approx. 30 liters
Dimensions	Major ellipse axis: 600 mm Minor axis: 400 mm

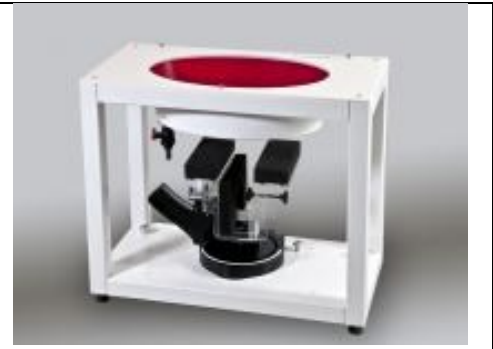

The ELI phantom is intended for compliance testing of handheld and body-mounted wireless devices in the frequency range of 30 MHz to 6 GHz. ELI4 is fully compatible with standard and all known tissue simulating liquids.

8.4 Device Holder

<Mounting Device for Hand-Held Transmitter>

In combination with the Twin SAM V5.0/V5.0c or ELI phantoms, the Mounting Device for Hand-Held Transmitters enables rotation of the mounted transmitter device to specified spherical coordinates. At the heads, the rotation axis is at the ear opening. Transmitter devices can be easily and accurately positioned according to IEC 62209-1, IEEE 1528, FCC, or other specifications. The device holder can be locked for positioning at different phantom sections (left head, right head, flat). And upgrade kit to Mounting Device to enable easy mounting of wider devices like big smart-phones, e-books, small tablets, etc. It holds devices with width up to 140 mm.



Mounting Device for Hand-Held Transmitters



Mounting Device Adaptor for Wide-Phones

<Mounting Device for Laptops and other Body-Worn Transmitters>

The extension is lightweight and made of POM, acrylic glass and foam. It fits easily on the upper part of the mounting device in place of the phone positioned. The extension is fully compatible with the SAM Twin and ELI phantoms.



Mounting Device for Laptops

9. Measurement Procedures

The measurement procedures are as follows:

<Conducted power measurement>

- (a) For WWAN power measurement, use base station simulator to configure EUT WWAN transmission in conducted connection with RF cable, at maximum power in each supported wireless interface and frequency band.
- (b) Read the WWAN RF power level from the base station simulator.
- (c) For WLAN/BT power measurement, use engineering software to configure EUT WLAN/BT continuously transmission, at maximum RF power in each supported wireless interface and frequency band
- (d) Connect EUT RF port through RF cable to the power meter, and measure WLAN/BT output power

<SAR measurement>

- (a) Use base station simulator to configure EUT WWAN transmission in radiated connection, and engineering software to configure EUT WLAN/BT continuously transmission, at maximum RF power, in the highest power channel.
- (b) Place the EUT in the positions as Appendix D demonstrates.
- (c) Set scan area, grid size and other setting on the DASY software.
- (d) Measure SAR results for the highest power channel on each testing position.
- (e) Find out the largest SAR result on these testing positions of each band
- (f) Measure SAR results for other channels in worst SAR testing position if the reported SAR of highest power channel is larger than 0.8 W/kg

According to the test standard, the recommended procedure for assessing the peak spatial-average SAR value consists of the following steps:

- (a) Power reference measurement
- (b) Area scan
- (c) Zoom scan
- (d) Power drift measurement

9.1 Spatial Peak SAR Evaluation

The procedure for spatial peak SAR evaluation has been implemented according to the test standard. It can be conducted for 1g and 10g, as well as for user-specific masses. The DASY software includes all numerical procedures necessary to evaluate the spatial peak SAR value.

The base for the evaluation is a "cube" measurement. The measured volume must include the 1g and 10g cubes with the highest averaged SAR values. For that purpose, the center of the measured volume is aligned to the interpolated peak SAR value of a previously performed area scan.

The entire evaluation of the spatial peak values is performed within the post-processing engine (SEMCAD). The system always gives the maximum values for the 1g and 10g cubes. The algorithm to find the cube with highest averaged SAR is divided into the following stages:

- (a) Extraction of the measured data (grid and values) from the Zoom Scan
- (b) Calculation of the SAR value at every measurement point based on all stored data (A/D values and measurement parameters)
- (c) Generation of a high-resolution mesh within the measured volume
- (d) Interpolation of all measured values from the measurement grid to the high-resolution grid
- (e) Extrapolation of the entire 3-D field distribution to the phantom surface over the distance from sensor to surface
- (f) Calculation of the averaged SAR within masses of 1g and 10g

9.2 Power Reference Measurement

The Power Reference Measurement and Power Drift Measurements are for monitoring the power drift of the device under test in the batch process. The minimum distance of probe sensors to surface determines the closest measurement point to phantom surface. This distance cannot be smaller than the distance of sensor calibration points to probe tip as defined in the probe properties.

9.3 Area Scan

The area scan is used as a fast scan in two dimensions to find the area of high field values, before doing a fine measurement around the hot spot. The sophisticated interpolation routines implemented in DASY software can find the maximum found in the scanned area, within a range of the global maximum. The range (in dB0 is specified in the standards for compliance testing. For example, a 2 dB range is required in IEEE standard 1528 and IEC 62209 standards, whereby 3 dB is a requirement when compliance is assessed in accordance with the ARIB standard (Japan), if only one zoom scan follows the area scan, then only the absolute maximum will be taken as reference. For cases where multiple maximums are detected, the number of zoom scans has to be increased accordingly.

Area scan parameters extracted from FCC KDB 865664 D01v01r04 SAR measurement 100 MHz to 6 GHz.

	≤ 3 GHz	> 3 GHz
Maximum distance from closest measurement point (geometric center of probe sensors) to phantom surface	5 ± 1 mm	$\frac{1}{2} \cdot \delta \cdot \ln(2) \pm 0.5$ mm
Maximum probe angle from probe axis to phantom surface normal at the measurement location	30° ± 1°	20° ± 1°
Maximum area scan spatial resolution: $\Delta x_{Area}, \Delta y_{Area}$	≤ 2 GHz: ≤ 15 mm 2 – 3 GHz: ≤ 12 mm	3 – 4 GHz: ≤ 12 mm 4 – 6 GHz: ≤ 10 mm
	When the x or y dimension of the test device, in the measurement plane orientation, is smaller than the above, the measurement resolution must be ≤ the corresponding x or y dimension of the test device with at least one measurement point on the test device.	

9.4 Zoom Scan

Zoom scans are used assess the peak spatial SAR values within a cubic averaging volume containing 1 gram and 10 gram of simulated tissue. The zoom scan measures points (refer to table below) within a cube shoes base faces are centered on the maxima found in a preceding area scan job within the same procedure. When the measurement is done, the zoom scan evaluates the averaged SAR for 1 gram and 10 gram and displays these values next to the job's label.

Zoom scan parameters extracted from FCC KDB 865664 D01v01r04 SAR measurement 100 MHz to 6 GHz.

		≤ 3 GHz	> 3 GHz	
Maximum zoom scan spatial resolution: $\Delta x_{Zoom}, \Delta y_{Zoom}$		≤ 2 GHz: ≤ 8 mm 2 – 3 GHz: ≤ 5 mm*	3 – 4 GHz: ≤ 5 mm* 4 – 6 GHz: ≤ 4 mm*	
Maximum zoom scan spatial resolution, normal to phantom surface	uniform grid: $\Delta z_{Zoom}(n)$	≤ 5 mm	3 – 4 GHz: ≤ 4 mm 4 – 5 GHz: ≤ 3 mm 5 – 6 GHz: ≤ 2 mm	
	graded grid	$\Delta z_{Zoom}(1)$: between 1 st two points closest to phantom surface	≤ 4 mm	3 – 4 GHz: ≤ 3 mm 4 – 5 GHz: ≤ 2.5 mm 5 – 6 GHz: ≤ 2 mm
		$\Delta z_{Zoom}(n>1)$: between subsequent points	$\leq 1.5 \cdot \Delta z_{Zoom}(n-1)$	
Minimum zoom scan volume	x, y, z	≥ 30 mm	3 – 4 GHz: ≥ 28 mm 4 – 5 GHz: ≥ 25 mm 5 – 6 GHz: ≥ 22 mm	
Note: δ is the penetration depth of a plane-wave at normal incidence to the tissue medium; see draft standard IEEE P1528-2011 for details. * When zoom scan is required and the <i>reported</i> SAR from the <i>area scan based 1-g SAR estimation</i> procedures of KDB 447498 is ≤ 1.4 W/kg, ≤ 8 mm, ≤ 7 mm and ≤ 5 mm zoom scan resolution may be applied, respectively, for 2 GHz to 3 GHz, 3 GHz to 4 GHz and 4 GHz to 6 GHz.				

9.5 Volume Scan Procedures

The volume scan is used for assess overlapping SAR distributions for antennas transmitting in different frequency bands. It is equivalent to an oversized zoom scan used in standalone measurements. The measurement volume will be used to enclose all the simultaneous transmitting antennas. For antennas transmitting simultaneously in different frequency bands, the volume scan is measured separately in each frequency band. In order to sum correctly to compute the 1g aggregate SAR, the EUT remain in the same test position for all measurements and all volume scan use the same spatial resolution and grid spacing. When all volume scan were completed, the software, SEMCAD postprocessor can combine and subsequently superpose these measurement data to calculating the multiband SAR.

9.6 Power Drift Monitoring

All SAR testing is under the EUT install full charged battery and transmit maximum output power. In DASY measurement software, the power reference measurement and power drift measurement procedures are used for monitoring the power drift of EUT during SAR test. Both these procedures measure the field at a specified reference position before and after the SAR testing. The software will calculate the field difference in dB. If the power drifts more than 5%, the SAR will be retested.



10. Test Equipment List

Manufacturer	Name of Equipment	Type/Model	Serial Number	Calibration	
				Last Cal.	Due Date
SPEAG	750MHz System Validation Kit	D750V3	1099	Dec. 04, 2017	Dec. 03, 2018
SPEAG	835MHz System Validation Kit	D835V2	4d162	Dec. 05, 2017	Dec. 04, 2018
SPEAG	1750MHz System Validation Kit	D1750V2	1137	Jun. 05, 2017	Jun. 04, 2018
SPEAG	1900MHz System Validation Kit	D1900V2	5d182	Dec. 06, 2017	Dec. 05, 2018
SPEAG	2450MHz System Validation Kit	D2450V2	924	Mar. 22, 2018	Mar. 21, 2019
SPEAG	5000MHz System Validation Kit	D5GHzV2	1167	Jul. 26, 2017	Jul. 25, 2018
SPEAG	Data Acquisition Electronics	DAE4	1303	Dec. 19, 2017	Dec. 18, 2018
SPEAG	Data Acquisition Electronics	DAE4	1386	Jul. 20, 2017	Jul. 19, 2018
SPEAG	Dosimetric E-Field Probe	EX3DV4	3911	Nov. 28, 2017	Nov. 27, 2018
SPEAG	Dosimetric E-Field Probe	EX3DV4	3958	Jan. 11, 2018	Jan. 10, 2019
SPEAG	SAM Twin Phantom	QD 000 P40 CD	TP-1671	NCR	NCR
SPEAG	SAM Twin Phantom	QD 000 P40 CD	TP-1795	NCR	NCR
SPEAG	Phone Positioner	N/A	N/A	NCR	NCR
Anritsu	Radio communication analyzer	MT8820C	6201300653	Jul. 19, 2017	Jul. 18, 2018
Agilent	Wireless Communication Test Set	E5515C	MY50267224	Sep. 12, 2017	Sep. 11, 2018
Agilent	Network Analyzer	E5071C	MY46523671	Oct. 18, 2017	Oct. 17, 2018
Speag	Dielectric Assessment KIT	DAK-3.5	1071	Nov. 28, 2017	Nov. 27, 2018
Agilent	Signal Generator	N5181A	MY50145381	Dec. 26, 2017	Dec. 25, 2018
Anritsu	Power Sensor	MA2411B	1306099	Aug. 21, 2017	Aug. 20, 2018
Anritsu	Power Meter	ML2495A	1349001	Jul. 19, 2017	Jul. 18, 2018
Anritsu	Power Meter	ML2495A	1218006	Oct. 06, 2017	Oct. 05, 2018
Anritsu	Power Sensor	MA2411B	1207363	Oct. 06, 2017	Oct. 05, 2018
R&S	CBT BLUETOOTH TESTER	CBT	100963	Dec. 26, 2017	Dec. 25, 2018
R&S	Spectrum Analyzer	FSP7	100818	Jul. 19, 2017	Jul. 18, 2018
LKM electronic	Hygrometer	DTM3000	3241	Jul. 21, 2017	Jul. 20, 2018
Anymetre	Thermo-Hygrometer	JR593	2015030903	Jan. 01, 2018	Dec. 31, 2018
ARRA	Power Divider	A3200-2	N/A		Note
PASTERNAK	Dual Directional Coupler	PE2214-10	N/A		Note
Agilent	Dual Directional Coupler	778D	50422		Note
MCL	Attenuation1	BW-S10W5	N/A		Note
Weinschel	Attenuation2	3M-20	N/A		Note
Zhongjilianhe	Attenuation3	MVE2214-03	N/A		Note
mini-circuits	Amplifier	ZHL-42W+	QA1341002		Note
mini-circuits	Amplifier	ZVE-3W-83+	599201528		Note

Note: Prior to system verification and validation, the path loss from the signal generator to the system check source and the power meter, which includes the amplifier, cable, attenuator and directional coupler, was measured by the network analyzer. The reading of the power meter was offset by the path loss difference between the path to the power meter and the path to the system check source to monitor the actual power level fed to the system check source.

11. System Verification

11.1 Tissue Simulating Liquids

For the measurement of the field distribution inside the SAM phantom with DASY, the phantom must be filled with around 25 liters of homogeneous body tissue simulating liquid. For head SAR testing, the liquid height from the ear reference point (ERP) of the phantom to the liquid top surface is larger than 15 cm, which is shown in Fig. 10.1. For body SAR testing, the liquid height from the center of the flat phantom to the liquid top surface is larger than 15 cm, which is shown in Fig. 10.2.

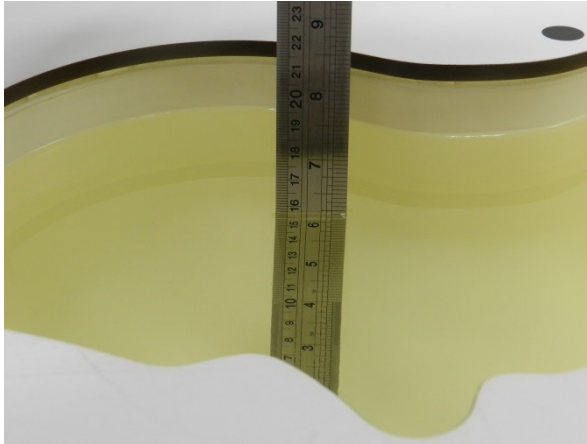

Fig 11.1 Photo of Liquid Height for Head SAR

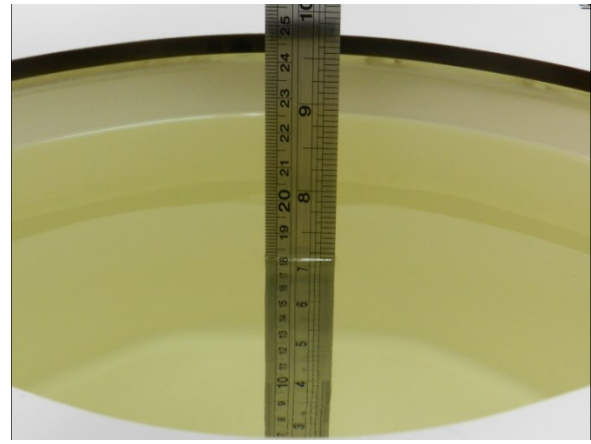

Fig 11.2 Photo of Liquid Height for Body SAR

11.2 Tissue Verification

The following tissue formulations are provided for reference only as some of the parameters have not been thoroughly verified. The composition of ingredients may be modified accordingly to achieve the desired target tissue parameters required for routine SAR evaluation.

Frequency (MHz)	Water (%)	Sugar (%)	Cellulose (%)	Salt (%)	Preventol (%)	DGBE (%)	Conductivity (σ)	Permittivity (ϵ_r)
For Head								
750	41.1	57.0	0.2	1.4	0.2	0	0.89	41.9
835	40.3	57.9	0.2	1.4	0.2	0	0.90	41.5
1800, 1900, 2000	55.2	0	0	0.3	0	44.5	1.40	40.0
2450	55.0	0	0	0	0	45.0	1.80	39.2
For Body								
750	51.7	47.2	0	0.9	0.1	0	0.96	55.5
835	50.8	48.2	0	0.9	0.1	0	0.97	55.2
1800, 1900, 2000	70.2	0	0	0.4	0	29.4	1.52	53.3
2450	68.6	0	0	0	0	31.4	1.95	52.7

Simulating Liquid for 5GHz, Manufactured by SPEAG

Ingredients	(% by weight)
Water	64~78%
Mineral oil	11~18%
Emulsifiers	9~15%
Additives and Salt	2~3%

<Tissue Dielectric Parameter Check Results>

Frequency (MHz)	Tissue Type	Liquid Temp. (°C)	Conductivity (σ)	Permittivity (ϵ_r)	Conductivity Target (σ)	Permittivity Target (ϵ_r)	Delta (σ) (%)	Delta (ϵ_r) (%)	Limit (%)	Date
750	Head	22.5	0.879	40.711	0.89	41.90	-1.24	-2.84	±5	2018/4/14
835	Head	22.8	0.929	41.793	0.90	41.50	3.22	0.71	±5	2018/4/14
1750	Head	22.4	1.382	41.560	1.37	40.10	0.88	3.64	±5	2018/4/16
1900	Head	22.6	1.455	40.068	1.40	40.00	3.93	0.17	±5	2018/4/16
2450	Head	22.5	1.834	39.654	1.80	39.20	1.89	1.16	±5	2018/4/25
5250	Head	22.6	4.713	36.255	4.71	35.90	0.06	0.99	±5	2018/4/25
5600	Head	22.7	5.139	35.632	5.07	35.50	1.36	0.37	±5	2018/4/25
5750	Head	22.8	5.313	35.352	5.22	35.40	1.78	-0.14	±5	2018/4/25
750	Body	22.8	0.970	54.642	0.96	55.50	1.04	-1.55	±5	2018/4/18
835	Body	22.9	1.000	54.086	0.97	55.20	3.09	-2.02	±5	2018/4/17
835	Body	22.5	0.998	54.379	0.97	55.20	2.89	-1.49	±5	2018/4/24
1750	Body	22.7	1.527	51.995	1.49	53.40	2.48	-2.63	±5	2018/4/26
1750	Body	22.9	1.527	51.995	1.49	53.40	2.48	-2.63	±5	2018/4/26
1900	Body	22.9	1.512	53.903	1.52	53.30	-0.53	1.13	±5	2018/4/26
1900	Body	22.8	1.547	53.803	1.52	53.30	1.78	0.94	±5	2018/4/26
2450	Body	22.5	1.991	52.320	1.95	52.70	2.10	-0.72	±5	2018/4/25
5250	Body	22.6	5.307	50.980	5.36	48.90	-0.99	4.25	±5	2018/4/25
5600	Body	22.7	5.904	50.345	5.77	48.50	2.32	3.80	±5	2018/4/25
5750	Body	22.8	6.135	49.988	5.94	48.30	3.28	3.49	±5	2018/4/25

11.3 System Performance Check Results

Comparing to the original SAR value provided by SPEAG, the verification data should be within its specification of 10 %. Below table shows the target SAR and measured SAR after normalized to 1W input power. The table below indicates the system performance check can meet the variation criterion and the plots can be referred to Appendix A of this report.

<1g SAR>

Date	Frequency (MHz)	Tissue Type	Input Power (mW)	Dipole S/N	Probe S/N	DAE S/N	Measured 1g SAR (W/kg)	Targeted 1g SAR (W/kg)	Normalized 1g SAR (W/kg)	Deviation (%)
2018/4/14	750	Head	250	1099	3958	1303	2.00	8.33	8.00	-3.96
2018/4/14	835	Head	250	4d162	3958	1303	2.44	9.56	9.76	2.09
2018/4/16	1750	Head	250	1137	3958	1303	8.71	36.60	34.84	-4.81
2018/4/16	1900	Head	250	5d182	3958	1303	9.86	40.10	39.44	-1.65
2018/4/25	2450	Head	250	924	3911	1386	12.80	51.80	51.20	-1.16
2018/4/25	5250	Head	100	1167	3911	1386	7.57	79.90	75.70	-5.26
2018/4/25	5600	Head	100	1167	3911	1386	8.68	83.80	86.80	3.58
2018/4/25	5750	Head	100	1167	3911	1386	8.11	80.60	81.10	0.62
2018/4/18	750	Body	250	1099	3958	1303	2.10	8.64	8.40	-2.78
2018/4/17	835	Body	250	4d162	3958	1303	2.52	9.56	10.08	5.44
2018/4/24	835	Body	250	4d162	3911	1386	2.55	9.56	10.20	6.69
2018/4/26	1750	Body	250	1137	3958	1303	9.20	37.00	36.80	-0.54
2018/4/26	1750	Body	250	1137	3911	1386	9.20	37.00	36.80	-0.54
2018/4/26	1900	Body	250	5d182	3958	1303	9.41	40.40	37.64	-6.83
2018/4/26	1900	Body	250	5d182	3911	1386	9.63	40.40	38.52	-4.65
2018/4/25	2450	Body	250	924	3911	1386	13.80	50.70	55.20	8.88
2018/4/25	5250	Body	100	1167	3911	1386	7.63	76.90	76.30	-0.78
2018/4/25	5600	Body	100	1167	3911	1386	8.66	80.00	86.60	8.25
2018/4/25	5750	Body	100	1167	3911	1386	8.35	77.50	83.50	7.74

<10g SAR>

Date	Frequency (MHz)	Tissue Type	Input Power (mW)	Dipole S/N	Probe S/N	DAE S/N	Measured 10g SAR (W/kg)	Targeted 10g SAR (W/kg)	Normalized 10g SAR (W/kg)	Deviation (%)
2018/4/26	1750	Body	250	1137	3958	1303	4.91	19.70	19.64	-0.30
2018/4/26	1750	Body	250	1137	3911	1386	4.91	19.70	19.64	-0.30
2018/4/26	1900	Body	250	5d182	3958	1386	4.82	21.00	19.28	-8.19
2018/4/26	1900	Body	250	5d182	3911	1386	4.93	21.00	19.72	-6.10
2018/4/25	5250	Body	100	1167	3911	1386	2.08	21.50	20.80	-3.26
2018/4/25	5600	Body	100	1167	3911	1386	2.32	22.40	23.20	3.57
2018/4/25	5750	Body	100	1167	3911	1386	2.27	21.60	22.70	5.09

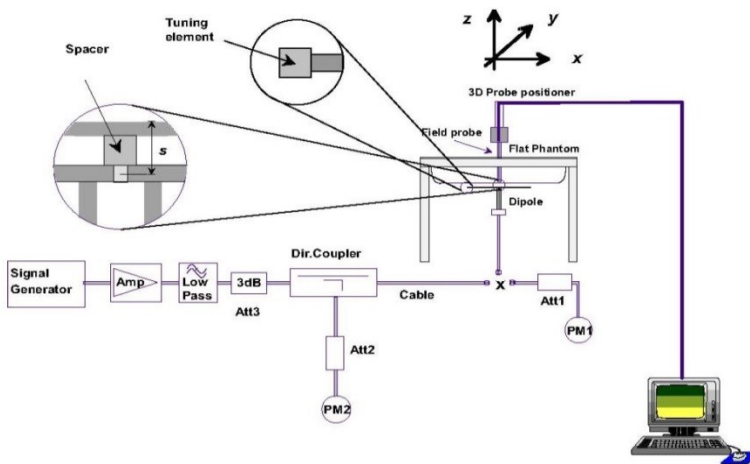

Fig 11.3.1 System Performance Check Setup



Fig 11.3.2 Setup Photo

12. RF Exposure Positions

12.1 Ear and handset reference point

Figure 9.1.1 shows the front, back, and side views of the SAM phantom. The center-of-mouth reference point is labeled “M,” the left ear reference point (ERP) is marked “LE,” and the right ERP is marked “RE.” Each ERP is 15 mm along the B-M (back-mouth) line behind the entrance-to-ear-canal (EEC) point, as shown in Figure 9.1.2 The Reference Plane is defined as passing through the two ear reference points and point M. The line N-F (neck-front), also called the reference pivoting line, is normal to the Reference Plane and perpendicular to both a line passing through RE and LE and the B-M line (see Figure 9.1.3). Both N-F and B-M lines should be marked on the exterior of the phantom shell to facilitate handset positioning. Posterior to the N-F line the ear shape is a flat surface with 6 mm thickness at each ERP, and forward of the N-F line the ear is truncated, as illustrated in Figure 9.1.2. The ear truncation is introduced to preclude the ear lobe from interfering with handset tilt, which could lead to unstable positioning at the cheek.

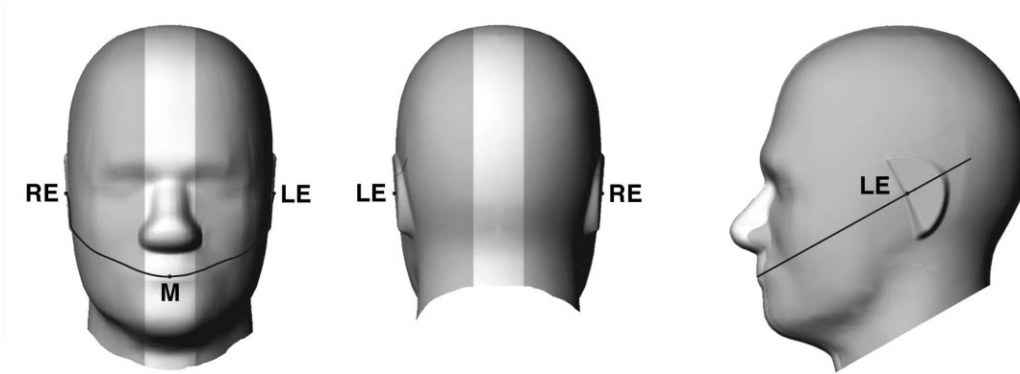

Fig 9.1.1 Front, back, and side views of SAM twin phantom

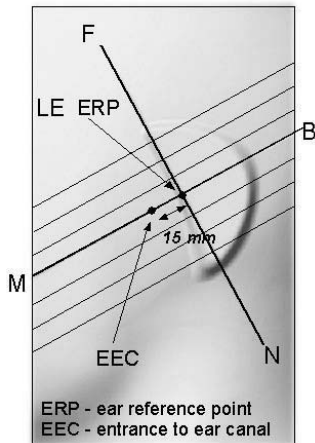

Fig 9.1.2 Close-up side view of phantom showing the ear region.

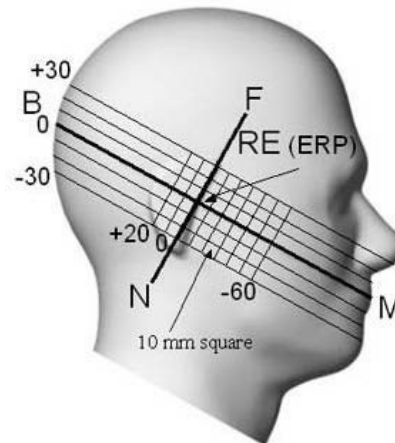

Fig 9.1.3 Side view of the phantom showing relevant markings and seven cross-sectional plane locations

12.2 Definition of the cheek position

1. Ready the handset for talk operation, if necessary. For example, for handsets with a cover piece (flip cover), open the cover. If the handset can transmit with the cover closed, both configurations must be tested.
2. Define two imaginary lines on the handset—the vertical centerline and the horizontal line. The vertical centerline passes through two points on the front side of the handset—the midpoint of the width w_t of the handset at the level of the acoustic output (point A in Figure 12.2.1 and Figure 12.2.2), and the midpoint of the width w_b of the bottom of the handset (point B). The horizontal line is perpendicular to the vertical centerline and passes through the center of the acoustic output (see Figure 12.2.1). The two lines intersect at point A. Note that for many handsets, point A coincides with the center of the acoustic output; however, the acoustic output may be located elsewhere on the horizontal line. Also note that the vertical centerline is not necessarily parallel to the front face of the handset (see Figure 12.2.2), especially for clamshell handsets, handsets with flip covers, and other irregularly-shaped handsets.
3. Position the handset close to the surface of the phantom such that point A is on the (virtual) extension of the line passing through points RE and LE on the phantom (see Figure 12.2.3), such that the plane defined by the vertical centerline and the horizontal line of the handset is approximately parallel to the sagittal plane of the phantom.
4. Translate the handset towards the phantom along the line passing through RE and LE until handset point A touches the pinna at the ERP.
5. While maintaining the handset in this plane, rotate it around the LE-RE line until the vertical centerline is in the plane normal to the plane containing B-M and N-F lines, i.e., the Reference Plane.
6. Rotate the handset around the vertical centerline until the handset (horizontal line) is parallel to the N-F line.
7. While maintaining the vertical centerline in the Reference Plane, keeping point A on the line passing through RE and LE, and maintaining the handset contact with the pinna, rotate the handset about the N-F line until any point on the handset is in contact with a phantom point below the pinna on the cheek. See Figure 12.2.3. The actual rotation angles should be documented in the test report.

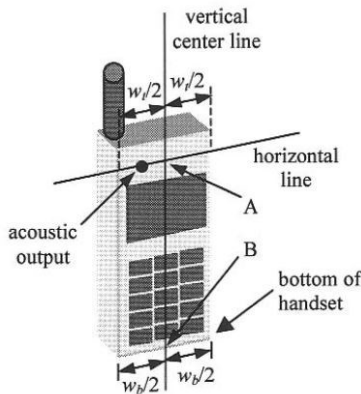

Fig 12.2.1 Handset vertical and horizontal reference lines—"fixed case"

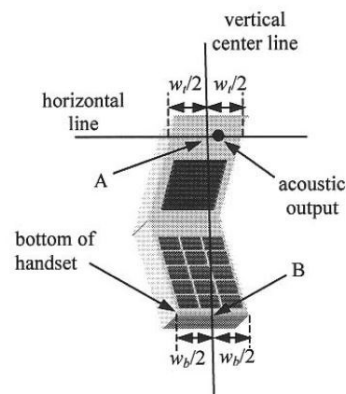

Fig 12.2.2 Handset vertical and horizontal reference lines—"clam-shell case"

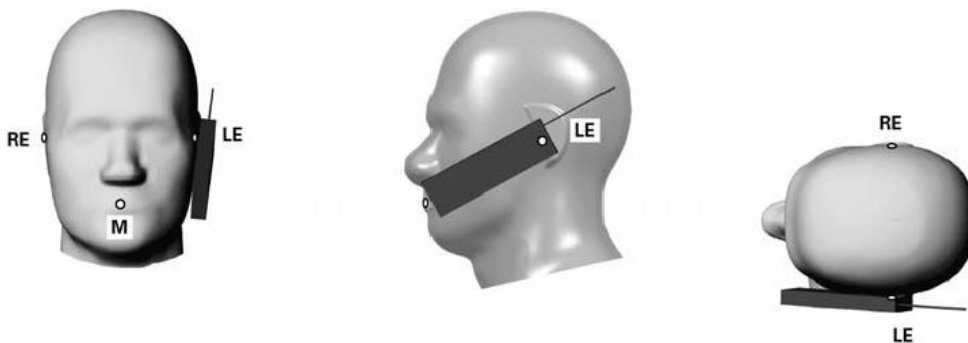

Fig 12.2.3 cheek or touch position. The reference points for the right ear (RE), left ear (LE), and mouth (M), which establish the Reference Plane for handset positioning, are indicated.

12.3 Definition of the tilt position

1. Ready the handset for talk operation, if necessary. For example, for handsets with a cover piece (flip cover), open the cover. If the handset can transmit with the cover closed, both configurations must be tested.
2. While maintaining the orientation of the handset, move the handset away from the pinna along the line passing through RE and LE far enough to allow a rotation of the handset away from the cheek by 15°.
3. Rotate the handset around the horizontal line by 15°.
4. While maintaining the orientation of the handset, move the handset towards the phantom on the line passing through RE and LE until any part of the handset touches the ear. The tilt position is obtained when the contact point is on the pinna. See Figure 12.3.1. If contact occurs at any location other than the pinna, e.g., the antenna at the back of the phantom head, the angle of the handset should be reduced. In this case, the tilt position is obtained if any point on the handset is in contact with the pinna and a second point

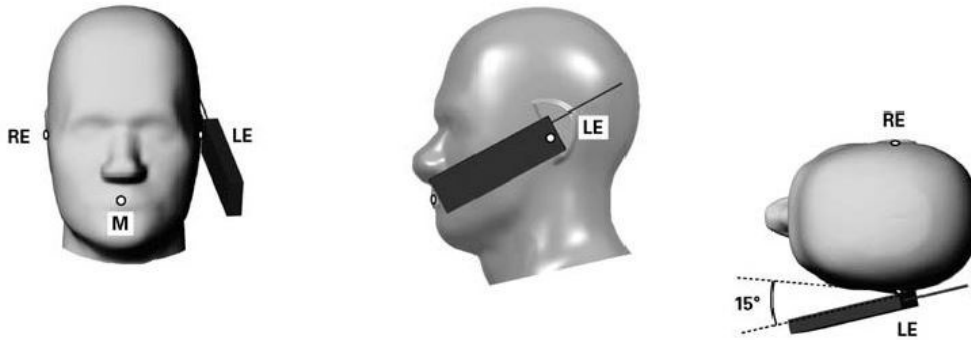

Fig 12.3.1 Tilt position. The reference points for the right ear (RE), left ear (LE), and mouth (M), which define the Reference Plane for handset positioning, are indicated.

12.4 Body Worn Accessory

Body-worn operating configurations are tested with the belt-clips and holsters attached to the device and positioned against a flat phantom in a normal use configuration (see Figure 12.4). Per KDB648474 D04v01r03, body-worn accessory exposure is typically related to voice mode operations when handsets are carried in body-worn accessories. The body-worn accessory procedures in FCC KDB 447498 D01v06 should be used to test for body-worn accessory SAR compliance, without a headset connected to it. This enables the test results for such configuration to be compatible with that required for hotspot mode when the body-worn accessory test separation distance is greater than or equal to that required for hotspot mode, when applicable. When the reported SAR for body-worn accessory, measured without a headset connected to the handset is $> 1.2 \text{ W/kg}$, the highest reported SAR configuration for that wireless mode and frequency band should be repeated for that body-worn accessory with a handset attached to the handset.

Accessories for body-worn operation configurations are divided into two categories: those that do not contain metallic components and those that do contain metallic components. When multiple accessories that do not contain metallic components are supplied with the device, the device is tested with only the accessory that dictates the closest spacing to the body. Then multiple accessories that contain metallic components are tested with the device with each accessory. If multiple accessories share an identical metallic component (i.e. the same metallic belt-chip used with different holsters with no other metallic components) only the accessory that dictates the closest spacing to the body is tested.

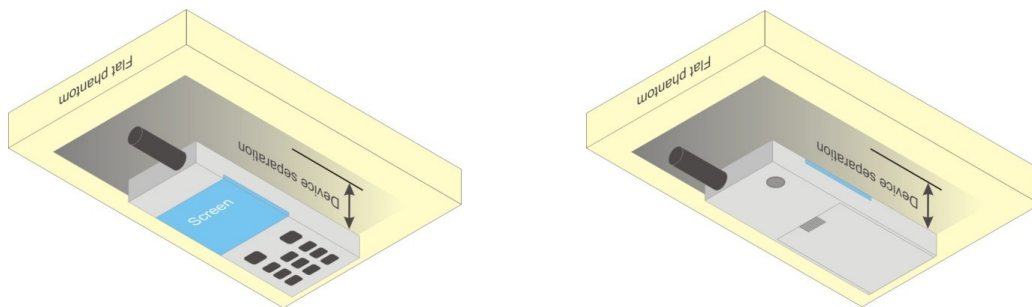

Fig 12.4 Body Worn Position



12.5 Product Specific 10g SAR Exposure

For smart phones with a display diagonal dimension > 15.0 cm or an overall diagonal dimension > 16.0 cm that provide similar mobile web access and multimedia support found in mini-tablets or UMPC mini-tablets that support voice calls next to the ear, According to KDB648474 D04v01r03, the following phablet procedures should be applied to evaluate SAR compliance for each applicable wireless modes and frequency band. Devices marketed as phablets, regardless of form factors and operating characteristics must be tested as a phablet to determine SAR compliance

1. The normally required head and body-worn accessory SAR test procedures for handsets, including hotspot mode, must be applied.
2. The UMPC mini-tablet procedures must also be applied to test the SAR of all surfaces and edges with an antenna located at ≤ 25 mm from that surface or edge, in direct contact with a flat phantom, for 10-g extremity SAR according to the body-equivalent tissue dielectric parameters in KDB 865664 to address interactive hand use exposure conditions.6 The UMPC mini-tablet 1-g SAR at 5 mm is not required. When hotspot mode applies, 10-g extremity SAR is required only for the surfaces and edges with hotspot mode 1-g reported SAR > 1.2 W/kg.

12.6 Wireless Router

Some battery-operated handsets have the capability to transmit and receive user through simultaneous transmission of WIFI simultaneously with a separate licensed transmitter. The FCC has provided guidance in FCC KDB Publication 941225 D06 v02r01 where SAR test considerations for handsets ($L \times W \geq 9$ cm x 5 cm) are based on a composite test separation distance of 10mm from the front, back and edges of the device containing transmitting antennas within 2.5cm of their edges, determined from general mixed use conditions for this type of devices. Since the hotspot SAR results may overlap with the body-worn accessory SAR requirements, the more conservative configurations can be considered, thus excluding some body-worn accessory SAR tests.

When the user enables the personal wireless router functions for the handset, actual operations include simultaneous transmission of both the WIFI transmitter and another licensed transmitter. Both transmitters often do not transmit at the same transmitting frequency and thus cannot be evaluated for SAR under actual use conditions due to the limitations of the SAR assessment probes. Therefore, SAR must be evaluated for each frequency transmission and mode separately and spatially summed with the WIFI transmitter according to FCC KDB Publication 447498 D01v06 publication procedures. The "Portable Hotspot" feature on the handset was NOT activated during SAR assessments, to ensure the SAR measurements were evaluated for a single transmission frequency RF signal at a time.



13. Conducted RF Output Power (Unit: dBm)

<GSM Conducted Power>

General Note:

1. Per KDB 447498 D01v06, the maximum output power channel is used for SAR testing and for further SAR test reduction.
2. Per KDB 941225 D01v03r01, for SAR test reduction for GSM / GPRS / EDGE modes is determined by the source-based time-averaged output power including tune-up tolerance. The mode with highest specified time-averaged output power should be tested for SAR compliance in the applicable exposure conditions. For modes with the same specified maximum output power and tolerance, the higher number time-slot configuration should be tested. Therefore, the GPRS (4Tx slots) for GSM850/GSM1900 is considered as the primary mode.
3. Other configurations of GSM / GPRS / EDGE are considered as secondary modes. The 3G SAR test reduction procedure is applied, when the maximum output power and tune-up tolerance specified for production units in a secondary mode is $\leq \frac{1}{4}$ dB higher than the primary mode, SAR measurement is not required for the secondary mode
4. Power reduction which is triggered by hotspot mode is implemented in GSM1900 band, for hotspot mode SAR testing EUT was set in reduced power mode and GPRS 1 Tx slot due to its highest frame-average power.

<Full Power Mode>

GSM850 Tx Channel	Burst Average Power (dBm)			Tune-up Limit (dBm)	Frame-Average Power (dBm)			Tune-up Limit (dBm)
	128	189	251		128	189	251	
Frequency (MHz)	824.2	836.4	848.8		824.2	836.4	848.8	
GSM 1 Tx slot	32.32	32.35	32.33	33.50	23.42	23.46	23.43	24.50
GPRS 1 Tx slot	32.30	32.33	32.31	33.50	23.40	23.43	23.41	24.50
GPRS 2 Tx slots	29.12	29.16	29.03	30.50	23.12	23.16	23.03	24.50
GPRS 3 Tx slots	27.11	27.16	27.06	28.75	22.85	22.90	22.80	24.49
GPRS 4 Tx slots	27.00	27.05	27.02	27.50	24.00	24.05	24.02	24.50
EDGE 1 Tx slot	26.88	26.66	26.50	28.00	17.88	17.66	17.50	19.00
EDGE 2 Tx slots	26.55	26.30	26.31	28.00	20.55	20.30	20.31	22.00
EDGE 3 Tx slots	25.14	24.87	24.98	26.25	20.88	20.61	20.72	21.24
EDGE 4 Tx slots	23.75	23.60	23.58	25.00	20.75	20.60	20.58	22.00
GSM1900								
Tx Channel	Burst Average Power (dBm)			Tune-up Limit (dBm)	Frame-Average Power (dBm)			Tune-up Limit (dBm)
	512	661	810		512	661	810	
Frequency (MHz)	1850.2	1880	1909.8		1850.2	1880	1909.8	
GSM 1 Tx slot	29.34	29.38	29.37	30.50	20.44	20.48	20.47	21.50
GPRS 1 Tx slot	29.32	29.36	29.35	30.50	20.42	20.46	20.45	21.50
GPRS 2 Tx slots	26.26	26.32	26.30	27.50	20.26	20.32	20.30	21.50
GPRS 3 Tx slots	24.17	24.27	24.24	25.75	19.91	20.01	19.98	21.49
GPRS 4 Tx slots	23.85	23.86	23.82	24.50	20.85	20.86	20.82	21.50
EDGE 1 Tx slot	25.88	25.96	25.68	27.00	16.88	16.96	16.68	18.00
EDGE 2 Tx slots	25.50	25.73	25.52	27.00	19.50	19.73	19.52	21.00
EDGE 3 Tx slots	24.22	24.31	24.13	25.25	19.96	20.05	19.87	20.99
EDGE 4 Tx slots	22.67	22.69	22.62	24.00	19.67	19.69	19.62	21.00

Remark: The frame-averaged power is linearly scaled the maximum burst averaged power over 8 time slots.

The calculated method are shown as below:

- Frame-averaged power = Maximum burst averaged power (1 Tx Slot) - 9 dB
- Frame-averaged power = Maximum burst averaged power (2 Tx Slots) - 6 dB
- Frame-averaged power = Maximum burst averaged power (3 Tx Slots) - 4.26 dB
- Frame-averaged power = Maximum burst averaged power (4 Tx Slots) - 3 dB

<Reduced Power Mode for Hotspot On/P-Sensor On>

GSM1900 Tx Channel	Burst Average Power (dBm)			Tune-up Limit (dBm)	Frame-Average Power (dBm)			Tune-up Limit (dBm)
	512	661	810		512	661	810	
Frequency (MHz)	1850.2	1880	1909.8		1850.2	1880	1909.8	
GSM 1 Tx slot	23.57	23.59	23.50	24.50	14.57	14.59	14.50	15.50
GPRS 1 Tx slot	23.56	23.57	23.48	24.50	14.56	14.57	14.48	15.50
GPRS 2 Tx slots	20.36	20.33	20.25	20.50	14.36	14.33	14.25	14.50
GPRS 3 Tx slots	18.35	18.46	18.37	18.50	14.09	14.20	14.11	14.24
GPRS 4 Tx slots	16.92	16.99	16.97	18.00	13.92	13.99	13.97	15.00
EDGE 1 Tx slot	21.05	21.03	20.87	21.50	12.05	12.03	11.87	12.50
EDGE 2 Tx slots	20.95	20.75	20.63	21.00	14.95	14.75	14.63	15.00
EDGE 3 Tx slots	18.93	18.92	18.93	19.00	14.67	14.66	14.67	14.74
EDGE 4 Tx slots	17.97	17.95	17.96	18.00	14.97	14.95	14.96	15.00

Remark: The frame-averaged power is linearly scaled the maximum burst averaged power over 8 time slots.

The calculated method are shown as below:

- Frame-averaged power = Maximum burst averaged power (1 Tx Slot) - 9 dB
- Frame-averaged power = Maximum burst averaged power (2 Tx Slots) - 6 dB
- Frame-averaged power = Maximum burst averaged power (3 Tx Slots) - 4.26 dB
- Frame-averaged power = Maximum burst averaged power (4 Tx Slots) - 3 dB

<WCDMA Conducted Power>

1. The following tests were conducted according to the test requirements outlines in 3GPP TS 34.121 specification.
2. The procedures in KDB 941225 D01v03r01 are applied for 3GPP Rel. 6 HSPA to configure the device in the required sub-test mode(s) to determine SAR test exclusion.
3. For DC-HSDPA, the device was configured according to the H-Set 12, Fixed Reference Channel (FRC) configuration in Table C.8.1.12 of 3GPP TS 34.121-1, with the primary and the secondary serving HS-DSCH Cell enabled during the power measurement.

A summary of these settings are illustrated below:

HSDPA Setup Configuration:

- a. The EUT was connected to Base Station Agilent E5515C referred to the Setup Configuration.
- b. The RF path losses were compensated into the measurements.
- c. A call was established between EUT and Base Station with following setting:
 - i. Set Gain Factors (β_c and β_d) and parameters were set according to each
 - ii. Specific sub-test in the following table, C10.1.4, quoted from the TS 34.121
 - iii. Set RMC 12.2Kbps + HSDPA mode.
 - iv. Set Cell Power = -86 dBm
 - v. Set HS-DSCH Configuration Type to FRC (H-set 1, QPSK)
 - vi. Select HSDPA Uplink Parameters
 - vii. Set Delta ACK, Delta NACK and Delta CQI = 8
 - viii. Set Ack-Nack Repetition Factor to 3
 - ix. Set CQI Feedback Cycle (k) to 4 ms
 - x. Set CQI Repetition Factor to 2
 - xi. Power Ctrl Mode = All Up bits
- d. The transmitted maximum output power was recorded.

Table C.10.1.4: β values for transmitter characteristics tests with HS-DPCCH

Sub-test	β_c	β_d	β_d (SF)	β_c/β_d	β_{HS} (Note 1, Note 2)	CM (dB) (Note 3)	MPR (dB) (Note 3)
1	2/15	15/15	64	2/15	4/15	0.0	0.0
2	12/15 (Note 4)	15/15 (Note 4)	64	12/15 (Note 4)	24/15	1.0	0.0
3	15/15	8/15	64	15/8	30/15	1.5	0.5
4	15/15	4/15	64	15/4	30/15	1.5	0.5

Note 1: $\Delta_{ACK}, \Delta_{NACK}$ and $\Delta_{CQI} = 30/15$ with $\beta_{HS} = 30/15 * \beta_c$.

Note 2: For the HS-DPCCH power mask requirement test in clause 5.2C, 5.7A, and the Error Vector Magnitude (EVM) with HS-DPCCH test in clause 5.13.1A, and HSDPA EVM with phase discontinuity in clause 5.13.1AA, Δ_{ACK} and $\Delta_{NACK} = 30/15$ with $\beta_{HS} = 30/15 * \beta_c$, and $\Delta_{CQI} = 24/15$ with $\beta_{HS} = 24/15 * \beta_c$.

Note 3: CM = 1 for $\beta_c/\beta_d = 12/15, \beta_{HS}/\beta_c = 24/15$. For all other combinations of DPCCH, DPDCCH and HS-DPCCH the MPR is based on the relative CM difference. This is applicable for only UEs that support HSDPA in release 6 and later releases.

Note 4: For subtest 2 the β_c/β_d ratio of 12/15 for the TFC during the measurement period (TF1, TF0) is achieved by setting the signalled gain factors for the reference TFC (TF1, TF1) to $\beta_c = 11/15$ and $\beta_d = 15/15$.

Setup Configuration

HSUPA Setup Configuration:

- a. The EUT was connected to Base Station Agilent E5515C referred to the Setup Configuration.
- b. The RF path losses were compensated into the measurements.
- c. A call was established between EUT and Base Station with following setting * :
 - i. Call Configs = 5.2B, 5.9B, 5.10B, and 5.13.2B with QPSK
 - ii. Set the Gain Factors (β_c and β_d) and parameters (AG Index) were set according to each specific sub-test in the following table, C11.1.3, quoted from the TS 34.121
 - iii. Set Cell Power = -86 dBm
 - iv. Set Channel Type = 12.2k + HSPA
 - v. Set UE Target Power
 - vi. Power Ctrl Mode= Alternating bits
 - vii. Set and observe the E-TFCl
 - viii. Confirm that E-TFCl is equal to the target E-TFCl of 75 for sub-test 1, and other subtest's E-TFCl
- d. The transmitted maximum output power was recorded.

Table C.11.1.3: β values for transmitter characteristics tests with HS-DPCCH and E-DCH

Sub-test	β_c	β_d	β_d (SF)	β_c/β_d	β_{HS} (Note1)	β_{ec}	β_{ed} (Note 4) (Note 5)	β_{ed} (SF)	β_{ed} (Codes)	CM (dB) (Note 2)	MPR (dB) (Note 2) (Note 6)	AG Index (Note 5)	E-TFCl
1	11/15 (Note 3)	15/15 (Note 3)	64	11/15 (Note 3)	22/15	209/25	1309/225	4	1	1.0	0.0	20	75
2	6/15	15/15	64	6/15	12/15	12/15	94/75	4	1	3.0	2.0	12	67
3	15/15	9/15	64	15/9	30/15	30/15	$\beta_{ed1}: 47/15$ $\beta_{ed2}: 47/15$	4	2	2.0	1.0	15	92
4	2/15	15/15	64	2/15	4/15	2/15	56/75	4	1	3.0	2.0	17	71
5	15/15	0	-	-	5/15	5/15	47/15	4	1	1.0	0.0	12	67

Note 1: For sub-test 1 to 4, Δ_{ACK} , Δ_{NACK} and $\Delta_{CQI} = 30/15$ with $\beta_{hs} = 30/15 * \beta_c$. For sub-test 5, Δ_{ACK} , Δ_{NACK} and $\Delta_{CQI} = 5/15$ with $\beta_{hs} = 5/15 * \beta_c$.

Note 2: CM = 1 for $\beta_c/\beta_d = 12/15$, $\beta_{hs}/\beta_c = 24/15$. For all other combinations of DPDCH, DPCCH, HS-DPCCH, E-DPDCH and E-DPCCH the MPR is based on the relative CM difference.

Note 3: For subtest 1 the β_c/β_d ratio of 11/15 for the TFC during the measurement period (TF1, TF0) is achieved by setting the signalled gain factors for the reference TFC (TF1, TF1) to $\beta_c = 10/15$ and $\beta_d = 15/15$.

Note 4: In case of testing by UE using E-DPDCH Physical Layer category 1, Sub-test 3 is omitted according to TS25.306 Table 5.1g.

Note 5: β_{ed} can not be set directly; it is set by Absolute Grant Value.

Note 6: For subtests 2, 3 and 4, UE may perform E-DPDCH power scaling at max power which could results in slightly smaller MPR values.

Setup Configuration

DC-HSDPA 3GPP release 8 Setup Configuration:

- a. The EUT was connected to Base Station Agilent E5515C referred to the Setup Configuration below
- b. The RF path losses were compensated into the measurements.
- c. A call was established between EUT and Base Station with following setting:
 - i. Set RMC 12.2Kbps + HSDPA mode.
 - ii. Set Cell Power = -25 dBm
 - iii. Set HS-DSCH Configuration Type to FRC (H-set 12, QPSK)
 - iv. Select HSDPA Uplink Parameters
 - v. Set Gain Factors (β_c and β_d) and parameters were set according to each Specific sub-test in the following table, C10.1.4, quoted from the TS 34.121
 - a). Subtest 1: $\beta_c/\beta_d=2/15$
 - b). Subtest 2: $\beta_c/\beta_d=12/15$
 - c). Subtest 3: $\beta_c/\beta_d=15/8$
 - d). Subtest 4: $\beta_c/\beta_d=15/4$
 - vi. Set Delta ACK, Delta NACK and Delta CQI = 8
 - vii. Set Ack-Nack Repetition Factor to 3
 - viii. Set CQI Feedback Cycle (k) to 4 ms
 - ix. Set CQI Repetition Factor to 2
 - x. Power Ctrl Mode = All Up bits
- d. The transmitted maximum output power was recorded.

The following tests were conducted according to the test requirements outlines in 3GPP TS 34.121 specification. A summary of these settings are illustrated below:

C.8.1.12 Fixed Reference Channel Definition H-Set 12

Table C.8.1.12: Fixed Reference Channel H-Set 12

Parameter	Unit	Value
Nominal Avg. Inf. Bit Rate	kbps	60
Inter-TTI Distance	TTI's	1
Number of HARQ Processes	Processes	6
Information Bit Payload (N_{INF})	Bits	120
Number Code Blocks	Blocks	1
Binary Channel Bits Per TTI	Bits	960
Total Available SML's in UE	SML's	19200
Number of SML's per HARQ Proc.	SML's	3200
Coding Rate		0.15
Number of Physical Channel Codes	Codes	1
Modulation		QPSK
Note 1: The RMC is intended to be used for DC-HSDPA mode and both cells shall transmit with identical parameters as listed in the table. Note 2: Maximum number of transmission is limited to 1, i.e., retransmission is not allowed. The redundancy and constellation version 0 shall be used.		

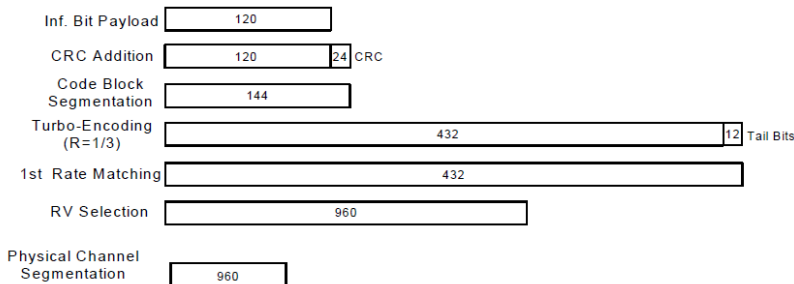

Figure C.8.19: Coding rate for Fixed reference Channel H-Set 12 (QPSK)

Setup Configuration



<WCDMA Conducted Power>

General Note:

1. Per KDB 941225 D01v03r01, for SAR testing is measured using a 12.2 kbps RMC with TPC bits configured to all "1's".
2. Per KDB 941225 D01v03r01, RMC 12.2kbps setting is used to evaluate SAR. The maximum output power and tune-up tolerance specified for production units in HSDPA / HSUPA / DC-HSDPA is $\leq \frac{1}{4}$ dB higher than RMC 12.2Kbps or when the highest reported SAR of the RMC12.2Kbps is scaled by the ratio of specified maximum output power and tune-up tolerance of HSDPA / HSUPA / DC-HSDPA to RMC12.2Kbps and the adjusted SAR is ≤ 1.2 W/kg, SAR measurement is not required for HSDPA / HSUPA / DC-HSDPA, and according to the following RF output power, the output power results of the secondary modes (HSUPA, HSDPA, DC-HSDPA) are less than $\frac{1}{4}$ dB higher than the primary modes; therefore, SAR measurement is not required for HSDPA / HSUPA / DC-HSDPA.

<Full Power Mode>

Band		WCDMA Band II			Tune-up Limit (dBm)	WCDMA Band IV			Tune-up Limit (dBm)	WCDMA Band V			Tune-up Limit (dBm)
Tx Channel		9262	9400	9538		1312	1413	1513		4132	4182	4233	
Rx Channel		9662	9800	9938		1537	1638	1738		4357	4407	4458	
Frequency (MHz)		1852.4	1880	1907.6	1712.4	1732.6	1752.6	826.4	836.4	846.6			
3GPP Rel 99	AMR 12.2Kbps	23.20	23.24	23.19	24.00	22.98	22.93	22.85	24.00	22.88	22.89	23.05	24.00
3GPP Rel 99	RMC 12.2Kbps	23.24	23.26	23.22	24.00	23.00	22.96	22.89	24.00	22.90	22.92	23.08	24.00
3GPP Rel 6	HSDPA Subtest-1	22.64	22.64	22.72	23.00	22.00	21.91	21.80	23.00	22.18	22.25	22.30	22.50
3GPP Rel 6	HSDPA Subtest-2	22.64	22.63	22.73	23.00	21.98	21.89	21.81	23.00	22.21	22.25	22.26	22.50
3GPP Rel 6	HSDPA Subtest-3	22.14	22.17	22.25	23.00	21.49	21.40	21.41	23.00	21.69	21.75	21.81	22.50
3GPP Rel 6	HSDPA Subtest-4	22.12	22.12	22.23	23.00	21.48	21.40	21.40	23.00	21.71	21.75	21.78	22.50
3GPP Rel 8	DC-HSDPA Subtest-1	22.35	22.14	22.03	23.00	22.01	21.90	21.92	23.00	21.87	21.92	21.99	22.50
3GPP Rel 8	DC-HSDPA Subtest-2	22.11	22.10	21.98	23.00	21.87	21.79	21.77	23.00	21.86	21.93	21.95	22.50
3GPP Rel 8	DC-HSDPA Subtest-3	21.68	21.65	21.52	23.00	21.42	21.19	21.18	23.00	21.40	21.43	21.56	22.50
3GPP Rel 8	DC-HSDPA Subtest-4	21.97	21.60	21.47	23.00	21.23	21.13	21.15	23.00	21.37	21.40	21.48	22.50
3GPP Rel 6	HSUPA Subtest-1	22.67	22.66	22.75	23.00	22.03	21.98	21.66	23.00	22.23	22.24	22.34	23.00
3GPP Rel 6	HSUPA Subtest-2	20.64	20.68	20.79	21.00	20.02	19.95	19.60	21.00	20.23	20.31	20.34	21.00
3GPP Rel 6	HSUPA Subtest-3	21.62	21.68	21.79	22.00	20.98	20.97	21.35	22.00	21.27	21.29	21.35	22.00
3GPP Rel 6	HSUPA Subtest-4	20.61	20.64	20.72	21.00	20.01	19.99	20.08	21.00	20.29	20.25	20.36	21.00
3GPP Rel 6	HSUPA Subtest-5	22.70	22.70	22.80	23.00	22.00	22.00	21.50	23.00	22.20	22.30	22.40	23.00



<Reduced Power Mode for Hotspot On/P-Sensor On>

Band		WCDMA Band II			Tune-up Limit (dBm)	WCDMA Band IV			Tune-up Limit (dBm)	WCDMA Band V			Tune-up Limit (dBm)
Tx Channel		9262	9400	9538		1312	1413	1513		4132	4182	4233	
Rx Channel		9662	9800	9938		1537	1638	1738		4357	4407	4458	
Frequency (MHz)		1852.4	1880	1907.6		1712.4	1732.6	1752.6		826.4	836.4	846.6	
3GPP Rel 99	AMR 12.2Kbps	14.44	14.48	14.31	15.00	16.71	16.72	16.70	17.00	22.33	22.37	22.58	23.00
3GPP Rel 99	RMC 12.2Kbps	14.46	14.49	14.32	15.00	16.74	16.73	16.71	17.00	22.35	22.39	22.59	23.00
3GPP Rel 6	HSDPA Subtest-1	13.48	13.47	13.33	14.00	15.71	15.76	15.71	16.00	21.35	21.42	21.47	22.00
3GPP Rel 6	HSDPA Subtest-2	13.47	13.51	13.34	14.00	15.72	15.77	15.71	16.00	21.37	21.40	21.53	22.00
3GPP Rel 6	HSDPA Subtest-3	12.92	13.02	12.84	13.50	15.26	15.28	15.20	15.50	20.91	20.92	20.96	21.50
3GPP Rel 6	HSDPA Subtest-4	13.01	13.01	12.85	13.50	15.24	15.27	15.21	15.50	20.84	20.90	20.98	21.50
3GPP Rel 8	DC-HSDPA Subtest-1	13.42	13.44	13.39	14.00	15.67	15.73	15.68	16.00	21.77	21.74	21.96	22.00
3GPP Rel 8	DC-HSDPA Subtest-2	13.40	13.43	13.38	14.00	15.65	15.72	15.67	16.00	21.76	21.73	21.95	22.00
3GPP Rel 8	DC-HSDPA Subtest-3	12.91	12.95	12.87	13.50	15.21	15.24	15.20	15.50	21.21	21.25	20.98	21.50
3GPP Rel 8	DC-HSDPA Subtest-4	12.90	12.94	12.85	13.50	15.19	15.22	15.16	15.50	21.20	21.25	20.96	21.50
3GPP Rel 6	HSUPA Subtest-1	13.51	13.29	13.51	14.00	15.82	15.77	15.79	16.00	21.48	21.52	21.55	22.00
3GPP Rel 6	HSUPA Subtest-2	11.57	11.48	11.55	12.00	13.73	13.76	13.79	14.00	19.48	19.51	19.55	20.00
3GPP Rel 6	HSUPA Subtest-3	12.48	12.51	12.49	13.00	14.76	14.73	14.74	15.00	20.48	20.50	20.54	21.00
3GPP Rel 6	HSUPA Subtest-4	11.56	11.47	11.53	12.00	13.86	13.73	13.77	14.00	19.46	19.53	19.52	20.00
3GPP Rel 6	HSUPA Subtest-5	13.50	13.50	13.40	14.00	15.90	15.70	15.80	16.00	21.50	21.50	21.60	22.00

<Reduced Power Mode for Product Specific 10g SAR>

Band		WCDMA Band II			Tune-up Limit (dBm)	WCDMA Band IV			Tune-up Limit (dBm)
Tx Channel		9262	9400	9538		1312	1413	1513	
Rx Channel		9662	9800	9938		1537	1638	1738	
Frequency (MHz)		1852.4	1880	1907.6		1712.4	1732.6	1752.6	
3GPP Rel 99	AMR 12.2Kbps	19.44	19.47	19.30	20.00	19.71	19.71	19.68	20.00
3GPP Rel 99	RMC 12.2Kbps	19.46	19.49	19.35	20.00	19.75	19.74	19.69	20.00
3GPP Rel 6	HSDPA Subtest-1	18.50	18.50	18.37	19.00	18.63	18.73	18.68	19.00
3GPP Rel 6	HSDPA Subtest-2	18.50	18.48	18.36	19.00	18.70	18.72	18.65	19.00
3GPP Rel 6	HSDPA Subtest-3	18.01	17.99	17.87	18.50	18.24	18.23	18.18	18.50
3GPP Rel 6	HSDPA Subtest-4	17.99	17.99	17.87	18.50	18.24	18.24	18.16	18.50
3GPP Rel 8	DC-HSDPA Subtest-1	18.44	18.45	18.33	19.00	18.16	18.14	18.11	19.00
3GPP Rel 8	DC-HSDPA Subtest-2	18.43	18.43	18.31	19.00	18.14	18.13	18.09	19.00
3GPP Rel 8	DC-HSDPA Subtest-3	17.96	17.94	17.91	18.50	17.64	17.62	17.61	18.50
3GPP Rel 8	DC-HSDPA Subtest-4	17.95	17.95	17.91	18.50	17.63	17.62	17.60	18.50
3GPP Rel 6	HSUPA Subtest-1	18.54	18.56	18.38	19.00	18.76	18.72	18.70	19.00
3GPP Rel 6	HSUPA Subtest-2	16.51	16.50	16.40	17.00	16.76	16.72	16.71	17.00
3GPP Rel 6	HSUPA Subtest-3	17.54	17.59	17.34	18.00	17.72	17.71	17.71	18.00
3GPP Rel 6	HSUPA Subtest-4	16.52	16.53	16.35	17.00	16.75	16.78	16.67	17.00
3GPP Rel 6	HSUPA Subtest-5	18.50	18.50	18.40	19.00	18.70	18.80	18.70	19.00



<CDMA2000 Conducted Power>

General Note:

1. Per KDB 941225 D01v03r01, SAR for head exposure is measured in RC3 with the handset configured to transmit at full rate in SO55.
2. Per KDB 941225 D01v03r01, in Hotspot mode EUT is treated as data device and SAR is tested with Ev-Do Rev 0 (RTAP 153.6kbps) as the primary mode.
3. Per KDB 941225 D01v03r01, for Body-worn accessory SAR is measured in RC3 with the handset configured in TDSO/SO32 to transmit at full rate on FCH only with all other code channels disabled. The body-worn accessory procedures in KDB Publication 447498 are applied. The 3G SAR test reduction procedure is applied to the multiple code channel configuration (FCH+SCH), with FCH only as the primary mode.

<Full Power Mode>

Band	CDMA2000 BC0			Tune-up Limit (dBm)	CDMA2000 BC1			Tune-up Limit (dBm)
	Tx Channel	1013	384		777	25	600	
Frequency (MHz)	824.7	836.52	848.31		1851.25	1880	1908.75	
RC1 SO55	23.64	23.70	23.62	25.00	24.47	24.53	24.34	25.00
RC3 SO55	23.63	23.69	23.60	25.00	24.46	24.51	24.32	25.00
RC3 SO32 (F+SCH)	23.58	23.60	23.51	25.00	24.40	24.47	24.15	25.00
RC3 SO32 (+SCH)	23.55	23.57	23.48	25.00	24.21	24.36	24.13	25.00
RTAP 153.6Kbps	23.48	23.54	23.46	25.00	24.15	24.21	24.08	25.00
RETAP 4096Bits	23.08	23.15	23.06	25.00	23.77	23.81	23.74	25.00

<Reduced Power Mode for Hotspot On/P-Sensor On>

Band	CDMA2000 BC0			Tune-up Limit (dBm)	CDMA2000 BC1			Tune-up Limit (dBm)
	Tx Channel	1013	384		777	25	600	
Frequency (MHz)	824.7	836.52	848.31		1851.25	1880	1908.75	
RC1 SO55	22.07	22.10	21.96	22.50	15.80	15.85	15.84	16.00
RC3 SO55	22.03	22.07	21.93	22.50	15.77	15.81	15.82	16.00
RC3 SO32 (F+SCH)	22.06	22.09	21.94	22.50	15.78	15.83	15.82	16.00
RC3 SO32 (+SCH)	22.05	22.07	21.93	22.50	15.76	15.81	15.49	16.00
RTAP 153.6Kbps	22.05	22.08	21.93	22.50	15.74	15.78	15.77	16.00
RETAP 4096Bits	21.91	21.97	21.81	22.50	15.72	15.77	15.76	16.00

<Reduced Power Mode for Product Specific 10g SAR>

Band	CDMA2000 BC1			Tune-up Limit (dBm)
	Tx Channel	25	600	
Frequency (MHz)	1851.25	1880	1908.75	
RC1 SO55	20.30	20.34	20.32	21.00
RC3 SO55	20.28	20.32	20.31	21.00
RC3 SO32 (F+SCH)	20.27	20.31	20.30	21.00
RC3 SO32 (+SCH)	20.26	20.30	20.28	21.00
RTAP 153.6Kbps	20.24	20.29	20.28	21.00
RETAP 4096Bits	20.22	20.25	20.26	21.00

<LTE Conducted Power>

General Note:

1. Anritsu MT8820C base station simulator was used to setup the connection with EUT; the frequency band, channel bandwidth, RB allocation configuration, modulation type are set in the base station simulator to configure EUT transmitting at maximum power and at different configurations which are requested to be reported to FCC, for conducted power measurement and SAR testing.
2. Per KDB 941225 D05v02r05, when a properly configured base station simulator is used for the SAR and power measurements, spectrum plots for each RB allocation and offset configuration is not required.
3. Per KDB 941225 D05v02r05, start with the largest channel bandwidth and measure SAR for QPSK with 1 RB allocation, using the RB offset and required test channel combination with the highest maximum output power for RB offsets at the upper edge, middle and lower edge of each required test channel.
4. Per KDB 941225 D05v02r05, 50% RB allocation for QPSK SAR testing follows 1RB QPSK allocation procedure.
5. Per KDB 941225 D05v02r05, For QPSK with 100% RB allocation, SAR is not required when the highest maximum output power for 100 % RB allocation is less than the highest maximum output power in 50% and 1 RB allocations and the highest reported SAR for 1 RB and 50% RB allocation are ≤ 0.8 W/kg. Otherwise, SAR is measured for the highest output power channel; and if the reported SAR is > 1.45 W/kg, the remaining required test channels must also be tested.
6. Per KDB 941225 D05v02r05, 16QAM/64QAM output power for each RB allocation configuration is $>$ not $\frac{1}{2}$ dB higher than the same configuration in QPSK and the reported SAR for the QPSK configuration is ≤ 1.45 W/kg; Per KDB 941225 D05v02r05, 16QAM/64QA SAR testing is not required.
7. Per KDB 941225 D05v02r05, Smaller bandwidth output power for each RB allocation configuration is $>$ not $\frac{1}{2}$ dB higher than the same configuration in the largest supported bandwidth, and the reported SAR for the largest supported bandwidth is ≤ 1.45 W/kg; Per KDB 941225 D05v02r05, smaller bandwidth SAR testing is not required.
8. For LTE B4 / B5 / B12 the maximum bandwidth does not support three non-overlapping channels, per KDB 941225 D05v02r05, when a device supports overlapping channel assignment in a channel bandwidth configuration, the middle channel of the group of overlapping channels should be selected for testing.
9. LTE B4 SAR test was covered by B66; according to April 2015 TCB workshop, SAR test for overlapping LTE bands can be reduced if
 - a. the maximum output power, including tolerance, for the smaller band is \leq the larger band to qualify for the SAR test exclusion
 - b. the channel bandwidth and other operating parameters for the smaller band are fully supported by the larger band
10. According to 2017 TCB workshop, for 64 QAM and 16 QAM should be verified by checking the signal constellation with a call box to avoid incorrect maximum power levels due to MPR and other requirements associated with signal modulation, and the following figure is taken from the "Fundamental Measurement >> Modulation Analysis >> constellation" mode of the device connect to the MT8821C base station, therefore, the device 64QAM and 16QAM signal modulation are correct.

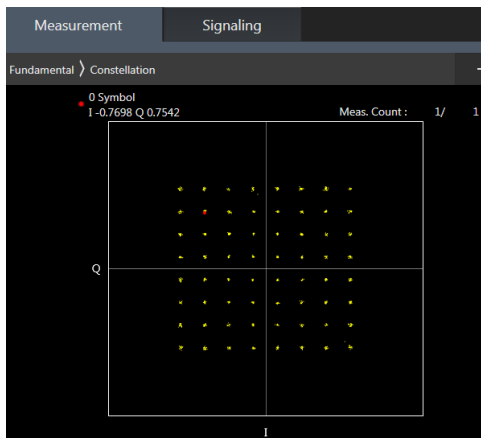

64QAM

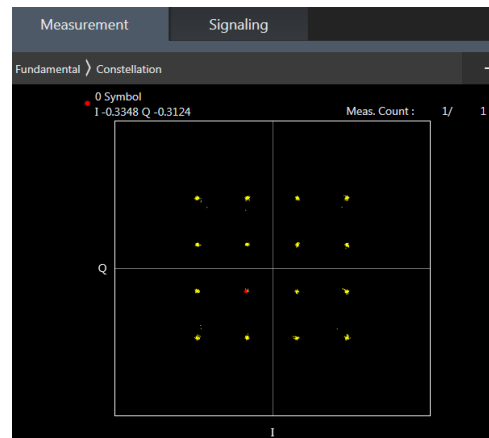

16QAM



<Full Power Mode>

<LTE Band 2>

BW [MHz]	Modulation	RB Size	RB Offset	Power Low Ch. / Freq.	Power Middle Ch. / Freq.	Power High Ch. / Freq.	Tune-up limit (dBm)	MPR (dB)
Channel				18700	18900	19100		
Frequency (MHz)				1860	1880	1900		
20	QPSK	1	0	23.62	23.34	23.31	24	0
20	QPSK	1	49	23.30	23.35	23.32		
20	QPSK	1	99	23.63	23.80	23.69		
20	QPSK	50	0	22.50	22.58	22.53	23	1
20	QPSK	50	24	22.36	22.35	22.43		
20	QPSK	50	50	22.48	22.46	22.34		
20	QPSK	100	0	22.39	22.56	22.53	23	1
20	16QAM	1	0	22.79	22.90	22.95		
20	16QAM	1	49	22.62	22.56	22.46		
20	16QAM	1	99	22.93	22.98	22.64	22	2
20	16QAM	50	0	21.43	21.52	21.53		
20	16QAM	50	24	21.36	21.37	21.45		
20	16QAM	50	50	21.46	21.44	21.43	23	1
20	16QAM	100	0	21.44	21.44	21.57		
20	64QAM	1	0	22.75	22.80	22.70		
20	64QAM	1	49	22.71	22.86	22.74	22	2
20	64QAM	1	99	22.98	22.30	22.58		
20	64QAM	50	0	21.62	21.74	21.79		
20	64QAM	50	24	21.70	21.85	21.69	22	2
20	64QAM	50	50	21.86	21.78	21.92		
20	64QAM	100	0	21.72	21.67	21.73		
Channel				18675	18900	19125		
Frequency (MHz)				1857.5	1880	1902.5		
15	QPSK	1	0	23.25	23.34	23.44	24	0
15	QPSK	1	37	23.25	23.46	23.12		
15	QPSK	1	74	23.68	23.76	23.53		
15	QPSK	36	0	22.57	22.55	22.42	23	1
15	QPSK	36	20	22.32	22.44	22.22		
15	QPSK	36	39	22.43	22.49	22.24		
15	QPSK	75	0	22.43	22.45	22.45	23	1
15	16QAM	1	0	22.85	22.99	22.98		
15	16QAM	1	37	22.74	22.56	22.46		
15	16QAM	1	74	22.92	22.96	22.73	22	2
15	16QAM	36	0	21.39	21.49	21.39		
15	16QAM	36	20	21.32	21.45	21.37		
15	16QAM	36	39	21.43	21.51	21.41	23	1
15	16QAM	75	0	21.44	21.44	21.51		
15	64QAM	1	0	22.60	22.80	22.80		
15	64QAM	1	37	22.80	23.00	22.68	22	2
15	64QAM	1	74	22.89	22.14	22.11		
15	64QAM	36	0	21.58	21.84	21.86		
15	64QAM	36	20	21.67	21.79	21.82	22	2
15	64QAM	36	39	21.72	21.56	21.72		
15	64QAM	75	0	21.65	21.94	21.91		



Channel				18650	18900	19150	Tune-up limit (dBm)	MPR (dB)
Frequency (MHz)				1855	1880	1905		
10	QPSK	1	0	23.19	23.13	23.06	24	0
10	QPSK	1	25	23.28	23.30	23.32		
10	QPSK	1	49	23.43	23.61	23.40		
10	QPSK	25	0	22.54	22.35	22.45	23	1
10	QPSK	25	12	22.50	22.31	22.20		
10	QPSK	25	25	22.41	22.39	22.49		
10	QPSK	50	0	22.52	22.44	22.54	23	1
10	16QAM	1	0	22.51	22.81	23.00		
10	16QAM	1	25	22.13	22.40	22.45		
10	16QAM	1	49	22.97	22.85	22.81	22	2
10	16QAM	25	0	21.56	21.37	21.49		
10	16QAM	25	12	21.35	21.27	21.23		
10	16QAM	25	25	21.54	21.35	21.32	23	1
10	16QAM	50	0	21.45	21.45	21.39		
10	64QAM	1	0	22.70	22.94	22.90		
10	64QAM	1	25	22.59	22.85	22.93	22	2
10	64QAM	1	49	22.83	22.93	22.20		
10	64QAM	25	0	21.75	21.68	21.97		
10	64QAM	25	12	21.66	21.75	21.85	22	2
10	64QAM	25	25	21.75	21.83	21.90		
10	64QAM	25	0	21.70	21.92	21.96		
Channel				18625	18900	19175	Tune-up limit (dBm)	MPR (dB)
Frequency (MHz)				1852.5	1880	1907.5		
5	QPSK	1	0	23.36	23.25	23.25	24	0
5	QPSK	1	12	23.30	23.30	23.48		
5	QPSK	1	24	23.63	23.54	23.71		
5	QPSK	12	0	22.55	22.37	22.49	23	1
5	QPSK	12	7	22.43	22.41	22.32		
5	QPSK	12	13	22.42	22.43	22.51		
5	QPSK	25	0	22.47	22.43	22.43	23	1
5	16QAM	1	0	22.87	22.82	22.82		
5	16QAM	1	12	22.53	22.56	22.47		
5	16QAM	1	24	22.90	22.79	22.78	22	2
5	16QAM	12	0	21.56	21.34	21.47		
5	16QAM	12	7	21.44	21.35	21.34		
5	16QAM	12	13	21.43	21.36	21.52	23	1
5	16QAM	25	0	21.48	21.40	21.47		
5	64QAM	1	0	22.70	22.70	22.87		
5	64QAM	1	12	22.37	22.80	22.62	22	2
5	64QAM	1	24	22.69	22.95	22.71		
5	64QAM	12	0	21.71	21.88	21.88		
5	64QAM	12	7	21.67	21.68	21.80	22	2
5	64QAM	12	13	21.76	21.69	21.94		
5	64QAM	25	0	21.68	21.79	21.88		



Channel				18615	18900	19185	Tune-up limit (dBm)	MPR (dB)
Frequency (MHz)				1851.5	1880	1908.5		
3	QPSK	1	0	23.15	22.90	23.02	24	0
3	QPSK	1	8	23.38	23.23	23.34		
3	QPSK	1	14	23.32	23.32	23.40		
3	QPSK	8	0	22.46	22.38	22.33	23	1
3	QPSK	8	4	22.46	22.35	22.34		
3	QPSK	8	7	22.39	22.29	22.36		
3	QPSK	15	0	22.47	22.37	22.45		
3	16QAM	1	0	22.71	22.63	22.70	23	1
3	16QAM	1	8	22.57	22.54	22.52		
3	16QAM	1	14	22.58	22.55	22.45		
3	16QAM	8	0	21.53	21.42	21.40	22	2
3	16QAM	8	4	21.52	21.38	21.40		
3	16QAM	8	7	21.40	21.31	21.32		
3	16QAM	15	0	21.53	21.35	21.40		
3	64QAM	1	0	22.73	22.81	22.87	23	1
3	64QAM	1	8	22.82	23.00	22.99		
3	64QAM	1	14	22.67	22.85	22.72		
3	64QAM	8	0	21.73	21.96	21.84	22	2
3	64QAM	8	4	21.73	21.75	22.00		
3	64QAM	8	7	21.61	21.63	21.76		
3	64QAM	15	0	21.67	21.61	21.97		
Channel				18607	18900	19193	Tune-up limit (dBm)	MPR (dB)
Frequency (MHz)				1850.7	1880	1909.3		
1.4	QPSK	1	0	23.19	22.83	22.73	24	0
1.4	QPSK	1	3	23.35	23.30	23.22		
1.4	QPSK	1	5	23.29	23.18	23.23		
1.4	QPSK	3	0	23.32	23.22	23.28		
1.4	QPSK	3	1	23.34	23.27	23.28		
1.4	QPSK	3	3	23.32	23.23	23.27		
1.4	QPSK	6	0	22.36	22.29	22.26	23	1
1.4	16QAM	1	0	22.66	22.55	22.71	23	1
1.4	16QAM	1	3	22.58	22.60	22.53		
1.4	16QAM	1	5	22.58	22.47	22.48		
1.4	16QAM	3	0	22.37	22.28	22.23		
1.4	16QAM	3	1	22.38	22.36	22.26		
1.4	16QAM	3	3	22.29	22.25	22.21		
1.4	16QAM	6	0	21.49	21.35	21.40	22	2
1.4	64QAM	1	0	22.53	22.70	22.30	23	1
1.4	64QAM	1	3	22.74	23.00	22.82		
1.4	64QAM	1	5	22.69	23.00	22.75		
1.4	64QAM	3	0	22.65	22.83	22.71		
1.4	64QAM	3	1	22.82	22.82	23.00		
1.4	64QAM	3	3	22.59	22.96	22.81		
1.4	64QAM	6	0	21.59	21.68	21.81	22	2



<LTE Band 4>

BW [MHz]	Modulation	RB Size	RB Offset	Power Low Ch. / Freq.	Power Middle Ch. / Freq.	Power High Ch. / Freq.	Tune-up limit (dBm)	MPR (dB)
Channel				20050	20175	20300		
Frequency (MHz)				1720	1732.5	1745		
20	QPSK	1	0	23.52	23.49	23.33	24	0
20	QPSK	1	49	23.58	23.39	23.39		
20	QPSK	1	99	23.50	23.68	23.61		
20	QPSK	50	0	22.59	22.55	22.52	23	1
20	QPSK	50	24	22.53	22.57	22.45		
20	QPSK	50	50	22.69	22.72	22.53		
20	QPSK	100	0	22.63	22.67	22.49		
20	16QAM	1	0	22.59	22.72	22.71	23	1
20	16QAM	1	49	22.56	22.65	22.60		
20	16QAM	1	99	22.79	22.63	22.70		
20	16QAM	50	0	21.50	21.50	21.42	22	2
20	16QAM	50	24	21.37	21.44	21.41		
20	16QAM	50	50	21.40	21.35	21.35		
20	16QAM	100	0	21.38	21.35	21.35		
20	64QAM	1	0	22.46	22.30	22.34	23	1
20	64QAM	1	49	22.56	22.63	22.78		
20	64QAM	1	99	22.34	22.30	22.41		
20	64QAM	50	0	21.47	21.49	21.33	22	2
20	64QAM	50	24	21.46	21.44	21.29		
20	64QAM	50	50	21.47	21.42	21.33		
20	64QAM	100	0	21.42	21.36	21.30		
Channel				20025	20175	20325	Tune-up limit (dBm)	MPR (dB)
Frequency (MHz)				1717.5	1732.5	1747.5		
15	QPSK	1	0	23.15	23.28	23.23	24	0
15	QPSK	1	37	23.05	23.19	23.28		
15	QPSK	1	74	23.39	23.38	23.41		
15	QPSK	36	0	22.52	22.51	22.44	23	1
15	QPSK	36	20	22.42	22.39	22.43		
15	QPSK	36	39	22.35	22.32	22.28		
15	QPSK	75	0	22.42	22.37	22.41		
15	16QAM	1	0	22.73	22.86	22.79	23	1
15	16QAM	1	37	22.70	22.61	22.66		
15	16QAM	1	74	22.69	22.69	22.72		
15	16QAM	36	0	21.51	21.47	21.39	22	2
15	16QAM	36	20	21.39	21.40	21.40		
15	16QAM	36	39	21.40	21.33	21.40		
15	16QAM	75	0	21.40	21.37	21.42		
15	64QAM	1	0	22.38	22.43	22.56	23	1
15	64QAM	1	37	22.57	21.89	21.52		
15	64QAM	1	74	22.21	22.25	22.10		
15	64QAM	36	0	21.40	21.38	21.32	22	2
15	64QAM	36	20	21.47	21.35	21.39		
15	64QAM	36	39	21.39	21.36	21.37		
15	64QAM	75	0	21.46	21.44	21.34		



Channel				20000	20175	20350	Tune-up limit (dBm)	MPR (dB)
Frequency (MHz)				1715	1732.5	1750		
10	QPSK	1	0	22.98	23.13	23.05	24	0
10	QPSK	1	25	23.40	23.26	23.26		
10	QPSK	1	49	23.50	23.35	23.40		
10	QPSK	25	0	22.50	22.53	22.45	23	1
10	QPSK	25	12	22.39	22.49	22.37		
10	QPSK	25	25	22.37	22.35	22.42		
10	QPSK	50	0	22.39	22.37	22.39		
10	16QAM	1	0	22.98	22.95	22.98	23	1
10	16QAM	1	25	22.76	22.71	22.72		
10	16QAM	1	49	22.94	22.98	22.89		
10	16QAM	25	0	21.56	21.58	21.56	22	2
10	16QAM	25	12	21.53	21.55	21.38		
10	16QAM	25	25	21.65	21.55	21.38		
10	16QAM	50	0	21.64	21.55	21.51		
10	64QAM	1	0	22.51	22.74	22.79	23	1
10	64QAM	1	25	22.57	22.91	22.41		
10	64QAM	1	49	23.00	22.92	22.83		
10	64QAM	25	0	21.61	21.66	21.49	22	2
10	64QAM	25	12	21.73	21.59	21.54		
10	64QAM	25	25	21.67	21.70	21.74		
10	64QAM	50	0	21.67	21.59	21.32		
Channel				19975	20175	20375	Tune-up limit (dBm)	MPR (dB)
Frequency (MHz)				1712.5	1732.5	1752.5		
5	QPSK	1	0	23.22	23.18	23.03	24	0
5	QPSK	1	12	23.53	23.32	23.37		
5	QPSK	1	24	23.57	23.40	23.33		
5	QPSK	12	0	22.56	22.56	22.44	23	1
5	QPSK	12	7	22.50	22.44	22.43		
5	QPSK	12	13	22.50	22.41	22.40		
5	QPSK	25	0	22.54	22.46	22.45		
5	16QAM	1	0	22.88	22.91	22.89	23	1
5	16QAM	1	12	22.70	22.61	22.75		
5	16QAM	1	24	22.90	22.78	22.70		
5	16QAM	12	0	21.56	21.60	21.46	22	2
5	16QAM	12	7	21.51	21.50	21.48		
5	16QAM	12	13	21.51	21.45	21.42		
5	16QAM	25	0	21.50	21.46	21.43		
5	64QAM	1	0	22.60	22.68	22.80	23	1
5	64QAM	1	12	23.00	22.78	22.31		
5	64QAM	1	24	22.30	22.46	22.47		
5	64QAM	12	0	21.66	21.59	21.45	22	2
5	64QAM	12	7	21.62	21.63	21.60		
5	64QAM	12	13	21.67	21.56	21.47		
5	64QAM	25	0	21.60	21.47	21.43		



Channel				19965	20175	20385	Tune-up limit (dBm)	MPR (dB)
Frequency (MHz)				1711.5	1732.5	1753.5		
3	QPSK	1	0	23.01	23.05	22.88	24	0
3	QPSK	1	8	23.47	23.36	23.36		
3	QPSK	1	14	23.46	23.36	23.32		
3	QPSK	8	0	22.47	22.52	22.44	23	1
3	QPSK	8	4	22.50	22.42	22.41		
3	QPSK	8	7	22.49	22.38	22.39		
3	QPSK	15	0	22.47	22.37	22.38		
3	16QAM	1	0	22.78	22.80	22.73	23	1
3	16QAM	1	8	22.88	22.72	22.75		
3	16QAM	1	14	22.89	22.65	22.62		
3	16QAM	8	0	21.49	21.58	21.52	22	2
3	16QAM	8	4	21.51	21.41	21.48		
3	16QAM	8	7	21.50	21.44	21.42		
3	16QAM	15	0	21.50	21.43	21.41		
3	64QAM	1	0	22.12	22.56	22.70	23	1
3	64QAM	1	8	22.96	22.73	22.53		
3	64QAM	1	14	23.00	22.97	22.99		
3	64QAM	8	0	21.55	21.72	21.64	22	2
3	64QAM	8	4	21.86	21.68	21.63		
3	64QAM	8	7	21.80	21.52	21.38		
3	64QAM	15	0	21.48	21.48	21.46		
Channel				19957	20175	20393	Tune-up limit (dBm)	MPR (dB)
Frequency (MHz)				1710.7	1732.5	1754.3		
1.4	QPSK	1	0	22.88	22.93	22.82	24	0
1.4	QPSK	1	3	23.46	23.38	23.45		
1.4	QPSK	1	5	23.33	23.35	23.31		
1.4	QPSK	3	0	23.45	23.44	23.33		
1.4	QPSK	3	1	23.41	23.51	23.42		
1.4	QPSK	3	3	23.42	23.40	23.42		
1.4	QPSK	6	0	22.36	22.33	22.36	23	1
1.4	16QAM	1	0	22.85	22.93	22.64	23	1
1.4	16QAM	1	3	22.81	22.71	22.86		
1.4	16QAM	1	5	22.76	22.66	22.57		
1.4	16QAM	3	0	22.39	22.47	22.36		
1.4	16QAM	3	1	22.40	22.57	22.41		
1.4	16QAM	3	3	22.41	22.39	22.36		
1.4	16QAM	6	0	21.46	21.41	21.36	22	2
1.4	64QAM	1	0	22.57	22.58	22.60	23	1
1.4	64QAM	1	3	22.73	23.00	22.86		
1.4	64QAM	1	5	22.96	22.90	22.83		
1.4	64QAM	3	0	22.55	22.67	22.51		
1.4	64QAM	3	1	22.72	22.59	22.49		
1.4	64QAM	3	3	22.65	22.60	22.54		
1.4	64QAM	6	0	21.57	21.56	21.47	22	2



<LTE Band 5>

BW [MHz]	Modulation	RB Size	RB Offset	Power Low Ch. / Freq.	Power Middle Ch. / Freq.	Power High Ch. / Freq.	Tune-up limit (dBm)	MPR (dB)
Channel				20450	20525	20600		
Frequency (MHz)				829	836.5	844		
10	QPSK	1	0	23.10	23.18	23.10	24	0
10	QPSK	1	25	23.35	23.35	23.36		
10	QPSK	1	49	23.55	23.79	23.77		
10	QPSK	25	0	22.42	22.47	22.50	23	1
10	QPSK	25	12	22.52	22.60	22.40		
10	QPSK	25	25	22.45	22.52	22.52		
10	QPSK	50	0	22.47	22.58	22.52	23	1
10	16QAM	1	0	22.79	22.90	22.88		
10	16QAM	1	25	22.59	22.75	22.48		
10	16QAM	1	49	22.98	22.79	22.99	22	2
10	16QAM	25	0	21.48	21.46	21.49		
10	16QAM	25	12	21.59	21.53	21.48		
10	16QAM	25	25	21.52	21.55	21.59	23	1
10	16QAM	50	0	21.54	21.55	21.46		
10	64QAM	1	0	22.58	22.65	22.59		
10	64QAM	1	25	23.00	23.00	22.64	22	2
10	64QAM	1	49	22.99	23.00	22.73		
10	64QAM	25	0	21.64	21.53	21.68		
10	64QAM	25	12	21.72	21.74	21.67	23	1
10	64QAM	25	25	21.76	21.80	21.67		
10	64QAM	50	0	21.74	21.72	21.65		
Channel				20425	20525	20625	Tune-up limit (dBm)	MPR (dB)
Frequency (MHz)				826.5	836.5	846.5		
5	QPSK	1	0	22.91	22.89	22.97	24	0
5	QPSK	1	12	23.38	23.34	23.24		
5	QPSK	1	24	23.38	23.39	23.37		
5	QPSK	12	0	22.45	22.46	22.41	23	1
5	QPSK	12	7	22.45	22.46	22.47		
5	QPSK	12	13	22.46	22.48	22.51		
5	QPSK	25	0	22.44	22.43	22.51	23	1
5	16QAM	1	0	22.64	22.66	22.63		
5	16QAM	1	12	22.52	22.68	22.67		
5	16QAM	1	24	22.60	22.61	22.73	22	2
5	16QAM	12	0	21.55	21.52	21.48		
5	16QAM	12	7	21.51	21.50	21.50		
5	16QAM	12	13	21.53	21.54	21.52	23	1
5	16QAM	25	0	21.45	21.48	21.48		
5	64QAM	1	0	22.46	22.54	22.50		
5	64QAM	1	12	22.34	22.63	22.60	22	2
5	64QAM	1	24	22.74	22.72	22.67		
5	64QAM	12	0	21.76	21.63	21.60		
5	64QAM	12	7	21.60	21.73	21.63	23	1
5	64QAM	12	13	21.61	21.61	21.61		
5	64QAM	25	0	21.65	21.66	21.52		



Channel				20415	20525	20635	Tune-up limit (dBm)	MPR (dB)
Frequency (MHz)				825.5	836.5	847.5		
3	QPSK	1	0	22.87	22.82	22.92	24	0
3	QPSK	1	8	23.46	23.38	23.43		
3	QPSK	1	14	23.38	23.39	23.36		
3	QPSK	8	0	22.44	22.36	22.41	23	1
3	QPSK	8	4	22.48	22.41	22.49		
3	QPSK	8	7	22.39	22.38	22.41		
3	QPSK	15	0	22.46	22.40	22.45		
3	16QAM	1	0	22.64	22.73	22.66	23	1
3	16QAM	1	8	22.66	22.67	22.73		
3	16QAM	1	14	22.60	22.67	22.67		
3	16QAM	8	0	21.52	21.46	21.49	22	2
3	16QAM	8	4	21.55	21.52	21.59		
3	16QAM	8	7	21.48	21.45	21.52		
3	16QAM	15	0	21.53	21.47	21.53		
3	64QAM	1	0	22.47	22.50	22.55	23	1
3	64QAM	1	8	23.00	22.86	22.51		
3	64QAM	1	14	22.81	22.86	22.38		
3	64QAM	8	0	21.65	21.61	21.59	22	2
3	64QAM	8	4	21.67	21.68	21.71		
3	64QAM	8	7	21.66	21.65	21.51		
3	64QAM	15	0	21.66	21.58	21.71		
Channel				20407	20525	20643	Tune-up limit (dBm)	MPR (dB)
Frequency (MHz)				824.7	836.5	848.3		
1.4	QPSK	1	0	22.81	22.84	22.83	24	0
1.4	QPSK	1	3	23.40	23.38	23.46		
1.4	QPSK	1	5	23.34	23.30	23.26		
1.4	QPSK	3	0	23.33	23.35	23.35		
1.4	QPSK	3	1	23.39	23.37	23.37		
1.4	QPSK	3	3	23.42	23.36	23.31		
1.4	QPSK	6	0	22.43	22.40	22.43	23	1
1.4	16QAM	1	0	22.60	22.64	22.63	23	1
1.4	16QAM	1	3	22.69	22.73	22.77		
1.4	16QAM	1	5	22.58	22.60	22.60		
1.4	16QAM	3	0	22.35	22.41	22.42		
1.4	16QAM	3	1	22.37	22.42	22.47		
1.4	16QAM	3	3	22.35	22.34	22.39		
1.4	16QAM	6	0	21.47	21.46	21.42	22	2
1.4	64QAM	1	0	22.47	22.46	22.52	23	1
1.4	64QAM	1	3	22.89	22.90	23.00		
1.4	64QAM	1	5	22.61	22.83	22.94		
1.4	64QAM	3	0	22.61	22.76	22.76		
1.4	64QAM	3	1	22.86	22.90	22.78		
1.4	64QAM	3	3	22.69	22.54	22.63		
1.4	64QAM	6	0	21.67	21.67	21.59	22	2



<LTE Band 12>

BW [MHz]	Modulation	RB Size	RB Offset	Power Low Ch. / Freq.	Power Middle Ch. / Freq.	Power High Ch. / Freq.	Tune-up limit (dBm)	MPR (dB)
Channel				23060	23095	23130		
Frequency (MHz)				704	707.5	711		
10	QPSK	1	0	23.42	23.43	23.37	24	0
10	QPSK	1	25	23.20	23.34	23.12		
10	QPSK	1	49	23.39	23.46	23.26		
10	QPSK	25	0	22.92	22.87	22.81	23	1
10	QPSK	25	12	22.94	22.97	22.84		
10	QPSK	25	25	22.91	22.92	22.83		
10	QPSK	50	0	22.18	22.39	21.99	23	1
10	16QAM	1	0	22.33	22.71	22.31		
10	16QAM	1	25	22.48	22.68	22.32		
10	16QAM	1	49	22.35	22.64	22.23	22	2
10	16QAM	25	0	21.90	21.84	21.83		
10	16QAM	25	12	22.00	21.98	21.87		
10	16QAM	25	25	21.86	21.93	21.83	23	1
10	16QAM	50	0	21.27	21.50	21.07		
10	64QAM	1	0	22.88	22.78	22.90		
10	64QAM	1	25	22.71	22.50	22.50	22	2
10	64QAM	1	49	22.58	22.57	22.54		
10	64QAM	25	0	21.77	21.73	21.55		
10	64QAM	25	12	21.62	21.61	21.54	23	1
10	64QAM	25	25	21.65	21.45	21.41		
10	64QAM	50	0	21.75	21.56	21.61		
Channel				23035	23095	23155	Tune-up limit (dBm)	MPR (dB)
Frequency (MHz)				701.5	707.5	713.5		
5	QPSK	1	0	23.20	22.97	22.82	24	0
5	QPSK	1	12	23.45	23.10	22.99		
5	QPSK	1	24	23.32	23.11	23.00		
5	QPSK	12	0	22.43	22.22	21.99	23	1
5	QPSK	12	7	22.46	22.23	22.06		
5	QPSK	12	13	22.38	22.13	22.01		
5	QPSK	25	0	22.39	22.18	22.05	23	1
5	16QAM	1	0	22.59	22.51	22.42		
5	16QAM	1	12	22.85	22.43	22.30		
5	16QAM	1	24	22.59	22.42	22.38	22	2
5	16QAM	12	0	21.43	21.28	21.11		
5	16QAM	12	7	21.46	21.27	21.09		
5	16QAM	12	13	21.39	21.19	21.07	23	1
5	16QAM	25	0	21.41	21.23	21.06		
5	64QAM	1	0	22.68	22.66	22.52		
5	64QAM	1	12	22.73	22.80	22.76	22	2
5	64QAM	1	24	22.53	22.46	22.84		
5	64QAM	12	0	21.66	21.46	21.56		
5	64QAM	12	7	21.49	21.59	21.40	23	1
5	64QAM	12	13	21.74	21.50	21.34		
5	64QAM	25	0	21.74	21.64	21.46		



Channel				23025	23095	23165	Tune-up limit (dBm)	MPR (dB)
Frequency (MHz)				700.5	707.5	714.5		
3	QPSK	1	0	23.23	23.05	22.86	24	0
3	QPSK	1	8	23.28	23.14	23.02		
3	QPSK	1	14	23.28	23.17	23.12		
3	QPSK	8	0	22.40	22.17	22.18	23	1
3	QPSK	8	4	22.34	22.19	22.09		
3	QPSK	8	7	22.37	22.14	22.06		
3	QPSK	15	0	22.43	22.22	22.13		
3	16QAM	1	0	22.68	22.49	22.33	23	1
3	16QAM	1	8	22.54	22.32	22.28		
3	16QAM	1	14	22.54	22.36	22.32		
3	16QAM	8	0	21.41	21.19	21.17	22	2
3	16QAM	8	4	21.37	21.27	21.13		
3	16QAM	8	7	21.39	21.23	21.03		
3	16QAM	15	0	21.41	21.24	21.12		
3	64QAM	1	0	22.81	22.69	22.56	23	1
3	64QAM	1	8	22.20	22.34	22.11		
3	64QAM	1	14	22.99	22.65	22.38		
3	64QAM	8	0	21.65	21.53	21.36	22	2
3	64QAM	8	4	21.67	21.58	21.26		
3	64QAM	8	7	21.61	21.49	21.26		
3	64QAM	15	0	21.78	21.53	21.37		
Channel				23017	23095	23173	Tune-up limit (dBm)	MPR (dB)
Frequency (MHz)				699.7	707.5	715.3		
1.4	QPSK	1	0	23.23	22.84	22.75	24	0
1.4	QPSK	1	3	23.34	23.22	23.02		
1.4	QPSK	1	5	23.28	23.07	23.00		
1.4	QPSK	3	0	22.46	22.31	22.24		
1.4	QPSK	3	1	22.33	22.24	22.22		
1.4	QPSK	3	3	22.32	22.18	22.10		
1.4	QPSK	6	0	22.43	22.18	22.20	23	1
1.4	16QAM	1	0	22.87	22.77	22.72	23	1
1.4	16QAM	1	3	22.55	22.42	22.37		
1.4	16QAM	1	5	22.66	22.58	22.50		
1.4	16QAM	3	0	21.49	21.37	21.23		
1.4	16QAM	3	1	21.41	21.29	21.23		
1.4	16QAM	3	3	21.33	21.19	21.13		
1.4	16QAM	6	0	21.40	21.19	21.28	22	2
1.4	64QAM	1	0	22.85	22.47	22.66	23	1
1.4	64QAM	1	3	22.86	22.66	22.39		
1.4	64QAM	1	5	22.61	22.62	22.41		
1.4	64QAM	3	0	22.60	22.67	22.59		
1.4	64QAM	3	1	22.81	22.83	22.48		
1.4	64QAM	3	3	22.68	22.70	22.55		
1.4	64QAM	6	0	21.50	21.53	21.28	22	2



<LTE Band 13>

BW [MHz]	Modulation	RB Size	RB Offset	Power Low Ch. / Freq.	Power Middle Ch. / Freq.	Power High Ch. / Freq.	Tune-up limit (dBm)	MPR (dB)
Channel				23230				
Frequency (MHz)				782				
10	QPSK	1	0		23.18		24	0
10	QPSK	1	25		23.37			
10	QPSK	1	49		23.52			
10	QPSK	25	0		22.55		23	1
10	QPSK	25	12		22.49			
10	QPSK	25	25		22.36			
10	QPSK	50	0		22.46		23	1
10	16QAM	1	0		22.80			
10	16QAM	1	25		22.41			
10	16QAM	1	49		22.91		22	2
10	16QAM	25	0		21.52			
10	16QAM	25	12		21.53			
10	16QAM	25	25		21.35		23	1
10	16QAM	50	0		21.49			
10	64QAM	1	0		22.77			
10	64QAM	1	25		22.47		22	2
10	64QAM	1	49		22.81			
10	64QAM	25	0		21.58			
10	64QAM	25	12		21.71		23	1
10	64QAM	25	25		21.66			
10	64QAM	50	0	21.70				
Channel				23205	23230	23255	Tune-up limit (dBm)	MPR (dB)
Frequency (MHz)				779.5	782	784.5		
5	QPSK	1	0	22.82	22.85	22.82	24	0
5	QPSK	1	12	23.23	23.32	23.27		
5	QPSK	1	24	23.45	23.31	23.33		
5	QPSK	12	0	22.38	22.37	22.36	23	1
5	QPSK	12	7	22.33	22.28	22.33		
5	QPSK	12	13	22.34	22.41	22.31		
5	QPSK	25	0	22.49	22.41	22.34	23	1
5	16QAM	1	0	22.51	22.71	22.59		
5	16QAM	1	12	22.61	22.39	22.55		
5	16QAM	1	24	22.68	22.64	22.71	22	2
5	16QAM	12	0	21.42	21.42	21.37		
5	16QAM	12	7	21.32	21.33	21.32		
5	16QAM	12	13	21.38	21.36	21.33	23	1
5	16QAM	25	0	21.53	21.33	21.36		
5	64QAM	1	0	22.30	22.38	22.41		
5	64QAM	1	12	22.51	22.55	23.00	22	2
5	64QAM	1	24	22.63	22.45	22.95		
5	64QAM	12	0	21.40	21.58	21.38		
5	64QAM	12	7	21.47	21.60	21.52	23	1
5	64QAM	12	13	21.51	21.34	21.41		
5	64QAM	25	0	21.58	21.58	21.66		



<LTE Band 66>

BW [MHz]	Modulation	RB Size	RB Offset	Power Low Ch. / Freq.	Power Middle Ch. / Freq.	Power High Ch. / Freq.	Tune-up limit (dBm)	MPR (dB)
Channel				132072	132322	132572		
Frequency (MHz)				1720	1745	1770		
20	QPSK	1	0	23.44	23.37	23.28		
20	QPSK	1	49	23.51	23.44	23.33	24	0
20	QPSK	1	99	23.84	23.90	23.85		
20	QPSK	50	0	22.71	22.76	22.55		
20	QPSK	50	24	22.64	22.54	22.55	23	1
20	QPSK	50	50	22.67	22.63	22.48		
20	QPSK	100	0	22.65	22.70	22.65		
20	16QAM	1	0	22.96	22.91	22.92	23	1
20	16QAM	1	49	22.88	22.81	22.80		
20	16QAM	1	99	22.95	22.94	22.89		
20	16QAM	50	0	21.68	21.58	21.53	22	2
20	16QAM	50	24	21.64	21.54	21.54		
20	16QAM	50	50	21.67	21.58	21.56		
20	16QAM	100	0	21.62	21.55	21.57	23	1
20	64QAM	1	0	22.10	22.38	22.46		
20	64QAM	1	49	22.21	22.31	22.32		
20	64QAM	1	99	22.69	22.76	21.80	22	2
20	64QAM	50	0	21.36	21.21	21.24		
20	64QAM	50	24	21.51	21.46	21.31		
20	64QAM	50	50	21.36	21.37	21.26	22	2
20	64QAM	100	0	21.46	21.43	21.36		
Channel				132047	132322	132597		
Frequency (MHz)				1717.5	1745	1772.5	Tune-up limit (dBm)	MPR (dB)
15	QPSK	1	0	23.78	23.82	23.77	24	0
15	QPSK	1	37	23.58	23.19	23.32		
15	QPSK	1	74	23.78	23.79	23.51		
15	QPSK	36	0	22.73	22.62	22.59	23	1
15	QPSK	36	20	22.67	22.51	22.52		
15	QPSK	36	39	22.58	22.45	22.54		
15	QPSK	75	0	22.68	22.54	22.57	23	1
15	16QAM	1	0	22.95	22.65	22.95		
15	16QAM	1	37	22.50	22.86	22.90		
15	16QAM	1	74	22.90	22.97	22.90	22	2
15	16QAM	36	0	21.75	21.57	21.62		
15	16QAM	36	20	21.68	21.51	21.48		
15	16QAM	36	39	21.53	21.44	21.39	23	1
15	16QAM	75	0	21.69	21.57	21.59		
15	64QAM	1	0	22.56	22.78	22.76		
15	64QAM	1	37	22.38	22.71	22.29	22	2
15	64QAM	1	74	22.57	22.59	22.00		
15	64QAM	36	0	21.45	21.38	21.44		
15	64QAM	36	20	21.45	21.36	21.53	22	2
15	64QAM	36	39	21.32	21.35	21.16		
15	64QAM	75	0	21.34	21.47	21.14		



Channel				132022	132322	132622	Tune-up limit (dBm)	MPR (dB)
Frequency (MHz)				1715	1745	1775		
10	QPSK	1	0	22.65	22.55	22.56	24	0
10	QPSK	1	25	23.30	23.18	23.17		
10	QPSK	1	49	23.21	23.34	23.25		
10	QPSK	25	0	22.33	22.25	22.27	23	1
10	QPSK	25	12	22.40	22.30	22.31		
10	QPSK	25	25	22.46	22.44	22.45		
10	QPSK	50	0	22.36	22.29	22.25		
10	16QAM	1	0	22.41	22.50	22.31	23	1
10	16QAM	1	25	22.59	22.53	22.55		
10	16QAM	1	49	22.90	22.93	22.91		
10	16QAM	25	0	21.33	21.27	21.23	22	2
10	16QAM	25	12	21.44	21.32	21.29		
10	16QAM	25	25	21.45	21.35	21.46		
10	16QAM	50	0	21.36	21.29	21.21		
10	64QAM	1	0	21.74	21.89	21.85	23	1
10	64QAM	1	25	22.13	22.18	22.21		
10	64QAM	1	49	22.60	22.28	21.75		
10	64QAM	25	0	21.13	21.12	21.08	22	2
10	64QAM	25	12	21.32	21.20	21.03		
10	64QAM	25	25	21.26	21.25	20.88		
10	64QAM	50	0	21.24	21.29	21.26		
Channel				131997	132322	132647	Tune-up limit (dBm)	MPR (dB)
Frequency (MHz)				1712.5	1745	1777.5		
5	QPSK	1	0	23.20	23.20	23.11	24	0
5	QPSK	1	12	23.31	23.17	23.16		
5	QPSK	1	24	23.31	23.21	23.18		
5	QPSK	12	0	22.38	22.31	22.33	23	1
5	QPSK	12	7	22.36	22.23	22.26		
5	QPSK	12	13	22.33	22.30	22.23		
5	QPSK	25	0	22.36	22.26	22.28		
5	16QAM	1	0	22.68	22.73	22.60	23	1
5	16QAM	1	12	22.61	22.65	22.49		
5	16QAM	1	24	22.73	22.53	22.64		
5	16QAM	12	0	21.38	21.37	21.34	22	2
5	16QAM	12	7	21.36	21.27	21.28		
5	16QAM	12	13	21.33	21.32	21.24		
5	16QAM	25	0	21.35	21.24	21.29		
5	64QAM	1	0	21.97	22.14	22.04	23	1
5	64QAM	1	12	21.96	22.35	22.10		
5	64QAM	1	24	22.50	22.43	22.29		
5	64QAM	12	0	21.25	21.20	21.14	22	2
5	64QAM	12	7	21.21	21.25	21.09		
5	64QAM	12	13	21.19	21.16	21.10		
5	64QAM	25	0	21.26	21.30	21.12		



Channel				131987	132322	132657	Tune-up limit (dBm)	MPR (dB)
Frequency (MHz)				1711.5	1745	1778.5		
3	QPSK	1	0	23.12	23.07	23.03	24	0
3	QPSK	1	8	23.28	23.21	23.18		
3	QPSK	1	14	23.21	23.22	23.09		
3	QPSK	8	0	22.33	22.24	22.22	23	1
3	QPSK	8	4	22.29	22.22	22.24		
3	QPSK	8	7	22.30	22.30	22.20		
3	QPSK	15	0	22.29	22.20	22.22		
3	16QAM	1	0	22.71	22.57	22.65	23	1
3	16QAM	1	8	22.69	22.55	22.49		
3	16QAM	1	14	22.75	22.55	22.42		
3	16QAM	8	0	21.36	21.30	21.26	22	2
3	16QAM	8	4	21.35	21.28	21.25		
3	16QAM	8	7	21.32	21.32	21.21		
3	16QAM	15	0	21.31	21.21	21.22		
3	64QAM	1	0	22.31	22.49	22.70	23	1
3	64QAM	1	8	22.34	22.96	22.66		
3	64QAM	1	14	22.29	22.66	22.47		
3	64QAM	8	0	21.25	21.30	21.12	22	2
3	64QAM	8	4	21.24	21.28	21.06		
3	64QAM	8	7	21.21	21.20	21.07		
3	64QAM	15	0	21.21	21.24	21.07		
Channel				131979	132322	132665	Tune-up limit (dBm)	MPR (dB)
Frequency (MHz)				1710.7	1745	1779.3		
1.4	QPSK	1	0	22.98	22.93	22.90	24	0
1.4	QPSK	1	3	23.26	23.25	23.21		
1.4	QPSK	1	5	23.21	23.22	23.12		
1.4	QPSK	3	0	23.27	23.19	23.10		
1.4	QPSK	3	1	23.28	23.23	23.19		
1.4	QPSK	3	3	23.28	23.20	23.11		
1.4	QPSK	6	0	22.21	22.16	22.17	23	1
1.4	16QAM	1	0	22.55	22.53	22.45	23	1
1.4	16QAM	1	3	22.75	22.52	22.52		
1.4	16QAM	1	5	22.49	22.52	22.47		
1.4	16QAM	3	0	22.23	22.19	22.15		
1.4	16QAM	3	1	22.29	22.23	22.18		
1.4	16QAM	3	3	22.24	22.17	22.18		
1.4	16QAM	6	0	21.34	21.20	21.14	22	2
1.4	64QAM	1	0	22.88	22.59	22.63	23	1
1.4	64QAM	1	3	22.78	22.64	22.61		
1.4	64QAM	1	5	22.47	22.68	22.00		
1.4	64QAM	3	0	22.09	22.02	22.08		
1.4	64QAM	3	1	22.09	22.15	22.17		
1.4	64QAM	3	3	21.96	21.99	21.80		
1.4	64QAM	6	0	21.98	22.00	21.78	22	2



<LTE Band 71>

BW [MHz]	Modulation	RB Size	RB Offset	Power Low Ch. / Freq.	Power Middle Ch. / Freq.	Power High Ch. / Freq.	Tune-up limit (dBm)	MPR (dB)
Channel				133222	133322	133372		
Frequency (MHz)				673	683	688		
20	QPSK	1	0	23.29	23.53	23.50		
20	QPSK	1	49	24.42	24.59	24.57	25	0
20	QPSK	1	99	24.52	24.54	24.33		
20	QPSK	50	0	22.68	22.58	22.64		
20	QPSK	50	24	23.04	23.11	23.04	24	1
20	QPSK	50	50	23.03	23.01	22.94		
20	QPSK	100	0	22.84	22.89	22.88		
20	16QAM	1	0	22.12	22.17	22.43	24	1
20	16QAM	1	49	23.25	23.31	23.38		
20	16QAM	1	99	23.44	23.12	23.19		
20	16QAM	50	0	21.52	21.58	21.75	23	2
20	16QAM	50	24	22.01	22.05	22.08		
20	16QAM	50	50	22.00	22.03	21.97		
20	16QAM	100	0	21.89	21.78	21.84	24	1
20	64QAM	1	0	22.32	22.45	22.51		
20	64QAM	1	49	23.41	23.54	23.46		
20	64QAM	1	99	23.12	23.33	23.21	23	2
20	64QAM	50	0	22.00	22.04	22.01		
20	64QAM	50	24	22.39	22.44	22.41		
20	64QAM	50	50	22.19	22.27	22.26	23	2
20	64QAM	100	0	22.12	22.23	22.20		
Channel				133197	133297	133397		
Frequency (MHz)				670.5	680.5	690.5		
15	QPSK	1	0	24.08	24.55	24.31	25	0
15	QPSK	1	37	24.10	24.50	24.40		
15	QPSK	1	74	24.42	24.58	24.57		
15	QPSK	36	0	22.78	22.99	22.80	24	1
15	QPSK	36	20	22.89	23.15	23.09		
15	QPSK	36	39	23.01	23.08	22.92		
15	QPSK	75	0	22.91	23.00	22.95	24	1
15	16QAM	1	0	22.70	22.99	22.97		
15	16QAM	1	37	23.03	22.87	22.85		
15	16QAM	1	74	23.21	23.18	23.19	23	2
15	16QAM	36	0	21.75	22.00	21.87		
15	16QAM	36	20	21.94	22.09	22.08		
15	16QAM	36	39	21.99	22.03	21.88	24	1
15	16QAM	75	0	21.79	22.06	21.93		
15	64QAM	1	0	23.09	23.16	23.15		
15	64QAM	1	37	23.19	23.36	23.32	23	2
15	64QAM	1	74	23.24	23.30	23.28		
15	64QAM	36	0	22.18	22.28	22.25		
15	64QAM	36	20	22.41	22.46	22.44	23	2
15	64QAM	36	39	22.32	22.35	22.34		
15	64QAM	75	0	22.28	22.37	22.31		



Channel				133172	133297	133422	Tune-up limit (dBm)	MPR (dB)
Frequency (MHz)				668	680.5	693		
10	QPSK	1	0	23.15	23.38	23.33	25	0
10	QPSK	1	25	23.90	24.37	24.16		
10	QPSK	1	49	24.35	24.58	24.47		
10	QPSK	25	0	22.31	22.51	22.53	24	1
10	QPSK	25	12	22.51	22.85	22.58		
10	QPSK	25	25	22.64	22.75	22.76		
10	QPSK	50	0	22.42	22.70	22.60		
10	16QAM	1	0	22.07	22.39	22.27	24	1
10	16QAM	1	25	22.54	22.84	22.65		
10	16QAM	1	49	23.01	23.21	23.08		
10	16QAM	25	0	21.40	21.60	21.55	23	2
10	16QAM	25	12	21.57	21.86	21.67		
10	16QAM	25	25	21.61	21.77	21.76		
10	16QAM	50	0	21.44	21.70	21.61		
10	64QAM	1	0	22.21	22.23	22.25	24	1
10	64QAM	1	25	22.85	22.89	22.88		
10	64QAM	1	49	23.40	23.42	23.38		
10	64QAM	25	0	22.00	22.03	22.02	23	2
10	64QAM	25	12	22.07	22.11	22.10		
10	64QAM	25	25	22.05	22.13	22.16		
10	64QAM	50	0	22.06	22.03	22.05		
Channel				133147	133297	133447	Tune-up limit (dBm)	MPR (dB)
Frequency (MHz)				665.5	680.5	695.5		
5	QPSK	1	0	23.90	24.31	24.17	25	0
5	QPSK	1	12	23.77	24.22	24.09		
5	QPSK	1	24	24.04	24.35	24.18		
5	QPSK	12	0	22.41	22.77	22.73	24	1
5	QPSK	12	7	22.48	22.86	22.66		
5	QPSK	12	13	22.46	22.83	22.59		
5	QPSK	25	0	22.40	22.77	22.71		
5	16QAM	1	0	22.53	22.95	22.83	24	1
5	16QAM	1	12	22.39	23.05	22.95		
5	16QAM	1	24	22.66	22.96	22.76		
5	16QAM	12	0	21.44	21.76	21.75	23	2
5	16QAM	12	7	21.52	21.87	21.65		
5	16QAM	12	13	21.41	21.83	21.59		
5	16QAM	25	0	21.49	21.80	21.69		
5	64QAM	1	0	22.89	23.03	23.02	24	1
5	64QAM	1	12	23.11	23.18	23.15		
5	64QAM	1	24	23.03	23.15	23.16		
5	64QAM	12	0	22.00	22.06	22.03	23	2
5	64QAM	12	7	22.10	22.13	22.10		
5	64QAM	12	13	22.01	22.07	22.06		
5	64QAM	25	0	22.00	22.06	22.04		



<Reduced Power Mode for Hotspot On/P-Sensor On>

<LTE Band 2>

BW [MHz]	Modulation	RB Size	RB Offset	Power Low Ch. / Freq.	Power Middle Ch. / Freq.	Power High Ch. / Freq.	Tune-up limit (dBm)	MPR (dB)
Channel				18700	18900	19100		
Frequency (MHz)				1860	1880	1900		
20	QPSK	1	0	15.03	15.08	14.96	15.5	0
20	QPSK	1	49	14.67	14.61	14.67		
20	QPSK	1	99	15.08	15.23	15.10		
20	QPSK	50	0	14.94	14.96	14.95	15.5	0
20	QPSK	50	24	14.71	14.71	14.77		
20	QPSK	50	50	14.85	14.80	14.92		
20	QPSK	100	0	14.88	14.96	14.94	15.5	0
20	16QAM	1	0	15.17	15.17	15.06		
20	16QAM	1	49	14.89	14.50	15.01		
20	16QAM	1	99	15.06	15.18	15.18	15.5	0
20	16QAM	50	0	14.90	14.82	14.89		
20	16QAM	50	24	14.66	14.71	14.85		
20	16QAM	50	50	14.86	14.89	14.90	15.5	0
20	16QAM	100	0	14.79	14.80	14.92		
20	64QAM	1	0	15.19	15.12	15.17		
20	64QAM	1	49	14.91	14.72	14.88	15.5	0
20	64QAM	1	99	15.17	15.01	15.18		
20	64QAM	50	0	14.83	14.75	14.86		
20	64QAM	50	24	14.74	14.59	14.84	15.5	0
20	64QAM	50	50	14.83	14.73	14.80		
20	64QAM	100	0	14.72	14.69	14.92		
Channel				18675	18900	19125	Tune-up limit (dBm)	MPR (dB)
Frequency (MHz)				1857.5	1880	1902.5		
15	QPSK	1	0	15.12	15.18	15.02	15.5	0
15	QPSK	1	37	14.69	15.21	14.58		
15	QPSK	1	74	15.07	15.08	15.20		
15	QPSK	36	0	14.84	14.81	14.85	15.5	0
15	QPSK	36	20	14.74	14.54	14.81		
15	QPSK	36	39	14.85	14.86	14.95		
15	QPSK	75	0	14.86	14.77	14.92	15.5	0
15	16QAM	1	0	15.16	15.13	15.08		
15	16QAM	1	37	14.96	14.74	14.63		
15	16QAM	1	74	15.14	15.13	15.20	15.5	0
15	16QAM	36	0	14.80	14.80	14.68		
15	16QAM	36	20	14.75	14.72	14.82		
15	16QAM	36	39	14.87	14.80	14.89	15.5	0
15	16QAM	75	0	14.83	14.82	14.92		
15	64QAM	1	0	15.20	14.90	15.16		
15	64QAM	1	37	14.39	14.52	14.51	15.5	0
15	64QAM	1	74	15.20	15.13	15.13		
15	64QAM	36	0	14.75	14.77	14.79		
15	64QAM	36	20	14.69	14.72	14.76	15.5	0
15	64QAM	36	39	14.79	14.61	14.72		
15	64QAM	75	0	14.75	14.67	14.87		



Channel				18650	18900	19150	Tune-up limit (dBm)	MPR (dB)
Frequency (MHz)				1855	1880	1905		
10	QPSK	1	0	14.95	15.07	14.95	15.5	0
10	QPSK	1	25	14.62	14.56	14.70		
10	QPSK	1	49	14.93	14.87	15.03		
10	QPSK	25	0	14.86	14.76	14.85	15.5	0
10	QPSK	25	12	14.77	14.76	14.92		
10	QPSK	25	25	14.89	14.92	14.85		
10	QPSK	50	0	14.81	14.82	14.93		
10	16QAM	1	0	15.19	15.19	15.15	15.5	0
10	16QAM	1	25	14.92	14.81	14.97		
10	16QAM	1	49	15.16	15.20	15.05		
10	16QAM	25	0	14.87	14.84	14.83	15.5	0
10	16QAM	25	12	14.80	14.73	14.85		
10	16QAM	25	25	14.84	14.90	15.02		
10	16QAM	50	0	14.88	14.74	14.87		
10	64QAM	1	0	15.18	15.12	15.12	15.5	0
10	64QAM	1	25	14.67	14.55	14.89		
10	64QAM	1	49	15.08	14.96	15.03		
10	64QAM	25	0	14.87	14.62	14.89	15.5	0
10	64QAM	25	12	14.70	14.60	14.71		
10	64QAM	25	25	14.73	14.66	14.79		
10	64QAM	50	0	14.81	14.82	14.88		
Channel				18625	18900	19175	Tune-up limit (dBm)	MPR (dB)
Frequency (MHz)				1852.5	1880	1907.5		
5	QPSK	1	0	14.81	14.84	14.82	15.5	0
5	QPSK	1	12	14.61	14.68	14.72		
5	QPSK	1	24	14.65	14.74	14.76		
5	QPSK	12	0	14.82	14.76	14.87	15.5	0
5	QPSK	12	7	14.80	14.66	14.87		
5	QPSK	12	13	14.84	14.73	14.82		
5	QPSK	25	0	14.81	14.68	14.88		
5	16QAM	1	0	15.10	15.00	15.05	15.5	0
5	16QAM	1	12	15.03	14.73	14.91		
5	16QAM	1	24	14.91	14.95	15.01		
5	16QAM	12	0	14.79	14.79	14.92	15.5	0
5	16QAM	12	7	14.86	14.66	14.86		
5	16QAM	12	13	14.81	14.73	14.88		
5	16QAM	25	0	14.78	14.71	14.84		
5	64QAM	1	0	14.90	14.82	14.80	15.5	0
5	64QAM	1	12	14.84	14.63	14.65		
5	64QAM	1	24	14.76	14.43	14.76		
5	64QAM	12	0	14.79	14.64	14.73	15.5	0
5	64QAM	12	7	14.80	14.58	14.74		
5	64QAM	12	13	14.69	14.48	14.70		
5	64QAM	25	0	14.80	14.54	14.77		



Channel				18615	18900	19185	Tune-up limit (dBm)	MPR (dB)
Frequency (MHz)				1851.5	1880	1908.5		
3	QPSK	1	0	14.69	14.75	14.79	15.5	0
3	QPSK	1	8	14.63	14.59	14.72		
3	QPSK	1	14	14.60	14.63	14.61		
3	QPSK	8	0	14.75	14.64	14.79	15.5	0
3	QPSK	8	4	14.74	14.67	14.78		
3	QPSK	8	7	14.71	14.57	14.79		
3	QPSK	15	0	14.70	14.64	14.74		
3	16QAM	1	0	14.99	14.86	15.09	15.5	0
3	16QAM	1	8	14.91	14.79	15.06		
3	16QAM	1	14	14.88	14.91	14.85		
3	16QAM	8	0	14.80	14.69	14.85	15.5	0
3	16QAM	8	4	14.81	14.68	14.82		
3	16QAM	8	7	14.78	14.66	14.86		
3	16QAM	15	0	14.76	14.66	14.81		
3	64QAM	1	0	14.77	14.76	14.81		
3	64QAM	1	8	14.76	14.61	14.84	15.5	0
3	64QAM	1	14	14.65	14.69	14.84		
3	64QAM	8	0	14.73	14.65	14.74		
3	64QAM	8	4	14.70	14.64	14.73	15.5	0
3	64QAM	8	7	14.71	14.56	14.75		
3	64QAM	8	7	14.71	14.56	14.75		
3	64QAM	15	0	14.73	14.60	14.75		
Channel				18607	18900	19193	Tune-up limit (dBm)	MPR (dB)
Frequency (MHz)				1850.7	1880	1909.3		
1.4	QPSK	1	0	14.58	14.71	14.65	15.5	0
1.4	QPSK	1	3	14.71	14.58	14.75		
1.4	QPSK	1	5	14.59	14.47	14.65		
1.4	QPSK	3	0	14.64	14.58	14.59		
1.4	QPSK	3	1	14.66	14.59	14.70		
1.4	QPSK	3	3	14.63	14.51	14.65		
1.4	QPSK	6	0	14.71	14.60	14.69	15.5	0
1.4	16QAM	1	0	14.82	14.64	14.87	15.5	0
1.4	16QAM	1	3	15.01	14.80	14.95		
1.4	16QAM	1	5	14.84	14.68	14.86		
1.4	16QAM	3	0	14.67	14.60	14.76		
1.4	16QAM	3	1	14.73	14.62	14.74		
1.4	16QAM	3	3	14.67	14.52	14.71		
1.4	16QAM	6	0	14.76	14.67	14.77	15.5	0
1.4	64QAM	1	0	14.84	14.74	14.79	15.5	0
1.4	64QAM	1	3	14.62	14.57	14.90		
1.4	64QAM	1	5	14.78	14.69	14.73		
1.4	64QAM	3	0	14.70	14.58	14.68		
1.4	64QAM	3	1	14.79	14.58	14.67		
1.4	64QAM	3	3	14.60	14.53	14.66		
1.4	64QAM	6	0	14.65	14.58	14.70	15.5	0



<LTE Band 4>

BW [MHz]	Modulation	RB Size	RB Offset	Power Low Ch. / Freq.	Power Middle Ch. / Freq.	Power High Ch. / Freq.	Tune-up limit (dBm)	MPR (dB)
Channel				20050	20175	20300		
Frequency (MHz)				1720	1732.5	1745		
20	QPSK	1	0	16.97	16.94	16.89	17.5	0
20	QPSK	1	49	16.80	16.88	16.76		
20	QPSK	1	99	16.98	16.99	17.31		
20	QPSK	50	0	16.99	16.99	16.89	17.5	0
20	QPSK	50	24	16.83	16.94	16.86		
20	QPSK	50	50	16.80	16.86	16.84		
20	QPSK	100	0	16.84	16.81	16.83		
20	16QAM	1	0	17.22	17.14	17.23	17.5	0
20	16QAM	1	49	17.10	17.30	17.12		
20	16QAM	1	99	17.22	17.11	16.88		
20	16QAM	50	0	17.01	16.99	16.93	17.5	0
20	16QAM	50	24	16.83	16.96	16.89		
20	16QAM	50	50	16.88	16.84	16.86		
20	16QAM	100	0	16.84	16.85	16.85		
20	64QAM	1	0	16.64	16.54	16.53	17.5	0
20	64QAM	1	49	16.53	16.61	16.50		
20	64QAM	1	99	16.63	16.46	16.59		
20	64QAM	50	0	16.41	16.45	16.35	17.5	0
20	64QAM	50	24	16.35	16.37	16.32		
20	64QAM	50	50	16.29	16.24	16.37		
20	64QAM	100	0	16.33	16.28	16.32		
Channel				20025	20175	20325	Tune-up limit (dBm)	MPR (dB)
Frequency (MHz)				1717.5	1732.5	1747.5		
15	QPSK	1	0	17.13	17.13	17.02	17.5	0
15	QPSK	1	37	16.74	16.76	16.89		
15	QPSK	1	74	16.90	16.88	16.88		
15	QPSK	36	0	17.00	17.04	16.91	17.5	0
15	QPSK	36	20	16.89	16.87	16.93		
15	QPSK	36	39	16.84	16.85	16.83		
15	QPSK	75	0	16.87	16.87	16.93		
15	16QAM	1	0	17.20	17.20	17.12	17.5	0
15	16QAM	1	37	16.93	17.18	17.27		
15	16QAM	1	74	17.21	17.19	17.15		
15	16QAM	36	0	17.03	17.00	16.94	17.5	0
15	16QAM	36	20	16.86	16.89	16.91		
15	16QAM	36	39	16.85	16.83	16.79		
15	16QAM	75	0	16.90	16.88	16.92		
15	64QAM	1	0	16.76	16.72	16.65	17.5	0
15	64QAM	1	37	16.43	16.52	16.25		
15	64QAM	1	74	16.52	16.47	16.57		
15	64QAM	36	0	16.42	16.43	16.40	17.5	0
15	64QAM	36	20	16.29	16.35	16.39		
15	64QAM	36	39	16.32	16.23	16.37		
15	64QAM	75	0	16.34	16.30	16.34		



Channel				20000	20175	20350	Tune-up limit (dBm)	MPR (dB)
Frequency (MHz)				1715	1732.5	1750		
10	QPSK	1	0	17.22	17.17	17.19	17.5	0
10	QPSK	1	25	16.90	16.99	16.94		
10	QPSK	1	49	17.27	17.18	17.22		
10	QPSK	25	0	17.16	17.10	17.15	17.5	0
10	QPSK	25	12	17.04	17.09	17.04		
10	QPSK	25	25	17.18	17.17	17.11		
10	QPSK	50	0	17.11	17.07	17.11		
10	16QAM	1	0	17.28	17.29	17.26	17.5	0
10	16QAM	1	25	17.25	17.13	17.23		
10	16QAM	1	49	17.20	17.23	17.27		
10	16QAM	25	0	17.10	17.05	17.16	17.5	0
10	16QAM	25	12	17.05	17.08	17.06		
10	16QAM	25	25	17.21	17.11	17.07		
10	16QAM	50	0	17.11	17.16	17.14		
10	64QAM	1	0	17.02	16.97	16.88	17.5	0
10	64QAM	1	25	16.71	16.56	16.50		
10	64QAM	1	49	17.18	17.17	17.11		
10	64QAM	25	0	16.58	16.59	16.56	17.5	0
10	64QAM	25	12	16.57	16.61	16.56		
10	64QAM	25	25	16.76	16.53	16.57		
10	64QAM	50	0	16.67	16.58	16.53		
Channel				19975	20175	20375	Tune-up limit (dBm)	MPR (dB)
Frequency (MHz)				1712.5	1732.5	1752.5		
5	QPSK	1	0	17.03	17.03	17.00	17.5	0
5	QPSK	1	12	17.12	16.98	16.97		
5	QPSK	1	24	16.99	16.96	16.96		
5	QPSK	12	0	17.05	17.10	17.04	17.5	0
5	QPSK	12	7	17.03	17.04	17.05		
5	QPSK	12	13	17.02	17.01	17.03		
5	QPSK	25	0	17.04	17.06	17.05		
5	16QAM	1	0	17.12	17.16	17.17	17.5	0
5	16QAM	1	12	17.30	17.29	17.26		
5	16QAM	1	24	17.28	17.22	17.25		
5	16QAM	12	0	17.12	17.14	17.07	17.5	0
5	16QAM	12	7	17.02	17.07	17.10		
5	16QAM	12	13	17.04	17.04	17.02		
5	16QAM	25	0	17.07	17.07	17.09		
5	64QAM	1	0	16.80	16.74	16.66	17.5	0
5	64QAM	1	12	16.66	16.67	16.67		
5	64QAM	1	24	16.71	16.55	16.56		
5	64QAM	12	0	16.62	16.60	16.52	17.5	0
5	64QAM	12	7	16.59	16.51	16.59		
5	64QAM	12	13	16.54	16.50	16.53		
5	64QAM	25	0	16.56	16.46	16.59		



Channel				19965	20175	20385	Tune-up limit (dBm)	MPR (dB)
Frequency (MHz)				1711.5	1732.5	1753.5		
3	QPSK	1	0	16.93	16.92	16.86	17.5	0
3	QPSK	1	8	16.98	17.04	16.99		
3	QPSK	1	14	16.96	16.95	16.93		
3	QPSK	8	0	17.04	17.04	17.01	17.5	0
3	QPSK	8	4	17.01	17.05	16.99		
3	QPSK	8	7	17.01	17.00	16.99		
3	QPSK	15	0	17.01	17.02	17.02	17.5	0
3	16QAM	1	0	17.11	17.11	17.17		
3	16QAM	1	8	17.22	17.11	17.17		
3	16QAM	1	14	17.17	17.12	17.24	17.5	0
3	16QAM	8	0	17.10	17.11	17.10		
3	16QAM	8	4	17.08	17.11	17.07		
3	16QAM	8	7	17.06	17.09	17.08	17.5	0
3	16QAM	15	0	17.04	17.04	17.01		
3	64QAM	1	0	16.52	16.47	16.57		
3	64QAM	1	8	16.73	16.46	16.64	17.5	0
3	64QAM	1	14	16.60	16.61	16.62		
3	64QAM	8	0	16.64	16.54	16.54		
3	64QAM	8	4	16.61	16.47	16.50	17.5	0
3	64QAM	8	7	16.51	16.45	16.51		
3	64QAM	15	0	16.56	16.38	16.48		
Channel				19957	20175	20393	Tune-up limit (dBm)	MPR (dB)
Frequency (MHz)				1710.7	1732.5	1754.3		
1.4	QPSK	1	0	16.87	16.81	16.83	17.5	0
1.4	QPSK	1	3	17.01	17.05	17.01		
1.4	QPSK	1	5	16.91	16.95	16.90		
1.4	QPSK	3	0	16.93	16.98	16.94		
1.4	QPSK	3	1	16.99	17.04	16.97		
1.4	QPSK	3	3	16.94	16.98	16.96		
1.4	QPSK	6	0	16.95	16.97	16.91	17.5	0
1.4	16QAM	1	0	17.21	17.16	17.21	17.5	0
1.4	16QAM	1	3	17.25	17.15	17.17		
1.4	16QAM	1	5	17.24	17.16	17.18		
1.4	16QAM	3	0	16.99	17.05	17.00		
1.4	16QAM	3	1	17.09	17.09	17.03		
1.4	16QAM	3	3	17.00	17.04	16.96		
1.4	16QAM	6	0	16.98	17.02	17.02	17.5	0
1.4	64QAM	1	0	16.45	16.53	16.57	17.5	0
1.4	64QAM	1	3	16.65	16.65	16.72		
1.4	64QAM	1	5	16.68	16.56	16.53		
1.4	64QAM	3	0	16.60	16.54	16.51		
1.4	64QAM	3	1	16.63	16.65	16.54		
1.4	64QAM	3	3	16.54	16.44	16.53		
1.4	64QAM	6	0	16.51	16.38	16.49	17.5	0



<LTE Band 5>

BW [MHz]	Modulation	RB Size	RB Offset	Power Low Ch. / Freq.	Power Middle Ch. / Freq.	Power High Ch. / Freq.	Tune-up limit (dBm)	MPR (dB)
Channel				20450	20525	20600		
Frequency (MHz)				829	836.5	844		
10	QPSK	1	0	22.46	22.41	22.57	23	0
10	QPSK	1	25	22.19	22.25	22.34		
10	QPSK	1	49	22.69	22.70	22.69		
10	QPSK	25	0	21.62	21.66	21.76	22	1
10	QPSK	25	12	21.78	21.85	21.75		
10	QPSK	25	25	21.72	21.84	21.81		
10	QPSK	50	0	21.66	21.77	21.76	22.5	0.5
10	16QAM	1	0	21.98	22.01	22.08		
10	16QAM	1	25	21.81	21.93	21.80		
10	16QAM	1	49	22.27	22.12	22.37	21	2
10	16QAM	25	0	20.65	20.71	20.77		
10	16QAM	25	12	20.74	20.77	20.73		
10	16QAM	25	25	20.76	20.78	20.93	22	1
10	16QAM	50	0	20.73	20.78	20.79		
10	64QAM	1	0	21.87	21.96	21.86		
10	64QAM	1	25	21.60	21.71	21.64	21	2
10	64QAM	1	49	21.99	21.92	22.00		
10	64QAM	25	0	20.51	20.57	20.59		
10	64QAM	25	12	20.67	20.62	20.59	21	2
10	64QAM	25	25	20.67	20.64	20.71		
10	64QAM	50	0	20.61	20.58	20.66		
Channel				20425	20525	20625	Tune-up limit (dBm)	MPR (dB)
Frequency (MHz)				826.5	836.5	846.5		
5	QPSK	1	0	22.26	22.28	22.46	23	0
5	QPSK	1	12	22.16	22.21	22.26		
5	QPSK	1	24	22.16	22.31	22.30		
5	QPSK	12	0	21.60	21.68	21.75	22	1
5	QPSK	12	7	21.57	21.70	21.76		
5	QPSK	12	13	21.64	21.73	21.76		
5	QPSK	25	0	21.58	21.70	21.72	22.5	0.5
5	16QAM	1	0	21.79	21.87	21.96		
5	16QAM	1	12	21.79	21.90	21.94		
5	16QAM	1	24	21.78	21.88	21.92	21	2
5	16QAM	12	0	20.67	20.68	20.73		
5	16QAM	12	7	20.63	20.72	20.75		
5	16QAM	12	13	20.67	20.72	20.82	22	1
5	16QAM	25	0	20.57	20.73	20.80		
5	64QAM	1	0	21.72	21.64	21.76		
5	64QAM	1	12	21.38	21.53	21.73	21	2
5	64QAM	1	24	21.59	21.64	21.70		
5	64QAM	12	0	20.59	20.51	20.55		
5	64QAM	12	7	20.56	20.59	20.53	21	2
5	64QAM	12	13	20.60	20.56	20.55		
5	64QAM	25	0	20.54	20.56	20.60		



Channel				20415	20525	20635	Tune-up limit (dBm)	MPR (dB)
Frequency (MHz)				825.5	836.5	847.5		
3	QPSK	1	0	22.23	22.24	22.40	23	0
3	QPSK	1	8	22.27	22.28	22.38		
3	QPSK	1	14	22.16	22.26	22.30		
3	QPSK	8	0	21.56	21.62	21.72	22	1
3	QPSK	8	4	21.61	21.67	21.76		
3	QPSK	8	7	21.55	21.62	21.71		
3	QPSK	15	0	21.62	21.66	21.79		
3	16QAM	1	0	21.71	21.82	21.89	22.5	0.5
3	16QAM	1	8	21.86	21.82	21.99		
3	16QAM	1	14	21.76	21.92	21.96		
3	16QAM	8	0	20.64	20.67	20.76	21	2
3	16QAM	8	4	20.70	20.73	20.89		
3	16QAM	8	7	20.57	20.70	20.88		
3	16QAM	15	0	20.68	20.65	20.77		
3	64QAM	1	0	21.62	21.62	21.60	22	1
3	64QAM	1	8	21.74	21.77	21.60		
3	64QAM	1	14	21.55	21.65	21.58		
3	64QAM	8	0	20.59	20.52	20.58	21	2
3	64QAM	8	4	20.58	20.54	20.61		
3	64QAM	8	7	20.48	20.50	20.63		
3	64QAM	15	0	20.58	20.50	20.58		
Channel				20407	20525	20643	Tune-up limit (dBm)	MPR (dB)
Frequency (MHz)				824.7	836.5	848.3		
1.4	QPSK	1	0	22.19	22.24	22.37	23	0
1.4	QPSK	1	3	22.29	22.22	22.40		
1.4	QPSK	1	5	22.21	22.18	22.25		
1.4	QPSK	3	0	22.21	22.21	22.34		
1.4	QPSK	3	1	22.24	22.24	22.39		
1.4	QPSK	3	3	22.22	22.22	22.28		
1.4	QPSK	6	0	21.51	21.61	21.65	22	1
1.4	16QAM	1	0	21.74	21.74	21.83	22.5	0.5
1.4	16QAM	1	3	21.77	21.88	21.88		
1.4	16QAM	1	5	21.71	21.87	21.82		
1.4	16QAM	3	0	21.48	21.61	21.67		
1.4	16QAM	3	1	21.52	21.67	21.73		
1.4	16QAM	3	3	21.53	21.61	21.66		
1.4	16QAM	6	0	20.63	20.71	20.75	21	2
1.4	64QAM	1	0	21.53	21.49	21.52	22	1
1.4	64QAM	1	3	21.50	21.60	21.60		
1.4	64QAM	1	5	21.56	21.64	21.66		
1.4	64QAM	3	0	21.56	21.57	21.56		
1.4	64QAM	3	1	21.53	21.66	21.58		
1.4	64QAM	3	3	21.46	21.54	21.44		
1.4	64QAM	6	0	20.49	20.50	20.49	21	2



<LTE Band 66>

BW [MHz]	Modulation	RB Size	RB Offset	Power Low Ch. / Freq.	Power Middle Ch. / Freq.	Power High Ch. / Freq.	Tune-up limit (dBm)	MPR (dB)
Channel				132072	132322	132572	17.5	0
Frequency (MHz)				1720	1745	1770		
20	QPSK	1	0	16.88	16.98	16.94		
20	QPSK	1	49	16.90	17.00	16.63	17.5	0
20	QPSK	1	99	17.44	17.45	17.18		
20	QPSK	50	0	16.95	16.97	16.81		
20	QPSK	50	24	16.92	16.91	16.74	17.5	0
20	QPSK	50	50	16.94	16.94	16.77		
20	QPSK	100	0	17.02	17.09	16.90		
20	16QAM	1	0	17.41	17.37	17.28	17.5	0
20	16QAM	1	49	17.27	17.27	16.93		
20	16QAM	1	99	17.40	17.41	17.36		
20	16QAM	50	0	16.94	17.00	16.79	17.5	0
20	16QAM	50	24	16.93	16.95	16.75		
20	16QAM	50	50	17.01	16.99	16.78		
20	16QAM	100	0	17.02	17.03	16.83	17.5	0
20	64QAM	1	0	17.29	17.13	17.24		
20	64QAM	1	49	16.73	16.44	16.45		
20	64QAM	1	99	16.97	16.80	16.86	17.5	0
20	64QAM	50	0	16.73	16.50	16.61		
20	64QAM	50	24	16.43	16.53	16.69		
20	64QAM	50	50	16.46	16.53	16.41	17.5	0
20	64QAM	100	0	16.42	16.36	16.47		
Channel				132047	132322	132597		
Frequency (MHz)				1717.5	1745	1772.5		
15	QPSK	1	0	17.37	17.41	17.15	17.5	0
15	QPSK	1	37	16.83	16.88	16.59		
15	QPSK	1	74	17.24	17.19	16.84		
15	QPSK	36	0	17.03	17.06	16.82	17.5	0
15	QPSK	36	20	16.91	16.96	16.70		
15	QPSK	36	39	16.96	16.97	16.61		
15	QPSK	75	0	16.96	17.03	16.77	17.5	0
15	16QAM	1	0	17.32	17.39	17.29		
15	16QAM	1	37	17.41	17.28	16.95		
15	16QAM	1	74	17.42	17.27	17.25	17.5	0
15	16QAM	36	0	17.02	17.00	16.84		
15	16QAM	36	20	16.94	16.98	16.69		
15	16QAM	36	39	16.95	16.97	16.61	17.5	0
15	16QAM	75	0	17.01	17.00	16.78		
15	64QAM	1	0	17.19	17.03	17.07		
15	64QAM	1	37	16.84	16.34	16.34	17.5	0
15	64QAM	1	74	16.97	16.90	16.86		
15	64QAM	36	0	16.63	16.50	16.61		
15	64QAM	36	20	16.55	16.46	16.49	17.5	0
15	64QAM	36	39	16.40	16.40	16.44		
15	64QAM	75	0	16.54	16.49	16.53		



Channel				132022	132322	132622	Tune-up limit (dBm)	MPR (dB)
Frequency (MHz)				1715	1745	1775		
10	QPSK	1	0	16.28	16.40	16.19	17.5	0
10	QPSK	1	25	16.94	17.05	16.68		
10	QPSK	1	49	17.39	17.28	17.17		
10	QPSK	25	0	16.96	17.04	16.71	17.5	0
10	QPSK	25	12	17.08	17.16	16.80		
10	QPSK	25	25	17.15	17.13	16.90		
10	QPSK	50	0	17.01	17.14	16.74		
10	16QAM	1	0	16.79	16.79	16.57	17.5	0
10	16QAM	1	25	17.25	17.39	17.05		
10	16QAM	1	49	17.39	17.43	17.37		
10	16QAM	25	0	16.99	17.06	16.74	17.5	0
10	16QAM	25	12	17.08	17.15	16.81		
10	16QAM	25	25	17.12	17.07	16.79		
10	16QAM	50	0	17.04	17.09	16.79		
10	64QAM	1	0	16.05	16.04	16.09	17.5	0
10	64QAM	1	25	16.74	16.59	16.64		
10	64QAM	1	49	17.15	17.20	16.97		
10	64QAM	25	0	16.52	16.56	16.54	17.5	0
10	64QAM	25	12	16.62	16.51	16.58		
10	64QAM	25	25	16.63	16.65	16.68		
10	64QAM	50	0	16.60	16.50	16.55		
Channel				131997	132322	132647	Tune-up limit (dBm)	MPR (dB)
Frequency (MHz)				1712.5	1745	1777.5		
5	QPSK	1	0	17.00	17.09	16.75	17.5	0
5	QPSK	1	12	16.98	17.12	16.84		
5	QPSK	1	24	17.00	17.03	16.64		
5	QPSK	12	0	17.07	17.12	16.87	17.5	0
5	QPSK	12	7	17.02	17.15	16.77		
5	QPSK	12	13	17.02	17.07	16.71		
5	QPSK	25	0	17.06	17.18	16.77		
5	16QAM	1	0	17.30	17.31	17.10	17.5	0
5	16QAM	1	12	17.34	17.40	16.97		
5	16QAM	1	24	17.34	17.37	16.96		
5	16QAM	12	0	17.17	17.18	16.90	17.5	0
5	16QAM	12	7	17.08	17.13	16.81		
5	16QAM	12	13	17.04	17.11	16.76		
5	16QAM	25	0	16.99	17.14	16.78		
5	64QAM	1	0	16.71	16.69	16.65	17.5	0
5	64QAM	1	12	16.69	16.60	16.73		
5	64QAM	1	24	16.74	16.62	16.62		
5	64QAM	12	0	16.58	16.55	16.67	17.5	0
5	64QAM	12	7	16.56	16.48	16.58		
5	64QAM	12	13	16.51	16.56	16.47		
5	64QAM	25	0	16.62	16.49	16.60		



Channel				131987	132322	132657	Tune-up limit (dBm)	MPR (dB)
Frequency (MHz)				1711.5	1745	1778.5		
3	QPSK	1	0	16.91	16.94	16.69	17.5	0
3	QPSK	1	8	16.96	17.10	16.71		
3	QPSK	1	14	16.93	16.99	16.65		
3	QPSK	8	0	16.99	17.06	16.76	17.5	0
3	QPSK	8	4	17.01	17.09	16.77		
3	QPSK	8	7	16.96	17.09	16.73		
3	QPSK	15	0	16.97	17.08	16.74		
3	16QAM	1	0	17.34	17.41	17.01	17.5	0
3	16QAM	1	8	17.30	17.32	16.97		
3	16QAM	1	14	17.17	17.31	16.95		
3	16QAM	8	0	17.07	17.11	16.83	17.5	0
3	16QAM	8	4	17.10	17.16	16.85		
3	16QAM	8	7	17.03	17.11	16.79		
3	16QAM	15	0	17.00	17.13	16.76		
3	64QAM	1	0	16.49	16.65	16.64	17.5	0
3	64QAM	1	8	16.71	16.64	16.74		
3	64QAM	1	14	16.70	16.50	16.61		
3	64QAM	8	0	16.61	16.48	16.54	17.5	0
3	64QAM	8	4	16.55	16.49	16.56		
3	64QAM	8	7	16.57	16.55	16.51		
3	64QAM	15	0	16.54	16.46	16.49		
Channel				131979	132322	132665	Tune-up limit (dBm)	MPR (dB)
Frequency (MHz)				1710.7	1745	1779.3		
1.4	QPSK	1	0	16.81	16.85	16.57	17.5	0
1.4	QPSK	1	3	17.00	17.16	16.71		
1.4	QPSK	1	5	16.93	17.05	16.64		
1.4	QPSK	3	0	16.94	16.94	16.62		
1.4	QPSK	3	1	16.99	17.11	16.71		
1.4	QPSK	3	3	16.93	17.03	16.69		
1.4	QPSK	6	0	16.94	17.06	16.74	17.5	0
1.4	16QAM	1	0	17.23	17.21	16.96	17.5	0
1.4	16QAM	1	3	17.28	17.43	17.06		
1.4	16QAM	1	5	17.29	17.26	17.03		
1.4	16QAM	3	0	16.98	17.01	16.80		
1.4	16QAM	3	1	17.08	17.20	16.76		
1.4	16QAM	3	3	16.98	17.06	16.73		
1.4	16QAM	6	0	16.96	17.10	16.72	17.5	0
1.4	64QAM	1	0	16.66	16.43	16.54	17.5	0
1.4	64QAM	1	3	16.59	16.59	16.61		
1.4	64QAM	1	5	16.70	16.72	16.70		
1.4	64QAM	3	0	16.47	16.54	16.61		
1.4	64QAM	3	1	16.62	16.54	16.61		
1.4	64QAM	3	3	16.43	16.48	16.49		
1.4	64QAM	6	0	16.51	16.43	16.51	17.5	0



<Reduced Power Mode for Product Specific 10g SAR>

<LTE Band 2>

BW [MHz]	Modulation	RB Size	RB Offset	Power Low Ch. / Freq.	Power Middle Ch. / Freq.	Power High Ch. / Freq.	Tune-up limit (dBm)	MPR (dB)
Channel				18700	18900	19100		
Frequency (MHz)				1860	1880	1900		
20	QPSK	1	0	18.74	18.78	18.73	19	0
20	QPSK	1	49	18.23	18.24	18.01		
20	QPSK	1	99	18.85	18.86	18.72		
20	QPSK	50	0	18.48	18.50	18.32	19	0
20	QPSK	50	24	18.22	18.23	18.30		
20	QPSK	50	50	18.25	18.27	18.22		
20	QPSK	100	0	18.24	18.50	18.49		
20	16QAM	1	0	18.60	18.79	18.50	19	0
20	16QAM	1	49	18.43	18.25	18.46		
20	16QAM	1	99	18.72	18.62	17.96		
20	16QAM	50	0	18.39	18.38	18.27	19	0
20	16QAM	50	24	18.18	18.18	18.22		
20	16QAM	50	50	18.33	18.31	18.42		
20	16QAM	100	0	18.33	18.32	18.39		
20	64QAM	1	0	18.77	18.73	18.75	19	0
20	64QAM	1	49	18.50	18.49	18.45		
20	64QAM	1	99	18.83	18.65	18.81		
20	64QAM	50	0	18.30	18.25	18.36	19	0
20	64QAM	50	24	18.21	18.05	18.36		
20	64QAM	50	50	18.27	18.18	18.36		
20	64QAM	100	0	18.25	18.22	18.45		
Channel				18675	18900	19125	Tune-up limit (dBm)	MPR (dB)
Frequency (MHz)				1857.5	1880	1902.5		
15	QPSK	1	0	18.46	18.83	18.69	19	0
15	QPSK	1	37	18.36	18.04	18.17		
15	QPSK	1	74	18.72	18.73	18.33		
15	QPSK	36	0	18.42	18.37	18.26	19	0
15	QPSK	36	20	18.21	18.23	18.19		
15	QPSK	36	39	18.38	18.31	18.24		
15	QPSK	75	0	18.31	18.33	18.43		
15	16QAM	1	0	18.81	18.71	18.85	19	0
15	16QAM	1	37	18.51	18.36	18.34		
15	16QAM	1	74	18.71	18.70	18.13		
15	16QAM	36	0	18.29	18.30	18.24	19	0
15	16QAM	36	20	18.32	18.28	18.22		
15	16QAM	36	39	18.31	18.21	18.34		
15	16QAM	75	0	18.26	18.30	18.50		
15	64QAM	1	0	18.71	18.75	18.76	19	0
15	64QAM	1	37	18.76	18.71	18.37		
15	64QAM	1	74	18.83	18.74	18.72		
15	64QAM	36	0	18.33	18.31	18.27	19	0
15	64QAM	36	20	18.27	18.24	18.27		
15	64QAM	36	39	18.21	18.16	18.37		
15	64QAM	75	0	18.30	18.27	18.46		



Channel				18650	18900	19150	Tune-up limit (dBm)	MPR (dB)
Frequency (MHz)				1855	1880	1905		
10	QPSK	1	0	18.57	18.54	18.27	19	0
10	QPSK	1	25	17.96	18.01	18.15		
10	QPSK	1	49	18.44	18.19	18.02		
10	QPSK	25	0	18.38	18.28	18.41	19	0
10	QPSK	25	12	18.29	18.20	18.33		
10	QPSK	25	25	18.46	18.23	18.70		
10	QPSK	50	0	18.36	18.43	18.40	19	0
10	16QAM	1	0	18.60	18.75	18.71		
10	16QAM	1	25	18.73	18.21	18.50		
10	16QAM	1	49	18.69	18.57	18.26	19	0
10	16QAM	25	0	18.42	18.23	18.35		
10	16QAM	25	12	18.23	18.27	18.31		
10	16QAM	25	25	18.33	18.47	18.49	19	0
10	16QAM	50	0	18.34	18.44	18.39		
10	64QAM	1	0	18.69	18.61	18.65		
10	64QAM	1	25	18.38	18.18	18.35	19	0
10	64QAM	1	49	18.71	18.51	18.65		
10	64QAM	25	0	18.46	18.15	18.38		
10	64QAM	25	12	18.24	18.18	18.25	19	0
10	64QAM	25	25	18.26	18.08	18.39		
10	64QAM	50	0	18.33	18.17	18.48		
Channel				18625	18900	19175	Tune-up limit (dBm)	MPR (dB)
Frequency (MHz)				1852.5	1880	1907.5		
5	QPSK	1	0	18.30	18.41	18.44	19	0
5	QPSK	1	12	17.97	18.09	18.13		
5	QPSK	1	24	17.94	18.20	18.06		
5	QPSK	12	0	18.27	18.29	18.36	19	0
5	QPSK	12	7	18.24	18.21	18.32		
5	QPSK	12	13	18.36	18.16	18.20		
5	QPSK	25	0	18.29	18.16	18.39	19	0
5	16QAM	1	0	18.23	18.42	18.69		
5	16QAM	1	12	18.61	18.38	18.80		
5	16QAM	1	24	18.20	18.62	18.59	19	0
5	16QAM	12	0	18.34	18.42	18.47		
5	16QAM	12	7	18.41	18.18	18.45		
5	16QAM	12	13	18.38	18.22	18.40	19	0
5	16QAM	25	0	18.23	18.24	18.37		
5	64QAM	1	0	18.49	18.32	18.43		
5	64QAM	1	12	18.37	18.08	18.54	19	0
5	64QAM	1	24	18.24	18.10	18.34		
5	64QAM	12	0	18.34	18.13	18.35		
5	64QAM	12	7	18.20	18.16	18.24	19	0
5	64QAM	12	13	18.27	18.06	18.18		
5	64QAM	25	0	18.41	18.10	18.31		



Channel				18615	18900	19185	Tune-up limit (dBm)	MPR (dB)
Frequency (MHz)				1851.5	1880	1908.5		
3	QPSK	1	0	18.27	18.19	18.27	19	0
3	QPSK	1	8	18.04	18.09	18.28		
3	QPSK	1	14	18.14	17.99	18.07		
3	QPSK	8	0	18.28	18.17	18.30	19	0
3	QPSK	8	4	18.33	18.19	18.33		
3	QPSK	8	7	18.23	18.17	18.26		
3	QPSK	15	0	18.26	18.16	18.32		
3	16QAM	1	0	18.29	18.77	18.41	19	0
3	16QAM	1	8	18.59	18.45	18.58		
3	16QAM	1	14	18.29	18.66	18.40		
3	16QAM	8	0	18.22	18.10	18.38	19	0
3	16QAM	8	4	18.41	18.30	18.51		
3	16QAM	8	7	18.34	18.39	18.38		
3	16QAM	15	0	18.36	18.30	18.20		
3	64QAM	1	0	18.45	18.20	18.39	19	0
3	64QAM	1	8	18.26	18.02	18.20		
3	64QAM	1	14	18.27	18.12	18.36		
3	64QAM	8	0	18.23	18.19	18.26	19	0
3	64QAM	8	4	18.31	18.12	18.29		
3	64QAM	8	7	18.25	18.09	18.23		
3	64QAM	15	0	18.26	18.06	18.28		
Channel				18607	18900	19193	Tune-up limit (dBm)	MPR (dB)
Frequency (MHz)				1850.7	1880	1909.3		
1.4	QPSK	1	0	18.30	18.02	18.46	19	0
1.4	QPSK	1	3	18.41	18.44	18.43		
1.4	QPSK	1	5	17.98	18.15	17.95		
1.4	QPSK	3	0	18.08	18.13	18.21		
1.4	QPSK	3	1	18.12	18.10	18.25		
1.4	QPSK	3	3	18.17	18.23	18.10		
1.4	QPSK	6	0	18.23	18.16	18.39	19	0
1.4	16QAM	1	0	18.77	18.06	18.21	19	0
1.4	16QAM	1	3	18.18	18.41	18.29		
1.4	16QAM	1	5	18.45	18.09	18.57		
1.4	16QAM	3	0	18.17	18.17	18.41		
1.4	16QAM	3	1	18.11	18.03	18.28		
1.4	16QAM	3	3	18.20	18.02	18.35		
1.4	16QAM	6	0	18.10	18.28	18.34	19	0
1.4	64QAM	1	0	18.38	18.28	18.23	19	0
1.4	64QAM	1	3	18.22	18.06	18.45		
1.4	64QAM	1	5	18.18	17.89	18.46		
1.4	64QAM	3	0	18.30	18.12	18.27		
1.4	64QAM	3	1	18.31	18.21	18.36		
1.4	64QAM	3	3	18.22	18.07	18.26		
1.4	64QAM	6	0	18.21	18.13	18.26	19	0



<LTE Band 4>

BW [MHz]	Modulation	RB Size	RB Offset	Power Low Ch. / Freq.	Power Middle Ch. / Freq.	Power High Ch. / Freq.	Tune-up limit (dBm)	MPR (dB)
Channel				20050	20175	20300		
Frequency (MHz)				1720	1732.5	1745		
20	QPSK	1	0	20.43	20.49	20.39	21	0
20	QPSK	1	49	20.21	20.88	20.43		
20	QPSK	1	99	20.19	20.21	20.55		
20	QPSK	50	0	20.52	20.51	20.41	21	0
20	QPSK	50	24	20.29	20.43	20.35		
20	QPSK	50	50	20.32	20.32	20.40		
20	QPSK	100	0	20.40	20.42	20.33		
20	16QAM	1	0	20.74	20.70	20.70	21	0
20	16QAM	1	49	20.78	20.66	20.77		
20	16QAM	1	99	20.62	20.71	20.82		
20	16QAM	50	0	20.43	20.51	20.38	21	0
20	16QAM	50	24	20.32	20.49	20.38		
20	16QAM	50	50	20.38	20.27	20.28		
20	16QAM	100	0	20.29	20.38	20.47		
20	64QAM	1	0	20.04	20.03	19.94	21	0
20	64QAM	1	49	19.86	20.04	19.94		
20	64QAM	1	99	20.09	20.00	20.14		
20	64QAM	50	0	19.88	19.83	19.79	21	0
20	64QAM	50	24	19.76	19.82	19.76		
20	64QAM	50	50	19.75	19.70	19.78		
20	64QAM	100	0	19.82	19.76	19.79		
Channel				20025	20175	20325	Tune-up limit (dBm)	MPR (dB)
Frequency (MHz)				1717.5	1732.5	1747.5		
15	QPSK	1	0	20.55	20.58	20.57	21	0
15	QPSK	1	37	20.74	20.19	20.44		
15	QPSK	1	74	20.59	20.46	20.51		
15	QPSK	36	0	20.40	20.51	20.38	21	0
15	QPSK	36	20	20.45	20.31	20.37		
15	QPSK	36	39	20.30	20.35	20.35		
15	QPSK	75	0	20.32	20.44	20.40		
15	16QAM	1	0	20.75	20.86	20.66	21	0
15	16QAM	1	37	20.50	20.30	20.80		
15	16QAM	1	74	20.43	20.71	20.78		
15	16QAM	36	0	20.44	20.45	20.40	21	0
15	16QAM	36	20	20.43	20.33	20.41		
15	16QAM	36	39	20.28	20.41	20.31		
15	16QAM	75	0	20.44	20.37	20.38		
15	64QAM	1	0	20.29	20.18	20.24	21	0
15	64QAM	1	37	20.07	20.07	19.70		
15	64QAM	1	74	20.03	20.02	20.17		
15	64QAM	36	0	19.92	19.93	19.81	21	0
15	64QAM	36	20	19.83	19.73	19.87		
15	64QAM	36	39	19.72	19.70	19.80		
15	64QAM	75	0	19.82	19.78	19.85		



Channel				20000	20175	20350	Tune-up limit (dBm)	MPR (dB)
Frequency (MHz)				1715	1732.5	1750		
10	QPSK	1	0	20.58	20.76	20.75	21	0
10	QPSK	1	25	20.46	20.27	20.21		
10	QPSK	1	49	20.76	20.73	20.72		
10	QPSK	25	0	20.61	20.61	20.63	21	0
10	QPSK	25	12	20.62	20.58	20.58		
10	QPSK	25	25	20.77	20.84	20.74		
10	QPSK	50	0	20.63	20.70	20.60		
10	16QAM	1	0	20.82	20.80	20.83	21	0
10	16QAM	1	25	20.81	20.59	20.53		
10	16QAM	1	49	20.82	20.83	20.84		
10	16QAM	25	0	20.57	20.52	20.70	21	0
10	16QAM	25	12	20.53	20.68	20.52		
10	16QAM	25	25	20.64	20.78	20.66		
10	16QAM	50	0	20.61	20.63	20.55		
10	64QAM	1	0	20.45	20.50	20.28	21	0
10	64QAM	1	25	20.11	20.05	20.19		
10	64QAM	1	49	20.71	20.68	20.62		
10	64QAM	25	0	20.10	20.03	20.05	21	0
10	64QAM	25	12	20.09	20.00	19.92		
10	64QAM	25	25	20.19	20.05	20.03		
10	64QAM	50	0	20.16	20.04	20.06		
Channel				19975	20175	20375	Tune-up limit (dBm)	MPR (dB)
Frequency (MHz)				1712.5	1732.5	1752.5		
5	QPSK	1	0	20.59	20.53	20.37	21	0
5	QPSK	1	12	20.35	20.48	20.32		
5	QPSK	1	24	20.46	20.38	20.34		
5	QPSK	12	0	20.68	20.65	20.58	21	0
5	QPSK	12	7	20.57	20.56	20.53		
5	QPSK	12	13	20.49	20.54	20.54		
5	QPSK	25	0	20.56	20.56	20.67		
5	16QAM	1	0	20.71	20.61	20.64	21	0
5	16QAM	1	12	20.68	20.72	20.66		
5	16QAM	1	24	20.59	20.76	20.74		
5	16QAM	12	0	20.65	20.59	20.44	21	0
5	16QAM	12	7	20.59	20.52	20.75		
5	16QAM	12	13	20.54	20.63	20.47		
5	16QAM	25	0	20.52	20.56	20.52		
5	64QAM	1	0	20.25	20.35	20.08	21	0
5	64QAM	1	12	20.36	20.21	19.98		
5	64QAM	1	24	20.18	20.02	20.08		
5	64QAM	12	0	20.06	20.03	19.96	21	0
5	64QAM	12	7	20.09	19.95	19.98		
5	64QAM	12	13	20.03	19.95	19.89		
5	64QAM	25	0	20.08	19.94	20.00		



Channel				19965	20175	20385	Tune-up limit (dBm)	MPR (dB)
Frequency (MHz)				1711.5	1732.5	1753.5		
3	QPSK	1	0	20.41	20.39	20.30	21	0
3	QPSK	1	8	20.37	20.45	20.36		
3	QPSK	1	14	20.38	20.47	20.45		
3	QPSK	8	0	20.54	20.54	20.60	21	0
3	QPSK	8	4	20.56	20.59	20.57		
3	QPSK	8	7	20.46	20.51	20.57		
3	QPSK	15	0	20.56	20.52	20.52	21	0
3	16QAM	1	0	20.62	20.62	20.35		
3	16QAM	1	8	20.67	20.63	20.74		
3	16QAM	1	14	20.27	20.76	20.49	21	0
3	16QAM	8	0	20.58	20.75	20.66		
3	16QAM	8	4	20.70	20.71	20.64		
3	16QAM	8	7	20.59	20.71	20.60	21	0
3	16QAM	15	0	20.49	20.51	20.70		
3	64QAM	1	0	20.11	20.02	19.90		
3	64QAM	1	8	20.21	20.05	20.19	21	0
3	64QAM	1	14	20.13	20.14	20.11		
3	64QAM	8	0	20.09	20.06	20.04		
3	64QAM	8	4	20.03	19.94	19.97	21	0
3	64QAM	8	7	20.06	19.96	19.92		
3	64QAM	15	0	20.04	19.89	19.94		
Channel				19957	20175	20393	Tune-up limit (dBm)	MPR (dB)
Frequency (MHz)				1710.7	1732.5	1754.3		
1.4	QPSK	1	0	20.29	20.35	20.19	21	0
1.4	QPSK	1	3	20.33	20.24	20.49		
1.4	QPSK	1	5	20.55	20.36	20.28		
1.4	QPSK	3	0	20.46	20.57	20.44	21	0
1.4	QPSK	3	1	20.54	20.59	20.52		
1.4	QPSK	3	3	20.59	20.53	20.50		
1.4	QPSK	6	0	20.48	20.53	20.35	21	0
1.4	16QAM	1	0	20.66	20.61	20.39	21	0
1.4	16QAM	1	3	20.39	20.75	20.83		
1.4	16QAM	1	5	20.71	20.42	20.25		
1.4	16QAM	3	0	20.47	20.52	20.64	21	0
1.4	16QAM	3	1	20.66	20.40	20.52		
1.4	16QAM	3	3	20.35	20.52	20.44		
1.4	16QAM	6	0	20.52	20.67	20.36	21	0
1.4	64QAM	1	0	20.14	19.97	19.81	21	0
1.4	64QAM	1	3	20.05	20.15	20.10		
1.4	64QAM	1	5	20.19	19.92	19.90		
1.4	64QAM	3	0	20.07	20.09	20.03	21	0
1.4	64QAM	3	1	20.07	20.11	20.02		
1.4	64QAM	3	3	19.97	19.89	20.02		
1.4	64QAM	6	0	19.96	19.90	19.93	21	0



<LTE Band 66>

BW [MHz]	Modulation	RB Size	RB Offset	Power Low Ch. / Freq.	Power Middle Ch. / Freq.	Power High Ch. / Freq.	Tune-up limit (dBm)	MPR (dB)
Channel				132072	132322	132572		
Frequency (MHz)				1720	1745	1770		
20	QPSK	1	0	20.49	20.36	20.49		
20	QPSK	1	49	20.35	20.42	20.15	21	0
20	QPSK	1	99	20.88	20.95	20.62		
20	QPSK	50	0	20.56	20.66	20.39		
20	QPSK	50	24	20.50	20.39	20.23	21	0
20	QPSK	50	50	20.54	20.64	20.33		
20	QPSK	100	0	20.51	20.59	20.54		
20	16QAM	1	0	20.66	20.85	20.62	21	0
20	16QAM	1	49	20.81	20.52	20.93		
20	16QAM	1	99	20.85	20.84	20.47		
20	16QAM	50	0	20.44	20.54	20.27	21	0
20	16QAM	50	24	20.52	20.48	20.37		
20	16QAM	50	50	20.59	20.54	20.41		
20	16QAM	100	0	20.48	20.53	20.49	21	0
20	64QAM	1	0	20.36	20.29	20.36		
20	64QAM	1	49	20.17	20.10	20.36		
20	64QAM	1	99	20.79	20.80	20.40	21	0
20	64QAM	50	0	20.09	19.96	20.01		
20	64QAM	50	24	19.98	19.90	19.98		
20	64QAM	50	50	20.01	19.90	20.02	21	0
20	64QAM	100	0	20.01	20.01	20.02		
Channel				132047	132322	132597		
Frequency (MHz)				1717.5	1745	1772.5		
15	QPSK	1	0	20.93	20.91	20.86	21	0
15	QPSK	1	37	20.26	20.88	20.10		
15	QPSK	1	74	20.71	20.71	20.55		
15	QPSK	36	0	20.51	20.52	20.34	21	0
15	QPSK	36	20	20.46	20.53	20.25		
15	QPSK	36	39	20.34	20.46	20.23		
15	QPSK	75	0	20.45	20.57	20.24	21	0
15	16QAM	1	0	20.89	20.89	20.79		
15	16QAM	1	37	20.94	20.37	20.32		
15	16QAM	1	74	20.90	20.94	20.55	21	0
15	16QAM	36	0	20.43	20.59	20.49		
15	16QAM	36	20	20.38	20.49	20.26		
15	16QAM	36	39	20.36	20.43	20.15	21	0
15	16QAM	75	0	20.46	20.62	20.38		
15	64QAM	1	0	20.64	20.56	20.54		
15	64QAM	1	37	20.04	20.18	20.73	21	0
15	64QAM	1	74	20.37	20.43	20.38		
15	64QAM	36	0	20.14	19.98	20.06		
15	64QAM	36	20	20.05	19.95	19.98	21	0
15	64QAM	36	39	19.93	19.84	19.97		
15	64QAM	75	0	20.14	19.92	20.05		



Channel				132022	132322	132622	Tune-up limit (dBm)	MPR (dB)
Frequency (MHz)				1715	1745	1775		
10	QPSK	1	0	19.95	19.80	19.96	21	0
10	QPSK	1	25	20.20	20.21	20.18		
10	QPSK	1	49	20.78	20.70	20.17		
10	QPSK	25	0	20.52	20.52	20.22	21	0
10	QPSK	25	12	20.54	20.64	20.37		
10	QPSK	25	25	20.75	20.66	20.26		
10	QPSK	50	0	20.54	20.70	20.37		
10	16QAM	1	0	20.20	20.41	19.99	21	0
10	16QAM	1	25	20.60	20.87	20.55		
10	16QAM	1	49	20.86	20.65	20.02		
10	16QAM	25	0	20.47	20.74	20.24	21	0
10	16QAM	25	12	20.60	20.69	20.43		
10	16QAM	25	25	20.67	20.59	20.55		
10	16QAM	50	0	20.52	20.48	20.30		
10	64QAM	1	0	19.73	19.70	19.71	21	0
10	64QAM	1	25	20.17	20.07	20.19		
10	64QAM	1	49	20.63	20.66	20.59		
10	64QAM	25	0	20.04	19.94	20.05	21	0
10	64QAM	25	12	20.08	20.01	20.13		
10	64QAM	25	25	20.19	20.04	20.22		
10	64QAM	50	0	20.08	20.04	20.01		
Channel				131997	132322	132647	Tune-up limit (dBm)	MPR (dB)
Frequency (MHz)				1712.5	1745	1777.5		
5	QPSK	1	0	20.52	20.57	20.27	21	0
5	QPSK	1	12	20.37	20.49	20.16		
5	QPSK	1	24	20.50	20.53	20.19		
5	QPSK	12	0	20.59	20.61	20.37	21	0
5	QPSK	12	7	20.48	20.67	20.32		
5	QPSK	12	13	20.52	20.57	20.24		
5	QPSK	25	0	20.56	20.58	20.32		
5	16QAM	1	0	20.86	20.76	20.51	21	0
5	16QAM	1	12	20.82	20.91	20.83		
5	16QAM	1	24	20.77	20.76	20.53		
5	16QAM	12	0	20.61	20.62	20.31	21	0
5	16QAM	12	7	20.64	20.68	20.49		
5	16QAM	12	13	20.65	20.68	20.27		
5	16QAM	25	0	20.42	20.67	20.40		
5	64QAM	1	0	20.15	20.17	20.24	21	0
5	64QAM	1	12	20.15	20.13	20.31		
5	64QAM	1	24	20.22	20.15	20.14		
5	64QAM	12	0	20.08	20.03	20.15	21	0
5	64QAM	12	7	20.09	20.05	20.15		
5	64QAM	12	13	20.04	20.02	20.08		
5	64QAM	25	0	20.04	20.00	20.08		



Channel				131987	132322	132657	Tune-up limit (dBm)	MPR (dB)
Frequency (MHz)				1711.5	1745	1778.5		
3	QPSK	1	0	20.28	20.40	20.28	21	0
3	QPSK	1	8	20.32	20.56	20.02		
3	QPSK	1	14	20.44	20.47	20.27		
3	QPSK	8	0	20.52	20.50	20.32	21	0
3	QPSK	8	4	20.50	20.65	20.42		
3	QPSK	8	7	20.50	20.53	20.27		
3	QPSK	15	0	20.44	20.61	20.25	21	0
3	16QAM	1	0	20.63	20.52	20.77		
3	16QAM	1	8	20.65	20.92	20.57		
3	16QAM	1	14	20.85	20.40	20.55	21	0
3	16QAM	8	0	20.54	20.82	20.37		
3	16QAM	8	4	20.64	20.73	20.31		
3	16QAM	8	7	20.51	20.77	20.35	21	0
3	16QAM	15	0	20.66	20.70	20.30		
3	64QAM	1	0	20.23	20.25	20.15		
3	64QAM	1	8	20.14	20.05	20.24	21	0
3	64QAM	1	14	20.01	20.12	20.05		
3	64QAM	8	0	20.02	19.98	20.10		
3	64QAM	8	4	20.08	19.94	20.08	21	0
3	64QAM	8	7	19.99	20.04	20.00		
3	64QAM	15	0	20.06	19.95	20.04		
Channel				131979	132322	132665	Tune-up limit (dBm)	MPR (dB)
Frequency (MHz)				1710.7	1745	1779.3		
1.4	QPSK	1	0	20.21	20.44	20.12	21	0
1.4	QPSK	1	3	20.49	20.63	20.25		
1.4	QPSK	1	5	20.62	20.41	20.17		
1.4	QPSK	3	0	20.47	20.40	20.25	21	0
1.4	QPSK	3	1	20.57	20.65	20.20		
1.4	QPSK	3	3	20.49	20.44	20.43		
1.4	QPSK	6	0	20.49	20.59	20.30	21	0
1.4	16QAM	1	0	20.91	20.89	20.63	21	0
1.4	16QAM	1	3	20.50	20.80	20.44		
1.4	16QAM	1	5	20.93	20.94	20.86		
1.4	16QAM	3	0	20.60	20.43	20.38	21	0
1.4	16QAM	3	1	20.43	20.70	20.19		
1.4	16QAM	3	3	20.40	20.49	20.27		
1.4	16QAM	6	0	20.47	20.69	20.37	21	0
1.4	64QAM	1	0	20.19	20.11	20.08	21	0
1.4	64QAM	1	3	20.16	19.91	20.12		
1.4	64QAM	1	5	20.14	20.21	20.33		
1.4	64QAM	3	0	20.13	20.03	20.16	21	0
1.4	64QAM	3	1	20.12	19.99	20.24		
1.4	64QAM	3	3	20.08	19.99	20.13		
1.4	64QAM	6	0	20.00	19.93	20.06	21	0



<WLAN Conducted Power>

General Note:

1. Per KDB 248227 D01v02r02, SAR test reduction is determined according to 802.11 transmission mode configurations and certain exposure conditions with multiple test positions. In the 2.4 GHz band, separate SAR procedures are applied to DSSS and OFDM configurations to simplify DSSS test requirements. For OFDM, in both 2.4 and 5 GHz bands, an initial test configuration must be determined for each standalone and aggregated frequency band, according to the transmission mode configuration with the highest maximum output power specified for production units to perform SAR measurements. If the same highest maximum output power applies to different combinations of channel bandwidths, modulations and data rates, additional procedures are applied to determine which test configurations require SAR measurement. When applicable, an initial test position may be applied to reduce the number of SAR measurements required for next to the ear, UMPC mini-tablet or hotspot mode configurations with multiple test positions.
2. For 2.4 GHz 802.11b DSSS, either the initial test position procedure for multiple exposure test positions or the DSSS procedure for fixed exposure position is applied; these are mutually exclusive. For 2.4 GHz and 5 GHz OFDM configurations, the initial test configuration is applied to measure SAR using either the initial test position procedure for multiple exposure test position configurations or the initial test configuration procedures for fixed exposure test conditions. Based on the reported SAR of the measured configurations and maximum output power of the transmission mode configurations that are not included in the initial test configuration, the subsequent test configuration and initial test position procedures are applied to determine if SAR measurements are required for the remaining OFDM transmission configurations. In general, the number of test channels that require SAR measurement is minimized based on maximum output power measured for the test sample(s).
3. For OFDM transmission configurations in the 2.4 GHz and 5 GHz bands, When the same maximum power is specified for multiple transmission modes in a frequency band, the largest channel bandwidth, lowest order modulation, lowest data rate and lowest order 802.11a/g/n/ac mode is used for SAR measurement, on the highest measured output power channel for each frequency band.
4. DSSS and OFDM configurations are considered separately according to the required SAR procedures. SAR is measured in the initial test position using the 802.11 transmission mode configuration required by the DSSS procedure or initial test configuration and subsequent test configuration(s) according to the OFDM procedures.18 The initial test position procedure is described in the following:
 - a. When the reported SAR of the initial test position is ≤ 0.4 W/kg, further SAR measurement is not required for the other test positions in that exposure configuration and 802.11 transmission mode combinations within the frequency band or aggregated band.
 - b. When the reported SAR of the test position is > 0.4 W/kg, SAR is repeated for the 802.11 transmission mode configuration tested in the initial test position to measure the subsequent next closet/smallest test separation distance and maximum coupling test position on the highest maximum output power channel, until the report SAR is ≤ 0.8 W/kg or all required test position are tested.
 - c. For all positions/configurations, when the reported SAR is > 0.8 W/kg, SAR is measured for these test positions/configurations on the subsequent next highest measured output power channel(s) until the reported SAR is ≤ 1.2 W/kg or all required channels are tested.

<Full Power Mode>

<2.4GHz WLAN>

	Mode	Channel	Frequency (MHz)	Average power (dBm)	Tune-Up Limit	Duty Cycle %
2.4GHz WLAN	802.11b 1Mbps	1	2412	18.87	19.50	97.84
		6	2437	19.17	19.50	
		11	2462	18.77	19.50	
	802.11g 6Mbps	1	2412	14.73	15.50	87.44
		6	2437	18.73	19.50	
		11	2462	15.04	15.50	
	802.11n-HT20 MCS0	1	2412	14.40	15.00	86.70
		6	2437	17.55	18.00	
		11	2462	13.71	14.00	



<5GHz WLAN>

	Mode	Channel	Frequency (MHz)	Average power (dBm)	Tune-Up Limit	Duty Cycle %
5.2GHz WLAN	802.11a 6Mbps	36	5180	17.96	18.50	87.50
		40	5200	18.02	18.50	
		44	5220	18.06	18.50	
		48	5240	18.08	18.50	
	802.11n-HT20 MCS0	36	5180	17.95	18.50	86.27
		40	5200	18.00	18.50	
		44	5220	18.04	18.50	
		48	5240	18.06	18.50	
	802.11n-HT40 MCS0	38	5190	16.84	17.50	76.22
		46	5230	17.35	17.50	

	Mode	Channel	Frequency (MHz)	Average power (dBm)	Tune-Up Limit	Duty Cycle %
5.3GHz WLAN	802.11a 6Mbps	52	5260	18.11	18.50	87.50
		56	5280	18.06	18.50	
		60	5300	18.13	18.50	
		64	5320	18.20	18.50	
	802.11n-HT20 MCS0	52	5260	18.09	18.50	86.27
		56	5280	18.05	18.50	
		60	5300	18.11	18.50	
		64	5320	18.17	18.50	
	802.11n-HT40 MCS0	54	5270	17.46	17.50	76.22
		62	5310	17.42	17.50	

5.5GHz WLAN	Mode	Channel	Frequency (MHz)	Average power (dBm)	Tune-Up Limit	Duty Cycle %
	802.11a 6Mbps	100	5500	17.58	18.50	87.50
		116	5580	17.83	18.50	
		132	5660	17.95	18.50	
		140	5700	17.75	18.50	
	802.11n-HT20 MCS0	100	5500	17.57	18.50	86.27
		116	5580	17.80	18.50	
		132	5660	17.92	18.50	
		140	5700	17.71	18.50	
	802.11n-HT40 MCS0	102	5510	16.65	17.00	76.22
		110	5550	16.72	17.00	
		134	5670	16.79	17.00	

5.8GHz WLAN	Mode	Channel	Frequency (MHz)	Average power (dBm)	Tune-Up Limit	Duty Cycle %
	802.11a 6Mbps	149	5745	17.60	18.00	87.50
		157	5785	17.03	18.00	
		165	5825	16.51	18.00	
	802.11n-HT20 MCS0	149	5745	17.59	18.00	86.27
		157	5785	17.01	18.00	
		165	5825	16.49	18.00	
	802.11n-HT40 MCS0	151	5755	17.56	17.90	76.22
		159	5795	16.88	17.50	



<Reduced Power Mode for Receiver On>

<2.4GHz WLAN>

2.4GHz WLAN	Mode	Channel	Frequency (MHz)	Average power (dBm)	Tune-Up Limit	Duty Cycle %
	802.11b 1Mbps		1	2412	16.35	16.50
6			2437	16.07	16.50	
11			2462	16.10	16.50	
802.11g 6Mbps		1	2412	14.73	15.00	87.44
		6	2437	16.06	16.50	
		11	2462	15.04	15.50	
802.11n-HT20 MCS0		1	2412	14.40	15.00	86.70
		6	2437	16.06	16.50	
		11	2462	13.71	14.00	

<Reduced Power Mode for P-Sensor On>

<5GHz WLAN>

5.5GHz WLAN	Mode	Channel	Frequency (MHz)	Average power (dBm)	Tune-Up Limit	Duty Cycle %
	802.11a 6Mbps		100	5500	15.21	15.50
116			5580	15.05	15.50	
132			5660	14.90	15.50	
140			5700	14.82	15.50	
802.11n-HT20 MCS0		100	5500	15.20	15.50	86.27
		116	5580	15.04	15.50	
		132	5660	14.86	15.50	
		140	5700	14.78	15.50	
802.11n-HT40 MCS0		102	5510	14.23	15.00	76.22
		110	5550	14.60	15.00	
		134	5670	14.75	15.00	

<Reduced Power Mode for Hotspot On/P-Sensor On>

<5GHz WLAN>

5.8GHz WLAN	Mode	Channel	Frequency (MHz)	Average power (dBm)	Tune-Up Limit	Duty Cycle %
	802.11a 6Mbps		149	5745	14.97	15.50
157			5785	14.94	15.50	
165			5825	14.84	15.50	
802.11n-HT20 MCS0		149	5745	14.95	15.50	86.27
		157	5785	14.92	15.50	
		165	5825	14.82	15.50	
802.11n-HT40 MCS0		151	5755	14.94	15.00	76.22
		159	5795	14.96	15.00	

<2.4GHz Bluetooth>

General Note:

1. For 2.4GHz Bluetooth SAR testing was selected 1Mbps, due to its highest average power.
2. The Bluetooth duty cycle is 76.74% as following figure, according to 2016 Oct. TCB workshop for Bluetooth SAR scaling need further consideration and the theoretical duty cycle is 83.3%, therefore the actual duty cycle will be scaled up to the theoretical value of Bluetooth reported SAR calculation

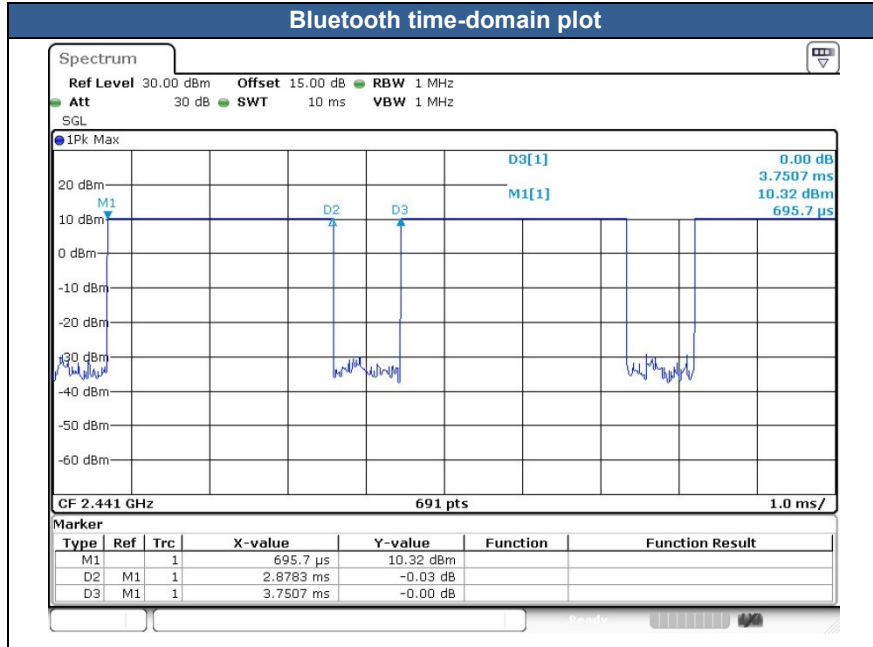

Mode	Channel	Frequency (MHz)	Average power (dBm)
			1Mbps
v3.0 with EDR	CH 00	2402	10.81
	CH 39	2441	10.85
	CH 78	2480	10.15
Tune-up Limit			11.50

Mode	Channel	Frequency (MHz)	Average power (dBm)
			GFSK
v4.0/4.1/4.2 with LE	CH 00	2402	1.51
	CH 19	2440	1.54
	CH 39	2480	0.98
Tune-up Limit			2.50

14. Antenna Location

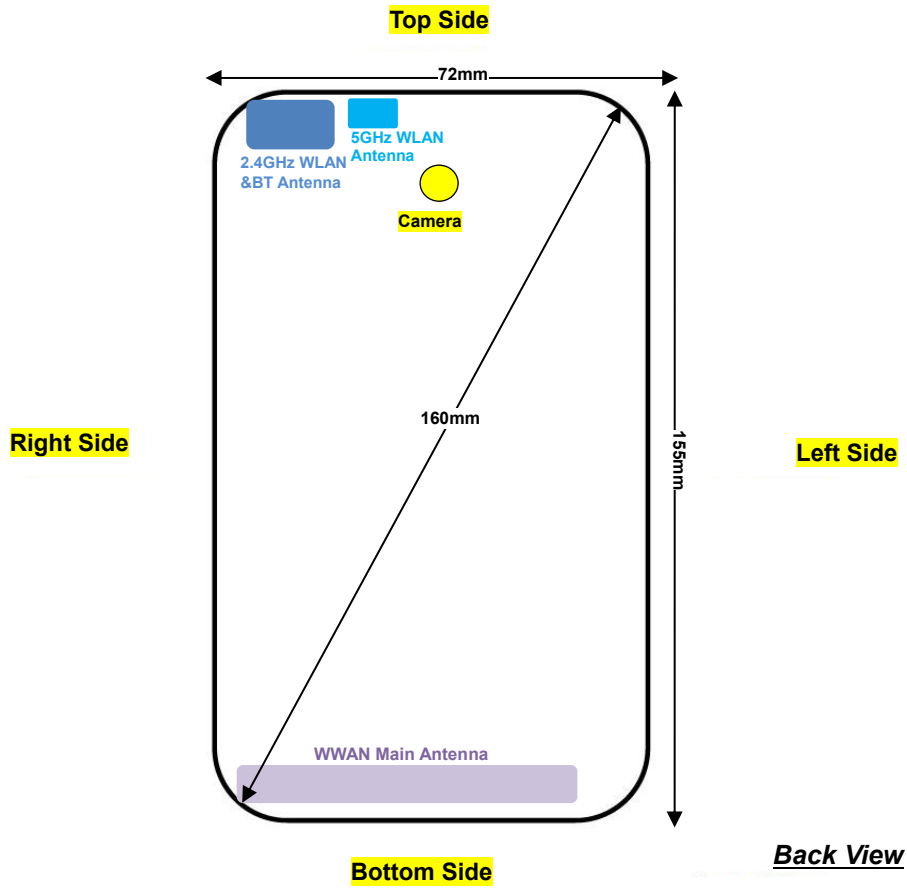

Distance of the Antenna to the EUT surface/edge						
Antennas	Back	Front	Top Side	Bottom Side	Right Side	Left Side
WWAN Main Antenna	≤ 25mm	≤ 25mm	>25mm	≤ 25mm	≤ 25mm	≤ 25mm
2.4GHz WLAN & BT	≤ 25mm	≤ 25mm	≤ 25mm	>25mm	≤ 25mm	>25mm
5GHz WLAN	≤ 25mm	≤ 25mm	≤ 25mm	>25mm	≤ 25mm	>25mm

Positions for SAR tests; Hotspot mode						
Antennas	Back	Front	Top Side	Bottom Side	Right Side	Left Side
WWAN Main Antenna	Yes	Yes	No	Yes	Yes	Yes
2.4GHz WLAN & BT	Yes	Yes	Yes	No	Yes	No
5GHz WLAN	Yes	Yes	Yes	No	Yes	No

General Note: Referring to KDB 941225 D06 v02r01, when the overall device length and width are ≥ 9cm*5cm, the test distance is 10 mm. SAR must be measured for all sides and surfaces with a transmitting antenna located within 25mm from that surface or edge.



15. SAR Test Results

General Note:

1. Per KDB 447498 D01v06, the reported SAR is the measured SAR value adjusted for maximum tune-up tolerance.
 - a. Tune-up scaling Factor = tune-up limit power (mW) / EUT RF power (mW), where tune-up limit is the maximum rated power among all production units.
 - b. For SAR testing of WLAN signal with non-100% duty cycle, the measured SAR is scaled-up by the duty cycle scaling factor which is equal to "1/(duty cycle)"
 - c. For WWAN: Reported SAR(W/kg)= Measured SAR(W/kg)*Tune-up Scaling Factor
 - d. For WLAN/Bluetooth: Reported SAR(W/kg)= Measured SAR(W/kg)* Duty Cycle scaling factor * Tune-up scaling factor
2. Per KDB 447498 D01v06, for each exposure position, testing of other required channels within the operating mode of a frequency band is not required when the *reported* 1-g or 10-g SAR for the mid-band or highest output power channel is:
 - ≤ 0.8 W/kg or 2.0 W/kg, for 1-g or 10-g respectively, when the transmission band is ≤ 100 MHz
 - ≤ 0.6 W/kg or 1.5 W/kg, for 1-g or 10-g respectively, when the transmission band is between 100 MHz and 200 MHz
 - ≤ 0.4 W/kg or 1.0 W/kg, for 1-g or 10-g respectively, when the transmission band is ≥ 200 MHz
3. Per KDB 865664 D01v01r04, for each frequency band, repeated SAR measurement is required when the measured SAR is ≥ 0.8 W/kg. Per KDB 865664 D01v01r04, if the extremity repeated SAR is necessary, the same procedures should be adapted for measurements according to extremity and occupational exposure limits by applying a factor of 2.5 for extremity exposure and a factor of 5 for occupational exposure to the corresponding SAR thresholds.
4. Per KDB 648474 D04v01r03, when the reported SAR for a body-worn accessory measured without a headset connected to the handset is ≤ 1.2 W/kg, SAR testing with a headset connected to the handset is not required.
5. The device employs proximity sensors that detect the presence of the user's body at the front or back faces of the device. When front or back body worn condition is detected, GSM1900, WCDMA band II/IV/V, CDMA2000 BC0/BC1, LTE band 2/4/5/66 and WLAN 5.5/5.8GHz reduced power will be active. (P-sensor can't work at detecting presence of the user's body at the four edges of the device.)
6. When hotspot mode is enabled, power reduction will be activated to limit the maximum power of GSM1900, WCDMA band II/IV/V, CDMA2000 BC0/BC1, LTE band 2/4/5/66 and WLAN5.8GHz.
7. For WWAN bands, this device hotspot reduced power and P-sensor reduced power level are the same. So only show one reduced power level for hotspot reduced power and P-sensor reduced power for this application.
8. The device additionally employs proximity sensors that detect the presence of tissue near the currently active transmit antenna, the handheld reduced power table which at WCDMA band II/IV, CDMA2000 BC1 and LTE band 2/4/66 reduced powers will be active.
9. When the phone is in talking mode and receiver worked, then power reduction will be implemented immediately at WLAN2.4GHz.
10. Per KDB648474 D04v01r03, for smart phones with a display diagonal dimension > 15.0 cm or an overall diagonal dimension > 16.0 cm, when hotspot mode applies, 10-g extremity SAR is required only for the surfaces and edges with hotspot mode 1-g reported SAR > 1.2 W/kg, however, when power reduction applies to hotspot mode the measured SAR must be scaled to the maximum output power, including tolerance, allowed for phablet modes to compare with the 1.2 W/kg SAR test reduction threshold.
 - a. For this device for WWAN transmitter scaled to handheld power or full power mode for product specific 10g SAR is higher than 1.2W/kg of GSM1900, WCDMA band II/IV, CDMA2000 BC1 and LTE band 2/4/66, therefore product specific SAR is necessary.
 - b. WLAN 5.3/5.5GHz tested the product specific 10g SAR since it has no hotspot mode.
 - c. WLAN 5.8GHz scaled to full power mode for product specific 10g SAR is higher than 1.2W/kg of WLAN5.8GHz, therefore product specific SAR is necessary.
 - d. When 10-g product specific 10g SAR is considered, SAR thresholds is specified in the procedures for SAR test reduction and exclusion should be multiplied by 2.5.

GSM Note:

1. Per KDB 941225 D01v03r01, for SAR test reduction for GSM / GPRS / EDGE modes is determined by the source-based time-averaged output power including tune-up tolerance. The mode with highest specified time-averaged output power should be tested for SAR compliance in the applicable exposure conditions. For modes with the same specified maximum output power and tolerance, the higher number time-slot configuration should be tested. Therefore, the GPRS (4Tx slots) for GSM850/GSM1900 is considered as the primary mode.
2. Other configurations of GSM / GPRS / EDGE are considered as secondary modes. The 3G SAR test reduction procedure is applied, when the maximum output power and tune-up tolerance specified for production units in a secondary mode is $\leq 1/4$ dB higher than the primary mode, SAR measurement is not required for the secondary mode.



3. Power reduction which is triggered by hotspot mode is implemented in GSM1900 band, for hotspot mode SAR testing EUT was set in reduced power mode and GPRS 1 Tx slot due to its highest frame-average power.

WCDMA Note:

1. Per KDB 941225 D01v03r01, for SAR testing is measured using a 12.2 kbps RMC with TPC bits configured to all "1's".
2. Per KDB 941225 D01v03r01, RMC 12.2kbps setting is used to evaluate SAR. The maximum output power and tune-up tolerance specified for production units in HSDPA / HSUPA / DC-HSDPA is $\leq \frac{1}{4}$ dB higher than RMC 12.2Kbps or when the highest reported SAR of the RMC12.2Kbps is scaled by the ratio of specified maximum output power and tune-up tolerance of HSDPA / HSUPA / DC-HSDPA to RMC12.2Kbps and the adjusted SAR is ≤ 1.2 W/kg, SAR measurement is not required for HSDPA / HSUPA / DC-HSDPA, and according to the following RF output power, the output power results of the secondary modes (HSUPA, HSDPA, DC-HSDPA) are less than $\frac{1}{4}$ dB higher than the primary modes; therefore, SAR measurement is not required for HSDPA / HSUPA / DC-HSDPA.

CDMA Note:

1. Per KDB 941225 D01v03r01, SAR for next to the ear head exposure is measured in RC3 with the handset configured to transmit at full rate in SO55.
2. Per KDB 941225 D01v03r01, in Hotspot mode EUT is treated as data device and SAR is tested with Ev-Do Rev 0 (RTAP 153.6kbps) as the primary mode.
3. Per KDB 941225 D01v03r01, for Body-worn accessory SAR is measured in RC3 with the handset configured in TDSO/SO32 to transmit at full rate on FCH only with all other code channels disabled. The body-worn accessory procedures in KDB Publication 447498 are applied. The 3G SAR test reduction procedure is applied to the multiple code channel configuration (FCH+SCH), with FCH only as the primary mode.

LTE Note:

1. Per KDB 941225 D05v02r05, start with the largest channel bandwidth and measure SAR for QPSK with 1 RB allocation, using the RB offset and required test channel combination with the highest maximum output power for RB offsets at the upper edge, middle and lower edge of each required test channel.
2. Per KDB 941225 D05v02r05, 50% RB allocation for QPSK SAR testing follows 1RB QPSK allocation procedure.
3. Per KDB 941225 D05v02r05, for QPSK with 100% RB allocation, SAR is not required when the highest maximum output power for 100 % RB allocation is less than the highest maximum output power in 50% and 1 RB allocations and the highest reported SAR for 1 RB and 50% RB allocation are ≤ 0.8 W/kg. Otherwise, SAR is measured for the highest output power channel; and if the reported SAR is > 1.45 W/kg, the remaining required test channels must also be tested.
4. Per KDB 941225 D05v02r05, 16QAM/64QAM output power for each RB allocation configuration is $>$ not $\frac{1}{2}$ dB higher than the same configuration in QPSK and the reported SAR for the QPSK configuration is ≤ 1.45 W/kg; Per KDB 941225 D05v02r05, 16QAM/64QAM SAR testing is not required.
5. Per KDB 941225 D05v02r05, smaller bandwidth output power for each RB allocation configuration is $>$ not $\frac{1}{2}$ dB higher than the same configuration in the largest supported bandwidth, and the reported SAR for the largest supported bandwidth is ≤ 1.45 W/kg; Per KDB 941225 D05v02r05, smaller bandwidth SAR testing is not required.
6. For LTE B4 / B5 / B12 the maximum bandwidth does not support three non-overlapping channels, per KDB 941225 D05v02r05, when a device supports overlapping channel assignment in a channel bandwidth configuration, the middle channel of the group of overlapping channels should be selected for testing.
7. LTE B4 SAR test was covered by B66; according to April 2015 TCB workshop, SAR test for overlapping LTE bands can be reduced if
 - c. the maximum output power, including tolerance, for the smaller band is \leq the larger band to qualify for the SAR test exclusion
 - d. the channel bandwidth and other operating parameters for the smaller band are fully supported by the larger band



WLAN Note:

1. Per KDB 248227 D01v02r02, for 2.4GHz 802.11g/n SAR testing is not required when the highest reported SAR for DSSS is adjusted by the ratio of OFDM to DSSS specified maximum output power and the adjusted SAR is ≤ 1.2 W/kg.
2. Per KDB 248227 D01v02r02, U-NII-1 SAR testing is not required when the U-NII-2A band highest reported SAR for a test configuration is ≤ 1.2 W/kg, SAR is not required for U-NII-1 band.
3. When the reported SAR of the test position is > 0.4 W/kg, SAR is repeated for the 802.11 transmission mode configuration tested in the initial test position to measure the subsequent next closet/smallest test separation distance and maximum coupling test position on the highest maximum output power channel, until the report SAR is ≤ 0.8 W/kg or all required test position are tested.
4. For all positions / configurations, when the reported SAR is > 0.8 W/kg, SAR is measured for these test positions / configurations on the subsequent next highest measured output power channel(s) until the reported SAR is ≤ 1.2 W/kg or all required channels are tested.
5. During SAR testing the WLAN transmission was verified using a spectrum analyzer.



15.1 Head SAR

<GSM SAR>

Plot No.	Band	Mode	Test Position	Power Mode	Ch.	Freq. (MHz)	Average Power (dBm)	Tune-Up Limit (dBm)	Tune-up Scaling Factor	Power Drift (dB)	Measured 1g SAR (W/kg)	Reported 1g SAR (W/kg)
01	GSM850	GPRS 4 Tx slots	Right Cheek	Full	189	836.4	27.05	27.50	1.109	0.07	0.234	0.260
	GSM850	GPRS 4 Tx slots	Right Tilted	Full	189	836.4	27.05	27.50	1.109	0.02	0.151	0.167
	GSM850	GPRS 4 Tx slots	Left Cheek	Full	189	836.4	27.05	27.50	1.109	-0.03	0.206	0.228
	GSM850	GPRS 4 Tx slots	Left Tilted	Full	189	836.4	27.05	27.50	1.109	0.11	0.141	0.156
02	GSM1900	GPRS 4 Tx slots	Right Cheek	Full	661	1880	23.86	24.50	1.159	-0.03	0.093	0.108
	GSM1900	GPRS 4 Tx slots	Right Tilted	Full	661	1880	23.86	24.50	1.159	0.02	0.031	0.036
	GSM1900	GPRS 4 Tx slots	Left Cheek	Full	661	1880	23.86	24.50	1.159	0.04	0.086	0.099
	GSM1900	GPRS 4 Tx slots	Left Tilted	Full	661	1880	23.86	24.50	1.159	0.07	0.049	0.056

<WCDMA SAR>

Plot No.	Band	Mode	Test Position	Power Mode	Ch.	Freq. (MHz)	Average Power (dBm)	Tune-Up Limit (dBm)	Tune-up Scaling Factor	Power Drift (dB)	Measured 1g SAR (W/kg)	Reported 1g SAR (W/kg)
03	WCDMA Band V	RMC 12.2Kbps	Right Cheek	Full	4233	846.6	23.08	24.00	1.236	0.06	0.332	0.410
	WCDMA Band V	RMC 12.2Kbps	Right Tilted	Full	4233	846.6	23.08	24.00	1.236	0.01	0.172	0.213
	WCDMA Band V	RMC 12.2Kbps	Left Cheek	Full	4233	846.6	23.08	24.00	1.236	0.05	0.258	0.319
	WCDMA Band V	RMC 12.2Kbps	Left Tilted	Full	4233	846.6	23.08	24.00	1.236	0.03	0.173	0.214
04	WCDMA Band IV	RMC 12.2Kbps	Right Cheek	Full	1312	1712.4	23.00	24.00	1.259	0.06	0.155	0.195
	WCDMA Band IV	RMC 12.2Kbps	Right Tilted	Full	1312	1712.4	23.00	24.00	1.259	0.02	0.067	0.085
	WCDMA Band IV	RMC 12.2Kbps	Left Cheek	Full	1312	1712.4	23.00	24.00	1.259	0.11	0.117	0.147
	WCDMA Band IV	RMC 12.2Kbps	Left Tilted	Full	1312	1712.4	23.00	24.00	1.259	-0.02	0.059	0.074
05	WCDMA Band II	RMC 12.2Kbps	Right Cheek	Full	9400	1880	23.26	24.00	1.186	0.01	0.187	0.222
	WCDMA Band II	RMC 12.2Kbps	Right Tilted	Full	9400	1880	23.26	24.00	1.186	0.03	0.064	0.076
	WCDMA Band II	RMC 12.2Kbps	Left Cheek	Full	9400	1880	23.26	24.00	1.186	0.04	0.170	0.202
	WCDMA Band II	RMC 12.2Kbps	Left Tilted	Full	9400	1880	23.26	24.00	1.186	0.08	0.092	0.109

<CDMA2000 SAR>

Plot No.	Band	Mode	Test Position	Power Mode	Ch.	Freq. (MHz)	Average Power (dBm)	Tune-Up Limit (dBm)	Tune-up Scaling Factor	Power Drift (dB)	Measured 1g SAR (W/kg)	Reported 1g SAR (W/kg)
06	CDMA2000 BC0	RC3 SO55	Right Cheek	Full	384	836.52	23.69	25.00	1.352	0.03	0.352	0.476
	CDMA2000 BC0	RC3 SO55	Right Tilted	Full	384	836.52	23.69	25.00	1.352	0.12	0.180	0.243
	CDMA2000 BC0	RC3 SO55	Left Cheek	Full	384	836.52	23.69	25.00	1.352	0.02	0.265	0.358
	CDMA2000 BC0	RC3 SO55	Left Tilted	Full	384	836.52	23.69	25.00	1.352	0.01	0.174	0.235
07	CDMA2000 BC1	RC3 SO55	Right Cheek	Full	600	1880	24.51	25.00	1.119	-0.06	0.226	0.253
	CDMA2000 BC1	RC3 SO55	Right Tilted	Full	600	1880	24.51	25.00	1.119	-0.03	0.071	0.079
	CDMA2000 BC1	RC3 SO55	Left Cheek	Full	600	1880	24.51	25.00	1.119	0.02	0.170	0.190
	CDMA2000 BC1	RC3 SO55	Left Tilted	Full	600	1880	24.51	25.00	1.119	0.05	0.117	0.131



<LTE SAR>

Plot No.	Band	BW (MHz)	Modulation	RB Size	RB Offset	Test Position	Power Mode	Ch.	Freq. (MHz)	Average Power (dBm)	Tune-Up Limit (dBm)	Tune-up Scaling Factor	Power Drift (dB)	Measured 1g SAR (W/kg)	Reported 1g SAR (W/kg)
	LTE Band 71	20M	QPSK	1	49	Right Cheek	Full	133322	683	24.59	25.00	1.099	0.05	0.214	0.235
	LTE Band 71	20M	QPSK	50	24	Right Cheek	Full	133322	683	23.11	24.00	1.227	0.02	0.128	0.157
	LTE Band 71	20M	QPSK	1	49	Right Tilted	Full	133322	683	24.59	25.00	1.099	0.03	0.098	0.107
	LTE Band 71	20M	QPSK	50	24	Right Tilted	Full	133322	683	23.11	24.00	1.227	0.05	0.045	0.055
08	LTE Band 71	20M	QPSK	1	49	Left Cheek	Full	133322	683	24.59	25.00	1.099	-0.17	0.222	0.244
	LTE Band 71	20M	QPSK	50	24	Left Cheek	Full	133322	683	23.11	24.00	1.227	-0.05	0.114	0.140
	LTE Band 71	20M	QPSK	1	49	Left Tilted	Full	133322	683	24.59	25.00	1.099	0.11	0.093	0.102
	LTE Band 71	20M	QPSK	50	24	Left Tilted	Full	133322	683	23.11	24.00	1.227	-0.03	0.055	0.067
09	LTE Band 5	10M	QPSK	1	49	Right Cheek	Full	20525	836.5	23.79	24.00	1.050	0.03	0.365	0.383
	LTE Band 5	10M	QPSK	25	12	Right Cheek	Full	20525	836.5	22.60	23.00	1.096	0.02	0.194	0.213
	LTE Band 5	10M	QPSK	1	49	Right Tilted	Full	20525	836.5	23.79	24.00	1.050	0.04	0.185	0.194
	LTE Band 5	10M	QPSK	25	12	Right Tilted	Full	20525	836.5	22.60	23.00	1.096	0.01	0.095	0.104
	LTE Band 5	10M	QPSK	1	49	Left Cheek	Full	20525	836.5	23.79	24.00	1.050	0.08	0.281	0.295
	LTE Band 5	10M	QPSK	25	12	Left Cheek	Full	20525	836.5	22.60	23.00	1.096	0.04	0.143	0.157
	LTE Band 5	10M	QPSK	1	49	Left Tilted	Full	20525	836.5	23.79	24.00	1.050	0.15	0.192	0.202
	LTE Band 5	10M	QPSK	25	12	Left Tilted	Full	20525	836.5	22.60	23.00	1.096	-0.02	0.095	0.105
10	LTE Band 12	10M	QPSK	1	49	Right Cheek	Full	23095	707.5	23.46	24.00	1.132	0.02	0.231	0.262
	LTE Band 12	10M	QPSK	25	12	Right Cheek	Full	23095	707.5	22.97	23.00	1.007	0.07	0.135	0.136
	LTE Band 12	10M	QPSK	1	49	Right Tilted	Full	23095	707.5	23.46	24.00	1.132	0.04	0.088	0.100
	LTE Band 12	10M	QPSK	25	12	Right Tilted	Full	23095	707.5	22.97	23.00	1.007	-0.11	0.063	0.063
	LTE Band 12	10M	QPSK	1	49	Left Cheek	Full	23095	707.5	23.46	24.00	1.132	-0.03	0.216	0.245
	LTE Band 12	10M	QPSK	25	12	Left Cheek	Full	23095	707.5	22.97	23.00	1.007	0.05	0.124	0.125
	LTE Band 12	10M	QPSK	1	49	Left Tilted	Full	23095	707.5	23.46	24.00	1.132	0.03	0.102	0.116
	LTE Band 12	10M	QPSK	25	12	Left Tilted	Full	23095	707.5	22.97	23.00	1.007	0.04	0.055	0.055
11	LTE Band 13	10M	QPSK	1	49	Right Cheek	Full	23230	782	23.52	24.00	1.117	-0.06	0.326	0.364
	LTE Band 13	10M	QPSK	25	0	Right Cheek	Full	23230	782	22.55	23.00	1.109	-0.11	0.190	0.211
	LTE Band 13	10M	QPSK	1	49	Right Tilted	Full	23230	782	23.52	24.00	1.117	0.05	0.197	0.220
	LTE Band 13	10M	QPSK	25	0	Right Tilted	Full	23230	782	22.55	23.00	1.109	-0.03	0.112	0.124
	LTE Band 13	10M	QPSK	1	49	Left Cheek	Full	23230	782	23.52	24.00	1.117	0.08	0.258	0.288
	LTE Band 13	10M	QPSK	25	0	Left Cheek	Full	23230	782	22.55	23.00	1.109	-0.05	0.145	0.161
	LTE Band 13	10M	QPSK	1	49	Left Tilted	Full	23230	782	23.52	24.00	1.117	0.02	0.180	0.201
	LTE Band 13	10M	QPSK	25	0	Left Tilted	Full	23230	782	22.55	23.00	1.109	0.02	0.106	0.118
12	LTE Band 66	20M	QPSK	1	99	Right Cheek	Full	132322	1745	23.90	24.00	1.023	-0.07	0.158	0.162
	LTE Band 66	20M	QPSK	50	0	Right Cheek	Full	132322	1745	22.76	23.00	1.057	0.07	0.129	0.136
	LTE Band 66	20M	QPSK	1	99	Right Tilted	Full	132322	1745	23.90	24.00	1.023	0.05	0.052	0.053
	LTE Band 66	20M	QPSK	50	0	Right Tilted	Full	132322	1745	22.76	23.00	1.057	-0.11	0.046	0.049
	LTE Band 66	20M	QPSK	1	99	Left Cheek	Full	132322	1745	23.90	24.00	1.023	0.02	0.135	0.138
	LTE Band 66	20M	QPSK	50	0	Left Cheek	Full	132322	1745	22.76	23.00	1.057	0.02	0.113	0.119
	LTE Band 66	20M	QPSK	1	99	Left Tilted	Full	132322	1745	23.90	24.00	1.023	-0.02	0.066	0.067
	LTE Band 66	20M	QPSK	50	0	Left Tilted	Full	132322	1745	22.76	23.00	1.057	-0.03	0.056	0.060
13	LTE Band 2	20M	QPSK	1	99	Right Cheek	Full	18900	1880	23.80	24.00	1.047	-0.04	0.186	0.195
	LTE Band 2	20M	QPSK	50	0	Right Cheek	Full	18900	1880	22.58	23.00	1.102	0.11	0.146	0.161
	LTE Band 2	20M	QPSK	1	99	Right Tilted	Full	18900	1880	23.80	24.00	1.047	-0.02	0.071	0.074
	LTE Band 2	20M	QPSK	50	0	Right Tilted	Full	18900	1880	22.58	23.00	1.102	0.03	0.044	0.048
	LTE Band 2	20M	QPSK	1	99	Left Cheek	Full	18900	1880	23.80	24.00	1.047	0.02	0.152	0.159
	LTE Band 2	20M	QPSK	50	0	Left Cheek	Full	18900	1880	22.58	23.00	1.102	-0.01	0.121	0.133
	LTE Band 2	20M	QPSK	1	99	Left Tilted	Full	18900	1880	23.80	24.00	1.047	0.05	0.085	0.089
	LTE Band 2	20M	QPSK	50	0	Left Tilted	Full	18900	1880	22.58	23.00	1.102	0.01	0.073	0.080



<WLAN 2.4GHz SAR>

Plot No.	Band	Mode	Test Position	Power Mode	Ch.	Freq. (MHz)	Average Power (dBm)	Tune-Up Limit (dBm)	Tune-up Scaling Factor	Duty Cycle %	Duty Cycle Scaling Factor	Power Drift (dB)	Max Area Scan SAR	Measured 1g SAR (W/kg)	Reported 1g SAR (W/kg)
	WLAN2.4GHz	802.11b 1Mbps	Right Cheek	Receiver On	1	2412	16.35	16.50	1.034	97.84	1.022		0.444		
	WLAN2.4GHz	802.11b 1Mbps	Right Tilted	Receiver On	1	2412	16.35	16.50	1.034	97.84	1.022		0.431		
14	WLAN2.4GHz	802.11b 1Mbps	Left Cheek	Receiver On	1	2412	16.35	16.50	1.034	97.84	1.022	0.06	1.14	0.711	0.751
	WLAN2.4GHz	802.11b 1Mbps	Left Tilted	Receiver On	1	2412	16.35	16.50	1.034	97.84	1.022	0.01	0.83	0.542	0.573

<WLAN 5GHz SAR>

Plot No.	Band	Mode	Test Position	Power Mode	Ch.	Freq. (MHz)	Average Power (dBm)	Tune-Up Limit (dBm)	Tune-up Scaling Factor	Duty Cycle %	Duty Cycle Scaling Factor	Power Drift (dB)	Max Area Scan SAR	Measured 1g SAR (W/kg)	Reported 1g SAR (W/kg)
	WLAN5.3GHz	802.11a 6Mbps	Right Cheek	Full	64	5320	18.20	18.50	1.072	87.5	1.143	0.02	0.922	0.335	0.410
	WLAN5.3GHz	802.11a 6Mbps	Right Tilted	Full	64	5320	18.20	18.50	1.072	87.5	1.143		0.806		
	WLAN5.3GHz	802.11a 6Mbps	Left Cheek	Full	64	5320	18.20	18.50	1.072	87.5	1.143	0.12	1.31	0.662	0.811
	WLAN5.3GHz	802.11a 6Mbps	Left Tilted	Full	64	5320	18.20	18.50	1.072	87.5	1.143	0.07	1.36	0.638	0.781
15	WLAN5.3GHz	802.11a 6Mbps	Left Cheek	Full	60	5300	18.13	18.50	1.089	87.5	1.143	0.07		0.674	0.839
	WLAN5.5GHz	802.11a 6Mbps	Right Cheek	Full	132	5660	17.95	18.50	1.135	87.5	1.143		0.625		
	WLAN5.5GHz	802.11a 6Mbps	Right Tilted	Full	132	5660	17.95	18.50	1.135	87.5	1.143		0.601		
16	WLAN5.5GHz	802.11a 6Mbps	Left Cheek	Full	132	5660	17.95	18.50	1.135	87.5	1.143	-0.11	0.631	0.277	0.359
	WLAN5.5GHz	802.11a 6Mbps	Left Tilted	Full	132	5660	17.95	18.50	1.135	87.5	1.143		0.591		
	WLAN 5.8GHz	802.11a 6Mbps	Right Cheek	Full	149	5745	17.60	18.00	1.097	87.5	1.143		0.347		
	WLAN 5.8GHz	802.11a 6Mbps	Right Tilted	Full	149	5745	17.60	18.00	1.097	87.5	1.143		0.536		
	WLAN 5.8GHz	802.11a 6Mbps	Left Cheek	Full	149	5745	17.60	18.00	1.097	87.5	1.143		0.461		
17	WLAN 5.8GHz	802.11a 6Mbps	Left Tilted	Full	149	5745	17.60	18.00	1.097	87.5	1.143	0.03	0.657	0.259	0.325



15.2 Hotspot SAR

<GSM SAR>

Plot No.	Band	Mode	Test Position	Gap (mm)	Power Mode	Ch.	Freq. (MHz)	Average Power (dBm)	Tune-Up Limit (dBm)	Tune-up Scaling Factor	Power Drift (dB)	Measured 1g SAR (W/kg)	Reported 1g SAR (W/kg)
	GSM850	GPRS 4 Tx slots	Front	5	Full	189	836.4	27.05	27.50	1.109	-0.03	0.896	0.994
	GSM850	GPRS 4 Tx slots	Back	5	Full	189	836.4	27.05	27.50	1.109	0.02	0.592	0.657
	GSM850	GPRS 4 Tx slots	Left Side	5	Full	189	836.4	27.05	27.50	1.109	0.05	0.216	0.240
	GSM850	GPRS 4 Tx slots	Right Side	5	Full	189	836.4	27.05	27.50	1.109	-0.02	0.506	0.561
	GSM850	GPRS 4 Tx slots	Bottom Side	5	Full	189	836.4	27.05	27.50	1.109	0.01	0.548	0.608
	GSM850	GPRS 4 Tx slots	Front	5	Full	128	824.2	27.00	27.50	1.122	-0.09	0.844	0.947
18	GSM850	GPRS 4 Tx slots	Front	5	Full	251	848.8	27.02	27.50	1.117	-0.08	0.904	1.010
	GSM1900	GPRS 1 Tx slot	Front	5	Hotspot On	661	1880	23.57	24.50	1.239	0.02	0.604	0.748
	GSM1900	GPRS 1 Tx slot	Back	5	Hotspot On	661	1880	23.57	24.50	1.239	0.02	0.375	0.465
	GSM1900	GPRS 1 Tx slot	Left Side	5	Hotspot On	661	1880	23.57	24.50	1.239	-0.03	0.018	0.022
	GSM1900	GPRS 1 Tx slot	Right Side	5	Hotspot On	661	1880	23.57	24.50	1.239	0.01	0.056	0.069
	GSM1900	GPRS 1 Tx slot	Bottom Side	5	Hotspot On	661	1880	23.57	24.50	1.239	0.11	0.749	0.928
	GSM1900	GPRS 1 Tx slot	Bottom Side	5	Hotspot On	512	1850.2	23.56	24.50	1.242	0.07	0.652	0.810
19	GSM1900	GPRS 1 Tx slot	Bottom Side	5	Hotspot On	810	1909.8	23.48	24.50	1.265	0.09	0.772	0.976

<WCDMA SAR>

Plot No.	Band	Mode	Test Position	Gap (mm)	Power Mode	Ch.	Freq. (MHz)	Average Power (dBm)	Tune-Up Limit (dBm)	Tune-up Scaling Factor	Power Drift (dB)	Measured 1g SAR (W/kg)	Reported 1g SAR (W/kg)
20	WCDMA Band V	RMC 12.2Kbps	Front	5	Hotspot On	4233	846.6	22.59	23.00	1.099	0.01	0.863	0.948
	WCDMA Band V	RMC 12.2Kbps	Back	5	Hotspot On	4233	846.6	22.59	23.00	1.099	0.11	0.539	0.592
	WCDMA Band V	RMC 12.2Kbps	Left Side	5	Hotspot On	4233	846.6	22.59	23.00	1.099	-0.05	0.192	0.211
	WCDMA Band V	RMC 12.2Kbps	Right Side	5	Hotspot On	4233	846.6	22.59	23.00	1.099	0.01	0.397	0.436
	WCDMA Band V	RMC 12.2Kbps	Bottom Side	5	Hotspot On	4233	846.6	22.59	23.00	1.099	0.1	0.594	0.653
	WCDMA Band V	RMC 12.2Kbps	Front	5	Hotspot On	4132	826.4	22.35	23.00	1.161	0.06	0.785	0.912
	WCDMA Band V	RMC 12.2Kbps	Front	5	Hotspot On	4182	836.4	22.39	23.00	1.151	-0.01	0.769	0.885
	WCDMA Band IV	RMC 12.2Kbps	Front	5	Hotspot On	1312	1712.4	16.74	17.00	1.062	0.01	0.724	0.769
	WCDMA Band IV	RMC 12.2Kbps	Back	5	Hotspot On	1312	1712.4	16.74	17.00	1.062	0.02	0.459	0.487
	WCDMA Band IV	RMC 12.2Kbps	Left Side	5	Hotspot On	1312	1712.4	16.74	17.00	1.062	-0.14	0.112	0.119
	WCDMA Band IV	RMC 12.2Kbps	Right Side	5	Hotspot On	1312	1712.4	16.74	17.00	1.062	0.01	0.306	0.325
	WCDMA Band IV	RMC 12.2Kbps	Bottom Side	5	Hotspot On	1312	1712.4	16.74	17.00	1.062	0.01	0.888	0.943
	WCDMA Band IV	RMC 12.2Kbps	Bottom Side	5	Hotspot On	1413	1732.6	16.73	17.00	1.064	0.16	0.845	0.899
21	WCDMA Band IV	RMC 12.2Kbps	Bottom Side	5	Hotspot On	1513	1752.6	16.71	17.00	1.069	0.05	0.907	0.970
	WCDMA Band II	RMC 12.2Kbps	Front	5	Hotspot On	9400	1880	14.49	15.00	1.125	0.02	0.644	0.724
	WCDMA Band II	RMC 12.2Kbps	Back	5	Hotspot On	9400	1880	14.49	15.00	1.125	0.05	0.424	0.477
	WCDMA Band II	RMC 12.2Kbps	Left Side	5	Hotspot On	9400	1880	14.49	15.00	1.125	0.04	0.032	0.036
	WCDMA Band II	RMC 12.2Kbps	Right Side	5	Hotspot On	9400	1880	14.49	15.00	1.125	0.08	0.061	0.068
	WCDMA Band II	RMC 12.2Kbps	Bottom Side	5	Hotspot On	9400	1880	14.49	15.00	1.125	0.11	0.921	1.036
	WCDMA Band II	RMC 12.2Kbps	Bottom Side	5	Hotspot On	9262	1852.4	14.46	15.00	1.132	-0.07	0.807	0.914
22	WCDMA Band II	RMC 12.2Kbps	Bottom Side	5	Hotspot On	9538	1907.6	14.32	15.00	1.169	0.13	0.992	1.160



<CDMA2000 SAR>

Plot No.	Band	Mode	Test Position	Gap (mm)	Power Mode	Ch.	Freq. (MHz)	Average Power (dBm)	Tune-Up Limit (dBm)	Tune-up Scaling Factor	Power Drift (dB)	Measured 1g SAR (W/kg)	Reported 1g SAR (W/kg)
23	CDMA2000 BC0	RTAP 153.6Kbps	Front	5	Hotspot On	384	836.52	22.08	22.50	1.102	0.05	0.609	0.671
	CDMA2000 BC0	RTAP 153.6Kbps	Back	5	Hotspot On	384	836.52	22.08	22.50	1.102	-0.05	0.457	0.503
	CDMA2000 BC0	RTAP 153.6Kbps	Left Side	5	Hotspot On	384	836.52	22.08	22.50	1.102	0.04	0.116	0.128
	CDMA2000 BC0	RTAP 153.6Kbps	Right Side	5	Hotspot On	384	836.52	22.08	22.50	1.102	0.12	0.336	0.370
	CDMA2000 BC0	RTAP 153.6Kbps	Bottom Side	5	Hotspot On	384	836.52	22.08	22.50	1.102	0.07	0.426	0.469
	CDMA2000 BC1	RTAP 153.6Kbps	Front	5	Hotspot On	600	1880	15.78	16.00	1.052	0.03	0.700	0.736
	CDMA2000 BC1	RTAP 153.6Kbps	Back	5	Hotspot On	600	1880	15.78	16.00	1.052	-0.04	0.451	0.474
	CDMA2000 BC1	RTAP 153.6Kbps	Left Side	5	Hotspot On	600	1880	15.78	16.00	1.052	0.08	0.035	0.037
	CDMA2000 BC1	RTAP 153.6Kbps	Right Side	5	Hotspot On	600	1880	15.78	16.00	1.052	-0.07	0.068	0.071
	CDMA2000 BC1	RTAP 153.6Kbps	Bottom Side	5	Hotspot On	600	1880	15.78	16.00	1.052	0.12	0.955	1.005
	CDMA2000 BC1	RTAP 153.6Kbps	Bottom Side	5	Hotspot On	25	1851.25	15.74	16.00	1.062	0.06	0.828	0.879
24	CDMA2000 BC1	RTAP 153.6Kbps	Bottom Side	5	Hotspot On	1175	1908.75	15.77	16.00	1.054	-0.05	1.050	1.107



<LTE SAR>

Plot No.	Band	BW (MHz)	Modulation	RB Size	RB Offset	Test Position	Gap (mm)	Power Mode	Ch.	Freq. (MHz)	Average Power (dBm)	Tune-Up Limit (dBm)	Tune-up Scaling Factor	Power Drift (dB)	Measured 1g SAR (W/kg)	Reported 1g SAR (W/kg)
25	LTE Band 71	20M	QPSK	1	49	Front	5	Full	133322	683	24.59	25.00	1.099	0.08	0.762	0.837
	LTE Band 71	20M	QPSK	1	49	Front	5	Full	133222	673	24.42	25.00	1.143	0.04	0.721	0.824
	LTE Band 71	20M	QPSK	1	49	Front	5	Full	133372	688	24.57	25.00	1.104	0.07	0.736	0.813
	LTE Band 71	20M	QPSK	50	24	Front	5	Full	133322	683	23.11	24.00	1.227	-0.01	0.383	0.470
	LTE Band 71	20M	QPSK	100	0	Front	5	Full	133322	683	22.89	24.00	1.291	0.05	0.359	0.464
	LTE Band 71	20M	QPSK	1	49	Back	5	Full	133322	683	24.59	25.00	1.099	0.02	0.364	0.400
	LTE Band 71	20M	QPSK	50	24	Back	5	Full	133322	683	23.11	24.00	1.227	0.01	0.249	0.306
	LTE Band 71	20M	QPSK	1	49	Left Side	5	Full	133322	683	24.59	25.00	1.099	-0.1	0.179	0.197
	LTE Band 71	20M	QPSK	50	24	Left Side	5	Full	133322	683	23.11	24.00	1.227	0.03	0.132	0.162
	LTE Band 71	20M	QPSK	1	49	Right Side	5	Full	133322	683	24.59	25.00	1.099	0.03	0.378	0.415
	LTE Band 71	20M	QPSK	50	24	Right Side	5	Full	133322	683	23.11	24.00	1.227	0.04	0.405	0.497
	LTE Band 71	20M	QPSK	1	49	Bottom Side	5	Full	133322	683	24.59	25.00	1.099	-0.03	0.357	0.392
	LTE Band 71	20M	QPSK	50	24	Bottom Side	5	Full	133322	683	23.11	24.00	1.227	0.05	0.194	0.238
26	LTE Band 5	10M	QPSK	1	49	Front	5	Hotspot On	20525	836.5	22.70	23.00	1.072	0.09	0.688	0.737
	LTE Band 5	10M	QPSK	25	12	Front	5	Hotspot On	20525	836.5	21.85	22.00	1.035	0.06	0.464	0.480
	LTE Band 5	10M	QPSK	1	49	Back	5	Hotspot On	20525	836.5	22.70	23.00	1.072	-0.08	0.437	0.468
	LTE Band 5	10M	QPSK	25	12	Back	5	Hotspot On	20525	836.5	21.85	22.00	1.035	0.01	0.305	0.316
	LTE Band 5	10M	QPSK	1	49	Left Side	5	Hotspot On	20525	836.5	22.70	23.00	1.072	0.14	0.140	0.150
	LTE Band 5	10M	QPSK	25	12	Left Side	5	Hotspot On	20525	836.5	21.85	22.00	1.035	-0.03	0.097	0.100
	LTE Band 5	10M	QPSK	1	49	Right Side	5	Hotspot On	20525	836.5	22.70	23.00	1.072	0.17	0.343	0.368
	LTE Band 5	10M	QPSK	25	12	Right Side	5	Hotspot On	20525	836.5	21.85	22.00	1.035	0.08	0.223	0.231
	LTE Band 5	10M	QPSK	1	49	Bottom Side	5	Hotspot On	20525	836.5	22.70	23.00	1.072	0.01	0.474	0.508
	LTE Band 5	10M	QPSK	25	12	Bottom Side	5	Hotspot On	20525	836.5	21.85	22.00	1.035	0.02	0.317	0.328
27	LTE Band 12	10M	QPSK	1	49	Front	5	Full	23095	707.5	23.46	24.00	1.132	-0.01	0.615	0.696
	LTE Band 12	10M	QPSK	25	12	Front	5	Full	23095	707.5	22.97	23.00	1.007	-0.03	0.368	0.371
	LTE Band 12	10M	QPSK	1	49	Back	5	Full	23095	707.5	23.46	24.00	1.132	0.01	0.398	0.451
	LTE Band 12	10M	QPSK	25	12	Back	5	Full	23095	707.5	22.97	23.00	1.007	0.05	0.244	0.246
	LTE Band 12	10M	QPSK	1	49	Left Side	5	Full	23095	707.5	23.46	24.00	1.132	0.05	0.268	0.303
	LTE Band 12	10M	QPSK	25	12	Left Side	5	Full	23095	707.5	22.97	23.00	1.007	-0.04	0.159	0.160
	LTE Band 12	10M	QPSK	1	49	Right Side	5	Full	23095	707.5	23.46	24.00	1.132	0.08	0.388	0.439
	LTE Band 12	10M	QPSK	25	12	Right Side	5	Full	23095	707.5	22.97	23.00	1.007	0.04	0.233	0.235
	LTE Band 12	10M	QPSK	1	49	Bottom Side	5	Full	23095	707.5	23.46	24.00	1.132	-0.11	0.361	0.409
	LTE Band 12	10M	QPSK	25	12	Bottom Side	5	Full	23095	707.5	22.97	23.00	1.007	0.02	0.206	0.207
28	LTE Band 13	10M	QPSK	1	49	Front	5	Full	23230	782	23.52	24.00	1.117	0.15	0.757	0.845
	LTE Band 13	10M	QPSK	25	0	Front	5	Full	23230	782	22.55	23.00	1.109	-0.02	0.497	0.551
	LTE Band 13	10M	QPSK	50	0	Front	5	Full	23230	782	22.46	23.00	1.132	0.05	0.547	0.619
	LTE Band 13	10M	QPSK	1	49	Back	5	Full	23230	782	23.52	24.00	1.117	0.07	0.497	0.555
	LTE Band 13	10M	QPSK	25	0	Back	5	Full	23230	782	22.55	23.00	1.109	0.05	0.313	0.347
	LTE Band 13	10M	QPSK	1	49	Left Side	5	Full	23230	782	23.52	24.00	1.117	-0.02	0.317	0.354
	LTE Band 13	10M	QPSK	25	0	Left Side	5	Full	23230	782	22.55	23.00	1.109	0.03	0.203	0.225
	LTE Band 13	10M	QPSK	1	49	Right Side	5	Full	23230	782	23.52	24.00	1.117	-0.05	0.590	0.659
	LTE Band 13	10M	QPSK	25	0	Right Side	5	Full	23230	782	22.55	23.00	1.109	0.04	0.362	0.402
	LTE Band 13	10M	QPSK	1	49	Bottom Side	5	Full	23230	782	23.52	24.00	1.117	0.04	0.442	0.494
	LTE Band 13	10M	QPSK	25	0	Bottom Side	5	Full	23230	782	22.55	23.00	1.109	0.11	0.292	0.324



Plot No.	Band	BW (MHz)	Modulation	RB Size	RB Offset	Test Position	Gap (mm)	Power Mode	Ch.	Freq. (MHz)	Average Power (dBm)	Tune-Up Limit (dBm)	Tune-up Scaling Factor	Power Drift (dB)	Measured 1g SAR (W/kg)	Reported 1g SAR (W/kg)
	LTE Band 66	20M	QPSK	1	99	Front	5	Hotspot On	132322	1745	17.45	17.50	1.012	0.02	0.811	0.820
	LTE Band 66	20M	QPSK	1	99	Front	5	Hotspot On	132072	1720	17.44	17.50	1.014	0.06	0.740	0.750
	LTE Band 66	20M	QPSK	1	99	Front	5	Hotspot On	132572	1770	17.18	17.50	1.076	0.01	0.870	0.937
	LTE Band 66	20M	QPSK	50	0	Front	5	Hotspot On	132322	1745	16.97	17.50	1.130	-0.08	0.747	0.844
	LTE Band 66	20M	QPSK	50	0	Front	5	Hotspot On	132072	1720	16.95	17.50	1.135	0.05	0.613	0.696
	LTE Band 66	20M	QPSK	50	0	Front	5	Hotspot On	132572	1770	16.81	17.50	1.172	0.03	0.759	0.890
	LTE Band 66	20M	QPSK	100	0	Front	5	Hotspot On	132322	1745	17.09	17.50	1.099	0.05	0.680	0.747
	LTE Band 66	20M	QPSK	1	99	Back	5	Hotspot On	132322	1745	17.45	17.50	1.012	-0.05	0.526	0.532
	LTE Band 66	20M	QPSK	50	0	Back	5	Hotspot On	132322	1745	16.97	17.50	1.130	-0.02	0.445	0.503
	LTE Band 66	20M	QPSK	1	99	Left Side	5	Hotspot On	132322	1745	17.45	17.50	1.012	0.02	0.042	0.043
	LTE Band 66	20M	QPSK	50	0	Left Side	5	Hotspot On	132322	1745	16.97	17.50	1.130	0.05	0.038	0.043
	LTE Band 66	20M	QPSK	1	99	Right Side	5	Hotspot On	132322	1745	17.45	17.50	1.012	0.01	0.096	0.097
	LTE Band 66	20M	QPSK	50	0	Right Side	5	Hotspot On	132322	1745	16.97	17.50	1.130	0.05	0.087	0.099
	LTE Band 66	20M	QPSK	1	99	Bottom Side	5	Hotspot On	132322	1745	17.45	17.50	1.012	-0.03	0.905	0.915
	LTE Band 66	20M	QPSK	1	99	Bottom Side	5	Hotspot On	132072	1720	17.44	17.50	1.014	0.08	0.837	0.849
29	LTE Band 66	20M	QPSK	1	99	Bottom Side	5	Hotspot On	132572	1770	17.18	17.50	1.076	0.02	1.070	1.152
	LTE Band 66	20M	QPSK	50	0	Bottom Side	5	Hotspot On	132322	1745	16.97	17.50	1.130	-0.02	0.758	0.856
	LTE Band 66	20M	QPSK	50	0	Bottom Side	5	Hotspot On	132072	1720	16.95	17.50	1.135	-0.06	0.682	0.774
	LTE Band 66	20M	QPSK	50	0	Bottom Side	5	Hotspot On	132572	1770	16.81	17.50	1.172	-0.02	0.894	1.048
	LTE Band 66	20M	QPSK	100	0	Bottom Side	5	Hotspot On	132322	1745	17.09	17.50	1.099	-0.03	0.830	0.912
	LTE Band 2	20M	QPSK	1	99	Front	5	Hotspot On	18900	1880	15.23	15.50	1.064	-0.17	0.752	0.800
	LTE Band 2	20M	QPSK	1	99	Front	5	Hotspot On	18700	1860	15.08	15.50	1.102	0.03	0.791	0.871
	LTE Band 2	20M	QPSK	1	99	Front	5	Hotspot On	19100	1900	15.10	15.50	1.096	-0.03	0.880	0.965
	LTE Band 2	20M	QPSK	50	0	Front	5	Hotspot On	18900	1880	14.96	15.50	1.132	0.04	0.776	0.879
	LTE Band 2	20M	QPSK	50	0	Front	5	Hotspot On	18700	1860	14.94	15.50	1.138	-0.13	0.743	0.845
	LTE Band 2	20M	QPSK	50	0	Front	5	Hotspot On	19100	1900	14.95	15.50	1.135	0.05	0.772	0.876
	LTE Band 2	20M	QPSK	100	0	Front	5	Hotspot On	18900	1880	14.96	15.50	1.132	0.02	0.784	0.888
	LTE Band 2	20M	QPSK	1	99	Back	5	Hotspot On	18900	1880	15.23	15.50	1.064	0.11	0.591	0.629
	LTE Band 2	20M	QPSK	50	0	Back	5	Hotspot On	18900	1880	14.96	15.50	1.132	0.05	0.547	0.619
	LTE Band 2	20M	QPSK	1	99	Left Side	5	Hotspot On	18900	1880	15.23	15.50	1.064	-0.02	0.038	0.040
	LTE Band 2	20M	QPSK	50	0	Left Side	5	Hotspot On	18900	1880	14.96	15.50	1.132	0.02	0.038	0.043
	LTE Band 2	20M	QPSK	1	99	Right Side	5	Hotspot On	18900	1880	15.23	15.50	1.064	0.03	0.073	0.077
	LTE Band 2	20M	QPSK	50	0	Right Side	5	Hotspot On	18900	1880	14.96	15.50	1.132	0.01	0.071	0.080
	LTE Band 2	20M	QPSK	1	99	Bottom Side	5	Hotspot On	18900	1880	15.23	15.50	1.064	0.09	1.010	1.075
	LTE Band 2	20M	QPSK	1	99	Bottom Side	5	Hotspot On	18700	1860	15.08	15.50	1.102	-0.02	0.926	1.020
30	LTE Band 2	20M	QPSK	1	99	Bottom Side	5	Hotspot On	19100	1900	15.10	15.50	1.096	-0.08	1.060	1.162
	LTE Band 2	20M	QPSK	50	0	Bottom Side	5	Hotspot On	18900	1880	14.96	15.50	1.132	-0.03	0.915	1.036
	LTE Band 2	20M	QPSK	50	0	Bottom Side	5	Hotspot On	18700	1860	14.94	15.50	1.138	0.1	0.841	0.957
	LTE Band 2	20M	QPSK	50	0	Bottom Side	5	Hotspot On	19100	1900	14.95	15.50	1.135	-0.09	0.981	1.113
	LTE Band 2	20M	QPSK	100	0	Bottom Side	5	Hotspot On	18900	1880	14.96	15.50	1.132	0.04	0.882	0.999

<WLAN 2.4GHz SAR>

Plot No.	Band	Mode	Test Position	Gap (mm)	Power Mode	Ch.	Freq. (MHz)	Average Power (dBm)	Tune-Up Limit (dBm)	Tune-up Scaling Factor	Duty Cycle %	Duty Cycle Scaling Factor	Power Drift (dB)	Measured 1g SAR (W/kg)	Reported 1g SAR (W/kg)
	WLAN2.4GHz	802.11b 1Mbps	Front	5	Full	6	2437	19.17	19.50	1.078	97.84	1.022	0.07	0.489	0.539
31	WLAN2.4GHz	802.11b 1Mbps	Back	5	Full	6	2437	19.17	19.50	1.078	97.84	1.022	0.01	0.569	0.627
	WLAN2.4GHz	802.11b 1Mbps	Right Side	5	Full	6	2437	19.17	19.50	1.078	97.84	1.022	0.02	0.413	0.455
	WLAN2.4GHz	802.11b 1Mbps	Top Side	5	Full	6	2437	19.17	19.50	1.078	97.84	1.022	-0.01	0.341	0.376

<WLAN 5GHz SAR>

Plot No.	Band	Mode	Test Position	Gap (mm)	Power Mode	Ch.	Freq. (MHz)	Average Power (dBm)	Tune-Up Limit (dBm)	Tune-up Scaling Factor	Duty Cycle %	Duty Cycle Scaling Factor	Power Drift (dB)	Measured 1g SAR (W/kg)	Reported 1g SAR (W/kg)
	WLAN5.2GHz	802.11a 6Mbps	Front	5	Full	48	5240	18.08	18.50	1.102	87.50	1.143	0.05	0.303	0.381
32	WLAN5.2GHz	802.11a 6Mbps	Back	5	Full	48	5240	18.08	18.50	1.102	87.50	1.143	0.01	0.806	1.015
	WLAN5.2GHz	802.11a 6Mbps	Right Side	5	Full	48	5240	18.08	18.50	1.102	87.50	1.143	0.04	0.117	0.147
	WLAN5.2GHz	802.11a 6Mbps	Top Side	5	Full	48	5240	18.08	18.50	1.102	87.50	1.143	0.02	0.455	0.573
	WLAN5.2GHz	802.11a 6Mbps	Back	5	Full	44	5220	18.06	18.50	1.107	87.50	1.143	0.12	0.710	0.898
	WLAN 5.8GHz	802.11a 6Mbps	Front	5	Hotspot On	149	5745	14.97	15.50	1.130	87.50	1.143	0.09	0.012	0.016
	WLAN 5.8GHz	802.11a 6Mbps	Back	5	Hotspot On	149	5745	14.97	15.50	1.130	87.50	1.143	0.02	0.785	1.014
	WLAN 5.8GHz	802.11a 6Mbps	Right Side	5	Hotspot On	149	5745	14.97	15.50	1.130	87.50	1.143	0.03	0.003	0.004
	WLAN 5.8GHz	802.11a 6Mbps	Top Side	5	Hotspot On	149	5745	14.97	15.50	1.130	87.50	1.143	0.07	0.435	0.562
33	WLAN 5.8GHz	802.11a 6Mbps	Back	5	Hotspot On	157	5785	14.94	15.50	1.138	87.50	1.143	0.04	0.804	1.045

<Bluetooth SAR>

Plot No.	Band	Mode	Test Position	Gap (mm)	Ch.	Freq. (MHz)	Average Power (dBm)	Tune-Up Limit (dBm)	Tune-up Scaling Factor	Duty Cycle %	Duty Cycle Scaling Factor	Power Drift (dB)	Measured 1g SAR (W/kg)	Reported 1g SAR (W/kg)
	Bluetooth	1Mbps	Front	5	39	2441	10.85	11.50	1.161	76.74	1.085	0.06	0.058	0.073
34	Bluetooth	1Mbps	Back	5	39	2441	10.85	11.50	1.161	76.74	1.085	-0.05	0.075	0.095
	Bluetooth	1Mbps	Right Side	5	39	2441	10.85	11.50	1.161	76.74	1.085	-0.02	0.053	0.066
	Bluetooth	1Mbps	Top Side	5	39	2441	10.85	11.50	1.161	76.74	1.085	0.07	0.052	0.066

15.3 Body Worn Accessory SAR

<GSM SAR>

Plot No.	Band	Mode	Test Position	Gap (mm)	Power Mode	Ch.	Freq. (MHz)	Average Power (dBm)	Tune-Up Limit (dBm)	Tune-up Scaling Factor	Power Drift (dB)	Measured 1g SAR (W/kg)	Reported 1g SAR (W/kg)
	GSM850	GPRS 4 Tx slots	Front	5	Full	189	836.4	27.05	27.50	1.109	-0.03	0.896	0.994
	GSM850	GPRS 4 Tx slots	Back	5	Full	189	836.4	27.05	27.50	1.109	0.02	0.592	0.657
	GSM850	GPRS 4 Tx slots	Front	5	Full	128	824.2	27.00	27.50	1.122	-0.09	0.844	0.947
35	GSM850	GPRS 4 Tx slots	Front	5	Full	251	848.8	27.02	27.50	1.117	-0.08	0.904	1.010
36	GSM1900	GPRS 1 Tx slot	Front	5	P-Sensor On	661	1880	23.57	24.50	1.239	0.02	0.604	0.748
	GSM1900	GPRS 1 Tx slot	Back	5	P-Sensor On	661	1880	23.57	24.50	1.239	0.02	0.375	0.465

<WCDMA SAR>

Plot No.	Band	Mode	Test Position	Gap (mm)	Power Mode	Ch.	Freq. (MHz)	Average Power (dBm)	Tune-Up Limit (dBm)	Tune-up Scaling Factor	Power Drift (dB)	Measured 1g SAR (W/kg)	Reported 1g SAR (W/kg)
37	WCDMA Band V	RMC 12.2Kbps	Front	5	P-Sensor On	4233	846.6	22.59	23.00	1.099	0.01	0.863	0.948
	WCDMA Band V	RMC 12.2Kbps	Back	5	P-Sensor On	4233	846.6	22.59	23.00	1.099	0.11	0.539	0.592
	WCDMA Band V	RMC 12.2Kbps	Front	5	P-Sensor On	4132	826.4	22.35	23.00	1.161	0.06	0.785	0.912
	WCDMA Band V	RMC 12.2Kbps	Front	5	P-Sensor On	4182	836.4	22.39	23.00	1.151	-0.01	0.769	0.885
38	WCDMA Band IV	RMC 12.2Kbps	Front	5	P-Sensor On	1312	1712.4	16.74	17.00	1.062	0.01	0.724	0.769
	WCDMA Band IV	RMC 12.2Kbps	Back	5	P-Sensor On	1312	1712.4	16.74	17.00	1.062	0.02	0.459	0.487
39	WCDMA Band II	RMC 12.2Kbps	Front	5	P-Sensor On	9400	1880	14.49	15.00	1.125	0.02	0.644	0.724
	WCDMA Band II	RMC 12.2Kbps	Back	5	P-Sensor On	9400	1880	14.49	15.00	1.125	0.05	0.424	0.477

<CDMA2000 SAR>

Plot No.	Band	Mode	Test Position	Gap (mm)	Power Mode	Ch.	Freq. (MHz)	Average Power (dBm)	Tune-Up Limit (dBm)	Tune-up Scaling Factor	Power Drift (dB)	Measured 1g SAR (W/kg)	Reported 1g SAR (W/kg)
40	CDMA2000 BC0	RC3 SO32(F+SCH)	Front	5	P-Sensor On	384	836.52	22.09	22.50	1.099	0.09	0.671	0.737
	CDMA2000 BC0	RC3 SO32(F+SCH)	Back	5	P-Sensor On	384	836.52	22.09	22.50	1.099	0.05	0.439	0.482
41	CDMA2000 BC1	RC3 SO32(F+SCH)	Front	5	P-Sensor On	600	1880	15.83	16.00	1.040	0.09	0.701	0.729
	CDMA2000 BC1	RC3 SO32(F+SCH)	Back	5	P-Sensor On	600	1880	15.83	16.00	1.040	0.07	0.449	0.467



<LTE SAR>

Plot No.	Band	BW (MHz)	Modulation	RB Size	RB Offset	Test Position	Gap (mm)	Power Mode	Ch.	Freq. (MHz)	Average Power (dBm)	Tune-Up Limit (dBm)	Tune-up Scaling Factor	Power Drift (dB)	Measured 1g SAR (W/kg)	Reported 1g SAR (W/kg)
42	LTE Band 71	20M	QPSK	1	49	Front	5	Full	133322	683	24.59	25.00	1.099	0.08	0.762	0.837
	LTE Band 71	20M	QPSK	1	49	Front	5	Full	133222	673	24.42	25.00	1.143	0.04	0.721	0.824
	LTE Band 71	20M	QPSK	1	49	Front	5	Full	133372	688	24.57	25.00	1.104	0.07	0.736	0.813
	LTE Band 71	20M	QPSK	50	24	Front	5	Full	133322	683	23.11	24.00	1.227	-0.01	0.383	0.470
	LTE Band 71	20M	QPSK	100	0	Front	5	Full	133322	683	22.89	24.00	1.291	0.05	0.359	0.464
	LTE Band 71	20M	QPSK	1	49	Back	5	Full	133322	683	24.59	25.00	1.099	0.02	0.364	0.400
	LTE Band 71	20M	QPSK	50	24	Back	5	Full	133322	683	23.11	24.00	1.227	0.01	0.249	0.306
43	LTE Band 5	10M	QPSK	1	49	Front	5	P-Sensor On	20525	836.5	22.70	23.00	1.072	0.09	0.688	0.737
	LTE Band 5	10M	QPSK	25	12	Front	5	P-Sensor On	20525	836.5	21.85	22.00	1.035	0.06	0.464	0.480
	LTE Band 5	10M	QPSK	1	49	Back	5	P-Sensor On	20525	836.5	22.70	23.00	1.072	-0.08	0.437	0.468
	LTE Band 5	10M	QPSK	25	12	Back	5	P-Sensor On	20525	836.5	21.85	22.00	1.035	0.01	0.305	0.316
44	LTE Band 12	10M	QPSK	1	49	Front	5	Full	23095	707.5	23.46	24.00	1.132	-0.01	0.615	0.696
	LTE Band 12	10M	QPSK	25	12	Front	5	Full	23095	707.5	22.97	23.00	1.007	-0.03	0.368	0.371
	LTE Band 12	10M	QPSK	1	49	Back	5	Full	23095	707.5	23.46	24.00	1.132	0.01	0.398	0.451
	LTE Band 12	10M	QPSK	25	12	Back	5	Full	23095	707.5	22.97	23.00	1.007	0.05	0.244	0.246
45	LTE Band 13	10M	QPSK	1	49	Front	5	Full	23230	782	23.52	24.00	1.117	0.15	0.757	0.845
	LTE Band 13	10M	QPSK	25	0	Front	5	Full	23230	782	22.55	23.00	1.109	-0.02	0.497	0.551
	LTE Band 13	10M	QPSK	50	0	Front	5	Full	23230	782	22.46	23.00	1.132	0.05	0.547	0.619
	LTE Band 13	10M	QPSK	1	49	Back	5	Full	23230	782	23.52	24.00	1.117	0.07	0.497	0.555
	LTE Band 13	10M	QPSK	25	0	Back	5	Full	23230	782	22.55	23.00	1.109	0.05	0.313	0.347
	LTE Band 66	20M	QPSK	1	99	Front	5	P-Sensor On	132322	1745	17.45	17.50	1.012	0.02	0.811	0.820
	LTE Band 66	20M	QPSK	1	99	Front	5	P-Sensor On	132072	1720	17.44	17.50	1.014	0.06	0.740	0.750
46	LTE Band 66	20M	QPSK	1	99	Front	5	P-Sensor On	132572	1770	17.18	17.50	1.076	0.01	0.870	0.937
	LTE Band 66	20M	QPSK	50	0	Front	5	P-Sensor On	132322	1745	16.97	17.50	1.130	-0.08	0.747	0.844
	LTE Band 66	20M	QPSK	50	0	Front	5	P-Sensor On	132072	1720	16.95	17.50	1.135	0.05	0.613	0.696
	LTE Band 66	20M	QPSK	50	0	Front	5	P-Sensor On	132572	1770	16.81	17.50	1.172	0.03	0.759	0.890
	LTE Band 66	20M	QPSK	100	0	Front	5	P-Sensor On	132322	1745	17.09	17.50	1.099	0.05	0.680	0.747
	LTE Band 66	20M	QPSK	1	99	Back	5	P-Sensor On	132322	1745	17.45	17.50	1.012	-0.05	0.526	0.532
	LTE Band 66	20M	QPSK	50	0	Back	5	P-Sensor On	132322	1745	16.97	17.50	1.130	-0.02	0.445	0.503
	LTE Band 2	20M	QPSK	1	99	Front	5	P-Sensor On	18900	1880	15.23	15.50	1.064	-0.17	0.752	0.800
	LTE Band 2	20M	QPSK	1	99	Front	5	P-Sensor On	18700	1860	15.08	15.50	1.102	0.03	0.791	0.871
47	LTE Band 2	20M	QPSK	1	99	Front	5	P-Sensor On	19100	1900	15.10	15.50	1.096	-0.03	0.880	0.965
	LTE Band 2	20M	QPSK	50	0	Front	5	P-Sensor On	18900	1880	14.96	15.50	1.132	0.04	0.776	0.879
	LTE Band 2	20M	QPSK	50	0	Front	5	P-Sensor On	18700	1860	14.94	15.50	1.138	-0.13	0.743	0.845
	LTE Band 2	20M	QPSK	50	0	Front	5	P-Sensor On	19100	1900	14.95	15.50	1.135	0.05	0.772	0.876
	LTE Band 2	20M	QPSK	100	0	Front	5	P-Sensor On	18900	1880	14.96	15.50	1.132	0.02	0.784	0.888
	LTE Band 2	20M	QPSK	1	99	Back	5	P-Sensor On	18900	1880	15.23	15.50	1.064	0.11	0.591	0.629
	LTE Band 2	20M	QPSK	50	0	Back	5	P-Sensor On	18900	1880	14.96	15.50	1.132	0.05	0.547	0.619

<WLAN 2.4GHz SAR>

Plot No.	Band	Mode	Test Position	Gap (mm)	Power Mode	Ch.	Freq. (MHz)	Average Power (dBm)	Tune-Up Limit (dBm)	Tune-up Scaling Factor	Duty Cycle %	Duty Cycle Scaling Factor	Power Drift (dB)	Max Area Scan SAR	Measured 1g SAR (W/kg)	Reported 1g SAR (W/kg)
	WLAN2.4GHz	802.11b 1Mbps	Front	5	Full	6	2437	19.17	19.5	1.078	97.84	1.022	0.07	0.769	0.489	0.539
48	WLAN2.4GHz	802.11b 1Mbps	Back	5	Full	6	2437	19.17	19.5	1.078	97.84	1.022	0.01	0.981	0.569	0.627

<WLAN 5GHz SAR>

Plot No.	Band	Mode	Test Position	Gap (mm)	Power Mode	Ch.	Freq. (MHz)	Average Power (dBm)	Tune-Up Limit (dBm)	Tune-up Scaling Factor	Duty Cycle %	Duty Cycle Scaling Factor	Power Drift (dB)	Measured 1g SAR (W/kg)	Reported 1g SAR (W/kg)
	WLAN5.3GHz	802.11a 6Mbps	Front	5	Full	64	5320	18.20	18.50	1.072	87.5	1.143	0.02	0.339	0.415
49	WLAN5.3GHz	802.11a 6Mbps	Back	5	Full	64	5320	18.20	18.50	1.072	87.5	1.143	0.04	0.954	1.168
	WLAN5.3GHz	802.11a 6Mbps	Back	5	Full	60	5300	18.13	18.50	1.089	87.5	1.143	-0.15	0.841	1.047
	WLAN5.5GHz	802.11a 6Mbps	Front	5	P-Sensor On	100	5500	15.21	15.50	1.069	87.5	1.143	0.06	0.094	0.115
	WLAN5.5GHz	802.11a 6Mbps	Back	5	P-Sensor On	100	5500	15.21	15.50	1.069	87.5	1.143	0.06	0.709	0.866
50	WLAN5.5GHz	802.11a 6Mbps	Back	5	P-Sensor On	116	5580	15.05	15.50	1.109	87.5	1.143	0.09	0.695	0.881
	WLAN 5.8GHz	802.11a 6Mbps	Front	5	P-Sensor On	149	5745	14.97	15.50	1.130	87.5	1.143	0.09	0.012	0.016
	WLAN 5.8GHz	802.11a 6Mbps	Back	5	P-Sensor On	149	5745	14.97	15.50	1.130	87.5	1.143	0.02	0.785	1.014
51	WLAN 5.8GHz	802.11a 6Mbps	Back	5	P-Sensor On	157	5785	14.94	15.50	1.138	87.5	1.143	0.04	0.804	1.045

<Bluetooth SAR>

Plot No.	Band	Mode	Test Position	Gap (mm)	Ch.	Freq. (MHz)	Average Power (dBm)	Tune-Up Limit (dBm)	Tune-up Scaling Factor	Duty Cycle %	Duty Cycle Scaling Factor	Power Drift (dB)	Measured 1g SAR (W/kg)	Reported 1g SAR (W/kg)
	Bluetooth	1Mbps	Front	5	39	2441	10.85	11.50	1.161	76.74	1.085	0.06	0.058	0.073
52	Bluetooth	1Mbps	Back	5	39	2441	10.85	11.50	1.161	76.74	1.085	-0.05	0.075	0.095



15.4 Product specific 10g SAR

<GSM SAR>

Plot No.	Band	Mode	Test Position	Gap (mm)	Power Mode	Ch.	Freq. (MHz)	Average Power (dBm)	Tune-Up Limit (dBm)	Tune-up Scaling Factor	Power Drift (dB)	Measured 10g SAR (W/kg)	Reported 10g SAR (W/kg)
	GSM1900	GPRS 4 Tx slots	Front	0	Full	661	1880	23.86	24.50	1.159	0.06	2.400	2.781
	GSM1900	GPRS 4 Tx slots	Front	0	Full	512	1850.2	23.85	24.50	1.161	0.01	2.150	2.497
53	GSM1900	GPRS 4 Tx slots	Front	0	Full	810	1909.8	23.82	24.50	1.169	0.19	2.380	2.783
	GSM1900	GPRS 4 Tx slots	Back	0	Full	661	1880	23.86	24.50	1.159	0.03	1.720	1.993
	GSM1900	GPRS 4 Tx slots	Bottom Side	0	Full	661	1880	23.86	24.50	1.159	-0.04	2.210	2.561
	GSM1900	GPRS 4 Tx slots	Bottom Side	0	Full	512	1850.2	23.85	24.50	1.161	0.08	2.000	2.323
	GSM1900	GPRS 4 Tx slots	Bottom Side	0	Full	810	1909.8	23.82	24.50	1.169	0.18	2.160	2.526

<WCDMA SAR>

Plot No.	Band	Mode	Test Position	Gap (mm)	Power Mode	Ch.	Freq. (MHz)	Average Power (dBm)	Tune-Up Limit (dBm)	Tune-up Scaling Factor	Power Drift (dB)	Measured 10g SAR (W/kg)	Reported 10g SAR (W/kg)
	WCDMA Band IV	RMC 12.2Kbps	Front	0	Handheld On	1312	1712.4	19.75	20.00	1.059	0.13	2.130	2.256
	WCDMA Band IV	RMC 12.2Kbps	Front	0	Handheld On	1413	1732.6	19.74	20.00	1.062	0.01	2.130	2.261
	WCDMA Band IV	RMC 12.2Kbps	Front	0	Handheld On	1513	1752.6	19.69	20.00	1.074	0.06	2.250	2.416
	WCDMA Band IV	RMC 12.2Kbps	Back	0	Handheld On	1312	1712.4	19.75	20.00	1.059	0.07	1.300	1.377
	WCDMA Band IV	RMC 12.2Kbps	Bottom Side	0	Handheld On	1312	1712.4	19.75	20.00	1.059	0.02	2.300	2.436
	WCDMA Band IV	RMC 12.2Kbps	Bottom Side	0	Handheld On	1413	1732.6	19.74	20.00	1.062	0.08	2.320	2.463
54	WCDMA Band IV	RMC 12.2Kbps	Bottom Side	0	Handheld On	1513	1752.6	19.69	20.00	1.074	0.03	2.410	2.588
	WCDMA Band II	RMC 12.2Kbps	Front	0	Handheld On	9400	1880	19.49	20.00	1.125	0.01	2.430	2.733
	WCDMA Band II	RMC 12.2Kbps	Front	0	Handheld On	9262	1852.4	19.46	20.00	1.132	-0.05	2.310	2.616
55	WCDMA Band II	RMC 12.2Kbps	Front	0	Handheld On	9538	1907.6	19.35	20.00	1.161	0.07	2.460	2.857
	WCDMA Band II	RMC 12.2Kbps	Back	0	Handheld On	9400	1880	19.49	20.00	1.125	0.06	1.770	1.991
	WCDMA Band II	RMC 12.2Kbps	Bottom Side	0	Handheld On	9400	1880	19.49	20.00	1.125	-0.06	2.260	2.542
	WCDMA Band II	RMC 12.2Kbps	Bottom Side	0	Handheld On	9262	1852.4	19.46	20.00	1.132	0.07	2.160	2.446
	WCDMA Band II	RMC 12.2Kbps	Bottom Side	0	Handheld On	9538	1907.6	19.35	20.00	1.161	0.01	2.220	2.578

<CDMA2000 SAR>

Plot No.	Band	Mode	Test Position	Gap (mm)	Power Mode	Ch.	Freq. (MHz)	Average Power (dBm)	Tune-Up Limit (dBm)	Tune-up Scaling Factor	Power Drift (dB)	Measured 10g SAR (W/kg)	Reported 10g SAR (W/kg)
56	CDMA2000 BC1	RTAP 153.6Kbps	Front	0	Handheld On	600	1880	20.29	21.00	1.178	0.09	2.550	3.003
	CDMA2000 BC1	RTAP 153.6Kbps	Front	0	Handheld On	25	1851.25	20.24	21.00	1.191	0.09	2.300	2.740
	CDMA2000 BC1	RTAP 153.6Kbps	Front	0	Handheld On	1175	1908.75	20.28	21.00	1.180	0.01	2.540	2.998
	CDMA2000 BC1	RTAP 153.6Kbps	Back	0	Handheld On	600	1880	20.29	21.00	1.178	-0.01	1.900	2.237
	CDMA2000 BC1	RTAP 153.6Kbps	Back	0	Handheld On	25	1851.25	20.24	21.00	1.191	0.1	1.720	2.049
	CDMA2000 BC1	RTAP 153.6Kbps	Back	0	Handheld On	1175	1908.75	20.28	21.00	1.180	-0.08	1.950	2.302
	CDMA2000 BC1	RTAP 153.6Kbps	Bottom Side	0	Handheld On	600	1880	20.29	21.00	1.178	0.04	2.330	2.744
	CDMA2000 BC1	RTAP 153.6Kbps	Bottom Side	0	Handheld On	25	1851.25	20.24	21.00	1.191	0.04	2.160	2.573
	CDMA2000 BC1	RTAP 153.6Kbps	Bottom Side	0	Handheld On	1175	1908.75	20.28	21.00	1.180	0.01	2.240	2.644



<LTE SAR>

Plot No.	Band	BW (MHz)	Modulation	RB Size	RB Offset	Test Position	Gap (mm)	Power Mode	Ch.	Freq. (MHz)	Average Power (dBm)	Tune-Up Limit (dBm)	Tune-up Scaling Factor	Power Drift (dB)	Measured 10g SAR (W/kg)	Reported 10g SAR (W/kg)
	LTE Band 66	20M	QPSK	1	99	Front	0	Handheld On	132322	1745	20.95	21.00	1.012	0.1	2.550	2.580
	LTE Band 66	20M	QPSK	1	99	Front	0	Handheld On	132072	1720	20.88	21.00	1.028	0.03	2.470	2.539
57	LTE Band 66	20M	QPSK	1	99	Front	0	Handheld On	132572	1770	20.62	21.00	1.091	0.08	2.810	3.067
	LTE Band 66	20M	QPSK	50	0	Front	0	Handheld On	132322	1745	20.66	21.00	1.081	0.04	2.300	2.487
	LTE Band 66	20M	QPSK	50	0	Front	0	Handheld On	132072	1720	20.56	21.00	1.107	0.05	2.200	2.435
	LTE Band 66	20M	QPSK	50	0	Front	0	Handheld On	132572	1770	20.39	21.00	1.151	-0.01	2.490	2.865
	LTE Band 66	20M	QPSK	100	0	Front	0	Handheld On	132322	1745	20.59	21.00	1.099	0.04	2.350	2.583
	LTE Band 66	20M	QPSK	1	99	Back	0	Handheld On	132322	1745	20.95	21.00	1.012	-0.06	1.590	1.608
	LTE Band 66	20M	QPSK	50	0	Back	0	Handheld On	132322	1745	20.66	21.00	1.081	-0.11	1.420	1.536
	LTE Band 66	20M	QPSK	1	99	Bottom Side	0	Handheld On	132322	1745	20.95	21.00	1.012	0.08	2.550	2.580
	LTE Band 66	20M	QPSK	1	99	Bottom Side	0	Handheld On	132072	1720	20.88	21.00	1.028	0.05	2.520	2.591
	LTE Band 66	20M	QPSK	1	99	Bottom Side	0	Handheld On	132572	1770	20.62	21.00	1.091	0.14	2.670	2.914
	LTE Band 66	20M	QPSK	50	0	Bottom Side	0	Handheld On	132322	1745	20.66	21.00	1.081	0.01	2.310	2.498
	LTE Band 66	20M	QPSK	50	0	Bottom Side	0	Handheld On	132072	1720	20.56	21.00	1.107	0.12	2.330	2.578
	LTE Band 66	20M	QPSK	50	0	Bottom Side	0	Handheld On	132572	1770	20.39	21.00	1.151	0.03	2.400	2.762
	LTE Band 66	20M	QPSK	100	0	Bottom Side	0	Handheld On	132322	1745	20.59	21.00	1.099	0.01	2.360	2.594
	LTE Band 2	20M	QPSK	1	99	Front	0	Handheld On	18900	1880	18.86	19.00	1.033	-0.05	2.080	2.148
	LTE Band 2	20M	QPSK	1	99	Front	0	Handheld On	18700	1860	18.85	19.00	1.035	0.01	2.010	2.081
	LTE Band 2	20M	QPSK	1	99	Front	0	Handheld On	19100	1900	18.72	19.00	1.067	0.05	2.150	2.293
	LTE Band 2	20M	QPSK	50	0	Front	0	Handheld On	18900	1880	18.50	19.00	1.122	0.06	2.030	2.278
	LTE Band 2	20M	QPSK	50	0	Front	0	Handheld On	18700	1860	18.48	19.00	1.127	0.04	1.970	2.221
58	LTE Band 2	20M	QPSK	50	0	Front	0	Handheld On	19100	1900	18.32	19.00	1.169	0.03	2.110	2.468
	LTE Band 2	20M	QPSK	100	0	Front	0	Handheld On	18900	1880	18.50	19.00	1.122	0.05	2.080	2.334
	LTE Band 2	20M	QPSK	1	99	Back	0	Handheld On	18900	1880	18.86	19.00	1.033	0.02	1.430	1.477
	LTE Band 2	20M	QPSK	50	0	Back	0	Handheld On	18900	1880	18.50	19.00	1.122	0.04	1.350	1.515
	LTE Band 2	20M	QPSK	1	99	Bottom Side	0	Handheld On	18900	1880	18.86	19.00	1.033	0.03	1.870	1.931
	LTE Band 2	20M	QPSK	50	0	Bottom side	0	Handheld On	18900	1880	18.50	19.00	1.122	0.12	1.920	2.154
	LTE Band 2	20M	QPSK	50	0	Bottom side	0	Handheld On	18700	1860	18.48	19.00	1.127	0.03	1.780	2.006
	LTE Band 2	20M	QPSK	50	0	Bottom side	0	Handheld On	19100	1900	18.32	19.00	1.169	0.01	1.940	2.269
	LTE Band 2	20M	QPSK	100	0	Bottom side	0	Handheld On	18900	1880	18.50	19.00	1.122	0.06	1.930	2.165

<WLAN 5GHz SAR>

Plot No.	Band	Mode	Test Position	Gap (mm)	Power Mode	Ch.	Freq. (MHz)	Average Power (dBm)	Tune-Up Limit (dBm)	Tune-up Scaling Factor	Duty Cycle %	Duty Cycle Scaling Factor	Power Drift (dB)	Measured 10g SAR (W/kg)	Reported 10g SAR (W/kg)
	WLAN5.3GHz	802.11a 6Mbps	Front	0	Full	64	5320	18.20	18.50	1.072	87.5	1.143	0.14	0.442	0.541
59	WLAN5.3GHz	802.11a 6Mbps	Back	0	Full	64	5320	18.20	18.50	1.072	87.5	1.143	0.04	0.997	1.221
	WLAN5.3GHz	802.11a 6Mbps	Right Side	0	Full	64	5320	18.20	18.50	1.072	87.5	1.143	-0.07	0.087	0.107
	WLAN5.3GHz	802.11a 6Mbps	Top Side	0	Full	64	5320	18.20	18.50	1.072	87.5	1.143	-0.04	0.480	0.588
	WLAN 5.5GHz	802.11a 6Mbps	Front	0	Full	132	5660	17.95	18.50	1.135	87.5	1.143	0.13	0.142	0.184
60	WLAN 5.5GHz	802.11a 6Mbps	Back	0	Full	132	5660	17.95	18.50	1.135	87.5	1.143	0.09	1.240	1.609
	WLAN 5.5GHz	802.11a 6Mbps	Right Side	0	Full	132	5660	17.95	18.50	1.135	87.5	1.143	-0.08	0.030	0.038
	WLAN 5.5GHz	802.11a 6Mbps	Top Side	0	Full	132	5660	17.95	18.50	1.135	87.5	1.143	0.07	0.634	0.822
	WLAN 5.8GHz	802.11a 6Mbps	Back	0	Full	149	5745	17.60	18.00	1.097	87.50	1.143	0.03	1.300	1.629
61	WLAN 5.8GHz	802.11a 6Mbps	Back	0	Full	157	5785	17.03	18.00	1.250	87.50	1.143	0.04	1.180	1.686



15.5 Repeated SAR Measurement

<1g SAR>

No.	Band	Mode	BW (MHz)	Modulation	RB Size	RB Offset	Test Position	Gap (mm)	Power Mode	Ch.	Freq. (MHz)	Average Power (dBm)	Tune-Up Limit (dBm)	Tune-up Scaling Factor	Duty Cycle %	Duty Cycle Scaling Factor	Power Drift (dB)	Measured 1g SAR (W/kg)	Ratio	Reported 1g SAR (W/kg)
1st	GSM850	GPRS 4 Tx slots	-	-	-	-	Front	5	Full	251	848.8	27.02	27.50	1.117	-	-	-0.08	0.904	1	1.010
2nd	GSM850	GPRS 4 Tx slots	-	-	-	-	Front	5	Full	251	848.8	27.02	27.50	1.117	-	-	0.02	0.900	1.004	1.005
1st	LTE Band 66	-	20M	QPSK	1	99	Bottom Side	5	Hotspot On	132572	1770	17.18	17.50	1.076	-	-	0.02	1.070	1	1.152
2nd	LTE Band 66	-	20M	QPSK	1	99	Bottom Side	5	Hotspot On	132572	1770	17.18	17.50	1.076	-	-	-0.02	1.030	1.039	1.109
1st	LTE Band 2	-	20M	QPSK	1	99	Bottom Side	5	Hotspot On	19100	1900	15.10	15.50	1.096	-	-	-0.08	1.060	1	1.162
2nd	LTE Band 2	-	20M	QPSK	1	99	Bottom Side	5	Hotspot On	19100	1900	15.10	15.50	1.096	-	-	-0.04	0.962	1.102	1.055
1st	WLAN5.2GHz	802.11a 6Mbps	-	-	-	-	Back	5	Full	48	5240	18.08	18.50	1.102	87.5	1.143	0.01	0.806	1	1.015
2nd	WLAN5.2GHz	802.11a 6Mbps	-	-	-	-	Back	5	Full	48	5240	18.08	18.50	1.102	87.5	1.143	0.05	0.791	1.019	0.996
1st	WLAN5.3GHz	802.11a 6Mbps	-	-	-	-	Back	5	Full	64	5320	18.20	18.50	1.072	87.5	1.143	0.04	0.954	1	1.168
2nd	WLAN5.3GHz	802.11a 6Mbps	-	-	-	-	Back	5	Full	64	5320	18.20	18.50	1.072	87.5	1.143	0.17	0.935	1.020	1.145
1st	WLAN5.8GHz	802.11a 6Mbps	-	-	-	-	Back	5	Hotspot On	157	5785	14.94	15.50	1.138	87.5	1.143	0.04	0.804	1	1.045
2nd	WLAN5.8GHz	802.11a 6Mbps	-	-	-	-	Back	5	Hotspot On	157	5785	14.94	15.50	1.138	87.5	1.143	0.02	0.798	1.008	1.038

<10g SAR>

No.	Band	Mode	BW (MHz)	Modulation	RB Size	RB Offset	Test Position	Gap (mm)	Power Mode	Ch.	Freq. (MHz)	Average Power (dBm)	Tune-Up Limit (dBm)	Tune-up Scaling Factor	Power Drift (dB)	Measured 10g SAR (W/kg)	Ratio	Reported 10g SAR (W/kg)
1st	CDMA2000 BC1	RTAP 153.6Kbps	-	-	-	-	Front	0	Handheld On	600	1880	20.29	21.00	1.178	0.09	2.550	1	3.003
2nd	CDMA2000 BC1	RTAP 153.6Kbps	-	-	-	-	Front	0	Handheld On	600	1880	20.29	21.00	1.178	0.01	2.510	1.016	2.956
1st	LTE Band 66	-	20M	QPSK	1	99	Bottom Side	0	Handheld On	132572	1770	20.62	21.00	1.091	0.08	2.810	1	3.067
2nd	LTE Band 66	-	20M	QPSK	1	99	Bottom Side	0	Handheld On	132572	1770	20.62	21.00	1.091	0.05	2.770	1.014	3.023

General Note:

1. Per KDB 865664 D01v01r04, for each frequency band, repeated SAR measurement is required only when the measured SAR is $\geq 0.8W/kg$.
2. Per KDB 865664 D01v01r04, if the ratio among the repeated measurement is ≤ 1.2 and the measured SAR $< 1.45W/kg$, only one repeated measurement is required.
3. Per KDB 865664 D01v01r04, if the extremity repeated SAR is necessary, the same procedures should be adapted for measurements according to extremity and occupational exposure limits by applying a factor of 2.5 for extremity exposure and a factor of 5 for occupational exposure to the corresponding SAR thresholds.
4. The ratio is the difference in percentage between original and repeated *measured SAR*.
5. All measurement SAR result is scaled-up to account for tune-up tolerance and is compliant.

16. Simultaneous Transmission Analysis

No.	Simultaneous Transmission Configurations	Portable Handset				Note
		Head	Body-worn	Hotspot	Product specific 10g SAR	
1.	GSM Voice + WLAN2.4GHz	Yes	Yes			
2.	GPRS/EDGE + WLAN2.4GHz	Yes	Yes	Yes	Yes	WLAN Hotspot
3.	WCDMA + WLAN2.4GHz	Yes	Yes	Yes	Yes	WLAN Hotspot
4.	CDMA + WLAN2.4GHz	Yes	Yes	Yes	Yes	WLAN Hotspot
5.	LTE + WLAN2.4GHz	Yes	Yes	Yes	Yes	WLAN Hotspot
6.	GSM Voice + WLAN5.3/5.5GHz	Yes	Yes			
7.	GPRS/EDGE + WLAN5.3/5.5GHz	Yes	Yes		Yes	WLAN Direct (GC only)
8.	WCDMA + WLAN5.3/5.5GHz	Yes	Yes		Yes	WLAN Direct (GC only)
9.	CDMA + WLAN5.3/5.5GHz	Yes	Yes		Yes	WLAN Direct (GC only)
10.	LTE + WLAN5.3/5.5GHz	Yes	Yes		Yes	WLAN Direct (GC only)
11.	GSM Voice + WLAN5.2/5.8GHz	Yes	Yes			
12.	GPRS/EDGE + WLAN5.2/5.8GHz	Yes	Yes	Yes	Yes	WLAN Hotspot/Direct(GC/GO)
13.	WCDMA + WLAN5.2/5.8GHz	Yes	Yes	Yes	Yes	WLAN Hotspot/Direct(GC/GO)
14.	CDMA + WLAN5.2/5.8GHz	Yes	Yes	Yes	Yes	WLAN Hotspot/Direct(GC/GO)
15.	LTE + WLAN5.2/5.8GHz	Yes	Yes	Yes	Yes	WLAN Hotspot/Direct(GC/GO)
16.	GSM Voice + Bluetooth		Yes			
17.	GPRS/EDGE + Bluetooth		Yes	Yes	Yes	BT Tethering
18.	WCDMA + Bluetooth		Yes	Yes	Yes	BT Tethering
19.	CDMA + Bluetooth		Yes	Yes	Yes	BT Tethering
20.	LTE + Bluetooth		Yes	Yes	Yes	BT Tethering

General Note:

1. This device supports VoIP in GPRS, EGPRS, CDMA, WCDMA and LTE (e.g. for 3rd-party VoIP), LTE supports VoLTE operation.
2. EUT will choose each GSM, WCDMA, CDMA and LTE according to the network signal condition; therefore, they will not operate simultaneously at any moment.
3. All licensed modes share the same antenna part and cannot transmit simultaneously.
4. This device 2.4GHz WLAN support hotspot operation and Bluetooth support tethering applications.
5. This device 2.4GHz WLAN/ 5.2GHz WLAN/5.8GHz WLAN support hotspot operation, and 5.2GHz WLAN/5.8GHz WLAN supports WLAN Direct (GC/GO), and 5.3GHz / 5.5GHz supports WLAN Direct (GC only).
6. EUT will choose either WLAN 2.4GHz or WLAN 5GHz according to the network signal condition; therefore, 2.4GHz WLAN and 5GHz WLAN will not operate simultaneously at any moment though they have independent antenna.
7. WLAN 2.4GHz and Bluetooth share the same antenna so can't transmit simultaneously.
8. According to the EUT character, WLAN 5GHz and Bluetooth can't transmit simultaneously.
9. The worst case 5 GHz WLAN SAR for each configuration was used for SAR summation.
10. Chose the worst zoom scan SAR of WLAN correspondingly for co-located with WWAN analysis.
11. The reported SAR summation is calculated based on the same configuration and test position.
12. Per KDB 447498 D01v06, simultaneous transmission SAR is compliant if,
 - i) 1g Scalar SAR summation < 1.6W/kg and 10g Scalar SAR summation < 4.0W/kg.
 - ii) $SPLSR = (SAR1 + SAR2)^{1.5} / (\text{min. separation distance, mm})$, and the peak separation distance is determined from the square root of $[(x1-x2)^2 + (y1-y2)^2 + (z1-z2)^2]$, where (x1, y1, z1) and (x2, y2, z2) are the coordinates of the extrapolated peak SAR locations in the zoom scan.
 - iii) If $SPLSR \leq 0.04$ for 1g SAR, $SPLSR \leq 0.10$ for 10g SAR simultaneously transmission SAR measurement is not necessary.
 - iv) Simultaneously transmission SAR measurement, and the reported multi-band 1g SAR < 1.6W/kg and 10g SAR < 4.0W/kg.
 - v) The SPLSR calculated results please refer to section 16.5.



16.1 Head Exposure Conditions

WWAN Band		Exposure Position	1	2	3	1+2		1+3			
			WWAN 1g SAR (W/kg)	2.4GHz WLAN 1g SAR (W/kg)	5GHz WLAN 1g SAR (W/kg)	Summed 1g SAR (W/kg)	SPLSR	Case No	Summed 1g SAR (W/kg)	SPLSR	Case No
GSM	GSM850	Right Cheek	0.260	0.751	0.410	1.01			0.67		
		Right Tilted	0.167	0.751	0.839	0.92			1.01		
		Left Cheek	0.228	0.751	0.839	0.98			1.07		
		Left Tilted	0.156	0.573	0.781	0.73			0.94		
	GSM1900	Right Cheek	0.108	0.751	0.410	0.86			0.52		
		Right Tilted	0.036	0.751	0.839	0.79			0.88		
		Left Cheek	0.099	0.751	0.839	0.85			0.94		
		Left Tilted	0.056	0.573	0.781	0.63			0.84		
WCDMA	Band V	Right Cheek	0.410	0.751	0.410	1.16			0.82		
		Right Tilted	0.213	0.751	0.839	0.96			1.05		
		Left Cheek	0.319	0.751	0.839	1.07			1.16		
		Left Tilted	0.214	0.573	0.781	0.79			1.00		
	Band IV	Right Cheek	0.195	0.751	0.410	0.95			0.61		
		Right Tilted	0.085	0.751	0.839	0.84			0.92		
		Left Cheek	0.147	0.751	0.839	0.90			0.99		
		Left Tilted	0.074	0.573	0.781	0.65			0.86		
	Band II	Right Cheek	0.222	0.751	0.410	0.97			0.63		
		Right Tilted	0.076	0.751	0.839	0.83			0.92		
		Left Cheek	0.202	0.751	0.839	0.95			1.04		
		Left Tilted	0.109	0.573	0.781	0.68			0.89		
CDMA2000	BC0	Right Cheek	0.476	0.751	0.410	1.23			0.89		
		Right Tilted	0.243	0.751	0.839	0.99			1.08		
		Left Cheek	0.358	0.751	0.839	1.11			1.20		
		Left Tilted	0.235	0.573	0.781	0.81			1.02		
	BC1	Right Cheek	0.253	0.751	0.410	1.00			0.66		
		Right Tilted	0.079	0.751	0.839	0.83			0.92		
		Left Cheek	0.190	0.751	0.839	0.94			1.03		
		Left Tilted	0.131	0.573	0.781	0.70			0.91		



WWAN Band	Exposure Position	1	2	3	1+2		1+3			
		WWAN	2.4GHz WLAN	5GHz WLAN	Summed 1g SAR (W/kg)	SPLSR	Case No	Summed 1g SAR (W/kg)	SPLSR	Case No
		1g SAR (W/kg)	1g SAR (W/kg)	1g SAR (W/kg)						
LTE	Band 71	Right Cheek	0.235	0.751	0.410	0.99		0.65		
		Right Tilted	0.107	0.751	0.839	0.86		0.95		
		Left Cheek	0.244	0.751	0.839	1.00		1.08		
		Left Tilted	0.102	0.573	0.781	0.68		0.88		
	Band 5	Right Cheek	0.383	0.751	0.410	1.13		0.79		
		Right Tilted	0.194	0.751	0.839	0.95		1.03		
		Left Cheek	0.295	0.751	0.839	1.05		1.13		
		Left Tilted	0.202	0.573	0.781	0.78		0.98		
	Band 12	Right Cheek	0.262	0.751	0.410	1.01		0.67		
		Right Tilted	0.100	0.751	0.839	0.85		0.94		
		Left Cheek	0.245	0.751	0.839	1.00		1.08		
		Left Tilted	0.116	0.573	0.781	0.69		0.90		
	Band 13	Right Cheek	0.364	0.751	0.410	1.12		0.77		
		Right Tilted	0.220	0.751	0.839	0.97		1.06		
		Left Cheek	0.288	0.751	0.839	1.04		1.13		
		Left Tilted	0.201	0.573	0.781	0.77		0.98		
	Band 66	Right Cheek	0.162	0.751	0.410	0.91		0.57		
		Right Tilted	0.053	0.751	0.839	0.80		0.89		
		Left Cheek	0.138	0.751	0.839	0.89		0.98		
		Left Tilted	0.067	0.573	0.781	0.64		0.85		
	Band 2	Right Cheek	0.195	0.751	0.410	0.95		0.61		
		Right Tilted	0.074	0.751	0.839	0.83		0.91		
		Left Cheek	0.159	0.751	0.839	0.91		1.00		
		Left Tilted	0.089	0.573	0.781	0.66		0.87		



16.2 Hotspot Exposure Conditions

WWAN Band	Exposure Position	1	2	3	4	1+2			1+3			1+4			
		WWAN	2.4GHz WLAN	5GHz WLAN	Bluetooth	Summed 1g SAR (W/kg)	SPLSR	Case No	Summed 1g SAR (W/kg)	SPLSR	Case No	Summed 1g SAR (W/kg)	SPLSR	Case No	
		1g SAR (W/kg)	1g SAR (W/kg)	1g SAR (W/kg)	1g SAR (W/kg)										
GSM	GSM850	Front	1.010	0.539	0.381	0.073	1.55			1.39			1.08		
		Back	0.657	0.627	1.045	0.095	1.28			1.70	0.02	#1	0.75		
		Left Side	0.240				0.24			0.24			0.24		
		Right Side	0.561	0.455	0.147	0.066	1.02			0.71			0.63		
		Top Side		0.376	0.573	0.066	0.38			0.57			0.07		
	Bottom Side	0.608				0.61			0.61			0.61			
	GSM1900	Front	0.748	0.539	0.381	0.073	1.29			1.13			0.82		
		Back	0.465	0.627	1.045	0.095	1.09			1.51			0.56		
		Left Side	0.022				0.02			0.02			0.02		
		Right Side	0.069	0.455	0.147	0.066	0.52			0.22			0.14		
Top Side			0.376	0.573	0.066	0.38			0.57			0.07			
Bottom Side	0.976				0.98			0.98			0.98				
WCDMA	Band V	Front	0.948	0.539	0.381	0.073	1.49			1.33			1.02		
		Back	0.592	0.627	1.045	0.095	1.22			1.64	0.01	#2	0.69		
		Left Side	0.211				0.21			0.21			0.21		
		Right Side	0.436	0.455	0.147	0.066	0.89			0.58			0.50		
		Top Side		0.376	0.573	0.066	0.38			0.57			0.07		
	Bottom Side	0.653				0.65			0.65			0.65			
	Band IV	Front	0.769	0.539	0.381	0.073	1.31			1.15			0.84		
		Back	0.487	0.627	1.045	0.095	1.11			1.53			0.58		
		Left Side	0.119				0.12			0.12			0.12		
		Right Side	0.325	0.455	0.147	0.066	0.78			0.47			0.39		
		Top Side		0.376	0.573	0.066	0.38			0.57			0.07		
	Bottom Side	0.970				0.97			0.97			0.97			
	Band II	Front	0.724	0.539	0.381	0.073	1.26			1.11			0.80		
		Back	0.477	0.627	1.045	0.095	1.10			1.52			0.57		
		Left Side	0.036				0.04			0.04			0.04		
		Right Side	0.068	0.455	0.147	0.066	0.52			0.22			0.13		
		Top Side		0.376	0.573	0.066	0.38			0.57			0.07		
	Bottom Side	1.160				1.16			1.16			1.16			
CDMA2000	BC0	Front	0.671	0.539	0.381	0.073	1.21			1.05			0.74		
		Back	0.503	0.627	1.045	0.095	1.13			1.55			0.60		
		Left Side	0.128				0.13			0.13			0.13		
		Right Side	0.370	0.455	0.147	0.066	0.83			0.52			0.44		
		Top Side		0.376	0.573	0.066	0.38			0.57			0.07		
	Bottom Side	0.469				0.47			0.47			0.47			
	BC1	Front	0.736	0.539	0.381	0.073	1.28			1.12			0.81		
		Back	0.474	0.627	1.045	0.095	1.10			1.52			0.57		
		Left Side	0.037				0.04			0.04			0.04		
		Right Side	0.071	0.455	0.147	0.066	0.53			0.22			0.14		
		Top Side		0.376	0.573	0.066	0.38			0.57			0.07		
	Bottom Side	1.107				1.11			1.11			1.11			



WWAN Band	Exposure Position	1	2	3	4	1+2			1+3			1+4			
		WWAN	2.4GHz WLAN	5GHz WLAN	Bluetooth	Summed 1g SAR (W/kg)	SPLSR	Case No	Summed 1g SAR (W/kg)	SPLSR	Case No	Summed 1g SAR (W/kg)	SPLSR	Case No	
		1g SAR (W/kg)	1g SAR (W/kg)	1g SAR (W/kg)	1g SAR (W/kg)										
LTE	Band 71	Front	0.837	0.539	0.381	0.073	1.38			1.22			0.91		
		Back	0.400	0.627	1.045	0.095	1.03			1.45			0.50		
		Left Side	0.197				0.20			0.20			0.20		
		Right Side	0.497	0.455	0.147	0.066	0.95			0.64			0.56		
		Top Side		0.376	0.573	0.066	0.38			0.57			0.07		
		Bottom Side	0.392				0.39			0.39			0.39		
	Band 5	Front	0.737	0.539	0.381	0.073	1.28			1.12			0.81		
		Back	0.468	0.627	1.045	0.095	1.10			1.51			0.56		
		Left Side	0.150				0.15			0.15			0.15		
		Right Side	0.368	0.455	0.147	0.066	0.82			0.52			0.43		
		Top Side		0.376	0.573	0.066	0.38			0.57			0.07		
		Bottom Side	0.508				0.51			0.51			0.51		
	Band 12	Front	0.696	0.539	0.381	0.073	1.24			1.08			0.77		
		Back	0.451	0.627	1.045	0.095	1.08			1.50			0.55		
		Left Side	0.303				0.30			0.30			0.30		
		Right Side	0.439	0.455	0.147	0.066	0.89			0.59			0.51		
		Top Side		0.376	0.573	0.066	0.38			0.57			0.07		
		Bottom Side	0.409				0.41			0.41			0.41		
	Band 13	Front	0.845	0.539	0.381	0.073	1.38			1.23			0.92		
		Back	0.555	0.627	1.045	0.095	1.18			1.60	0.01	#3	0.65		
		Left Side	0.354				0.35			0.35			0.35		
		Right Side	0.659	0.455	0.147	0.066	1.11			0.81			0.73		
		Top Side		0.376	0.573	0.066	0.38			0.57			0.07		
		Bottom Side	0.494				0.49			0.49			0.49		
	Band 66	Front	0.937	0.539	0.381	0.073	1.48			1.32			1.01		
		Back	0.532	0.627	1.045	0.095	1.16			1.58			0.63		
		Left Side	0.043				0.04			0.04			0.04		
		Right Side	0.099	0.455	0.147	0.066	0.55			0.25			0.17		
		Top Side		0.376	0.573	0.066	0.38			0.57			0.07		
		Bottom Side	1.152				1.15			1.15			1.15		
Band 2	Front	0.965	0.539	0.381	0.073	1.50			1.35			1.04			
	Back	0.629	0.627	1.045	0.095	1.26			1.67	0.01	#4	0.72			
	Left Side	0.043				0.04			0.04			0.04			
	Right Side	0.080	0.455	0.147	0.066	0.54			0.23			0.15			
	Top Side		0.376	0.573	0.066	0.38			0.57			0.07			
	Bottom Side	1.162				1.16			1.16			1.16			



16.3 Body-Worn Accessory Exposure Conditions

WWAN Band	Exposure Position	1	2	3	4	1+2			1+3			1+4			
		WWAN	2.4GHz WLAN	5GHz WLAN	Bluetooth	Summed 1g SAR (W/kg)	SPLSR	Case No	Summed 1g SAR (W/kg)	SPLSR	Case No	Summed 1g SAR (W/kg)	SPLSR	Case No	
		1g SAR (W/kg)	1g SAR (W/kg)	1g SAR (W/kg)	1g SAR (W/kg)										
GSM	GSM850	Front	1.010	0.539	0.415	0.073	1.55			1.43			1.08		
		Back	0.657	0.627	1.168	0.095	1.28			1.83	0.02	#5	0.75		
	GSM1900	Front	0.748	0.539	0.415	0.073	1.29			1.16			0.82		
		Back	0.465	0.627	1.168	0.095	1.09			1.63	0.02	#6	0.56		
WCDMA	Band V	Front	0.948	0.539	0.415	0.073	1.49			1.36			1.02		
		Back	0.592	0.627	1.168	0.095	1.22			1.76	0.02	#7	0.69		
	Band IV	Front	0.769	0.539	0.415	0.073	1.31			1.18			0.84		
		Back	0.487	0.627	1.168	0.095	1.11			1.66	0.02	#8	0.58		
	Band II	Front	0.724	0.539	0.415	0.073	1.26			1.14			0.80		
		Back	0.477	0.627	1.168	0.095	1.10			1.65	0.02	#9	0.57		
CDMA2000	BC0	Front	0.737	0.539	0.415	0.073	1.28			1.15			0.81		
		Back	0.482	0.627	1.168	0.095	1.11			1.65	0.02	#10	0.58		
	BC1	Front	0.729	0.539	0.415	0.073	1.27			1.14			0.80		
		Back	0.467	0.627	1.168	0.095	1.09			1.64	0.02	#11	0.56		
LTE	Band 71	Front	0.837	0.539	0.415	0.073	1.38			1.25			0.91		
		Back	0.400	0.627	1.168	0.095	1.03			1.57			0.50		
	Band 5	Front	0.737	0.539	0.415	0.073	1.28			1.15			0.81		
		Back	0.468	0.627	1.168	0.095	1.10			1.64	0.02	#12	0.56		
	Band 12	Front	0.696	0.539	0.415	0.073	1.24			1.11			0.77		
		Back	0.451	0.627	1.168	0.095	1.08			1.62	0.02	#13	0.55		
	Band 13	Front	0.845	0.539	0.415	0.073	1.38			1.26			0.92		
		Back	0.555	0.627	1.168	0.095	1.18			1.72	0.02	#14	0.65		
	Band 66	Front	0.937	0.539	0.415	0.073	1.48			1.35			1.01		
		Back	0.532	0.627	1.168	0.095	1.16			1.70	0.02	#15	0.63		
	Band 2	Front	0.965	0.539	0.415	0.073	1.50			1.38			1.04		
		Back	0.629	0.627	1.168	0.095	1.26			1.80	0.02	#16	0.72		

16.4 Product specific 10g SAR Exposure Conditions

WWAN Band		Exposure Position	1	2	1+2		
			WWAN	5GHz WLAN	Summed 10g SAR (W/kg)	SPLSR	Case No
			10g SAR (W/kg)	10g SAR (W/kg)			
GSM	GSM1900	Front	2.783	0.541	3.32		
		Back	1.993	1.686	3.68		
		Bottom side	2.561		2.56		
WCDMA	Band IV	Front	2.416	0.541	2.96		
		Back	1.377	1.686	3.06		
		Bottom side	2.588		2.59		
	Band II	Front	2.857	0.541	3.40		
		Back	1.991	1.686	3.68		
		Bottom side	2.578		2.58		
CDMA2000	BC1	Front	3.003	0.541	3.54		
		Back	2.302	1.686	3.99		
		Bottom side	2.744		2.74		
LTE	Band 66	Front	3.067	0.541	3.61		
		Back	1.608	1.686	3.29		
		Bottom side	2.914		2.91		
	Band 2	Front	2.468	0.541	3.01		
		Back	1.515	1.686	3.20		
		Bottom side	2.269		2.27		

Remark: For Bluetooth/WLAN 2.4GHz Product specific 10g stand-alone SAR is not required for a transmitter or antenna, due to 1g hotspot SAR is <1.2W/kg.

16.5 SPLSR Evaluation and Analysis

General Note:

- When standalone SAR is measured for both antennas in the pair, the peak location separation distance is computed by the square root of $[(x_1-x_2)^2 + (y_1-y_2)^2 + (z_1-z_2)^2]$, where (x_1, y_1, z_1) and (x_2, y_2, z_2) are the coordinates in the area scans or extrapolated peak SAR locations in the zoom scans, as appropriate.
- $SPLSR = (SAR_1 + SAR_2)^{1.5} / (\text{min. separation distance, mm})$. If $SPLSR \leq 0.04$ for 1g SAR and $SPLSR \leq 0.10$ for 10g SAR, simultaneously transmission SAR measurement is not necessary.

Case #1	Band	Position	1g SAR (W/kg)	Gap (mm)	SAR peak location (m)			3D distance (mm)	Summed 1g SAR (W/kg)	SPLSR Results	Simultaneous SAR
	GSM850				WLAN5GHz	X	Y				
	GSM850	Back	0.657	5	-0.011	-0.072	-0.205	141.3	1.70	0.02	Not required
	WLAN5GHz		1.045	5	-0.03	0.068	-0.205				

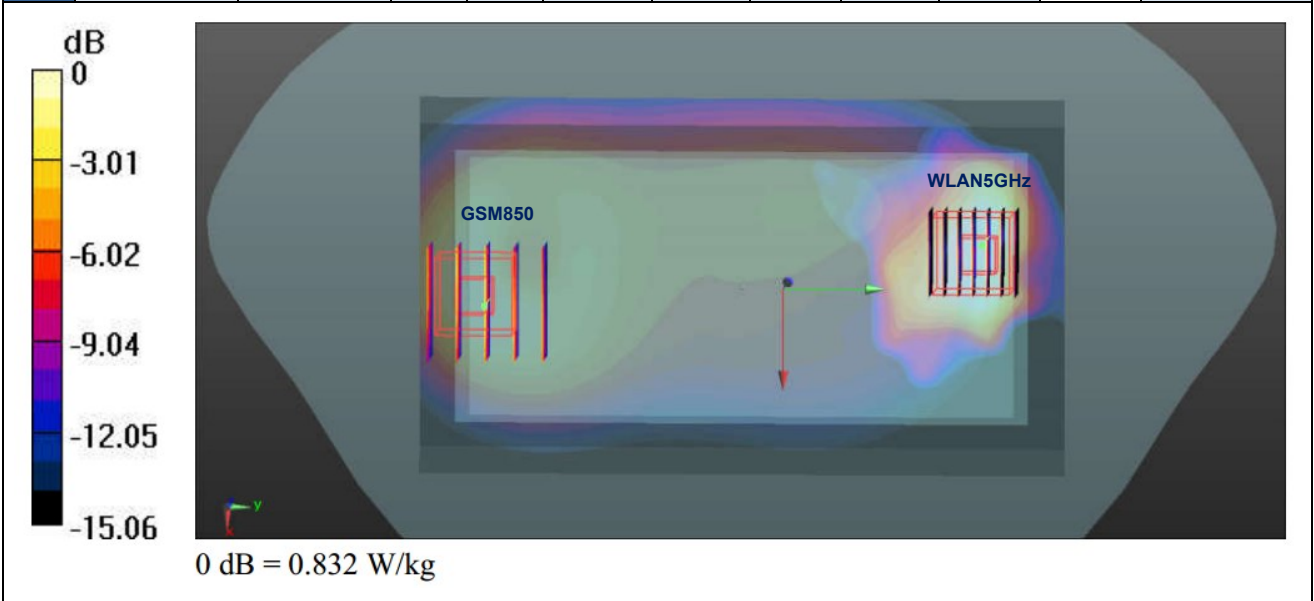

Case #2	Band	Position	1g SAR (W/kg)	Gap (mm)	SAR peak location (m)			3D distance (mm)	Summed 1g SAR (W/kg)	SPLSR Results	Simultaneous SAR
	WCDMA Band V				WLAN5GHz	X	Y				
	WCDMA Band V	Back	0.592	5	-0.003	-0.0735	-0.205	144.1	1.64	0.01	Not required
	WLAN5GHz		1.045	5	-0.03	0.068	-0.205				

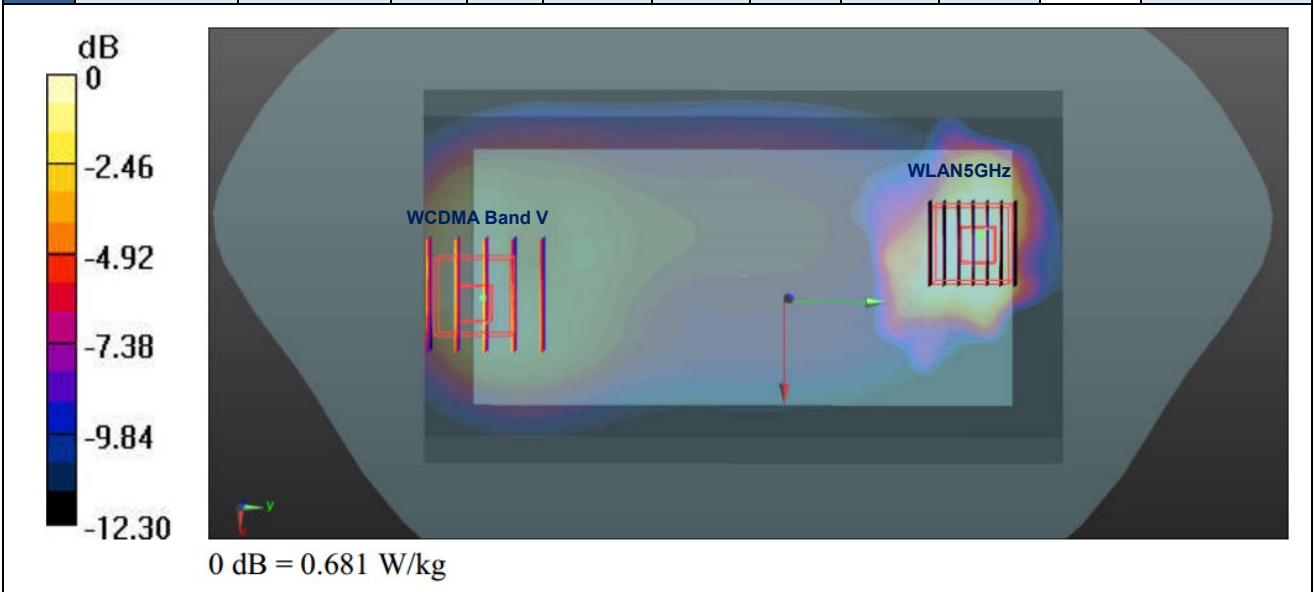

Case #3	Band	Position	1g SAR (W/kg)	Gap (mm)	SAR peak location (m)			3D distance (mm)	Summed 1g SAR (W/kg)	SPLSR Results	Simultaneous SAR
					X	Y	Z				
	LTE Band 13	Back	0.555	5	-0.007	-0.08	-0.205	149.8	1.60	0.01	Not required
	WLAN5GHz		1.045	5	-0.03	0.068	-0.205				

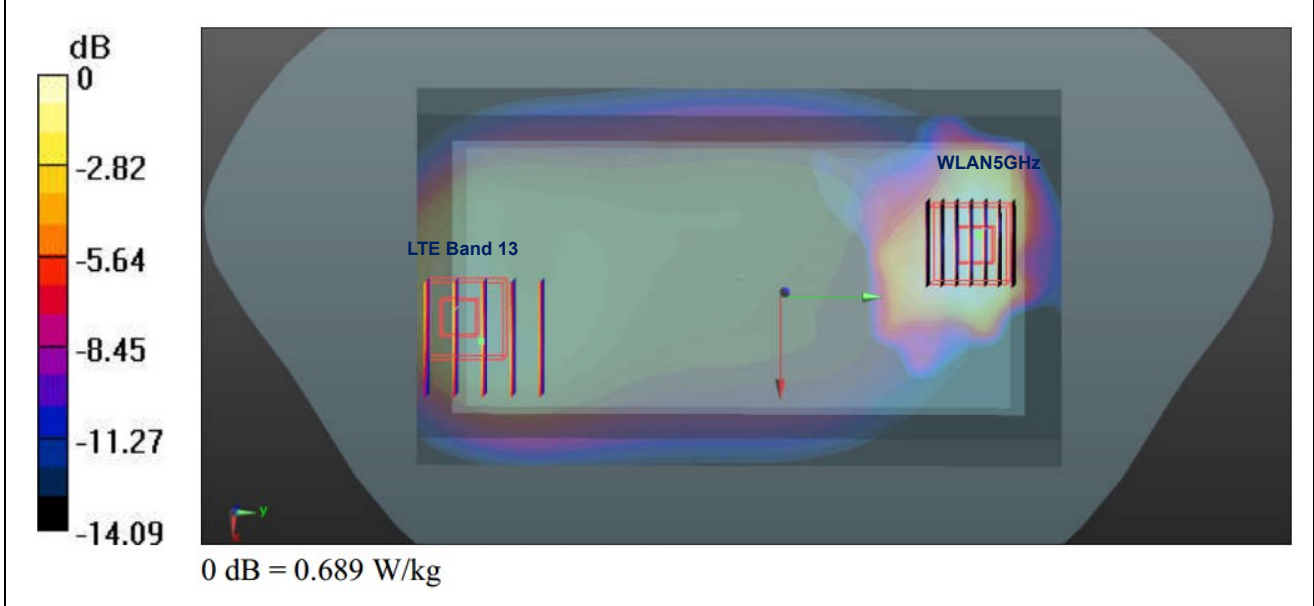

Case #4	Band	Position	1g SAR (W/kg)	Gap (mm)	SAR peak location (m)			3D distance (mm)	Summed 1g SAR (W/kg)	SPLSR Results	Simultaneous SAR
					X	Y	Z				
	LTE Band 2	Back	0.629	5	-0.023	-0.0795	-0.205	147.7	1.67	0.01	Not required
	WLAN5GHz		1.045	5	-0.03	0.068	-0.205				

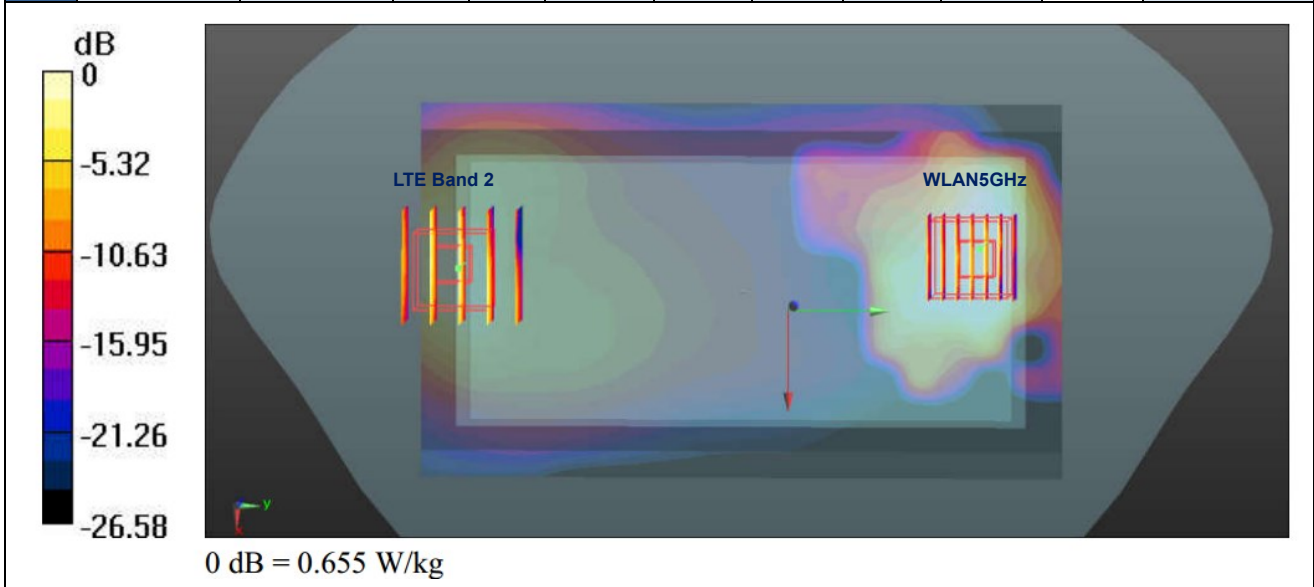

Case #5	Band	Position	1g SAR (W/kg)	Gap (mm)	SAR peak location (m)			3D distance (mm)	Summed 1g SAR (W/kg)	SPLSR Results	Simultaneous SAR
	GSM850				X	Y	Z				
	WLAN5GHz	Back	0.657	5	-0.011	-0.072	-0.205	128.4	1.83	0.02	Not required
	GSM850		1.168	5	-0.03	0.055	-0.205				

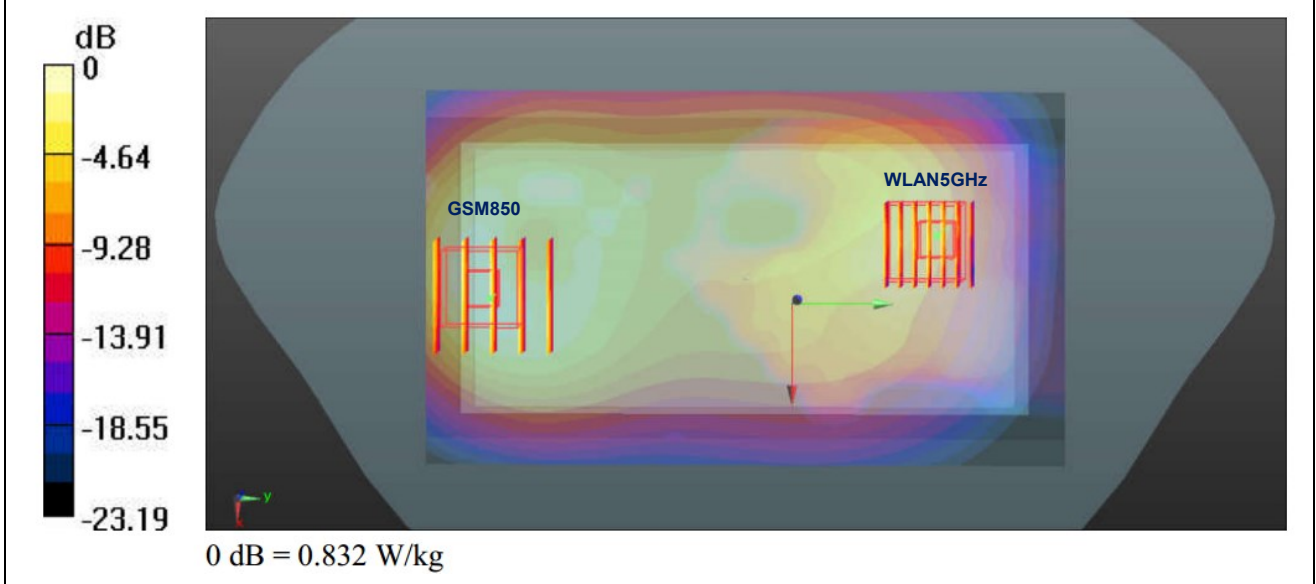

Case #6	Band	Position	1g SAR (W/kg)	Gap (mm)	SAR peak location (m)			3D distance (mm)	Summed 1g SAR (W/kg)	SPLSR Results	Simultaneous SAR
	GSM1900				X	Y	Z				
	WLAN5GHz	Back	0.465	5	-0.0245	-0.0735	-0.205	128.6	1.63	0.02	Not required
	GSM1900		1.168	5	-0.03	0.055	-0.205				

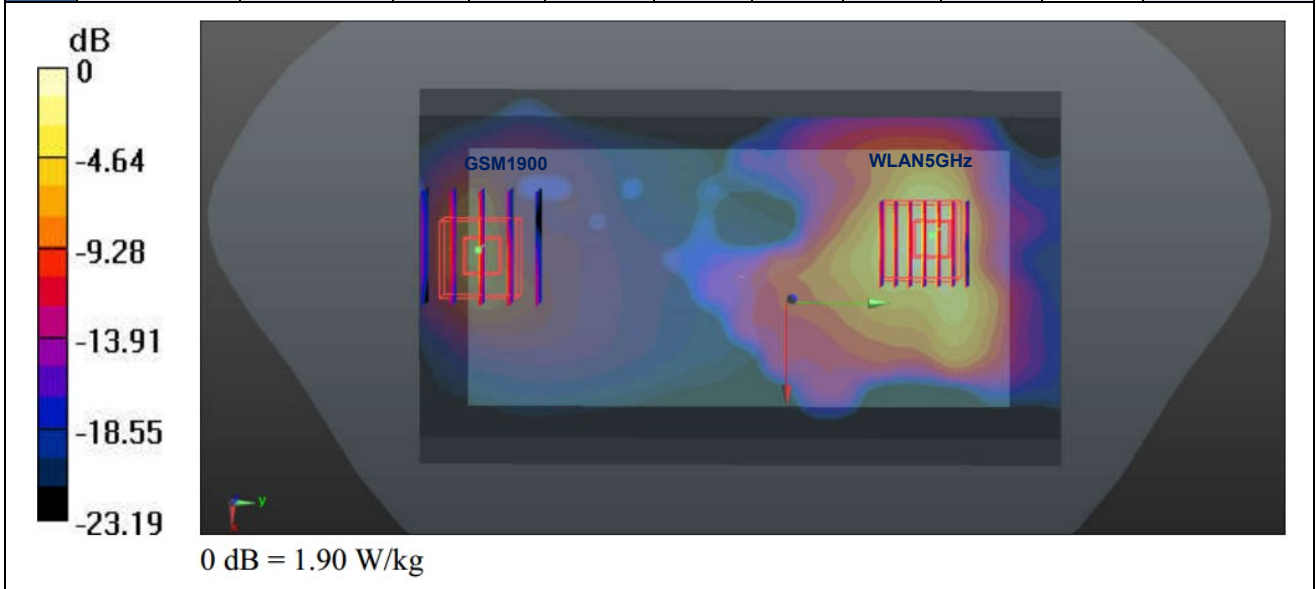

Case #7	Band	Position	1g SAR (W/kg)	Gap (mm)	SAR peak location (m)			3D distance (mm)	Summed 1g SAR (W/kg)	SPLSR Results	Simultaneous SAR
					X	Y	Z				
	WCDMA Band V	Back	0.592	5	-0.003	-0.0735	-0.205	131.3	1.76	0.02	Not required
	WLAN5GHz		1.168	5	-0.03	0.055	-0.205				

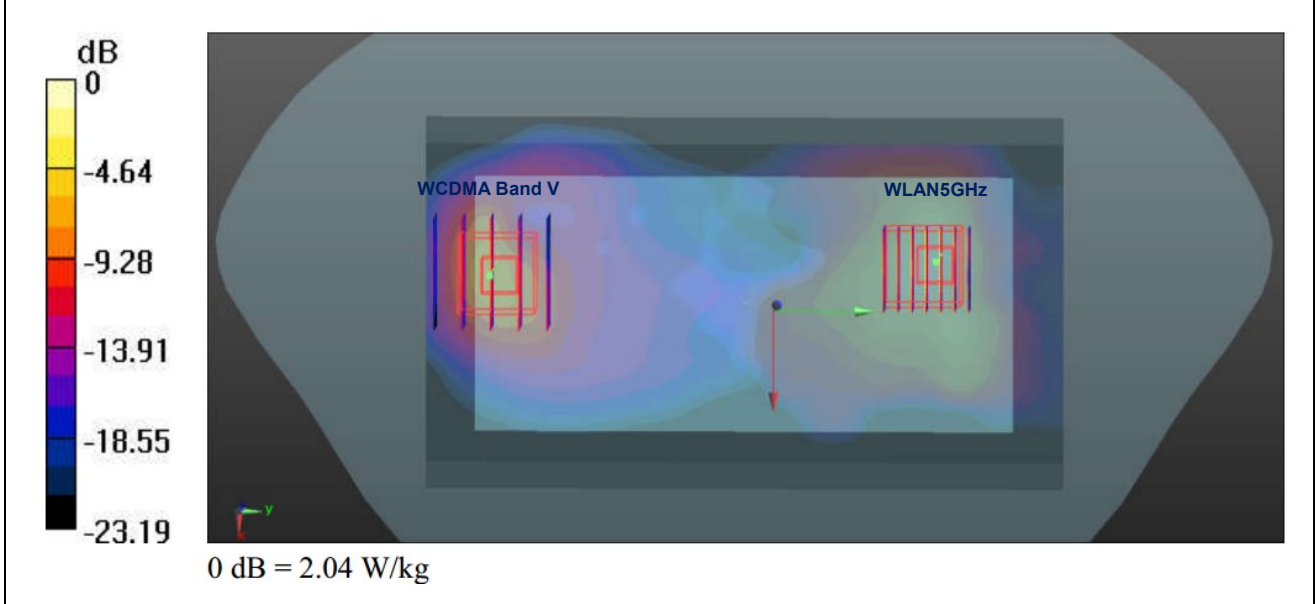

Case #8	Band	Position	1g SAR (W/kg)	Gap (mm)	SAR peak location (m)			3D distance (mm)	Summed 1g SAR (W/kg)	SPLSR Results	Simultaneous SAR
					X	Y	Z				
	WCDMA Band IV	Back	0.487	5	-0.0245	-0.072	-0.205	127.1	1.66	0.02	Not required
	WLAN5GHz		1.168	5	-0.03	0.055	-0.205				

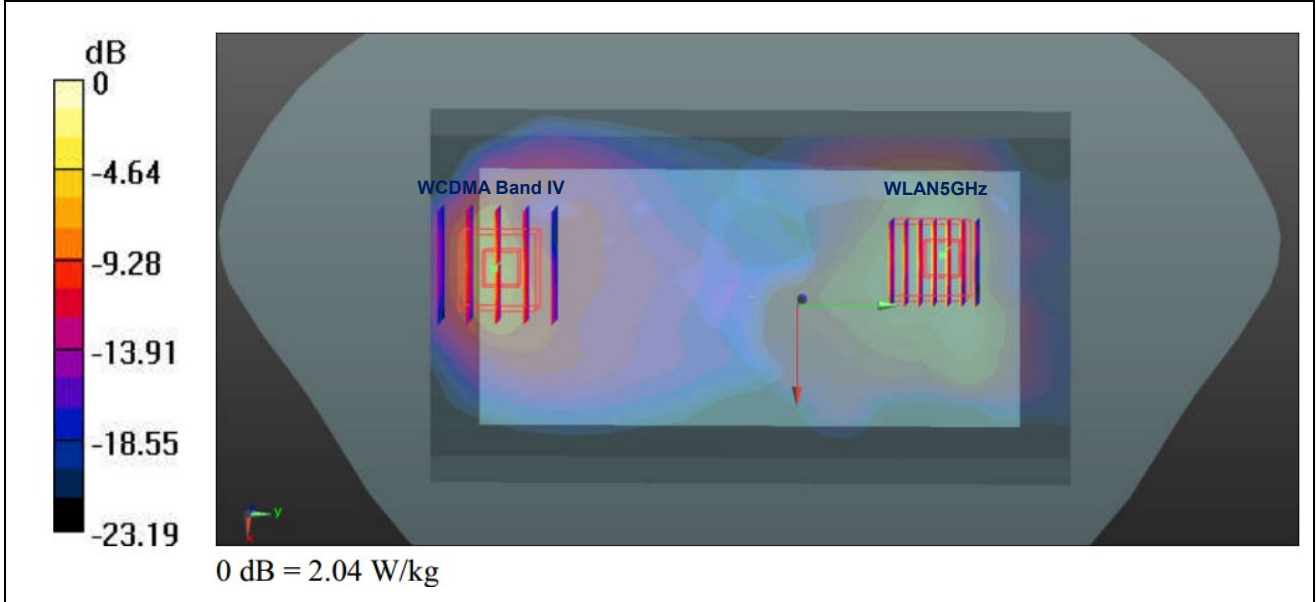

Case #9	Band	Position	1g SAR (W/kg)	Gap (mm)	SAR peak location (m)			3D distance (mm)	Summed 1g SAR (W/kg)	SPLSR Results	Simultaneous SAR
	WCDMA Band II				X	Y	Z				
	WCDMA Band II	Back	0.477	5	-0.0245	-0.072	-0.205	127.1	1.65	0.02	Not required
	WLAN5GHz		1.168	5	-0.03	0.055	-0.205				

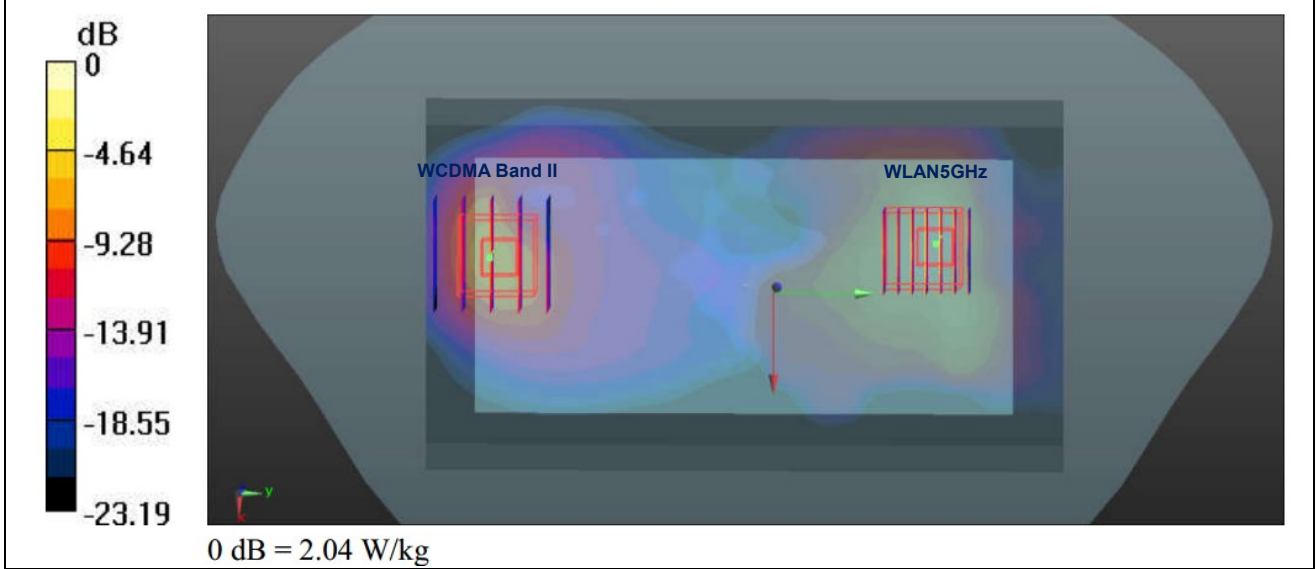

Case #10	Band	Position	1g SAR (W/kg)	Gap (mm)	SAR peak location (m)			3D distance (mm)	Summed 1g SAR (W/kg)	SPLSR Results	Simultaneous SAR
	CDMA2000 BC0				X	Y	Z				
	CDMA2000 BC0	Back	0.482	5	-0.0095	-0.0665	-0.205	123.2	1.65	0.02	Not required
	WLAN5GHz		1.168	5	-0.03	0.055	-0.205				

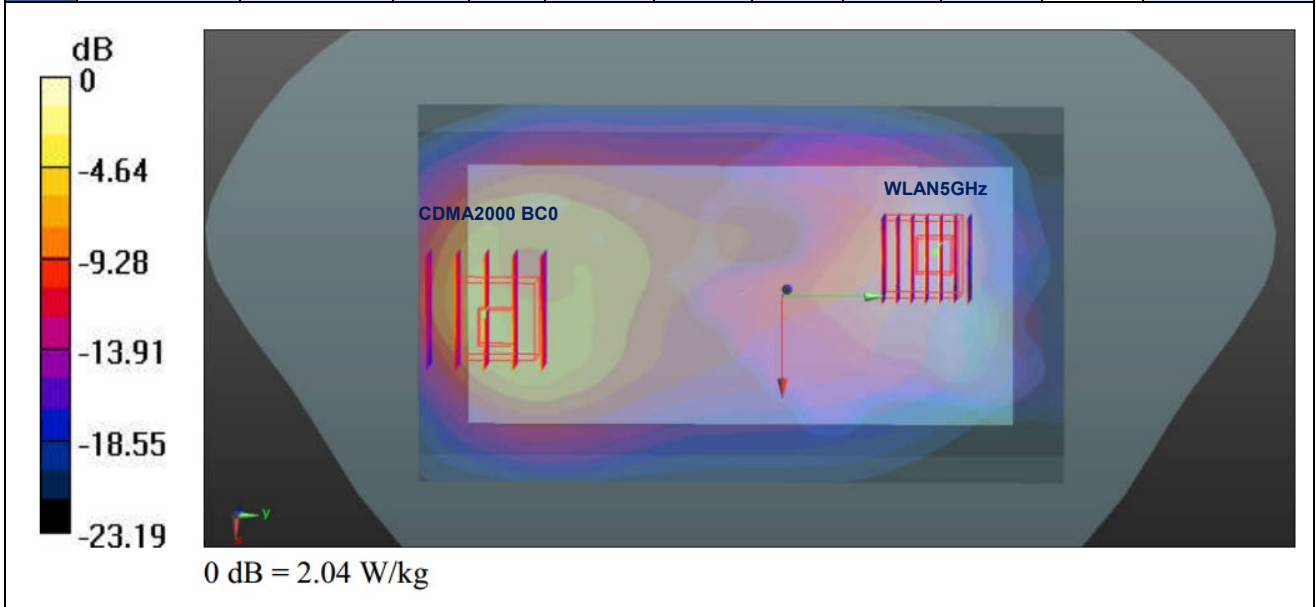

Case #11	Band	Position	1g SAR (W/kg)	Gap (mm)	SAR peak location (m)			3D distance (mm)	Summed 1g SAR (W/kg)	SPLSR Results	Simultaneous SAR
					X	Y	Z				
	CDMA2000 BC1	Back	0.467	5	-0.026	-0.075	-0.205	130.1	1.64	0.02	Not required
	WLAN5GHz		1.168	5	-0.03	0.055	-0.205				

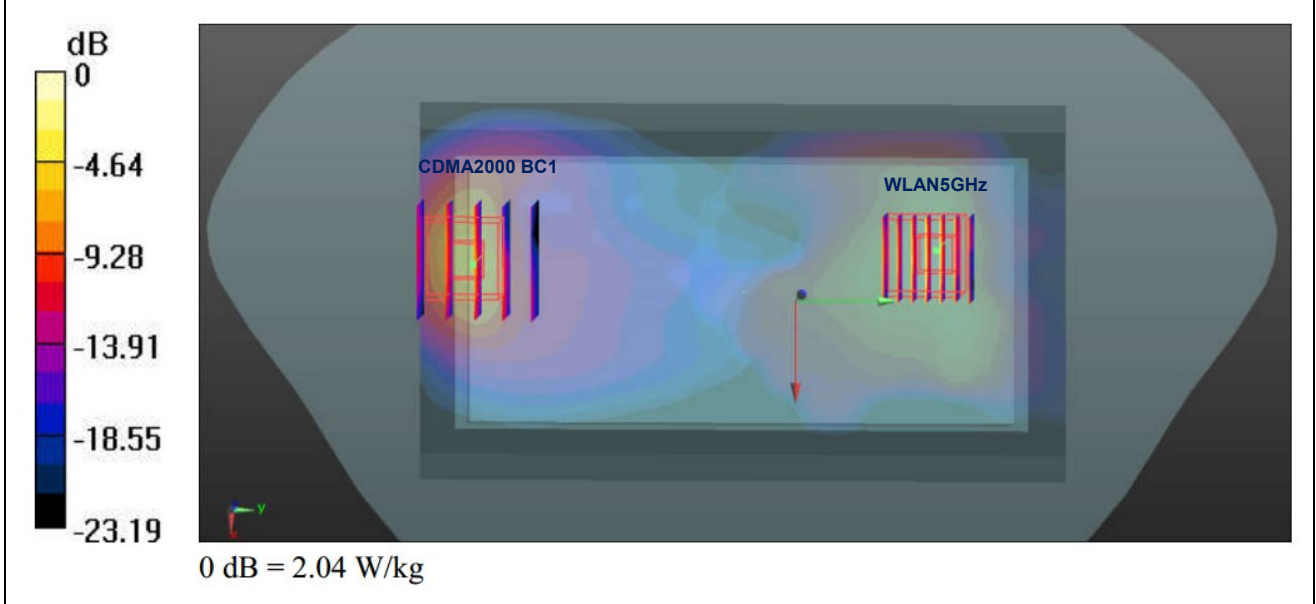

Case #12	Band	Position	1g SAR (W/kg)	Gap (mm)	SAR peak location (m)			3D distance (mm)	Summed 1g SAR (W/kg)	SPLSR Results	Simultaneous SAR
					X	Y	Z				
	LTE Band 5	Back	0.468	5	-0.003	-0.0735	-0.205	131.3	1.64	0.02	Not required
	WLAN5GHz		1.168	5	-0.03	0.055	-0.205				

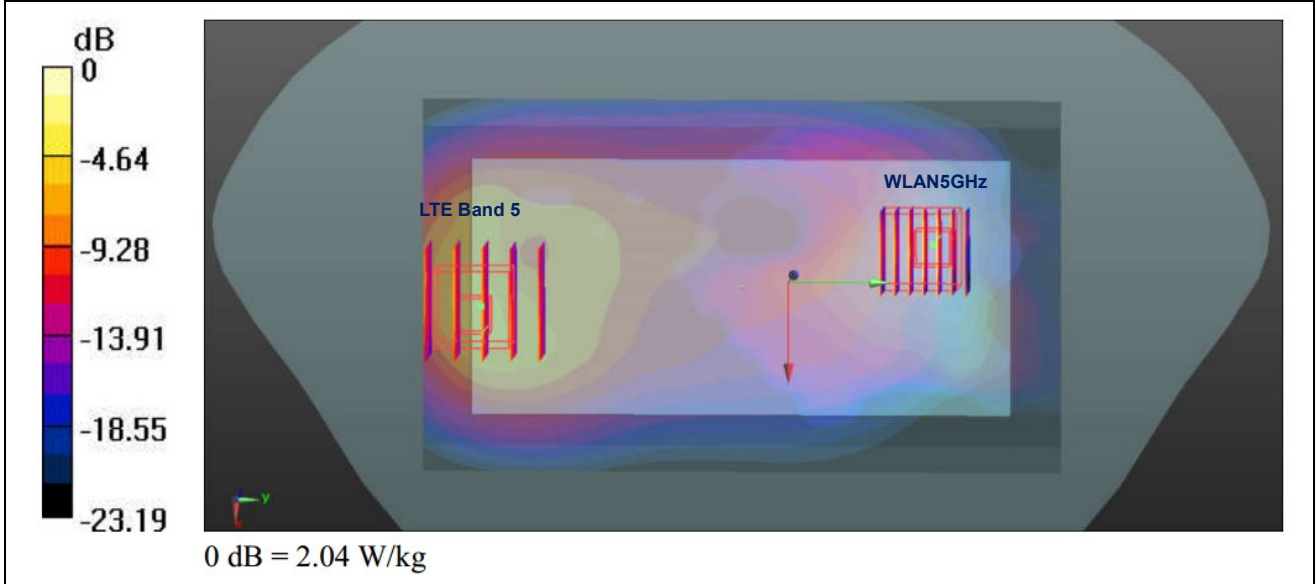

Case #13	Band	Position	1g SAR (W/kg)	Gap (mm)	SAR peak location (m)			3D distance (mm)	Summed 1g SAR (W/kg)	SPLSR Results	Simultaneous SAR
	LTE Band 12				X	Y	Z				
	WLAN5GHz	Back	0.451	5	-0.011	-0.072	-0.205	128.4	1.62	0.02	Not required
	LTE Band 12		1.168	5	-0.03	0.055	-0.205				

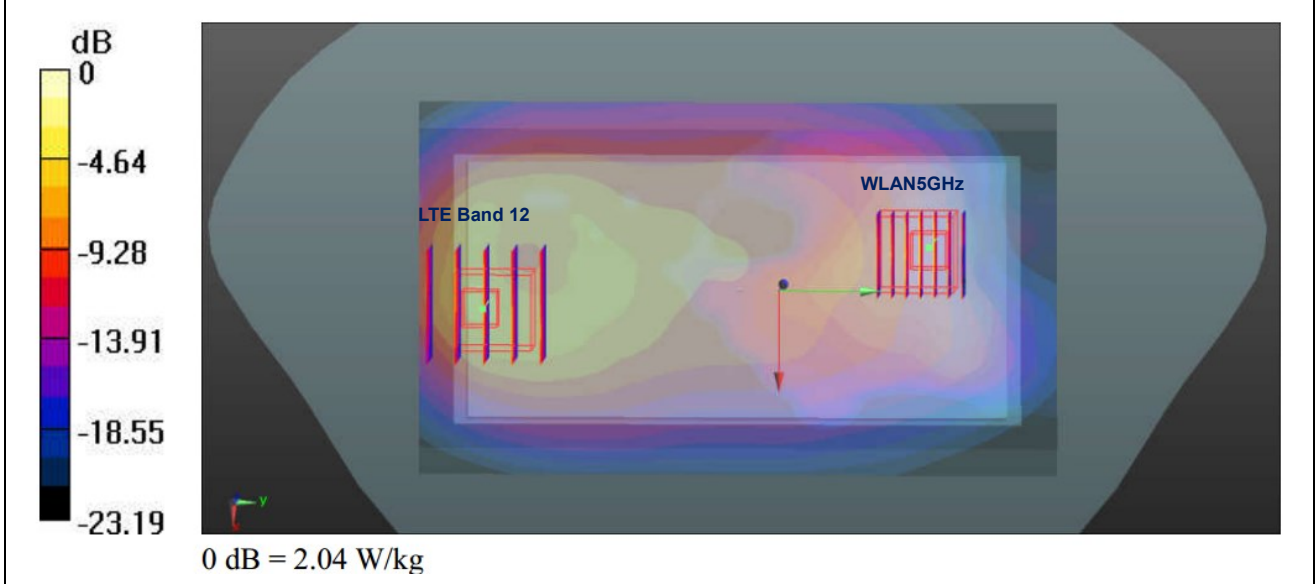

Case #14	Band	Position	1g SAR (W/kg)	Gap (mm)	SAR peak location (m)			3D distance (mm)	Summed 1g SAR (W/kg)	SPLSR Results	Simultaneous SAR
	LTE Band 13				X	Y	Z				
	WLAN5GHz	Back	0.555	5	-0.007	-0.08	-0.205	136.9	1.72	0.02	Not required
	LTE Band 13		1.168	5	-0.03	0.055	-0.205				

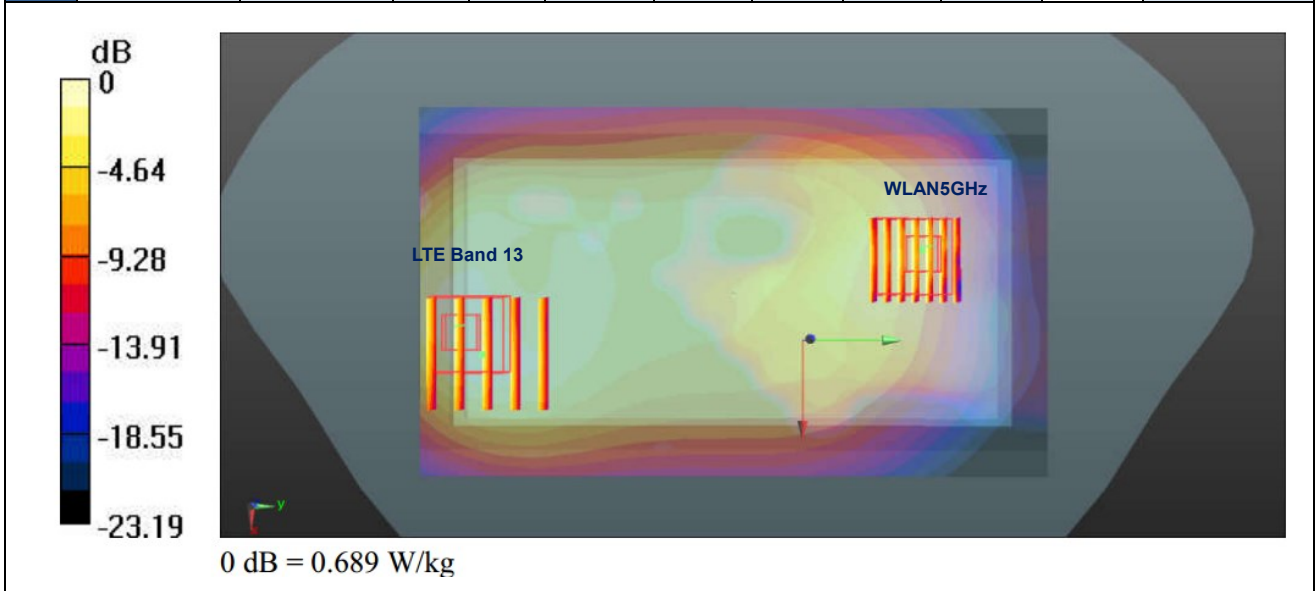

Case #15	Band	Position	1g SAR (W/kg)	Gap (mm)	SAR peak location (m)			3D distance (mm)	Summed 1g SAR (W/kg)	SPLSR Results	Simultaneous SAR
					X	Y	Z				
	LTE Band 66	Back	0.532	5	-0.0095	-0.075	-0.205	131.6	1.70	0.02	Not required
	WLAN5GHz		1.168	5	-0.03	0.055	-0.205				

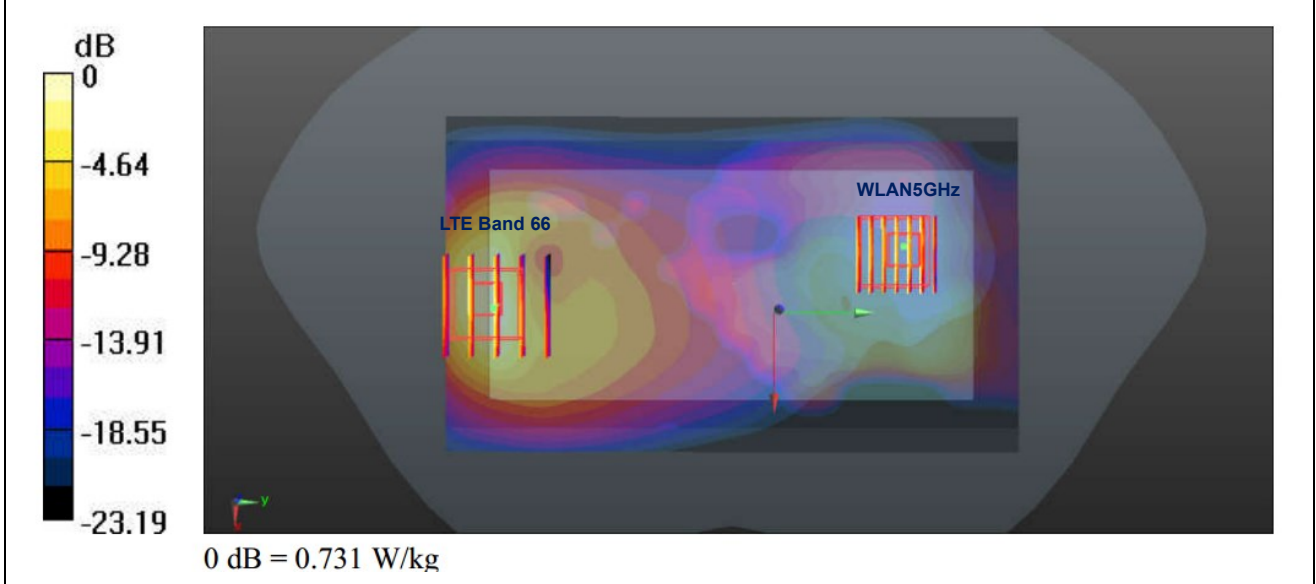

Case #16	Band	Position	1g SAR (W/kg)	Gap (mm)	SAR peak location (m)			3D distance (mm)	Summed 1g SAR (W/kg)	SPLSR Results	Simultaneous SAR
					X	Y	Z				
	LTE Band 2	Back	0.629	5	-0.023	-0.0795	-0.205	134.7	1.80	0.02	Not required
	WLAN5GHz		1.168	5	-0.03	0.055	-0.205				

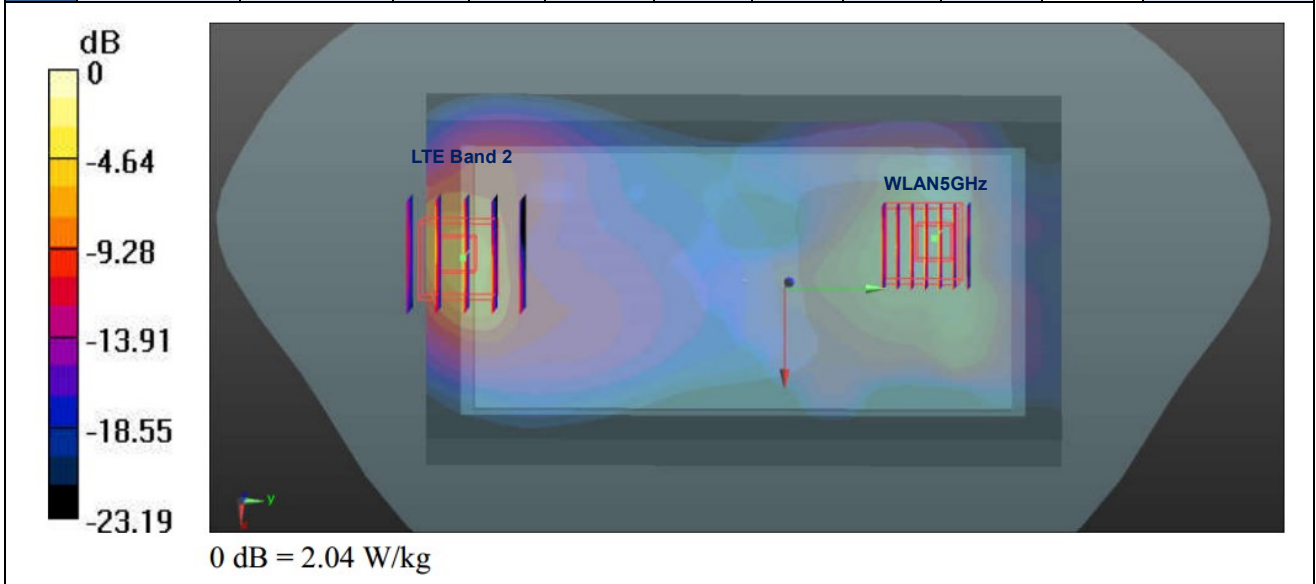

Test Engineer : Johnny Chen



17. Uncertainty Assessment

Per KDB 865664 D01 SAR measurement 100MHz to 6GHz, when the highest measured 1-g SAR within a frequency band is < 1.5 W/kg and the measured 10-g SAR within a frequency band is < 3.75 W/kg. The expanded SAR measurement uncertainty must be $\leq 30\%$, for a confidence interval of $k = 2$. If these conditions are met, extensive SAR measurement uncertainty analysis described in IEEE Std 1528-2013 is not required in SAR reports submitted for equipment approval. For this device, the highest measured 1-g SAR is less 1.5W/kg and highest measured 10-g SAR is less 3.75W/kg. Therefore, the measurement uncertainty table is not required in this report.



18. References

- [1] FCC 47 CFR Part 2 "Frequency Allocations and Radio Treaty Matters; General Rules and Regulations"
- [2] ANSI/IEEE Std. C95.1-1992, "IEEE Standard for Safety Levels with Respect to Human Exposure to Radio Frequency Electromagnetic Fields, 3 kHz to 300 GHz", September 1992
- [3] IEEE Std. 1528-2013, "IEEE Recommended Practice for Determining the Peak Spatial-Average Specific Absorption Rate (SAR) in the Human Head from Wireless Communications Devices: Measurement Techniques", Sep 2013
- [4] SPEAG DASY System Handbook
- [5] FCC KDB 865664 D01 v01r04, "SAR Measurement Requirements for 100 MHz to 6 GHz", Aug 2015.
- [6] FCC KDB 865664 D02 v01r02, "RF Exposure Compliance Reporting and Documentation Considerations" Oct 2015.
- [7] FCC KDB 447498 D01 v06, "Mobile and Portable Device RF Exposure Procedures and Equipment Authorization Policies", Oct 2015
- [8] FCC KDB 648474 D04 v01r03, "SAR Evaluation Considerations for Wireless Handsets", Oct 2015.
- [9] FCC KDB 248227 D01 v02r02, "SAR Guidance for IEEE 802.11 (WiFi) Transmitters", Oct 2015.
- [10] FCC KDB 941225 D01 v03r01, "3G SAR MEAUREMENT PROCEDURES", Oct 2015
- [11] FCC KDB 941225 D05 v02r05, "SAR Evaluation Considerations for LTE Devices", Dec 2015
- [12] FCC KDB 941225 D06 v02r01, "SAR Evaluation Procedures for Portable Devices with Wireless Router Capabilities", Oct 2015.
- [13] FCC KDB 616217 D04 v01r02, "SAR Evaluation Considerations for Laptop, Notebook, Netbook and Tablet Computers", Oct 2015.



Appendix A. Plots of System Performance Check

The plots are shown as follows.

System Check_Head_750MHz_180414

DUT: D750V3-SN:1099

Communication System: UID 0, CW (0); Frequency: 750 MHz; Duty Cycle: 1:1
Medium: HSL_750_180414 Medium parameters used: $f = 750$ MHz; $\sigma = 0.879$ S/m; $\epsilon_r = 40.711$; $\rho = 1000$ kg/m³
Ambient Temperature : 23.5 °C; Liquid Temperature : 22.5 °C

DASY5 Configuration:

- Probe: EX3DV4 - SN3958; ConvF(10.59, 10.59, 10.59); Calibrated: 2018.01.11;
- Sensor-Surface: 2mm (Mechanical Surface Detection)
- Electronics: DAE4 Sn1303; Calibrated: 2017.12.19
- Phantom: SAM (Front) with CRP v5.0; Type: QD000P40CD; Serial: TP:1795
- Measurement SW: DASY52, Version 52.8 (8); SEMCAD X Version 14.6.10 (7331)

Pin=250mW/Area Scan (61x61x1): Interpolated grid: dx=15mm, dy=15mm
Maximum value of SAR (interpolated) = 2.51 W/kg

Pin=250mW/Zoom Scan (5x5x7)/Cube 0: Measurement grid: dx=8mm, dy=8mm, dz=5mm
Reference Value = 53.84 V/m; Power Drift = 0.02 dB
Peak SAR (extrapolated) = 2.89 W/kg
SAR(1 g) = 2 W/kg; SAR(10 g) = 1.36 W/kg
Maximum value of SAR (measured) = 2.49 W/kg

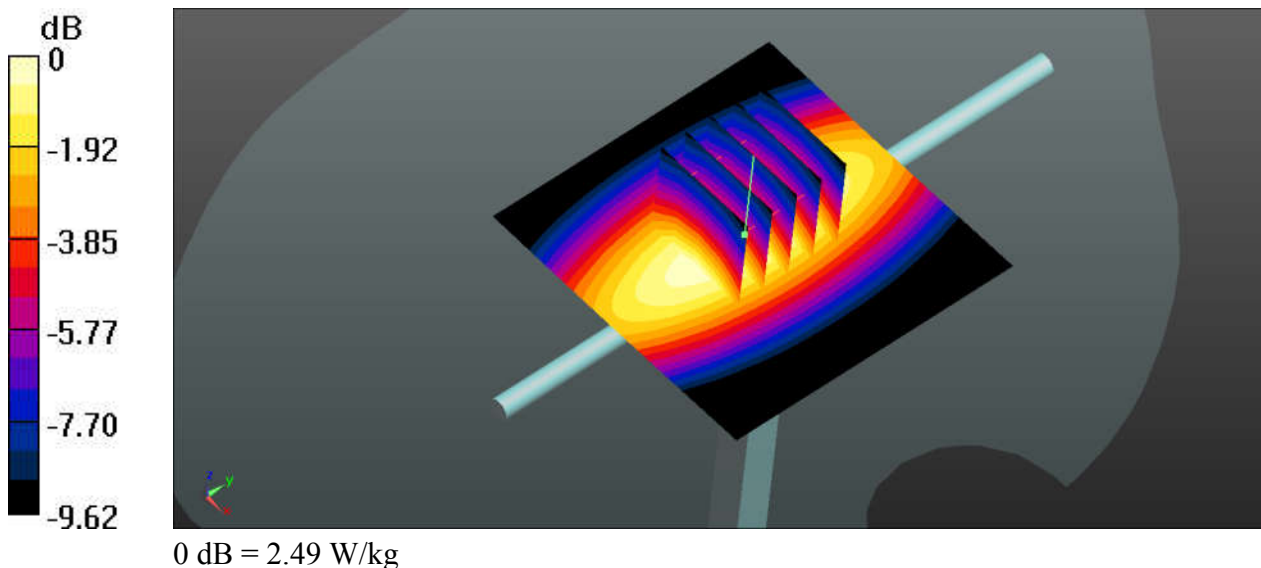

System Check_Head_835MHz_180414

DUT: D835V2-SN:4d162

Communication System: UID 0, CW (0); Frequency: 835 MHz; Duty Cycle: 1:1
Medium: HSL_835_180414 Medium parameters used: $f = 835 \text{ MHz}$; $\sigma = 0.929 \text{ S/m}$; $\epsilon_r = 41.793$; $\rho = 1000 \text{ kg/m}^3$
Ambient Temperature : $23.5 \text{ }^\circ\text{C}$; Liquid Temperature : $22.8 \text{ }^\circ\text{C}$

DASY5 Configuration:

- Probe: EX3DV4 - SN3958; ConvF(10.31, 10.31, 10.31); Calibrated: 2018.01.11;
- Sensor-Surface: 2mm (Mechanical Surface Detection)
- Electronics: DAE4 Sn1303; Calibrated: 2017.12.19
- Phantom: SAM (Front) with CRP v5.0; Type: QD000P40CD; Serial: TP:1795
- Measurement SW: DASY52, Version 52.8 (8); SEMCAD X Version 14.6.10 (7331)

Pin=250mW/Area Scan (61x61x1): Interpolated grid: $dx=15\text{mm}$, $dy=15\text{mm}$
Maximum value of SAR (interpolated) = 3.10 W/kg

Pin=250mW/Zoom Scan (5x5x7)/Cube 0: Measurement grid: $dx=8\text{mm}$, $dy=8\text{mm}$, $dz=5\text{mm}$
Reference Value = 58.60 V/m ; Power Drift = 0.00 dB
Peak SAR (extrapolated) = 3.67 W/kg
SAR(1 g) = 2.44 W/kg ; SAR(10 g) = 1.6 W/kg
Maximum value of SAR (measured) = 3.09 W/kg

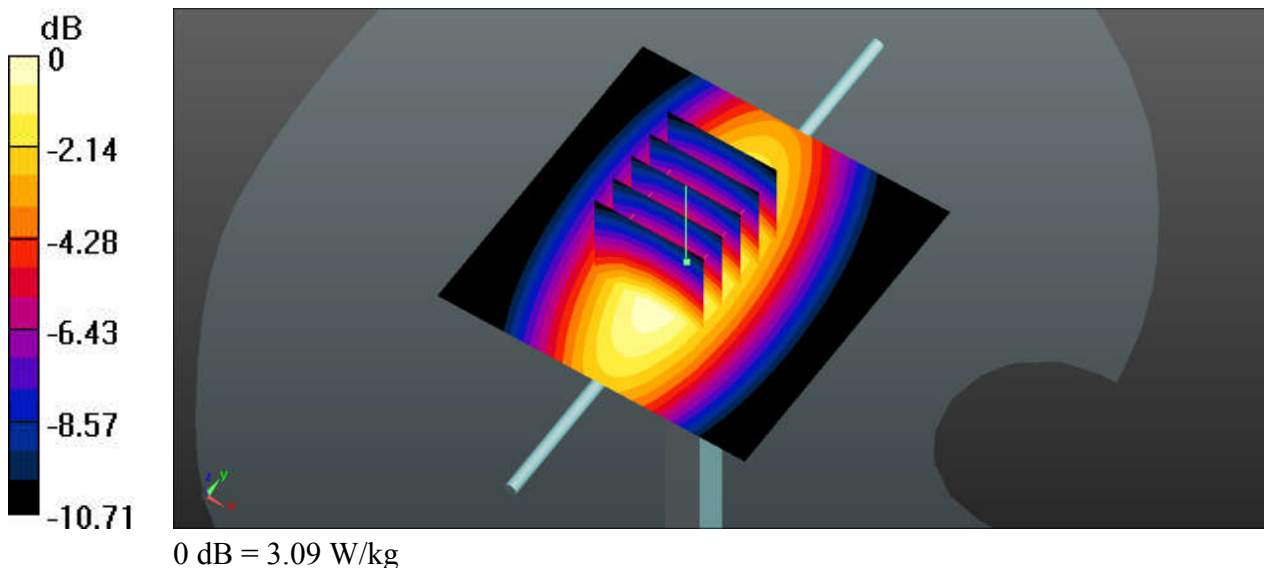

System Check_Head_1750MHz_180416

DUT: D1750V2-SN:1137

Communication System: UID 0, CW; Frequency: 1750 MHz; Duty Cycle: 1:1
Medium: HSL_1750_180416 Medium parameters used: $f = 1750$ MHz; $\sigma = 1.382$ S/m; $\epsilon_r = 41.56$; $\rho = 1000$ kg/m³
Ambient Temperature : 23.5 °C; Liquid Temperature : 22.4 °C

DASY5 Configuration:

- Probe: EX3DV4 - SN3958; ConvF(8.79, 8.79, 8.79); Calibrated: 2018.01.11;
- Sensor-Surface: 2mm (Mechanical Surface Detection)
- Electronics: DAE4 Sn1303; Calibrated: 2017.12.19
- Phantom: SAM (Front) with CRP v5.0; Type: QD000P40CD; Serial: TP:1795
- Measurement SW: DASY52, Version 52.8 (8); SEMCAD X Version 14.6.10 (7331)

Pin=250mW/Area Scan (61x61x1): Interpolated grid: dx=15mm, dy=15mm
Maximum value of SAR (interpolated) = 12.5 W/kg

Pin=250mW/Zoom Scan (5x5x7)/Cube 0: Measurement grid: dx=8mm, dy=8mm, dz=5mm
Reference Value = 92.34 V/m; Power Drift = 0.09 dB
Peak SAR (extrapolated) = 15.2 W/kg
SAR(1 g) = 8.71 W/kg; SAR(10 g) = 4.72 W/kg
Maximum value of SAR (measured) = 12.3 W/kg

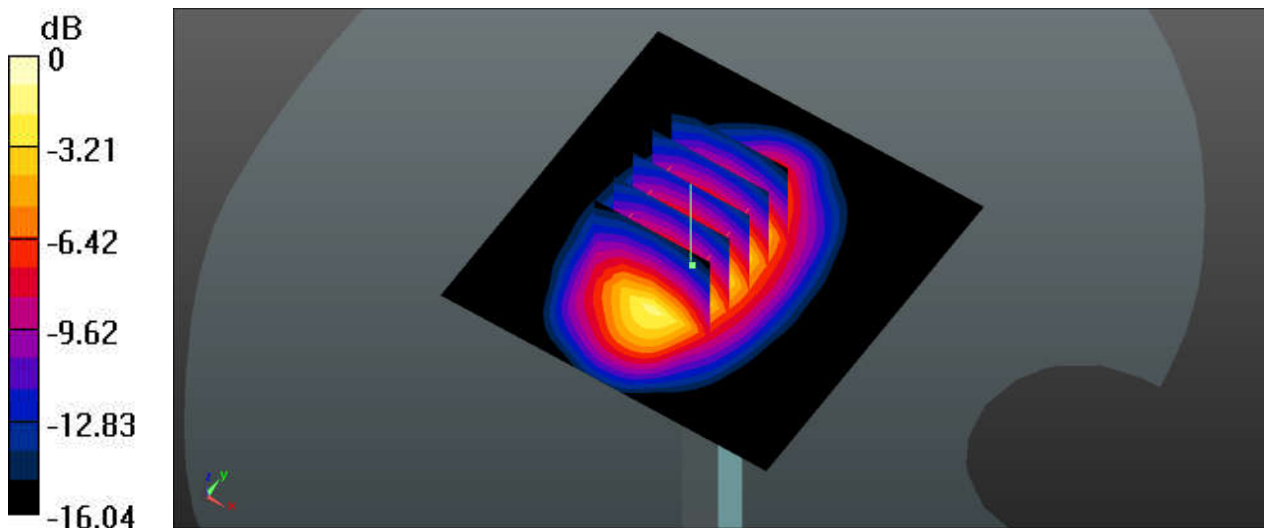

0 dB = 12.3 W/kg

System Check_Head_1900MHz_180416

DUT: D1900V2-SN:5d182

Communication System: UID 0, CW; Frequency: 1900 MHz; Duty Cycle: 1:1
Medium: HSL_1900_180416 Medium parameters used: $f = 1900$ MHz; $\sigma = 1.455$ S/m; $\epsilon_r = 40.068$;
 $\rho = 1000$ kg/m³
Ambient Temperature : 23.5 °C; Liquid Temperature : 22.6 °C

DASY5 Configuration:

- Probe: EX3DV4 - SN3958; ConvF(8.43, 8.43, 8.43); Calibrated: 2018.01.11;
- Sensor-Surface: 2mm (Mechanical Surface Detection)
- Electronics: DAE4 Sn1303; Calibrated: 2017.12.19
- Phantom: SAM (Front) with CRP v5.0; Type: QD000P40CD; Serial: TP:1795
- Measurement SW: DASY52, Version 52.8 (8); SEMCAD X Version 14.6.10 (7331)

Pin=250mW/Area Scan (61x61x1): Interpolated grid: dx=15mm, dy=15mm
Maximum value of SAR (interpolated) = 14.4 W/kg

Pin=250mW/Zoom Scan (5x5x7)/Cube 0: Measurement grid: dx=8mm, dy=8mm, dz=5mm
Reference Value = 96.03 V/m; Power Drift = 0.09 dB
Peak SAR (extrapolated) = 17.8 W/kg
SAR(1 g) = 9.86 W/kg; SAR(10 g) = 5.15 W/kg
Maximum value of SAR (measured) = 14.0 W/kg

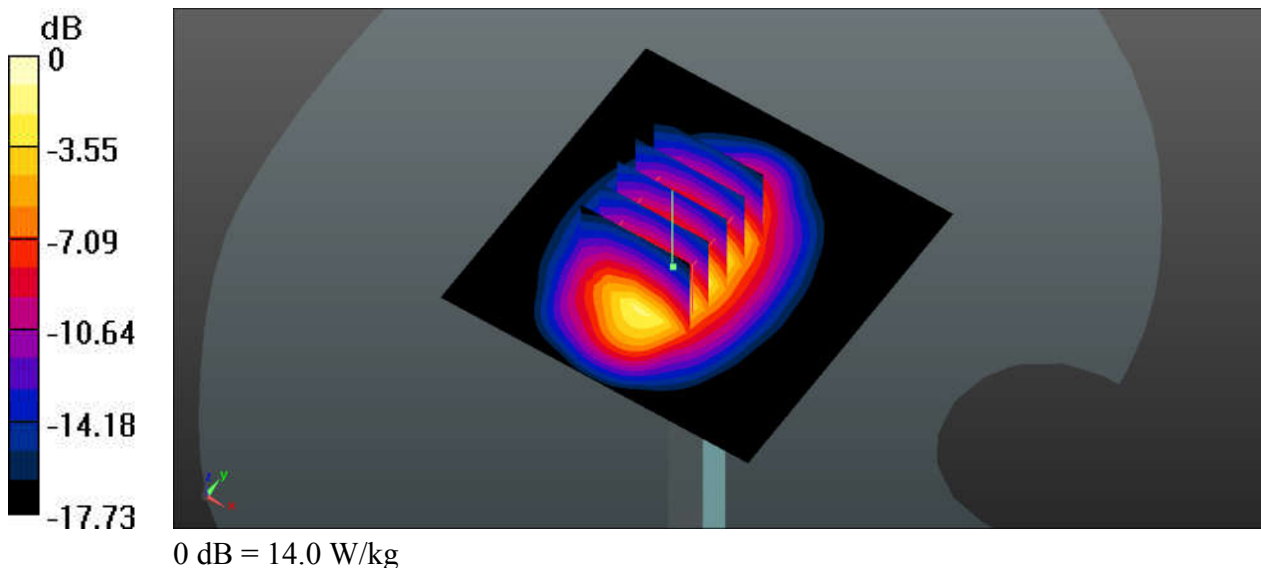

System Check_Head_2450MHz_180425

DUT: D2450V2-SN:924

Communication System: UID 0, CW; Frequency: 2450 MHz; Duty Cycle: 1:1

Medium: HSL_2450_180425 Medium parameters used: $f = 2450$ MHz; $\sigma = 1.834$ S/m; $\epsilon_r = 39.654$; $\rho = 1000$ kg/m³

Ambient Temperature : 23.3 °C; Liquid Temperature : 22.5 °C

DASY5 Configuration:

- Probe: EX3DV4 - SN3911; ConvF(7.53, 7.53, 7.53); Calibrated: 2017.11.28;
- Sensor-Surface: 2mm (Mechanical Surface Detection)
- Electronics: DAE4 Sn1386; Calibrated: 2017.07.20
- Phantom: SAM2; Type: QD000P40CD; Serial: TP:1671
- Measurement SW: DASY52, Version 52.8 (8); SEMCAD X Version 14.6.10 (7331)

Pin=250mW/Area Scan (81x81x1): Interpolated grid: dx=12mm, dy=12mm

Maximum value of SAR (interpolated) = 19.9 W/kg

Pin=250mW/Zoom Scan (7x7x7)/Cube 0: Measurement grid: dx=5mm, dy=5mm, dz=5mm

Reference Value = 89.27 V/m; Power Drift = -0.12 dB

Peak SAR (extrapolated) = 25.7 W/kg

SAR(1 g) = 12.8 W/kg; SAR(10 g) = 6 W/kg

Maximum value of SAR (measured) = 19.4 W/kg

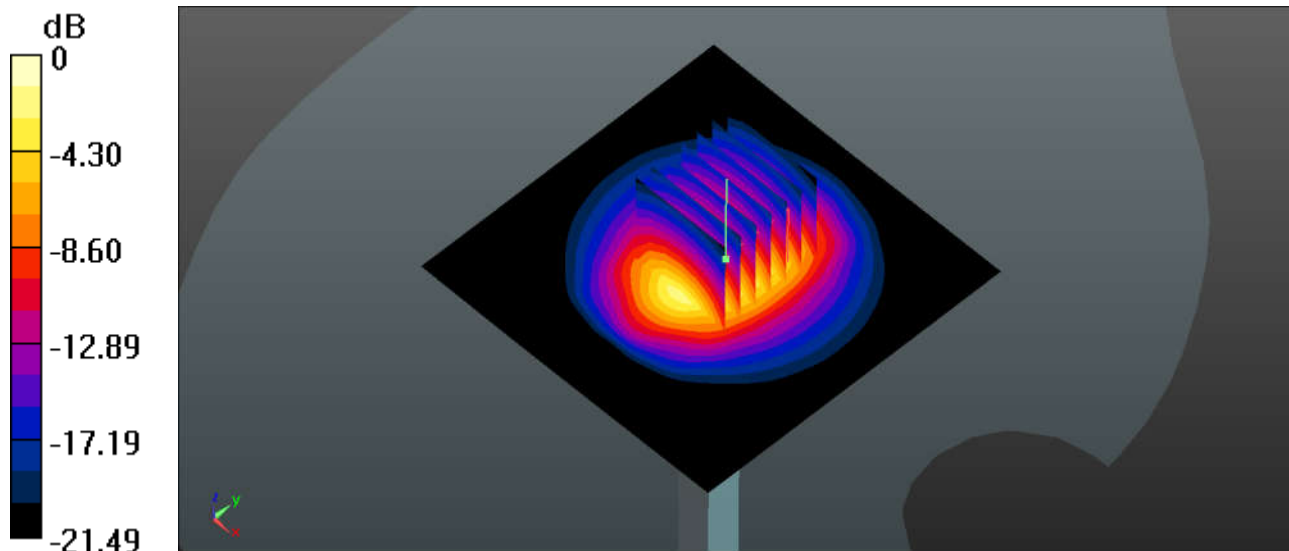

0 dB = 19.4 W/kg

System Check_Head_5250MHz_180425

DUT: D5GHzV2-SN:1167

Communication System: UID 0, CW (0); Frequency: 5250 MHz; Duty Cycle: 1:1

Medium: HSL_5250_180425 Medium parameters used: $f = 5250$ MHz; $\sigma = 4.713$ S/m; $\epsilon_r = 36.255$; $\rho = 1000$ kg/m³

Ambient Temperature : 23.3 °C; Liquid Temperature : 22.6 °C

DASY5 Configuration:

- Probe: EX3DV4 - SN3911; ConvF(5.25, 5.25, 5.25); Calibrated: 2017.11.28;
- Sensor-Surface: 1.4mm (Mechanical Surface Detection)
- Electronics: DAE4 Sn1386; Calibrated: 2017.07.20
- Phantom: SAM2; Type: QD000P40CD; Serial: TP:1671
- Measurement SW: DASY52, Version 52.8 (8); SEMCAD X Version 14.6.10 (7331)

Pin=100mW/Area Scan (71x71x1): Interpolated grid: dx=10mm, dy=10mm

Maximum value of SAR (interpolated) = 15.5 W/kg

Pin=100mW/Zoom Scan (7x7x7)/Cube 0: Measurement grid: dx=4mm, dy=4mm, dz=1.4mm

Reference Value = 24.86 V/m; Power Drift = -0.02 dB

Peak SAR (extrapolated) = 30.5 W/kg

SAR(1 g) = 7.57 W/kg; SAR(10 g) = 2.1 W/kg

Maximum value of SAR (measured) = 15.3 W/kg

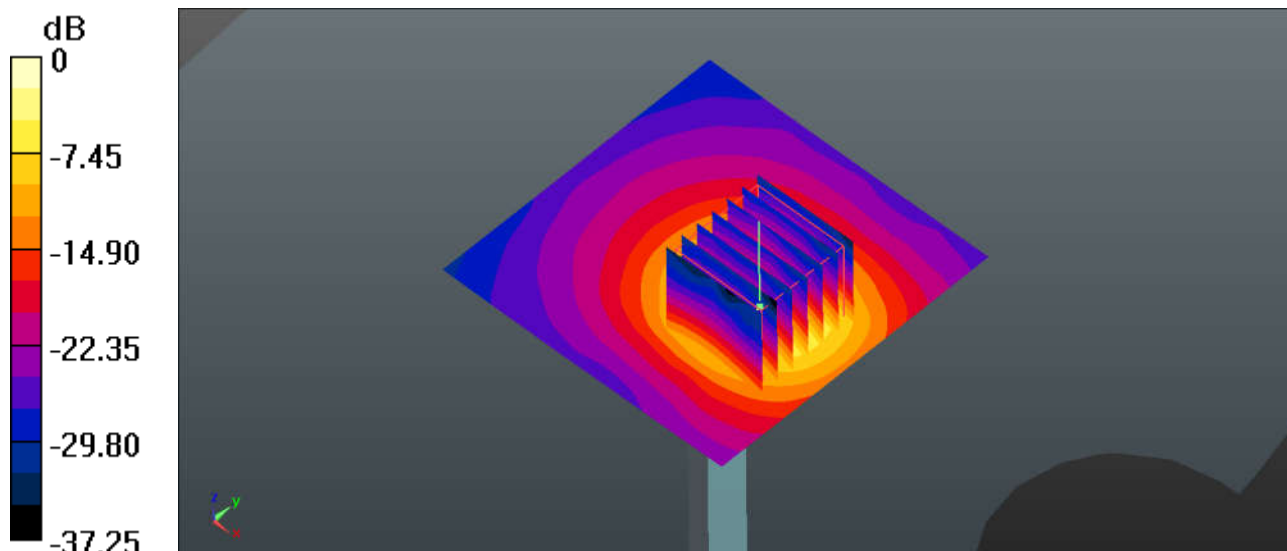

0 dB = 15.3 W/kg

System Check_Head_5600MHz_180425

DUT: D5GHzV2-SN:1167

Communication System: UID 0, CW; Frequency: 5600 MHz; Duty Cycle: 1:1

Medium: HSL_5600_180425 Medium parameters used: $f = 5600$ MHz; $\sigma = 5.139$ S/m; $\epsilon_r = 35.632$; $\rho = 1000$ kg/m³

Ambient Temperature : 23.3 °C; Liquid Temperature : 22.7 °C

DASY5 Configuration:

- Probe: EX3DV4 - SN3911; ConvF(4.6, 4.6, 4.6); Calibrated: 2017.11.28;
- Sensor-Surface: 1.4mm (Mechanical Surface Detection)
- Electronics: DAE4 Sn1386; Calibrated: 2017.07.20
- Phantom: SAM2; Type: QD000P40CD; Serial: TP:1671
- Measurement SW: DASY52, Version 52.8 (8); SEMCAD X Version 14.6.10 (7331)

Pin=100mW/Area Scan (71x71x1): Interpolated grid: dx=10mm, dy=10mm

Maximum value of SAR (interpolated) = 20.5 W/kg

Pin=100mW/Zoom Scan (7x7x7)/Cube 0: Measurement grid: dx=4mm, dy=4mm, dz=1.4mm

Reference Value = 69.35 V/m; Power Drift = -0.09 dB

Peak SAR (extrapolated) = 34.6 W/kg

SAR(1 g) = 8.68 W/kg; SAR(10 g) = 2.38 W/kg

Maximum value of SAR (measured) = 21.7 W/kg

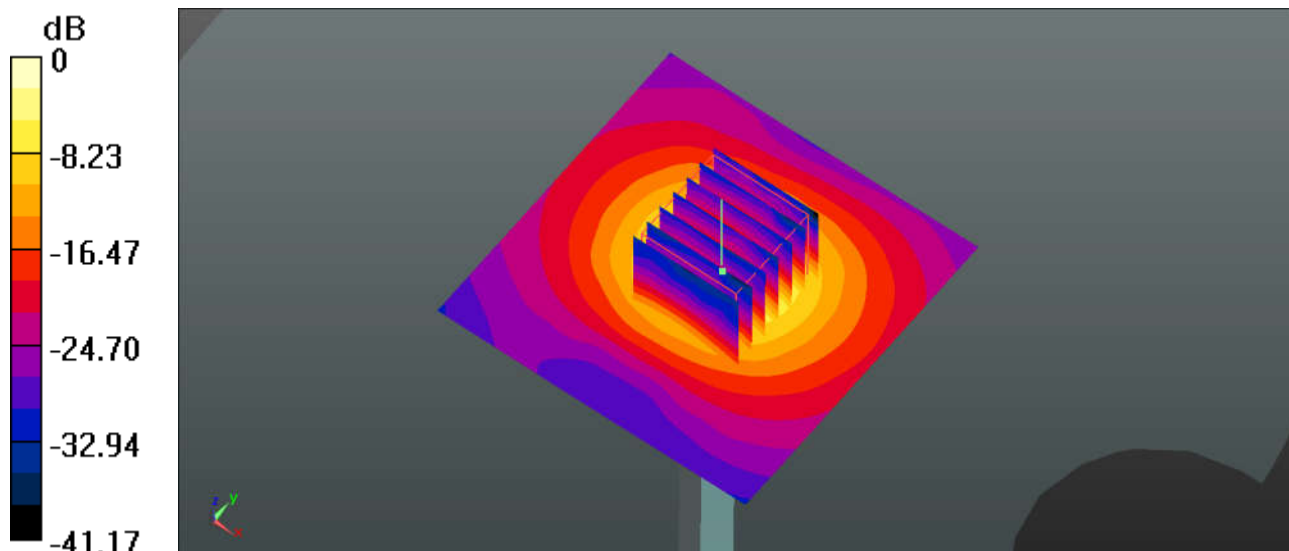

System Check_Head_5750MHz_180425

DUT: D5GHzV2-SN:1167

Communication System: UID 0, CW (0); Frequency: 5750 MHz; Duty Cycle: 1:1
Medium: HSL_5750_180425 Medium parameters used: $f = 5750$ MHz; $\sigma = 5.313$ S/m; $\epsilon_r = 35.352$; $\rho = 1000$ kg/m³
Ambient Temperature : 23.3 °C; Liquid Temperature : 22.8 °C

DASY5 Configuration:

- Probe: EX3DV4 - SN3911; ConvF(4.93, 4.93, 4.93); Calibrated: 2017.11.28;
- Sensor-Surface: 1.4mm (Mechanical Surface Detection)
- Electronics: DAE4 Sn1386; Calibrated: 2017.07.20
- Phantom: SAM2; Type: QD000P40CD; Serial: TP:1671
- Measurement SW: DASY52, Version 52.8 (8); SEMCAD X Version 14.6.10 (7331)

Pin=100mW/Area Scan (71x71x1): Interpolated grid: dx=10mm, dy=10mm
Maximum value of SAR (interpolated) = 16.5 W/kg

Pin=100mW/Zoom Scan (7x7x7)/Cube 0: Measurement grid: dx=4mm, dy=4mm, dz=1.4mm
Reference Value = 52.41 V/m; Power Drift = -0.01 dB
Peak SAR (extrapolated) = 33.7 W/kg
SAR(1 g) = 8.11 W/kg; SAR(10 g) = 2.21 W/kg
Maximum value of SAR (measured) = 17.1 W/kg

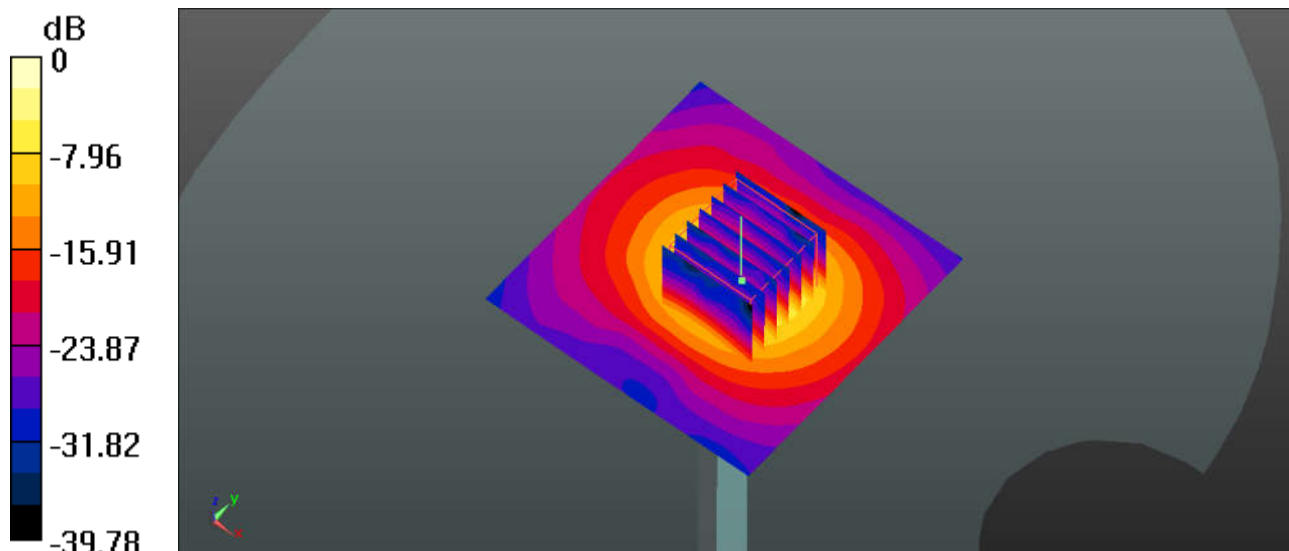

0 dB = 17.1 W/kg

System Check_Body_750MHz_180418

DUT: D750V3-SN:1099

Communication System: UID 0, CW (0); Frequency: 750 MHz; Duty Cycle: 1:1
Medium: MSL_750_180418 Medium parameters used: $f = 750$ MHz; $\sigma = 0.97$ S/m; $\epsilon_r = 54.642$; $\rho = 1000$ kg/m³
Ambient Temperature : 23.6 °C; Liquid Temperature : 22.8 °C

DASY5 Configuration:

- Probe: EX3DV4 - SN3958; ConvF(10.52, 10.52, 10.52); Calibrated: 2018.01.11;
- Sensor-Surface: 2mm (Mechanical Surface Detection)
- Electronics: DAE4 Sn1303; Calibrated: 2017.12.19
- Phantom: SAM (Front) with CRP v5.0; Type: QD000P40CD; Serial: TP:1795
- Measurement SW: DASY52, Version 52.8 (8); SEMCAD X Version 14.6.10 (7331)

Pin=250mW/Area Scan (61x61x1): Interpolated grid: dx=15mm, dy=15mm
Maximum value of SAR (interpolated) = 2.60 W/kg

Pin=250mW/Zoom Scan (5x5x7)/Cube 0: Measurement grid: dx=8mm, dy=8mm, dz=5mm
Reference Value = 50.59 V/m; Power Drift = 0.17 dB
Peak SAR (extrapolated) = 3.07 W/kg
SAR(1 g) = 2.1 W/kg; SAR(10 g) = 1.41 W/kg
Maximum value of SAR (measured) = 2.64 W/kg

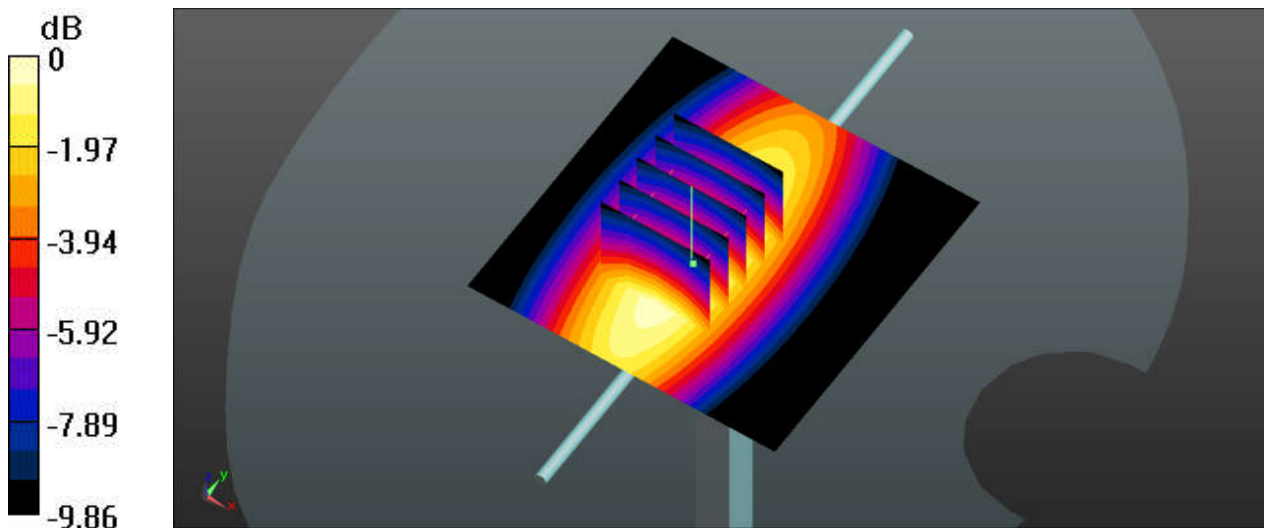

0 dB = 2.64 W/kg